

\*

UMASS/AMHERST

\*



312066 0333 3307 2

LIBRARY

OF THE



MASSACHUSETTS  
AGRICULTURAL  
COLLEGE

SOURC

PER  
SF  
521  
B7

----







THE  
**British Bee Journal,**  
AND BEE=KEEPERS' ADVISER.

EDITED BY

THOS. WM. COWAN, F.G.S., F.L.S., F.R.M.S., &c.  
Assisted by  
W. HERROD F.E.S.

---

**VOLUME XXXIX.**

JANUARY-DECEMBER, 1911.

---

PUBLISHED BY

SIMPKIN, MARSHALL, HAMILTON, KENT, & CO., LIMITED,

-32, PATERNOSTER ROW, E.C.

LIBRARY  

---

UNIVERSITY OF  
MASSACHUSETTS  

---

AMHERST, MASS.

PRINTED BY L. UPCOTT GILL, AT THE LONDON AND COUNTY  
PRINTING WORKS, BAZAAR BUILDINGS, W.C.

# INDEX.

## EDITORIAL, NOTICES, &c. :—

Annual Meeting of the B.B.K.A., 111  
 Bee Diseases Legislation, 351, 441  
 Bees in Parliament, 231  
 Beginning Bee-Keeping, 31  
 British Bee-Keepers' Association, 91; Annual Meeting, 112; *Conversazione*, 121, 131, 141, 411, 421, 431; Library, 30, 33, 45; Monthly Council Meetings, 31, 71, 161, 202, 241, 291, 381, 401, 461, 511; Prize Cards, 221.  
 British B.K. Guide Book (New Edition), 241  
 Coming Honey Shows, 351  
 Christmas, 501  
 Early Pollen Gathering, 43  
 General Sir Stanley Edwardes's Golden Wedding, 441  
 How Foul Brood has been Exterminated in Belgium, 3  
 "Isle of Wight" Disease, 131, 141, 171, 201, 351  
 Malignant Dysentery, 201, 311  
 Mr. and Mrs. Abbott's Silver Wedding, 262  
*Nosema* Disease and Dysentery, 371  
 Royal Show at Norwich, 192  
 Survival and Reproduction 61  
 The "Dzierzon" Centenary, 21  
 Therapeutic Value of Honey, 451  
 Volume Thirty-Nine, 1

## REVIEWS (Editorial):—

Australian Bee Manual, 111  
 Bee-keeper's Companion, The, 301  
 Bees and Honey, by Prof. Newman, 491  
*Chrysanthemums*, 157  
*Der Bau der Biene*, 171  
*Die Biologie der Biene*, 211  
*Echter Bienenhonig Ein wichtiges Nahrungs-u.*, 71.  
 Fertilisation of Fruit Blossoms by Bees, 211  
 Guide to Bee-Keeping in British Columbia, 144  
*La Loque des Abeilles*, 171  
 Lore of the Honey Bee, The, 202  
 Neighbourhood, 471  
 One and All Gardening, 71  
 Profitable Bee-Keeping for Smallholders, 101  
 Propolis, 151  
*Selborne Magazine*, The, 71  
 Shady Gardens, 112  
*South African Bee-Keepers' Journal*, 471  
*Studien über die Honigbiene*, 11  
 Swiss F.B. Insurance Scheme, 171  
 Vergleichende Untersuchungen über das Gehirn der Honigbiene, 42  
 Verwertung des Honigs im Haushalt, 101  
 Warum Stehen auf den Dörfern so Viele Bienenhütten Leer? 301

## PROMINENT BEE-KEEPERS :—

Mr. F. W. L. Sladen, F.E.S., 41  
 Monsieur A. Wathelet, 191

## AMONG THE BEES. By D. M. Macdonald, Banff :—

Advertising Honey, 25  
 An Abnormal Winter, 102  
 An Overplus of Pollen, 281  
 Auction Sales, 231  
 Bee-Keeping in Ancient Times, 152, 301  
 Bee-Keeping in New Zealand, 135  
 Bee-Teaching, 231  
 Best Food for Wintering, 63  
 Carbolic Acid as a Subjugator, 102  
 "Catch My Pal," 2  
 Cheap Home-Made Hive, A, 44  
 Cleanliness in the Hive, 322  
 Colour and Bees' Temper, 81  
 Cone Bee-Escapes, 103  
 Contraction, 343  
 Criticisms, 213

Decorating Prize Wax, 502  
 Defective Sections, 501  
 Depositing Fertile Workers, 24  
 Division Boards, 103  
 Drone Breeder, A, 282  
 Early Life of the Bee, The, 432  
 Education of the Bee, The, 321  
 Electric Embedding, 24, 64  
 Experiments with "Isle of Wight" Disease, 454  
 Features of the Season, 362  
 Finding the Queen, 173  
 Flow of Nectar, A, 262  
 For Legislation, 231  
 Frame Hive, A, 502  
 Fumigation, 62  
 Good Honey, 192  
 Grocer's Show, The, 414  
 "Hood" Device, The, 64  
 Hiving a Swarm, 453  
 Honey Selling, 25  
 Honey-Maker, The, 362  
 How are Stores? 361  
 Languishing Industry, A, 135  
 Moving Hives, 152  
 Olive Branch, The, 415  
 Our Humble-Bees, 483  
 Painting Hives, 103  
 Parcelling Sections, 281  
 Passing of the Skep, The, 43  
 Prescience of the Bee, The, 192  
 Queen Introduction, 151  
 Queen Mating Stations, 501  
 Records, 415  
 Removing Propolis, 193  
 Rising Industry, A, 135  
 System, 391  
 The "Guide Book," 361  
 Three Honey Recipes, 151  
 United Action, 193  
 Urbanity, 64  
 Very Old Bee, A, 151  
 Waspish Bees, 453  
 Winter Protection for Bees, 232

## HELPFUL HINTS FOR NOVICES. By W. Herrod :—

Driven Bees, 333  
 Driving Bees, 353  
 First Examinations, 162  
 Fitting-Up Frames, 241  
 Foundation, 253  
 Hiving Swarms into Frame Hives, 253  
 Making Syrup, 403  
 Manipulating, 222  
 Preparing for Winter, 373, 402, 424  
 Preventing Casts, 292  
 Procuring Surplus, 442, 462, 494  
 Saving and Extracting Wax, 313  
 Solar Wax Extractor, 314  
 Spring-Cleaning Hives, 162  
 Stimulative Feeding, 204  
 Super, The, 443  
 Treatment of Swarms, 271  
 Use of the Dummy Board, 203  
 Water and Pollen, 162

## REVIEWS OF FOREIGN BEE-JOURNALS. By "Nemo" :—

Alcohol and Honey, 22  
 An Enemy of the Hive, 22  
 Are Bees Attracted by Colour of Flowers? 462  
 Bacon Beetle as an Enemy, The, 51  
 Baron Bela v. Ambrozy, 91  
 Bee-Keeping for Women, 11  
 Bee-Keeping Proselytism, 333  
 Bees Transporting Eggs, 313  
 Care of Extracted Honey, The, 292  
 Foul Brood Insurance in Switzerland, 313  
 Good Bee Flowers, 51  
 Granulated Honey, 12  
 Introducing Queens, 11, 461  
 Judicious Protection of Hives, 51  
 Making Artificial Swarms, 312  
 Massacre of the Drones, 12  
 Mignonette as a Bee Plant, 22  
 Mineral Constituents of Honey, 333  
 Preserving Combs from Wax-Moth, 461

Protecting Hives from Ants, 312  
 Safe Covers for Honey Jars, 292  
 Time Taken by Bee to Get a Load of Pollen, 312  
 Treatment of Foul Brood in Germany, 23  
 Value of Bees in Agriculture, 22  
 Wax-Working of Bees, 91  
 Winter Flight of Bees, 23

CAPPINGS OF COMB. By L. S. Crawshaw, Norton, Malton, Yorks :—  
 Ants, Bees, and Wasps, 378  
 B.B.K.A. *Conversazione*, 197  
 Bee-Escapes, 467  
 Bee-Keeping Examinations, 16  
 Bee Notes from Germany, 48  
 Bee-Pest Act in Ireland, 16  
 Bee-Stings, 278, 337, 437, 468  
 Bees in Agriculture, 67  
 Candy-Making, 48, 87  
 Colour and Bees' Temper, 138  
 Co-operative Honey Company, 68  
 Cost of Disease, 177  
 Creating a Honey Market, 509  
 Cutting Foundation, 238  
 Dealing with Swarmed Stocks, 337  
 Driven Bees, 457, 508  
 Drone Breeder, A, 337  
 Drone v. Worker Comb, 487  
 Dummy Board, 18, 177, 238  
 Entomology, 15  
 Foul Brood in Belgium, 48  
 Foul Brood Legislation, 48, 138  
 Folding Sections, 238  
 Granulated Honey, 48  
 "Hand" Control Device, 108  
 Hives, Nuclei, and Driven Bees, 107  
 Honey by Rail, Sending, 468  
 Honey Prices, 138, 418  
 Hornets' Nest, A, 418  
 Instinct, 307  
 "Isle of Wight" Disease, 16, 197, 218, 257, 468, 508  
 Lighting a Smoker, 257  
 Load of a Bee, The, 378  
 Mineral Constituents of Honey, 379  
 Notes from Cornwall, 307  
 Number 1 Gland System, 67  
 Nucleus or Nuclei, 138  
 Painting Hives, 219  
 Painting Queens, 468  
 Parthenogenesis, 107, 196  
 Position of Stores, 307  
 Preventing Increase, 307  
 Propolis, 218, 238, 468  
 Queen Excluder, 237  
 Queen Introduction, 67  
 Quilts and Wax-Moth, 218  
 Renewal of Old Combs, 437  
 Scarcity of Swarms, 277  
 Shaking Bees from Combs, 379  
 Size of Frame, 177  
 Simmins' Treatment, The, 437  
 Spraying Charlock, 178  
 Starvation, 49  
 Strong Stock, 277  
 Sugar Feeding and Disease, 437  
 Swarm Control, 337  
 Tea for Bees, 238  
 The Season—A Warning, 258  
 Treasury Grant, The, 337  
 Webb's Hive Divider, 87  
 Where is the English Bee? 438  
 Winter Brood-Chamber, 107, 197  
 Wiring Frames, 87, 277  
 Wooden Extractor, 488  
 W. L. Hutchinson, 278

AMERICAN AND COLONIAL PAPERS :  
 Extracts and Comments, by D. M. M. Banff, 39, 77, 127, 166, 206, 247, 295, 386, 428, 475, 513

NOTES BY THE WAY. By Wm. Woodley, Beedon, Newbury :—  
 B.B.K.A. Grant, The, 354  
 Bee Disease Legislation, 184, 486  
 Bees in June, 255  
 Bees in October, 425  
 Bees in Spring, 74, 137

FEB 29 1916

- Bee-Sting Cures, 273  
 Candy-Making, 14  
 Combination Hive, The, 464, 486  
 Enlarging the Brood-Nest, 205  
 Fencing the Apiary, 335  
 Fighting Bee Disease, 34, 74, 93, 137  
 Finding a Market for Honey, 374  
 Fitting Sections, 205  
 Getting Stocks into Condition, 354  
 Honey-Flow in July, 335  
 Honey Prices, 255  
 "Isle of Wight" Disease, 54, 105  
 July Heat, 273  
 McEvoy Method, The, 34  
 Preparing Stocks for Winter, 374  
 Queen Rearing, 274  
 Recipe for Syrup, 75  
 Sending Bees by Rail, 15  
 Smoking at Entrance, 93  
 Storing Honey, 425  
 Straw Skep at a Honey Producer, 54, 74  
 Wasp Plague, The, 354  
 Wiring Frames, 234
- ANNUAL MEETINGS OF BEE-KEEPERS' ASSOCIATIONS:—**  
 Aberdeens, 181; British, 112; Crayford and District, 452; Cumberland, 52; Glamorgans, 81; Leicesters, 152; Middlesex, 172; Mid-Kent, 103; Northumberland and Durham, 116, 281; Notts, 101; Shropshire, 181; Somerset, 116; Staffs, 117; Surrey, 211; Warwick, 172; Worcesters, 72.
- BEE AND HONEY SHOWS:—**  
 Ayrshire Agricultural Society, 441; Cambridge Honey Show, 414; Cambridge Mammoth Show, 391; Cheshire B.K.A., 381; Crayford and District B.K.A., 382; Dairy Farmers' Association, 402; Glamorgan B.K.A., 311; Gloucesters B.K.A., 355; Grocers' Exhibition, 372; Hailsham and District B.K.A., 323; Herefords, B.K.A., 481; Hitchin and District B.K.A., 341; Kent Honey Show, 341; Lancashire B.K.A., 331; Leicesters, B.K.A., 332; Northants B.K.A., 351; Royal Show at Norwich, 252, 261; Shropshire B.K.A., 361; Somerset B.K.A., 321; South of Scotland B.K.A., 383; Sussex B.K.A., 442; Warwick, B.K.A., 352; Whitby B.K.A., 481.
- Abnormal Winter, An, 102  
 Advertising Honey, 25  
 Advertising in the "B.B.J.," 377  
 Africa, Bees in Parkest, 145  
 Age of Flight, 355  
 Age of Queens, 478  
 Age of Worker Bees, 199, 408  
 Agriculture, Bees in, 22, 67  
 Alcohol and Honey, 22  
 Alexander Method, The, 57  
 American Standard Frame, 95  
 Amount of Honey and Wax in a Section, 400  
 An Appreciation, 410  
 Ancient Apiculture, 152, 301, 466  
 Andover and District B.K.A., 501  
 Anatomical Drawings, 296  
 Animals Breaking Bounds, 328  
 Another Strike, 355  
 Ants Protecting Hives from, 312  
 Apiary, An Egyptian, 447  
 Apiary, a South African, 175  
 Apiary, A Suburban, 224  
 Apiary, Re-arranging, 139  
 Apiaries Regulation Act, 445, 445  
 Apiculture, B.B.K.A. and, 33  
 Apicultural Education in England, 144  
 Apicultural Notes, 174  
 Artificial Increase, 178, 237, 266, 312, 357, 387, 499  
 Artificial Pollen, 387  
 Ascertaining the Quality of Honey, 9
- Associations, Bee-Keepers', 377, 427  
 At the "Royal" Show, 284  
 Auction Sales of Bees, 251  
 Auricle and Pollen Collection, The, 491  
 Australia, Bee-Keeping, in, 32, 50, 78, 98  
 Australia, Taking Queens to, 358  
 Autumn, Foul Brood in, 357  
 Autumn, Uniting Bees in, 357  
 Aylesbury as a Honey District, 90
- Bacon Beetle as an Enemy, The, 51  
 Bacillus Gaytoni, 259  
 Badly Capped Sections, 388  
 Badly Drawn-Out Sections, 228  
 Barnett, New Association for, 461  
 Bedford, Lecture at, 499  
 Bee, Cleanliness of the, 322  
 Bee Control Cloth, 169  
 Bee Culture in Kashmere, 495  
 Bee-Disease Act in Ireland, 8, 15, 16, 46, 29  
 Bee-Disease and Sugar-Feeding, 277, 285, 305, 335, 375, 397, 437, 471, 498  
 Bee-Disease, Causes of, 217, 225, 226, 305  
 Bee-Disease, Fruit-growers and, 155  
 Bee-Disease in Hampshire, 108, 498  
 Bee-Disease, Spread of, 108  
 Bee-Disease, Need of Legislation for, 155, 275, 299, 306, 415, 441, 443, 445, 502, 506  
 Bee-Districts, Good, 88  
 Bee, Education of the, 321  
 Bee-Escape, Using the, 367, 384  
 Bee-Farming as a Business, 158  
 Bee-Flowers, 22, 51, 55, 149, 498  
 Bee, Food of the, 207  
 Bee-Food, Honey v. Sugar as, 63  
 Bee-Hive, A Petrified, 179  
 Bee-Keepers' Associations, 377, 427  
 Bee-Keepers and Disease, 193  
 Bee-Keepers, Co-operation for, 26, 37, 68  
 Bee-Keeping for Women, 11, 247  
 Bee-Keeping in Ancient Times, 152, 301; in Australia, 50, 98; in Darkest Africa, 145; in Italian Riviera, 237; in Lincolnshire, 385; in Michigan, 244; in New Zealand, 135; in Ontario, 88; in Oxfordshire, 276; in Queensland, 249; in South Africa, 45, 175, 223; in The Cotswolds, 46  
 Bee-Keeping, My Introduction to, 294  
 Bee-Keeping on a Large Scale, 19, 158  
 Bee-Keeping, Protection and, 5  
 Bee Literature, Old, 57, 69, 78, 89  
 Bee-Notes, A Novice's, 466  
 Bee-notes from Cornwall, 274, 295, 405; Derbyshire, 473; Germany, 4, 49; North Essex, 356; Ross-shire, 66, 105, 125, 205, 222, 263, 282, 304, 344, 362, 405, 436; Somerset, 454; Sussex, 306  
 Bee Paralysis, 205, 344, 436  
 Bee-Shows to Come:—  
 159, 189, 199, 209, 219, 229, 239, 248, 258, 268, 278, 287, 297, 308, 317, 328, 338, 347, 358, 369, 399, 410, 419, 430  
 Bee Sounds, 237, 369  
 Bee-Stings, Cure for, 246, 256, 275, 274, 275, 278, 283, 317.  
 Bee Story, A, 367, 386, 468  
 Bees and Clover Pasture, 297  
 Bees and Colours, 77, 81, 138, 462  
 Bees and Comb-Building, 91  
 Bees and Earwigs, 147  
 Bees and Flowers, 484  
 Bees and Fowls, 50  
 Bees and Fruit Pollination, 98, 159, 187, 232  
 Bees and Heather, 317  
 Bees and Neighbours, 119, 160  
 Bees as Trespassers, 14  
 Bees at Auction Sales, 251  
 Bees, Building in Candy-box, 188  
 Bees, Carniolan, 76, 205  
 Bees, Clustering Outside Hive, 316  
 Bees Collecting Old Propolis, 396, 468
- Bees Damaged in Transit, 50  
 Bees Dead under Cherry Tree, 235  
 Bees, Driven, 194, 329, 333, 367, 416, 467  
 Bees, Driving, 326, 334, 353, 385, 418  
 Bees Dying in Well-stored Hive, 47, 68  
 Bees, Enemies of, 17, 22, 51, 147., 158, 245  
 Bees, Feeding, 10, 47, 70, 83, 100  
 Bees, Hybridizing, 37, 118, 119  
 Bees in Agriculture, 22, 67  
 Bees in a Hollow Tree, 453  
 Bees in a Shed, Wintering, 76  
 Bees in Observatory Hive, 355, 388  
 Bees in Stornaway, 181, 205  
 Bees, Moving, 45, 68, 109, 152, 378  
 Bees, Native v. Italian, 139  
 Bees Not Taking to Supers, 265, 325  
 Bees Requeening Themselves, 453  
 Bees, Sending by Rail, 10, 14, 88, 186  
 Bees, Spraying Fruit-trees and, 47  
 Bees, Strange Behaviour of, 96, 158, 185  
 Bees, Subduing, 96  
 Bees Suffering from Dysentery, 70  
 Bees Superseding Queen, 235  
 Bees, Transferring, 68, 88, 267, 268, 326, 368, 398, 417  
 Bees Transporting Eggs, 313, 379  
 Bees under Snow, 168, 238  
 Bees, Uniting, 119, 298, 326, 478  
 Bees Visiting Drains, 209  
 Bees Visiting Mineral Water Factory, 285  
 Bees, Water for, 317  
 Bees, Wild, 189, 199, 229  
 Bees' Wing-power v. Nosema Apis, 395  
 Bees, Winter Flight of, 23  
 Beeswax, Judging, 289  
 Beginning Bee-Keeping, 31, 100  
 Beginners' Oceries, 37, 57, 76, 129, 257, 278, 317, 389, 399, 417, 448, 457  
 Belgium, Foul Brood in, 3, 48, 53  
 Bermuda, Bees in, 64  
 Bioscope and Bee-Keeping, The, 116, 324, 499  
 Board of Agriculture and Bee Disease, 147, 201, 331  
 Books on Wild Bees, 90, 209  
 Rotting Honey, 378  
 Braze Combs, 188, 345  
 Braula *Cocca* or Blind Louse, 120, 245, 389  
 Brie Swarm-Catcher, The, 297  
**BRIF REPORTS from**  
 Bedford, 456; Berkshire, 456; Cambridge, 456; Cheshire, 456; Cumberland, 456; Devonshire, 456; Dorset, 456; Durham, 457; Essex, 457; Gloucestershire, 457; Herefords, 457; Hants, 457; Hertfords, 457; Isle of Man, 457; Kent, 457; Monmouthshire, 476; Middlesex, 476; Northampton, 477; Northumberland, 477; Oxford, 477; Shropshire, 477; Somersetshire, 477.  
 British B.K. Association and Apiculture, 33  
 British B.K.A. Conversazione, 121, 126, 131, 141, 197, 411, 421, 431  
 British B.K.A. Library, 30, 33, 43  
 British Golden Bees, 308  
 Brood-Cells not Capped, 249  
 Brood-Chamber, Storing Surplus in, 118, 256, 294, 299  
 Brood-Chamber, Winter, 39, 56, 107, 123, 197  
 Brood-Combs, Renewing, 149, 358  
 Brood-Nests, Enlarging the, 205  
 Brood-Rearing, Late, 467  
 Buying Bees, 80  
 Cake Recipe, Honey, 315  
 Canadian B.J. and English Shows, 13  
 Candy as a Food for Bees, 448, 485  
 Candy-Making, 14, 20, 48, 60  
 Candy, Using Soft, 27  
 Carbolic Acid as a Subduer, 102  
 Carbolic Control Cloth, Making a, 267  
 Care of Extracted Honey, 286, 292, 355

- Carniolan Bees, 76, 206  
 Cappings, Difference between Honey and Brood, 279  
 Casts, Preventing, 292  
 "Catch My Pal," 2  
 Causes of Disease, Possible, 217, 225, 226, 305  
 Charlock Spraying and Disease, 166, 126, 135, 159, 178  
 Cheap Home-made Hives, 44, 56, 438  
 Clipping Queens' Wings, 348  
 Clover Pasture and Bees, 297  
 Cleanliness of the Bee, 322  
 Colony, The Ideal, 167  
 Colour Sense in the Bee, 77, 81, 138, 462  
 Comb-Foundation and Foul Brood, 27, 35, 46, 58, 75  
 Comb Honey, Preventing Granulation of, 338  
 Combination Hive, The, 464, 486  
 Combs, Dealing with Extracted, 438  
 Combs, Fumigating, 62, 90  
 Committee on Bee Diseases, 463  
 Completing Unsealed Sections, 227  
 Cone Escapes, 103  
 Control Cloth, 77, 169, 267  
 Controlled Fertilization of Queens, 364, 501  
 Controlling Disease in Michigan, 386  
 Controlling Swarming, 39, 46, 108, 128, 244, 255, 265, 275, 337, 345, 384, 394  
 Conversazione of B.B.K.A., 121, 126, 131, 141, 197, 411, 421, 431  
 Co-operation for Bee-keepers, 26, 37, 58  
 Cornwall, Notes from, 274, 295  
 Correction, A, 125  
 Cost of Disease, 77, 93, 177  
 Cotswolds, Bees in the, 416  
 Cottager, A Successful, 444  
 Covers for Honey Jars, 292  
 Crayford B.K.A., 271, 323  
 Criticisms, 187, 412  
 Cumberland B.K.A., 69  
 Cures for Bee-Stings, 245, 256, 273, 275, 278, 285  
 Cure for Isle of Wight Disease (Simmins), 358  
 Curious Incident, A, 235  
 Damage Done by Bees, Liability for, 398  
 Dead Bees in Section Rack, 316  
 Dealing with Foul Brood, 407  
 Dealing with Isle of Wight Disease, 188, 407, 417, 428, 454  
 Death of Baron Bela V. Ambrozy, 91; Mr. C. Dunn-Gardner, 502; Mr. W. Z. Hutchinson, 251, 278; Mr. D. A. Jones, 72  
 December Pollen Gatherings, 507  
 Decorating Prize Wax, 502  
 Defective Sections, 501  
 Density of Honey, Increasing the, 249  
 Destroying Wild Bees, 209  
 Difference between Honey and Brood Cappings, 279  
 Disease, Cost of, 77, 93, 177  
 Disease, Experiments in Treating, 454  
 Disease, Experts and, 83  
 Disease, Foreign Bees and, 127  
 Diseased Stock in Autumn, Treating, 438  
 Disease, Medicated Syrup and, 195  
 Disease, Possible Causes of, 217, 225, 226, 305  
 Disease, Ravages of, 94  
 Disease, Spraying Charlock and, 106, 126, 136, 159, 178, 186, 194  
 Disinfecting Hives, 70, 100, 159, 221, 228  
 Disinfecting Combs, 62, 90, 400  
 Disinfection, Foul Brood and, 8, 40, 154  
 Disinfection in Australia, 78  
 Disinfection in New Zealand, 8, 26, 34  
 Dividing for Increase, 259, 285  
 Dividing Swarmed Stock, 470  
 Drains, Bees Visiting, 409  
 Drawn-out Combs, 117, 129  
 Driven Bees, 194, 329, 355, 467; Dealing with, 367, 416; Nuclei and, 107; Wintering, 458  
 Driving Bees, 326, 334, 353, 385, 418  
 Drone Breeding Queens, 173, 282, 337  
 Drone Brood in Super, 269, 286  
 Drone Eggs in Worker Cells, 209  
 Drone - Foundation for Swarm, Using, 398  
 Drons, Flight of the, 319  
 Drones, Early, 139  
 Drones in October, 419  
 Drones, Massacre of the, 12  
 Drone v. Worker Cells in Super, 54, 345, 356, 397, 409, 406, 507  
 Dry Season and Disease, The, 485  
 Dual-Queen Systems, 66, 105  
 Dummy Board, Use of, 205  
 Dummy or Division Board, 17, 103, 177, 238  
 Dwindling Stock, 479  
 Dying Bees, 50  
 Dysenteric Bees, 70  
 Dysentery and Nosema Disease, 371  
 Dysentery, Malignant, 201, 311, 371  
 Dzierzon Centenary, The, 21, 95  
 Earliest Stages of Foul Brood, 229  
 Early Drones, 139  
 Early Honey-Gathering, 166, 223  
 Early Life of the Bee, 432  
 Early Pollen Bearing Shrub, 55, 75  
 Early Pollen Gathering, 43, 56  
 Early Queen Mating, 160  
 Early Swarm, An, 195  
 Earwigs and Bees, 147  
 Echoes from the Hives, 77, 148, 167, 228  
 Education of the Bee, 321  
 Egg-Laying, The Queen's, 387, 432  
 Eggs, Bees Transporting, 313, 379  
 Egyptian Apiary, An, 447  
 Eke Left on Hive, 228  
 Embedding Wires, 24, 64, 87  
 Enemies of Bees, 17, 22, 51, 147, 158, 245  
 England Still in Front, 13  
 English Apiary in Germany, 6  
 English Bee? Where is the, 376, 458  
 Enlarging the Brood-Nest, 495  
 Enlightened Bee-keepers, 127  
 Enthusiasm, 128  
 Error in Manipulation, 478  
 Essex, Disease in, 177  
 Evesham, Good Report from, 217  
 Excellent Return, An, 437, 467  
 Excluder Line, 55, 166, 237  
 Exhibiting Honey, 204, 224, 289, 314  
 Experiment, An Interesting, 243  
 Experiments in Treating Disease, 454  
 Experts and Disease, 83  
 Experts, Injustice to, 446  
 Extracted Combs, Dealing with, 438  
 Extracted Honey, Care of, 285, 292, 356  
 Extracted Honey, Working for, 368  
 Extracting Wax, 313, 514, 428  
 Extracting Heather Honey, 6, 30  
 Extracting Honey from Infected Combs, 10  
 Extracting Honey, Points in, 325  
 Extractor, Inexpensive, 199  
 Extractor, Preventing Rusting of, 358, 464  
 Extraordinary Phenomenon, 177  
 Facts about Bees, 445  
 Features of the Season, 362  
 Feeder, Observatory Floor-Board, 479  
 Feeding and Bee Diseases, 195, 277, 285, 305, 335, 375, 397, 437, 471, 498  
 Feeding Bees, 19, 47, 70, 83, 100, 174, 468  
 Feeding in Spring, 47, 70, 174, 468  
 Feeding, Stimulative, 95, 204  
 Feeding the Young Larvae, 7, 25, 68  
 Feed the Bees, 83  
 Fencing the Apiary, 315, 335, 346, 355  
 Ferdinand and the Census, 139  
 Fermented Honey, Utilising, 327  
 Fertile Workers, 24, 398  
 Fertilization of Fruit, 117, 232  
 Fertilization of Queens, 15, 46, 75  
 Fighting Among Bees and Disease, 55  
 Fighting Foul Brood, 65, 86, 106, 285, 506  
 Finding a Market for Honey, 365, 375, 386, 411, 436, 472  
 Finding the Queen, 118, 173, 339, 396  
 First Examinations, 162  
 Fittest, Survival of the, 444  
 Flight, Age of Bees, 355  
 Flight of Bees in Winter, 25  
 Flight of the Drone, 319  
 Floor-board, Cleaning the, 308  
 Flowers of Bees, 51, 55, 149, 484, 495  
 Flowers of January, 38, 87  
 Flood of the Bee, 207  
 Food for Bees, Candy as, 448  
 Folding Sections, 205, 238  
 Foreign Bees and Disease, 127  
 Foreign Honey, Prices of, 348  
 Foul Brood, Dealing with, 8, 40, 154, 407  
 Foul Brood, Earliest Stage of, 230  
 Foul Brood, Foundation and, 27, 35, 46, 68, 75  
 Foul Brood in Autumn, Dealing with, 357  
 Foul Brood in Belgium, 3, 48, 55  
 Foul Brood in Germany, 23  
 Foul Brood Insurance, 171, 313  
 Foul Brood Legislation, 7, 48, 65, 65, 80, 81, 84, 94, 95, 138, 165, 231, 296  
 Foundation, Comb, 253  
 Foundation Cutting, 205, 238  
 Fowls and Bees, 50  
 Frame, American Standard, 93  
 Frame Hive, A, 502  
 Frame Lifter, A New, 346  
 Frame, Size of, 177  
 Frames, Spacing, 70  
 Frames, Storing Fitted, 267  
 Frames, Wiring, 234, 241, 242, 277  
 Fruit Growers and Bee Disease, 155  
 Fruits, Pollination of, 98, 159, 187, 232  
 Fruit Trees, Spraying, 47, 179, 193, 268  
 Fumigating Combs, 62, 90  
 Germany, Bee Notes from, 4, 48  
 Germany, English Apiary in, 6  
 Germany, Foul Brood in, 23  
 Glamorgan B.K.A. Report, 81  
 Glass Sides for Observatory Hive, 163  
 Gleanings from Ancient Apiculture, 152, 301  
 Gleanings from "Gleanings," 207  
 Good Honey, 192  
 Good Report from Evesham, A, 217  
 Good Result, A, 295, 437, 467  
 Good "Take," A, 496  
 Grant to B.B.K.A., 291, 337, 342, 397  
 Granulated Honey, 12, 48  
 Granulation of Honey, 479  
 Granulated Sections, Dealing with, 359, 500  
 Green Fly, Parthenogenesis and, 195  
 Grocers' Exhibition The, 414  
 "Guide Book," New Edition of, 241, 362  
 Hampshire, Bee Disease in, 108, 498  
 "Hands" Control Device, 64, 108, 128  
 Hayfork, Novice and a, 423  
 Heather and Bees, 317  
 Heather Honey Extracting, 6, 30  
 Heather Honey, Pressing, 359  
 Heather Season, Plans for the, 304, 357, 405  
 Heather, Taking Bees to the, 319, 327  
 Hedge, Planting, 410  
 Hermaphrodite Bee, 139  
 Hive Blow Over, 449  
 Hive-Divider Webb's, 87  
 Hive Floors, 194  
 Hive-Making, 30, 44, 76, 327, 385, 409, 488  
 Hive, Suitable Position for, 37

- Hive-Roofs, Making Watertight, 405, 429  
 Hive-Roofs, Securing, 464  
 Hive, The Best, 598  
 Hive, Utilising Large, 448  
 Hives, Cheap Home-made, 44, 55, 488  
 Hives, Disinfecting, 190, 159, 221, 228  
 Hives for the Moors, 410  
 Hives in Pairs, 295  
 Hives, Observatory, 80, 163, 194, 305, 327, 355, 386  
 Hives, Painting, 103, 109, 155, 166, 176, 194  
 Hives, Protection of, 51, 232  
 Hives, Shading, 257  
 Hives, Spring Cleaning, 109  
 Hiving Swarms, 253, 453  
 Home-made Observatory Hive, 327, 385, 409  
 Homes of the Honey Bee, 17, 28, 52, 97, 157, 265, 324, 434, 454, 465, 505  
 Honey, Bottling, 378  
 Honey by Post or Rail, Sending, 596  
 Honey-Cake Recipes, 315  
 Honey-Cures, 151  
 Honey Exhibiting, 204, 2, 4, 229, 314  
 Honey, Finding a Market for, 363, 375, 386, 411, 436, 472  
 Honey, Flavour of, 207  
 Honey-Flow, Factors in Securing a, 262  
 Honey Gathering, Early, 166  
 Honey, Granulated, 12, 46, 479  
 Honey Harvest of 1911, 455, 476, 513  
 Honey Imports for December, 1910, 12; January, 64; February, 92; March, 143; April, 181; May, 231; June, 271; July, 337; August, 374; September, 414; October, 453; November, 491  
 Honey Imports for 1910, Total, 510  
 Honey Increasing, Density of, 249  
 Honey in Jars, Reliquifying, 259  
 Honey Jars, Covers for, 292  
 Honey-Maker, The, 362  
 Honey, Mineral Constituents of, 331, 379  
 Honey, Points in Judging, 289  
 Honey, Prices of, 9, 7, 158, 255, 548  
 Honey, Ascertaining Quality of, 9, 379  
 Honey Recipes, 151, 166, 315  
 Honey Selling, 25, 40, 365, 375, 386, 411, 428, 435, 439, 472, 476  
 Honey, Sicilian, 192  
 Honey, Storing, 425; in barrels, 129; in tins, 237, 419  
 Honey, Therapeutic Value of, 451  
 Honey? Too Much, 238  
 Honey, Utilising Comb, 119  
 Honey Vinegar, 479  
 Honey v. Sugar as Bee Food, 63  
 Honey, Working for, 169, 207  
 Honey Yield, Period of, 369  
 Hopeful Season, A, 225  
 Horses, Risk to, 515, 355, 346, 355  
 Humble Bee, The, 28, 254, 466, 485  
 Hybridizing Bees, 37, 118, 119  
 If Your Bees are a Nuisance, 46  
 Immature Bees Cast out, 269  
 Incident, A Curious, 255  
 Increase, Artificial, 178, 237, 266, 312, 357, 387, 499  
 Increase, 151, 169, 178, 237  
 Increase and Surplus, Working for, 169, 207  
 Increasing Stocks, 156, 225  
 Increase, Preventing, 199, 227, 256, 266, 307  
 Inducing Bees to Enter Supers, 264  
 Infected Combs, Extracting Honey from, 10  
 Inexpensive Extractor, 199  
 Injustice to Experts, 446  
 Insurance of Bees, 146, 171, 311  
 Interesting Experiment, 243  
 Introducing Queens, 11, 67, 244, 263, 358, 406, 461  
 Ireland, Bee Diseases Act in, 8, 15, 16, 46, 89  
 ISLE OF WIGHT DISEASE, 54, 55, 74, 82, 86, 87, 105, 107, 115, 121, 127, 131, 137, 141, 145, 149, 155, 154, 156, 164, 165, 171, 184, 185, 188, 206, 211, 218, 257, 264, 383, 407, 417, 428, 482, 498, 502  
 Isle of Wight Disease, Board of Agriculture and, 147, 201, 351  
 Isle of Wight Disease, Simmins' Cure of, 358  
 Isle of Wight Disease, Sugar and, 277, 285, 305, 335, 375, 397, 437, 471, 498  
 Isle of Wight Disease Symptoms of, 188, 482  
 Italian Bees and Honey Dew, 128  
 Italian Bees, Sociability of, 57  
 Italian Riviera, Bee-Keeping in, 237  
 January, Flowers of, 38, 87  
 January, Weather in, 63  
 Jottings, 247  
 Journalism, Sensational, 50  
 Judging, Points in, 289  
 Judging Sections, 339, 345  
 July Heat, 275  
 Justice to Wasps, 487  
 Kashmir, Bee Culture in, 495  
 Kashmir Queen, A, 249  
 Keep Better Bees, 429  
 Keeping Bees near High Road, 329  
 Keeping Honey in Tins, 237, 419  
 Keeping Records, 7  
 Keeping Unused Stores, 228  
 Lady's Ingenuity, A, 39  
 Larvæ, Feeding the Young, 7, 25  
 Larva, The, 453  
 Larva, Uncapped, 198  
 Late Brood-Rearing, 457  
 Late Reared Queens, 329  
 Late Surplus Storing, 346  
 Late Swarm, A, 368, 403  
 Laying Workers, Depositing, 24, 398  
 LECTURES ON BEE-KEEPING at Beckenham 211; Bedford, 499; Crayford, 323; Dartford, 271; Stocksfield-on-Tyne, 281; Whitby, 61; in England and Wales, 144, 218  
 Legislation for Bee Diseases, 32, 65, 66, 251, 275, 299, 306, 415, 441, 443, 445, 502  
 Legislation, Foul Brood, 7, 48, 66, 80, 81, 84, 94, 95, 138, 215, 231, 275, 283, 299, 506, 506  
 Legislation in America, 81, 296, 386; in Australia, 32; New Zealand, 215; Switzerland, 238  
 Lewis, Bee-Keeping in, 206  
 Liability for Damage done by Bees, 398  
 Library, The B.B.K.A., 30, 53, 43  
 Life of Bee, Duration of, 199, 408  
 Lighting a Smoker, 222, 257  
 Lincolnshire, Season in, 385  
 Literature, Old Bee, 57, 69, 78, 89  
 Live Bees, Railway Rates for, 345  
 Load of a Bee, The, 378  
 Malden (Dr.) on Isle of Wight Disease, 121  
 Malignant Dysentery, 201, 311  
 Manipulating, 222; Time for, 228  
 Manipulating, Error in, 473  
 Manipulating Supered Stock, 267  
 Market for Honey Finding a, 365, 375, 386, 436, 472  
 Marketing Honey, 411  
 Massacre of the Drones, 12  
 Material for Quits, 269, 318  
 Meaning of "Hatching," 30  
 Medicated Syrup, 120; and Disease, 195  
 Mice and Rats in Hives, 18, 158  
 Michigan, Bees in, 244, 386  
 Microscopic Objects, Preparing, 389  
 Midlothian B.K.A., 162  
 Mid Pike and Fell, 35  
 Mignonette as a Bee Plant, 22  
 Mineral Constituents of Honey, 331, 379  
 Mineral Water Factory, Bees Visiting, 285  
 Moors, Hives for the, 410  
 Moving Bees, 45, 68, 109, 152, 378  
 Moving Skep from Frame Hives, 96  
 Nature Study at Schools, 205, 426  
 Nectar, A Flow of, 262  
 NECTAR PRODUCING PLANTS and Their Pollen. By George Hayes: Apple, 23; Blackberry, 214; Borage, 12; Coltsfoot, 393; Hawthorne, 91; Heather, 305; Horse-chestnut, 242; Lime, 272; Primrose, 103; Sycamore, 163; Willow, 433  
 Need for Legislation, 65, 66, 231, 275, 299, 306, 415, 506  
 Neighbourhood and Bees, 119, 160  
 New Zealand, Bee-Keeping in, 135  
 New Zealand, Foul Brood in, 8, 25, 34, 215  
 Noise in Hive, Peculiar, 369  
 Non-Swarming Plan, 40, 50  
 North Norfolk, Record Season in, 295  
 Northumberland B.K.A., 271  
 Nosema Apis and Dysentery, 371  
 Nosema Apis, Bees' Wing-power, and, 395  
 Notice to Readers, 359, 470  
 November, Queenless Stock in, 449  
 NOVELTIES FOR 1911: Aluminium Rapid Feeder, 148; Bee-Control Cloth, 77; Feeder with Screw-Valves, 148; Frame Lifter, 348; Observatory Queen and Bee Catcher, 77; Perfection Frame and Block, 208; Queen Nursery Cage, 77; Steel Brush, 48  
 Novice's Bee-Notes, A, 486  
 Nuclei and Driven Bees, 107  
 Nucleus Hive, Wintering a, 408  
 Nucleus or Nuclei, 78, 138  
 Nuisance, If Your Bees are a, 146, 285  
 Number of Bees in a Hive, 309  
 OBITUARY: Baron Bela V. Ambrozny, 91; Mr. W. Z. Hutchinson, 251; Mr. D. A. Jones, 72  
 Observatory Feeder, 479  
 Observatory Hive, A Home-made, 327, 385, 409  
 Observatory Hive Out of Doors, 399  
 Observatory Hives, 80, 163, 194, 305, 355, 458  
 Obtaining Drawn Out Combs, 129  
 Obtaining Surplus, 169, 204, 227  
 October, Drone-Brood in, 419  
 Old Bee Literature, 57, 69, 78, 89  
 Old Books, Value of, 80, 90, 399  
 Old Combs, Renewing, 128, 437  
 Old English Recipes, 19  
 Ontario, Bee-Keeping in, 88  
 Our Humble Bees, 483  
 Oxfordshire, Bee-Keeping in, 276  
 Packing Sections, 281  
 Painting Hives, 103, 109, 159, 165, 166, 176, 194, 219  
 Painting Queens, 406, 468  
 Paralysis, Bee, 205, 344, 366, 456  
 Parasite on Bees, 120, 245, 246, 319  
 Parliament and Bees, 231  
 Parthenogenesis, 45, 75, 107, 196  
 Patent, Obtaining a, 319  
 Petrified Bee Hive, A, 179  
 Phenyle Solution, 119  
 Planting Hedge, 410  
 Poison in Stings, 209  
 Pollen, Artificial, 367  
 Pollen-bearing Shrub, Early, 55, 75  
 Pollen-Gathering, Early, 45, 56  
 Pollen-Gathering in December, 507  
 Pollen, How Collected by Bees, 491, 506  
 Pollen Mites, 47  
 Pollen, Nectar-producing Plants and, 12, 23, 91, 103, 163, 214, 242, 272, 303  
 Pollen, Overplus of, 281, 377  
 Pollen, Time taken by Bee in Gathering, 312  
 Pollen, Water and, 162  
 Pollination of Fruit Blossoms, Bees and, 98, 159, 187, 232  
 Position of Stores, 307  
 Preparing for Winter, 373, 402, 410, 424



- Presence of the Bee, 192  
 PRESS CUTTINGS: A Lost Pin, 19;  
 Bee-Keeping in South Australia,  
 98; Bees and Exotic Flowers, 50;  
 Bee Superstitions, 49; Petrified  
 Hive, 179; The Bee Martin, 238  
 "Preuss" Non-Swarming Method,  
 50  
 Preventing Brace-Combs, 188  
 Preventing Damp Hives, 509  
 Preventing Extractor from Rusting,  
 358, 464  
 Preventing Comb-Honey from  
 Granulating, 368  
 Preventing Swarming, 199, 227, 247,  
 255, 266, 292, 307  
 Prices of Honey, 78, 138, 255, 348  
 Prominent Bee-Keepers, 41, 191  
 Propolis, 118, 151, 193, 218  
 Propolis, Bees Collecting Old, 396,  
 468  
 Propolis, Removing, 195  
 Prosecutions under Bee Diseases  
 Act, 89  
 Protection and Bee-Keeping 5  
 Protection of Hives in Winter, 51,  
 232  
 Pure Race of Bees, Keeping, 409  
  
 Quality and Price of Honey, 379  
 Queen-Cell in Section Rack, 297  
 Queen-Excluder, 166, 237  
 Queen, Finding the, 118, 173, 359, 396  
 Queen Introduction, 11 67, 244, 263,  
 358, 406, 461  
 Queenless Bees Carrying Pollen, 259  
 Queenless Colony, United Bees and,  
 150  
 Queenlessness, 175; Suspected, 403,  
 408  
 Queenless Stock in November, 449  
 Queen-Mating, Early, 160  
 Queen-Mating in the Hive, 8, 15  
 Queen-Mating, Singular, 384  
 Queen-Rearing, 110, 274  
 Queen, Supposed Virgin, 178  
 Queen Surviving Disease, 275  
 Queen System, Dual, 66, 105  
 Queens, All About, 151  
 Queens, Age of, 478  
 Queens, Clipping, 348  
 Queens, Controlled Fertilization of,  
 364, 501  
 Queens, Drone-Breeding, 173, 282, 337  
 Queens, Egg-Laying, 387, 432  
 Queens, Fertilization of, 15, 46, 75  
 Queensland, Bees in 249  
 Queens, Late Reared 329  
 Queens, Painting, 406, 468  
 Queens, Two in One Cell, 266  
 Queries, Beginners', 37, 57, 76, 129,  
 257, 278, 317, 369, 399, 417, 448, 457  
 Queries, Various, 227, 517, 347, 389,  
 448  
 Quilts and Wax-Moth 218  
 Quilts, Material for 269, 318  
  
 Railway Rates for Live Bees, 345  
 Railway Station, Bees at a, 88, 186  
 Random Jottings, 417 446  
 Ravages of Disease, 194  
 Recipes, Honey, 151, 315  
 Recipes, Old English 19  
 Recollections of an Old Hand, 474,  
 507  
 Reliquifying Granulated Honey, 239  
 Removing Bees from a Roof, 511  
 Removing a Swarm, 316  
 Removing Skop from Frame Hive,  
 96, 237  
 Removing Sour Honey from Comb,  
 10  
 Removing Surplus, 316  
 Rendering Wax, 8, 314, 429, 458  
 Renewing Brood-Combs, 149, 356  
 Renewing Old Combs 128 437  
 Requeening, 47, 178 421, 431, 478  
 Requeening "Wells" Hive, 326  
 Risk to Horses, 315, 335, 346 355  
 Roof, Putting on the, 225, 258  
 Roof, Swarm Building in, 247  
 ROSS-SHIRE NOTES. By J. M. Ellis:  
 66, 105, 125, 185, 205 223, 263, 282,  
 304, 344, 362, 405, 436  
 Royal Show at Norwich, 192, 284  
  
 Scarcity of Food in April, 150  
 Sealed Stores, 168  
 Season, Features of the, 225, 362  
 Season of 1911, Reports on the, 456,  
 476  
 Section, Amount of Honey and Wax  
 in a, 409  
 Sections, Badly Capped, 388  
 Sections, Badly Drawn-out, 228  
 Sections, Completing Unsealed, 227  
 Sections, Defective, 501  
 Sections, Drone-Brood in, 269  
 Sections, Folding, 205, 238  
 Sections, Granulated, 359, 500  
 Sections, Judging, 359, 345  
 Sections, Packing, 281  
 Securing Hive-Roofs from Storms,  
 449, 464  
 Sending Honey, 25, 40, 363, 375, 386,  
 411, 428, 436, 439, 472, 476  
 Sending Bees by rail, 10, 14, 88, 186  
 Sending Honey by Post or Rail, 396  
 Sensational Journalism, 60  
 Shading Hives, 257  
 Shakespeare and the Bee, 95  
 Shaking Bees from Combs, 379  
 Shallow Frames for Shows, 358  
 Shows, Exhibiting at Honey, 204,  
 224, 269, 314  
 Sicilian Honey, 192  
 Simmins' Cure for "Isle of Wight"  
 Disease, 358, 366  
 Size of Frame, 177  
 Skop, Removing from Frame-Hive,  
 96, 237  
 Skop, Passing of the, 43  
 Sladen (Mr.) on Pollen Collection,  
 491, 506  
 Small-Holdings Exhibition, 38  
 Smoker, Lighting the, 222, 257  
 Smoking the Entrance, 77, 93, 296  
 Smogrove Method of Re-queening,  
 421, 431, 478  
 Snow, Bees under, 167, 237  
 Solar Wax-Extractor, 244, 314, 345  
 Sounds Made by Bees, 237 369  
 Sour Honey in Combs, 10  
 South African Bee-Keeping, 45, 54,  
 107, 175, 203, 512  
 Southern Snatches, 54, 107  
 Spacing Frames, 70, 469  
 Spacing Hives at the Moors, 358  
 Spraying Charlock and Disease,  
 106, 126, 135, 159, 178, 166, 194  
 Spraying Fruit Trees and Bees, 47,  
 179, 192, 268  
 Spread of Bee Disease, 108  
 Spring-Cleaning Hives, 109, 162  
 Spring-Feeding, 47, 70, 174, 468  
 Spring-Management, 188  
 Standard Frame, American, 95  
 Stapleton's Apiary, Visit to Mr., 236  
 Stimulative Feeding, 96, 204  
 Sting of the Bee, 209, 488  
 Stockholm Tar and Bees, 140  
 Stocks, Increasing, 156  
 Stores, Importance of, 261  
 Stores, Position of, 307  
 Storing, Extracted Honey, 285  
 Storing Fitted Frames, 267  
 Storing, Late Surplus, 346  
 Storing Surplus in Brood Chamber,  
 118, 256  
 Storifying for Surplus, 178  
 Stonorway, Bees in, 181, 206  
 Stray Swarm Entering Hive, 278  
 Strange Behaviour of Bees, 96, 158,  
 185  
 Strong Stocks, Making, 168, 229, 277  
 Subduing Bees, 96  
 Suburban Apiary, A, 224  
 Successful Cottager, A, 444  
 Sugar as Bee-Food, 63, 305  
 Sugar-Feeding and Disease, 277, 285,  
 303, 335, 375, 397, 437, 471, 498  
 Suitable Position for Hive, 37  
 Super Clearer, Using the, 129, 166,  
 308, 367, 384  
  
 Super, Drone v. Worker Cells in the,  
 54, 345, 356, 397, 400, 405  
 Super, Drone-Brood in, 286  
 Supersed Stock, Manipulating a, 267  
 Supers, Bees Refusing to Enter, 264,  
 266, 325.  
 Superseding Queen, 235  
 Supers, Inducing Bees to Enter, 264,  
 266  
 Supers, Time to put on, 269  
 Superstitions, Bee, 49  
 Surplus Pollen in Combs, 281, 377  
 Surplus, Procuring, 442, 462  
 Surplus, Removing, 316  
 Surplus, Working for, 75, 442, 462  
 Survival of the Fittest, 444  
 Suspected Queenlessness, 400, 408  
 Sussex, Bee-Notes from, 306  
 Swarm, An Early, 195  
 Swarm Building in Hive-Roof, 357  
 Swarm-Catchers, 218, 297, 509  
 Swarm, Curious Location for, 216  
 Swarmed Stocks, Dealing with, 285,  
 337  
 Swarmed Stock, Dividing, 470  
 Swarming, Controlling, 39, 46, 128,  
 244, 255, 263, 275, 337, 344, 384, 394  
 Swarming during Manipulation, 259  
 Swarming, Persistent, 227  
 Swarming, Prevention of, 159, 227,  
 247, 256, 266, 292, 307  
 Swarming Vagaries, 316, 365  
 Swarm Returning to Parent Hive,  
 256, 472  
 Swarm, Removing a 216  
 Swarms, All About, 271  
 Swarms Hiving, 253, 453  
 Swarms, Making Artificial, 312  
 Swarms, Scarcity of, 234, 277  
 Swiss Foul Brood Insurance, 171 313  
 Symptoms of "Isle of Wight"  
 Disease, 188, 482  
 Syrup and Disease, Medicated, 195  
 Syrup-Feeding, 140  
 Syrup, Making, 120, 403  
 Syrup, Medicated, 120  
 System, 291  
  
 Taking Queens to Australia, 358  
 Tales I Have Read, 466, 472  
 Tanging the Bees, 277  
 Tea for Bees, 174, 238  
 Telling the Bees, 353  
 Tent, Working in a, 476  
 Testing Honey, 9  
 Tetrachloride of Carbon, 509  
 The "Dzierzon" Centenary, 21  
 Therapeutic Value of Honey, 461  
 Time for Manipulating, 228  
 Time for Supering, 269  
 Time taken by Bee to Get a Load  
 of, 312  
 Tips Worth Knowing, 409  
 Tit-bits, 295 397  
 Too Much Honey, 238  
 Total Honey Imports for 1910 510  
 Trade Catalogues Received, 99, 149,  
 160, 189 198, 209  
 Transferring Bees, 68, 88, 258, 326,  
 408  
 Transferring from Skop to Frame-  
 Hive, 267 368, 398  
 Transferring Bees, Time for, 417  
 Transferring in Autumn, 363  
 Treasury Grant to B.B.K.A., 291,  
 337, 342  
 Treatment of Swarms 271  
 Tree, Bees in a Hollow, 453  
 Twin Queens in One Cell, 255  
  
 Uncapped Larva, 198  
 Uncapping Partly-Built Combs, 369  
 United Action 193  
 United Bees and Queenless Colony,  
 150  
 Unting Bees, 119 298, 478; in  
 Autumn, 357  
 Unting Driven Bees, 326  
 Unsealed Sections Completing, 227  
 Unsealed Syrup in Combs, 379  
 Unused Stores, Keeping, 228  
 Use of the Dummy-Board, 205

Using Combs from Dead Stock, 80  
Utah, Bee Disease in, 197  
Utilising Driven Stocks, 416, 508

Value of Bees in Agriculture, 22  
Value of Old Bee Books, 80, 90, 399  
Value of Honey, Therapeutic, 451  
Various Queries, 287, 317, 347, 389, 448, 509  
Vigour in Races, 388  
Vinegar, Honey, 479  
Virgin Queen, Supposed, 173  
Virgin Queens, Introducing, 405  
Visit to Mr. Stapleton's Apiary, 236  
Volume Thirty-nine, 1

Waspish Bees, 453  
Wasp Plague, 325, 344, 385, 450, 487  
Wasp, The Common, 459, 468  
Wasp Traps, 385  
Water and Pollen, 162  
Water for Bees, 317  
Wax-Extractor, The Solar, 244, 314, 346  
Wax-Mite in Sections, 358

Wax-Moth, Preserving Combs from, 149, 348, 461  
Wax-Moth, Quilts and, 218  
Wax Rendering, 8, 313, 429, 458, 488  
Wax Working of Bees, 91  
W.B.C. Hives, Making, 129  
Weak Colony, Strengthening, 229  
Weather-proof Hive-Roofs, Making, 403, 439  
Weather Reports for 1910, 20  
WEATHER REPORTS: December, 1910, 58; January, 60; February, 99; March, 139, 160; April, 169, 198; May, 228, 248; June, 267; August, 359, 369; September, 409; October, 470; November, 500, 510  
Weardale Notes, 215, 234  
"Webb's" Hive Divider, 87  
"Wells'" Hive, Re-queening, 326  
"Wells'" System, The, 27, 34  
Where is the English Bee? 376, 438  
Why I Advocate Bee-Keeping, 503  
Wild Bees, 189, 199, 209, 229, 236  
Wild Bees, Books on, 90, 209  
Wild Bees, Destroying, 209, 236  
Winter, An Abnormal, 102  
Winter Brood-Chamber, 39, 56, 66, 107, 128, 197

Winter Contraction, 66  
Winter Flight of Bees, 23  
Wintering Bees, 76, 389, 398, 408  
Wintering Driven Bees, 438  
Wintering with Super in Position, 468  
Winter, Preparing for, 373, 402, 410, 424  
Winter, Protection of Hives in, 51, 532  
Winter, Prospects of Severe, 459  
Wiring Frames, 24, 234, 277  
Women, Bee-Keeping for, 11, 167, 247  
Worker-Bee, Average Life of, 199, 408  
Worker v. Drone-Cells in Super, 54, 345, 356, 397, 400, 405, 507  
Working for Surplus, 76, 368, 507, 169, 207  
Working for Surplus, 76, 507  
Working in a Tent, 476  
  
Yield, Period of Honey, 359  
Yorkshire and Isle of Wight Disease, 206  
Yorks. B.K. Association, 57  
Young Bees Cast-Out, 219  
Young Larvæ, Feeding the, 7, 25, 68

## LIST OF CONTRIBUTORS.

Abbott, Jas. A., Merchant's Quay, Dublin, 474, 507  
Andersen, J., Stornoway, N.B., 181, 206  
Bee-Mason, J. C., Bures, Suffolk, 116  
Betts, Miss A., Camberley, 484  
Brice, H. W., Orpington, Kent, 85  
Brown, J., Tauneston, 217, 225, 498  
Bullamore, G. W., Albury, Herts, 7, 55, 75, 82, 115, 154, 187, 274, 305  
Crawshaw, L. S., Norton, Malton, Yorks., 16, 48, 67, 87, 107, 138, 177, 196, 218, 237, 257, 277, 307, 337, 356, 378, 397, 418, 437, 465, 467, 487, 508  
Dalziel, J., Dulwich, 65, 85, 95, 394  
Desmond, G. G., Camberwell, S.E., 45, 75, 115, 224, 294, 487  
Ellis, J. M., Ussie Valley, Ross-shire, 56, 105, 125, 185, 205, 223, 263, 282, 304, 344, 362, 405, 436  
Ewell, E., Waseca, Minnesota, 45, 244, 366  
Farmer, W. J., Cornwall, 274, 295  
Franklin, E. W., Mouldsworth, Cheshire, 275, 306  
G. S. N., Godstone, 246, 266  
Grose, R., Bodmin, Cornwall, 479, 511  
Harris, A., Wavenden, Bucks, 56, 194, 345, 385, 405, 507  
Hayes, Geo., Beeston, Notts, 12, 23, 91, 105, 163, 214, 242, 272, 302, 392, 433

Heap, C., Reading, 167, 417, 446  
Herdod, W., Luton, Beds., 144, 162, 205, 222, 241, 253, 271, 292, 313, 333, 353, 373, 402, 424, 442, 462, 494  
Hooper, Cecil H., Wye, Kent, 159, 187, 232  
Hopkins, I., Auckland, New Zealand, 7, 154, 215, 221  
Humble Bee, Allanvale, 35, 176  
Judge, G. W., Dartford, 364, 482  
Kidd, J. W., Stocksfield-on-Tyne, 376  
Linde, R., Germany, 5  
Lockwood, J. E., Hunstanton, 293, 406  
Macdonald, D. M., Morinsh, Banff, 2, 24, 25, 39, 45, 62, 77, 81, 102, 127, 125, 145, 151, 166, 173, 192, 206, 212, 231, 247, 262, 281, 295, 301, 321, 343, 361, 386, 391, 413, 428, 432, 453, 475, 483, 501  
Manley, R. B., Potcote, Towcester, 375, 471  
Martin, H., Natal, 54, 107  
Moir, J. W., Edinburgh, 163, 245  
Muir and Sons, Kirkeowan, 407, 428  
"Nemo," 11, 22, 51, 91, 292, 312, 353, 461  
Neve, E. F., Kashmir, India, 495  
Pearman, J., Penny Long Lane, Derby, 27, 75  
Pinder, J. E., Salisbury, 363  
Pinkney, C. R., Sleights, Yorks., 255, 266, 355

Price, J., Staffs, 396  
Reid, Alex., Balloan, 174  
Roman Bee-Keeper, Anzio, 105  
Salmon, A. W., Finchley, N., 15, 75  
Samways, H., Maesybont, Carmarthens, 84  
Schroder, Alex., Trieste, 244, 275  
S. J., St. Beunos College, 185  
Sladen, F. W. L., Ripple Court Apiary, Dover, 254, 491, 506  
Simmons, S., Heathfield, Sussex, 53, 153, 336, 366, 395, 485  
Smallwood, J., Hendon, 56, 93, 145, 276, 284, 466, 472, 496  
Smith, Rev. Sidney, Yorks., 206  
Stapleton, T., Gwinar, Cornwall, 166, 188, 244, 273  
Stevenson, G. W., Bisley, 66, 426  
Taylor, J. L., Pretoria, S.A., 145, 175  
Tickner, Edwardes, Arundel, 443  
Tinsley, W. H., Staffs, 377, 384  
Thomas, G., Coedmelyn, Pembroke, 445, 454  
Turner, H. H., Swanley College, 215  
Walker, Lieut.-Colonel H. J., Badley Hill Salterton, 94, 356  
Wathelet, Mons. A., Prayon, Belgium, 4, 55  
Woodley, Wm., Beedon, Newbury, 14, 34, 54, 74, 93, 105, 137, 184, 204, 234, 255, 275, 333, 354, 374, 425, 464, 486  
Zehetmayr, W. E., Twickenham, 264, 355

## ILLUSTRATIONS.

Alighting-Board of Diseased Hive, 482  
An Egyptian Apiary, 447  
Bee-Keeping Class at Nicholson School, 184  
Bee-Keeping Class at Shaftesbury School, 427  
Bees in a Box, 497  
Chief Visitors to Fruit Blossoms, 233  
Feeder with Screw Valve, 148  
Feeder, Rapid, 148  
Frame Lifter New, 428  
Fumigating Chamber, 63  
Good Swarm, A., 474  
Hive Entrance Set Back, 194  
Home-Made Observatory Hives, 327, 367  
Humble Bees, 254  
Interior of Diseased Hive, 483  
Manipulating without Veil or Gloves, 182  
Maps Showing Districts Affected with "Isle of Wight" Disease, 122, 123

Modern Apiary in Germany, 5  
Mr. Tickner Edwardes, 203  
Mr. L. Hardwick's Apiary, 512  
Mr. M. J. Stevenson, 504  
Nicholson Observatory Hive, 185  
Old-fashioned Bee-stand in Germany, 4  
Pollen Collecting Apparatus of Social Bees, 492, 493, 494  
Follen Producing Plants, 13, 24, 92, 104, 163, 214, 273, 303, 454  
Pollens of Fruits, 232  
Prize Hive, Mr. Heaseldon's, 489  
Queen and Her Attendants, The, 475  
Solar Wax Extractors, 245  
Steel Brush, 148  
The Late Dr. Dzierzon, 21  
The Late Mr. W. Z. Hutchinson, 73  
The Late Mr. D. A. Jones, 75  
Two-Shilling Hive, A., 44  
Wonderboom Apiary, Pretoria, 175  
HOMES OF THE HONEY-BEE:—  
Apiary of Mr. W. Goodchild,

Holmes Chapel, Burnley, 28  
Mr. F. V. Hadow, Buxted, Sussex, 455  
Mr. C. H. Haynes, Hanley Castle Worc., 465  
Mr. T. Alun Jones, Rhosmore, Halkyn, Flintshire, 17  
Mr. G. Kennedy, Odell, Beds., 157  
Mr. F. C. Kelly, Hawarden, Chester, 435  
Mr. J. E. Meyer, Colehill Lane, Fulham, 324  
Mr. M. J. Stevenson, Adamstown, Co. Wexford, Ireland, 505  
Mr. E. Watts, Partridge Green, Sussex, 97  
Mr. E. Wheatley, Spa Road, Hinckley, 566  
Mr. W. J. Woolley, Junr., Evesham, Worc., 53

PROMINENT BEE-KEEPERS:—  
Mr. F. W. L. Sladen, 41  
Monsieur A. Wathelet, 191

THE  
**British Bee Journal**

No. 1489. Vol. XXXIX. N.S. 1097.] JANUARY 5, 1911.

[Published Weekly.]

VOLUME THIRTY-NINE.

The New Year's heading, which makes its appearance to-day, at the beginning of a new volume will no doubt be seen for the first time by many beginners in bee-keeping who are now readers of the **BRITISH BEE JOURNAL**. It also serves to remind us of the progress made in modern bee-keeping since the B.B.J. first appeared in the year 1873. Although the improvements in methods of management effected in those thirty-eight years far exceed anything previously recorded, it would be foolish not to realise that perfection is still a long way off, and there yet remains much work for the B.B.K.A. and the county associations before the industry can attain that position which it should hold in this country.

With respect to bee-journalism, we cannot avoid a feeling of conscious pride in still possessing the confidence of so many old and valued friends and supporters, together with the constant accession of new ones. Although the period since the coming into existence of the B.B.J. has seen many changes in the bee-industry, it has seen no change whatever in the ruling principles by which the policy of the B.B.J. has been guided under the present editorship. That this policy is both sound and just the present position of the paper amply testifies. Moreover, if still further prosperity could be attained only by the smallest sacrifice of perfect independence of all trade interests, we would prefer to remain as we are. Our advertisers who understand the value of our papers know equally well with ourselves that there is no canvassing for orders, nor do we publish the many testimonials regarding the value of the B.B.J. as an advertising medium. Yet we manage to secure most of what is going in that line simply because advertisers know very well that there are few readers of bee-literature in the kingdom who do not see either the B.B.J. or our monthly, the *Record*.

All the leading British bee-keepers are contributors to our columns, and as the B.B.J. goes into every part of the world we have the contributions of the prominent men of other countries. A leading feature of the B.B.J. is giving the news of what goes on in the bee-world, so that its readers are kept fully informed of all improvements in the practice of bee-keeping, as well as in the progress of the science connected with it. A perusal of

the index of the last volume will give an idea of the extent and variety of our work. The fact that nearly 900 queries on matters connected with bee-keeping were replied to in the B.B.J. will give some idea of the extent to which our advice has been sought. Besides these, replies in urgent and special cases were dealt with either through the post or by telegraph.

While thanking our friends for the help received, we hope that we may be favoured by a continuance of the assistance hitherto given us, so that the B.B.J. may continue to retain the position it has attained as the only weekly bee-paper in the world.

The past season of 1910, although an unsatisfactory one from a honey point of view, has, we trust, been productive of results which cannot fail to have an important bearing on the future of bee-keeping. Our readers have been fully informed of what has been done in the endeavour to bring the British Bee-keepers' Association into closer touch with the county associations, and they know that a meeting took place on May 18 last at which the members and delegates discussed the matter. No definite conclusion was arrived at, but the committee for further considering the question was re-appointed, and was strengthened by the addition of several of the delegates. In the meantime the work of the Association has proceeded with new vigour imparted to it by its new secretary.

The conversaciones of the B.B.K.A. usually attract a large number of bee-keepers, and the two held during the year were no exception. The papers read at the spring meeting were "Honey-dew," by Colonel H. J. O. Walker, and on "Disease and Compensation," by Mr. L. S. Crawshaw. At the autumn meeting the subjects for discussion were on "Keeping Records in the Apiary," by Mr. E. Garcke, and "The Preparation of Bees for Winter," by Mr. J. B. Lamb. The interest and enthusiasm shown at these meetings were clear evidence that the industry was not on the decline.

The principal additions to the literature of bee-keeping during the year have been "Diseases of Bees," by Dr. Malden, a new edition of Roots' "A B C and X Y Z of Bee-Culture," and "The Anatomy of the Bee," by R. E. Snodgrass; also a similar work by Dr. Fleischmann on "The Natural History of the Bee," "Race-breeding by the Swiss Bee-

keepers." by Dr. Kramer; and the pamphlets by Drs. Maassen and Zander treating of foul brood and diseases of adult bees.

Some progress has been made with respect to the knowledge of diseases, although at present no remedy has been found for a disease that has caused considerable loss in this country and in other parts of Europe, as well as in America and Australia; but we hope that the investigations being made both here and on the Continent will result in a better understanding of the cause of the disease, so as to enable bee-keepers to guard against it. The B.B.K.A. has also moved in the matter of obtaining legislation for dealing with bee-diseases. A strong committee to deal with the matter was appointed, and it is hoped that the Association will have sufficient support from bee-keepers to enable the question to be brought before the Board of Agriculture, and so put this country in the same favourable position as most other countries which have obtained legislation.

In the spring of the year the country had to mourn the loss of its Sovereign, King Edward VII., and amongst bee-keepers two county associations have lost their secretaries—namely, the Rev. W. E. Burkitt, secretary of the Wilts B.K.A., who was also one of its founders in 1831, and Mr. R. Godson, the highly-esteemed secretary of the Lincolnshire B.K.A. The death-roll was further increased by the loss of Mr. E. Saunders, F.R.S., author of the great work on "The Hymenoptera Aculeata of the British Isles." Abroad, the most notable losses are those of M. E. Preuss, the first to advocate "claustration," and M. G. Lehzen, the able editor of the *Bienenwirtschaftliche Centralblatt*, who had only retired from the editorship at the beginning of the year.

With regard to our programme for 1911, we hope to continue the biographies of prominent bee-keepers, "The Homes of the Honey-Bee" as hitherto, and also to deal from time to time with some of the more important and essential items of bee-management, on which so much success depends. In this we are pleased to announce that we shall have the assistance of Mr. W. Herrod, who is well known to be a thoroughly practical bee-keeper. The interesting articles on pollen by Mr. G. Hayes will be also continued.

We are frequently asked to make reprints of articles appearing in previous volumes, but there is so much to record of what is going on in the bee-world at the present time that we have little room for reprints. However, we intend to reproduce some of the articles of "Lordswood," which are quite as applicable to the present time as when they were written.

In conclusion, we must express our heartfelt acknowledgments of the good wishes for the New Year that come with so many of our daily batch of letters, not only from bee-keepers in this country, but also from those abroad. Although as a rule we leave out of print all such allusions to ourselves as those contained in the letter of M. Wathelet, the editor of the *Rucher Belge*, on page 4, it is indeed gratifying to receive such kindly remembrances, and they enable us to realise that the labour of love to which we have devoted so many years of our life has not been entirely in vain, but has borne fruit and enabled some to reap the benefit. We hope that when the inexorable hand of Time causes us to drop into the rear, young and ardent spirits now amongst us will be ready to take our place and carry on the work. Our present wish for our readers is that they may have a good and prosperous New Year.

#### AMONG THE BEES.

"CATCH MY PAL!"

By D. M. Macdonald, Banff.

A thought struck me the other day, and I think this first contribution in 1911 to the opening number of our new volume is an appropriate time and place for giving it utterance. Readers will no doubt be familiar with the heading I have adopted, but I flatter myself that the present application of the idea is entirely new. How many bee-keepers have "pals" as yet uncaught? They number tens of thousands in the aggregate as far as associated effort, or rather the want thereof, is concerned. Let me glance at a few of the many ways in which we all could do "catch-my-pal" work in a quiet way.

The British Bee-keepers' Association needs strengthening not only in numbers but in the sinews of war. As the Israelites of old failed to make bricks without straw, so this central body cannot work the impossible. They need active support from county associations, and also from the large body of unassociated bee-keepers. Less than a year ago their own secretary described the B.B.K.A. as in a "moribund" condition, but of late there are signs of a waking up, and the past year should show a new membership larger than that obtained in any other year for a very long period, if not, indeed, for any twelve months since its inauguration. I think this has been produced mainly by the efforts of one man. What I want to secure is that everybody should work in aiding the good cause during the current year. Each member should "catch a pal." How simple the process is, yet how potent might be the resulting force. There would be an im-

mediate doubling of membership. Is it only a dream, or could it not be made a reality? This would give a splendid addition to the free income of the Association, with a commensurate increase of the power to do good to bee-keeping. I have just at random taken up vol. xxxv., and found in its pages the names of sixteen new members recorded—only that and nothing more. Look on that miserable picture and then on this encouragingly bright one. The volume just completed includes lists totalling *one hundred and twenty-three new names!* Honour to whom honour is due! In a special way, while appealing to the whole membership of the B.B.K.A. to join in a "catch-my-pal" movement, I would urge on these 123 neophytes to add a like number in the present year. It is only one single member for each individual; nothing easier. I hereby promise to perform my duty in this respect.

The library has been in a wretched plight, but the "upward and onward" movement has caught on here, too, and I anticipate great things during 1911. Let an appeal be formulated at the first meeting of the Council for contributions. The list of books should be very largely added to, those on hand should be renovated as advised by Colonel Walker, and the secretary's pleading for more cases should be attended to. I will not only give a mite. The smallest contributions will no doubt be thankfully received and acknowledged, but I will endeavour to catch a few pals when liberally inclined. Combined effort, I think, is what is required. Give a long pull, a strong pull, and a pull all together.

While thus advising that we should all do our little best to aid the parent Association, let me urgently appeal to every member of a county or district association to start *now* to work up his neighbourhood and secure one or more new members. The movement could be made a living force in this respect, if it were heartily undertaken and wholeheartedly carried out. Every bee-keeper has a "pal" he can persuade to join. With advantage to all concerned, bee-keepers might take up the question of advising and encouraging *non-bee-keepers* to start in the pursuit. While a sum of from £30,000 to £60,000 is yearly expended on cheap inferior foreign honey there is room for very many more bee-keepers. Almost every corner of the country might contain ten hives, as against one at present, as far as bee-forage is concerned. If you "catch a pal" in this way it will be considerably to his profit mentally, physically, and financially.

I have always found it advisable when dealing with beginners, or even with many who have been engaged in the pur-

suit for a long time, to recommend them to get a good text-book on bee-keeping. It is worth its value many times told, even in the course of a year; while, once purchased, it may last a lifetime. Several good ones are on the market, but undoubtedly the best and most up-to-date is "The British Bee-keeper's Guide Book." By recommending your "pal" to invest in a copy you are doing him a good turn.

A new volume of the *Bee-keepers' Record* opened with January; subscription 2s. 6d., post free, for the twelve months. This is our British monthly, and the price of all similar foreign and Colonial publications is a dollar annually. All, however, who have caught the bee-fever, or who mean to carry on bee-keeping on modern lines, desire a weekly newspaper, and this we have in the B.B.J. On the "catch-my-pal" principle a very large percentage of readers might secure a considerable number of additional readers during the current year. The movement seems to me very opportune at the present time. A new assistant Editor commences work with our esteemed and respected Editor with this issue. The B.B.J. in the past has done an immense amount of good to bee-keeping. Bee-keepers individually and collectively may now do "a power of good" in extending the circulation of the paper. Why not double it? On the "catch-my-pal" system it can be done with scarcely an effort. An increased circulation would benefit the craft as a whole, because then the additional income would encourage the Editors to add to the interest of the two papers. Let us give them a hearty set-off!

I am not asking my fellow readers to do anything I am not prepared to take a hand in myself. I have already helped to secure additional affiliated associations, to start new branches, to obtain new members for the parent Association, as well as for local branches, and I hope to help on the library movement. I mean to start some new bee-keepers, and will obtain more than one new subscriber to the B.B.J. and *Record*. I hope my suggestions will all be enthusiastically responded to, and that very many will help on the movement, and on the "catch-my-pal" principle aid all the interests I have named. The idea possesses immense possibilities, because, of course, once started, every new pal obtained should in honour secure another, and so the movement would go on *ad infinitum!*

---

#### HOW FOUL BROOD HAS BEEN EXTERMINATED IN BELGIUM.

[Belgium, like most other countries, was for a long time troubled with foul brood, and some years ago—we believe about

1896—energetic steps were taken to get rid of the disease. It was decided to destroy by burning every colony having foul brood as the only safe method of ridding the country of this plague by attacking it at the root. For this purpose an insurance society was started for compensating those whose hives were destroyed. We wrote to M. Wathelet, the Editor of the *Rucher Belge*, for some particulars, and are now able to give his reply, which shows the measure of success which has been attained. We also thank him for his kind words, which will be an incentive to persevere in the work before us.—Ed.]

DEAR MR. COWAN,—The president of our foul-brood insurance society has not

making grants of several hundred francs in addition. If foul brood were to reappear the bee-keepers' society would again subscribe to the insurance society, so that the latter could indemnify bee-keepers whose hives were destroyed, just as it had done before.

I take this opportunity to wish you a prosperous and happy New Year. May God preserve you for a long time yet to continue to be the leader of English bee-keepers and the admiration of the bee-keepers of the whole world, who so well appreciate the great value of your scientific work and the immense services which you have rendered to bee-keeping.—A. WATHELET, Prayon, Belgium, December 26.

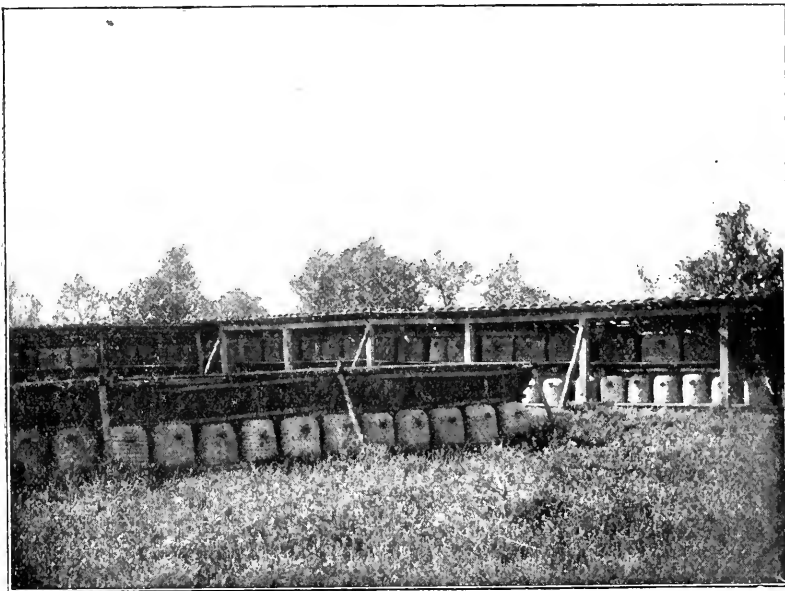

An old-fashioned bee-stand in the Lüneburger Heide of North Germany, a vast heather and moor district into which modern soil-culture cuts from all sides with rapid strides. Still, perhaps a quarter of a million skeps, ranging in weight from 30 lb. to 60 lb. and more in many cases, have been brought home from it this year (1910), meaning many a coin of gold after three failing seasons. The large trunk-like skeps contain movable-frame combs—usually sixteen—held in position by means of pins. There are more than 150 skeps on the stand shown above.—R. L.

been able to furnish me with the statistics for which you ask. The insurance society worked with great success for six years. At the end of this time foul brood was exterminated, so that we no longer have to pay any subscription to this society. It paid for and burned all hives having foul brood in more than twenty districts. All the members of the Société d'Apiculture du Bassin de la Meuse were insured. The bee-keepers' society paid the insurance society 50 centimes per member, which amounted to from 700 to 800 francs a year, the Government and the provinces

## Correspondence.

*The Editor does not hold himself responsible for the opinions expressed by correspondents. No notice will be taken of anonymous communications, and correspondents are requested to write on one side of the paper only and give their real names and addresses, not necessarily for publication, but as a guarantee of good faith. Illustrations should be drawn on separate pieces of paper. We do not undertake to return rejected communications.*

### BEE-NOTES FROM GERMANY.

[8013.] As promised some time ago, I am now sending you some photographs, leaving it to you to decide which is best

suited for reproduction. I thought it would interest you to have also a photo of an apiary so common in this heather district *par excellence*. Perhaps more than a quarter of a million skeps are standing here in the heather every year, although the number is slowly decreasing, as is also the area covered by the purple flowers. The method of the "heather skeppist" is an elaborate result of many centuries of bee-keeping, and implies a certain manual skill in handling great numbers of bees. However, what we, with our modern appliances and hives, call quiet and deft handling has given rise to the tale being told among the people around here that my bees do not sting, though my dog Lux—who is to be

and nicely-built straight combs as far as possible devoid of drone-cells. On account of this constant change of combs, queens, and stocks altogether he is very little troubled with foul brood. One feature of the "Lüneburger" method, on which formerly great stress was laid, consists in putting aside every year a number of casks filled with honey, for use in feeding in the following spring and early summer. To get this bee-food several hundredweights of entirely capped-over pieces of honey-comb are stamped into suitable receptacles. This mass, having undergone a slight fermentation in the meantime, makes a highly-stimulating food for brood-rearing. But I wonder how much honey nowadays, when silver



A modern apiary on English lines in a very old bee-keeping district of North Germany. The blooming heather reaches up to the very entrances of the hives, which are facing east, and are well protected towards north and west. The deliberately slow and careful movements of the dog show that he has learned his bee-lesson, having been compelled many a time to try his luck in swift retreat and taking a unicorn, called forth on his nose by an angry bee, with philosophical calmness "as a thing not to be undone, but disappearing by command of Time."—R. L.

seen in one of the photos—is of quite a different opinion.

The foundation on which the "Lüneburger" method is built up is, as one might guess, a bee in which the swarming trait is systematically developed to an undesirable extreme, judged from the standpoint of modern bee-culture. Having sulphured two-thirds of his stocks in the autumn, the sole object of the skeppist the following spring is to get swarms to enable him at least to triple his stocks again in time for the heather blossoms. He is, however, careful to select for wintering only those stocks which have young queens, sufficient bees and stores,

coins are so greatly valued, finds its way into the bee-food barrels. Sugar is cheap—though in this country of economical Protection we pay more, or at least as much, for inferior beet sugar than you pay for good, wholesome cane sugar (which, indeed, we cannot afford to feed our bees with).

*Protection and Bee-keeping.*—A few years ago, when manufacturers got an export bonus, which the consumer had to pay, we had the pleasure of paying a higher price over here than you paid for German sugar in London. But Protection is dogged by more blessings of which you, perhaps, know very little. What do you



know of artificial honey in your market? Here every shop is stocked with this stuff, that is sold retail at 4d. to 5½d. per pound. Of the quality of foreign honey that is penetrating your market very little reaches Germany, where, however, immense quantities of the much more inferior variety from Chili, &c., are constantly being dumped down. Of what quality this honey is you might guess when I mention that in Hamburg it is offered for about 14s. and upwards per cwt. The import duty of 20s. per cwt. soon imparts a value to this very stuff, that is subjected to some cleaning operations and blended with sugar-syrup to cover its too pronounced flavour before it is put on the market and sold at a price of more than 8d. a pound. How this stuff is converted into *finest extracted bee-honey*, under which flag it is sailing in the market, is, of course, a trade secret. Some years ago a large firm, doing probably the largest business in this very line, took out a patent for a process of throwing out the impurities of foreign honey by means of an extractor. The product of this cleaning operation was labelled—"Extracted honey"! How far the impudence of the foreign honey trade really goes you might judge from the fact that at a recent honey and bee show I bought some *finest extracted bee-honey* at about 1s. a pound. The stuff, if I am not greatly mistaken, is derived from the same source as a sample I tasted more than a year ago in a London shop, and for which I was asked 6d. a pound!

*An English Apiary in Germany.*—Very little need I add to the illustration of my own apiary, as the details are so familiar to you. I am at present publishing a series of articles on advanced bee-culture in a German bee-paper, hoping to propagate in this way your thoughtful and thoroughly worked-out methods of and appliances for bee-keeping. My adaptation of the "W.B.C." hive, a model of which I have had made me by Messrs. Lee and Son in accordance with my wants, takes eleven frames and one division-board. There is a full inch space between brood-box and outer case. As the photo will show you, I have dispensed with splayed legs because of the necessity to migrate with my stocks once a year. The runners, made high enough to serve as stands, enable me to put one story of hives upon another (roofs being taken off) when loading stocks for carting them away. For the same reason I am afraid I shall have to dispense with calico-covered roofs, because this covering does not stand the wear-and-tear the roofs are unavoidably subjected to on the journey. To show how I prepare my hives for the journey I will send you a photograph

later on. Information of that kind might be welcome to some of your readers. I remember that some years ago I looked up, without the desired result, a number of volumes of the B.B.J. in order to find something useful with regard to packing stocks and removing them to the heather.

My section-super is a combination of the "W.B.C." super and the American plain section-super—that is, eight hanging frames without shoulders take plain sections and alternate with hanging fence-separators. A fence-separator is put on each end, and the whole is kept tight by four simple springs similar to those used in the same way in the U.S.A. Outside dimensions of both supers correspond to outside dimensions of brood-box.

*Extracting Heather-honey.*—I am at present testing an interesting machine the inventor placed at my disposal for that purpose. Heather-honey, when derived from common ling, is ordinarily not extractable, however great the speed of the extractor might be and however much the combs are warmed previously. But it is a fact, already known for a long time, that if the contents of a cell filled with pure ling-honey have once been stirred the honey will easily leave the cell after a few rotations in the extractor. By a simple experiment everyone interested in this phenomenon might see for himself the magic result of the action of stirring. Take a comb or a section with ling-honey (in most combs there are always some cells filled with bell-heather honey, which readily leaves the cells in the extractor, and so reveals the nature of its source), stir the contents of a number of cells in the middle of comb by inserting the head of a nail to the bottom of the cells, and then try extracting. The result is really striking. The cylinder of the extractor is soon covered with lumps of heather-honey.

The inventor bases the construction of his machine on this fact. The machine consists of a framework on which a large number of steel needles are kept hanging at such a distance that for every cell there is a needle ready to plunge into it. The weight of each needle is so balanced by its length that it suffices for penetrating the jelly-like honey, and by that action to neutralise the adhesion of the latter. But if a needle meets the wall or bottom of a cell it is lifted, and in that way prevented from damaging the comb. It takes about five minutes' time to treat both sides of a shallow-frame comb with this machine. Very little honey remains in the cells—perhaps hardly more than when dealing with more liquid honey. My own tests cannot give normal results, because of the season being too much ad-



vanced for work of this nature. Nevertheless, it is doubtful whether it would pay to work for extracted honey during the heather-time even now that heather-honey can be extracted. But for extracting the brood-nest, which as a rule the bees choke up with heather-honey, the machine will prove a boon.

*Keeping Records.*—In view of the very interesting paper on this subject by Mr. Garcke, I should like to mention that I applied a combination of Mr. Garcke's card system and the simple notebook by using, with satisfactory results, a notebook with exchangeable leaves. By a simple mechanism any leaf may be taken out and restored or substituted, the leaves being kept in position by wire rings. Numbers on projecting linen ears on one side of the book correspond to the numbering of the stocks, so the records of any colony may easily be turned up by turning the correspondingly numbered ear. However, I should like to try Mr. Garcke's card system next season, and will get a set of his cards.—R. LINDE, Speelthorn, Kr. Celle, Germany.

#### FOUL BROOD LEGISLATION.

[8014.] Having taken the leading part in obtaining foul brood legislation in New Zealand, and being responsible for the framing of the Apiaries Act now in force here, I naturally feel interested in the controversy on bee-disease legislation that has been going on for some time past in your columns. I have before me your issue of September 22 last (just received), which contains a letter from Mr. Herbert Samways ("second-class expert") headed "An Opponent's Views"; and as he has somewhat sarcastically referred to the effect of our Act on some recalcitrant Otaki bee-keepers, and suggests that a New Zealand expert inspector (we detest the name of "bee-expert" in New Zealand) would be happy in wiping out "half of the bee-domiciles of Ireland belonging to the poor Irish cottagers," I have been impelled to reply to some of his illogical arguments.

Now, with regard to the action of certain Otaki bee-keepers who were contravening the Act after it had been in force for two years. It was found to be practically impossible to control disease without making it compulsory to keep bees in movable-frame hives, so that the combs could be readily examined by *the bee-keeper himself* and by the inspector: hence the reason for the compulsory clause. The practical result of this compulsion has been to get rid of most of those who were responsible for the continuous propagation and spreading of foul brood, and though it is but two and a half years since the Act came fully into force, New Zealand bee-keeping stands to-day on an

infinitely better footing than it ever did at any time previously. Large bee-keeping districts that were, before the Act came into force, "rotten" with disease are now clean. In these circumstances we cannot allow any bee-keeper to become a menace, in defiance of the interests of others who are complying with the Act. It would, I am sure, be impossible to find a bee-keeper who has gone over from box-hives to frame-hives who would willingly go back to the former.

New Zealand inspectors or instructors are not the callous, cold-blooded beings Mr. Samways seems to infer, and if what he suggests about their delight in having the opportunity to "wipe out half the bee-domiciles in Ireland" is a reflection of his own feelings as an expert, then I would suggest his coming to New Zealand and taking a lesson in charity from our inspectors.

I really cannot see that Mr. Samways has advanced any valid argument against foul brood legislation in his long letter, and I do not like to imply that he was correct in his estimation of what "some elegant writer" might think of it, but I will suggest that he is behind the times. Your footnote, Mr. Editor, is a fair reply.—I. HOPKINS, Auckland, New Zealand, November 15.

#### FEEDING THE YOUNG LARVÆ.

[8015.] The difficulty raised by the Rev. A. D. Downes-Shaw (8004, page 505) appears to me to be due to two somewhat doubtful postulates—first, that the No. 1 gland system automatically ceases to act at the end of fourteen days; and, second, that there is an interval of several months during the winter in which no brood-rearing takes place. Instead of the worker being compelled to take to foraging owing to the atrophy of the gland system I, there is the possibility that she is crowded out of the nursing industry by the younger bees, and that the gland atrophies from disuse. This disuse would be the natural result of the change of duties.

Snodgrass, in the "Anatomy of the Bee," has recently thrown doubt on Schonfeld's statement with regard to the method of regurgitating the chyle food. This may cause attention to be given to the subject, and the results of fresh work may help us to come to a definite decision as to the origin of larval food and as to the conditions governing the activities of the various gland systems.

If we accept the statement that gland system I. fails fourteen days after the bee is hatched, we find ourselves faced with the following difficulty: When a swarm issues, the youngest bees that join it are several days old. However much we cut down this age, the fact remains that they

have less than fourteen days' nursing ahead of them. When the swarm has established itself in a new location there is a period of twenty-one days before any young bees are hatched. From the failure of the nurses to the hatching of the young bees is a period of seven days, plus the age of the youngest bees at the time of swarming. During this period no larval food can be produced, and in consequence no unsealed larvæ should be present in a hive the third week after the queen of a swarm commences to lay. There are no facts to support this, and if the bees were a fortnight old before the queen commenced to lay there is little doubt that we should find unsealed brood right up to the time that the first eggs were hatched.

That the season of 1911 may necessitate extraordinary activity of the glands concerned in the conversion of nectar into honey is my New Year's wish.—G. W. BULLAMORE, Albury, Herts.

### WAX-RENDERING.

#### QUEEN MATING IN THE HIVE.

[8016.] In answer to Mr. Woodley (page 504, vol. xxxviii.), in my opinion the iron utensils which I use do not materially darken the colour of the wax. The colour, I think, is regulated primarily by the age of the combs. I always find my product equal to any I have ever seen in commerce, and have never realised less than 1s. 6d. per pound. I got 1s. 8d. for it this year (1910). I frequently sell it to manufacturers of comb-foundation, and have never had a complaint regarding it.

"A Fact Worth Mentioning."—Early in the spring of 1909, when inspecting my hives, I found my weakest stock (a mere handful of bees) minus a queen. Before her demise, however, a wise provision had been made to propagate the species. The combs contained patches of capped worker and drone brood, also three capped queen-cells almost ready to hatch. A month or so afterwards I again inspected the hive to ascertain its condition. To my pleasurable surprise, I found eggs and worker-grubs, the issue of a young fertile queen. Now, as the weather during the interval—without intermission—was stormy, wet, and cold, not a bee dared venture beyond the threshold of the hive, absolutely convincing me that fertilisation *must* have been engendered inside the hive. It is also remarkable that such a coincidence should take place so early in the season, no drone-brood being raised in any of my stronger stocks for two or three months later on. I know the above facts will be disputed; nevertheless, they are authentic. Have any of your numerous clientele ever had similar experiences? The compliments of the season to you and all bee-keepers.—SCOT.

### WORKING OF THE BEE-DISEASES PREVENTION (IRELAND) ACT.

[8017.] Your correspondent writing under the *nom-de-plume* of "Buzz Bee" (7998, page 497), in referring to the above, says: "In my experience, fresh cases of foul brood usually show themselves towards the end of May, not before, and *practically all signs of foul brood might have disappeared by September 15.*" As a supporter of Mr. Woodley's attitude, "Buzz Bee's" reasoning appears to me to be weak, and I should like to know on what authority he makes the statement I quote. If all signs of foul brood might disappear by September, what need for inspectors? But foul brood that disappears by magic is certainly different from any that has come under my notice. May I add that I am a firm believer in "Izal" as a cure? and I think that cases which have been reported of the disease again breaking out after an apparent cure are accounted for by the presence of spores in sealed stores, which are not killed by the "Izal," and cause a fresh outbreak when used. The moral is obvious. Unfortunately, it is not the lazy man's cure. Wishing all bee-keepers a better season this year.—R. B. DARR, West Horsham.

### FOUL BROOD AND DISINFECTION.

[8018.] I was rather surprised to read "D. M. M.'s" criticism of a New Zealand writer in the *Canadian Bee Journal* on the disinfection of hives. I read the article referred to in the October *C.B.J.*, and thought it a fairly able and good-natured contribution to a controversy where some of the disputants have been more than ordinarily unscrupulous in their allegation of facts. This New Zealander claims to speak as one who has closely followed the work of the apiary inspectors in New Zealand, and he says the results achieved are *not* due to the disinfection of hives, as this is almost unheard of there. He quotes from Mr. Hopkins's bulletin No. 18: "We have in the MacEvoy treatment, when properly carried out, an effective cure." To this "D. M. M." adds: "That includes disinfection." Does it? Not that I have ever noticed. However, I thought it worth while to look into, and nowhere can I find the MacEvoy treatment as including disinfection. For instance, in "Advanced Bee-Culture," Editor Hutchinson says: "Some advise boiling the hives or burning them out on inside by painting them over with kerosene and setting it on fire, but I have seen so many hives used without taking any such precautions that I have come to doubt their necessity. Mr. MacEvoy, Inspector of Apiaries for Ontario, says that he has cured thousands of cases of foul brood

without any such disinfecting, and considers it wholly unnecessary." Again, in the "A B C and X Y Z of Bee-Culture," Messrs. Root, after describing the MacEvoy treatment in Mr. MacEvoy's own language, say: "Mr. MacEvoy has probably had a wider experience with foul brood than any other man now living, and it is his opinion that it is worse than useless to use any form of drug, and it is also a waste of time to disinfect hives; and the fact that he has treated successfully thousands of colonies, without doing anything with the hives at all, would seem to indicate that disinfection is unnecessary." Speaking from memory, I am quite sure that Dr. Howard's brochure on "Foul Brood," which is an endorsement of the MacEvoy treatment, does not mention disinfection as being necessary. In *Gleanings* of October 1 there is an article by Mr. I. Hopkins, the gentleman who drafted the Apiaries Act of New Zealand, and in the course of his article he gives a "copy of the Digest of the Apiaries Act." Neither in his article nor in the Digest is there one word as to the need for disinfection. If disinfection was an essential part of the treatment in eradicating foul brood in New Zealand, would it not be mentioned in this Digest? I consider the article in the *Canadian Bee Journal* a useful contribution to this question of whether disinfection is requisite or not.—R. WHYTE, Rutherglen.

["D. M. M." is quite correct in stating that the MacEvoy treatment as advocated in New Zealand includes disinfection, and if our correspondent will refer to the Government Bulletin No. 18, issued by the New Zealand Department of Agriculture, he will see on page 53 the passage quoted by "D. M. M." which clearly shows that disinfection is recommended as part of the cure. Mr. Hutchinson is not certain, but only doubts the necessity; but it is no reason, because colonies have been cured without disinfection, that it is not desirable. Our correspondent quotes from an old edition of Roots' "A B C," but even in that, if he will read on, he will find Messrs. Root recommend disinfection, because from experience they had found the disease to reappear in several colonies when disinfection was not carried out, and they further say: "While Mr. MacEvoy may be right, it would seem advisable, in the case of a disease so serious as either black or foul brood, to disinfect the hive." However, referring to the 1908 and subsequent editions of the book, Messrs. Root omit the passage quoted by our correspondent and have substituted for it one in which disinfection is unhesitatingly recommended. They say: "Mr. MacEvoy does not recommend treating the hive; but reports have been received

by the publishers showing that the disease has returned in some instances when the hive had not been disinfected. It is advised, therefore, that one and all disinfect the hives as well as the combs." Dr. Howard's brochure was published in 1894, but since then much new light has been thrown on the subject, and it has been proved that the spores of foul brood can lurk in hives, so that the disease will break out again. We have the evidence of Doctors Maassen, Burri, and Zander, who all insist on disinfection. Probably more headway would have been made in America had disinfection been more systematically carried out. The article in *Gleanings* to which Mr. Whyte alludes refers to the importance of doing away with fixed-comb box-hives, and does not treat of disinfection at all, which, however, is fully dealt with in the Government bulletin already mentioned. Whatever may be the opinion of the New Zealand writer of the article in the *Canadian Bee Journal*, those who know the vitality and contagiousness of foul brood germs are pretty well agreed as to the advisability of disinfection.—E.]

## Queries and Replies.

[4068.] *Ascertaining the Quality of Honey.*—Can the quality of honey be satisfactorily ascertained and graded by "mechanical or physical" tests without resort to the personal opinion of the "expert" honey-taster? Are the following testing appliances of practical value, and, if so, to what extent, for this purpose:—Chemical reagents, the saccharimeter, the polariscope, specific gravity tests?—H. R., Cheadle Hulme.

REPLY.—While testing appliances are of real practical use for determining the analysis of honey and detecting adulteration, there is no "mechanical or physical" test of any value in ascertaining the aroma and flavour upon which the quality of the honey so much depends, and this must be left to the personal opinion of the expert honey-taster. Chemical methods are used for determining the moisture in honeys, the amount of reducing sugars such as dextrose and invert sugar, and the quantity of sucrose, ash, dextrine, wax particles, and free acid. The saccharimeter is really a polarising instrument for measuring the rotatory quality of various substances. The Soleil-Dubocq saccharimeter is the one mostly used for honey, and the degrees of deviation of the polarised ray to the right or left are indicated on a scale. Schmidt and Hänsch's shadow saccharimeter is also used for direct polarisation and for the calculation of the levulose. Specific gravity tests are

not of much value, as the specific gravity of the different kinds of honey varies considerably. Sometimes bees gather liquid which is little more than sweetened water. At other times the nectar stored in the cells is so dense that it solidifies before the bees have time to seal it, as in the case of ivy and heather honey. Good clover-honey, extracted after being sealed, has a specific gravity of 1.370, which may be taken as the average specific gravity of British honey. The microscope is also useful in determining the principal source of honey by showing what pollen grains it contains, and in this way foreign honey may frequently be distinguished from British.

[4069.] *Sending Bees by Rail.*—I have been a reader of the B.B.J. for over ten years, and have gained a great deal of useful knowledge from it, but there is one point I have never seen mentioned, which may have caused trouble to others besides myself. Last season I sent for a lot of driven bees to an advertiser in Gloucester, and they arrived on August 12 dead. I refused to receive them, and at once wrote to the sender, who referred me to the railway company for compensation for the loss. I received on November 9 a reply in answer to my claim to the effect that live bees are carried by the railway companies solely at owner's risk. The bees were sent in a very good travelling-box, with plenty of ventilation allowed in it, and a printed label on the box said: "By Passenger Train. Immediate. At Railway Company's Risk. *Live Bees. With Care.*" I should like to know, was the company entitled to refuse liability in this case?—BOWDON, Cheshire.

REPLY.—Although railway companies carry bees at owner's risk only, they are liable for loss caused by the negligence of their employees. As you state the bees were properly packed, with ample ventilation, it was clearly their fault, either through delay in delivery or by placing some article on the top of the box, which caused suffocation. Your claim would have held good in a county court, and had you persisted there is no doubt the company would have paid rather than appear in court. You have evidently been "bluffed" out of your money—a common practice of railway companies. In exactly the same circumstances we have several times recovered value of bees from the carrying company.

[4070.] *Removing Sour Honey from Combs.*—I purchased a quantity of drawn-out shallow frames about three months ago, but have not until recently had an opportunity of unpacking them. On examining them I find that the combs are comparatively new and clean, but many

of them contain what I presume to be sour liquid honey. Can you advise me how to treat them so that I may use them next season?—BEGINNER, Leeds.

REPLY.—Soak the combs in warm water, then put them through the extractor to remove the water, and place in a warm room to dry. To facilitate this, space the combs wide apart.

---

## Notices to Correspondents.

---

*Letters or queries asking for addresses of manufacturers or correspondents, or where appliances can be purchased, or replies giving such information, can only be inserted as advertisements. The space devoted to letters, queries, and replies is meant for the general good of bee-keepers, and not for advertisements. We wish our correspondents to bear in mind that, as it is necessary for us to go to press in advance of the date of issue, queries cannot always be replied to in the issue immediately following the receipt of their communications.*

---

A. W. S. (Thanet).—*Feeding; Entrance in Winter.*—1. Both the super and excluder should be removed when feeding. 2. If you mean the feed-hole, a cake of candy should be placed over it; but if the entrance to the hive is meant, then on no account close it up, or the bees will die. Leave it open about 6 in.

CLOVER BANK (DEVON).—*Various Queries.*—1. The wall will be no obstacle to the returning bees. 2. The last week in April. 3. This is the result of the bees giving more attention to the smaller number of larvae. 4. A little of the honey should be left uncapped as a stand-by should weather become adverse. 5. We should say not.

W. J. W. (Devon).—*Extracting Honey from Infected Combs.*—1. As the extractor is of tin, it is quite easy to disinfect it after use. A strong disinfectant should be used. All other methods of securing the honey will be troublesome and unpleasant, as well as being far more risky so far as regards spreading the disease. 2. We have kept candy for two years, and it has been quite fit for use. A cellar not too warm is the best place in which to store it. 3. We should not advise you to save the combs; it is running a dangerous risk. You had best melt them down for wax, and commence with new frames and full sheets of foundation.

NOVICE (Hawick).—*Clipping Queens to Prevent Loss of Swarms.*—1. We do not advise the clipping of queens, but if you must do it, remove with a pair of very sharp scissors about one-eighth of an inch from one wing. 2. The use of a "Briec" swarm-catcher for a short period would be better; also, you should pay attention to ventilation and give room in advance of requirements.

## Editorial, Notices, &c.

### REVIEW.

*Studien über die Honigbiene (Apis mellifica).* By Professor Dr. Enoch Zander. Part III.: *Die Verbindung zwischen Vorder- und Mitteldarm der Biene.* By Dr. Chr. Metzger (published by W. Engelmann, Leipzig).—This is a reprint from *Zeitschrift für wissenschaftliche Zoologie*, and deals with that part of the anatomy of the bee relating to the connection between the honey-sac and the chyle-stomach, which is called the "stomach-mouth." Dr. Metzger gives a very minute and accurate description of this organ, traces its gradual development, and gives its physiological use in the adult bee. He considers Schönfeld's theory that brood-food is prepared in the chyle-stomach wrong, and the studies undertaken in Erlangen on the subject tend to elucidate the fact that the "stomach-mouth" has nothing to do with brood-food, but acts as a valve for regulating the flow of food from the honey-sac to the chyle-stomach and preventing digested food from returning into the honey-sac. The author also considers Schönfeld wrong in his supposition as to the origin of brood-food, and believes, as Schiemenz stated in 1883, that it is a glandular secretion and not digested chyle. The photos of the dissections are very fine, and demonstrate what very painstaking work has been accomplished. It shows the value of the research work that is being carried on at the Erlangen Institute in reference to some of the unsettled problems in connection with the anatomy of the bee. We have the microscopical work of Dr. Fleischmann and Dr. Zander, who assisted in the investigations, which were the commencement of the systematic research work which is now being followed up at this establishment in order to settle some of these undecided physiological points. The present studies on the honey-bee are the most complete and perfect of any that have yet been produced, and are a valuable addition to our knowledge of the anatomy of the bee.

### REVIEWS OF FOREIGN BEE-JOURNALS.

By "Nemo."

*Queen-introduction.*—A novel method of introducing queens is given in *L'Union Apicole*. Towards evening place the queen to be introduced in a metal queen-cage, and put this in your trouser pocket, where it should be kept for about half an hour. Then burn under the colony to be operated upon a piece of

touch-paper 2 in. to 3 in. square, and close the entrance and all openings for a few minutes. Then open one side of the hive and let the queen run in on to the combs. Open the entrance, allow the fumes of the saltpetre to escape, and close up again, and the introduction is completed. This method does for introducing queens under all conditions, but is especially recommended for queenless colonies, or when dealing with valuable queens, and when expedition is desired. It is indispensable with certain colonies which refuse to accept the queens which one attempts to introduce in other ways. Touch-paper is made by brushing over with a solution of saltpetre ordinary paper such as that used by store-keepers. When well saturated, dry ready for use.

*Bee-keeping for Women.*—M. Gubler makes a strong appeal to women to take up bee-keeping, and points out its advantages in the *Bulletin de la Suisse Romande*. He says that women have to seek some occupation, and although factories, the post office, and the telegraph and telephone services employ a great number, all cannot get employment. Besides, all these have the drawback that they separate the woman from her family, the midst of which should be her element, and the necessarily deserted children are to be pitied. For a number of women, and more especially mothers of families, bee-keeping is an ideal occupation, which does not oblige them to leave their home, and with which they can earn a livelihood or make a substantial addition to their husbands' earnings. M. Gubler asks why there is so little interest in this branch of agriculture. Without doubt bee-keeping is quite suited for women. It requires accuracy, cleanliness, perseverance, and devotion, and who is better qualified in these requirements than women? Ask the visiting expert where he has found the greatest order, the hives best cared for! To melt wax, make comb-foundation, clean the appliances, extract and ripen the honey, fill and label the jars, feed the bees, care for a nucleus, and all other work in the apiary are well suited for women. One may object that they are more sensitive to pain and fear stings. M. Gubler says this is an error, for everyone knows that women can endure suffering much better than the so-called stronger sex. Besides, there is always a veil, gloves, and smoker with which she can arm herself if necessary. He further recommends bee-keepers to teach their wives and daughters bee-keeping, as it would be to their mutual interest. Should the bee-keeper die, his widow would not only be able to manage the bees, but could earn a livelihood with them. It frequently happens that when the bee-keeper dies there is no one who under-

stands anything about bees, and they are consequently sold at a great sacrifice or allowed to perish, instead of being a source of income.

*Granulated Honey.*—M. Fenouillet alludes to this in the *Rucher Belge*, and says that granulated or congealed honey generally leaves a somewhat sharp after-taste, which causes a certain stricture of the throat. It has also sometimes the unpleasant tendency of setting the teeth on edge. These two results, due to minute quantities of acetic and formic acids which it contains, turn a good many against granulated honey and prevent them from eating it. He does not hesitate to say that this is the principal cause why honey is not more generally used in France, as it is the custom in that country to sell honey in a granulated state. He then recommends that it should be liquefied, on the plan usually adopted in this country. When this is done honey loses its sharpness and acidity and resembles fresh honey; but he warns bee-keepers not to heat the honey in an ordinary vessel without surrounding it with water, otherwise it will lose its aroma and will not be any better than syrup.

*The Massacre of the Drones.*—M. Odant, referring to this subject in *L'Abeille de l'Aisne*, says that when the massacre of the drones is taking place so intent are the bees on this that one can not only stand near the hive, but assist in the destruction by crushing the drones on the alighting-board with one's finger without the bees resenting the interference in any way. He quotes M. de Layens, who said: "The end of the honey season is indicated by the following signs: 1. The activity of the bees at the entrance to the hive diminishes, even during fine weather. 2. The drones are driven out by the bees, who chase and kill them." The Abbé Sagot is even more explicit, for he says: "Drones appear only in May, June, and July, according to the temperature. This is the swarming period, and consequently the time for fecundating the young queens. Soon honey becomes as scarce as the flowers, and the bees will commence the destruction of the drones. Four to six will ruthlessly pull at one, and drive them out of the hive. And a fact worthy of notice is that the bee-keeper can not only approach the hive with impunity, but with his finger take part in the massacre. The bees are in no way annoyed, and instead of being irritated appear to be pleased with the assistance given them." M. Odant says he has at times killed two to three hundred in this way on the alighting-board without getting stung. On the contrary, bees sometimes would come and lick his fingers, which were moistened with the juices from the crushed drones.

## HONEY IMPORTS.

The value of honey imported into the United Kingdom during the month of December, 1910, was £2,373.—From a return furnished to the BRITISH BEE JOURNAL by the Statistical Office, H.M. Customs.

## NECTAR-PRODUCING PLANTS AND THEIR POLLEN.

By Geo. Hayes, Beeston, Notts.

(Continued from page 485, vol. xxviii.)

No. 2.—BORAGE (*Borago officinalis*).

NAT. ORD., *Boraginaceae*.

When advice is sought as to what flowers should be grown in gardens for the bees, borage is usually amongst those recommended, and this is why it is a fairly well known flower. Although it is extensively cultivated, it must be borne in mind that it is also one of our *wild* flowers, being frequently met with on waste ground and rubbish-heaps.

In the Middle Ages borage was held in high repute, and was largely grown in the herb garden. When once established, experience teaches us that it is a very difficult plant to eradicate. In my own garden while I am writing (October 24) there are plants in bloom from seeds shed from those which flowered early in the season, and these supplied the pollen from which these drawings were made, and which were also photographed. Some of the pollen was preserved in honey and other media for further observation.

Under cultivation in the garden it is a very strong-growing plant, and will often attain a height of 2 ft. and a diameter of 18 in. The leaves are obovate or oblong in form, and in texture very rough and hairy. It flowers all the summer, but mostly during June and July. When in full bloom it is a very attractive plant. The star-like flowers on long pedicels, drooping and of a clear blue, with dark anthers very prominent in the centre, make it most conspicuous in the midst of its sombre foliage.

The corolla is composed of five sharply-pointed petals, and when fully expanded is quite flat. All the parts are in one plane, as in the pimpernel and some few other flowers.

The stamens are very dark purple, and form a prominent mass in the centre of the flower. There is a curious ring of slightly projecting scales at their base. The calyx, like all the rest of the plant except the corolla, is thickly clothed with hairs, and is deeply cut into five long, narrow segments.

The flowers grow in loose, forked cymes, with drooping buds, the expanded blossoms rising perpendicular to the ground,

whereas in most plants they are parallel to it. A comparison between the ways in which a pansy and a daisy flower grow will, I think, explain what is meant.

According to some, the generic name is derived from the Latin words *cor* (the heart) and *ago* (I bring), and thence corrupted into borago, there being a belief that it imparted courage to those who partook of it. There is an old adage, "I Borage, give courage," which is an indication of the faith placed in its virtues. The plant in Italy is called *borragine*, in France *bourrache*, and according to Diez it is derived from the Latin *borra*, *burra*, signifying "rough hair, short wool," in reference to the roughness of the foliage.

As a nectar-producing plant borage stands in the front rank, and although it is lovely either in the wild state or when cultivated, it is never sufficiently plentiful to give any appreciable surplus. When grown near hives it certainly finds useful employment for bees in dull weather when they cannot get farther afield, and for this reason it is worth the trouble for bee-keepers to grow it, especially if there is a piece of spare ground.

The colour of the pollen when freshly gathered (dry) is a very light bluish-grey, but when taken from honey and viewed by transmitted light it is a very pale yellow. The flower yields it abundantly, and often when a bee settles on the blossom and weighs it over the pollen is simply poured out from the cone which the anthers form in the centre of the flower.

Each normal grain measures  $\frac{11}{10000}$  in. by  $\frac{3}{10000}$  in. at each end, and about  $\frac{1}{10000}$  in. in the narrowest part of the constriction, for it will be seen (Fig. 4) at 1 A and D that it is of the shape of a dumb-bell, and in the constriction between each rounded end it is fluted. A section of this part is shown at E. At B the pollen-grain is shown end up, and at C obliquely. When placed in water it immediately assumes a spherical form with irregular processes, as seen at

2, and the same may be found amongst those taken from honey, as at 3 c; but the more constant forms are those figured at 3 A and B. The latter forms are assumed when the grains are kept in dilute formalin.

(To be continued.)

ENGLAND STILL IN FRONT.

In view of the frequent grumbles which we are accustomed to hear with regard to the sale of honey in this country, and the contention that we are far behind other countries in pushing bee-keeping as a business, the following extract from the November issue of the *Canadian Bee Journal* is rather refreshing. After quoting the Grocers' Exhibition taken from our pages, the editor goes on to say:—

"Bee-keepers in the Old Country have been experiencing a succession of bad or indifferent seasons. Last year honeydew spoiled the crop. This year unfavourable weather brought disappointment and loss to our brothers across the water. Yet, in spite of adverse circumstances, our contemporary is able to report the London Honey Show a big success. Let us emphasise the fact. We read, for instance, that in the classes for light- and medium-coloured honey there were sixty exhibits. Only those who have visited the various London honey shows

can realise the effect produced by these imposing displays of honey. Sixty entries! Think of it. In the class for displays of honey and honey products (to be shown in suitably attractive form for tradesmen's windows) there were six trophies. That which gained the first prize was of an educational nature, exhibiting the variety of uses to which honey can be put in medicines as well as in articles of every-day consumption. The entries in the beeswax classes numbered thirty-two. We can imagine a certain well-known Canadian with that jack-knife of his doing a bit of

1 Dry.



2 In Water



3 In Honey

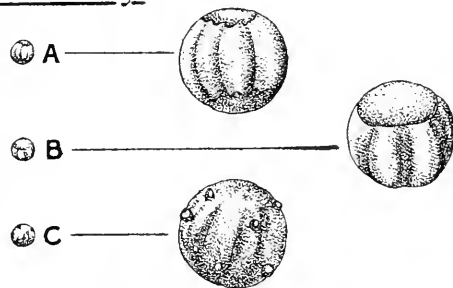

FIG. 4. POLLEN OF BORAGE.

scraping among the businesslike-looking cakes so familiar at these shows. There were some sixteen classes, all well filled, and furnishing a display that would simply amaze the bee-keeping visitor at the Canadian shows.

"We visited recently the two Ontario Honey Shows, the most important in the whole Dominion—viz., that held at the Canadian National Exhibition in September last, and the Honey Show at the recent Horticultural Exhibition. We are forced to the conclusion that we are a long way behind the Old Country in these matters.

"Now, what is the chief object of these shows? Simply to advertise. Yet how blind to our interests, how lacking in business instincts do we appear to be in failing to assist in making them a success. We are not at all certain as to who is really to blame. A correspondent in our last issue complained, with justice, of the unsuitable building allotted to the honey exhibitions. Is it that as bee-keepers we are too modest, and do not assert our claims with sufficient vehemence? The executive of the Ontario Bee-keepers' Association might do something here.

"We should like to see competitors encouraged to exhibit their honey and wax in forms attractive to the business man rather than to the child. Any receptacle, so long as it be glass, seems to be considered suitable for displaying the honey in, and the variety is as endless as that one meets with at the perfumer's or druggist's. Again, in the case of wax, instead of the innumerable animals and other forms into which the wax has been shaped, we should prefer a more sober, not necessarily less attractive, mode of exhibiting.

"One other matter seems to us to require attention. It is a very difficult thing indeed for the visitor to distinguish the various classes and the different exhibits in each class. Bee-keepers go to no little expense in sending their honey and wax to these shows, and we consider that they are entitled to better treatment by those responsible for the arrangement of the tables.

"When Canadian bee-keepers are fully alive to the importance of advertising they will, we imagine, evince a desire for more shows, better displays, and practical demonstrations at every opportunity."

#### BEEES AS TRESPASSERS.

A curious case comes from the Waikato district, New Zealand, where an apiarist has been threatened with prosecution by a farmer on the grounds that bees belonging to the former trespassed on his land and worried his cattle at their drinking place. The Waikato Farmers' Association have taken up the question with a view of adjusting the difficulty.

## Correspondence.

*The Editor does not hold himself responsible for the opinions expressed by correspondents. No notice will be taken of anonymous communications, and correspondents are requested to write on one side of the paper only and give their real names and addresses, not necessarily for publication, but as a guarantee of good faith. Illustrations should be drawn on separate pieces of paper. We do not undertake to return rejected communications.*

#### NOTES BY THE WAY.

[8019.] In the opening days of the New Year our thoughts naturally turn to the future, and we hope that it will bring us success in our undertakings; but to achieve success we must do more than hope—we must put our shoulder to the wheel. The past honey season was a bad one for bee-keepers in this part of the kingdom. We have escaped so far, I believe, that insidious foe called the "Isle of Wight disease" (though it is very near to the borders of East Berks), which is much to be thankful for; and we hear also very little of foul brood in this part, though a few years ago there were cases of it in the town of Newbury. Our greatest bee-foe this winter and coming spring will be *starvation*, and, depend upon it, a large percentage of stocks will be lost through neglect in feeding. I give my method of candy-making in reply to an inquiry for same by a bee-keeper: 5 lb. of sugar to 1 pint of water; add  $\frac{1}{2}$  teaspoonful of cream of tartar. I make up 20 lb. at a boiling, and use 10 lb. of loaf sugar and 10 lb. of pure Demerara sugar, 2 quarts of water, and 2 heaped-up teaspoonfuls of cream of tartar. This is put into a saucepan over a bright fire, and kept stirred till all is melted. When it boils I stand it for twenty minutes over an oil-stove, and this just keeps it boiling (with no danger of its boiling over). During the boiling prepare ten or twelve tin baking-dishes by lining each with a piece of white paper ready for the candy. Then take a good-sized bath or large pan, and fill this with cold water to come up to the level of the boiling syrup in the saucepan. When boiled sufficiently, stand the saucepan of boiling syrup in the cold water for a few minutes before stirring to cool. Now commence stirring with a wooden spoon or stick, and continue to do so until the syrup becomes creamy in colour and the consistency of porridge; then pour it out into the dishes, and when cold place over each cake a piece of paper with a hole in the centre to correspond with the feed-hole in quilt. This quantity of sugar and water makes 24 lb. of good soft candy.

*Sending Bees by Rail.*—With reference



to "Bowdon's" query (page 10). I think I must have given my method of packing and dispatching bees, less than ten years ago. Time flies quickly, I know, and it may be longer. I have sent bees to nearly every part of Scotland, and most parts of England and Ireland, during the last thirty years, and have had very few lots smothered. If swarms are sent off on the same day that they issue, while a honey-glut is on, and the temperature is round about 80 deg., there is a chance of getting them smothered even in a large box well ventilated. The excitement of being imprisoned, and the shaking and jarring of travelling on a hot day, with the temperature of the interior of the railway vans over 100 deg., cause the bees to vomit the new honey from their over-charged honey-sacs, and consequently they literally "stew in their own juice." Newly-driven bees are in the same condition as a new swarm: they are full of honey, and possibly, although in "Bowdon's" case the box was large and ventilated, there were no ledges on the bottom of the box and no air-holes in the bottom covered with perforated zinc between the cross-pieces. When these are used it ensures upward ventilation through the box containing the bees. I always provide bottom and end holes, and tie strainer-cloth over the top of swarm-boxes, and nail two or three pieces of lath to make handles for the railway porters; these also prevent the corners of other parcels sticking through the cloth. I label my boxes: "Living Bees. Require Air, but Not Draught," &c.—W. WOODLEY, Beedon, Newbury.

#### FERTILISATION OF QUEENS.

[8020.] The possibility of queens being fertilised in the hive has so often been discussed that many bee-keepers are, no doubt, still hopeful of proving that such can take place, and a few still think they have changed the hypotheses of early philosophers into actual facts. Such experienced men as Mr. Cowan and his colleagues of various nationalities, who have devoted a lifetime to research in a scientific and practical way, have undoubtedly proved conclusively that fecundation cannot take place except on the wing. In "Scot's" case (page 8) it would seem proof positive to him that mating was accomplished in the hive. It would be interesting to know the conditions existing previous to the hive being found queenless (?), why it was apparently so, how he nursed the bees, and the period over which the various changes extended, dates being given if possible.

I have seen bees in a similar condition reported queenless, and it was found that a queen not much larger than a worker-

bee, which had been mated late in the previous season, was amongst the cluster. In another instance the drone-brood found early in the season was chilled brood, which had been left over the winter in a sealed condition, and at first sight appeared an exceptionally early attempt to prepare for queen-mating. One also sees at times queen-cells of the previous season containing dead larvæ, and sometimes a matured queen which was ready to hatch out, but not able to do so.

One of these cases may be a parallel to "Scot's" rather unique experience. At the end of last October I saw a hive with drone- and worker-brood, and on examining the queen found that she was unable to oviposit properly owing to an injury to the spermatheca. The queen was young and active, but the abdomen was contracted on one side. With good wishes to "Scot" and all bee-keepers for 1911.—A. W. SALMON, St. Kilda, North Finchley.

#### WORKING OF THE BEE-DISEASES PREVENTION (IRELAND) ACT.

[8021.] Mr. Dart (8017, page 8) asks for my "authority" for the statement that practically all signs of foul brood might have disappeared by September 15; yet later on he speaks of the disease "breaking out after an apparent cure, owing to the presence of spores in sealed stores." Does not this statement of his answer the question he puts? Is it not the case that on September 15 there is "practically" no brood in the hive, and mostly sealed stores? There is no magic here, but only the normal course of Nature, which causes queens to cease egg-laying for a season. When there is no brood in a hive, it is evident foul brood cannot show itself; but, according to Mr. Dart, it might break out next May when these sealed stores are used in brood-rearing. I do not say that bees store honey or pollen on top of dried foul-brood spores, for I am inclined to think they do not; nor will I say that bees clean out dried-up foul-brood spores from their cells, for I am inclined to think the contrary. But I should like Mr. Dart to try the following experiment, if he has never done so, and note the result: Let him take a hive in July affected with foul brood, showing a fair sprinkling of yellow larvæ—I mean a stock that ought to be treated, but as yet not rotten with disease—kill the queen, and allow the bees to rear another for themselves. He will find that before that young queen starts laying in three weeks or a month, *practically* every cell will be cleaned out, and all signs of disease will have disappeared. There *may* only remain two or three cells with the dried scale containing the spores, or, possibly, there *may* remain

none. I am not recommending this as a cure for foul brood, as I do not think it thorough enough, but I am stating observed facts. When egg-laying ceases bees turn out the affected larvæ. They may do it all the time, but when egg-laying is continuous they cannot overtake the disease, and so rotting larvæ increase in the hive.

I repeat, therefore, that after September 15, with a rapidly diminishing brood-nest, or, it may be, with none at all, an expert has not a fair chance of deciding whether a stock of bees is affected with foul brood. Unless all the bees were shaken off their combs (which is scarcely advisable so late in the season) two or three cells of dried scales might easily be overlooked, and even if seen he would scarcely be justified in condemning a stock on the evidence of these cells only, without the presence of active bacilli shown in yellow larvæ, or the well-known coffee-coloured strings, to corroborate his diagnosis. Lastly, although I respect "Izal" as a useful disinfectant more convenient for use than carbolic acid, and as a prophylactic possibly as useful as phenyle, yet I am *not*, as Mr. Dart claims to be, "a firm believer in it as a 'cure'" if that means that it can kill spores without killing bees and brood, and I know that "authorities" are with me here. How can anything be called a "cure" for foul brood which requires first the removal of all combs containing spores? Colonies affected with foul brood may be easily cured, but I think it cannot be too widely known that "Izal" is powerless to effect a cure so long as spores exist in the combs. Further, where a healthy colony is attacked by virulent foul brood, treatment with "Izal" alone will not prevent the disease going on to the spore stage and the combs becoming spoilt.—BUZZ BEE, Royston.

---

### CAPPINGS OF COMB.

BY L. S. CRAWSHAW, NORTON, MALTON, YORKS.

*Bee-keeping Examinations* (page 465, vol. 38).—It is difficult to allow one of Mr. Reader's remarks to pass unnoticed. This is to the effect that "the certified, though possibly quite inexperienced, driver," &c. The implication is such a hopeless misrepresentation of present facts, and an unwarranted slur upon both the examiner and the expert who has gained his certificate, partially at least by a knowledge of driving, that I need merely pin it down for reference by the writer of it and such others as may have noticed his not altogether conclusive arguments.

*Bee-pest in Ireland* (page 469).—These cases under the Irish Act are interesting as indicating points to be possibly guarded

against in the framing of our own requirements, and also as showing the reasonable manner in which objections may be met. Personally, it seems to me to be reasonable that inspection should take place at a time when honey-making is not in full swing, and this obtains under our own associations. Inspection is, of course, more congenial when there is a honey-flow, but it is the interest of the bee-keeper and not of the inspector which should be first considered. Inspection can very well be carried out at other times without risk if the inspector is, very properly, provided with a hive-tent. And there is, to my mind, little question that spring and autumn are the most practical times for the work. The dates suggested would seem to provide even for cases where clover stocks are transported to heather districts, and if the times were made official a permissive clause would make it possible for an inspector to arrange a mutually convenient date during the close season with such owners as "Buzz Bee" (page 497). Generally speaking, however, thorough inspection of storing stocks would result in loss. Whether such loss would be so great as estimated by Mr. Stephenson I cannot say. His estimate appears to be 4s. per hive, or perhaps about 8 lb. of evaporated honey. If this is an average daily yield it is a very good return, as may be seen by a comparison with the heather chart on page 417. For, of course, any one hive would only need inspection on one day, even if the three or four days may be taken as distributed over the total number of hives. It is at least a doubtful proposition that a hive takes three or four days to recover from examination. Indeed, there are not wanting those who believe in rattling the bees about like so many peas to put increased energy into their work!

"*I.O.W. Disease*" (page 478).—"*Disease is even carried under careless expert finger-nails, especially when hunting for driven bees.*" The italics are my own. Just why this should be so I do not see. Are the bees driven to hide under the eaves of the expert fingers, or are the nails of some especial use in the hunt for driven bees? I would just point out that comparison between a skep worth 1s. 6d. and a bar-frame stock worth £2 is, for the purpose, hardly a fair statement of values.

*Entomology* (page 486).—"D. M. M." says that "one sexual intercourse is sufficient to fertilise the eggs of numerous generations of aphides." Is this strictly accurate? I am not very familiar with varieties of plant-lice, but their annual life-history generally consists of partheno-

(Continued on page 18.)

## HOMES OF THE HONEY-BEE.

THE APIARIES OF OUR READERS.

We have pleasure this week in illustrating Mr. T. Alun Jones's apiary, whose interesting notes need no addition from us. He says:

"My experience with bees dates back to 1901. For six or seven years previous to that time my father kept bees, but his interest in them was not such that I should here term him a 'bee-keeper.' The apiary then consisted of one frame-hive and a skep, both sometimes occupied, but as a rule scarcity of stores reduced them to one stock by the spring, and, as they got but little attention, the surplus obtained was always small. About this time I made a new bar-frame hive, not because I had the least interest in bees, but because 'joiner's work' was my hobby. This was placed in the garden and prepared ready for tenants, and,

as comfortably as an old hand at the job. Like most beginners, I wore gloves at first, but very soon discarded them as a hindrance, and although I get an occasional sting, it has very little effect on me.

"After giving Italians, hybrids, and blacks a fair trial, I have come to the conclusion that the last are by far the most suitable bees for this locality. My hives are on the 'W.B.C.' principle, and all those in the picture are of my own make. I consider that making one's own hives and appliances greatly adds to the pleasures of bee-keeping. Of course, I buy all fittings such as frames, metal ends, escapes, &c.

"My apiary generally consists of about a dozen stocks, and these are divided into two lots about one and a half miles apart. The part shown in photo is at Rhosesmor—my parents' home—where I first fell in



MR. T. ALUN JONES'S APIARY, RHOSMOR, FLINTSHIRE.

very strangely, the old skep swarmed and the bees took possession of my new hive.

"In September of the same year I accidentally saw a copy of the B.B.J., and, being rather interested in it, I ordered the newsagent to get it for me regularly, and I have not since been without my weekly copy. Acting upon the advice given in the B.B.J., I got 'The Bee-keeper's Guide Book.' This I read over and over again. It had an absorbing interest for me, and the attack of bee-fever which I then had was most severe, and the same enthusiasm seems to be renewed as every season comes on.

"There were no advanced bee-keepers living within miles of me from whom I could get any help in the way of practical work, but by following carefully the instructions in my companion the 'Guide Book' I was able to do such work as bee-driving, uniting, &c., for the first time

love with the bees. The other part is at Halkya. During the swarming and extracting season my youngest sister, who is at home, renders me much help in the apiary, as my wife—who is seen with me amongst the hives—has not yet joined our craft. She is terrified at the idea of being stung, but takes an interest in anything she can do if the bees are 'at a respectable distance.'

"Being situated on the Halkyn Mountain, about 800 ft. above sea-level, I cannot boast of any very heavy 'takes,' but in moderate seasons my average is about 50 lb. per hive, spring count. The heaviest 'take' I ever had here was 99 lb. Nor is this district a good one for light-coloured honey, but what it does produce I am able to get in the best form. For some years past I have taken premier awards at our local flower shows, and last August I secured first prize for medium-

coloured honey at the Chester Show, and the same honey got v.h.c. at the Grocers' Exhibition. So I feel satisfied that my honey must be of fairly good quality of its class. I work mostly for extracted honey, and have no difficulty in disposing of all my crop each year before September is out. I use my own labels, and these have been the means of securing inquiries from satisfied consumers all over the country.

"Although I occasionally buy a queen to introduce to the apiary for the sake of 'new blood,' I do practically all my own queen-rearing.

"Apart from the pleasure this fascinating hobby affords me, I keep strict accounts, and always find a substantial balance on the right side at the end of the year. Taking the outlay into consideration, I do not think any of the minor agricultural industries can compare with bee-keeping if carried on with any degree of intelligence.

"In concluding, allow me to wish our esteemed Editor and the staff of both B.B.J. and *Record* the compliments of the season, hoping that the coming summer will more than compensate all brother bee-keepers for the past few years of scarcity."

(*Cappings of Comb*," continued from page 16.)

genetic generations during the summer, ending with a male and female generation, and resultant eggs which hibernates. I take it that "D. M. M." does not mean generations in the strict sense, nor that fertilisation of the mother affects the eggs of the daughter; but, even so, I am unfamiliar with the aphids which lays more than one generation of eggs. That is, allowing the term "generation" to cover such reproduction as takes place in the hive—i.e., a period to a "generation." "D. M. M.'s" recommendation to beekeepers to study entomology cannot be too fully endorsed. The study will well repay them, and a wonderfully wide field of interest will open out before them.

*Bee-men and Matrimony* (page 498).—Like "J. M. E.," many of us may regret that "Scot" has not yet made up his mind! For we hoped such great things of him that it will be sad if disappointment is to be our lot. If I may speak for those of us who have abandoned Mr. Ellis's "canny" state, we feel sure that "Scot" will not regret so careful a selection! At any rate, may we hope that soon he will no longer be able to describe himself as Scot-free? Good luck to his wooing! Incidentally, it is rather a good thing perhaps for "J. M. E." that he has no "guidwife" to reason with him on what he is pleased to term "grand-

motherly legislation" against the beheading of wives. If he had, may we speculate as to which head would be the one to be snapp'd off?

*Dummy or Division-board?* (page 514).

—May I once again plead for correct definition? Mr. Webb uses the latter term correctly, but the letter to which he refers uses the other synonymously. Now a dummy has a bee-way around it in the same fashion as the comb of which it is a dummy representation. The use of such dummies is to fill out the hive, so as to crowd the bees, without at the same time preventing access to the portion of the hive which is dummy-filled. In no true sense is a "dummy" a "division-board." Dummies are usually made by nailing thin board to the sides of ordinary frames. There is a hybrid variety which only has bee-way below, and which does not, I think, serve any purpose which is not better served by one or other of the standard devices. So will you add to your New Year's resolutions a determination to abandon the term "dummy" except in its proper sense, and earn the gratitude of all clear-thinking beekeepers? A happy New Year and a "better season" to all bee-keeping friends is the wish of the writer of "Cappings of Comb."

## Queries and Replies.

[4071.] *Mice and Rats in Hives*.—This season mice, and even young rats, have been very troublesome in my apiary, the latter eating holes right through the hive-covers. When examining a stock I caught two snugly nesting down for the winter. I managed to kill one of them. I found another hive had been eaten through and the combs very much damaged. Mice have also been a perfect pest, having done a lot of damage. I should be glad to know, if I put all my hives on single pedestals, whether mice would be able to get up these. I have the hives on sugar-boxes at present, and they run up the sides, I expect, and get in the roofs, as some of these do not fit very tight; but this I can remedy.—A SMALLHOLDER, Herts.

REPLY.—The fault evidently lies in badly-constructed hives. It is no use trying to keep bees in ramshackle hives; they should be sound and well made, and a little extra money expended on such is a paying investment in the long run. Good hives standing on legs, with an entrance not more than  $\frac{3}{8}$  in. deep, are secure from the attacks of mice. Our advice is to either buy or make thoroughly well-fitting hives, as with the

present ones you will always have trouble from enemies and robbing.

[4072.] *Bee-keeping on a Large Scale.*  
—1. I have considered a plan of establishing an apiary of 100 hives of bees here, and would be glad of some particulars in the matter. First, I should like to know the expense this would entail, apart from the hives and stocking of same, in labour, honey-house, and other necessary appliances for an apiary of this size. I may state here I would be unable to do much work myself. 2. Would you advise working for sections or shallow frames, or both? Is there a better market for sections put up in an attractive way than for honey in bottles? Of course, with shallow frames one gets more honey, but I suppose this difference would be expended in extra labour, bottles, &c. 3. Given average luck, what would be the net income from an apiary this size? 4. What income could one expect from queen-rearing? Would the business done in queen-rearing depend on the name one had in the bee-world? What salary would an expert get? What would the staff do in the winter? 5. Would an expert and youth be able to attend to 100 hives? I have been a reader of the B.B.J. since I took up bee-keeping three years ago, and find many very useful hints in it, which have helped me very much.—QUEEN-REARER, Norwich.

REPLY.—1. You would be ill-advised to start an apiary under the conditions mentioned unless you could look after it yourself, and would certainly lose money. The climatic conditions in this country are not favourable for bee-keeping on a large scale, and most certainly will not admit of hired labour unless something else is combined with it. Labour would cost at least 30s. per week, and a good honey-house the size you would require at least £40; other appliances would run into about £10. 2. As to the merits of sections or extracted honey, you would have to be guided by your market. More profit can be made out of extracted honey than sections. It is not necessary always to bottle the honey, for it can be sold in bulk. 3. During a good season in a suitable district stocks will give an average profit of 20s., when the owner looks after them himself. Bad seasons have also to be taken into account. 4. The profits made by queen-rearing would depend to a very great extent upon the name the rearer makes in the bee-world. 5. One man alone could look after more than 100 colonies if he spent all his time at it. You have much to learn yet, and a little more experience will show you the difficulties of an undertaking such as you propose to start. We appreciate your remarks, and trust we may still be of further use to you.

#### OLD ENGLISH RECIPES.

A writer in the *Woman's Supplement* of October 15 remarks on our debt for cookery recipes to the Church. Besides the Church, we also owe some good old recipes to our grandmothers. In an old Welsh farmhouse I came across a Book of Recipes beautifully written in violet ink by the grandmother of the present owner (aged 80).

Among them the following:—

"To Thicken Haire.—Take Dead Bees. Put them in an Oven, when dry, powder, and mix them up with a little honey, and anoint ye balde place."

It was considerate, at least, to console the ashes of the poor burnt bees with some of their own honey.

For heroic remedies our grandmothers would be hard to beat in our own day, as witness:—

"For a bone that sticks in ye throat.—Take a thimble-ful of Gunpowder, and swallow it Downe: it will dissolve ye Bone."

That they knew how to cook pigeons as well as pheasants, as described in the *Woman's Supplement* recently, is evidenced by this:—

"To Pickle Pigeons.—Take your pigeons and bone them, and lay two in one, and season them with pepper, nutmeg and salt, a little thyme and marjoram and shalot, cut very small and put inside your pigeons and soe them up whole. Make your pickle of old cyder, water and salt and two or three bay leaves. Bake them with Boughted Bread, and use cold with oil and vinegar."

The spelling and punctuation are the ancient lady's own. The recipe is easy for us moderns if we like to try it.—A Correspondent in the *Times Woman's Supplement*, October 29, 1910.

---



---

#### PRESS CUTTING.

##### A LOST PIN.

Mr. W. B. Webster, a bee-expert, of Binfield, has had a most unpleasant experience. While in church he had a fit of coughing, and had to make for the doors. When outside, his cough became worse, and he felt something hard come up into his mouth. This proved to be a pin, about an inch and a quarter long, very much discoloured.

The pin was shown to a doctor, to whom the circumstances of its recovery were explained, and the medical man expressed his opinion that the pin had been inside Mr. Webster for quite ten years.—*Daily Mail*.

## WEATHER REPORT.

WESTBOURNE, SUSSEX.

December, 1910.

Rainfall, 3.96 in.	Minimum temperature, 29° on 28th.
Above average, 1.05 in.	Minimum on grass, 21° on 28th.
Heaviest fall, .57 in. on 15th.	Frosty nights, 4.
Rain fell on 20 days.	Mean maximum, 48.5.
Sunshine, 43.9 hours.	Mean minimum, 38.4.
Below average, 12.4 hours.	Mean temperature, 43.4.
Brightest day, 27th, 5.4 hours.	Above average, 4.2.
Sunless days, 12.	Maximum barometer, 30.462 on 31st.
Maximum temperature, 54° on 16th.	Minimum barometer, 28.885 on 10th.

L. B. BIRKETT.

## WEATHER REPORT

FOR THE YEAR 1910.

WESTBOURNE, SUSSEX.

Rainfall, 35.68 in.	Maximum temperature, 74° on June 8 and 20.
Above average, 5.92 in.	Minimum temperature, 17° on Jan. 27.
Heaviest fall, 1.10 in. on April 6.	Minimum on grass, 13° on Jan. 27.
Rain fell on 194 days.	Frosty nights, 60.
Above average, 18 days.	Below average, 11.
Sunshine, 1,647.3 hours.	Mean temperature, 49.2.
Below average, 173.4 hours.	Above average, .9.
Brightest day, June 14, 15.2 hours.	Maximum barometer, 30.567 on Jan. 7.
Sunless days, 56.	Minimum barometer, 28.714 on Jan. 24.
Below average, 4 days.	L. B. BIRKETT.

## Notices to Correspondents.

Letters or queries asking for addresses of manufacturers or correspondents, or where appliances can be purchased, or replies giving such information, can only be inserted as advertisements. The space devoted to letters, queries, and replies is meant for the general good of bee-keepers, and not for advertisements. We wish our correspondents to bear in mind that, as it is necessary for us to go to press in advance of the date of issue, queries cannot always be replied to in the issue immediately following the receipt of their communications.

L. C. F. (Durban, South Africa).—*Bee-keeping in South Africa*.—The hive you mention will answer your purpose very well, and is used by a good many bee-keepers in your country. As you already have the "Guide Book," you should get "South African Bee-keeping," by H. L. Attridge, as that will give you useful information respecting bee-keeping in South Africa. It is published by the Department of Agriculture, Cape of Good Hope.

J. T. W. (Farnborough).—*Making Candy*.—The proportion of water is that given by Bro. Columban, and as a good

many tons of candy have been successfully made from his recipe, we presume you could not have boiled it fast enough to evaporate sufficient of the moisture. You can use less water, but then the sugar would take much longer to dissolve, and it is no use in candy unless thoroughly dissolved. The proportion we use ourselves is 6 lb. of sugar to 1 pint of water; but we had such frequent complaints, and in so many cases the difficulty proved to be due to the sugar not being properly dissolved, that we have substituted Bro. Columban's recipe, in which there is a little more water used.

CONSTANT READER (Sussex).—*Bees Dying in Well-stored Hive*.—The colony has evidently been queenless for some time. The bees sent are very old ones. The stores can be given to another stock with perfect safety.

*Suspected Disease.*

J. W. M. (Surrey).—Both stocks of bees have died from "Isle of Wight disease." We should strongly advise you to follow the directions we usually give in such cases (which you say you know well), and on no account run the risk of infecting the other stock for the sake of a few pounds of syrup.

F. A. P. (Herts).—We regret to confirm your opinion as to the cause of death of bees. They are suffering from "Isle of Wight disease."

*Honey Samples.*

W. N. (Herefords).—No. 1 is of no value, as it is fermenting. It is a heather-mixture, and had it been sound would have been worth about 12s. per dozen jars. No. 2 is a good sample, and has a slight mixture of heather. No. 3 is better than No. 4, but whether it would win or not on the show-bench depends on the competition; it should stand a good chance.

F. G. (Cambridge).—The odour of custard-powder is very strong in the tins; it is much better to put the samples in glass bottles. No. 1 is mainly from mustard or turnip seed. No. 2 is mainly of foreign origin.

H. C. (Wye).—Sample No. 1, in bottle, is a honey of good colour and density, but is devoid of flavour. The honey in smaller tube marked No. 1 is very thin, and slightly darker in colour. No. 2, in bottle, is excellent in density and colour, but the flavour is poor. No. 2, in tube, is darker in colour and much thinner. We should say the two smaller samples had been heated, No. 2 being overdone.

BEE.—Whether English or not, or from what source, it is impossible to say. It has been badly burnt in melting, and is quite unfit for table use.

## Editorial, Notices, &c.

### THE DZIERZON CENTENARY.

Bee-keepers in Germany are this month commemorating the centenary of Dr. Dzierzon, who was born on January 16, 1811, and died October 26, 1906. The Rev. Dr. Dzierzon at the time of his death was the oldest bee-keeper in Germany, and without doubt to him was due in a great measure the progress made in bee-keeping in Europe during the nineteenth century, and from which we are now reaping the benefit. Dr. Dzierzon was appointed pastor

writer, and made known his views in the *Frauentorfer Journal*. Later he published a work, which passed through several editions, entitled "Rational Bee-keeping," the latest and most complete edition of which appeared in 1878. The greater part of his observations and experiences appeared in the *Bienenzeitung*. In this journal appeared his views on "Parthenogenesis," and for eight years he had to fight hard to defend his theory, which met with the most strenuous opposition; but with the introduction of the Italian bee he was able clearly to demonstrate the correctness of his state-



THE LATE DR. DZIERZON.

of Karlsmarkt in 1834, and it was there that he started bee-keeping, and established the apiary which was destined to become historical. It was there also that he made his observations, although he had several out-apiaries in the neighbourhood. The Karlsmarkt apiary was visited by many people desiring to increase their knowledge of bee-keeping, especially by schoolmasters, many of whom came there for instruction at the expense of the Government. Dr. Dzierzon was an able

ments. The physiological researches of Professors Dr. von Siebold and Leuckart proved the correctness of Dzierzon's theories, and he gradually found adherents and recognition among men of science. In recent years M. Dickel made a desperate endeavour to upset the Dzierzon theory, and at the congress of bee-keepers in Salzburg in 1898, when the two met and both defended their theories, Dzierzon's arguments were so forceful that they constantly elicited applause, and Dickel was thor-

oughly defeated. Dr. Dzierzon had his partisans and detractors. Some, like M. Perez, have discussed the theory most courteously, but a few others have done so with extreme rudeness. Dzierzon, however, lived long enough to see his theory triumphantly vindicated before he passed away from amongst us.

The venerable man received a great many decorations and distinctions. The University of Munich conferred on him the title of Doctor, and several reigning sovereigns decorated him with orders, seen in the photograph.

To Dzierzon we are also indebted for the various artificial substitutes for pollen, and ever since his discovery bee-keepers have been in the habit of supplying the bees with artificial pollen in the spring. Dr. Dzierzon had a sad experience of the virulence of foul brood, and in 1848 he lost several hundred colonies, leaving only ten in his apiary untouched by the disease. So drastic was his fight against the disease that three years later he was able with pride to point to four hundred colonies of healthy bees, which he had worked up from the ten survivors of the disaster.

Dr. Dzierzon spent the last years of his life at Lowkowitz, where he took up his abode with his nephew, and where he lived a happy, peaceful, and contented life, devoting all his time to his bees until about a year before he died. Dr. Dzierzon's name will always stand out prominently in the history of bee-keeping; and we heartily join with our German brethren in commemorating the centenary of this remarkable man, to whom bee-keeping is so greatly indebted.

#### REVIEWS OF FOREIGN BEE-JOURNALS.

By "Nemo."

*The Value of Bees in Agriculture.*—To give an idea of the value of bees in agriculture, it is stated in the *Deutsche Illustrierte Bienenzeitung* that an ordinary colony during summer contains an average of 20,000 foragers. Of these eighty fly from the hive to the pasturage every minute; therefore, taking the working hours as from 7 o'clock in the morning to 5 o'clock in the afternoon, it would make 48,000 flights. During each time that she is out every bee visits at least fifty blossoms. This amounts in round numbers to two millions. It is reckoned that there are on an average 100 fine days when bees are able to fly, consequently 200 million blossoms may be fertilised by the bees of one colony. When only one-tenth of these blossoms are properly fertilised by bees, it still leaves the enormous number of twenty million fertilisations per colony.

*Alcohol and Honey.*—M. Ed. Freyhoff, the editor of the *Praktischer Wegweiser für Bienenzucht*, says that in Germany the yearly consumption of alcohol per head of the population amounts to 50 marks (£2 10s.), and that of honey to only 50 pfennigs (6d.). The total value of alcohol consumed in Germany therefore amounts to 3,000,000,000 marks, while the value of the honey consumed only totals 24,456,000 marks. These figures appear fabulous, but if correct, the editor's remark, "How much happier would many people be if these figures were reversed," is certainly very pertinent.

*Mignonette as a Bee-plant.*—There is an interesting article on this in the *Münchener Bienenzeitung*, and the writer, Herr Joseph Trollmann, says that usually borage, phacelia, and the various clovers are mentioned as the best nectar-producing plants, and to them mignonette is frequently added. According to the writer's observations, its value has induced him to place mignonette (*Reseda odorata*) at the head of them all. It has the good quality of flowering continuously for four months, yields not only nectar in abundance but also pollen, and is therefore one of the best plants for furnishing bees with winter provisions. Whether wet or dry, warm or cold, in the cool early morning, during the hot mid-day, and until the twilight of evening, bees swarm on his patch of mignonette. He further mentions that on October 24 last there was a sharp frost which destroyed all tender vegetation, but the plants of mignonette not only held up their heads during the warm sunshine, but attracted many bees from the surrounding apiaries. Although the wind was easterly, mignonette was still secreting nectar. On this day borage, phacelia, and white clover had no bee-visitors, while, notwithstanding the cold wind, bees were carrying the orange-coloured pellets of pollen into their hives in abundance. The writer says mignonette does not succeed in all soils, but he finds it to secrete nectar most abundantly on clay or marl soils, and on these it is a most valuable bee-plant.

*An Enemy of the Hive.*—O. K. Prokopenko describes in *Ptschelovodnaya Shisn* a beetle which does a great deal of injury to hives in Russia. It belongs to the family *Cerambycidae* (Longicornia), and is named *Hylotrupes bajulus*. The beetle is pitchy-brown, with a few lighter spots of thick hair, and two shining marks on the thorax. The elytra are flat and broad and the antennæ filiform, and as long as the body in the males, but shorter in the females, which also have an ovipositor protruding from the end of their abdomens. In this country the beetle is common, and



the larva has been known to do considerable damage in the timber of houses, even penetrating sheets of lead, and is also common in old deal and in posts. So far we have had no complaints of its doing any harm to hives in this country; but it appears that in Russia it has caused considerable damage to the writer's hives. The larva in burrowing throws out a fine dust, so that if this is seen at any time steps should be taken to prevent further damage.

*Treatment of Foul Brood in Germany.*  
—Herr K. Günther says in *Deutsche Illustrierte Bienenzeitung* that an experienced bee-keeper will never allow foul brood to gain a footing in his apiary. The chief point is to stop it at the very commencement. Foul brood does not break out in all the colonies of an apiary at the same time, but only in one here and there; therefore the bee-keeper must keep a watchful eye upon his apiary during the whole season. Every colony should be thoroughly inspected at least three times a year with the special object of ascertaining its condition in relation to this disease. In the spring attention should be given to the amount of food it contains, the development of the brood, the strength of the colony, &c., all of which give some indication respecting the health of the colony. The second inspection should take place immediately after the main honey-harvest. Lastly, at the end of August, or after stimulative feeding is ended, the colonies should be again thoroughly overhauled. Should single scattered cells of foul brood be found, these should be cut out and burned. The queen must be at once removed, so that there should be no brood in which foul brood could find a suitable medium in which to develop. All nostrums are useless, and frequently do more harm than good. Should a colony be very badly affected with foul brood, it should be destroyed without compunction, as it is the safest method of getting quit of the disease.

*Winter Flight of Bees.*—On this subject M. Philomel says, in *L'Abcille de l'Aisne*, that during severe weather bees remain quiet in their hives where they are sheltered from the snow and cold. They form a cluster, compactly crowded against each other, and thus maintain the heat necessary for their existence. But when the temperature becomes warmer, and the thermometer rises to about 45 deg. Fahr., all the future foragers take a cleansing-flight. They fly round and round their home, and return after thus disporting themselves for a few moments, and having discharged the residues of digestion which had accumulated in their abdomens during the long days of their seclusion. It is a pleasure for the bee-keeper to see

them, during their sudden awakening, inoffensively circling round and taking their bearings, just as if they had lost all memory of the place where they had been reposing. Sometimes it is an advantage to induce the bees to leave their hive when the temperature is suitable, so that they may have a cleansing-flight. One may even tap the hives to cause the bees to come out for a few seconds. But this requires great care, and if there is a rapid thaw when snow is on the ground it would be much better to close the entrances and make the inmates remain indoors. If this precaution is not taken the rise in the temperature would entice the bees out, and in attempting to rest they would drop on the snow, become chilled, and, being unable to rise again, would eventually perish. This would be an enormous loss, for colonies thus decimated could hardly survive till spring.

---



---

## NECTAR-PRODUCING PLANTS AND THEIR POLLEN.

By Geo. Hayes, Beeston, Notts.

(Continued from page 13.)

No. 3.—THE APPLE (*Pyrus Malus*).

NAT. ORD., *Rosaceæ*.

In the month of May, when covered with a mass of pink and white blossoms, the apple tree forms a really beautiful sight, and when the trees are numerous the heart of the bee-keeper is gladdened to know that in this profusion of bloom there is at least food for his bees, if not much surplus for himself. Moreover, he knows that these flowers especially need the visit of his bees to carry the pollen from stamen to stigma to ensure a large crop of well-formed fruit.

The flowers, it will be noticed, grow in umbels or bunches at intervals on the branches. The calyx is a tube terminating at the upper part in five separate points and very woolly. The corolla is composed of five lovely pink and white petals; it has five styles united at the base. The stamens are very numerous. The leaves, when young, have a colour of their own known as apple-green, and are downy underneath.

The generic name is derived from the Latin *pyrus*, a pear; the specific from *malum*, an apple—a word used by the Romans to denote several other fruits of a similar character, such as quinces, pomegranates, pears, &c.; thus Virgil speaks of "*aurea mala*," i.e., quinces. Our English word is derived from the Anglo-Saxon word *Æpl*. Pliny states that "there were apple trees in the villages near the city which yielded more profit than a small farm."

The fruit is used largely for making cider, especially in Devonshire. In the reign of William III. Ambrose Philips wrote a poem in praise of cider, in which he says:—

What should we wish for more? or why, in quest  
Of foreign vintage, insecure and mixed,  
Traverse the extremest world? Why the rage  
Of the rough ocean when our native gleebe  
Imports from bounteous wombs annual recruits  
Of wine delectable.

The mistletoe is more partial to the apple than to any other kind of tree. While an interesting plant in itself, its parasitic growth soon proves injurious to the tree that supports it. The wild apple or crab is the progenitor of the hundreds of varieties we now have, and it is a curious and noticeable fact that it bears thorns for its protection.

The apple flower yields abundantly both nectar and pollen, and on a fine day the bees may be seen revelling in its blossoms. The pollen, when placed on the thigh of the bee, is of the palest of green colours, but darkens with age if kept in some receptacle. The grain is navicular or boat-shaped; usually, when lying horizontally in the flower, it appears as shown at Fig. 5, 1 A, but sometimes shows the forms at 1 B, C, D, the appearance due to the flutings or depressions depending upon the position in which it lays. A section of this pollen is shown at 1 E.

When collected by the bee, the moisture used for packing it in the pollen-basket causes some of the grains to alter their form, as shown at 3, c being the original form, whilst A and B are in a transition stage.

If a grain is placed in water, it quickly assumes the form shown at 2, which, with the exception of the depressions in the centre of the sides, is identical with those taken from honey, as seen at 4 A and B.

No. 4 is the appearance of the grains found in honey. A and B differ slightly in outline, the sides in one being concave and in the other convex. On both will be found what I believe to be pseudo-processes, which are clearly indicated in the enlargement. The texture of the pel-

licle is very rough and wrinkled, and the roughness extends even to the processes at each angle. When viewed by transmitted light the colour is a dull yellow.

(To be continued.)

## AMONG THE BEES.

SOME USEFUL HINTS.

By D. M. Macdonald, Banff.

*Embedding Wires.*—I was lately much struck by the perfect work done by an electric current in embedding wires in a sheet of foundation. The operation was momentary. The frame with full sheet, wires above, was placed on a frame-block,

a connection was made at one small point, and forthwith, and as if by magic, the wires were lying at the very centre of the wax. Frame after frame was laid down, operated on, and laid aside with every wire perfectly embedded. Sheets of foundation well fixed in the frames, and then so admirably wired, should ensure almost to a certainty combs all worker-cells, and all well and truly built so as to be perfectly interchangeable. Here from the very foundation is the fabric for the brood-nest all that the most fastidious could desire. Appliance dealers supply these wired-in combs at a fair price, and they are well worth the little extra they cost. Many bee-keepers may have the means of electrically embedding their wires, and, where they have,

my hint should not be thrown away, but should be applied. A colony in a hive with imperfect combs can never be a powerful one. Every cell in every frame of the nine or ten generally used is necessary to secure the best breeding results. Then it follows that where from 20 to 30 per cent. are defective cells, as too often happens, the brood suffers to that extent. Take the hint, and have every comb as nearly perfect as possible.

*Depositing Fertile Workers.*—Here is a successful plan of ridding a hive of these pests; at least, it worked out a colony's salvation once, and I do not see why it should not again. Clear out two central

### 1. Dry.

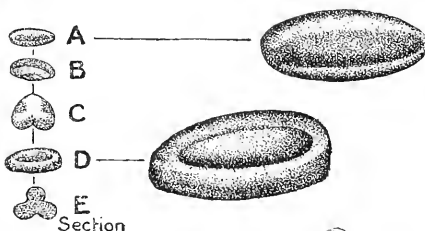

### 2. In Water.

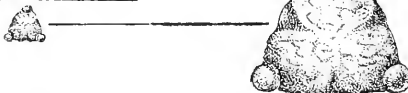

### 3. From Leg of Bee.



### 4. From Honey.

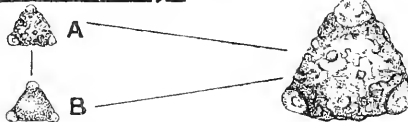

FIG. 5. POLLEN OF APPLE.

combs—perhaps any two would do—and take two with bees, brood, and eggs out of a nucleus, *with the queen*, inserting them in the space hitherto occupied by the two combs withdrawn. That is not all that is in it, however. See that the queen is in between the two combs protected by her own bees, and, to make assurance doubly sure, call in a little art to certify that she is thoroughly guarded by almost all the bees on the two frames. To secure this, lay the frames down leaning to the side of the hive, or hanging on a comb-stand. Smoke the outsides of both combs gently, in order that the bees will crowd towards the centre between the two frames. Here is a little bodyguard ready to protect their queen and shield her from any harm. Gradually it comes to the knowledge of the bees of the hive—by some form of telepathy, perhaps—that a genuine queen heads the stock. All the young bees crowd round the eggs and young larvæ at an early stage of the proceedings to act the part of nurses—a duty for which their little souls long—and they, too, are a further protection for the introduced queen. The discovery of this plan was purely an accident, but, in my opinion, it is one of the very best ways of ridding a colony of fertile workers, or, I should imagine, even a drone-breeder.

“*Honey for Sale.*”—Many bee-keepers are good all round at producing a honey crop, but not so many are able to dispose of the finished article to the best advantage. Too often they wait until customers come inquiring for honey. Almost all other articles are brought to the merchant or market, but honey is an exception. This is a grave mistake. Not many bee-keepers can actually carry their surplus to market; few in this country would care to peddle their honey, and only a very small percentage trouble to advertise it. Personally, my own honey is sold out even in a good year before it comes off the hive, because during a long series of years repeat orders come in, and friend sends friend to me for more, until I have to fall back upon others to supply the demand. Earlier in my experience, however, I did not wait until customers came. I got a number of neat cards printed, simply giving my name and address, and the kinds and prices of the honey I had for sale; something like the following:

	s. d.
Pure Clover Honey ..... in sections	0 10 per lb.
Blend of Clover and Heather... „	1 0 „
Pure Heather Honey ..... „	1 3 „

These cards would travel per post for a halfpenny stamp as a post-card, or in an unsealed envelope; but I always preferred to seal the envelope and put on a penny stamp. There was no solicitation—only an intimation that I had the honey for

sale. A very large percentage of the cards brought orders.

*Advertising Honey.*—In general, many bee-keepers say this does not bring them in many paying orders, even in the leading newspapers. Do not advertise in this way if this is your experience. Select a small newspaper or two, and try them instead. Many of our small towns, and even villages, have one of these circulating amongst the very class you want to tap—the upper middle-class. If the town is a health resort for summer visitors, you have the very “audience” you require. They are leading a life of leisure, and scan every item of local news in the district newspaper. One is in delicate health, another has a sensitive palate, a third has heard of the deliciousness of heather-honey, a fourth remembers the sweetness of honey partaken of in early life, a fifth has a friend he or she would like to present with some local souvenir, a sixth wants to carry away some relic of the temporary home, and so on. For numerous reasons your small advertisement, read in a time of holiday leisure, is impressed on the memory of the reader, and orders come in as a result.

In many parts we have some fine scenery, ancient castle, or noted battlefield, with crowds of tourists every summer. Take the Burns country. One bee-keeper informs me that he has a small notice on his garden gate, “Honey for Sale,” and that he sells all the produce of his twenty hives—clover at 1s. per lb. and heather at 1s. 6d.—without further effort. Before he exposed this notice he had to peddle his honey or send it to market.

## Correspondence.

*The Editor does not hold himself responsible for the opinions expressed by correspondents. No notice will be taken of anonymous communications, and correspondents are requested to write on one side of the paper only and give their real names and addresses, not necessarily for publication, but as a guarantee of good faith. Illustrations should be drawn on separate pieces of paper. We do not undertake to return rejected communications.*

### FEEDING THE YOUNG LARVÆ.

[8022.] During a lengthy experience I have had occasion to notice that breeding commences in a very small way early in the year. At this date a little batch of brood, possibly only the size of a penny-piece, may be found in some of the strong stocks that have a young and vigorous queen anxious to get on with her duties. I have found these small beginnings of a great future as early as the fourth week of December, when, by accident rather

than a wish to do so, it has been necessary to open a hive. The increase in the quantity of brood reared is so gradual from the small beginning that, though the old bees of last autumn's rearing are unable to do the work of the nursery at all well, they smooth away the difficulty of rearing the first little batch of young bees so well that I do not think there is any point left by them for writers and readers of bee-literature to consider. Three weeks after the queen has commenced to lay eggs a small number of young bees—it may be only five-and-twenty for a beginning—make their appearance. These may be, and probably are, imperfect through the inability of the old bees to feed and tend them properly in the larval stage; but these few young bees come upon the scene and take the work of nursing the young off the hands of the old bees, and they will do it better than the old bees were able to, and within six weeks from the commencement of breeding all the difficulties which are inseparable from any beginning of what is to be of the future perfection that is reached in a good stock of bees will have been surmounted.

If we wish to rear young queens, that is quite another matter. We must have the conditions perfect to begin with, otherwise we find the stamp of varying imperfect conditions perpetuated indefinitely by poor or defective mother-bees.—  
GUARDIAN.

#### CO-OPERATION FOR BEE-KEEPERS.

[8023.] Perhaps the present time, when a new season is commencing and the desire of the British Bee-keepers' Association is towards reconstruction, is not inopportune for the revival of the old cry of co-operation among bee-keepers. Because previous efforts in this direction have failed is no proof that bee-keepers form a class especially unsuited to co-operate, but rather that the forms of co-operation hitherto proposed have been particularly unsuited to their requirements.

The numerous and excellent sources whence hives, &c., can now be had render co-operative purchasing, at least at present, of very little value. Nor do those bee-keepers who have for disposal stocks, swarms, and queens appear to be in any need of united effort; hence the success of any apiarian co-operative venture seems to depend upon the extent to which it provides for and attracts honey-vendors.

The producers of honey may be divided into three general classes, viz., (1) the man who easily disposes of his entire yield; (2) the man who has only a limited market; and (3) the "amateur" who is not willing to exert himself to make a market, though he would probably welcome one ready made.

Members of class 1 are not likely to be of much assistance in starting a co-operative movement. It may be possible, however, to enlist their active support for a scheme which aims at preventing classes 2 and 3 putting on the market honey at a price, and often of a quality, which is detrimental to their own interests.

Such a scheme is briefly sketched in the following suggestions: Honey-producers wishing to benefit by co-operation should form an association as a limited company; shares, say, 5s. each, and the holding of at least one to be compulsory on each member. The company to rent a warehouse, and engage the whole or part time of a honey expert who is also a good business man and able to make sales. A member having honey to dispose of should send the bulk or a sample carriage forward to the warehouse. In due course he would receive an advice of its receipt together with a price. This price must be a fixed proportion, say one-third below what the manager considers to be the fair market value of the lot, and the member must either accept it unconditionally or refuse it absolutely. In the latter case the honey would be returned carriage forward. Having the control of a fairly large and varied supply of honey, it ought to be possible to make remunerative contracts for its disposal to one or two large consumers, or even to put it up in standard qualities suitable for supply to the retailer direct. At the end of the year any profit would be appropriated, first to the formation of a satisfactory reserve, then to the payment of a maximum dividend of, say, 5 per cent. on the capital, and the residue would be divided among the members proportionately to the value of the honey each had contributed. Even if the earlier contracts, in order to establish a connection, were made at a comparatively low rate, the price realised would most likely satisfy the majority of classes 2 and 3; whilst the scheme would tend to standardise the price and qualities of honey, preventing the market in a high-yielding locality from being spoilt by timid or reckless sellers, and enabling honey to be "pushed" in an attractive form and at a lower price in localities where it is now usually treated as a little-known and somewhat extravagant luxury.—H. READER, Cheshire.

#### DISINFECTATION IN NEW ZEALAND.

[8024.] The editorial footnote to Mr. R. Whyte's communication on page 9 so admirably controverts the points he seeks to make that I need only show readers that I did not write in ignorance of facts.

I have before me a bulky volume, "The

Annual Report of the Department of Agriculture of New Zealand." I quote from page 71, the writer being the chief apiarist: "I decided to treat all the seventy-two colonies on the McEvoy plan. The bees were shaken off their combs and given bare frames. Five days later the bees were again shaken on to full sheets of foundation. At the same time *all the floorboards had been scraped and disinfected, as were also the hives.*" From Bulletin 18 I again quote the following: "The hive, bottom board, and cover, if sound and worth saving, *should be cleaned and thoroughly disinfected.*"

If Mr. R. Whyte did not know before that the McEvoy treatment in New Zealand *includes disinfection*, he surely knows it now. Verily "some of the disputants in this controversy have been more than ordinarily unscrupulous in their allegations of facts."—D. M. MACDONALD.

#### THE "WELLS" SYSTEM.

[8025.] I was much interested and enlightened in reading Mr. Fischer-Webb's remarks on the "Wells" system (8010, page 514, December 29, 1910). As far as my limited experience goes, I quite agree; but I want to know more, and shall be greatly obliged for information (Editor permitting). I have some hives the right width for standard frames, and they are 25 in. long, inside measure. Could these hives be utilised in the "Wells" system? I have only once got one of them full of brood, and that was by introducing about five gallons of driven bees the previous autumn to the hive, which was fairly strong before.

The questions that occur to me are these: As the hives are not long enough to take two ordinary section-racks, would it matter if only one were used and tiered up instead, or had I better make racks to fit the hive? I presume bees do not fight in the sections. Is that so? Also, should the entrances be at each end or both on one side, to face south? Thanking Mr. Fischer-Webb in anticipation.—T. NEWMAN, Dorset.

#### COMB-FOUNDATION AND FOUL BROOD.

[8026.] About fourteen or fifteen years ago I had foul brood in my apiary, and used "Izal" as a cure, and have used it in all food since, and I have no fear of any disease. I am prepared to hear objections from some, but I am convinced that a great deal of this disease is sent out in foundation. A bee-keeper at the Dairy Show told me he had all his wax made up again into foundation, yet foul brood has been in his

apiary for years. The editor of *Gleanings* says one of the patrons of the A. I. Root Co. sent them a lot of wax from foul-broody combs, but was honest enough to tell them of the fact. When they knew of this, the foreman was instructed to give it special treatment. It was placed in a barrel by itself and brought nearly to a boiling-point by a steam jet for an hour. Next day it was treated in the same way and again heated, after which it was mixed with a general supply, then heated once more. This, of course, would render it entirely safe. Mr. Root says he thinks it is very unwise, certainly unsafe, for anyone to render up old foul-broody combs. Wax with a steam jet cannot be heated above 200 deg. Fahr., never more than 212 deg. if surrounded by boiling water, and even if one can thoroughly sterilise his wax, he runs a tremendous risk; and he desired to say to his friends that the A. I. Root Co. prefer not to receive wax from foul-broody combs, and if anyone has sent them such wax without telling them, there would be a possible danger of giving some innocent user of foundation foul brood. The boiling-point of good thick honey is 233 deg. Fahr.; thin honey, about 225 deg. Fahr. Yet we have Mr. J. A. Buchanan and others stating that no boiling will destroy the spores. Mr. Howe also says boiling honey for fifteen minutes at 235 deg. Fahr. is not safe to feed back. If this is true—and I am convinced it is—how can the spore be destroyed in wax which is never brought to a boil? I hope our foundation-makers will not hit me too hard, but let me down very gently.—J. PEARMAN, Penny Long Lane, Derby.

[On the other hand, we have the evidence of Dr. Maassen, which goes to show that, although the spores of foul brood may not be destroyed even by the high temperature mentioned, foundation made from combs taken from colonies badly infected with foul brood was perfectly harmless. On page 483 of the B.B.J. for last year we mentioned the experiments carried out at the Imperial Biological Institute, Dahlen, with the express object of finding out whether the disease could be propagated by means of infected wax, and to what extent comb-foundation was able to carry the infection. Although bees were placed on comb-foundation made entirely from wax obtained from colonies that had succumbed to virulent foul brood, not in a single case did the disease re-appear, and all the colonies remained healthy. As these results are from direct experiment, it is satisfactory to know that the danger apprehended by our correspondent is very remote. Although we have always used full sheets of comb-foundation, we have not had an outbreak of foul brood for more than thirty years.—ED.]

## MINEHEAD AS A BEE-DISTRICT.

[8027.] Can you or any of the readers of the B.B.J. give me information about Minehead, in Somersetshire, as a first-class place for keeping bees in quantity? Probably some resident of the district might be able to give me the information desired. I wish to pitch on a place where either sainfoin or clover abounds, and it must also have a mild climate.—A SMALLHOLDER, Herts.

## THE HUMBLE DUMBLEDORE.

By "Lordswood."

Let me say a word on behalf of the poor and despised humble-bee. Poor through no fault of his own, for never did a hive-bee work so hard; and despised he must be, for who ever found his home and did not try to destroy it? Of the different species—near a hundred—and their life-history I will tell you something at a future time. Their very names bring back to mind the lovely English country where I have sought them—the great forests and high hills, the southern downs and rich Gloucestershire meadows. I love them so well that I could even tell the species by their song, as you may the birds by their song, or the butterflies by their flight, or the flowers by their scent. To bring them back to memory dear, in these dull wintry days, all bee-keepers should read the books of Richard Jefferies, such as "The Open Air," "Field and Hedgerow," "The Life of the Fields." From the matchless "Pageant of Summer," in the last-named book, I give the following extract: "Each kind is repeated a hundred times, the foxtails are succeeded by foxtails, the narrow blades by narrow blades, but never become monotonous; sorrel stands by sorrel, and daisy flowers by daisy. This bed of veronica at the foot of the ancient apple has a whole handful of flowers, and yet they do not weary the eye. Oak follows oak and elm ranks with elm, but the woodlands are pleasant; however many times re-duplicated, their beauty only increases. So, too, the summer days; the sun rises on the same grasses and green hedges; there is the same blue sky, but did we ever have enough of them? No, not in a hundred years! There seems always a depth somewhere unexplored, a thicket that has not been seen through, a corner full of ferns, a quaint old hollow tree which may give us something. Bees go by me as I stand under the apple, but they pass on, for the most part bound on a long journey across to the clover fields or up to the thyme lands; only a few go down into the mowing-grass. The hive-bees are the most impatient of insects; they cannot bear to entangle their wings, beating against grasses or boughs. Not

one will enter a hedge. They like an open and level surface, places cropped by sheep, the sward by the roadside, fields of clover where the flower is not deep under grass."

It is the patient humble-bee that goes down into the forest of the mowing-grass. If entangled, the humble-bee climbs up a sorrel stem and takes wing, without any sign of annoyance. His broad back with tawny bar buoyantly glides over the golden buttercups. He hums to himself as he goes, so happy is he. He knows no skep; no cunning work in glass receives his labour; no artificial saccharine aids him when the beams of the sun are cold; there is no step to his house that he may alight in comfort. The way is not made clear for him that he may start straight for the flowers, nor are any sown for him. He has no shelter if the storm descends suddenly; he has no dome of twisted straw, well thatched and tiled, to retreat to. The butcher-bird, with a beak like a crooked iron nail, drives him to the ground, and leaves him pierced upon a thorn; but no hail of shot revenges his tortures. The grass stiffens at nightfall (in autumn), and he must creep where he may, if possibly he may escape the frost. No one cares for the humble-bee. But down to the flowering nettle in the mossy-sided ditch, up into the tall elm, winding in and out and round the branched buttercups, along the banks of the brook, far inside the deepest wood, away he wanders, and despises nothing. His nest is under the rough grasses and the mosses of the mound, a mere tunnel beneath the fibres and matted surface. The hawthorn overhangs it, the fern grows by, red mice rustle past.—January 16, 1896.

## HOMES OF THE HONEY-BEE.

## THE APIARIES OF OUR READERS.

The illustration on the opposite page shows the out-apiary of Mr. W. Goodchild, a bee-keeper whose interest in the craft is not confined to the amount of surplus obtained per stock, which, in fact, does not enter into his calculations at all. Mr. Goodchild is content to look upon the bees as a pleasurable and health-giving hobby, which takes him away into the pure air of the country whenever a spare day occurs. In the notes written to accompany the picture he says:

"My first recollections of bees go back to boyhood, when the interest then created by my father's bees (in the old days of sulphur-pits) led me, when the opportunity came about eleven years ago, to lay the foundation of my present apiary.

"My brother presented me with my first stock in a modern hive from his own apiary at Nottingham. Knowing very

little about bees, I had a lively time of it at first, and found, if I intended to keep them successfully, I must learn something about their management, and this I did by reading up the subject in the *BEE JOURNAL* and *Record* (and also in the 'Guide Book'), having obtained valuable information in this way during the time I have taken them. Indeed, I think no bee-keeper can afford to be without one of these papers; they are indispensable. As stated above, I began bee-keeping with one hive, and established an out-apiary and cottage four miles from Burnley. Being easy of access by road and rail, my family and friends make it their home at week-ends, and for change of scenery, change of thought, fresh air, and a successful place for the bees it cannot be under-estimated. I consider it has been

"I notice that many readers complain of their bees getting the swarming fever, but mine are never troubled in this way. My bees seem to be quite content with their old homes, so long as they have room in advance of their requirements, and this stops the swarming impulse, with me at any rate.

"What little knowledge I possess of the craft is always at the service of those who seek it, and this seems to afford equal pleasure to giver and receiver. It is especially interesting and instructive to the children, who come up from the village school and ask just to have a peep at the bees, to judge from the looks of astonishment and intelligent interest depicted on their faces when they hear such simple facts as the bee's body is covered with hair, that it breathes through open-



MR. W. GOODCHILD'S APIARY, HOLMES-CHAPEL, BURNLEY, LANCs.

the best investment I ever made for health, pleasure, and profit.

"The scenery round about my apiary (which is situated 800 ft. above sea-level) has a radius of thirty miles of mountain, waterfall, rock, and ravine, and for the naturalist, botanist, and geologist is one of the beauty spots in the British Isles, but unfortunately it is not one of the best honey-districts. I never look forward to obtaining 100 lb. of honey per hive like some B.B.J. readers, but am well satisfied with an average of 30 lb. per stock, which is, however, choice in quality, being a heather-blend.

"I am a stranger to foul brood, so cannot give any experiences with it. I find it does not answer to keep old queens, and therefore I re-queen regularly, as if this is not done I lose stocks during winter.

ings in its side, that it has two bread-baskets, that it can fly backwards, that its blood is white, that it has a brain, heart, &c. Bee-talks must be very beneficial in arousing in them a desire for information and assisting in making them, after their school-days are over, keener observers and in greater sympathy with their surroundings and in their enjoyment of country life.

"One of the most pleasant characteristics of bee-keeping is its freemasonry of kindly interest and helpful brotherhood. If only for that I should never regret the time spent amongst the bees; also I owe to it improved health and a great relief from the strain of years of business life.

"Having a warm corner in the cottage garden, sheltered from north and east

winds, I erected a shed to hold three or four hives. This shed is open in front; thus I am enabled to spend many hours in watching the little workers. It also has the advantage of enabling me to manipulate under any weather conditions. The hives are mostly home-made; the centre one of the three under shed is a 'Meadows' non-swarming hive. The figures in front of the shed are myself, and on my right is my staunch old friend Mr. Peter Shackleton, a neighbouring bee-keeper, a capital manipulator, and lecturer and hon. district secretary for the Lancashire B.K.A. Mr. Shackleton's out-apiary is some eight miles from Burnley on White Moor, amongst the heather. We both hope to do a little more yet towards spreading the love of bee-keeping, which our Editors, through the valuable B.B.J. and *Record*, ably advocate. Wishing all bee-keepers success in 1911."

#### B.B.K.A. LIBRARY.

Since the last announcement in B.B.J. the following books have been received for the library: "The Lore of the Honey-Bee," "The Bee-Master of Warrilow," and "Bees as Rent-Payers." from Tickner Edwardes, Esq., and three volumes of B.B.K.A. reports from J. Noble-Bower, Esq.—W. HERROD, Secretary.

#### PRESS CUTTING.

##### BEEES AND EXOTIC FLOWERS.

One of the many difficulties which confront the popular theory that the form and colour of flowers are due to the selective action of insects is the fact that our native bees visit freely a number of foreign species introduced into our gardens. These often differ widely in form from those which they must be supposed to have evolved and shaped to their own special needs and fancies. Among such flowers may be mentioned fuchsia, *Nasturtium canariensis*, and Himalayan balsam. If our native flowers reflect in the minutest details of their structure, and in the exact shade of their colour, the tastes of the bee, and are kept up to this standard only by the continuous selection of the insects, should we not expect our native bees to restrict themselves to such? Would they be so ready to visit the alien form, if for countless generations they had selected a very different shape, which, indeed, owed its existence to their continued devotion to it? If, on the other hand, we suppose that the object of the bee is honey or pollen, and that it cares little or nothing for shape or colour, its devotion to foreign flowers is easily explained. If this is so, however, it ceases to be a possible cause of the evolution of the shape and colour of flowers.—*Globe*.

## Notices to Correspondents.

*Letters or queries asking for addresses of manufacturers or correspondents, or where appliances can be purchased, or replies giving such information, can only be inserted as advertisements. The space devoted to letters, queries, and replies is meant for the general good of bee-keepers, and not for advertisements. We wish our correspondents to bear in mind that, as it is necessary for us to go to press in advance of the date of issue, queries cannot always be replied to in the issue immediately following the receipt of their communications.*

R. B. (Mildenhall).—*Hive-making*.—

There is no doubt that frame-hives are best, and if you are able to make one you will find full particulars in the "British Bee-keeper's Practical Notebook." There are all the dimensions given and detailed drawings for making the "W.B.C." hive, also "a home-made hive" to be constructed from used boxes. We would certainly advise you to transfer the bees from skeps to frame-hives, as recommended in "Guide Book." Should you need further advice write again.

H. R. (Cheadle Hulme).—*Meaning of "Hatching" in the Apiary*.—Properly speaking, "hatching" should be only applied to the issue of young from the egg, but, as in the case of other animals and generally, it refers to bringing forth or into existence, to bringing to maturity or full development. "Hatching brood" is commonly used to express the issuing of the matured bees from the cells, although *emerging brood* would be the more correct term; but most writers mean by "hatching brood" that which is just emerging from the cell.

G. M. (Churt).—*Removing Heather-honey*.—It is impossible to remove heather-honey from the combs with an extractor, and as you say melting them down causes discoloration of the honey, your only plan will be to improvise some kind of a press.

##### *Honey Samples.*

G. G. (Nethy Bridge).—Sample is a good heather-honey.

BEE-MAN (River Lea).—The dark sample is from ragwort, and we are afraid you will have a difficulty in disposing of it. The light sample is good in colour, but exceedingly thin. It is from mixed sources. Many thanks for your appreciation and good wishes.

##### *Suspected Disease.*

G. W. (Seagrave).—The bees have evidently died of starvation, as there was not a particle of food in their stomachs. Wash the hives thoroughly with carbolic acid solution, as given in "Guide Book," and melt the combs down, starting fresh stocks with full sheets of foundation.

C. G. (Chester-le-Street).—Bees have died from "Isle of Wight disease."



## Editorial, Notices, &c.

### BEGINNING BEE-KEEPING.

We have so many inquiries from beginners as to the best way of making a start that it is not out of place to refer now to some points of considerable importance to the uninitiated in the hope that they may be able to avoid disaster, annoyance, and expense.

Beginners, often in their eagerness to be able to secure honey, purchase *stocks* of bees. This is not the proper thing to do, and in many cases ends in failure. Avoid the purchase of old stocks at any price. A swarm in May should be the foundation of every new apiary. An experienced bee-keeper *might* secure a bargain; it is probable that a beginner would *not* do so. There are many contingencies, such as the proper preparation of the colony for wintering, and the care it has had through the previous winter, to say nothing of disease, that make it very risky for a beginner to commence with old stocks. A swarm will be more likely to go to work with energy, and will afford a means for study, which, if properly done, will give the novice a large insight into the science.

Be sure before purchasing the swarm to have a *new* hive ready, properly furnished with full sheets of comb-foundation. Any of the dealers who advertise in our columns would supply a really useful hive at a moderate price. Here again we would emphasise the importance of leaving second-hand hives severely alone by those commencing bee-keeping. Their faults *may* be many; for instance, they may be contaminated by foul brood or other diseases, leaky, not having standard frames, or of an antiquated, and therefore not such a useful, pattern, and possibly of a generally rickety constitution. Old combs may also provide foul brood and wax-moth, neither of which is conducive to success, and which handicap the tyro at the very start. Nor should various odd fittings offered cheaply tempt our friend while he is still on the threshold of the study. The actual requisites are few, so that it is better first to find out what is absolutely necessary and then to get it. A good many promising bee-keepers have thrown up the pursuit in disgust because they have been led into unnecessary expense at the outset. It is all very well to study dealers' catalogues, but it is better to obtain only what is indispensable, and eschew the numerous fads that are frequently not only of little use, but a hindrance to successful manipulation. When once started, the beginner must keep a watchful eye on anything which is heralded as about to revolu-

tionise bee-keeping completely. Were many of these much-vaunted articles generally adopted there would no doubt be a revolution in bee-keeping, but not in the honey-extractor, which, after all, is the principal consideration of the honey-producer. To an old experienced bee-keeper it is often amusing to watch the resurrection of some old exploded idea, but it is not so with the novice, who takes it up and when too late wishes he had not done so.

The articles absolutely necessary are: A hive having ten to twelve standard frames fitted with full sheets of comb-foundation, a division-board, smoker, feeding-bottle, quilts, veil, super fitted with sections provided with thin foundation, and the bees. For all these an outlay of 30s. to £2 should be sufficient. It is important that the hive and other things be procured some time beforehand, so as to be ready for the bees when the swarm arrives, and the winter months are the best time for getting these requisites, as then the dealers are not so busy, and orders can be more promptly executed. It is no use leaving it until the swarming season, for then the dealers are so busy executing orders that considerable delay may occur, and a good part of the season would thus be lost.

The novice should also gain experience by seeking information from any bee-keeper with whom he can make acquaintance. He should read every available standard book, such as Cowan's "Guide Book," which for him is indispensable, "Langstroth on the Honey-Bee," Roots' "A B C and X Y Z of Bee-Culture," and others. He should join his county association, and by joining the B.B.K.A. he could attend the conversaciones and get in touch with the many experienced bee-keepers there. He should carefully read the *BRITISH BEE JOURNAL*, and if in any uncertainty ask us any question, and we shall be pleased to assist by answering it in our columns. Then, having been taught, let it be his chief pleasure to teach others, for in this world there is plenty of room for more of the kindly spirit which has its greatest delight in helping others to the best of our ability, so that they may share with ourselves in the same measure of prosperity, as well as pleasure.

---

### BRITISH BEE-KEEPERS' ASSOCIATION

The monthly meeting of the Council was held at 23, Bedford Street, Strand, London, W.C., on January 19, when Mr. T. W. Cowan presided. There were also present Messrs. W. F. Reid, T. Bevan, C. L. M. Eales, J. B. Lamb, E. Garcke, E. Walker, O. R. Frankenstein, A. Richards, G. H. Skevington, E. R.

Stoneham (Crayford), F. W. Watts (Beckenham), and W. Herrod, secretary.

Letters expressing regret at inability to attend were received from Miss Gayton, Rev. A. D. Downes-Shaw, Dr. T. S. Elliot, and Messrs. H. Jonas and G. W. Avery.

The minutes of the Council meeting held on December 15, 1910, were read and confirmed.

The following new members were elected:—Miss M. Dagmar Sillar, Bloemfontein, South Africa; Mr. G. Mason, Moorend, Yardley Gobion, Stony Stratford; Mr. D. Cairncross, Pretoria, South Africa; Mr. Tickner Edwardes, The Red Cottage, Burpham, Sussex; Mr. J. Smallwood, Ivy Villa, Finchley Lane, Hendon; Mr. H. Reader, 9, Beech Road, Cheadle Hulme, Cheshire; and Mr. W. J. Coates, 4, Trafalgar Square, Chelsea, S.W.

The Report of the Finance Committee was presented by Mr. G. H. Skevington, and a cheque for £63 15s. was drawn to purchase Consols as an investment for the "W. B. Carr" Memorial Fund.

It was proposed by Mr. Reid, seconded by Mr. Skevington, and carried, that as the rules and other literature of the Association require revising, Mr. Garcke and Mr. Lamb constitute a committee to carry out this work and submit the same at next Council meeting.

Mr. J. Bee Mason kindly offered to provide at his own expense a bioscope entertainment of subjects connected with bee-keeping at the annual meeting in March next, and the same was accepted with thanks.

Next meeting of Council February 16, at 23, Bedford Street, Strand.

## LEGISLATION IN AUSTRALIA.

### NEW BEE-DISEASES ACT.

We have received the following letter from Mr. R. F. Beuhne, President of the Victorian Apiarists' Association. Mr. Beuhne also enclosed a copy of the new Bee-Diseases Act, which we print as being of special interest to readers at the present time, when the question of similar legislation is occupying so much attention among bee-keepers in this country:

DEAR SIR,—As there has been considerable discussion of, and opposition to, bee-disease legislation in the pages of your journal, it may interest your readers to hear that a Bee-Diseases Bill has just passed both Houses of the Victorian State Parliament without opposition.

The Bill is based partly on the New Zealand Act and partly on the results of the deliberations of our association. I may here state incidentally that during the whole time the proposed legislation

was before the bee-keepers of this State not a solitary voice was raised in opposition, either in the bee-journals or at meetings.

The regulations under which the Act will be administered have yet to be framed, which will be done in consultation with a committee of this association.—R. F. BEUHNE, Toobarac, Victoria.

### A BILL RELATING TO DISEASES OF BEES.

Be it enacted by the King's Most Excellent Majesty by and with the advice and consent of the Legislative Council and the Legislative Assembly of Victoria in this present Parliament assembled and by the authority of the same as follows (that is to say):

1. This Act may be cited as the *Bees Act 1910*.

2. In this Act unless inconsistent with the context or subject-matter—

"Disease" means any disease parasite or pest declared by the Governor in Council by proclamation to be a "disease" within the meaning of this Act.

"Diseased" means affected with disease.

"Prescribed" means prescribed by this Act or regulations under this Act.

3. (1) The Governor in Council may by proclamation published in the *Government Gazette*—

(a) declare any portion of Victoria in which any disease affecting bees exists and defined in such proclamation to be a "proclaimed area" under this Act.

(b) prohibit either absolutely or subject to regulations the sending or bringing of bees into any proclaimed area or the sending or removal from a proclaimed area into any other part of Victoria of bees comb or bee-hives in the opinion of the Governor in Council likely to spread any disease.

(2) The Governor in Council may at any time alter or revoke any proclamation under this section.

(3) Any person who is guilty of any contravention of any proclamation under this section shall be liable on conviction to a penalty not exceeding Twenty pounds.

4. (1) If an inspector certifies to the Minister in writing that any bees are diseased and in his opinion are a source of danger to other bees and ought to be destroyed, the Minister may make an order in writing directing the owner agent or person in charge to destroy such bees.

(2) If within seven days after the service of such order upon such owner

agent or person in charge the bees are not destroyed any inspector may cause the same to be destroyed at the cost of the owner thereof.

5. (1) An inspector may order any bee-hives fittings apparatus appliances utensils or other articles liable in his opinion to spread any disease to be cleansed and disinfected in such manner as he directs, and the owner agent or person in charge shall cause them to be cleansed and disinfected accordingly.

(2) Any such owner agent or person who refuses or neglects to carry out the direction of such inspector shall be guilty of an offence against this Act.

(3) If such inspector certifies to the Minister in writing that any of the articles mentioned in this section cannot be effectively cleansed or disinfected and that they ought to be destroyed such inspector may cause such things to be destroyed at the cost of the owner thereof: Provided that where the value of such articles ordered to be destroyed exceeds Five pounds this power shall not be exercised without the written approval of the Minister.

6. (1) On and after the first day of January One thousand nine hundred and thirteen no person shall in any district proclaimed under this section keep bees in any kind of bee-hive other than such as is prescribed.

(2) The Governor in Council may by proclamation published in the *Government Gazette* declare any district defined in such proclamation to be a district proclaimed under this section; and may at any time alter or revoke any proclamation made under this section.

7. (1) Any inspector may enter and inspect any premises where bees are kept and any bees bee-hives fittings apparatus appliances utensils or other articles used in connection therewith.

(2) No inspector acting in the execution of this Act shall be deemed to be a trespasser by reason of any entry or removal or destruction under this Act or be liable for any damage occasioned in carrying out the provisions of this Act unless the damage was occasioned by such inspector wilfully and without necessity.

(3) No person shall be entitled to receive any compensation whatsoever in consequence of any measures taken for the eradication of any disease or the destruction of any bees or any articles ordered to be destroyed under this Act or in respect of any damage that may result to him therefrom either directly or indirectly unless the same was occasioned wilfully and without necessity.

8. (1) Every person shall be guilty of an offence against this Act—

(a) who in any manner obstructs or impedes or attempts to obstruct

or impede any inspector in the execution of his powers under this Act: or

(b) who disobeys or fails to comply with any of the provisions of this Act or any direction or order given pursuant to such provisions.

(2) If any person is guilty of an offence against this Act for which no penalty is specially provided he shall for every such offence be liable on conviction to a penalty not exceeding Twenty pounds.

9. Subject to the Public Service Acts the Governor in Council may appoint as many inspectors as may seem necessary for carrying into effect the provisions of this Act and may remove any such inspectors.

10. (1) The Governor in Council may make regulations not inconsistent with this Act prescribing all matters which are required or permitted to be prescribed or which are necessary or convenient to be prescribed for carrying out or giving effect to this Act and for prescribing penalties not exceeding Five pounds for breaches of the regulations.

(2) All such regulations shall be published in the *Government Gazette*, and shall be laid before both Houses of Parliament within fourteen days after the making thereof if Parliament is then sitting, and if not then within fourteen days after the next meeting of Parliament.

---

#### THE B.B.K.A. LIBRARY.

The Secretary of the B.B.K.A. has received a copy of "The English Bee-keeper," date 1851, from an anonymous source. As he presumes it is intended to be a presentation copy to the library, he will be glad if the donor will send his name and address.—W. HERROD, 23, Bedford Street, Strand, W.C.

---

## Correspondence.

---

*The Editor does not hold himself responsible for the opinions expressed by correspondents. No notice will be taken of anonymous communications, and correspondents are requested to write on one side of the paper only and give their real names and addresses, not necessarily for publication, but as a guarantee of good faith. Illustrations should be drawn on separate pieces of paper. We do not undertake to return rejected communications.*

---

#### THE B.B.K.A. AND BRITISH APICULTURE.

[8028.] Referring to the B.B.J. (page 13) of January 12, the editor of the *Canadian Bee Journal* has indirectly paid a just and well-deserved tribute to the energy of an organisation

that is able to convince the bee-keeping world that Great Britain still leads in many matters apicultural, as she continues to do in numerous other fields of industry.

The steady, persevering nature of the average Britisher, and his frequent triumphant results, are often overlooked when the self-advertising pushfulness of members of some other nation may be glorized in big fiery letters upon the golden horizon of progress.

But it is not only our Canadian cousins who have appreciated the results of the early and continuous efforts of the original British Bee-keepers' Association, with which also the world-known name of Mr. T. W. Cowan has been associated from its commencement.

Years ago our United States friends woke up and realised the benefits the mother of bee-keepers' associations in the English-speaking world was conferring on the industry by holding annual exhibitions on a large scale, and by subsidising and otherwise assisting its daughter affiliated associations. Henceforth associations and exhibitions became great and invaluable assets of the community of American bee-keepers.

And yet to-day we are told by carping critics that the British Bee-keepers' Association has outgrown its usefulness. Can a parent institution with such an encouraging past and its golden present ever outgrow its term or sphere of usefulness? Our American cousins in following the same plans of exposition and organisation, and the commendations of our Canadian and other Colonial friends, show plainly that such cannot be the end, while British county associations owe their origin and the growth of their local apicultural industry to this sturdy parent.

But if the B.B.K.A. cannot carry out all the business its Council would like to see completed, that is solely the fault of the great community of bee-keepers and traders who do not realise that the present extensive development of the apicultural industry is largely the work of that association; hence is it their duty to support the mainspring of their interesting pursuit or business, as the case may be, so that further progress may be ensured.—SAMUEL STIMMONS, Heathfield.

#### NOTES BY THE WAY.

[8029.] The New Year has opened fairly well for the bees. We have had fine, sunny days during which they have taken wing in large numbers. I find they have cleared up the large cakes of candy given in mid-December, evidently preferring the candy to the stored syrup given earlier in the autumn. The candy being consumed calls attention to the fact that a further supply is needed, and advantage

should be taken of a suitable day to examine the candy supply and replenish it if required.

Mr. H. Reader (page 26) opens up a subject which cropped up in the early eighties of last century; then we tried to establish "The British Honey Company," but even under far more favourable conditions than those in the scheme formulated on page 26 the effort failed, and the shareholders lost all the money they put into the concern. *Experientia docet.*

*The McEvoy Method.*—The reply of our old friend "D. M. M." (8024) is not in his usual urbane style. Mr. Whyte and others, when writing on foul brood, often mention the "McEvoy" system of curing the disease, and if Mr. McEvoy's method is followed according to my reading of his assertions years ago, he does not use disinfectants. Therefore the New Zealand method, which I admit I should use myself if I was following the "shake-off" plan, is not the McEvoy system. The use of disinfectants is not part of Mr. McEvoy's method. He declares it is unnecessary to disinfect the hives, and only where any honey has been spat while manipulating does he advocate washing the interior. If I am wrong in my reading and understanding of Mr. McEvoy's written instructions, perhaps our friend will put me right.

The reply to "C. G." (column 2, page 30) is disquieting news to bee-keepers in the North. Chester-le-Street is some 300 miles north of the Isle of Wight. It will be interesting to know if the "Isle of Wight disease" can be accounted for in Durham, and how it got so far from the South. Perhaps "C. G." can throw some light on the probable cause of infection. I think every new centre of infection should be investigated, and every effort made to isolate and stamp out, if possible, this most malignant of bee-diseases. Foul brood is a small item in the economy of bee-life compared with this new insidious malady.—W. WOODLEY, Beeton, Newbury.

#### WORKING THE "WELLS" SYSTEM.

[8030.] I have much pleasure in giving Mr. Newman (8025, page 27) and any other interested readers further information with regard to the successful working of the "Wells" system.

My own hive holds exactly twenty frames and one thin division-board, but I should think one 25 in. long would do very well, as it would give just eight frames each side of the divider, which should be quite sufficient for ordinary purposes. I have never used sections on my double hive. I find the surface of twenty frames will not allow room for two full-size shallow-frame racks, so I make

one rack in each layer to hold only seven instead of eight broad-shoulder frames, which exactly fills the space. In the height of the honey-flow I have three supers of fifteen frames each (making forty-five in all), each rack in each layer communicating as described in my last letter (8010, page 514, vol. xxxviii.).

I should think, with only 25 in. space, it would be better to tier the section-racks one on top of the other (it would require about six, and how about lifts for all that lot?), but I am afraid in this case the bees would be more inclined to swarm than when the supers cover the whole surface.

I have never known the bees to fight either in the hive or in the supers.

I am told it is best for the entrances to be at each end, but mine are both in front (9 in. apart), with separate porches, the entrance being sunk back about 3 in.; they face N.W.

Referring to Mr. Crawshaw's remarks on page 500, vol. xxxviii., my division-board has a number of saw-kerfs: the bottom ones the bees leave free, but the top ones are always well stopped with propolis. I am trying to overcome this when cleaning the board in spring and autumn by smearing it thickly with vaseline. I think the more freely the heat is allowed to permeate the hive the better it must be for each division, especially in the spring.

With apologies for occupying so much of your valuable space.—W. G. FISCHER WEBB, South Croydon.

#### FOUNDATION AND FOUL BROOD.

[8031.] I notice a letter from Mr. J. Pearman in B.B.J. of January 19 (page 27), in which he states his opinion that foul brood is carried in the foundation used by the bee-keeper. I cannot agree with that statement, and take this opportunity of inviting Mr. Pearman to see the wax cleaned and sterilised before being used, when I think he will alter his opinion.

The process is as follows: The raw wax as sent in is thrown into a large copper tank holding about a quarter of a ton, a steam pipe is put in centre of tank, and steam turned on from a boiler under 80 lb. pressure to the square inch; this soon melts the wax and causes it to boil furiously, bringing it up to the same degree of heat as the steam itself. The tank containing the wax is then covered over and allowed gradually to cool down, when all impurities and dross sink to the bottom.

To cool such a large block of wax takes seven to eight days; the wax, however, is again melted and then suddenly chilled before being made into sheets for the

foundation. I think after such a sterilising process bee-keepers may rest assured that there is no risk of foul brood being carried in the foundation they use, providing the wax is treated as above.—E. W. TAYLOR, Welwyn, Herts.

#### FIGHTING AMONG BEES, AND DISEASE.

[8032.] My baby nucleus hive was a failure last year so far as the purpose for which I made it up was concerned (see B.B.J., page 396, 1909), the queen being small enough to pass through the piece of queen-excluder I placed over the entrance, yet she was one of four young queens that came off with two natural swarms which united. The following are notes which I took at the time, and may be of interest, as it will be seen I had a strange experience in connection with these bees:—

July 1.—I made up my baby nucleus hive. July 2.—Queen came out through the excluder as I stood by. After flying about a short time she alighted on my finger, so I had a good look at her; she was rather below average size. July 8.—Queen of baby nucleus hive came out at 3 p.m., and on the 9th she came out twice at about 3 p.m. This was the last time I saw her out. I think from the change in her manner she was mated on the 10th. July 30.—Saw young bees newly hatched in this hive. How often this queen may have flown out when I did not observe her I cannot say; but it will be seen by the date she was long in getting mated, the weather being unfavourable. The ease with which this queen passed through the queen-excluding zinc explains why brood may often be found in sections above the queen-excluder. But now comes the strange part of this hive's history, which I thought might possibly throw some light on the "Isle of Wight disease," and so, as you will remember, perhaps, Mr. Editor, I sent some dead bees for your inspection from this little hive last summer. August 6.—I to-day found the queen of this baby nucleus hive crawling on the edge of the water-trough two or three yards from the hive. I also found a lot of the bees, some lying dead on the ground, others, apparently paralysed, crawling slowly about. Some of these bees were shiny and dark, like robber-bees. On looking into the hive I saw the bees were fighting together, but apparently most of the old bees were gone. I returned the queen, and the little hive seemed to settle down quietly; but on August 9 I found all the bees gone, leaving sealed brood, larvæ, and honey in the comb. This did not appear to be an attempt at swarming, for I saw no appearance of queen-cells having been formed. Neither was it that they were

being robbed by strange bees, for there were no robbers about; the trouble seemed to arise among themselves. Several would be attacking one at a time, biting and worrying it till apparently they drove it out of the hive. Now as to the cause of this. Close by my workshop I have a row of black-currant bushes, and at their roots had been emptied the cleanings of the hen-house; these had become heated, and the effluvium was so powerful I could scarcely pass the spot. It seems to me the smell entered the hive and exasperated the bees in some way against each other. Is it possible that the same effect can be produced by bees returning home with some strong odour pervading them, such as that of guano, or some of the poisons that are used about fruit-trees, or weed destroyer, thus setting up fighting in the hive and the half-paralysed condition I found many bees in that were crawling on the ground below the entrance? I mention this case as it may be interesting to some, and may possibly throw further light on the subject of disease. It seems to me quite possible that some poison that bees come in contact with might produce fighting and also dysentery.—HUMBLE BEE, Allan Vale.

#### MID PIKE AND FELL.

[8033.] Nestled midst the verdant hills where Yorkshire and Westmorland combine is Ravenstonedale. Where all are beautiful it would be invidious to make exception, yet even in the land of hills and dales it would be difficult to find a more charming view than that of this village from the brow of Ash Fell. Half-hidden houses, the square-towered church, and the sheen of the silvery Lune—Lancaster's Lune—mingle in the mid-distance. Framing these are the surrounding woods, and the whole picture constitutes one of those delicious gems of northern scenery which haunt the memory long after the noisy city has again claimed one for its own.

It is possible to surfeit even of delicacies. *Toujours perdis!* A clause used to be inserted in the indentures of the London apprentices of old that they should not be compelled to eat salmon more than three days in any week. Even eternal bee-chat is an infliction. Physicians recommend an entire change as a recreation. An I could interest B.B.J. readers in the old customs and traditions, even the old inhabitants of this borderland of romance and fiction, it might not be found malapropos.

Turn back the pages of history to the days when might was right, and the longest sword with the strongest arm the readiest arbitrator. In hasty brawl in "Kirk-bee-Stephen" town the aggressor

has been slain. In "hot trod with horse and hound, and hue and cry," they chevy and chase the slayer over Ash Fell. Almost have they caught him, but by rare good fortune he has reached the abbey church of Ravenstonedale and tolled the bell. He is safe. No pursuer, nor even shire-reeve or King's officer, may molest him. Only a special commissioner of the "King's most excellent Majesty" may try him. Had his crime not been so grave, then twelve tenants of the abbey and the steward (for whom two rows of seats are reserved in the church) would have formed a jury to "clean or foul the bill against him"; and if he take oath that "hereafter he will behave himself well and faithfully" he may here end his days in peace.

The shield of the sanctuary intervened to shelter the weak has very ancient origin. Dumvallo Malmutius even in Druidical times ordained that the cities and temples of the gods should enjoy this privilege, and Lucius, first Christian king, confirmed this to Christian Winchester. A quaint old charter of Athelstan gives to Ripon Cathedral:

For ilke side ye kirke a mile  
For all ill-deedes, and ilk, agyle.

In 1470 Elizabeth, consort of Edward IV., took refuge in Westminster Abbey from her husband's enemies, and there "was lyghted of a fayre child," afterwards Edward V.; and I could quote many other examples.

We are apt to forget (it is so long ago) the incalculable debt we owe these monks of old. When, the Roman Empire being destroyed, Europe was but a seething chaos of barbarism, then the dim, flickering light of the lamp of learning was kept burning in the scriptorium of the monastery by the unselfish labour of the humble friar. Nowadays a book is written, and 1,000 copies are circulated in a few hours. A missal, a treatise, was in ancient days the work of a lifetime, pen-written from the illuminated title-page to the "s" in "Finis," priceless, its only reward the knowledge of a good work done.

Here is a copy of Thy Word,  
Written out with much toil and pain;  
Take it, O Lord, and let it be  
As something I have done for Thee.  
Longfellow's "Golden Legend."

I have wandered in many lands, and it has always given me a sad feeling to see these old abbeys crumbling to decay. Where once the chant was sung is now only the haunt of the owl and the bat, its columns desecrated by the inscription of Silas B. Jones, of U.S.A., recording the date when he "did Eu-rope." Even in our great cities I sorrow to see buildings in which history has been made

going, one by one, under the pickaxe of the housebreaker. "Old London," save for a few relics, is a thing of the past. You must search the *banlieue* of the Temple, or the narrow *rues* of the *Côte Gauche*, to find anything left of the Paris even of the days of the Huguenots. But he would be a *laudator temporis acti* (a praiser of bygone days) fossilised who would wish to stay the avalanche.

We read the records of the past, and sometimes we are inclined to smile at their mistakes (those patient students of old); but picture how they must have been hampered and baffled, not even having the mechanical means to investigate the secrets of the life of our little friend the honey-bee. Will some future generation consider us in the same light? We are after all but passers-by. The civilisation of the twentieth century may be as dark ages to the twenty-fifth. Ever, ever onward we travel,

And departing leave behind us  
Footprints on the sands of time.

—J. SMALLWOOD, Hendon.

#### CO-OPERATION FOR BEE-KEEPERS.

[8034.] Mr. Reader's recommendation (page 26) of a renewed effort to establish a limited company for the disposal of members' honey is, in my opinion, deserving of the heartiest support. The writer's plea is so convincing, and the features of his scheme are so practical and clear, that at this stage it is needless to add thereto. I hope the subject will be widely discussed and quickly assume a concrete shape. I suggest that every bee-keeper feeling an interest in the matter will communicate his views to the Editor—not necessarily for publication—so that the latter may be in a position to gauge the general opinion of his readers and advise accordingly. If the majority be in favour of the enterprise, a few zealous members of the B.B.K.A. might form a provisional committee and take the necessary initial steps. I believe a strong and influential company would spring into existence and enter upon a career of usefulness, to which the future invites it. I enclose my name and address for reference.—W. M. B., Newbury.

#### WIRING FRAMES BY ELECTRICITY.

[8035.] I should be grateful if Mr. D. M. Macdonald, Banff, would, in the pages of the B.B.J., state how the electric current is put through the wire (page 24), and if a dry battery is used, or what, as I am very anxious to do mine in the same way.—H. SIEBEL, Cheshire.

## Queries and Replies.

[4073.] *Bees Becoming Hybridised.*—I shall be obliged if you will kindly give me information on the following points: 1. Do golden bees change colour with age? Last summer I had two hives of goldens and one of blacks. The blacks started robbing, which I succeeded in stopping, but when I fastened all down for winter I found both goldens and blacks in all the hives. Last week I examined them to see that stores were all right, but could see no golden bees in any of the hives, yet all three stocks were quite strong and healthy. 2. Will it be advisable to provide some shade for the hives during summer? Mine have none whatever. I thought that perhaps two or three rows of artichokes, planted in front of hives and trained to allow free access of bees to hive, might be helpful.—H. A. B., Eastbourne.

REPLY.—1. It is very difficult to keep Italian bees pure in this country, and when hybridised they get darker. The presence of the goldens in all hives is on account of their sociability, which is a drawback so far as the spread of disease is concerned. 2. Yes, shade is helpful; but do not plant the artichokes too close to the hives: keep them 6 ft. or 8 ft. away.

[4074.] *A Beginner's Queries.*—I am thinking of starting bee-keeping, as we have a good garden and the neighbourhood appears to be suitable for the pursuit. I have read up a little on the subject, but should like to know more about it before investing any money. If you will kindly reply to the following questions I shall be much obliged: 1. Which is the best guide-book for a beginner? 2. Which is the best time of year in which to start? 3. What type of hive is best? 4. How shall I procure bees to stock the hive? I should also be glad to have particulars of the British Bee-keepers' Association. Thanking you in anticipation.—(Miss) R. T. R., Birmingham.

REPLY.—1. "The British Bee-keepers' Guide Book," by T. W. Cowan, Is. 8½d., post free, from this office. 2. In the spring with a swarm as early as possible. 3. The "W.B.C." hive is undoubtedly the best pattern in use at the present time. 4. You can either go to some reliable dealer, buy them locally or through our advertisement columns. See article on page 31.

[4075.] *Suitable Position for Hives.*—Would you, with your usual kindness, answer the following questions, as in this matter I am anxious to do the right thing? If I could keep my bees across

the top of my field I should be able to save a good bit of grass, and as I keep poultry as well I should be compelled to fence it off with wire-netting. 1. How far should the hives stand back from the netting? 2. Would it be any advantage to place the hives slantways to the fencing? 3. Would so doing in any way impede the flight of the bees?—S. A. D., Warminster.

REPLY.—1. If you put the netting 6 ft. from front of hives it will give ample room. 2. Yes. Facing south-east is the best position. 3. Not in the least.

#### FLOWERS OF JANUARY.

By "Lordswood."

January 19, a most lovely day. I went a long walk this morning, and could find only three flowers—groundsel, barren-strawberry, and a daisy. The bees from my sixteen hives were disporting themselves in the delicious sunlight. How glad they must be to unfurl their sails to the warm breeze and feel their feet on the petals of a sweet-scented flower!

There is nothing in the fields for them, I know, but in our gardens many things have flowered with unusual freedom—owing to the mild, open weather. A bed 16 ft. by 4 ft. of the Bath variety of the Christmas rose (*Helleborus niger*) has many thousand blossoms—wide-open cups against the dark brown earth-spread. A few sprays gathered, or even a few flowers set in damp moss, of the Japan allspice (*Chimonanthus fragrans*) will fill a room with fragrance. Showers of blossom are on the yellow winter jessamine (*Jasminum nudiflorum*), and tufts of scarlet—orange-scarlet—apple-blossom on *Syrus japonica*, right away from any protecting wall. What a lot of lovely things we have from the Celestial Empire; these, with lilacs and laburnums, hardy bamboos and gorgeous lilies!

One or two buds of winter aconite (*Eranthis hyemalis*), sweet-smelling *Daphne Mezereum*, rosy-lavender and white, *Crocus Imperati*, hardy cyclamen—these are nearly all that flower naturally at this season. There are many others, however, that have stray blossoms—snapdragon, stenactis, pansies, violets, primroses, polyanthus (quite a show), double daisies, rhododendron, hybrid pinks, *Geum coccineum* and *G. muricatum*, *Saxifraga Burseriana*, &c. The market is already gay with narcissi and daffodils, freesias and anemones from the Scilly Isles and South of France; so that here, close to a great town, winter has been reduced to two months or a little more. The odour of a bunch of jonquils which is borne to me as I write tells plainly that already the year is opening its great wide arms.—January 23. 1896.

#### WEATHER REPORT.

BARNWOOD, GLOUCESTER.

December, 1910.

Rainfall, 4.68 in.	55; in the year,
Above average, 2.55 in.	June 20, 79.
Heaviest fall, 7.3 in., on 15th.	Coldest night, 27th, 21; in the year, Jan. 26, 11.3.
Rain fell on 26 days.	Relative humidity, mean for month at 9 a.m., 87.
Total for year, 33.47 in., as compared with 26.82 in. for 1909.	Number of days with sky completely overcast at 9 a.m., 17; do. cloudless, 2.
Rain fell on 201 days, as compared with 187.	Percentage of wind force, 30.
Mean maximum temperature, 49.1; 4.1 above average.	Prevailing direction, S.W.
Mean minimum temperature, 38.5; 1.5 above average.	Mean daily height of barometer, reduced to sea-level, 29.72; .22 below normal.
Warmest day, 15th,	

F. H. FOWLER (F.R.Met.Soc.).

#### SMALL-HOLDINGS EXHIBITION.

An object-lesson in being, which is organised by experts in every branch of the work of the small farmer, will be seen in the Crystal Palace grounds this summer in connection with the Festival of Empire, and no detail of country life will be missing.

The small-holding section will, in fact, be laid out as a small-holders' colony and model village in miniature, set in London's most famous playground, and, what is more, it will be worked to show the small-holder the science of his industry and to reveal to the town-bred man how he may get back to the land.

Amongst other attractions, a small-holder's homestead is to be erected, and around it will be barns, ricks, cowyards, piggeries, sheep and goat pens, labourers' cottages, a dairy, stables, poultry-runs, duck-ponds, bee-hives, &c.

Beyond this, the land will be seen under cultivation, and special attention is being paid to intensive gardening, a science which we in this country have not yet grasped sufficiently. The small-holder of the rural districts, the artisan allotment-holder of the towns, and the gardener of the suburban villa will be able to gain in half an hour more vital, practical knowledge than could be acquired in a year from text-books.

There is also to be a congress held in connection with the Exhibition, and every society in the country which is interested in the question of the land will be represented.

In short, nothing that can tend to the advancement of the Empire's leading industry has been overlooked in the organ-



isation of this important section. It should be productive of the greatest financial benefit to the farmer and the small-holder who wishes to move with the times and equip himself to meet the increasing inroads of the foreign producer.

While there will not be a more pleasing or delightful section of the Festival of Empire than this Small-Holdings and Country Life Section, it must not be supposed that it is in any sense a side-show; it is a great national, officially-supported endeavour to save rural England.

## AMERICAN AND COLONIAL PAPERS.

### EXTRACTS AND COMMENTS.

By D. M. Macdonald, Banff.

*Controlling Swarming.*—The "Hand" device is receiving some attention in *Gleanings*. Hives are worked in pairs on one bottom-board. By means of a *switch*, adjustable from the outside, No. 1 receives the majority of the incoming bees. When it is very strong and likely to prepare for swarming, a large proportion of the bees are switched into No. 2, and the supers placed overhead in this division. It is presumed that the honey in the latter will be at once carried aloft to make room for the queen's accelerated egg-laying produced by the influx of bees. "When this flying bee-colony or No. 2 arrives somewhere near the swarming-pitch, its flying bees and its supers are switched back to the first hive. Mr. Hand feels that his plan of swarm control is a success, and that he has solved the problem." I hope so, but I have my doubts. To us in this country the system is nothing new. Simmins's "Double Conqueror" hive was arranged somewhat on this principle, but I never yet met a practical bee-keeper who practised the plan over a series of years. A few years ago I described a patent hive containing "switches" whereby the bee-keeper could arrange that his force of bees could be thrown at will into either of two divisions in his hive, and they could make their exit or entrance either by the front or main approach, or by auxiliary side-entrances.

*Winter Brood-chamber.*—"I am coming to the conclusion," writes Mr. Crane, "the larger chamber is more profitable (than a contracted one). My neighbour uses ten frames, and does not have to feed nearly as much in the fall for winter. There appears also to be less loss in wintering colonies with larger brood-chambers." I generally winter on eight, or at most nine, frames. Two neighbours winter and summer on ten. For several years they have come through the winter with less loss. Their hives are richer in stores in spring, and their bees are more numerous, while they un-

doubtedly work up to full strength at an earlier date. How do others find it? On both sides of the Atlantic, I know, contracting the hives for winter is advised, and I looked up two authorities to give their opinion first hand. On page 191 of "Guide Book" I find: "All combs not covered by bees on both sides should be removed, and the size of the hive reduced by division-boards placed on either side, so as to crowd the bees into as small a space as possible." On page 345 of "Langstroth on the Honey-Bee," latest edition, revised by Dadant, it is advised: "All empty combs, whether brood-combs or surplus-combs, should be removed from the hive previous to cold weather."

Now here is a very appropriate subject for discussion in this the dead time of the year. Should we have all the ten frames in the hive winter as well as summer, or should we contract our brood-chambers during the cold of winter to the number of frames actually covered by the bees when they are being winter-packed?

*A Lady's Ingenuity.*—At a recent Canadian Convention a lady, Miss E. Robson, read a taking paper on "Can a Woman Run an Apiary?" Some of her ingenious doings are very interesting, as the two following examples prove: "Being a woman, I found a hairpin a very satisfactory tool in queen-rearing. It was always convenient. It answered the purpose fairly well for stirring the royal jelly, but for lifting the larvæ and transferring to a new cell it was positively ideal." Here's another: "I had followed a swarm one fine Sunday, on my way to church, to a distance. When it settled it seemed a lot of trouble to go home for something to put the bees in, and I wanted to go to church. A happy inspiration came. I slipped off a skirt, tied a string round the top, making a bag of it, drew it over the branch, bees and all, fastened the bottom of the skirt at the other side of the swarm, then broke off the branch, and marched home triumphant. I went to church, too!" I would predict that Miss Robson will soon blossom into a very successful apiarist, judging by above examples.

The *Canadian B.J.* announces the appointment of Mr. W. White as assistant editor. Mr. White until quite recently was an English bee-keeper. In the November issue he says a good deal in commendation of the successful honey exhibitions held in the Old Country, and he specially praises the London shows.

*A Shield has Two Sides.*—Two writers in last *Australian Bee-keeper* supply me with food for thought. Mr. Beuhne records an average of 360 lb. from 172 colonies, and Mr. McIlveen contrasts a Scotch average of 50 lb.—which would

please me well over a series of years—with his "six times that amount." "Would that I were in Australia, with eucalyptus in its many varieties all round me!" I exclaimed on reading of the 300 lb. averages. But—well, here is the other side of the shield: "One bee-keeper had three left out of ninety colonies." "A fair price for honey is 3d. per pound." If the mortality is often so excessive and the price so low, Scotland, with its 50-lb. average, may come out on top in the end.

I was struck with Mr. Beulme's winter experiences. "In September the bees crowded two bodies. I finished in May with an average of 360 lb. per colony. The queens were laying from August, 1896, till May, 1898, the colonies strong all the time."

Nosema seems to be prevalent in Australia. They have also a *nameless* disease somewhat akin, it would appear. Some writers, indeed, wrote as if they deemed the "D.T." and Nosema were one and the same. Quoting a case where 996 colonies had died out of 1783, I may have unwittingly used words attributing this to Nosema. Mr. Beulme now points out that "no such proof has been established."

*Blacks for Maine.*—The *American Bee Journal* gives the following: "At our recent meeting of bee-keepers the question was asked, Which have you found the best bee, the black or Italian? Everyone who had tried them said the black or native bee was best. Let the Italians alone! Are we crazy up here, or does locality make a difference?" So it seems that even in the States bee-keepers can find some good in the much-reviled blacks.

*Non-Swarming Again.*—The same paper gives the "Allen" plan of non-swarming. It reads somewhat like our system of doubling or trebling as the bees increase, confining the queen, when swarming appears imminent, by excluder-zinc to the lower body filled with empty combs, with one comb in centre containing brood and the queen. In an article lately contributed to a farmers' annual I advised this plan for the busy farmer who can give little care or attention to his bees in the busy season. It requires a minimum of time with a maximum of surplus.

*Honey Selling.*—This subject still engrosses the attention of the *Review*, I think wisely. Many good bee-keepers are poor sellers, and the more tips we get about disposing of our produce the better. One of the articles advises a special *brand*, and the other uniform and medium instead of fancy prices. There is much in the "brand" idea; a good article advertises itself, and repeat orders come in year by year, with a tendency to increase annually.

## Notices to Correspondents.

R. W. (Rutherglen).—*Foul Brood and Disinfection.*—As you only repeat what you stated on page 8 of B.B.J., without bringing any further evidence to bear on the matter, no benefit would ensue by continuing the discussion. You say that the MacEvoy treatment does not include disinfection. You are right with regard to the treatment *per se* as recommended by MacEvoy, but Mr. Macdonald was alluding to the treatment in New Zealand, and he is therefore right in saying this *included disinfection*. Whether it is carried out in every case and by every inspector is irrelevant. There is no use quibbling over what was meant by either party, for it is quite clear; therefore no useful purpose can be served by repetition. If you have any fresh evidence to bring forward to show that disinfection is not necessary we shall be pleased to have it, and it can be discussed on its merits.

S. L. H. (Walthamstow).—*Wintering Driven Bees.*—It will be wise to give them candy. It should be put over the feed-hole in quilt, choosing a fine, warm day for the operation.

### Honey Samples.

C. R. C. (Tooting).—The sample is a very nice lime-honey.

W. G. (Lancs.).—The flavour, aroma, and colour of your honey are very good. If you can get honey like this you ought to do well with your bees. We are pleased to have been of service to you.

H. W. B. (Holbeach).—The honey is from lime-trees, which has a strong distinctive flavour not always liked by those unaccustomed to it. We consider it a good sample.

### Suspected Disease.

H. G. G. (Farnborough).—The bees have died from "Isle of Wight disease."

BALDEA (Lancs.).—1. Bees are affected with "Isle of Wight disease." 2. Wintering with glass quilts over the frames is not a good practice, as it does not allow of sufficient ventilation.

C. C. W. (Cornwall).—1. No. 1 comb is infected with foul brood. 2. The other combs contain adult bees which have died from starvation. This is readily seen by the numbers dead head downwards in the cells. 3. The bees in boxes have died from "Isle of Wight disease."

J. T. (Barnoldswick).—From your description, the bees may be suffering from "Isle of Wight disease." If you send us a few of the bees we will examine them; also please say where the driven bees were obtained.

## Editorial, Notices, &c.

### PROMINENT BEE-KEEPERS.

MR. F. W. L. SLADEN, F.E.S.

Mr. Frederick William Lambert Sladen, of Ripple Court Apiary, near Dover, whose portrait we have pleasure in presenting to our readers, and who is known as the originator and breeder of the "British Golden" bees, was born on May 30, 1876, at Shooter's Hill, Blackheath. He is the son of Lieut.-Colonel J. Sladen, R.A., and his mother, Lady Sarah Sladen, is a daughter of the eighth Earl of Cavan. He was privately educated, commenced bee-keep-

acquaintance with the subject far beyond his years, which gave promise that if he took up bee-keeping he would some day rise to prominence. He did become interested in the science, and visited India in the winter of 1896-7 to investigate the honey-bees of that country. He found *Apis dorsata* and *A. florea* useless for domestication, but brought home alive a queen of the Himalaya honey-bee. On his return from India he decided to take up bee-keeping as his calling, and went in for honey-production on a large scale. Finding English-Italian hybrids to be larger honey-producers than native blacks, he decided to breed them for sale. Close observation, with a study of the laws of heredity and the work of breeders



MR. F. W. L. SLADEN, F.E.S.

ing at the age of thirteen, and soon after he began to study wild bees, especially the humble-bee. Our attention was first drawn to Mr. Sladen in 1892, when we saw in the daily papers a notice of a small book of forty pages written by a "young naturalist," and entitled "The Humble-Bee." We sent for the book, and were much gratified by its perusal, as it was perfectly unique, inasmuch as it was altogether the production of the author, not only the writing and illustrations, but the printing (by stylography) and the binding. Although Mr. Sladen was only sixteen years of age, in this work, written from actual investigation, he showed an

of other animals, as well as of plants, led him to the conclusion that a distinct breed of bee selected for the production of honey in the English climate should be superior to the Italian for crossing with the English bee. The great difficulty of producing and maintaining such a breed in England, where isolation is unobtainable, Mr. Sladen overcame by the aid of a distinctive colour, obtained by cross-breeding his hybrids with American Goldens, and the new variety was introduced under the name of "British Goldens." This variety is now bred in its purity year by year in Ripple Court Apiary, the present generation (1910)

being the result of selection strictly carried out through eight successive generations, and shows many qualities not possessed by foreign bees. "British Goldenes" have proved a success in spite of much criticism from those who hold the opinion that there can be no better bee for the British climate than the native black, and also from advocates and breeders of "three-banded" Italians. Mr. Sladen believes that for progress in bee-breeding purity of stock is essential, and has shown that three-banded bees—even the brightest—are indistinguishable from hybrids, so that it is as impossible to breed in England a pure three-banded race distinct from the ordinary bee as it is to breed a distinct pure black race. As a matter of fact, "British Goldenes" are the only yellow bees bred in England without reinforcement with foreign blood. A year ago Mr. Sladen published in the B.B.J. (December 9, 1909, page 482 *et seq.*) an account of his bee-breeding work, giving figures which not only prove the truth of his claim that he has succeeded in breeding bees by selection, but show how he has done it. He has thus worked out a system of queen-rearing which under the trying conditions of the British climate produces thoroughly well-developed queens, and has invented several appliances for use therewith.

In 1901 he discovered the function of Nassanoff's organ, a membrane situated at the base of the sixth dorsal segment of the worker-bee. Mr. Sladen found that the bee, in her joy at finding herself unexpectedly in the vicinity of her home, exposes the membrane and emits from it a pungent odour, which attracts other bees searching for the hive, thus saving much loss of bee-life (see B.B.J., vol. xxix., page 142). In the autumn of 1901 he made a tour in America, visiting the A. I. Root Company's establishment and several prominent bee-keepers, including Doolittle, Benton, Pratt, and Captain Hetherington.

In 1902 Mr. Sladen married Miss Violet Barton, daughter of Captain C. R. Barton, D.L., of Pettigo, Co. Fermanagh, Ireland, and has two sons. He has gained several first prizes from the B.B.K.A. for scientific exhibits connected with bee-keeping. Mr. Sladen has also successfully shipped both "British Goldenes" and queens of foreign races to India, Ceylon, Java, Uganda, Pretoria, and the Seychelles, and has also been successful in sending humble-bees to New Zealand. With regard to the latter, it may be noted in passing that *Bombus terrestris* and *B. ruderatus* were introduced into New Zealand as a result of shipments made in November and December, 1884, by Messrs. Nottidge, Dunning, and Baldwin. *B. terrestris* having been

found to injure the flowers by biting holes in them, Mr. Sladen was asked to ship other species to compete with it. His shipments made in 1905 and 1906 consisted largely of *B. lapidarius*. He was fortunate in having a loss by death on the voyage of only about 40 per cent. of the queens, the 1884 shipments having sustained a loss of about 80 per cent.

Mr. Sladen has been for some years a contributor to the B.B.J., and wrote a series of articles on "Our Wild Bees," his writings being frequently illustrated by himself. His work on "Queen-Rearing in England" originally appeared in the B.B.J. in March and April, 1904, and was published in book form in 1905. A German edition, translated by Pastor Strauß, appeared recently. He has also contributed the "Hymenoptera of Kent" to the "Victoria History of the Counties of England," and has worked out the life-history of *Psithyrus* and added to the knowledge of *Bombus*.

We hope that Mr. Sladen may long be spared to continue the useful systematic work that he has undertaken, which must result in great benefit to the industry.

---

#### REVIEW.

*Vergleichende Untersuchungen über das Gehirn der Honigbiene.* By C. N. Jonescu (published by Gustav Fischer, Jena. Price 40 marks—£1 19s. 6d.).—In this monograph, which is published in the *Jenaische Zeitschrift für Naturwissenschaft*, C. N. Jonescu, after reviewing the work of previous investigators, gives a detailed account of the complex brain of the honey-bee. This, as is known, varies in the three bees, the brain of the queen being the smallest and that of the worker the largest. In the drone, which has a very large head, the optic lobes are large, but the actual brain is no larger than that of the worker. The author describes the origin of the various nerves proceeding from the brain, and shows that the "pedunculated bodies" (*pilzhutförmigen Körper*) described by Dujardin in 1850, and which he thought were the seat of intelligence, with which the author agrees, differed in size in the different bees. They are smaller in the queen and drone than in the worker, those of the drone being relatively the smallest. The optic lobe is a lateral extension of the procerbrum, and consists of an outer cell-layer and an inner subdivided fibrous mass. The position of the brain in the head varies in the different bees, as may be seen by the sections given to illustrate the fact. In the drone the brain is close up to the front of the head, and in this position it gives room for the development of the compound

eyes, the ocelli occupying quite a different position from what they do in either the queen or worker. The author thinks that the ocelli of the drone serve the purpose of enabling him to follow closely the queen in her wedding-flight, and he agrees with Büttel-Reepen as to these simple eyes being used for near vision. The denticerebrum is next fully described, and the nerves proceeding from it minutely traced. These are in connection with the antennæ, which the author shows to be highly-specialised sensory organs. He also agrees with Büttel-Reepen, who has shown that bees have a very keen sense of sight and hearing. The antennal ganglia vary in the different bees, and are smaller in the queen than in either drone or worker, which are nearly equal in size, although the inner structure shows a remarkable difference, it being less complex in the drone than it is in the worker, showing that the sensory organs are not nearly so highly developed in the former as in the latter. The sense of smell also is very highly developed in the worker, which has to discriminate between the odour of the brood-nest and of wax, blossoms, and honey, although in the case of flowers sight helps in their discovery. Probably also the distinctive odours of the larvæ and chrysalids have to be taken into consideration. M. Jonescu concludes by saying that although we cannot accurately ascribe all the complex organisms of the brain to certain functions, the differences in the brain of the drone, worker, and queen clearly show that they are adapted for different uses in each. The work is profusely illustrated, there being four folding plates containing forty-five illustrations, many of them series of microtome sections, besides thirteen figures in the text, which consists of seventy-five closely-printed pages. It is a work which anyone studying the brain of the bee should consult, as the author, with the improved appliances at his command, has been able to go further into the subject than previous investigators.

#### B.B.K.A. LIBRARY.

The following books have been presented to the Library by Mr. T. W. Cowan:—"The Honey-Bee," by E. Bevan, M.D. (1827); "Bees and Bee-keeping," by F. R. Cheshire, vol. 2 (1887); "Beeswax," by J. Demmler (1889); "Bjør og Honning," by H. Hovind and E. Hansen (1894); "Die Rassenzucht der Schweitzer Imker," by Dr. U. Kramer (1908); "Wintering Bees," by T. W. Cowan, third edition (1886); "Doubling and Storifying," by T. W. Cowan (1887); "Förer i Biavl efter," by T. W. Cowan and H. Eisler

(1887); "Ronkovodeetel Angliskavo Ptschelovoda," by T. W. Cowan and A. Zoubareff (1887); ditto, second edition (1890); "La Cire," by T. W. Cowan, translated by E. Bertrand (1911); "Die Honigbiene," by T. W. Cowan and C. J. H. Gravenhorst (1891); "Führer des Englischen Bienenzüchters," by T. W. Cowan and Tony Kellen (1891); and "Handleiding bij de Moderne Bijenteelt," by T. W. Cowan and G. F. W. Kehrer (1903).—W. HERROD, Secretary.

#### EARLY POLLEN-GATHERING.

Owing to the mildness of the weather, crocuses and other spring flowers are now in bloom, and last Saturday (January 28) our bees in Somersetshire were returning to their hives laden with pollen. Although they have recently had several cleansing-flights, this is the first time this year that we have noticed the bees collecting pollen.

#### AMONG THE BEES.

##### THE PASSING OF THE SKEP.

By D. M. Macdonald, Banff.

Recently several correspondents condemned the use of the skep in testing candidates for experts' certificates. As these are obtained with the intention of advancing *modern* apiculture, I confess to a considerable degree of sympathy with the contention that they are a thing of the past and out of place in this twentieth century of ours.

The "Guide Book" describes the skep as "steadily dying out," and affirms that the frame-hive is "indispensable to profitable apiculture." "Modern Bee-keeping," published for the B.B.K.A., informs us that "the Association is labouring for the introduction of the frame-hive among all classes of bee-keepers," and as a corollary for the *suppression* of the skep. That is as it should be.

None of the numerous "Homes of the Honey-Bee" which have appeared in the B.B.K.A. has consisted of skeps, and when a sample of this nearly obsolete receptacle has appeared it has been relegated to some quiet, obscure corner, showing that in the higher walks of the cult skeps have ceased to be favoured. No prizes are awarded to them in any leading show, and they bulk little, if at all, in dealers' catalogues. In this country a beginner never thinks of starting with skeps.

Yet we all know they still remain prime favourites with many keepers of bees. They cling to this old-fashioned hive as if it were part of our institutions. Their

forefathers kept bees in them, and they go on keeping them.

Why? One can give no reason. A second has been taught bees are *more comfortable* in straw homes. A third believes they require *less management*. Lastly, many hold that the start and subsequent *outlay is less* than with frame-hives. Time is the only cure for the first class. The Grim Reaper will gradually eliminate them. Bees kept in any good "W.B.C." hive can be kept as warm and comfortable as in any straw hive, in spite of the claims of Class 2. Ventilation can be as perfect, and as the brood-nests can be enlarged or contracted they have an immense advantage. With the third class, who believe in the sealed book of the straw skep, "management" is at a discount. It consists in running in a swarm, letting the bees work their own sweet will, and appropriating their hard-won spoils after cruelly consigning the denizens to the nauseous sulphur-pit. The frame-hive, on the contrary, is an open book, from whose pages we can read the life-history of the inhabitants, and as all is manifest before our eyes we can right what is wrong.

There remains, therefore, only the fourth reason—expense—to justify even the existence of the straw hive. If I can show, as I mean to do, that the fancied cheapness exists only in the imagination, I shall have put in a strong plea for the *passing of the skep* into the limbo of forgetfulness. I hold strongly that the only fit place for them in a modern apiary is in the bee-museum!

In the "Practical Note-book" will be found an illustration and full directions for making a cheap hive constructed from used boxes. The hive consists of a stand, floorboard, outer case, brood-chamber, lift, and roof. As full working instructions are given, anyone who can handle tools can have a comfortable hive, all but the frames, for the low figure of 1s. 1d.! Where can a good straw skep be purchased for the money?

The "Goodall" hive illustrated on page 366, vol. xxv., is made for 2s. 6d., and is described as "a perfect hive, suitable for any purpose." It is constructed of bacon-boxes, and the "inventor" considers it "equally suitable for the gentleman's garden and for that of the cottager," and for the latter procurable at the cost of the honoured skep.

The "Tomlinson" hive shown on page 5, vol. xxxii., looks a solid structure, and the cost is only 1s. 3d. These were made from specified boxes, amongst them Ceylon tea boxes. A Northern bee-keeper some time ago wrote me favourably in regard to his "tea-box hives."

Recently I discovered a first-class cheap

hive made from empty dynamite-cases, and I was so much taken with it that I had one sent to me for showing off as a model hive for any who may henceforth start bee-keeping on modern lines. Readers will remember seeing the neat apiary shown on page 467 of our last volume, belonging to Mr. James Henry, Egremont, Cumberland.

The hive is a true "W.B.C.," and consists of (a) stand, (b) floorboard, (c) entrance-slides, (d) outer body, (e) inner body-box, (f) shallow-frame box, (g) two section-racks, (h) two lifts, (i) roof, (j) two dummies, with a second brood-chamber for doubling. The workmanship does Mr. Henry infinite credit, and stands favourable comparison when his hive is placed alongside some appliance dealers' specimen hives. When such a splendid hive can be made at a charge of under 2s. for materials, nobody need start bee-keeping with such an out-of-date article as a straw skep. Mr. Henry, in



A TWO-SHILLING HIVE.

Made by Mr. J. Henry.

forwarding me the hive, wrote: "If any bee-keeper can make a frame-hive like this for the price of a straw skep, I see no reason why he should not adopt the frame-hive. I have yet to see the skep that will enable the bee-keeper to take off 70 lb. of surplus in as marketable a form as my hive. Wood for making these hives can be obtained in any mining or quarrying district where explosives are used, although the price may differ slightly. I may say that the 'W.B.C.' hive is an ideal one." The elegant appearance of the apiary as a whole, and the illustration accompanying this article kindly provided by the Editor, show that the hive is one suitable to appear and hold its own in any apiary. Further particulars may be given later, if desired, as the hive is well worth prominent notice.

## Correspondence.

*The Editor does not hold himself responsible for the opinions expressed by correspondents. No notice will be taken of anonymous communications, and correspondents are requested to write on one side of the paper only and give their real names and addresses, not necessarily for publication, but as a guarantee of good faith. Illustrations should be drawn on separate pieces of paper. We do not undertake to return rejected communications.*

### MOVING BEES IN MINNESOTA.

[8036.] I bought an apiary last summer, and I enclose a description of the moving:—

The bees were located a distance away of some thirty-five miles. There were forty-three colonies, besides other appliances, hives, extractor, &c., to be brought here. It was June 1, and not much honey in the hives. The first day was spent in the outgoing journey, and until far into the evening preparing the bees for moving. The bottom boards were securely fastened to the hives with large staples. Wire-cloth was tacked over the top of each hive, and  $\frac{1}{2}$ -in. strips put between this and the covers so as to give ventilation. The team was a fine span of heavy black horses, and the wagon had on it a large (16 ft. by 8 ft.) square box hay-rack. This rack was on springs, but in order to lessen the jolting straw was placed under the hives in the rack. The hives were placed in rows close together, with wide, long boards on top of each row, and another row on top of them. Thus everything was closely packed in the hay-rack on the wagon. All was ready to start home about 3 p.m. the second day. Ten miles were made that night, and I put the team in until the next morning. The third day in the evening the bees had reached their new location. Everything passed off finely, except that a heavy rain made the roads slippery and harder work for the horses. The load was left quietly upon the wagon until the next day, when the colonies were located for the summer. In moving bees the following points seem to be important:—

1. It is an advantage if the moving can be done when the colonies have little honey, as they are more easily lifted.

2. The bees should be securely fastened in the hives, and great care taken to provide them with good ventilation.

3. The men doing the work should move with firm, steady action, taking great care not to disturb the bees needlessly.

4. The hives should be closed up at night when the bees are all inside.

5. In handling, and upon the wagon, all jolting and shaking should be reduced to a minimum.

6. If the frames are not pretty close together, secure from moving, they should be fastened so that they cannot rub together.

The bees began working as soon as they were released. After a couple of days' house-cleaning they seemed at home, and soon commenced bringing in honey. The moving was in every way successful, but last season was not a good one, so I have no large results to report.—EDWIN EWELL, Waseca, Minnesota.

### PARTHENOGENESIS.

[8037.] "D. M. M." is right, in spite of Mr. Crawshaw's surprise, in saying that "one sexual intercourse is sufficient to fertilise the eggs of numerous generations of aphides." For about ten generations during the summer all the aphides are females, and all produce young.—G. G. DESMOND, Camberwell.

### SOUTH AFRICAN BEE-KEEPING.

[8038.] Bee-keeping is going ahead strongly in this, one of the finest countries in the world for it. It received a check when a year ago the Act prohibiting the importation of bees, honey, wax, and foundation came into force; but it has recovered from this, and there is plenty of first-class foundation now being made here.

In a quiet way, Miss M. D. Sillar, the Government apiarist, has been doing good work in the Orange Free State, and the result of this must react in the future in the establishment of apiculture on a firm basis as an important rural industry. Personally, I am optimistic about it as a commercial proposition when we understand it from a local point of view more thoroughly. At present we are all beginners under new conditions, and what we have to ascertain is how best to adapt European and American methods to suit those particular conditions.

My association is doing good work in collecting information from all over the country in its monthly journal the *Agriculturist and Stock-Breeder*, copies of which you should now be receiving monthly. We have a whole lot of things to find out, such as bee-flora, best size of brood-chamber, &c., but we hope to get nearer our goal as time proceeds. We are having an important conference here in April next, the effect of which, I trust, will be to assist us considerably in our efforts.

You should within the next fortnight receive the report of the general meeting held in December last, which will give you a fair indication of the association's prospects.—H. F. BENDER, Hon. Sec. South African Bee-keepers' Association.

## WORKING OF THE BEE-DISEASES PREVENTION (IRELAND) ACT.

[8039.] *Re* above, I must thank your correspondent "Buzz Bee" for his reply (8021, page 15). I hope he read Mr. Crawshaw's most sensible remarks on page 16: "And there is, to my mind, little question that spring and autumn are the most practical times for the work." With regard to "Izal," "Buzz Bee" allows it is more convenient than carbolic acid. He might have added, and a far more powerful disinfectant, in usable proportions. I know all "authorities" do not agree as to its curing foul brood, but I also know that many experienced and expert bee-keepers have complete faith in it. Mr. Pearman's reference to it in B.B.J. of January 19 (page 27) is instructive; I believe he is not exactly a novice. "Buzz Bee" says it cannot be called a cure, because all combs containing spores must be removed. I wonder who suggested such a course! Certainly I never did. My reference to "the disease breaking out again after an apparent cure" was an attempt to explain cases which I have seen mentioned in B.B.J., but which have not come under my immediate notice. I now see "Buzz Bee" really means, when he says *all* signs of foul brood *may* have practically disappeared, that only a few cells with dried scale *may* remain, and I venture to think these would not escape an expert's notice in the autumn, especially if the hive had been without a laying queen during July, as suggested. Alternatively, the disease might not be discernible if a bee-keeper had practically cured it, but surely such cases do not require consideration. I thought the act was supposed to be directed against those who delight to have their hives rotting with foul brood, and who will not have them touched for any consideration.—R. B. DART, West Horsham.

## FERTILISATION OF QUEENS.

### FOUL BROOD AND COMB-FOUNDATION.

[8040.] A novice might make mistakes such as Mr. Salmon instances on page 15 (B.B.J., January 12), but for anyone to insinuate that these blunders are liable to be made by bee-keepers who have had as much practical experience as I have is quite out of the question. The hive alluded to was provided with ample stores for winter, and had exactly the same normal treatment as all my other stocks. Upon looking up my diary I find I inspected my bees from March 28 to 30. Not from this time onward until some time in the beginning of May was the hive again inspected, being the first

opportunity I could grasp on account of the adverse weather conditions. The queen being aged (1906) and apparently worn out, accounts, in my opinion, for the whole irregularity.

With all due deference to "Mr. Cowan and his colleagues of various nationalities, who have devoted a lifetime to research in a scientific and practical way," such a coincidence might baffle the wit of "L. S. C." (who, by the way, I am glad to learn is possessed of a queen whose price is far above rubies—Prov. xxi. 10). Perhaps the level-headed "D. M. M." will prove conclusively that the "exception proves the rule," even amongst the works of creation and Providence.

*Comb-foundation.*—Another fact which is not generally accepted is as follows: Two or three seasons ago I inserted comb-foundation between frames of *old* combs. Several of these sheets of foundation developed black brood in a good many cells *the first time bred in*, while the old brood-combs alongside were intact. Is this not proof positive that the wax had not been thoroughly sterilised? The foundation was that of a well-known American manufacturer, where (in America), as you are well aware, black brood is very prevalent.—Scot.

P.S.—Since writing the above the B.B.J. has just come, and in it I notice Mr. Pearman's remarks (8026) on the same subject. I agree with him "up to the hilt" that foul brood is caused through infected foundation, and entirely disagree with Dr. Maassen's evidence which you quote.—S.

[We can only repeat that the danger of infection by comb-foundation is very remote. There are hundreds of bee-keepers who have used comb-foundation who could record the same experience that we have had, and were this danger common we should have heard more about it. Knowing as we do the extreme care with which all such investigations are carried out in Germany, we do attach some importance to Dr. Maassen's reports; but, of course, anyone who likes is quite at liberty to differ.—Ed.]

## CONTROLLING SWARMING.

### THE "HAND" DEVICE.

[8041.] In your issue of January 26 (page 39) Mr. Macdonald says that he has never yet met a practical bee-keeper who practised the "Hand" device over a series of years. Would he kindly inform us why they abandoned the plan, as I, personally, was thinking of experimenting with it this year?—B. B., Rams-gate.



## Queries and Replies.

[4076.] *Spring Feeding—Re-queening.*  
—1. I have 3 pints of syrup left over from the autumn. How much water will be required to make same suitable for spring feeding? 2. Do you recommend Mr. Simmins's system of rapid feeding for the spring? 3. Which do you think most effective when driving bees—the ordinary smoker or the carbolic solution? 4. One of my hives contains a 1909 queen. If a swarm issues, and I kill the queen and then return the swarm to the hive, would that not answer the purpose of re-queening with a young queen? To my mind, it appears an easy and safe way to re-queen one's stocks. What is there against it? Is it not possible for you to devote a column in the good old B.B.J. giving weekly advice to beginners, &c., such as what to do each week throughout the season? It would be a great help to beginners and interesting to one and all, as there would sure to be several little hints the "old hands" could pick up and take advantage of.—J. S. W., Suffolk.

REPLY.—1. Add  $\frac{2}{3}$  pint of water, and the syrup will be fit for spring food. 2. No, slow feeding is best. 3. We prefer to use the smoker. 4. Your plan is an easy one so far as re-queening only is concerned, but it spoils the stock for honey-getting. A much better method would be to make a nucleus when queen-cells are built. This would check swarming, and you could give the stock a young queen by uniting the nucleus to it as soon as the honey-flow is over. We thank you for your suggestion, and had already decided to do something of the kind this year, as we quite agree it would be helpful to beginners.

[4077.] *Pollen-mites.*—I am sending you some pollen shaken out of combs put away last autumn, but not sterilised, and you will see that the pollen is full of little insects something like cheese-mites. They do not appear to be destroying the comb, but only the pollen in it. Do you consider that they would be injurious if the combs were given to the bees as they are, or would the bees destroy the insects? Is it usual for pollen in combs to be so infested? I am much interested in "D. M. M.'s" reference (January 19, page 24) to embedding wires by an electric current, and should be glad if he could tell me through the B.B.J. how a current of 110 volts from a dynamo for lighting purposes could be utilised for doing the work.—W. A. C.

REPLY.—The creature you mention is the ordinary pollen-mite. If much infested, it would be best to melt the combs down. If the mites are few in number, jar the combs slightly flatwise to knock

out all the dust you can, after which they can be used again.

[4078.] *Bees Dying in Well-provisioned Hive.*—I only began bee-keeping last year, and am much in want of advice. I should be very glad if you could tell me why these bees which I enclose have died. They were in a large box, 13 in. deep and 12½ in. square (inside measurement), with old black combs, and were put to transfer themselves over a "W.B.C." body-box, with frames and foundation, in May, 1910. The bees did not draw out any of the foundation until late in the summer—August, I think. I then drove the bees and put them below with a queen-excluder and a quilt, with a hole for passage in the latter about 3 in. square. In September I found bees and eggs in both the frames and in the upper box, so I concluded there were two queens. I fed the bees during the end of September and in October with good cane syrup. To-day, on looking at the hives, they all seemed very lively except this one, which had no sign or sound of life, so I opened it. I found a large heap of bees dead on the floorboard and swarming with living maggots, a few bees dead in the frames, and a few dead in the upper box. There are plenty of sealed stores in upper box all along the top—quite enough to last till May, I should think; so the bees are not starved, unless the stores were too far away from the cluster. My idea is that there were two queens, and that the bees fought and became so reduced in number that they were not warm enough in such a large space. They were not well packed, as it was difficult to wrap up the upper box; the lower one had plenty of quilts. I shall be deeply grateful for help and advice in this matter of diagnosis; also if you could tell me what use I can make of the combs with honey. Can I use them for feeding in any way? Is there danger of infection of any sort? I have never seen foul brood, but there are no eggs anywhere in any part of the hive.—THEODOSSIA, Millbrook.

REPLY.—The bees have died from starvation, the stores being too far away for them to reach. You can use the combs containing food in other hives with safety.

[4079.] *Spraying Fruit-trees and Bees.*  
—I wish to ask the following question, and shall be glad to have an answer in the B.B.J. in due course: If Paris green in an insecticide is used on fruit-trees before the flower-buds burst, is it liable to poison bees when visiting the flowers later?—F. A. A., Warminster.

REPLY.—If used before the flowers open, insecticides will not injure the bees.

[4080.] *Best Bee for Out-apiculture.*  
—A swarm of bees alighted in my

garden last June, and never having seen such a thing before in my life, with the assistance of a friend I got them hived in a skep, consulted my newsagent, and subsequently became an ardent reader of the B.B.J., and have learnt all I know from same. I transferred the swarm to a bar-frame hive, and fed them up in the early part of September last, and they are doing well, for yesterday being a warm day, they were out for a cleansing-flight in hundreds. I hope to establish an out-apiary in the country, and, not knowing the best bee to stock it with, would be gratified to learn through the medium of your journal.—R. PICKETT.

REPLY.—Ordinary British bees are most suitable for this country.

### CAPPINGS OF COMB

BY L. S. CRAWSHAW, NORTON, MALTON, YORKS.

*Foul Brood in Belgium* (page 4).—The title of this paragraph is something of a misnomer, as owing to the efforts of the bee-keepers foul brood is non-existent. I am unfamiliar with the history of the movement, but, reading between the lines, it appears that the bee-keepers were a law unto themselves in the matter, and prosecuted the work with such energy that a few years sufficed to free them from disease. Whether the Government assisted them with legislation as well as by grants is not actually stated, and it would be interesting to know. Also, whilst the whole of the associated members were insured for a trifling sum of 5d. per member, it is not stated whether compensation was paid to uninsured outsiders. Perhaps there were no outsiders. Without legislation, compensation of outsiders would almost necessarily follow, and fuller details of the scheme which effected such great results would be welcome. One thing is quite clear, and that is the co-operation of those concerned enabled the community to rid itself in a short time of the menace and hindrance of foul brood—a result which would quickly repay whatever was expended upon compensation.

*Bee-notes from Germany* (page 5).—This very interesting letter from Herr Linde leads one to hope that we may be privileged to have more from the same source. The writer, however, seems to me to confuse the issue of protective tariffs with that of pure food laws, which is a pity. It is not clear how the consumer (the English buyer?) pays the export bonus on German sugar; and Protection, whatever its faults, can hardly, as he implies, assist the Chilian honey by raising its price! We in England get some of this honey, and, whilst it may do

for manufacturing, it is not a good table-honey, and chemists, in my opinion, do harm to the sale of honey by retailing it. For it is not a help-yourself-again honey, and its low price discourages buyers from purchasing a better variety. Only the other day I was given a good-looking honey, of soft granulation, which was undoubtedly a blend of West Indian honey and English clover honey. It was attractive in appearance, but had the unmistakable flavour of the Transatlantic honey. Yet the buyer had been given the impression that it was Norfolk honey, and had bought retail at 6d. a pound. How are we to compete with this class of trading?

*A Heather-honey Extractor* (page 5).—I should like to see this machine. There seems to be a good deal of labour and care involved in the process, and it is doubtful whether it is worth while to adopt it when considering the lower price and reduced attractiveness of the extracted product.

*Foul Brood Legislation* (page 7).—Here is a letter from Mr. Isaac Hopkins, who is at least in a position to speak authoritatively of the working of a Foul Brood Act. I do not think that he quite does justice to Mr. Samways' sincerity. But however that may be, it is interesting to note another contribution to those we recently had upon the subject. It will be noted that in no case where legislation has been tried has there been any allegation against the benefit derived. Yet in spite of all this practical testimony we are still in the stage of being obliged to expend ammunition upon bogeys. The worst of it is that these bogeys are occasionally erected by men of undoubted practical ability and common-sense.

*Granulated Honey* (page 12).—I have sometimes wondered at the preference which is shown for liquid honey. For my own part, I think that a good grade of granulated clover-honey leaves little to be desired, and poor grades are improved by granulation. I do not consider that the same applies to heather-honey, which is incomparable in the comb, but ordinary clover-honey of good white colour and fine granulation is delightful. Then, too, from the buyer's point of view, the keeping quality is rendered almost positive, whilst the liquid form can be obtained again at will. I should think that one of our chocolate-manufacturers might find a sale for granulated-honey chocolates. For the purpose of experiment in flavours, I have just tried a mixture of the two articles, and am only anxious to have the matter challenged in order to repeat the experiment!

*Candy-making* (page 15).—Those who have difficulty with this expert product

are recommended to read Mr. Woodley's recipe, and to try again. I have not done so, but I am convinced that it will give good candy. There is often a decided difference in the proportions of sugar and water in different recipes, but this is apparently compensated by the duration of boiling. Various sugars also seem to give slightly different results, and amateurs would do well to confine themselves to one variety. My recommendation is that recipes should be tried, and when you have found one which in your hands gives the best results in the simplest way, post the proportions up where they cannot be mislaid, and stick to it, for your candy will improve with experience. Generally speaking, all these recipes aim at a final result in which the sugar and water bear a definite proportion, and the temperature at which the compound boils is a gauge of this. Recently the temperature was given officially in the B.B.J. as 235 deg. Fahr. Some years ago I made a number of experiments to determine this accurately, and I found that 238 deg. gave me the best results. The higher temperature gave a quicker granulation. This quickness of granulation is an important factor in securing a fine grain, and is part of the reason for stirring the candy in order to cool it as rapidly as possible.

*Starvation—a Warning* (page 15).—This is a timely word, and bee-keepers, whether beginners or otherwise, should act upon it, and not merely read it with a sage nodding of the head. For they cannot know definitely without an examination just how their stocks are progressing, whilst the best may need the earliest attention. We have had a kindly winter so far, and there have been so many good days upon which an examination could be made that there is no excuse for ignorance. I have to-day (January 30) made the first quilt-turning inspection, and found all stocks alive and well stored. The stocks packed up—two in a ten-frame hive—seem to be all right; but in several cases I thought a cake of candy advisable, for there is no telling what sort of weather is in store for us. Curiously, I noticed that the syrup-stored stocks were well below their stores, whilst the heather-going stocks, though equally heavy, were up to the top bars. I shall need to keep an eye upon them.

## PRESS CUTTING.

### BEE-SUPERSTITIONS.

Old bee-lore and picturesque superstitions concerning bees yet linger in many out-of-the-way corners of the country. Thus the custom mentioned by Borlase (1769) that the Cornish bee-keepers used

to invoke a spirit called Brownyn when their bees swarmed, to prevent the bees from returning to the former stand and to induce them to form a new colony, is said to be still not forgotten. In a Saxon MS. in Corpus Christi College, Oxford, there is an instruction to throw gravel over a swarm of bees in the air, using these words: "Set ye, my ladies, sink; sink ye to earth down. Never be so wild as to the wood to fly." During the past summer the writer's garden-lad, when pursuing a truant swarm, was advised by a cottager to use the same method, if not the same words. John Gay (died 1732) alludes to the very ancient superstition that if a swarm of bees clusters on dead wood it is an omen of death for the owner or his relatives; it is also believed that such a swarm never produces honey to any value. Both these consequences are firmly credited by old-time skeppists to-day. One such recently told the writer that when bees are kept in frame-hives, and their surplus honey is taken away, they invariably go and rob their neighbours in order to make up the shortage; his attitude to modern systems of bee-keeping was, therefore, distinctly unfriendly. The custom of "telling the bees" of weddings, christenings, funerals, and other important events in the family of the bee-master, and which forms the subject of a pathetic little poem by J. G. Whittier, is still observed in many cottage bee-gardens. A piece of crape, or a white favour, is fastened to each skep, or upon stakes before the entrances, and someone of the family moves up and down in front of the hives chanting the news, or else whispers it at the entrances, touching each with the door-key. The writer has seen twice, within recent years, skeps thus decorated with crape bows in remote villages in East Anglia.

In some parts of Europe it is said to be usual to turn up the skeps as the funeral procession leaves the house for the church. Small pieces of wafer bread are sometimes placed in the hives to bring luck, and it is hailed almost as a miracle of reverence when the bees enclosed these morsels as it were in a shrine of wax. At wedding feasts long ago much mead or hydromel was drunk during the month succeeding the marriage, hence possibly the term "honeymoon." The aged road-mender, from whom the writer got his first bees, did not part with his skeps without some ceremonial, although a change in his circumstances prevented his keeping bees any longer. A small river separated the two dwellings, and he considered it unlucky to cross running water with bees; however, as there was no other way, he brought them over on the eve of Old Christmas Day—an auspicious date. Sprinkling the new floorboards with a

compound of sugar concocted by himself—to make the bees, as he said, feel at home—he then instructed the new owner to tap on each hive and say, "This is your new master." In his view, to take money for bees was unlucky, but he also had a conflicting theory that bees will not prosper unless gold is paid for them. The latter course was followed, and the bees certainly prospered, but the old roadman shortly after was run over by a passing trap. He was stone deaf, and was soon gathered to his fathers. A curious coincidence happened in the writer's presence during the funeral of a woman who for many years had been devoted to bee-keeping. When the body was being lowered into the ground a swarm of bees issued from one of the hives near at hand, which she had tended, and clustered on a bush close to the grave, although there were many trees near the hive. The swarm settled quietly, and did not disturb the service.—*Daily Telegraph*.

## Notices to Correspondents.

- F. J. N. (Wokingham).—"*Preuss*" *Non-swarming Method*.—We do not know if this method has been tried in this country, but there is no reason why it should not do if the bee-keeper chooses to undertake all the work connected with it. The frames of the "Preuss" hive are 8½ in. wide and 15 in. deep, and slide out from the back—a system which is not nearly so convenient as the one we adopt of lifting the frames from the top. The hives could contain from nine to twelve frames, and can be reduced to any number by means of a sliding glass partition. Preuss's system has been improved by the "claustral" system of the Abbé Gouttefangeas, which is applicable to our hives, and is described on page 50 of "Guide Book." The gist of the "Preuss" non-swarming principle was given on page 513 of B.B.J. for last year, so that it would be easy to try it. We would recommend you to get the book, which consists of over 250 pages and illustrates the hives and appliances used.
- E. M. M. (Tremeirchion).—*Soft Candy*.—The candy is very well made. Please note our change of address.
- W. G. A. (Elgin).—*Dying Bees*.—The bees are evidently suffering from internal trouble, due probably to improper food which they are unable to digest. Their stomachs are very much distended and filled with pollen-grains, most of which are undigested, small flakes of wax, hairs, and bacteria. These are present in large numbers,
- which was to be expected, as decomposition had far advanced.
- EMIGRANT (Plymouth).—*Bee-keeping in Australia*.—Bee-keeping is carried on extensively in Australia, though not on so large a scale as in the United States. This is due partly to the difference in the quality of the bee-forage and partly to the climate. Then in America there is an excellent market close at hand, while the Australian bee-keepers have to export a large amount of their produce at a very low price. Still, it is possible to make a living from bee-keeping in Australia, as several bee-keepers do so to our personal knowledge.
- H. S. (Cheshire).—*Bees Damaged in Transit*.—If you can prove that the damage was caused by carelessness on the part of the railway company's servants, the company is liable.
- BEGINNER (Altofts).—*Bees Dead in Hive*.—The bee is a queen. The colony has evidently not been strong enough to maintain the warmth necessary, and died from cold. It will be quite safe to use the combs again.
- M. E. C. (Suffolk).—*Fowls and Bees*.—The fowls will not injure the bees, but chickens are sometimes stung to death when allowed to run freely about the apiary.
- Suspected Disease.*
- J. R. (Bagshot).—The bees have died from "Isle of Wight disease." On no account give the stores to other stocks. Every precaution should be taken to prevent the disease spreading.
- C. C. (Swansea).—We are sorry to have to confirm your suspicions as to cause of death of bees, as they are affected with "Isle of Wight disease." On no account use the combs again; burn them, together with quilts and all internal fittings of the hive, and well disinfect the latter before using again.
- H. S. (Cheshire).—1. The honey in the box had made the bees so wet and in such a messy condition that it was impossible to examine them. 2. There is no scheme of insurance against disease in this country.
- E. J. S. (Kew).—Unfortunately, your surmise is correct, and what you propose to do will be the wisest course to take. If you can change the site, so much the better; but if this is not convenient a good dressing of chloride of lime will make the risk less.
- ANXIOUS (Surrey), J. M. M. (Fife), WEYSIDE (Hants), K. B. (Surrey), H. B. (Cheshire), ANXIOUS (Woodford Green), and H. J. U. (Kent).—We regret to say that the bees sent are affected with "Isle of Wight disease."

## Editorial, Notices, &c.

### REVIEWS OF FOREIGN BEE JOURNALS.

By "Nemo."

*The Bacon Beetle as an Enemy.*—A. Holfeld, writing in "Deutsche Imker aus Böhmen," warns bee-keepers of the harm that *Dermestes lardarius* (the bacon beetle) causes sometimes in hives. He says that he has not seen this beetle mentioned as an enemy of bees in any bee book, nor has he noticed any allusion to it in bee papers. For this reason he thinks it is necessary to call attention to it, so that the bee-keeper may recognise and be on his guard against it. *Dermestes lardarius* is 5-16ths of an inch long, and has elytra with a broad brownish-grey band, straight, short-clubbed antennæ of eleven joints, the club occupying three; the head is small and retractile; the hind coxæ are expanded and flattened, the tarsi five-jointed and the elytra covering the abdomen, giving it a cylindrical appearance. Like their relatives of the same genus these beetles are able to simulate death on being frightened. With bent head, closely pressed antennæ, and retracted legs, the beetle lies for a long time after it has been disturbed, pretending to be dead. The larva is as long again as the beetle, with leathery plates on the upper side, which is clothed with long erect scattered hairs; and there is a pair of short spines on the last segment, which has also a fleshy protuberance on the under side. It casts its skin four times between May and September, and the dry cast skins of this larva may frequently be seen among the debris of brown dust. The chrysalis is white in front and brown behind, and if disturbed becomes very agitated. The full grown beetle emerges in September. These creatures are not particular as to food: they attack any kind of animal substance and are particularly partial to natural history specimens. They are also partial to old combs, feeding on the cast larval skins, and are particularly fond of sealed pollen. As the larvæ, as well as the beetles, frequently change their places, it is difficult to find them on the combs, and the best way to dislodge them is to rap on the frames, when the disturbance causes them to counterfeit death, and they drop down. They do not care for new combs, but old ones are very soon destroyed by them. Owing to their hard skins, bees are not able to sting them or get rid of them. We have amplified the description given in the German paper, because we have on several occasions had these larvæ sent up for identification.

*Judicious Protection of Hives.*—We are told in the "Rucher Belge" that in February there ought logically to be a softening of the winter temperature, but the weather very often is rigorous and damp. Everyone will, naturally, at such times be anxious about his colonies, and take precautions that the bees may be able to keep up the proper temperature in the hive. However, in this great judgment must be exercised. It is

most important that the vital caloric be preserved. Of their own accord the bees have drawn together and clustered, in such a way that all the members of the colony enjoy an even temperature. It must not be forgotten that an excess of heat is very injurious to bees from several points of view. First of all, contrary to the opinion expressed sometimes, the bee is not a southern insect which has been acclimatised in our temperate regions. Her physical constitution is adapted to our changeable weather, and she is drowsy during winter. She appears to suspend social life, which is so proverbially active in summer, and also partly her animal life. In fact, it is well known that the intestine can retain for a month or two the excrements and residues of digestion, which are at such times much reduced, in order to evacuate them in the spring, or when a fine day enables the bees to go out for a cleansing flight. The results of scientific observations have shown that the temperature of a hive may not rise higher than 47 degrees Fahrenheit, and it is even desirable that in winter this temperature should not be exceeded. Bees fear cold, for as soon as the temperature rises they are eager to come out, and we know with what disastrous results. Supposing the hive is too small, by being reduced with division boards, the population very strong, the sides of the hive very thick, and the coverings excessive. When the temperature inside the hive rises from 60 to 67 degrees, while that outside is only 39 degrees, it is evident that the bees which fly out owing to the warmth inside, would inevitably be lost. From this it will be gathered that a high temperature in the hive is dangerous, and if bees are noticed to be disturbed by too much covering, some of it should be removed, to induce the bees to remain indoors.

*Bee Flowers.*—Besides the ordinary flowers which are indigenous to a district the "Deutsche Illustrierte Bienenzeitung" recommends sowing seeds of various exotic species, which are much visited by bees, and which should be sown during favourable weather in the spring. The annuals can be sown on the spot where they are to flower, and the perennials should be transplanted in the autumn. The seeds recommended are: *Agrostemma coeli-rosa* (rose of heaven), *Asperula azurea* (blue woodruff), *Calendula officinalis* (pot marigold), *Campanula speculum* (Venus's looking-glass), *Collinsia bicolor* (two-coloured Collins's flower), *Dracocephalum Moldavica* (Moldavian dragon's head), *Eschscholtzia Californica* (Californian poppy), and *Iberis amara* (bitter candy-tuft). For sandy soils *Lupinus hybridus* (lupins) of various colours, and *Nemophila insignis* (Californian bluebell), as both flower for a considerable time and furnish plenty of nectar. The bees also work assiduously on *Nigella* (fennel-flower), and revel in poppies, from which they return covered with pollen. Especially fond are they of mignonette. Among the sages those recommended are *Salvia coccinea* (scarlet-flowered), *S. horminum* (red-topped), *S. pratensis* (meadow clary), *S. verticillata* (whorled blue-flowered).

All these flowers in a favourable season are much visited by bees, and are worth planting.

---

## CUMBERLAND B.K.A.

### ANNUAL MEETING.

The annual general meeting of the above Association was held in the Parish Room, Egremont, on Saturday, the 21st January. Mr. James Henry occupied the chair.

The report and balance sheet for the past year were presented, which stated that 1910 must be considered the best year they had had for many years, from the bee-keepers' point of view. Although the season could not be considered a first-class one, yet in many districts results were obtained surpassing any of late years, both as regards quantity and quality of the honey secured, and average takes of 100 lb. per hive were recorded. The heather harvest was again a disappointment, owing to continuous rain during the best part of August and September, when the heather was in bloom. Only those who had well-prepared colonies placed on the moors very early in August secured any surplus. Honey dew was entirely absent during the whole of the season. There has again been a satisfactory increase of membership, 107 new members having joined in the last twelve months. This increase is principally in Westmorland, where new districts have been visited.

The balance sheet showed on the receipt side that subscriptions had been received to the amount of £111 6s., Cumberland County Council grant, £100; Westmorland County Council grant, £10, but there was a deficit balance of £18 5s. 6d. on the year's working. The Council hope that all members who can will do their best to help in clearing off this deficit during the current year.

Mr. Mitchell proposed, and Mr. Simpson seconded, the adoption of the report and statement of accounts, which was carried.

On the proposition of Mr. T. Hartley, seconded by Mr. Mitchell, a hearty vote of thanks was accorded to the members of the Council and all officers for their services during the past year.

Lord Muncaster was re-elected president of the Association, and the vice-presidents were re-elected with the exception of Colonel Blackett, and the additions were Dr. Arnott (chairman of committee), Mr. Bermair, and Mr. Ecroyd. The committee were also given power to add to their number.

The Council were re-appointed, after three names had been omitted, and the vacancies were filled by Father Berkeley, Mr. John Allsopp, and Mr. J. W. Nelson.

Mr. G. W. Avery was unanimously re-elected hon. sec. and treasurer.

The hon. auditor (re-elected) was Mr. J. B. Millican, of the Carlisle and Cumberland Bank.

In bringing up the proposal to alter the name of the Association to "The Cumberland and Westmorland Bee-keepers' Association," it was said if this was carried out they could not use any of the £100 grant from the Cumberland Council for the expenses in Westmorland, and the sister council must have the whole of their expenses. There might be a possibility of the Westmorland County Council repeating their grant of £10 to help the Association on.

Mr. T. Hartley moved that the sister county be joined with the name of the Association, and that separate accounts of each county's workings be kept.

Mr. Satterthwaite seconded, and it was carried.

It was decided, after discussion, to again become affiliated with the British Bee-keepers' Association.

Next year's meeting was fixed to take place at Keswick.—G. AVERY, Hon. Sec.

---

## HOMES OF THE HONEY-BEE.

### THE APIARIES OF OUR READERS.

Mr. W. J. Woolley, one of whose apiaries is seen below, is another tradesman bee-keeper who has "tacked" on the pursuit to his ordinary occupation, which in this case is that of a fruiterer and confectioner. Therefore, the problem of how to dispose of his honey crop presents no difficulties to him, for, according to his own account, he can easily sell all the honey his bees produce through ordinary.

business channels, and sometimes has to supplement the supply by buying from other bee-keepers less fortunately placed with regard to a honey market. In the following notes written to accompany the picture, Mr. Woolley says:

"I started bee-keeping in 1905, with two stocks, principally because I had an acre of land on which I grew strawberries and other small fruits, which I disposed of at my own shop in the town. I thought I could sell honey direct to my customers also, if I was able to get any. Since then I have gradually increased till I have now seventeen stocks at my home apiary at Evesham,

stock and burnt the lot. When I commenced bee-keeping, I made up my mind to master the subject thoroughly, so I started taking in four or five bee papers, joined the county association, bought the "Guide Book," and got practical advice and help from the association expert. In 1909 I entered for the third-class certificate myself, and passed, and last year I was expert to the Worcestershire Bee-Keepers' Association, South Evesham district. I have never regretted going in for the hobby, as I find it interesting and profitable. I make nearly all my own hives during winter-time, and they hold thirteen or fourteen frames. This district is

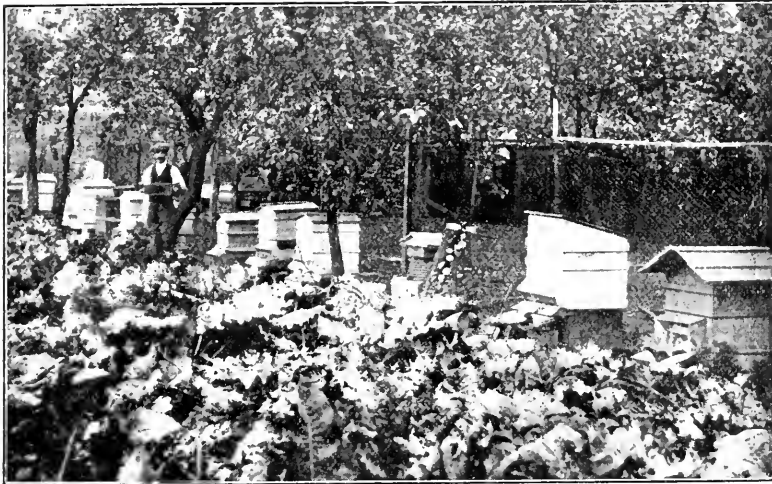

MR. W. J. WOOLLEY, JUNR. S APIARY, EVESHAM, WORCESTERSHIRE.

and six at an out-apiary six miles away. I can easily sell all the honey I can get, at 1s. per lb., and last year I had to buy a considerable quantity, besides my own, in order to supply my customers. Last season, my average per hive was only 15 lb., but in other years I have generally taken an average of 40 lb. My best "take" of honey was 73 lb., the produce of one stock, the queen of which I bought through an advertisement in the BEE JOURNAL for 1s. 6d. Unfortunately, they were the worst tempered bees I ever handled. I have had practical experience of foul brood through the bees belonging to a neighbour having it, and the owner taking no trouble to cure them year after year. At last, in desperation, I bought the diseased

fairly early through scores of acres of wallflowers being grown, which supply plenty of early pollen. This causes the bees to build up quickly. The honey is from mixed sources, apple and plum blossom, beans, etc. The clover honey comes on after the apples have finished blooming. I have been fairly successful at local shows, and took five first and one second prize last year, but the local honey is rather dark, through being gathered from mixed sources. Of course, I have had my share of stings, and in my first year of bee-keeping, I well remember having to stop indoors for three days, because my face was not fit to be seen. I had thirteen stings round my eyes. But stings rarely take any effect upon me now."

## Correspondence.

*The Editors do not hold themselves responsible for the opinions expressed by correspondents. No notice will be taken by anonymous communications, and correspondents are requested to write on one side of the paper only and give their real names and addresses, not necessarily for publication, but as a guarantee of good faith. Illustrations should be drawn on separate pieces of paper. We do not undertake to return rejected communications.*

### NOTES BY THE WAY.

[8042.] An old Wessex saying is that if the sun shines before 12 o'clock on Candlemas day winter is not half over. On February 2nd, the weather was dull throughout the whole day hereabouts, but as to the extent of winter weather to come I express no opinion. On Saturday, January 28th, we had a beautiful day, more like May or June than January, every hive in the home apiary was in full force, some gathering natural pollen, and after lunch I ran the car up to my out apiary and found every stock alive and on the wing in goodly numbers. Many of the cakes of candy given at the end of November were nearly cleared up, so candy making had to be started again, so that a further supply may be given as soon as that now on the hives is nearing its end.

*Isle of Wight Bee Disease.*—I am very sorry to see so many replies to correspondents in B.B.J., saying their bees have died from this insidious malady. How is the disease disseminated so far and wide? If it is produced by a specific germ, surely, in some cases the source of infection can be traced, and some reason given for the outbreak in such widely divided districts as Kent, Swansea and Fife (N.B.). Again, if this disease is of a dysenteric nature have our agriculturists or horticulturists introduced any new plant in recent years from which bees have gathered pollen that is harmful? It seems almost like a plague in wiping out colonies and frequently whole apiaries in a short space of time. Would the spraying of fruit trees and fields of charlock with Paris Green or London Purple account for the outbreak if the bees collected and stored poisoned pollen. If so, bee-keeping stands a chance of being wiped out in this scientific utilitarian age. But farmers and horticulturists and fruit growers will also suffer most disastrously if there is a lack of such valuable pollinating agents as bees.

Anent the straw skep as a honey producer, I may say that the finest and heaviest bell-glass of comb honey I ever saw was exhibited at a flower and honey show at Wantage, Berks (the birthplace of King Alfred), under the auspices of the Berks B.K. Association, in 1880 or 1881. It weighed 94 or 96 lbs. net. Since that time I myself have worked some extra fine bell-glass supers of between 80 to 90 lb. each, but I never reached the weight of the one stored on the now despised straw skep.

Fifty years ago nearly every cottager and every farmer kept bees in this district. Now I know of two farmers only who keep bees, and one of these apiaries is catalogued for sale this month. The cottager bee-keepers can be counted on the fingers of one hand in two or three villages. In saying this I am not disparaging the modern frame hive system, as I have proved its benefits myself, but I know the cottagers' capabilities, and except in a few instances the frame hive is beyond his management, whereas in the times gone by four or five skeps in a good season would produce enough to pay the rent.—W. WOODLEY, Bedford, Newbury.

### SOUTHERN SNATCHES

#### DRONE V. WORKER CELLS IN THE SUPER.

[8043.] Mr. MacDonald, on p. 494, B.B.J. (December 15th, vol. XXXVIII.), commenting on drone comb in sections, expresses the opinion that it has no advantages but many disadvantages when used for supers. After two seasons' trial I am more than convinced that Mr. MacDonald is right, and I have a worse charge against it than any he has brought forward. I do not know if it is a peculiarity of our South African bee or not, but I have found that unless the drone foundation is given during a "flow" my bees make a regular mess of it. When honey is plentiful it is drawn out and well filled, having a "plump" appearance, but not the nice even capping of the "worker" foundation, and it is certainly not "in it" for the show bench. When the honey "flow" is at an end, any foundation not already drawn out is simply spoiled for anything except the wax extractor. The bees seem to think they have quite enough drone comb, and endeavour to convert it into worker on the same base, and the result is indeed curious in the extreme. In a whole sheet there may not be a perfect shaped cell, either drone or worker, and not quite half have honey stored in them. The tops of the cells are of every conceivable shape, being narrowed down at the top to about the size of worker cells there is naturally a void space between each cell. This is sealed over, and mostly of a triangle shape, but both shape and size varies considerably, as does also the neighbouring cell, which the bees, with futile efforts, try to shape to the natural form. My experiments were confined entirely to shallow frame super foundation. I can assign no reason for the bees working it when honey was coming in plentifully, and treating it as explained when honey was scarce, but no doubt they were actuated by the golden rule of "making hay while the sun shines," and had no time to give way to the natural impulse of cur-tailing the amount of drone comb to their actual needs. The above results have been obtained in every instance in which the foundation was used, and I should like to know if any other readers of the B.B.J. have had a similar experience. Apart from this, I don't think there is much gain either to the bees or the bee-keeper in using drone foundation for sections. The walls of the



cells are certainly heavier, and this must counteract the advantage gained in having fewer to build, and in the case of extracting frames, there can be no benefit at all only in the first instance, as after the comb is once drawn out there is still the same surface to cap, and, finally, drone comb is easier broken in the extractor.

*Excluder Zinc.*—This evergreen topic, which has been discussed in the pages of the B.B.J. many times, must always be of interest to bee-keepers, which is my only plea for referring to it. My experience is that to the bee-keeper working for extracted honey it is a necessary evil. I have never found an egg in a section where it was not used; and I have never been able to obtain a super of extracting frames without eggs in abundance when it was not used. This on hives containing as many as fifteen frames, all of which the queen was at liberty to make use of. Queens seem to have a decided preference for new combs, and I have found them filling the super frames with brood a couple of days after they were put on. Mr MacDonald and Mr. Soal some time ago argued the pro and con of this subject, and my experience proves that both were right from their own standpoint. I would never dream of using an excluder under sections, or put on extracting frames without it. Much stress has been laid on the impediment to bees in getting through it. This I consider is over-drawn. Bees very soon get used to it, and given a good "flow," I have always found the honey goes up almost as well as if there was no excluder on the hive. Notwithstanding these conclusions, I am no lover of excluder zinc, and should welcome a system of working for extracted honey without it.

To the many correspondents of the B.B.J., whose names are household words in the bee-keeping world, I tender my best thanks for many pleasant moments, as well as for much valuable information week by week, year in and year out.

Trusting brother bee-keepers in the British Isles will have a record year in 1911.—HENRY MARTIN, Dannhauser, Natal.

#### HOW FOUL BROOD WAS EXTERMINATED IN BELGIUM.

[8084.] In reply to your questions, I would say that bee-keepers who were not members of our society (Société d'Apiculture du Bassin de la Meuse), and in whose apiaries there was foul brood, generally kept their bees in straw skeps, but the bees had mostly died out in less than two years. Many of them joined our society as members for the purpose of obtaining advantage of the compensation secured from the foul brood Insurance Society.

This is how the Insurance Society worked. When an apiary was found to have foul brood an expert visited the bee-keeper, and after putting a valuation on the colonies, offered to pay pretty nearly their value if the owner gave his consent to have everything burned; bees, hives, combs, etc. The destruction had to be effected in the presence of witnesses delegated by our bee society.

In not a single case did the bee-keepers who were insured refuse to have everything destroyed; they understood that nothing better could be done than to cut off the mischief at its source. Let us hope that science has not said the last word, and that the time will come when foul brood can be thoroughly eradicated without having to consign everything to the flames. I have fortunately never had foul brood in my apiary, probably because every spring I take the precaution of transferring my colonies into clean hives disinfected with formalin, and never feed the bees with honey obtained from an unknown source or suspicious district.

In order to prevent bee-keepers who are not members of your Bee-keepers' Associations from propagating foul brood by keeping their diseased colonies, would it not be possible to hand each a leaflet, which would give them the necessary information to convince them that their apiaries had foul brood? A leaflet which would inform them what would surely happen if they did not destroy their diseased colonies, and that your Association would offer them compensation if they consented to such destruction. Probably most of them would accept such an offer. The members of your Association would have to distribute such leaflets, and, if necessary, explain them to these bee-keepers who are thoughtless of their own interests and grossly culpable, because they are really the means of spreading the disease among their neighbours.

The law here punishes all those who by their imprudence cause harm to their fellow citizens. Bee-keepers who keep diseased colonies deserve to be brought into court and made to pay damages for the injury caused by them. If the law does not affect them, they are none the less culpable, and their conscience must trouble them for their carelessness.—A. WATHELET, Prayon, Belgium, January 24th.

#### AN EARLY POLLEN-BEARING SHRUB.

[8085.] I am enclosing for your inspection a sample of a flowering shrub, which I think may interest readers of the B.B.J. On visiting Messrs. W. Cutbush and Sons' Barnet Nursery, a few days ago, I was surprised to find this shrub *Garrza Elliptica* in full flower, and that the slightest touch liberated a perfect cloud of pollen. This is apparently a much earlier plant than the willow, or in fact any other flower that produces pollen in large quantities. I am assured that it is very nearly hardy and this is borne out by the fact that in this high and exposed position it is in full bloom so early in the year. The shrub I inspected was on the south side of a store shed, and was literally covered with trusses of bloom.—G. J. F., High Barnet.

#### ISLE OF WIGHT DISEASE (?).

[8086.] The following account of a disease of bees, accompanied by constipation and loss of the flying bees may prove of interest. It is taken from Bonner's "New Plan for

Speedily Increasing the Number of Bee-hives, etc.," which was published in 1795:

"The long continuance of the late storm (1794-5) having confined the bees in their hives for about four months, the bees of some hives contracted diseases, which during the last month of their confinement proved very fatal to them; and some of them daily fell down, or rather came down of their own accord, from the combs to the stool, in search of some aperture to get out at, in order to void their fæces, but, after crawling about on the bottom of the hive for a considerable time in vain, the cold benumbed them so much, that they could not return to their brethren again, and thus death ensued. Now, supposing only three dozen of bees per day to have come down upon this errand, and perhaps not a third of them to have been able to return, 't is evident, that such hives must of course be soon greatly reduced in the number of their inhabitants. This made me anxious for good weather, that my diseased and distressed servants might get out and recover their health, by flying about and getting rid of their superfluous matter. The long-wished for period at last arrived. The storm broke, and the weather became mild; and, upon examining my hives, I found that out of fourteen, which I had in one apiary, there were twelve whose bees were in a healthy state; and that those of the remaining two were partly diseased. The day being very fine, and the doors of my hives opened, the bees flew about as thick as hail, making a great noise with their usual music. My wife being present, we observed that the two diseased hives gradually diminished in the number of their bees, whereupon I said, that I supposed the bees would soon desert these hives altogether, to which she replied, that she wished they would, and that they would go into some other hives, provided they did not fight. Upon further observation I found that some of them entered into one hive, and some into another, till at last the original hives were totally deserted, except the queen and about a score of bees; and that almost all the bees entered into those hives that were most happy, as appeared by their making a most harmonious sound at the entry of their hives, by which music they seemed to invite their new friends. The deserted hives were well stored with honey and therefore I turned them upside down, and placed them below some of my other hives, in order that the bees might collect the honey that was in them. Such deserted hives I have often found useful for putting a young swarm into.

"I have even seen young swarms gradually desert their hives in this manner, and go into other hives."—G. W. BULLAMORE, Albury, Herts.

#### CHEAP HOME-MADE HIVES.

[8087.] *Two-shilling Hives* (page 44).—It would be interesting to know the value of the time expended in making hives out of packing-cases. To my positive knowledge, and I have had over fifty years' experience in

woodwork, packing-case wood is all of inferior quality, being chiefly sapwood, and, of course, absorbs wet very readily, it also expands and contracts, according to the weather, and, naturally, it soon decays.

From D. M. M.'s description I should infer the value of time was not less than 10s., possibly more, and the value of the completed hive would not be more than 5s. Let anyone test the absorbent qualities of real sound St Petersburg or Memel deal in contrast with packing-case wood if he wishes to prove my statement.

A weak point in the construction of hives in general is in having the junction of alighting board and floor just under the entrance slides. The wet lodges there and soon rots both, as well as the bearers or joists. The junction should be at least three inches from the edge of floor board—inside of course; with alighting board and floor arranged thus. I have often seen the bees fly right into the hive as it seemed; and it should also be much easier for them to get out dead bees and chilled brood.

*Winter Brood Chamber* (page 39).—I do not think there is any hard and fast rule as to the number of frames for successfully wintering bees. I have wintered them successfully on five frames. One lot (nucleus, of course) sent to Scotland in April of 1908 gave 60 lbs. surplus honey. A "top" swarm was taken off and the stock divided into two; thus, the owner had three good stocks in April, 1909, from the one five-frame lot of April, 1908, besides the 60 lbs. surplus. My experience is that eight frames with fair stores at the end of September is about the "quantum suf." I usually look through them about September 12th, and those that do not appear to have sufficient stores are fed up for a fortnight. I do not think it is advisable to feed with syrup later than the first week in October.

I am curious to know what progress is made with driven bees at the end of October? Do they seal their stores? Naturally, a single lot of, say, 2½ lbs., early in September will do far better than a 5 lb. lot in the end or even the middle of October.—A. HARRIS, North Bucks.

#### EARLY POLLEN GATHERING.

[8088.] I see in this week's BEE JOURNAL you mention January 28th as the first day that bees have been seen carrying in pollen. It may interest you to know that on January 15th, in the middle of the day, I observed two bees enter one of my hives with pollen apparently from yellow chrysanthemums. I was only watching for a very short time, and so cannot say if any more were carrying it in, but there were not a great many flying at the time.—A. R. P., Taunton.

Four things a man must learn to do  
If he would make his record true:  
To think without confusion clearly;  
To love his fellow men sincerely;  
To act from honest motives purely;  
To trust in God and heaven securely.

—Henry Van Dyke

## Queries and Replies.

[4081.] *A Beginner's Queries.*—The BEE JOURNAL is a grand little paper, and I look forward to seeing it every week. As I am only a beginner I should be grateful if you would answer the following questions in an early issue:

(1) What is meant by the word "novice"? Would you term a man who has kept bees for three years one? (2) Is 55 sections and a large swarm a good record from one hive last year—on the borders of Bristol—the swarm drew out nine combs besides? (3) To prevent second swarms should I cut out all the queen cells, or leave one? Should there be a virgin queen in the hive, and the one cell hatches; will that cause the bees to swarm a second time? (4) I have a hive in the country, do you think if I put on a "Porter bee-escape" in the evening and leave it on till four o'clock the next day will the bees on a warm day be too crowded when in the lower super and board chamber? Is this too long to leave the bee-escape on? (5) Is the afternoon the best time to take a super of honey off the hive. (6) Do bait sections cause the queen to lay in the super, for when I did not use them I had no sections spoiled. (7) Is the queen at her best in the first year or second? (8) Is there any way of telling if bees have re-queened themselves. (9) Does it upset a hive to remove supers and look for queen cells, and cut them out, and look again in a week's time.—BEGINNER, Bristol

REPLY. (1) A man who has kept bees for three years, while not an experienced bee-keeper, can hardly be called a novice. (2) Yes, especially in a poor season like the last. (3) To prevent a cast you should cut out all queen cells but one, making sure at the same time that a virgin has not emerged. (When a swarm leaves the virgin is generally due to emerge in about three days.) Should a virgin queen have come out then cut out all queen-cells. (4) If the weather is very hot it would be well to put an empty super on, at the same time that you will put on the Porter escape, the time will then not be too long; in fact, you might leave it for several days if necessary. (5) Less excitement is caused if it is taken off early in the morning or late in the evening. (6) A great many bee-keepers do not use an excluder with sections, the queen is less likely to lay in them than in shallow frames, as the cluster of bees is divided. (7) In her second season. (8) An experienced bee-keeper can tell an old queen from a young one, and so is able to say if a colony that had an old queen has re-queened itself. The wings of young queens are perfect instead of being jagged at the edges as is often the case with an old one. They are also more slim, and agile in their movements. (9) It is not a good plan to disturb bees unnecessarily, but if occasion arises it will do

little harm if carried out in a proper manner. Room in advance of requirements and plenty of ventilation will usually check the desire of the bees to swarm.

[4082.] *Sociability of Italian Bees.*—In your reply to question 4073, p. 37, you seem to imply that "Golden" bees are content and welcomed in any hive. If this is so, and their presence in "native stocks" is not due to robbing, they must surely be devoid of that homing instinct and allegiance to their queen which most of us take for granted is the great outstanding fact upon which the whole economy of the hive is based. It will certainly add a new interest to bee-keeping if we have to discriminate between robbers and visitors, rather, I am afraid to the disadvantage of the latter.—A. B. S., Manchester.

REPLY.—In our reply we intended to convey that Italian bees are apparently more sociable than blacks, or it may be that they are more noticeable than the latter could possibly be when they get into other hives. In our own apiary of over one hundred stocks of blacks we have found Italians in nearly every colony, although there was but one Italian stock in the apiary. The probability is that bees are far more social under certain conditions than we are generally led to suppose—more especially in large apiaries. We have found that Italians are certainly more pugnacious and given to robbing than blacks.

[4083.] *The Alexander Method.*—In reading Roots' ABC and X Y Z of Bee Culture, page 447, I came across Mr. Alexander's plan of uniting weak colonies to strong ones, with the intention of building up both lots strong to take advantage of the honey flow. I should be pleased if you would say if this plan is adopted to any great extent in this country; also if it is a plan that you would recommend. If so when would be the best time to carry it out?—A. H. H., Ilkeston.

REPLY.—The plan is not adopted at all to our knowledge in this country; it will be much better for you to stick to the method given in the Guide Book.

---

### YORKSHIRE BEE-KEEPERS PLEASE NOTE!

The Rev. Sidney Smith, Wheldrake Rectory, York, asks us to say that owing to his prolonged illness he has been obliged to give up all official connection with the Yorkshire Bee-Keepers' Association. The secretary for the Association is Mr. Richardson, Whitkirk, Leeds, and to him all letters respecting the Association should be addressed.

---

### OLD BEE LITERATURE.

Mr. W. G. Coates sends us an interesting extract relating to bees which he discovered in an old book called "The Treasure of Ancient and Modern Times." It was printed in 1619, and

might be called an equivalent to our modern *Encyclopædia Britannica*; it consists of ten books relating to different subjects. The chapter on bees, which we print, appeared in Book 7. If any B.B.J. reader interested in old bee literature would care to see the book, Mr. Coates is willing to bring it to the B.B.K.A. Conversazione in March next.

THE TREASURIE OF ANCIENT AND MODERN TIMES.

*Printed by William Haggard, 1619.*

“The True Module and Pattern of Governement, to be observed in any Commonwealth; deriued from the communitie among Bees, and how many wayes they may be examples to men.”

The form of a Commonwealth observed amongst Bees, methinks is so proper and answerable unto that of men as it may be verily presumed, that GOD gave them it by a Natural instinct, and for an instruction unto our manner of Government. This little Creature is named by the Latines “*Apis*,” a derivation from the Greek, which signifieth to be without feet; not in regard that it hath no feet, but because they do join so closely and aptly with the body, as if indeed it had none at all.

Many have written of their properties and qualities; as Aristotle, Pliny, and many more; besides, I find in elder times, that Hiliscus Tatus was very inquisitive, to understand the properties of these creatures, and that he might render the sounder reasons of his knowledge he lived in Forests and solitary places, where best he might attain to his own intent. And Aristomachus, likewise, for the space of forty years (without attending to any other exercise) gave himself wholly to the same labour; and both of them wrote divers books very apt and worthy for all prosterity.

The first and most notable thing, observed in the writings of modern men, is, that they have noted an admirable kind of Religion in the little Creatures: For, before they will issue forth of their hives they bow down their heads forward in such humble manner as if they were devoutly at meditation on their knees. Declaring therein (even by Natural instinct as it were) to us, that we should not understand or begin anything, before we have first honoured GOD, and recommended our endeavours

to His gracious goodness, that they be begun and ended in His name. Very respective are they, that by the food they gather from sweet flowers, they may produce honey, beneficial both for others and themselves; demonstrating thereby that men should labour (by virtuous means) to performe good actions in their lifetime, available both for themselves and others; considering, it is a duty required in men, and for which they are born, not to labour for themselves, but also for their Country and their Friends.

They are content to live in their own habitation, without intruding for dwelling in another's house. As a notable example to us, that (for the peace of the Commonwealth) every man should rest contented with his own, without coveting or usurping ought from another.

Every Hive hath its King, and both he and his attendants, do shun noises, clamours, and winds. Which teacheth us, that we ought to have one chief Commander in one Commonwealth, by whom all the rest may be well governed; and that we should shun the smoke of Ambition, in being greater one than another in the Commonwealth, to the end, that there may be good discipline. Also, we should flee from all winds of vanities, tumults, partialities, and enmities. Flight, labour, food, and fruit is common alike to everyone; to let us understand, the mutual love and charity which ought to be among Citizens, in being helpful one to another; and partaking likewise in others' distresses: for by this means, men's minds become linked together in such amity, that the Commonwealth flourisheth in peace and quietness, and is a goodly president to other estates.

These creatures live without lubricity, although they engender more than any other. Which instructeth us, that for the peace and repose of the people, men should have care of their children's generation, to perpetuate their own kind and the Commonwealth, without lusting after adulteries: but to live chaste and temperate in pleasures carnal, the liberty whereof doth procure contentions, quarrels and death.

They do respect their King with such love and observance, that they account

it an honourable deed to die for him. And Saint Ambrose saith thus: "They will not fly abroad, until they first see, whether he will fly forth, or no: that they keep him company in finding food, and other effects for common benefit." Which may minister example unto men, for honouring their Prince, to whom GOD hath given such Authority, to be assisted and imitated in those pains which he taketh for the good of his people, he being the principal of the Commonwealth.

They endeavour continually, to elect such a one for their King, as (in appearance) is most noble, as also the mildest; nor using his sting against any other, which only is a punishment for offenders. Advising us hereby, to elect such for our Governors and Magistrates, as are of generous Nature, discreet, wise, and debonnaire. And these small creatures, are of such nature, that they who are of greatest body amongst them, are also (commonly) the most humane and gracious. Signifying nothing else to us, but that he ought to be most mild and courteous, that is exalted unto the highest dignity, as well in Nobility of blood, as wealth of virtue: which things naturally beget envy in others, and yet destroy themselves by humanity, and converteth into love. Most obedient are they to their King; and if any one have declared disdain, or other disobedience, and the same be discerned: he never attendeth for other correction, but instantly slayeth himself with his sting. Whereby we are admonished, to be faithfull and loving to our Prince or Magistrate, and fearful to offend, even to death itself.

No Bee is slothful or idle in the Hive; for some flieth forth to combat against other in open field; others watch to seek for food; others contemplate times to foresee when the storms and rains will ensue; others compose the Honey-combs; others lay aside the wax by itself, and thereof on others make little Lodgers, caries and rounds, in every strange and wonderfull order. Nevertheless, in so many and sundry offices, no one intrudes into another's business, or dare make any stealth or robbery from his companions: but by his own labour and virtue, he feedeth abroad on herbs

and flowers, and yet brings a part of his pains home, for general good of the Commonwealth. Herein we have a notable instruction, to abhor and banish out of our Cities, slothful rogues and idle vagabonds, that will not live by their own labour as they ought to do. Wherefore, through such deboshment and negligence in men, all such vices arise in Citties, as do corrupt good manners, and overthrow order: for every one should live upon his own endeavour, without usurping ought of others; and what he hath superflous, is for general aid of the Commonwealth, and to be ministered to other necessities.

Nature hath given them stings to defend themselves, and offend such as dare assail them, or presume into their city or hive: and although they are not of any great corpulence, yet notwithstanding they have unconquerable courage and prudence. For with the gum of trees, they annoint the superficies of the hives, to the end, that no beast or other enemy my enter in at any rift or chinke; and if the passage or issue be overlarge, they labour diligently to restrain or make it less. By which example men are admonished to be stout and courageous for defence of their country, and wisely to foresee, that no vices enter into their Commonwealth, that may infect, corrupt, or poison it.

By natural instinct, they are inclined, that each one stays on the first flower he finds, and parts not thence away, until he has taken his refection and nourishment: whereof he will discharge himself, before he seeks out any other. And much they frequent the leaves and flowers of the Olive tree, making there a long abiding: serving us as an example, what sobriety we should find in the course of our life. When they feed on the flowers of the Almond tree, their honey is the more savoury and temperate: whereas contrarywise, when they feed on bitter herbs or flowers, it is far less sweet: notwithstanding it is thinner, very mundificative, profitable for the opilations of the liver, and good for the dropsy, as also to heal the biting of a mad dog.

Such as have made trial by experience of these creatures, do justifie that when their king cannot fly, he is carried

abroad by troops of them; and during the time that he lieth so sickly, the females are separated from the males. But when he is dead, they converse together again: which declareth what pitty and piety we owe to our Prince and Country, and that men should gladly support and suffer for one another. The sting of the females is sharper than the males, and there are many males that have no stings at all. Hereby we may understand that the tongues of women are more piercing than mens', and oft-times cause very great inconveniences: in which respect, they should be kept short and temporated, that their lavish liberty breed no blame and contention among neighbours. The best Bee is little, round, closely plump, bending in the midst, and least hairy. Some feed on flowers of the mountains, others on them of gardens and husbanded places: the first whereof are much less than the other, as also more strong and robust, to endure labour. Beside, according to Pliny, they are of far dreadfuller aspect, abiding in the rifts of trees, or in some small vaults. And what fairer example can Nature afford us, than of their strength and abilities? For, such people as are not educated in delicacies, but in continual exercises of mind and body; are most profitable members for the Commonwealth.

*(To be continued.)*

#### WEATHER REPORTS.

BARNWOOD, GLOUCESTER, JANUARY, 1911.

Rainfall, 1.03 in.; below average, .76 in.; heaviest fall, .28 on 8th; rain fell on nine days. Mean maximum temperature, 43.5, .5 above average; warmest day, 28th, 53; mean minimum temperature, 33.7, .3 below average; coldest night, 1st, 24.5. Relative humidity, mean for month, 89 per cent., at 9 a.m. Number of days with sky completely overcast at 9 a.m., 18; ditto cloudless, 3. Percentage of wind force, 14; prevailing directions, S.W. and variable. Mean daily height of barometer, reduced to sea-level, 30.35, .4 of an inch above normal.—F. H. FOWLER.

WESTBOURNE, JANUARY, 1911.

Rainfall, 1.24 in.; below average, 1.30 in.; heaviest fall, .36 on 11th; rain fell on 13 days; sunshine, 68.3 hours; brightest day, 31st, 7.2 hours; sunless days, 15. Maximum temperature, 49 on 9th and 28th; minimum temperature, 23 on 15th and 16th; minimum on grass, 20 on 16th; frosty nights, 13; mean maximum, 42.8; mean minimum, 33.5; mean temperature, 38.1;

above average, .5; maximum barometer, 30.770 on 18th; minimum barometer, 29.487 on 12th.—L. B. BIRKETT.

## Notices to Correspondents

*Letters or queries asking for addresses of manufacturers or correspondents, or where appliances can be purchased, or replies giving such information, can only be inserted as advertisements. The space devoted to letters, queries, and replies is meant for the general good of bee-keepers, and not for advertisements. We wish our correspondents to bear in mind that, as it is necessary for us to go to press in advance of the date of issue, queries cannot always be replied to in the issue immediately following the receipt of their communication.*

F. V. W. (Gloucester) *Candy Making*.—There should be no difficulty in boiling sugar up to 234 degrees, as it is quite possible to attain as high as 315 degrees, a temperature required for toffee, drops, rocks, and such like. The lowest temperature at which you can make satisfactory candy is 235 degrees, so that you would have to continue boiling until this degree is reached. In boiling refined sugars see that your fire is sufficiently made up to bring off the pan without any additional coal; it does not matter if the fire is dull when the pan goes on, but to put fresh coal on when the sugar is boiling is detrimental, and the quicker the boiling is done the better, therefore, it is essential to have a very fierce bright fire. Sugar boiling, with the aid of the thermometer, is an everyday practice, and many of the shops will not allow a sugar-boiler to work without one. We have no doubt that if you persevere you will soon attain the necessary skill in using it.

C. W. G. (Surbiton) *Sensational Journalism*.—Such sensational articles are evidently intended as big advertisements to take advantage of the gullibility of the British public. The one you send must be taken *cum grano salis*, as it certainly shows gross ignorance or deliberate misrepresentation, and does not speak well for either the school or the instructor. Such articles do bee-keeping more harm than good, for "how to make a fortune" is always an attractive title, and is one that is drawing money from people's pockets every day, and the more sensational the statements the easier it appears some people can be gulled. It is even quite possible that people will believe that a hive in Clerkenwell, containing 60,000 bees, "makes an average yearly profit of £4," or that at the advertiser's apiary "they will learn more in half an hour than they would in fifty books." We would sum up the whole article by the word "fudge." The acme of impudence is reached when we are told that "The King is one of the foremost bee-keepers in Britain"—a random shot very wide of the mark.

*Honey Samples.*

A. C. S. (Norwich).—The honey is rather thin though of good flavour. It should be shown in the light class.

## Editorial, Notices, &c.

### REVIEW.

*Survival and Reproduction*, by Hermann Reinheimer (London: J. M. Watkins, Cecil Court, Charing Cross Road, 7s. 6d. net.).—This is a sequel to the author's previous work, "Nutrition and Evolution," in which he dealt with the evolutionary significance of nutrition, and showed it to be of far greater importance than has hitherto been conceived in biological work. He also endeavoured to demonstrate that stability and permanence of individual and racial existence depended primarily on a state of the nutritional life and on the observance of proper metabolic ratios, and finally reached the conclusion that parasitism in the widest sense of the term was responsible for the majority of improper ratios which resulted in disease, in antithetic morphological and racial developments, and in degeneration generally. In that book the author provided a first instalment of a study of the cumulative (physiological, morphological and pathological) effects of nutrition and its teleological significance in general, and endeavoured to show that "selective" philosophy was standing on its trial. In the volume before us he continues the criticism of what he believes to be the impending "principle" of selection, and endeavours to establish the teleological rationale of preservation and survival as adumbrated in the previous volume. The wider standards of usefulness which he is endeavouring to introduce have their foundation in the universality of facts observable throughout nature, and lead him to the conclusion that whatever is physiologically healthful will be found to be both ethically and æsthetically desirable. The author shows that the growth of disease is marked by an invasion of waste matter forming the soil for microbes, by plethora, structural abnormalities, and loss of generic architecture, and such developments are fostered by, and were inseparable from, parasitism. This term is used to connote every condition whereby one organism lives in any way predaceously, stealthily or indolently, i.e., retrogressively by the work of others. Parasitism, according to the author, is a pathological state, and teaches the lesson how not to survive. The partaking of inappropriate food is prejudicial to selection, and by its continual use the soil has been provided for non-pathogenic bacteria to evolve slowly into pathogenic forms. To this cause he attributes the extinction of many animal types. Reproductive functions are associated with nutritive functions, and the author concludes that to the animal plant food alone supplies appropriate concordant with the requirements of stability, and only when the nutritional duties of life are satisfactorily fulfilled can the development of sex assume right proportions. The case of a larva destined to become a worker bee, but changed into a queen, illustrates how teleological status is affected by nutrition.

In the first part of the book before us the author reviews the theories of "natural

selection" of Darwin, Kropotkin, Malthus and others, and endeavours to show that Darwin was biased by the malthusian theory which premises that "the constant tendency in all animal life is to increase beyond the nourishment prepared for it"—as were also the other investigators—a theory which is no longer tenable. In the second part of the book the author deals with nutrition and reproduction, and explains that they are means towards the attainment of stability and progress, which becomes apparent in the ever-increasing beauty and serviceableness of forms. The good effect of plant nutrition (which he terms "cross-feeding") as opposed to infeeding, are analogous to those of cross-fertilisation in plants (as opposed to self-fertilisation). In Chapter V., parthenogenesis is fully dealt with, both as regards plants and animals, in the former of which it is rare, but certainly occurs in some of the lower forms. It is, however, more common in rotifers, crustaceans and insects, of which bees are a notable example well known to our readers. Parthenogenetic ova are regarded as imperfectly differentiated female cells, retaining certain male or katabolic characteristics, parthenogenesis being a degeneration from the ordinary process.

The author further traces the connection between startling increase and parasitism, and concludes that exorbitant fecundity like many another startling phenomenon of reproduction, is a symptom of pathological development attended by loss of survival-capacity. This he shows to be due to nutrition, a redundancy of which causes degeneration. The work is a closely reasoned treatise based on close observation of biological facts, and deals with the fundamental laws governing reproduction in its relation to nutrition, and its tendency is in harmony with the most recent biological research. We recommend the book to our readers, as it will quite repay a careful study.

### WHITBY AND N.E. YORKS B.K.A.

#### LECTURE ON BEE-KEEPING.

Under the auspices of the newly formed Whitby and N.E. Yorks B.K.A., a public meeting was held on January 28th last at the Marine Cafe, Whitby, when Mr. L. S. Crawshaw gave an address on "The Advantages of Bee-Keeping." Considerable interest was evinced in the gathering, and it augurs well for the future of the recently formed Association that the meeting was so well attended and so successful. The chair was occupied by Mr. A. E. Cooper, who, in introducing Mr. Crawshaw expressed his pleasure that the meeting had been called, and that the hopes which several of them had had so long were about to bear fruit. They would not be disappointed in the lecturer, and they would all be led to further efforts in promoting the most interesting hobby which, he thought, anyone could take up. It would lead to their keeping bees on a more humane and thorough system. They had enjoyed reading Mr. Crawshaw's

writings, and he had pleasure in asking him to give his address.

Mr. Crawshaw, who was received with applause, gave an interesting and able lecture on the subject upon which he had been asked to speak, in the course of which he touched upon the pleasure associated with the hobby of bee-keeping, and the generous and helpful spirit it engendered amongst those following the pursuit. Mr. Crawshaw also spoke of the value of honey as a food and a medicine, and the benefits which bee-keepers conferred upon fruit-growers and horticulturists through the activity of bees as pollinating agents. He concluded his address by referring to bee diseases, and the necessity for such associations as their own, in order that the knowledge of how to keep bees in a healthy and profitable manner might be spread.

Mr. Hood spoke on the skep system, and on the question of swarming. He said he had not been able to get sufficient swarms, and an association was needed, to put bee-keepers more in touch with one another. He said that bar-frame hives were mostly used in the district; but the substance of it all was that a man must be a bee-keeper, and not a keeper of bees. This heather district was most advantageous for skep honey, and one man, near Pickering, bought a field out of the proceeds of it.

Mr. W. E. Richardson (Leeds), Yorks B.K.A., spoke, endorsing what Messrs. Crawshaw and Hood had said, and hoping that the Association would be successful. Leeds people wanted heather honey, whatever the price.

Mr. H. S. Horne moved a vote of thanks to Mr. Crawshaw. He said Mr. Crawshaw's address had been interesting and eloquent, and he hoped they would have the pleasure of listening to him again. Mr. W. Burn, in seconding this motion, said the address had been of a very interesting nature. He thought the Association would "go," when now started, as there were several enthusiastic bee-keepers, and the stuff for the bees to gather. He could always sell more honey than he could get.

The chairman supported, endorsing Mr. Crawshaw's remarks as to the freemasonry of bee-keeping, and asked for a cure for foul brood.

The vote of thanks was carried, with applause.

Mr. Crawshaw thanked them. He did not know a certain cure for foul brood, but it was foolish to attempt a cure by drugs, which might, however, be used as a preventive. For foul brood, he would devote one of the diseased hives to the purposes of a cure, and treat it as a hospital colony. He then detailed the plan.

Mr. C. R. Pinkney also spoke, observing that he could, at present, dispose of all the honey that could be produced by those in the room, at good prices.

Some discussion took place as to the making of candy, and the meeting was concluded by votes of thanks to the chairman, seconded by Mr. Pinkney; and to Mr. Hood for the use of the room.

It was decided to hold branch meetings in the country districts, wherever bee-keepers can arrange an attendance of eight or ten, when brief addresses on bee-keeping subjects will be given, to be followed by a discussion. The hon. secretary will be glad to know where such meetings are desired.—P. C. FRANCIS, hon. sec., Laurel House, Wellclose Square, Whitby, Yorks.

## AMONG THE BEES.

### FUMIGATION.

*By D. M. Macdonald, Banff.*

Of old this process meant something different to what we understand now when we apply the term. Bees were stupefied by puffball. A fumigator was simply a subjugator, whereby "bees were totally subdued without being injured in the slightest degree, and then dealt with as if they had neither stings nor wings," as Nutt tells us. We have discovered a new and more excellent way for bringing bees under discipline.

Fumigation is now carried out to preserve combs from various enemies, among them being our arch enemy bee pest, wax moth, etc. I promised some time ago to give a short description of the fumigating chamber used at the W.B.C. Apiary, Luton. It is in the form of a cupboard, 7 ft. high, 6 ft. wide, and 19 in. deep, inside measure, and will take fifty-six supers in at one time. To make it air-tight it is papered throughout with a double thickness of brown paper, floor and door as well. The doors fit into a rebate all round, and also at the joint, and this is lined with felt so that none of the fumes can escape.

The process followed is to put under each pile of supers an empty section rack, on which stands an earthenware dish containing about 5 oz. of a 10 per cent. solution of formaldehyde and a piece of washing soda the size of a walnut. This makes the formaldehyde give off the fumes much quicker. Each set stay in about two months. Racks and shallow frames are all dealt with alike. The illustration, from a photograph, will give a good idea of the fumigating chamber.

*Matter Up to Date.*—We have had a very open winter, and for over three weeks, from the middle of January onwards weather was spring-like and mild.



A very much needed cleansing flight resulted, as the cold snap coming on in October, followed by a prolonged spell of excessive rainfall, suddenly confined bees without any warning or preparation for withstanding a long siege. Such an unprepared-for imprisonment, following a period of lusty roaming far afield, I have formerly noted tends to produce dysenteric symptoms, and this year it has resulted in a few cases of severe soiling of hive entrances. Now,

entrance. It is now where all bad mice go!

*An Open Question.*—"Honey in its purity breeds the hardiest bees. The further you travel along the road of feeding any other sweet, any other foreign subject, the more will you promote a tendency towards degeneracy in the race of bees!" Is this simply a pestulatum, or does it convey a great truth? Leaving out of consideration for the present the quality of the sugar

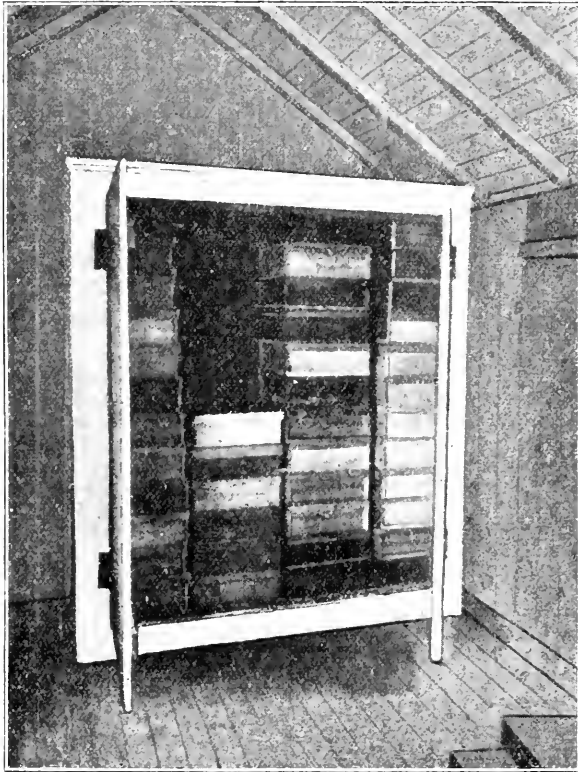

FUMIGATING CHAMBER AT THE "W.B.C." APIARY.

with a re-arrangement of stores, and a re-clustering of bees, a stormy time, or a period of long imprisonment, can be met with equanimity. If we trust to the old saw we have a period of storm ahead before bees are safe. "If Candlemas is fine and fair half of the winter's to come, and mair." Mice secured a lodgment in one hive. I killed seven out of eight. Some time after this, No. 8, I presume, *shifted the slide*, and once more obtained an

employed in feeding, it may be pointed out that bee-keepers in many lands believe that wintering is more successfully carried out with a syrup food, stored in the brood cupboard. Many Canadians accept this as a rigid truth and practise what they preach. Some in this country hold the same doctrine and act according to its tenets. Good syrup would certainly be better than bad honey every time, but that is not the point. It is not as a winter food we are

regarding the subject, but as a healthy food for immature bees. Can the nurses make as nourishing, healthy, and stamina generating food from a substance that in many essentials differs from the food Nature decreed was the proper one for them? I am, on other grounds, a strong advocate of natural stores, unless under very exceptional circumstances, and then only under compulsion do I ever feed artificially prepared food for bees. Under emergency requirements it is an important substitute. Now, without reasoning the matter further, let me end with a question—Does sugar feeding tend to produce degenerate bees?

*Electric Embedding.*—Perhaps H. Siebel (8035) and W. A. C. (4077) had better consult someone who knows more about electricity than I do, as a practical man's advice is always safest. Messrs. Lees' current is obtained from their lighting circuit, but as the direct current, as might naturally be supposed, would be a great deal too powerful for the purpose of embedding, "inefficient resistance" is brought into operation to reduce the current to the proper amount required. This resistance is enclosed in a small box-like arrangement on the operating table, and its regulated operation supplies three degrees of intensity, slow, medium, and fast. In cold weather the last is used, and at other times the medium suits the purpose best.

*Urbanity.*—If Mr. Woodley had stated on page 34, wherein my supposed lack of urbanity consisted, I would have known how to answer him, but as he affirms that he himself would do exactly as I advised, his suavity non-plusses me. I rather admire urbanity, but when it approaches inanity it ceases to be a virtue. Turning the other cheek may be apostolic and very fine in theory, but it appears to me rather quixotic in a case like the one I dealt with.

*"Hands' Device."*—This newly invented American swarm controller was not condemned by me. Rather, I think I blessed it, and hoped it might prove a success. Let B. B. (8041) by all means carry out his resolve to experiment with it this year, and may all good luck attend his efforts. I would

regret it if anything I contribute hinders experimentation, yet in regard to many "devices" I would advise *Festina Lente*.

---

#### HONEY IMPORTS.

The value of honey imported into the United Kingdom during the month of January, 1911, was £779.—From a return furnished to the BRITISH BEE JOURNAL by the Statistical Office, H.M. Customs.

---

## Correspondence.

*The Editors do not hold themselves responsible for the opinions expressed by correspondents. No notice will be taken by anonymous communications, and correspondents are requested to write on one side of the paper only and give their real names and addresses, not necessarily for publication, but as a guarantee of good faith. Illustrations should be drawn on separate pieces of paper. We do not undertake to return rejected communications.*

---

#### BEEES IN BERMUDA.

[8089.] As a sequel to my inquiry in B.B.J. last November regarding the importation of bees to Bermuda it may interest you to know that my venture was entirely successful, and so far as I am aware, the bees I brought over are the only blacks on the islands.

There is one apiary of Italians here owned by an American, and kept in "box hives." On account of the hordes of ants it is necessary to isolate the hives, and his are placed on a two-tier stand, the legs of which have a paraffin guard attached. Excepting one stock all his colonies seemed very weak when I saw them, a fact I attributed to excessive swarming last season, a thing which seems to be the only evil I shall have to guard against. Prices for produce are up 75 per cent. here, as compared with those at home, and the possibilities of a fair yield seem good.

My bees were released at 8 p.m. (fourteen days after their confinement three thousand miles away). They were a late driven lot hived on four combs (partly stored), and I estimate there were only about two hundred dead; and as they had brood when they started, and were pollen carrying before mid-day, the day after their release (December 4th), which they have continued to do ever since, a goodly part of the stock now are bees raised since landing.

There is no provision in the colony's tariff for "wild animals," not that I doubt that the customs' official would have found one, had he only thought his eyes read aright the plainly displayed label. Consequently I cannot enlighten you as to what the duty might have been. I intend to work all my stock strictly on British methods, and hope at the end of the season to be able to

furnish you with a statement of my results as compared with that of the American gentleman I have mentioned. I greatly miss that extremely handy person the "middleman" here. I find I shall have to import direct from England, or make everything I need, and after waiting five weeks pay 10 per cent. duty on its value. This, however, will be compensated for, when I draw a dollar for three nicely filled sections in the time to come. Wishing that all those interested might have a good share of the glorious weather we enjoy here.—A. F. LEANEY, R.A.M.C., Prospect, Bermuda.

### FIGHTING FOUL BROOD.

#### NEED OF LEGISLATION.

[8090.] May I lay my sad case before you? I am now entering on my fourth year of bee-keeping. Enthusiastic to the last degree, I have, as far as I know, omitted nothing, failed in nothing, spared neither time, thought, trouble or expense, to ensure success, and yet have nothing to record but absolute failure.

I may say that before starting bee-keeping I subscribed to the B.B.J., and possessed myself of the "Guide Book," the "Note Book," the "A B C and X Y Z of Bee Culture," and all the literature I could lay my hands on dealing with the subject. I had read, re-read and studied these, and from a theoretical point of view I could have passed a fairly stiff examination in the science before I had become personally acquainted with a bee. I had studied many catalogues, and rightly or wrongly, I had fixed on a double walled hive, holding ten frames and a dummy.

My hives were all new, and after use were always scrupulously cleaned, washed with disinfectant, sand-papered, painted and attended to with the utmost care, as were all the utensils and accessories before being put in use again. The roofs I covered with calico and painted. I have glass quilts on the frames, allowing a bee-way between the glass and the frames, with a 3in. circular hole in the centre, covered with a square of glass for feeding purposes. Each hive has four or more quilts, besides, of  $\frac{1}{4}$ in. felt, and a cushion of woollen material over all. The hives stand upon wooden platforms, raised on bricks, about 6in. from the soil, extending 3ft. in front of the alighting board, with a slightly downward slope.

In April, 1908, I bought a stock of hybrids from a well-known and reputable dealer. On the 16th May I got another stock of hybrids from an expert friend, without a queen, and introduced an Italian queen from abroad.

On the 9th June I bought a swarm of Italians from a well-known Italian firm. By August all three stocks were flourishing, and I had about 30 lbs. of surplus, when, on the 29th the friend from whom I had got the stock in May came to help me to remove the supers, and discovered incipient foul brood in No. 1 stock. Following his instructions I managed to rid that stock of

the disease, and all my stocks wintered fairly well.

Next year, 1909, I determined to increase my apiary. On May 3rd it was examined by the County expert, and the stocks pronounced very strong and quite free from disease (I had by this time joined the B.B.K.A. and the County Association). On the 22nd May, No. 1 swarmed and I successfully hived the swarm.

On the 8th and 9th June I made two artificial swarms from Nos. 2 and 3, and introduced Italian queens obtained from abroad, and later I made an artificial swarm from No. 1. Of course, I was working only for increase. By July, therefore, I had increased my stocks to seven. On the 24th of that month I found foul brood in No. 3, and reported it to the County Association, and asked for a visit from the expert. On the 29th he came, and confirmed my suspicions. The stock was condemned and destroyed. On the 27th August I found foul brood in No. 1, and that was destroyed.

Each hive in which foul brood (the mild, or inodorous, form) had appeared was removed to a distance, the frames and combs burnt in a stove, the hives washed and syringed with a strong solution of almost boiling carbolic acid, when dry carefully scorched in every nook and corner with a painter's blow-lamp, the quilts burnt, the glass quilt boiled in carbolic solution, the hives themselves painted afresh, and not used again for months, and the platforms and the ground all round watered with a hot solution of carbolic acid.

In the late autumn of 1909, therefore, I had only five stocks to put into winter quarters. These I fed liberally with thick, warm medicated syrup, most of which was sealed, and for greater safety I gave each a 2 lb. cake of medicated candy. With a glass quilt it is easy to inspect the condition of the hive during winter without causing the least disturbance. In January, 1910, I found No. 6 was suffering from dysentery, and on the 27th February it was dead.

Thus the spring of 1910 found me with only four stocks. On the 17th May I had my annual spring visit from the County expert, who gave me a clean bill of health. Now, thought I, I have at least overcome my troubles.

I bought a stock of "extra golden" bees, and re-queened three of my stocks with extra golden queens. On the 12th June (a Sunday, of course), a swarm issued from No. 2, and made for a woodyard near by, which, equally, of course, was locked up, so I could not follow it, and on Monday it was gone.

This has been, as you know, a wretched season near London for honey gathering, and I did not get much more than 20 lbs. from all my five hives, but all had plenty of stores in the brood chambers.

In September, when removing the supers, I found Nos. 1 and 3 badly hit with foul brood, and they had to be destroyed, as before, and only 2, 4 and 5 went into winter quarters. Last month No. 4 died of

dysentery, and to-day I find No 5 has done the same. So here I am, beginning my fourth year as I began my first, with one stock.

You will naturally say: "You wintered your bees on unsealed stores." Not so. Each hive was copiously fed on thick, warm medicated syrup, most of which was sealed, and when they were put up for winter, almost all the unsealed stores were removed, and in addition to sealed stores, each hive had three full-sized frames filled with medicated candy. The County expert superintended the work.

My house is certainly not five miles from Charing Cross, but it adjoins a large park, and has dozens of full-grown lime trees in the immediate neighbourhood. I have flower gardens and hundreds of fruit trees all round me, and, in patches of varying sizes, there must be very many acres of clover within a two-mile radius.

I know of no one else who keeps bees within that radius, but I have reluctantly come to the conclusion that there must be someone who does, and whose hives are rotten with foul brood.

Such is my tale of woe! Can you offer any solution of the cause of my twin troubles—foul brood in the summer and dysentery in the winter? Let me at least claim your sympathy.—"DEPRESSED."

[You certainly have our sympathy, and yours is only one more added to the many cases which show how difficult it is to keep bees free from disease, in a neighbourhood where probably some careless or ignorant bee-keeper has foul brood in his apiary, and does nothing to get rid of it. You have evidently done all that you can to cure the disease in your hives, and the repeated outbreak is probably caused by your bees visiting some infected hive. With respect to dysentery, this is usually caused by bad food, damp, and the bees consuming pollen when they are not able to have cleansing flights, and therefore discharge their excrement in the hives. Sometimes if the syrup is made in a copper vessel, unless this is scrupulously clean, bees are liable to suffer, and if such vessels are used, acids and other medicaments should be added after the syrup is removed, as they are likely to act on the copper.—ED.]

#### ROSS-SHIRE NOTES.

[8091.] A recent reference to Simmins' double colony hive reminds me that no report of this system of working has yet appeared in the B.B.J. Like the "Wells" plan, it makes use of the dual queen principle, with the difference that only one stock is supered, and the entrance of the other is so arranged that its working force is diverted to the supered portion.

When the weakened lot has built up anew, it, in its turn, is supered, and receives the working force from the other side, which is then deprived of its surplus honey.

Personally, I have experimented on similar lines with a modified "Wells" hive, an

adapted entrance block being used to shunt the incoming foragers in either direction, as required. The first trouble was that six racks of section failed to hold all the bees, great numbers clustering outside the supers. The enormous population gathered honey quicker than they could seal it over, and then swarmed out, leaving most of the sections full, but unsealed.

I fancy results would have been better if both stocks had been supered with three or four racks apiece in the usual way.

Under different conditions the scheme might have been a distinct success. Given an early honey flow, with stocks below par, it would be quite feasible to unite the working force of two colonies on the best frames of brood, with one queen, allowing the other to build up her hive for the late crop.

*Winter Contraction.*—I have had colonies winter finely on six frames, and on ten, also, in double and triple storey hives. Even a stock left with four racks of partly stored sections over winter came through all right, and duly stored an 80 lb. surplus.

Bees are hardy little creatures, and if numerous enough will winter safely under almost any conditions. Instead of contracting the medium colony for winter, strengthen it by the addition of more bees and a prolific queen. How was it that the Pettigrew skeppist secured results rivalling the modern frame hive? The old bee-masters used skeps having double the capacity of the present-day straw hive, and giving full scope to the most prolific queens. Such hives were very populous, and the swarms from them large and profitable. Then as the honey flow closed, the swarm was driven and united to the parent hive. These were the colonies that filled the old time 90 lb. bell glasses with honey.

We work on different lines now, but the principle of the great skeppist still holds good. Given a strong colony, with a prolific queen, I should expect the best results from autumn expansion of the brood-chamber. A stored, shallow super placed above the standard frames in September ensures safe wintering, and a large population when the days come for honey gathering.—J. M. ELLIS, Ussie Valley.

#### SELF-PRESERVATION.

[8092.] It is now an opportune time to appeal to bee-keepers who have lost bees during the past few months from Isle of Wight disease. Those who have experienced it know how very disheartening it is. Disgust is the first-born of disappointment, and when one gets disgusted anything may result. In the case of an enthusiast the thing is faced and put right; but in the case of an unwilling convert, or of a person who has not much leisure to devote to his bees, or again, of a cottager whose consequent outlay has to be seriously considered, and to whom the risks accordingly seem very great, bee-keeping becomes a dream ending in an unpleasant nightmare. Often the tenantless hives are left in exactly the same condition

as when the bees died. Robbing ensues, till all the infected honey is gone, and thus the disease is carried to most, if not all, of the surrounding apiaries. When the honey is all gone the wax remains; the wax moth takes advantage of the circumstances, and the district becomes infected with this "undesirable."

This I know to be the case. In one instance of which I have personal knowledge, a man who had over twenty hives, and made them pay, is now chopping them up for firewood! Another bee-keeper declared that his stocks were worth £30 in spring, and they were not worth that number of shillings in autumn. Two other cases I know, of hives left absolutely untouched for a long time. These are all within the one-mile radius. It would be different if they even closed the entrances of their hives and prevented ingress of other people's bees. But they do not, and there the matter rests, representing, I should estimate, the greatest source of infection.

Now this sort of thing should be stamped out as thoroughly as possible. We must realise that no amount of *clamouring* for Bee Disease Legislation will move us one step forward. More can be done at present by helping others, and thereby oneself, for no one at present can feel immune from infection.

In the case of the "unwilling convert," who has taken apiculture up to satisfy an enthusiastic friend (who is a bit of a bore with it), give him a start with disinfecting the first hive, lend him your copy of Maeterlinck's "Life of the Bee," and if he fails to see beauty in the life of the bee then, or does not appreciate their industry after giving him a sample of your choicest honey, discourage him, discourage him heartily, for commonsense passes severe judgment on "slipshod" apiarists.

A little more time will be required to rectify matters in the case of the person who has not much time. Try to sacrifice your own time and interests a little, give him a little more help in disinfecting, etc., and when all is well again, keep in constant touch with him, and directly the danger is sighted take prompt measures to prevent it spreading.

Then for the cottager, with whom the expense of a fresh start is the deciding factor, the promise of a swarm in the coming season, on condition that the apiary is cleaned out to the satisfaction of the person offering the swarm, would prove a wonderful incentive.

I lost my bees last season, so am not in a position to offer swarms, but I have cleaned and disinfected one apiary right through with no direct advantage to myself, and am negotiating about others. I hold no official position as regards bee-keeping, but am relying simply and solely on the commonsense and good feeling of those visited.

I appeal therefore to all brother and sister bee-keepers in infected areas, first, to destroy all stocks having I.O.W. disease, and thoroughly disinfect the hives, secondly,

to close the entrances to prevent robbing, if the dead stock cannot be seen to at once, and thirdly, to help others who are not so keen, with a view to self-preservation. Now is the time to wage war, before spring comes and we are wanted in our own apiaries, and before short stores drive the bees to robbing again.—G. STEVENTON, Bisley.

### CAPPINGS OF COMB.

BY L. S. CRAWSHAW, NORTON, MALTON, YORKS.

*The No. 1 Gland System* (p. 8).—The reasoning which Mr. Bullamore advances seems to me so sound and conclusive as almost to dispose of the theory that this system automatically atrophies in two weeks' time, and the case of a swarm which he cites is even stronger if a virgin queen be supposed at the head of affairs. Clearly, the larvæ must be fed, and by bees which are over age.

Our knowledge of these things is necessarily somewhat empirical, and it is not easy to suggest a test which shall be absolutely above criticism. The isolation of some Italian swarms in a black bee district, and the periodical removal of all mature brood, for, say, two months, would overcome the objection that swarms may be re-inforced by younger bees, called to their aid by the foragers. It is beyond question that young bees are accepted by strange stocks.

Mr. Bullamore's argument is not so clear when he says "that we should find unsealed brood right up to the time that the first eggs were hatched." Where would the unsealed brood come from?

P.S.—A re-perusal of this in search of a possible misprint suggests that it should read: "the first bees," in other words, bees from the first laid eggs. That suggests that we need a distinctive term for the hatching, or emerging, of the adult bee.

*Queen Introduction* (p. 11).—This method of introduction by saltpetre fumes promises well, but will it perform? If the bees are not stupefied by the fumes, will they not make a sudden and stragetic movement to the open? Whilst if the fumes are sufficiently strong to prevent this, will the queen have the sense to know that the inferno thus offered to her is to be her future home? Perhaps there would be neither entering in, nor going out, if the keys of the gate were kept by "St. Petre." But would opening the entrance for a brief period allow the fumes to escape, supposing the entrance to be at the bottom? Of course, these directions may not exactly apply to our type of hive, although I know of no reason for supposing that the writer uses another type, except his references to "all openings," and his manipulation from the "side" of the hive.

*Bees in Agriculture* (p. 22).—If we may take these figures as a correct estimate, viz., 20,000 as the average number of foragers, and 80 per minute as the number of flights, it appears probable that 100 flowers per bee per diem is an under-estimate. For upon the figures, more than half the bees (12,000) would only make two journeys in the ten-hours' day. If this be so, it follows that

the bee must be absent from the hive either for a longer period than would enable her to visit 50 flowers, or, taking this time as a maximum of 20 minutes, that there can only be about 7 per cent. of the foragers absent at any one average moment. If these figures are even approximately accurate, they throw an interesting light upon the economy of the hive. If a forager only forages for 40 minutes, more or less, in any one day, what does it do for the rest of the 24 hours. One finds bees resting in the hive at all hours of the day, but not in such number as the figures would imply. As to the number of bossoms actually fertilised, it is possible, judging from personal observation, that a good deal of time is wasted in profitless visits to flowers already robbed of their treasures, and in investigation of immature blossoms.

*Feeding the Young Larva* (p. 26).—Does not this small bit of winter life-history here sketched out by "Guardian" meet the difficulties raised by the Rev. A. R. Downes-Shaw? Perhaps the latter will give us the theory which he promised when he opened the subject.

*The Co-operative Honey Company* (p. 26).—There is a lot of sound suggestion in Mr. Reader's letter, which at least gives one to think furiously. A discussion on the subject, at least, say, at one of the conversaciones, might be of value as indicating whether it would receive more than verbal support. Such support might, however, be more readily forthcoming from the younger and more enthusiastic members than from the older and more experienced. First of all, one would want to know all about the rocks upon which past ventures were wrecked. I believe that at least one member of the British Honey Company objected to have her good honey mixed with inferior products. Such objection might not be removed even if honey were bought, as suggested, upon its merits. Carriage charges to and from a depot would be a heavy item, and after all, the business would rest upon the ability of one man. Is that one man available? If not—!

*Comb-Foundation and Foul Brood* (p. 27).—If it be true that boiling (in water) does not kill the spores of F.B., whilst at the same time foundation made from infected combs is innocuous, it follows either that the spores are removed from the wax (or killed) during the processes of cleaning, or that they become encased or impregnated by the wax in such a way as to prevent their development. I prefer to believe that the several heatings dispose of the gentry, but either way is satisfactory if we can be sure that foundation is sterile.

---

## Queries and Replies.

---

[4084.] *Bees Dying in Well-provisioned Hive.*—Last October, I had a present of a hive of bees. I examined them a few days after

they arrived, and found them fairly strong, with bees on ten frames, which were three-parts full of honey. I started to feed them, but after taking down two jars of syrup they refused to take any more, as bad weather set in, so I covered them well up for the winter. One fine day last week I looked at all the hives, and found this stock dead, with plenty of honey, sealed and unsealed. There were about thirty live bees on the back frame, but I think they were bees from my other hives, robbing. I at once burnt the dead bees, wax, and honey. Please will you tell me, through the Journal, the probable cause of them dying? I found the queen dead at the bottom of the hive.—G. M., Tadcaster.

REPLY.—The bees had evidently dwindled somewhat in the late autumn, and therefore they were not sufficiently strong to keep up the temperature during the winter, and died from cold.

[4085.] *Transferring Bees.*—Last September I bought some bees in a butter box, 13ins. square. They were provided with stores, but I gave them candy in December, over a 4in. feed-hole in top of box, and packed them in W.B.C. stock box, surrounded with cork dust. They were flying on 17th and 19th January last. If I place over the top of the box they are in a W.B.C. body-box, or a super of shallow frames with foundation, will the bees come up through the feed-hole, leave their present box, and work out the new foundation in spring, so that I may remove the old box and leave them in W.B.C. hive? Will you advise me, please? I should be glad to see an elementary weekly course in B.B.J., that we small holders, anxious to take up bee-keeping, could do so with confidence and success.—H. C., Essex.

REPLY.—Instead of putting the frames above, put the brood chamber in its proper place with frames fitted with full sheets of foundation. Place the box with bees above, and let them work down, as if they were in a skep (see Guide Book, page 150). We decided some time ago to carry out what you suggest during the coming season. The Guide Book is so simple that we are surprised at your difficulty.

[4086.] *Moving Bees, and other Queries.*—May I trouble you with one or two questions, the answers to which I thank you for in anticipation. (1) About the beginning of August I obtained two small stocks, and a late swarm from a friend, the stocks on three frames each (more properly called nuclei, I suppose). Being short of hives, I put them into one hive, divided with a tight-fitting division board, and gave each lot two frames, with full sheets of foundation, one on either side. I also made a separate entrance for one lot in the side of hive; they were fed up well, and were breeding nicely well into October. To enable me to feed regularly, I kept these in my garden, where they still are, but they will be shifted to my out-apiary in due course. What is the latest date they may be safely left to before moving, and (2) are they likely to make serviceable stocks for next season? (3) When may I start stimulative feeding for these and the

other stocks at the out-apiary, and as the latter is over two miles away and inconvenient to visit more than is quite necessary, (4) would it suffice to give each stock a pint jar of syrup, with two, or even more, thicknesses of calico tied over, about once a week? (5) When should the two stocks in one hive be separated? (6) As I am a little doubtful as to the sufficiency of stores in the weak stocks, will it do harm to give candy, if wanted or not, as a safeguard? Should the candy be given under or on top of quilts, over feed-hole? (7) What size should cakes be, and I suppose enclosed in a frame with a piece of glass on top would be best. (8) What is your opinion of Alexander's method of increase (A B C of Bee Culture, page 279, 1908)? Would it be suitable for this, a clover district, with fair amount of apple blossom, etc.—A. S. C.

REPLY.—(1) You can move them as late as April. (2) Yes, if properly attended to and stimulated. (3 and 4) Beginning of April will be quite soon enough. Use a proper feeder, with holes in the cap, and give one hole. Calico will become close in texture, and the bees will not be able to get at the food if it is left so long. (5) The first fine day in March or April. (6) On top, over feed-hole. (7) A matter of choice. One or two pound cakes in a glass-topped box. (8) Leave it alone and stick to British methods, which have been tried and found successful.

---

#### CUMBERLAND B.K.A.

##### A CORRECTION.

In the report of the Cumberland B.K.A. annual meeting, which appeared in our last issue (p. 52), the name of one of the new vice-presidents was given as Mr. Bermair. This should have been Mr. F. E. T. Jones-Balme. We have received from the Hon. Sec. the combined schedule of the annual exhibition of the Carlisle and Cumberland Horticultural Association, and the Cumberland and Westmorland B.K.A. The show will be held in the Market Hall, Carlisle, on August 30th and 31st, and the judges of bees and honey, etc., are the Rev. R. McClelland, and Mr. Robt. Rymer.

---

#### OLD BEE LITERATURE.

(Continued from page 60.)

Closely they ply their work in their hives, and feed on the super abundance of their combs, knowing by mere instinct of Nature, that if they should not do so, and give vigilant attendance: Spiders would get into the hive, and there kill them. When they have but small store of honey, the most of them keeps the entrance that it may not be taken from them until they are better provided. A worthy president to

men, to banish all superfluous things out of their Commonwealth, lest by the meanness of them, the venom of hatred may be bred among them, which may procure the death of one another. And when dearth or scarcity happens in their cities, vigilancy is needfully required, to preserve such store as they have; that it may not elsewhere be transported, and so public calamity ensue thereon.

There are a kind of Bees which labour not to produce honey, but eat that already made, and they are longer than the other: the good Bees have continually war with them, to expell them out of their Commonwealth. Signifying to us, that slothful persons should be excluded from other men's company: and such as seek to feed by other's sweat. Their King never flies abroad, but he is attended round with a great company of Bees, and it so happen that they meet with another flight of Bees, that likewise have their King with them, they leave their owne to accompany the New King. And if their own King contend to reduce them again under his obedience; they kill him, and follow the other newly made choice of, and him they elect as their King. This excesse happeneth very seldom, and is one of the two imperfections which these creatures have in their government: beside, it is necessary, that in every kind there should be some vice. If they chance to sting hard they put forth the whole length of their sting; whereon themselves die withall, because their bowels issue out thereby.

Their Kings and Governors sting but seldom, although they are thereto provoked; for some say, that they have no sting at all. And Pliny is not certain, whether they have any or no: but notwithstanding, he is well assured they sting not: Neither care they that their King should be so armed, provided, that he be of good government, valiant, and majesticall: which proveth, that Princes ought to be benign, mild, and patient: never to take any delight in cruelty, but rather to be gentle and merciful. Such is the cleanliness of these creatures, that they cannot endure any foul, or noisome favour, and therefore when they return to their City or Castle (for such as they count their Hive to be) they discharge

their bellies in the air, and many times (through bad smells) they become sickly, and so soon as any one of them dieth, the rest hurl him out of their hive. They grow sick also through idleness, and therefore they will not suffer any to be slothful amongst them: and the smell of boiled fish, such as Creuses, Lobsters, and Crab-fish is deadly to them. An excellent example for men to live clean and neatly, free from a vicious life, carefully respecting both their souls and bodies.

(To be continued.)

## Notices to Correspondents

*Letters or queries asking for addresses of manufacturers or correspondents, or where appliances can be purchased, or replies giving such information, can only be inserted as advertisements. The space devoted to letters, queries, and replies is meant for the general good of bee-keepers, and not for advertisements. We wish our correspondents to bear in mind that, as it is necessary for us to go to press in advance of the date of issue, queries cannot always be replied to in the issue immediately following the receipt of their communication.*

S. E. H. (Birmingham) *Bees Suffering from Dysentery.*—From your description it appears that the bees are suffering from virulent dysentery, probably caused by bad food and confinement. As there are only enough bees to cover three frames we are afraid that there is poor chance of saving them. You can, however, try by transferring them to a clean hive and floor board on the first day it is fine enough for the bees to fly. Any soiled combs, and those containing honey should also be exchanged for clean ones. Feed the bees on candy, give proper ventilation, and disturb as little as possible. Reduce hive by division boards to the number of combs covered by bees, and protect them well from cold. No, do not place a hot water bottle on at present as it would excite the bees too much, and if they are not able to get out would do more harm than good.

C. W. S. (Surbiton) *Spring Feeding, etc.*—(1) You need not boil the syrup again, but simply mix the water—preferably hot—with it. (2) You can hardly feed up so small a lot of bees to do very much on apple blossoms, and the best way would be to strengthen them by uniting two or three lots together. It is too soon to commence feeding with syrup and artificial pollen, and only candy should be used at present. (3) You would have to depend on the lime trees for your surplus, as well as what the bees may gather from the miscellaneous

flowers in the neighbourhood. (4) The closer the bees are to the heather the better, but it is very doubtful if it would be worth your while to take your bees to either of the places mentioned, not only because you would get very little heather honey, but also owing to the prevalence of the Isle of Wight disease in the neighbourhood. We would therefore advise you not to move your bees.

J. F. A. (Northam) *Spacing frames and disinfecting.*—(1) The frames may be closed up again about the end of March, as directed on page 198 of the Guide Book. (2) Yes, the honey should be removed. (3) If foul brood is of the mild type either formalin gas or soluble phenyle will do, but you must bear in mind that neither will destroy the spores, and both depend on their efficacy in arresting the growth of bacilli. (4) Although it is possible to do without it, you can add one and a half teaspoonfuls of cream of tartar with advantage, as it will expedite the making of the candy. (5) It is not necessary to add pea-meal to candy where crocuses and gorse are plentiful. (6) Gorse flowers as early as February and March, but willows yield pollen in greater abundance.

### *Suspected Disease.*

C. T. (Malvern).—The symptoms are those of the Isle of Wight disease, and it is quite possible that this is the cause of death. It is difficult to say without having some of the bees for examination.

X. Y. Z. (Lewes).—The bees are dry and have been dead some time, but amongst other bacteria there appear to be spores of the Isle of Wight disease.

C. W. H. (Haslemere).—Your bees are suffering from dysentery and Isle of Wight disease.

J. T. (Barnoldswick).—Isle of Wight disease.

G. R. (Manchester).—1.—Bees have been dead some time, and there is no evidence of disease, so they have probably died of old age or want of food. 2.—The bees are hybrids.

The following sent bees which had been dead for some time, and dried up, consequently it is impossible to speak with certainty as to the cause of their death. They all contain various bacteria of decomposition:

SCHOOLBOY (Dursley).—Queen a young one, bees too dry.

BURNT OAK (Herne Hill).—Probably Isle of Wight disease.

J. W. W. (Stokesley).—Dysentery.

H. (Renfrewshire).—Bees came in very bad condition, and smothered with earth. Nos. 1 and 2, dysentery, stomachs filled with undigested pollen. No. 3 contain some undigested pollen, and apparently spores of Isle of Wight disease.

If our correspondents can send live bees from affected hive, we might diagnose with more certainty.



## Editorial, Notices, &c.

### REVIEWS.

*Echter Bienenhonig, ein wichtiges Nahrungs-u. Volks-Heilmittel*, by Reinhold Michaelis (published by A. Michaelis, Leipzig, price 40 pfg.—fivepence).—This is a capital little pamphlet of fifty-six pages, intended to instruct the public on the advantages to be derived from the use of honey and to popularise it. It commences by describing what honey really is, its nature and chemical composition. The author says that genuine honey is as easily distinguished from so-called artificial as real wine is from the imitation, and as there are no artificial apples, pears, cherries or eggs, so there can be no artificial honey. Honey is entirely the product of the bee. The next chapter treats of the different substances found in commerce in Germany under various names, simulating honey, and shows that the manufacturers which place them on the market produce them mainly from potato-syrup, prepared by subjecting potato-starch to the action of sulphuric acid. As this syrup is highly injurious to the human constitution, the author thinks it is quite time that the consumer was put on his guard respecting it. The various methods of testing honey and detecting adulteration are given, and there is a chapter on the different varieties of honey, their colour and flavour. Several chapters are devoted to the use of honey as food in the household, its use in medicine, and the methods of making honey wine. There are a number of useful recipes, and the author concludes with a chapter showing the pharmaceutical use of bee-poison.

*One-and-All Gardening*, Edited by E. O. Greuning, F.R.H.S. (London: Agricultural and Horticultural Association; price twopence).—The sixteenth year of this interesting Annual finds it full of life and vigour, and as popular as ever with lovers of gardens, for whom the publishers have provided a first edition of 100,000 copies. The editor devotes his opening article to a comprehensive plan for developing the work of existing Horticultural Societies throughout the Kingdom. These Societies he estimates at a thousand in number, with a quarter of a million members, whom he would convert into missionaries for the conversion of our country into a "Garden Land." The 128 pages of the Annual are, as usual, full of instructive articles and pleasant illustrations.

*The Selbourne Magazine*, Edited by J. D. Boulyer, LL.D. (published by J. Philip and Son, Ltd., London; price threepence).—The Selbourne Society has enlarged its magazine and printed it on art paper. Our readers may remember that for many years it was called "Nature Notes," but two years ago the old name of "The Selborne Magazine" was once more adopted. In the present number, Miss Hodgson, who has so successfully introduced nature study into the Croft School, gives some hints on the teaching of

natural history. There are many interesting natural history notes, and the number is thoroughly well illustrated. We notice, also, that a children's corner has been started. All particulars with regard to the magazine and the society can be obtained from the honorary secretary, at the new offices of the Selbourne Society, 42, Bloomsbury Square, London, W.C.

### BRITISH BEE-KEEPERS' ASSOCIATION.

The monthly meeting of the Council was held on February 16th, at 23, Bedford Street, London, W.C. Mr. W. F. Reid presided, and there were also present Messrs. R. T. Andrews, O. R. Frankenstein, G. H. Skevington, T. Bevan, E. Walker, J. B. Lamb, E. Gareke, W. W. Watts (Beckenham), E. R. Stoneham (Crayford) and the secretary, W. Herrod.

The minutes of the Council meeting held January 19th were read and confirmed.

Letters expressing regret at inability to attend were read from Miss Gayton, Messrs. T. W. Cowan, C. L. M. Eales, H. Jonas, A. G. Pugh, A. Richards, and Col. H. J. O. Walker.

The following new members were elected: Miss C. Campbell, 47, Lennox Gardens, London, S.W.; Miss D. K. Ernest, St. Stephens, Stanstead, Essex; Miss R. Saunders and Miss V. Kirby, Live Oak Canon, Redlands, California, U.S.A.; Sir Francis Walker, Bart., Swansfield, Alnwick, Northland; Mr. J. E. Buttle, Pretoria, S.A.; Mr. F. W. Moore, 10, The Avenue, Bedford; Mr. W. E. Richardson, 14, Carter Mount, Whitkirk, Leeds; Mr. A. J. Rex, 6, Mayfield Gardens, Edinburgh; Mr. G. Steventon, A.C.P., Elmfield House, Bisley, Surrey.

The report of the Finance Committee was presented by Mr. G. H. Skevington, the balance in hand being £80 8s. 9d. It was resolved that payments amounting to £8 4s. 6d. be made.

The draft report and balance sheet for 1910 was read, and it was resolved "That the draft report, balance sheet and income and expenditure account be approved and signed by the Chairman, and that printed proofs be submitted to the Chairman, Vice-Chairman of the Council, and Mr. Gareke for their final approval. It was also resolved that the names of the Presidents of Affiliated Associations be printed on the front page of the report as Vice-Presidents of The British Bee-keepers' Association, as per Rule 3.

The Secretary read replies received to applications sent out for use of room for annual meeting, and it was resolved "That the meeting be held at the Gardenia Restaurant, 6, Catherine Street, Covent Garden, London, W.C. (next door to Drury Lane Theatre). Arrangements were also made for papers to be read at the conversazione.

The insurance scheme for 1911-12 was considered, and the amended terms of Messrs. Heath and Co. were accepted. It was resolved that the registration fee to non-members be increased to one shilling.

Letters were received from the Rev. H. Ellison and Mr. J. Grimwood resigning their seats on the Council, and the same were accepted with regret.

The names of Mr. T. D. Sinfield and Mr. L. McNeill Stewart as delegates were submitted by the South Bedfordshire B.K.A., and accepted by the Council.

Mr. Gareke and Mr. Lamb were cordially thanked for their work in revising the literature of the Association, and it was resolved "That the proofs of the amended circulars be submitted to the Chairman and Vice-Chairman, Mr. Gareke and Mr. Lamb, for their approval.

Mr. Reid mentioned that a case for the display of objects of interest in bee-keeping was being reserved at the White City for the Cornucopia Exhibition, and that he would be pleased to hear from anyone having objects to lend.

The next meeting of the Council will be held on March 16th, at The Gardenia Restaurant, 6, Catherine Street, Covent Garden, London, W.C.

#### WORCESTERSHIRE BEE-KEEPERS' ASSOCIATION.

##### ANNUAL MEETING.

The annual meeting of the above Association took place at the Church House, Worcester, on February 11th. The President (Canon Coventry) was in the chair, and there was a good attendance of members.

The report of the committee mentioned the great benefit to beginners in bee-keeping the recent action of the County Council in making the Association the authority for instruction had been. It also urged the need of stronger measures against foul brood, which is very prevalent in the county. The President thought, and several members agreed, that experts had mistaken other complaints for this disease, and considered that a microscopic examination was often needed before stocks were condemned. The report was adopted.

The Treasurer's accounts showed a small deficit (£1 3s. 6d.) for the first time for some years. Mr. Millward, as auditor, stated that, notwithstanding the leaflet issued in the spring, there were still members paying the reduced subscription who should pay the ordinary one.

Mr. Leicester suggested that the officials might go over the list and request the full amount from such members. It was decided to consider the alteration of Rule V. at the next meeting, and the committee were asked to re-draft the rule in readiness. The Treasurer's statement was then passed.

The Rev. Canon Coventry was re-elected President, and the vice-presidents and officials were all re-appointed. Mr. Brierley's name was added to the committee.

Miss Johnson then distributed medals to such of the winners as were present.

On the motion of the Rev. J. Bowstead

Wilson, a vote of thanks to the officers was carried.

After tea, Mr. W. Herrod gave a lecture on "Diseases and Enemies of Bees" to an audience of over sixty. He dealt with the subject as fully as time would allow, and succeeded in interesting his hearers, in spite of having to deal with the unpleasant side of bee-keeping.—J. PHILLIPS, hon. secretary.

#### Obituary.

##### DAVID ALANSON JONES.

We regret to have to record the death of Mr. David Alanson Jones, of Beeton, Ontario, who was for many years one of the leading bee-keepers of Canada.

Mr. D. A. Jones was born near Toronto, on October 9th, 1836, and during his boyhood worked on the farm with his father, who kept bees, and among his earliest recollections was that of being carried by his father to the apiary to watch them working. At the age of five he knew pretty nearly all that was generally known about keeping bees in those days, and before the age of fifteen he hunted and captured bees on his own account, without any assistance from his father. In 1860 he went to Illinois, where he worked for a stockman, and in the autumn of that year he happened to attend an exhibition in Chicago, where he saw a bee-keeper manipulating combs covered with bees, and explaining the advantages of the Langstroth hive. His interest revived, and Mr. Jones took measurements of the hive, with a view to making a start in keeping bees on modern lines. He married Miss Jessie Macpherson, of Whitby, in 1864, and settled in Beeton, where he engaged in business as a merchant, in partnership with his brother. The business was carried on successfully for some years, but on his brother retiring, the store was sold, and Mr. Jones found the leisure to gratify his taste for bees, and made a start with two colonies in Langstroth hives. He afterwards established a business from which Beeton derived its name. In 1878 he commenced in a small way to manufacture hives and appliances, and six years later he built a large factory. In 1886 the business had grown to such proportions that the "D. A. Jones Co., Ltd." was formed, with a capital of 40,000 dollars, and the factory gave employment to a number of men all the year round. The two colonies soon became several apiaries, and during certain seasons the bees were moved to "Jones" Island, on the east shore of Georgian Bay. Mr. Jones also built up a large trade in extracted honey, and gave an impetus in Canada to the exhibition of small packages of honey at fairs and agricultural shows.

One of the great services rendered to bee-keeping was while Mr. Jones was head of this firm, and he will always be remembered as one who undertook the search for

new races of bees. It was in 1879 that he set out himself, at great expense, and amid considerable difficulties and dangers, to visit Cyprus and Palestine, in search of the races of bees in those countries. These he shipped to this country, and after having a flight they were re-shipped to Canada. As an adjunct to this undertaking, he established, on separate islands on Georgian Bay, apiaries where the different races could be kept in purity, or crossed at will. Great credit was due to Mr. Jones for this experiment, as he bore all the cost, and we know that it was not a paying speculation, as he was several thousand dollars out of

Messrs. S. Corneil, S. T. Pettit and R. McKnight. The exhibit was a grand display of the honey-producing powers of the Canadian Dominion, and consisted of forty tons of honey, chiefly from white clover. This exhibit did much to popularise honey here, and not only was it all sold, but by the sale of twopenny packages, many had the opportunity of tasting honey who had never done so before.

On October 6th an International Congress was organized by the British Bee-keepers' Association, which was attended by all these gentlemen with the exception of Mr. Pettit, who had to leave the day before. The



THE LATE MR. D. A. JONES.

pocket. In 1885 Mr. Jones founded the *Canadian Bee Journal*, and edited it until it was transferred to E. L. Gould and Co., of Brantford, and while actively engaged in business, he also found time to publish *The Becton World* and the *Canadian Poultry Journal*. In 1885 he published a small book entitled "Foul Brood: Its Management and Cure."

Bee-keepers in this country made the acquaintance of Mr. Jones in 1886, during the Indian and Colonial Exhibition, where he and three others were appointed Commissioners in charge of the Canadian Honey Department. The other representatives were

Colonial representatives received a hearty welcome. The company over which the chairman presided at the luncheon was a distinguished one, and included, in addition to the representatives of the Ontario B.K.A., the Chief Commissioner of Education for Ontario, Dr. May, and Pastor Descoulayes, representing the Swiss Association, as well as representatives from a large number of County Associations, and the leading British bee-keepers of that time. The day of the conference is one that will ever be remembered with pleasure by those present on the occasion. The feelings that predominated in the breasts of British bee-

keepers towards their Canadian brethren were hearty and sincere, and those feelings found a ready response in the hearts of those whom on this day we delighted to honour. At the meeting after the luncheon, the large Conference Hall was crowded, when Mr. Jones gave his interesting description of the system of bee-keeping and appliances in use in Canada. At that time the Heddon hive was much talked about, and Mr. Jones's remarks about it were listened to with great attention. At this meeting he also gave his opinion that it was useless to hope for any results by crossing of the *Apis dorsata* with other breeds.

In 1887 we paid a visit to Canada, and received a hearty welcome from the Canadian bee-keepers, who presented us with an illuminated address and gold-headed walking-stick, at a meeting in Toronto organized in our honour. At this meeting the bond of friendship commenced the previous year in London was further strengthened. A few days were spent at Beeton, and we had an opportunity of seeing the manufactory and learning of the multifarious interests which Mr. Jones had in the town, where he was much respected, and where he had gained the title of "The Bee King of Canada." In spite of his earnestness and energy, Mr. Jones was very sociable and jovial, ever ready to communicate to others the results of his investigations; he was also most charitable and kind, and will be deeply mourned not only by bee-keepers, for in his time he had done much for the advancement of the industry, but by all who knew him. We extend to the surviving relatives our sympathy in their loss.

---

## Correspondence.

---

*The Editors do not hold themselves responsible for the opinions expressed by correspondents. No notice will be taken of anonymous communications, and correspondents are requested to write on one side of the paper only and give their real names and addresses, not necessarily for publication, but as a guarantee of good faith. Illustrations should be drawn on separate pieces of paper. We do not undertake to return rejected communications.*

---

### NOTES BY THE WAY.

[8093.] The weather for the past fortnight has been open and mild for February, and on several days the bees have been very busy at the watering places, and some have been carrying in pollen from natural sources. I have not furnished a supply of artificial pollen yet, but shall give a supply in moderate quantities in a few days, if suitable weather prevails, for the bees to gather it. Those eaten cakes of candy referred to in my last notes have been replaced by a new batch, and all stocks responded to the roll-call. My neighbour, the young farmer mentioned, whose bees were catalogued for

sale, has decided to take them with him into Kent, as he is moving to a fruit farm at Kingswood, and I have just packed the hives for the journey for him. I found two lots starved to death, and three others nearly run out of food. These will probably also die of starvation long before natural food can be gathered, if not fed. Last autumn I impressed on him the necessity of feeding these colonies, but he has neglected to do so, with the result that he will lose half his apiary from a preventable cause. I mention this as a warning to others who may have neglected to feed their bees, hoping they may pull through without help. I say, for the sake of the poor, helpless little creatures, don't let them starve when food is so cheap. Good candy can be made at 2½d. per lb., and a 2lb. or 3lb. cake will carry them along till some food can be gathered in early districts.

I find I did not mention that that heavy bell glass (8042) was worked on the top of a straw skep, and that my bell glasses have always been worked (at least, my large ones were) on bar-framed hives.

Mr. Bullamore's excerpt from "Bonner's Book" (p. 55) does not, to my mind, convey the impression that the bees were suffering from the new bee pest, "Isle of Wight disease." The first period supplies the cause of their death, but this new bee pest, when once started in an apiary, so far as I can gather, it is beyond human skill to stop it. It is not a small matter of so many per cent. of the stocks in an apiary dying, but a 100 per cent. loss, as every colony, once infected, dies. If we had a Foul Brood Act in operation in this country, it appears to me that each bee expert or inspector working under the Act, after examining bees infected, or dead, with this Isle of Wight bee pest, would be simply germ carriers to other healthy apiaries, and that they would spread the disease far and wide. Those countries which have enjoyed the helpful (?) working of Foul Brood Acts are not satisfied with the results of those Acts. Michigan State, U.S.A., is the one now earnestly endeavouring to get a new F.B. Act. Editor Root, in *Gleanings*, says: "Foul brood is spreading at an alarming rate, and very stringent measures are necessary to stamp it out"—and this condition of things exists in Michigan, where an Act has been in force for several years. Even on the other side of St. George's Channel I hear from a F.B. inspector that they need more power than the present Irish F.B. Act gives the inspectors. Belgium points the way out of the foul brood difficulty in a friendly, simple manner.

My sympathies are with "Depressed" (8090) in his fight with disease near London, but so far as I understand the matter, I cannot see where an inspector could have helped, except by making a clearance by fire, as our friend had the benefit of the Association expert's visits. I should like to know if No. 1 stock was examined on July 29th. or by "Depressed" on the 24th.

If so, he may take it that infection was given in the examination either by himself or by the expert sent on July 24th or 29th. Then as to dysentery, the glass covers are not conducive to the comfort of the colony during the winter months especially. I always use a quilt of common carpet with a felt one over this, and a chaff cushion or some warm wraps in addition. Then as to food given, did "Depressed" use vinegar in making the autumn food? I have never used either vinegar or salt myself in bee-food. For syrup I use pure cane sugar (Demerara crystals), or for soft candy, half loaf and half Demerara sugar, and a little cream of Tartar, which helps to break up the grain of the sugar, leaving the candy soft and buttery. After feeding up in the early autumn, I have never thought of extracting the unsealed food. Continual pottering with bees is not conducive either to their health or well-doing. As regards infection, most probably it came with the bees or with the queens bought, or through the expert's visits of examination. I consider this a far more likely cause than from neighbours' hives, especially as it is stated that none are known to be kept in the neighbourhood.—W. WOODLEY, Beeton, Newbury.

#### PARTHENOGENESIS.

[8094.] Under this heading, on page 45, Mr. Desmond claims scientific accuracy for the statement that "one sexual intercourse is sufficient to fertilise the eggs of numerous generations of aphides." What are the facts?

In the aphid life cycle, the sexual generation is the only one that produces eggs. These eggs produce females which are incapable of being fertilised, and which are viviparous, i.e., they bring forth living young.

These young are themselves capable of producing parthenogenetic viviparous offspring, and after several such generations, the cycle is again started by the production of the sexual forms of the insect.

The number of generations in the cycle depends on circumstances. Experimentally, it has been made to continue for four years without the occurrence of sexual forms of the insect. I do not think that any juggling with the sentence quoted will fit it to these facts. The intermediate generations produce no eggs.

It might be argued that the germ which develops in the body of the plant-louse is really an egg, and that this is fertilised. There is no support given to this view by the embryologist. Studies of parthenogenetic ova and of fertilised ova reveal a difference in the early stages of development. Further research has shown that the eggs produced by the sexual female aphids are analogous with other fertilised eggs. The germ which develops in the body of the parthenogenetic female mani-

festes the peculiarities of the parthenogenetic ovum.

A loose style of expression in the columns of a scientific journal usually gives rise to trouble. The late controversy on the McEvoy system originated in the use of the term to denote a system which was not the system of McEvoy, and which, in its use of disinfectants, materially differed from it.—G. W. BULLAMORE, Albury, Herts.

#### COMB-FOUNDATION AND FOUL BROOD

[8095.] I thank Mr. Taylor (p. 35) for his kind invitation, but I fail to see that any good would come of it. He tells us it takes several days to cool half a ton of wax. That, no doubt, is true, but in his catalogue he says: "customers' wax cleaned, sterilized and made into weed brood at 6d. per lb. He does not, however, say that each customer gets his own wax back, and I should consider myself unreasonable if I sent 6 lbs. of wax and expected a manufacturer to put his machinery into motion to keep mine separate for the sum of 3s. How long would it take to cool this 6 lbs. of wax? I would like to know, also, how the spores are removed, or destroyed, for I believe the only heat that will really destroy them is a dry torch, such as a painter's lamp, and this, of course, will destroy the wax. Apiary after apiary has been wiped out, both by foul brood and the Isle of Wight disease, and the old combs have been melted and sent to our manufacturers, who send their foundation to all parts, and the Isle of Wight disease is spreading both north and south. I would appeal to all bee-keepers who have this disease not to send such wax to be made into foundation, for it is certainly both unsafe and unwise; there are plenty of other uses to which it may be put.—JAS. PEARMAN, Penny Long Lane, Derby.

#### FERTILISATION OF QUEENS.

[8096.] It is interesting to have further details concerning the experience of "Scot" re queens mating in the hive (page 46). We must evidently assume that "Scot" is infallible, but yet his case has not been proved. At what age did the drones mate with the queen, if such an event actually took place? Also, were they so active in the hive if the weather was so adverse as to prevent outdoor excursions?—A. W. SALMON, St. Kilda, North Finchley.

#### EARLY POLLEN-BEARING PLANT.

[8097.] *Garrya Elliptica* is an anemophilous shrub, and it is very doubtful whether the bees would use its pollen. If they should use the pollen of wind-fertilisers they have the yew, which is just as early as *Garrya Elliptica*, and bears great quantities of pollen.—G. G. D., Camberwell.

## Queries and Replies.

[4087.] *Working for Surplus.*—Having now increased my apiary to fifteen stocks, I should like to run it this year for honey only, and to this end I should like to return all swarms to parent colony. Would you be good enough to let me know through the medium of your valued journal the best means of doing this? Also, I am in doubt whether for honey purposes the old laying queen should be retained, or whether it would be generally better to keep the young one; in the latter case, how would one find the old queen in the swarm, in order to remove her? Thanking you in anticipation for your kind advice.—F.V.W., Gloucester.

REPLY.—(1) If you give room in advance of requirements, and sufficient ventilation, it will reduce swarming risks to a minimum. In returning swarms, first destroy all queen cells. This should be done as soon after the swarm has issued as possible. Then, in the evening, return the swarm from the front in the usual way, having first put on an extra super. (2) All depends upon the age of queen whether she is retained or destroyed. If in her second year, then she should be kept till the end of the season; if older, destroy her. In the latter case it will be necessary to leave the best queen cell. The queen can be found in the swarm by turning the skep upside down and carefully searching for her, or if in returning the swarm is thrown low down on the sloping board, she will easily be seen amongst the bees as they run up into the hive.

[4088.] *Carniolan Bees. Hive Construction.*—Can you advise me on the following points:—(1) Owing to the position of my apiary it is rather important to have good-tempered bees. In raising my queens in the early spring, would it be advisable to use a colony of pure Carniolans I have for supplying the drones? (The queens, of course, would be raised from my best stock, viz., an English black.) I ask this because hybrids are reported to be bad-tempered, and yet the "Guide Book" says their disposition is derived from drones. (2) Do you consider bees do as well without porches as with? Several apiaries in Holland I have seen do not use a hive with a porch, and I cannot quite see its use except as an ornament. Also, what is the proper distance between the floor and bottom bar of frames? I mean the space to be allowed in summer. In winter, of course, the eke is used.—"BEE-MAN," Atherstone.

REPLY.—(1) Though Carniolans are good-tempered when pure, it would be unwise to cross the bees as you suggest. As a rule, hybrids are vicious, though the parents on both sides may be docile. (2) Hives are much better with porches to keep out sun, wet and snow: they also provide for the use of entrance slides for the prevention of

robbing, etc. The space between bottom bar and floor-board should be half an inch.

[4089.] *Wintering Bees in a Shed.*—I should be pleased if you will kindly answer the following questions in the BRITISH BEE JOURNAL. (1) I have two weak stocks of bees which I have wintered in a shed. I am feeding with candy. What would be the best date to put them out in the garden for the season? (2) Another of my stocks has very irregular combs. I am feeding these also on candy, although they have plenty of sealed stores. I want to get the bees into a new hive, and intend to feed them up well on candy with pea-flour in it, as I want them to swarm early. If I can make them do this, and then send off a cast, how should I get the bees left on the combs out, as I understand I must wait two weeks after the cast issues before doing this? I shall be glad if you will tell me the right way to act in this case, and when to begin feeding with pea-flour candy, etc. The combs are fastened to the hive on each side.—G.B., Bath.

REPLY.—The bees should be kept out-of-doors or you will lose them. Keeping them in a shed will prevent their taking cleansing flights during fine days in the winter, which are necessary for their health. Wrap warmly at the top and they will be quite all right. (2) Do not do as you suggest, but treat the hive they are now in as a skep, and work them down as instructed in "Guide Book," page 150.

[4090.] *A Beginner's Queries.*—I would like to have your assistance through the columns of the B.B.J., from which I have already received much help. Being only a six months' novice, I have taken particular care of two stocks of bees this winter (as I thought), but upon examination on Saturday, the 11th, was horrified to find one stock had died with about ten pounds of stores left, and half a cake of candy on quilts, and judging from the "Guide Book," I guess the cause is dysentery, as a quantity of the stores were not sealed over. (1) Is the enclosed candy good? The other stock, treated in the same manner, appears in good condition. (2) If I thoroughly cleanse out this (dead) hive, would you advise me to put the other stock into it, for fear of trouble there? Would the old combs be fit for use again? (3) Is the honey in them fit for consumption? (4) Is there a member of the Association near Hampton Court who would visit me? I looked forward to doing great things in bee-keeping at Hampton Court, with its avenues of lime trees, and a wealth of flowers from March to October. My bees came from Epsom, I hope without having contracted disease so prevalent about there.—W.L. Hampton Court.

REPLY.—(1) The candy is much too hard for bee-food. (2) The combs being old, it will be best to melt them down. The hive should be well washed with disinfectant before using again. If you get it ready now you will be able to transfer the other stock into it when spring-cleaning about April.

You must not disturb them now by transferring to another hive. (3) The honey would not be nice for human consumption. (4) Write to Major Fair, 22, Anlaby Road, Teddington, hon. secretary, Middlesex B.K.A. He will no doubt be well able to put you into communication with a neighbouring bee-keeper.

## Echoes from the Hives.

I send a few lines on the prospects for the season from this little Garden of England, or, as Mr. L. S. Crawshaw would perhaps prefer it being called, the Garden of France (p. 179, B.B.J., May 5th, 1910). Bees here are generally in good condition, and on fine days are busy carrying water and pollen to the hives from crocuses and snowdrops, which are out in profusion in the small gardens in the town and neighbouring villages. I took advantage of Thursday last (February 16th) being fine and warm to examine nine stocks at an out-apiary, and was pleased to find in each hive large patches of brood on three, four, and in one hive, five frames, with plenty of sealed stores. Market gardeners here appear to be taking more interest in bees and bee-keeping now than in former years. Many are starting with two or three hives, and increasing year by year. The Gardeners' Association, in conjunction with the Worcestershire B.K.A., have arranged a lecture in Evesham Town Hall on March 9th on the subject of "Bees and the Fertilisation of Bloom," and much interest is being taken in it by all classes, especially by those who are members of both societies.—J. S. BAILEY, Expert, Worcestershire B.K.A., Evesham District.

## NOVELTIES.

Mr. R. Grose, of Bodmin, sends us two novelties which he has found useful. One is what he calls "An Observatory Queen and other Bee-Catcher," and is made from a Bryant and May's "Ruby" matchbox. The drawer of the box has a piece of glass fitted in, which replaces the bottom, and on the outside a flap  $\frac{1}{8}$ ths of an inch wide is cut out, so as to permit of inspection of bees or queen beneath the glass. At one end of the box a triangular piece is cut out for allowing the bees exit to the mailing cage. By placing the glass covered drawer over the bees, they can be captured expeditiously and allowed to run into the mailing cage without a finger being placed on them. The second appliance is a "Queen Nursery Cage," which can be suspended in upper storeys or used in "Swarthmore" nuclei. It is a perforated zinc tube, 3 in. long, and  $\frac{3}{4}$  in. in diameter. In the centre there is a cork  $\frac{1}{2}$ in. thick, with a  $\frac{1}{2}$ in. hole in it. There is a similar cork at the bottom end, the opening of which is closed with a cork fitting it. The cork stopping the top is  $\frac{1}{2}$ in. thick, with a

hollow into which the queen cell may be fitted. The top cork is flanged for suspension if desired, when several are used together. The cork at the bottom is removed when candy is placed in the hole, or the queen may be let out into the lower chamber, in which case the hole must be closed.

## BEE CONTROL CLOTH.

We have received from the Irekling Company, Dublin, samples of their "Bee Control" cloths, which are put up in a compact tin case, and can be carried in the vest pocket. They are very neat, and in calm weather would no doubt be quite convenient subjugators, but their lightness would make them a little difficult to work with in windy weather. They will specially appeal to travelling experts, where lightness and an absence of bulk in luggage is a great consideration.

## AMERICAN AND COLONIAL PAPERS.

### EXTRACTS AND COMMENTS.

By D. M. Macdonald, Banff.

*Colour Sense in the Bee.*—One who has devoted a considerable amount of original investigation to this subject is quoted in *Gleanings*. His conclusions are: First, bees plainly distinguish colours, whether natural or artificial; secondly, bees visiting one colour return to it habitually, they exhibit colour fidelity; thirdly, this habit does not become obsessional, they discriminate between colours when it is for their advantage. I am interested in this subject, and will deal with one phase of it next week.

*Buckwheat.*—I was asked lately about the value of buckwheat as a feeder for stock. Here is an interesting extract on the subject:—"Buckwheat is being grown more and more in most dairy regions, as the great question with the dairyman is what food gives the most milk, and the increase will go to increase the dairy products. The blossom, however, is what the bee-man is after, and so the dairyman and the bee-keeper will fill the land with milk and honey." Two for buckwheat!

*The Cost of Disease.*—According to an estimate made in a publication issued by the U.S. Department of Agriculture this works out at the rate of 1,000,000 dols. per annum. Disease is declared to exist in at least thirty-seven States. This department is doing its best to combat disease in every form, and bee-keepers are loyally supporting them. *Gleanings* aids the good cause in every possible way.

*Smoking Entrance.*—An Australian advises not to inject smoke at entrance when manipulating. Another says that Doolittle advises the contrary, and adds "I inject smoke at the entrance before raising quilt." I wonder, now, if many follow out this practice. I never found any necessity for it, and I question if, for ordinary operations, it would do any good. More interruption of work and more confusion in the interior would result.

*Honey Prices.*—It will be generally acknowledged that prices are more inclined to fall than rise. The "good old prices" are a thing of the past. Now, while this is so, most, if not all, other commodities are enhanced in value. A writer in *Review* gives a concrete example: "When pork was 5 cents. per lb. it took 7 lbs. of honey to purchase 9 lbs. of pork. Now, with pork 10 cents per lb., it takes 10 lbs. of honey to purchase the 9 lbs. of pork." Hereabout some years ago, 1 lb. of honey would buy 2 lbs. of butter. Nowadays 1 lb. of the one about meets the cost of the other.

*Comb Plus Extracted Honey.*—Another writer dealing with this subject puts in two good pleas for working a combination of the two: "A man who produces both kinds is often able to make sales earlier in the season. And a colony backward in beginning work in comb honey supers, or which is a very slow or poor comb builder, often does excellent work if given extracted honey supers." Both are interesting points, and, I think, true.

*A Sweet Fraternity.*—A contribution by the Hon. Eugene Secor, gracing the front page of cover of the *American B.J.*, thus designates bee-keepers. He says many *sweet* things about us as a class. "Our toil doth sweeten others." "Bee-keepers are the most companionable fellows in the world." Bee-keepers are "temperate," "moral," "generally religious." "I recall the beautiful friendships in the brotherhood of bee-men that it has been my privilege and good fortune to enjoy. The memory of it is like unto the fragrant breath of June roses. How sweet is friendship! How delightful are the recollections of happy days! How endearing is the brotherhood of common endeavour! Toil makes the toilers kin." Mr. Secor is the poet of Beedom.

*Nucleus or Nuclei.*—I rather admire the ingenuousness and ingenuousness of the paragraph on page 6 *American B.J.*, wherein I am lightly "let down" over my use of nuclei. When I write of "forming several nuclei," why should I transgress against the rules of grammar and commonsense by using the word for one when I mean a number more than one? My friend the doctor should specially note that when I wrote of "shook" swarming, I used quotation marks, showing clearly the word was borrowed—from America. It is un-English and not Scotch! I wonder now if I could throw a brick or two—on paper? I remember a dreadful word lately coined over there—"queenright." Then not only the "ABC" but the "XYZ" speaks of one weaker bee as a "fellow." "Jangstroth on the Honey Bee" calls a flight board an "apron," and Dr. Lyon designates a hive roof as a "lid." Again, there is that barbarous word "chunk" honey. I could indefinitely extend the list.

*Disinfection in Australia.*—The new Victorian Disease of Bees Bill is professedly constructed on the lines of the New Zealand Act, according to the *Bee-keeper*. Here is an extract from clause v., section 1: "An inspector may order any bee-hives, fittings, ap-

paratus, appliances, utensils or other articles liable in his opinion to spread disease, to be cleaned and disinfected." Yet Mr. Beuhne informs us that all bee-keepers have acquiesced in its passing. "Not a solitary voice was raised in opposition, either in the journals or at meetings of bee-keepers." Britons might follow the good example.

*Honey Cures.*—"For burns and scalds pure extracted honey is very good, it will generally relieve the pain in a very short time, and induces the wound to heal very rapidly." A writer quoting the foregoing from a medical work records that in a case which came under his own observation, where a man had his hands badly scalded, the cure worked favourably. The hands were dipped in honey and wrapped in cotton wool, the application being renewed in course of time.

As a consequence of moving about in cold weather with damp feet, children are frequently troubled with chilblains at this time of the year. Honey helps to cure them. Coat a piece of cloth with honey and apply it to the sore when the child is going to bed. A few applications should bring about a cure.

## OLD BEE LITERATURE.

(Continued from page 70.)

The wind is very contrary and hurtful for them; and therefore when it is great, stiff, and boisterous, the hives ought to be carefully covered. Warm places they affect in winter as other creatures do, and in Summer, fresh aires are most fitting for them. It is very necessary to use diligence when the honey is taken from them: because if overmuch be taken away, they will labour little; and if more likewise be left than is convenient, they will be the less diligent in making move, and therefore a moderate, and reasonable quantity must remain, according to the number whereof they consist. What worthier example to men, can there be than this? Declaring that in the Commonwealth, everything ought to be moderately measured; because over-great, pompous, and luxurious diet, do but destroy famous families, abounding in all superflous things. And yet not to be too niggardly and sparing in provisions needfully required. For as by the first, children and servants may become careless and negligent; so by the latter, they may grow wretched and desperate.

Another diligent care is required in them that make use of Bees; to wit; that when they hear their great swarm-



ing noise in the hive, it is a signification that they would be gone and leave the hive; but then if the hive be gently sprinkled over with sweet wine they will not stir abroad. Such as keep them may easily take note thereof, because (ordinarily) they make no other noise than when they are flying. Wherein we are instructed, that by sweet language and kind behaviour, we may qualify stern anger in discontented brethren.

Aristotle further saith, "he did well observe it by experience, that their feet before are shorter than them behind; which is so given them by nature, for the easier rising from the ground. He saith, moreover, that when the honey corrupteth in the hive, it engendereth certain worms, which make webs like unto spiders; whereby they waxe sick and die." A very apt example for men, to be vigilant and respective of themselves, that the sweet days and prosperity in the world do not so corrupt their souls, as to beget the banful worm of ambition, which is deadly. In Moyfte times of raines, they multiply greatly, by reason of the humidity: and contrariwise they decrease in times of draught, through want of moisture. Also in winter their strength much faileth them, in regard of cold weather, snow, and windes out of the North; which hindereth their fruitfulness, and therefore they keep closely hidden. But when the flowers of Beans begin to sprout, they come abroad to labour: and the first work they do at home is to build their dwelling-houses, next to engender, and then to yield honey.

They make several rampiers before their combs, as their guard and strength; the first crust (being ymoft) they make bitter; the second (within) somewhat sweeter; and the third, thickest of all, because it joineth next to the Combs; and thus is the foundation of their defence. A good instruction for men, how to share their building in this world, to use diligence in their provision, so soon as they can, especially of things necessary; then to marry for increase of children, and still to keep employment in natural exercises. When they fly forth upon some urgent occasions, and are prevented by night, so that they cannot return home unto their own

habitation, they sleep topsy-turvy, the upside down, because cold mists, fogs, and rains should not offend their wings, to hinder their flight home to their hives, or execution of their other enterprises and affairs.

Sentinels they have of their own appointment, who make a noise at break of day, by which sound they all awake, and turning themselves on their feet, they make a noise again to their sentinels, as a thankful sign of joy: but then, upon another sound from the same sentinels, they are all silent, as attending what instant charge is given them. Informing our judgments in times of war to be very vigilant; well provided and noway negligent.

Excellent experience have they, when rains and unseasonable times will ensue, which they foresee by flying abroad in the evenings, about their own needfull occasions; and finding it to follow as they feared, they will not by any means budge from home.

(To be continued.)

---

## Notices to Correspondents

---

*Letters or queries asking for addresses of manufacturers or correspondents, or where appliances can be purchased, or replies giving such information, can only be inserted as advertisements. The space devoted to letters, queries, and replies is meant for the general good of bee-keepers, and not for advertisements. We wish our correspondents to bear in mind that, as it is necessary for us to go to press in advance of the date of issue, queries cannot always be replied to in the issue immediately following the receipt of their communication.*

*\*\*The Editors will esteem it a favour if subscribers will kindly let them know if they have failed to get satisfaction from any advertisement appearing in the columns of the BRITISH BEE JOURNAL.*

F.V. (Barns Green) *Dead Bees Cast Out.*—The bees are merely the old ones which die in the hive during the winter, and are thrown out by the others when a fine warm day comes and they are able to take a flight. It is quite natural for this to happen.

G.M. (Tewkesbury) *Disease Preventives.*—(1) Neither remedy will affect the honey in the least. (2) We have no faith whatever in it. (3) No.

CONSTANT READER (Dorchester) *Bees Found Dead.*—(1) The colony evidently dwindled

away through there not being sufficient bees to keep up the necessary warmth. (2) The comb contains hard pollen only, and if the rest are as badly pollen-clogged melt them all down and start again with full sheets of foundation.

**ANXIOUS** (Berwick-on-Tweed).—*Using Combs from Dead Stock.*—The combs contain mouldy pollen, and should be melted down. Starting a swarm on foundation will be better and more economical than allowing the bees to clean out old combs. We should like to have a few live bees from the hive, where the bees are showing signs of dysenteric trouble and restlessness, then we shall be better able to advise you.

**STUDENT** (Sheffield) *Two-frame Observatory Hive.*—(1) For breeding, a temperature of 80 to 90 degrees is necessary. (2) You require shutters which should be lined with felt or cloth to keep the hive sufficiently comfortable. (3) You can get effective microscopes at any price from about 30s. upwards. You would require one with a one-inch objective and a quarter-inch for a higher power.

**A.R.** (Tiptree) *Claustral Hive.*—(1) As a beginner it is not necessary for you to start with a claustral hive, although there are certain advantages from which an experienced bee-keeper could derive benefit. (2) The chamber of shallow frames below brood chamber sometimes prevents swarming, but is too troublesome, and is seldom used. (3) Plinths are no disadvantage if properly fixed.

**A.B.** (Ardrihaig) *Buying Bees.*—It is not a good time to buy bees now. Wait until spring and purchase either a swarm or a good nucleus. In May, a reasonable price for a six-frame nucleus would be about one guinea; later on, of course, the price would be lower.

**W.E.N.** (Norwich) *Value of Old Books.*—You have not given the correct titles of the books, but we presume you mean "The History and Management of Bees," by John Wighton, 1842, present value about 2s. to 2s. 6d. "An Essay on the Management of Bees," by John Mills, F.R.S., 1766, value 3s. 6d. "My Bee Book," by W. C. Cotton, M.A., 1842, value 5s.

**W.D.T.** (Swanage) *Cheshire's Bees and Bee-keeping (Practical, Vol. 2).*—The book is now out of print, and from a practical point of view it is useless, but a collector of bee literature might buy it. The value varies according to condition, and the desire on the part of a purchaser to secure it, from 5s. to 10s.

**H.S.** (Cheshire) *Bee Legislation.*—Efforts have been made in the past to obtain legislative powers to deal with foul brood. This is no doubt what you mean. The want of a unanimous desire for legislation amongst bee-keepers, especially those keeping bees on a large scale, has up to the present prevented the securing of an Act. An effort is again being made which we hope will be

successful, so that British bee-keepers may have the protection enjoyed by other countries, which is as yet denied to us.

#### *Honey Samples.*

**W.H.P.** (Carlisle).—The sample is foreign, and very indifferent at that. It is honey, but the flavour you mention is caused through overheating it in liquifying. It is not fit to eat, and so is worth nothing.

**N.R.** (Lincolnshire).—The honey has been gathered principally from the limes, and shows slight signs of granulation. No doubt you have kept it in a dark and warm place; this would retard granulation.

#### *Suspected Disease.*

**H.H.** (St. Albans).—The parcel arrived in such a squashed condition that it was impossible to carry out an examination.

**G.L.B.** (Derby).—(1) Bees have died of starvation, although some show signs of dysentery. (2) We would certainly not advise you to use the food for other colonies, as it is probably the bad stores that have been the cause of dysentery.

**ENDICOTT** (Worcester Park).—Bad case of dysentery. The candy you send is totally unfit for bee-food, and is no doubt the cause of dysentery. If you will refer to page 171 of "Guide Book," you will see that brown or moist sugar should never be given to bees.

**SURREY** (Walton-on-Thames).—Both the lots of bees sent have suffered from dysentery. In view of the prevalence of disease in your neighbourhood, we would not advise you to keep the frames of comb to use again, but to destroy them, as it is far the safest plan.

**A.I.** (Watford).—Bees have died of dysentery, but in view of Isle of Wight disease in your neighbourhood, you should destroy combs, frames, etc., and disinfect hives.

**C.C.** (Alverston).—(1) Dysentery. (2) Bees can have dysentery in the autumn if they do not get proper food, and when forage is scarce they may suck the juice of decaying fruit. (3) If it is brown sugar it is certainly injurious, and would cause dysentery. Nothing but white lump or granulated cane sugar should be used. (4) It is quite possible for apple juice to cause the mischief.

**ANXIOUS** (Devon).—The stomachs were quite empty, and the bees appear to have suffered from starvation.

**X.Y.Z.** (Lewes) and **H.** (Renfrewshire).—In the reply last week inadvertently "spores" were mentioned instead of "bacilli," as *B. pestiformis apis* of Dr. Malden usually associated with Isle of Wight disease is a non-spore-bearing organism.

**H.** (Renfrewshire).—Undigested pollen in abundance, but among the numerous bacteria we could not identify the bacillus usually present in Isle of Wight disease.

## Editorial, Notices, &c.

### GLAMORGAN B.K.A.

The annual report of the Glamorgan Bee-keepers' Association, read at the annual general meeting held at the Mackworth Hotel, Swansea, on February 11th, states that the Association has passed through a critical period during the past year. The former secretary, Mr. William Richards, who worked so strenuously for nine years, was compelled reluctantly to relinquish the secretarial duties. The county council had reduced their grant to the Association by £50, reserving the other £50 for the salary of an expert bee-keeper of their own appointment. The work stipulated by the county council as a condition of the £50 grant entailed great sacrifices on the part of the members of the committee, and a sum of £15 was added to the county council grant from the subscription list. In order to comply with the conditions laid down by the county council in reference to their grant, the county was divided into ten areas, and local experts were appointed.

The honey season generally was a very poor one, though the honey gathered was of very good quality. Some instances are reported of exceptionally good yields of excellent quality. Late swarming was rather prevalent, which in part accounted for the reduction in the quantity of honey harvested. The experts' report showed that there were 364 apiaries, with a total of 1,191 hives and skeps, of which 1,121 were healthy. The estimated produce was 15,000 lbs. of honey and 724 lbs. of wax.

The financial statement reveals a healthy position, the receipts being £117 9s., against an expenditure of £102 7s. 7d., the credit balance being increased by £5 3s. 11d. on the year's working.

### FOUL BROOD LEGISLATION.

[In view of the controversy on the above subject we give an extract from *Gleanings* on some experiences of the Editor in foul brood inspection work.]

During the last few days we have been getting some real experience in helping out the Ohio foul brood inspectors. We have driven from forty to seventy-five miles in a day with a machine, carrying the inspectors about from bee-keeper to bee-keeper. If there is any one fact that was impressed on us it is this: That foul brood finds an easy lodging-place among the old-fashioned bee-keepers, who either have box hives or old hives of an antiquated pattern—so old, in fact, that there are cracks all over them. Of course, some of these farmers do not take any bee-paper, and they probably do not even read the apian department in their agricultural papers, if they read any paper at all.

At two or three yards we found where the

bees had died the previous winter. Examination showed the characteristic scales of foul brood on the combs. The bees had, no doubt, been so weakened by the ravages of this disease during the previous summer and fall that they were unable to withstand the winter's cold. The result was, there were several hives in the spring containing honey in the combs, with no live bees in. Neighbouring bees found these hives, of course, and robbed them out and thus scattered foul brood right and left. We ran into one section where fully 99 per cent. of the farmers had foul brood among their bees; and we found not a few of them having empty hives with foul-brood combs in them, all of which gave evidence of having been robbed out the previous spring. No wonder their cry was, "Bees don't pay like they used to." In every case the farmers were willing to be shown what to do, and to comply with the provisions of the Ohio law, and scarcely one of them knew he had the disease.

### AMONG THE BEES.

#### COLOUR AND BEES' TEMPER.

By D. M. Macdonald, Banff.

A great deal has been written in the past on this question, and at present it is engrossing the attention of bee-keepers. Many have strangely reasoned it out that because some have unfortunately received a good deal of adverse attention from the bees when clothed in black garments, the mere colour alone was the cause from which the ire of the bees arose. I never experienced bad results from such a cause, and the reason is always present with me, because I wear black or very dark garments, and bees never show me any special disfavour on that account. Among my friends and correspondents are a number of clericals of all denominations, and all of them agree in certifying that they have experienced no ill effects from working among their bees when clad in the orthodox black ministerial habiliments. It is not with any of them a question of fancy, but one of simple fact—not theory.

Since writing the above, I have seen and spoken to three clergymen on the subject, and all declare positively and emphatically that the idea is a myth, without any foundation in reality. I dropped three other distant clergymen a post-card inquiring as to their experience, and all three agree that it does not make a whit of difference. One says his white shirt, if any part, gets more stings than anything black about him.

That is exactly my experience. If stings are going anywhere they will be most plentiful on the white wrists under the white cuffs, but I do not for a moment say it is because these are *white*, but would venture a guess that it is because some pressure has been brought to bear on the bees who have endeavoured to explore the vast void, to them, which lies beyond. I know my neck at times gets a fair share, when the veil is thrown on hurriedly, but, reasoning by analogy, it should be the white collar, and

not the black coat, that should be the attraction. I feel it is neither. I presume some venturesome worker investigates as to a vulnerable point of attack and gets caught as in a trap, with the result that it vents its vitriolic venom on my white skin, not on my black garment. My eyebrows are black, not yet even a sabled silver; still stings, when they are delivered in that region, are not often thrust into the dark object, but above or below. I am not so foolish as to think that it is the colour, either white or black, which has such a fascination for the Amazonian warrior's spear-thrusts. I know it is the motion which attracts them. The eternal movement of the eyelashes appears to be a menace, and these spiteful little ladies vent their ire on that which seems to them a cause of offence. A dead stillness they disregard; motion, in their eyes, is a *causula belli*, and they strike first.

My veil is black, in common, I suppose, with the majority of these indispensable pieces of armour, worn to defend us from the wrath of the bee. Has it ever been seriously proposed by any sane bee-keeper that the colours should be changed in order that stings might be decreased? If so, I never heard of such a suggestion. When do we don these black headgears, if not when bees are ireful? And then, when stings are going, do these black objects suffer unduly? Some years ago I had a spiteful Cypro-Carniolan stock—patent stingers they were, too! Something irritated them especially one day, and dropping the veil, I stood stock still, to test them. This same subject had been up for discussion shortly before. Although hundreds of bees most spitefully buzzed all round this black veil of mine *not* one stung the netting. My grey cap was literally covered with stings where it showed above. My white shirt sleeves suffered unmercifully every time I moved my arm, and in the end, so many pierced the skin through that thin, white summer garment that I had to clear out; I am afraid in rather an undignified manner!

In the same way, my black boots never get stung, yet when the bees crawl up higher the white skin is not spared because it happens to be white, but is pierced venomously by almost every bee finding its way beneath the outer garment, which is black, by the way.

A small white spot on the top of my head, unfortunately extending in area annually, has a species of fascination for the bees at times, while the dark surroundings are left severely alone.

Leaving the personal argument alone, I tried to prove an assertion of an old-time correspondent as to a "bogey man" curing a vicious lot of bees, and erected a dark and a light scarecrow near the extra vicious stock mentioned above. Both were utterly disregarded, not one single sting being administered to either. A friend who has been in Africa informs me that he has seen the native "blacks" almost stark naked, getting off scot free, when Britishers in white rai-

ment were severely punished while engaged in robbing hives of bees. One of the clergymen mentioned above humorously wrote saying he could only speak for one side, and that a baker in his Sunday suit, contrasted with the same individual in his workaday clothing, would be better evidence. Fortunately, such a case was available, and the individual consulted declared that it was a case of "six of the one and half a dozen of the other." After a lengthy experience, he is confident that his "Sunday best" is no detriment when working among the bees.

For the various reasons given, I can only conclude that colour alone is not a generator of ire in the bee.

---

## Correspondence.

---

*The Editors do not hold themselves responsible for the opinions expressed by correspondents. No notice will be taken of anonymous communications, and correspondents are requested to write on one side of the paper only and give their real names and addresses, not necessarily for publication, but as a guarantee of good faith. Illustrations should be drawn on separate pieces of paper. We do not undertake to return rejected communications.*

---

### IS "ISLE OF WIGHT DISEASE" INFECTIOUS?

[8098] Last summer an expert wrote saying that "Isle of Wight disease" was so infectious that he could communicate it by speaking or thinking of it! Whilst touring he visited an apiary where this trouble had started, and later in the day, when passing a bee-keeper friend, he shouted the fact to him. A few days later "Isle of Wight disease" appeared in his friend's apiary, and also in his own.

When the disease visits a number of hives or apiaries in succession, it by no means follows that the trouble is communicated from hive to hive. If it could be communicated by robbers it should be possible to communicate it artificially, and to do this is absolutely impossible (see Dr. Malden's report). I consider it to be a food trouble, and whether caused by starvation or fungus poisoning, it would affect stocks in just the same way.

If Mr. Woodley knows how the disease can be conveyed from one stock to another I should be glad to hear it. That one stock suffers after another is no proof of infection. If they get it from a common source we cannot reasonably expect them all to develop it at exactly the same moment.

When Bonner states that swarms disappeared leaving only the queen and a few bees, the explanation of the long winter will not apply. I think it is reasonably certain that if a number of pollen-distended bees were sent to the B.B.J. with a note saying that only the queen and a score of bees were left in the hive, the owner would be advised to treat it as a case of "Isle of Wight

disease." They are the only symptoms that we have to go upon.

I read that about eighty years ago, of 300 hives in one parish one stock survived the winter, and in the adjoining parish four escaped out of 200 hives. Bad weather and death and disease of bees are associated throughout the history of bee-keeping. In the summer of 1894 "bees were gorged with pollen, that in times of scarcity of honey they appear to consume, which they cannot assimilate or discharge."

When a good honey flow comes we shall hear very little of "Isle of Wight disease."—G. W. BULLAMORE, Albury Herts.

EXPERTS AND DISEASE.

[8099.] My grateful thanks to Mr. Woodley (p. 84) for his sympathy and advice. Had there been a Foul Brood Act in force I should at least have known whether there was an apiary with foul brood in my neighbourhood. I do not complain of having had to destroy the stocks. It is the least one could do to prevent other apiaries becoming infected.

Mr. Woodley has confused dates somewhat. The expert who examined the stocks on July 29th, 1908, was Mr. Charles Lodge, a well-known and successful Essex bee-keeper, and the winner of numerous prizes. Under his advice I managed to cure No. 1 stock, and it was the only one that swarmed the following year. There was no foreign queen in it, and I had been near no other apiaries. Query: How did the foul brood arise in this case?

It was in the following year, 1909, that on July 24th I found foul brood in No. 3 (not No. 1), and this was confirmed by the county expert on his examination on July 29th, five days later. I had been near no hives but my own all that year, so I did not bring the infection, nor could the county expert have done so. It is true that the hive had an imported Italian queen, but she had been there since June 8th, and had bred a large number of healthy bees. No. 1 was not looked at either on the 24th or 29th of that month. It had supers on and I was unwilling to disturb it.

This leads me to combat Mr. Woodley's views as to experts, or inspectors under the Act (if, happily, there were one in force) conveying infection. One has only to look at the ordinary practice of medical men in infectious cases. Who would ever allow a doctor in the house, knowing his practice brings him into contact with infectious cases daily, if the doctor often or even ever carried the infection with him? The answer is obvious. The doctor takes precautions, and does not carry infection, and what the doctor does surely the inspector could do.

As to dysentery, I don't think this can be attributed to glass quilts; otherwise all my stocks would have suffered. All had the same sources of nectar supply, were fed alike and wintered alike.

I wrote my views very fully as to the

merits of glass quilts in the JOURNAL of May 26th, 1910 (No. 7824). At the same time, I cannot deny that they are not recommended in England at least, and it may well be that there is some hidden drawback in their use here. This year I intend in re-stocking my apiary to try half with my glass quilts and the rest with ordinary quilts, and study the results.

I made my syrup exactly in accordance with the formula in the "Guide Book," using cane sugar in crystals. As for extracting the unsealed food, I assume Mr. Woodley means removing the frames that had more of it than of sealed stores. I did that at the time of closing up for winter, when I inserted three frames of candy. Otherwise I have not in any way "potted" with the bees.

I am still awaiting a satisfactory solution of my trouble.—"DEPRESSED."

FEED THE BEES!

WHY?

[8100] I send these few notes on the above subject because the last few days have brought under my immediate notice the necessity for bees being fed at once if many (very many) now promising stocks are to be preserved to reap the benefit of the coming season, and to give a due meed of profit to their owners. Bees have had during the last few weeks many opportunities for cleansing flights, and where not already dead from starvation, are in most cases in good condition; but all, with hardly an exception, are practically without stores, and unless cakes of soft candy are *at once* given, the loss will be great.

I have been told, when I have suggested this little help, that the bees have got over the worst of the winter, and will now do all right as they have done in the past. My reply to this was a question: "Do your bees pay?" and the majority have answered, "No, they have not done so for years." True, we have had several bad seasons of late, and hundreds of stocks have died out, but it is more bad management than bad weather that has caused this high mortality and failure.

The erroneous idea that bees are self-supporting under the present system is no doubt responsible. Bees *are* self-supporting, and could well do without help if bee-keepers did not take the heavy toll of surplus every season, and in many cases so closely are the bees denuded of their stores that not sufficient natural food is left to keep them during the cold and inactive period of the year. A few pounds of watery syrup may be given in the autumn, but I never saw a hive yet properly fed back in autumn to recompense or make up the deficiency of the deprivation. Herein lies the root of all the evils of bee-keeping, in my opinion, summed up in two words—improper management. But to return to my subject, why feed now? Maybe there is still a little honey left within the hive; it may or may not last out until the fruit blossom comes. I noticed pollen being car-

ried in on February 15th; where it came from or how far the bees had to travel to get it set me thinking, and hence these lines. Pollen is for the young now being reared; it is necessary for their existence and well being, and the bees, alive to their requirements, are out on every available opportunity seeking for means to supply the demand. They would, however, often have been better at home. On the date I mentioned it was true the sun shone, but the wind was icy cold, and nothing but necessity brought those bees out to fetch the necessary food. How many were there that never returned? How much weaker are the stocks thus positioned than they were a month ago? Where will such stocks be in a month's time, living, as nearly all are, on something less than will properly keep them, the old bees half starved; and what about the battalions of young bees that should now be hatching? In the majority of unfed hives you will find a little patch of brood in the centre of the cluster, totally inadequate in size to compensate for the daily loss of old bees. Yet this is no fault of the bees, and the remedy is with the bee-keeper. I say if your bees are still alive, don't disturb them more than is necessary, but feed them for their sakes, and for your own if you wish to make them pay and to return you a hundred-fold in the future the present trifling outlay. In good stocks breeding commences with the new year, and provided food is all right the stock will gradually grow stronger in young though weaker in old bees, but if rood is short the stock will grow less, no brood be raised, and even may die outright. Such a stock will of a surety be too small when the season comes to give a good account of itself. Why, therefore, should you run the risk of the loss when a cake of candy now and again will induce an increase of breeding. Feed and keep the bees in good heart, save them long and fruitless journeys in search of what is not to be found, ward off disease, and eventually work them, in a few months, into such a condition that be the harvest great or small they will be ready to render a satisfactory account of themselves. They will give a return to their keepers not dreamed of by those who place bees in their garden and on their farms, and expect them to do the rest and *keep their keepers*. P.S.—At this time of the year I advise pea-flour candy being given.—H. W. BRICE, Green Street Green, Orpington, Kent.

#### FOUL BROOD LEGISLATION.

##### AN OPPONENT'S REPLY.

[8101] I feel constrained to again solicit space in your attractive and helpful JOURNAL, in order to reply to some remarks that my previous letter has occasioned.

May I ask you to kindly allow me to bring evidence from the reports of county associations which have appeared in your own pages during 1910, and also the present year, to help to remove the impression apparent in

the editorial footnote to Mr. Gordon (October 6th, p. 398), in which you state that "It is quite certain the industry cannot go on much longer unless some steps be taken to check the spread of disease."

##### Report.

B.B.J., February 17th, 1910 (p. 64), Glamorgan County Association:—"Percentage of foul brood was reported to be small."

Do. March 3rd, 1910 (p. 83), Derbyshire:—"It was pleasing to note that there was a large decrease in the number of diseased stocks in the county."

Do. March 3rd, 1910 (p. 86), Cumberland:—"Sixty per cent. diseased in 1899, 7 per cent. in 1909."

Do. March 10th, 1910 (p. 94), Hertford, Ware and District:—"106 hives and nine skeps. Only four colonies diseased."

Do. March 24th, 1910 (p. 114), Lancashire:—"Chairman congratulated on the fact that the expert had reported a decrease in the number of foul brood cases in the county."

Do. April 14th, 1910 (p. 144), Warwickshire:—"Membership 500, 4.4 per cent. stocks were diseased."

RECORD, April 1910 (p. 176), Notts:—"729 stocks, 3.6 per cent. diseased—"a very low rate."

B.B.J., May 26th, 1910 (p. 205), Staffordshire:—"851 stocks examined, 1.5 (about a dozen) diseased."

Do. February 9th, 1911 (p. 52), Cumberland:—"Report stated that 1910 must be considered the best year they had had for many years."

RECORD, February, 1911 (p. 18), Devon:—"277 members. "The report was exceedingly gratifying" (Col. Walker). "It was gratifying to know that bee-keeping was making such strides" (Mr. Scholefield).

The editorial footnote to R. Whyte, Rutherglen (p. 360), quotes the reduction of disease in New York State from 30 per cent. to 5 per cent., by help of a Bill. Northumberland's reduction from 60 per cent. to 7 per cent. is a much better result even without a Bill. [All these results are among members only, and show what can be done by the experts, but they do not touch non-members, who form the majority.—ED.]

The editorial footnote to Iceniland (p. 448), states: "Old hands who do not allow foul brood to be in their apiaries will not require a visit," etc. Recent events in Ireland prove that they will have to put up with the visits whether required or not, or go to law, like Messrs. Stephenson and Doyle in co. Wexford.

Editorial footnote (p. 489) and Mr. Crawshaw (p. 48) (1911), should refer to the editorial in *Gleanings* (August 15th, p. 509) for the single instance required. The Editor of *Gleanings* says as follows:—"The facts are that European and American foul brood are

spreading over the United States, in spite of the McEvoy treatment. One State inspector, with an excellent law back of him, wrote us a few days ago, stating that he was somewhat discouraged over the outlook; that do everything he could, with his corps of inspectors, the diseases were raging as strongly as ever." [The Editor tells us why, because "the McEvoy treatment was expensive, and many bee-keepers were disinclined to follow instructions, and others made bungling work of it."—Ed.]

Our Editor informs us on page 27, footnote to J. Pearman, that he has been able to keep his apiary free of foul brood for thirty years, and at a conference some time ago stated that the only time he experienced it was by the introduction of an Italian queen; yet in reply to "Depressed" last week (who admits having introduced an Italian queen from abroad, and finding foul brood a short time after. He cures this, and the following year introduces two more Italian queens *from abroad*, on June 8th, and finds foul brood on the 24th following) our worthy Editor suggests that there was probably some ignorant or careless bee-keeper living near, who was the probable cause of the outbreak.

Mr. Quinton (p. 396) states that just before he left Surrey for Ireland, there was hardly a bee-keeper left in that county, owing to foul brood. It would be unkind to suggest that he took the disease with him to Ireland, yet it is a fact that only a year or two later it is recorded in the B.B.J. that Surrey had the largest membership of any county association in England at that time. That its honey show and able secretary are worthy of emulation to-day is apparent to all.

Isolating by placing a gauze tent over a hive, however good in theory, would be "distinctly wrong" in practice, especially when the bees in a strong yet slightly infected stock are in full work in the midst of a honey flow in June or July.

Mr. Quinton says that I misunderstand the working of the Irish Act, but do not the following particulars rather point to the fact that he himself is not acquainted with its working. He states that "it is only where the bee-keeper does not carry out instructions that he receives notice to destroy." If this is so, then there is a very recalcitrant body of bee-keepers in Ireland, for in the Returns of the Irish Board of Agriculture for the twelve months ending September 30th, 1910, in one county alone twenty bee-keepers received the inspector's three days' (not twenty-four hours, as he says) notice to destroy, and compensation was paid in nineteen cases, three at 2s. 6d., one at 3s. 6d., eleven at 5s., one at 7s., one at 7s. 6d., one at 15s., and one at 16s.

Whilst questioning whether recent events in the carrying out the Irish Act amount to more than Mr. Crawshaw's (p. 421) conception of them would be in practice or not, I must acknowledge that he has surpassed me, and let his fancy for analogy soar to higher flights than my own poor effort reached. He has even disregarded the influence that

*meum et tuum* might have had on the poor Irishman's indulgence of his simple pleasures. The bees are his own, the cattle his enemy's. As to compensation, the view that compensation should not be given for a valueless article is, in my opinion, not the right point of view to take of this matter. I look at it rather from the standpoint that it is not for the worthless foul broody skep or stock that we would be paying, but for the bee-keeper's interest, and securing his goodwill in co-operating with us in the removal of the unhealthy skep. By purchasing his interest and goodwill, a great step in advance is being made. Persuasion is better than force. As to submitting to the committee the name of a suitable cottager, Mr. Crawshaw will no doubt, on reflection, see that after I had in my own way put *both* sides before one of these, he would most undoubtedly refuse to serve on any committee formed for the promotion of a Foul Brood Bill. At least, from past experiences I feel convinced he would.

If such a keen observer and delightful writer, as Mr. Crawshaw undoubtedly is, were to spend his next holiday in Belgium (a country which has done more than any Bill-ridden country has been able to do), the information he might obtain there, together with the knowledge he already possesses, as displayed in his excellent address at the *conversazione* on May 12th last, on "Insurance etc., in Switzerland," there is no doubt in my mind but that a good step towards solving the foul brood problem would ensue. I feel much diffidence in crossing swords with a bee-keeper of such ripe experience as Col. Walker (No. 7944), but when he states that "Our colonies and the more virile branches of the Anglo-Saxon race entirely refuse to hear of compensation," I am tempted to recall to his mind that one of the peculiar features of Anglo-Saxon Society was the "Wergylde" or "life price." A sum was settled upon every freeman for nearly every injury that could be done to his person, civil rights, his honour, or his domestic peace. From the operation of this principle no one was exempt. The king, as well as the peasant, was protected by a "Wergylde."

That compensation is being paid in England and Germany to-day more than ever it was in the past (cannot be denied, and if Col. Walker will refer to page 138 of the "Immigrant's Guide and Settler's Handbook" of New Zealand (one of the most virile of our colonies to-day), he will find the following amounts are allowed as compensation for stock destroyed compulsorily, viz.: Horses £20 each, cattle £8 each, swine £2 each, and sheep £1 each.

I also ask him, as an experienced administrator of the law, whether he would accept, as evidence of proof, such mythical statements as "No doubt it has been introduced from a neighbouring apiary," or "probably some careless or ignorant bee-keeper has foul brood near."

As Mr. Hopkins (5014) is one of the two foul brood inspectors in New Zealand, I at

once take his word that they are not, as he says, "callous or cold-blooded." I assure him that the "reflection" he mentions came from the account of the police court proceedings, taken by him or his confrere, against the Otakiri bee-masters. That the New Zealand expert inspectors have been on the trail of the bee-keepers, the following passage in his letter to *Gleanings* of October 1st plainly shows, viz., when referring to the effect of his Act on the non-frame hive bee-keepers, he says: "The effect of this has been to drive out of the business, automatically, the great majority," etc., etc. [We complete the sentence, which is "of the ignorant and careless, leaving only the frame-men to deal with." The very object of the Act was to do away with the "ignorant and wilfully careless non-hive bee-keeper."—ED.]

From letters I receive from old pupils settled in New Zealand (the latest of whom states that he safely arrived two days before Christmas) the action of the "boomerang" may yet prove typical of this drastic and "very stringent Act" (to use the words of a New Zealand commissioner in a letter which lies before me).

At the last census taken in New Zealand there were 15,000 bee-keepers. It would be interesting to see by the next census how many have been "got rid of," and "driven out of the business." The conditions in New Zealand, with its ten persons to the square mile, and 30,000,000 acres of unoccupied land, are vastly different to those in the old country.

In the contents page of Bulletin 18, Bee Culture, dated 1907, foul brood is not even mentioned, but a year later they have, to use an Americanism, made things "hum" in New Zealand, in order to get in first in bee legislation, as they claim to have done in women's franchise, old-age pensions, State insurance, State coal mines, State railways, penny postage, etc., etc.

New Zealand bee farmers should read the remarks in *Gleanings*, September 1st, 1910 (p. 560) of Dr. Smith, State Entomologist, in which he states "that the foul brood inspection laws in force give too much power to the inspector, and that none of them contain any right of appeal from the decision of the inspector, and if the Bills got into the courts, as they surely would, they would certainly be declared unconstitutional."

I admire the discretion of Mr. Hopkins and Mr. Crawshaw in refraining from applying such terms as "what rot," or "the fool and the knave" to a brother bee-keeper's remarks, or character. We are also entitled to differ in opinion as to the side on which the persons alluded to in "D.M.M.'s" epithet (B.K.R., p. 189) "the clamant few" occupy in this discussion.—HERBERT SAMWAYS, Carmarthen.

#### FIGHTING FOUL BROOD.

[8102] All sympathy to "Depressed" (8090), B.J. February 16th. I am glad to

read that he is not yet "knocked out" although so badly hit.

Is it possible (paragraph 11, line 5) the woodyard spoken of is the cause of the constantly recurring foul brood and dysentery. Last March I went after a supply of timber and in selecting the stuff found many of the boards had hundreds of bees on them, many dead, and numbers of the boards filthily soiled, especially planed yellow pine. I was told the occupiers knew of no bee-keepers near, but that the bees were a great nuisance, and at times made some of the timber "stink."

Could "Depressed" get permission to make a thorough examination of the yard? Would it be likely the swarm remained there? And also, it might be well to do away with the wooden platforms and place hives on bricks only, or, at any rate, wash underneath and sides with hot lime wash?—H.C., Essex.

#### THE SPREAD OF "ISLE OF WIGHT DISEASE."

[8103] I cannot help feeling that the bee-keeping industry is in a very serious state.

Doubtless other readers of the B.B.J. besides myself would be glad to know if there is any prospect of a cure being found for the "Isle of Wight bee disease," for, failing such cure, bee-keeping is faced with the probability of being wiped out, which would be as great a calamity for the fruit and seed grower as for ourselves. Has a fresh start yet been made successfully at keeping bees in the Isle of Wight?

The question arises whether it would not be wise to take time by the forelock and clear out of the business at once.

Bee-keeping has had quite enough drawbacks to contend with, without this "last straw" being added.—RD. DUTTON, Essex.

[8104] According to reports that have reached me, the "Isle of Wight disease" is spreading so rapidly over many parts of this country that it is time something should be done in bringing the matter before the Board of Agriculture.

The disease is of so serious a nature that it threatens in a short time to destroy all the bees in this country, which would mean a serious loss to the nation, especially the poorer classes, who depend on the produce of the bees for their home supply of honey. It will also have a disastrous effect upon our fruit crops, the important part bees play in the fertilisation of fruit blossoms, etc., of every sort being well known.

My committee have already approached the Member for Windsor (J. F. Mason, Esq., M.P.), who promises to bring the matter at once before the Board of Agriculture, therefore, we sincerely hope that all bee-keepers will bring this matter before their Members of Parliament, with a view to urging the Government to appoint some practical bee experts, in conjunction with well-known bacteriologists, to investigate the cause and,



if possible, discover remedies, and inform bee-keepers what should be done for its prevention.

The quantity of honey imported into the United Kingdom is large; in addition to our own supply some £45,844 worth was imported in 1910.

Bee-keeping is largely increasing, and we are anxious that this source of income should not be checked by disease.

In the name of my committee, I ask all bee-keepers, whether they live in places infected or not, to unite in bringing to bear all the influence they can with their M.P.'s, to do their utmost to prevent the destruction of our bees.—(Mrs.) W. S. DARBY, Hon. Secretary, Windsor Branch of the Berks B.K.A.

### CAPPINGS OF COMB.

BY L. S. CRAWSHAW, NORTON, MALTON, YORKS.

*Soft Candy* (p. 34).—Is there any disadvantage whatever in the use of this during the winter? I seem to remember occasional advice given against its use, but I do not remember any reasoning advanced. I have noticed, in company with Mr. Woodley, that bees have sometimes preferred candy to stored syrup. Not only so, but candy has been consumed, perhaps only in connection with storing, in preference to breaking into sealed honey. Whilst I am in the habit of making candy and supplying all stocks of fair strength and light stores, giving it upon favourable occasions during the winter, such stocks have not seemed to suffer in any way from the disturbance. Is there contrary evidence, or is the big business which is done in the commodity based upon sound practice?

*I.O.W. Disease* (p. 34).—We are now getting reports of this from the North, and we naturally want to know how the cases arise. Perhaps those who know will take note of Mr. Woodley's injunction to investigate, and will report, so that we may form some idea of how the disease is communicated. Here, if ever anywhere, is work for the local association.

*Webb's Hive Divider* (p. 35).—It is questionable whether Mr. Fischer Webb's well-intentioned effort to defeat, by means of vaseline, the instinct of the bees in thus stopping the saw kerfs will be attended by any benefit. Is it not a fallacious supposal that greater inter-radiation of heat, that is to say, a flow of air from one side to another, is desirable? Such a current would be largely dependent upon the direction of the wind. I should prefer to keep each colony in a multiple hive as individual as possible, whilst separated by, if you like, the thinnest of partitions.

*Bee Problems* (p. 35).—I wonder if others find these as interesting as I do. Oftentimes I run over the details several times before confessing failure to solve, or deciding upon a definite solution, which occasionally includes possibility of error on the part of the

narrator. And such admissibility of error arises occasionally. I believe, from failure to note down the exact date when observation made. This is a point well worth the attention of those who desire to share their experiences, and obtain comment or criticism. Such careful data as those given by "Humble Bee" have a value which is not inherent to partially investigated and loosely detailed facts, which are only too often coloured with theory. Having said so much, my friend "Humble Bee" will forgive me for questioning whether his queen was mated on July 10th. I have never known a queen to lay upon the mating day, as would be at least necessary on his figures. I am not to be understood as asserting that it could not occur, but I think that hers was a subsequent flight, the first eggs being possibly already laid, and her altered appearance due to her already pregnant condition. The later symptoms read like "I.O.W. disease," but I am not, thank heaven, able to speak from experience. If they were not, they show how little we know of what actually passes through the bee mind in these abnormal cases. I wonder if the manure could affect them. By the way, the most profitable place for hen manure is from two to three spits deep in the land. Will some of our gardening friends who have not done so try it, and note the results? Do not be afraid of burying the manure, as the products of fermentation will be available for plant growth.

*Electric Embedding* (p. 37).—The current is conveyed to the wire by making contact at each end close to the end bar. Two small handles, or a combined handle, connected to the circuit are used for the purpose. A dry battery, unless very powerful, would not do the work. Quite a number of cells of about 2 volts each would be required to sufficiently and quickly heat some thirteen inches of No. 60 wire in contact with foundation. I do not know how many, but anyone having an installation could determine it in practice, but it would certainly not pay to use cells for such a purpose alone. Current obtained from a lighting system would be suitable, in conjunction, as described by "D.M.M." with a resistance frame to reduce the intensity. Anyone having a power extractor could couple up to the engine a small dynamo which would do the work, but unless many frames were to be wired, it is difficult to see where the economy would come in.

*Flowers of January* (p. 38).—These notes by "Lordswood," tinged as they are by the writings of Richard Jefferies, whose spirit he seems to have absorbed in great measure, might almost have been penned this year. I am struck, however, by his omission of the modest snowdrop. Our first snowdrop opened this year on January 7th, and at a date equal to his own we had bunches of these delicately petticoated ladies nodding in the grass and the border. Most years I have thought they showed to greater advantage against the wet, dark earth, but this year I am in doubt.

it must be due, I think, to a difference of season, and with less rain, a difference in the ground colourings. Have you ever really looked inside a snowdrop, a double one for preference, although the single variety hangs with a special charm, and admired the contrasting colours of green and white? I think it is Ruskin who depreciates this lovely winter flower, on the ground, forsooth, that it has no smell. Whilst its smell may not be overpowering, yet it is there. The bees, at least, appreciate its attractions, and are to be seen visiting blossom after blossom in the sunny days of January and February.

## Queries and Replies.

[4091] *Bee-Keeping in Ontario.*—I intend going to Port Arthur, New Ontario, Canada, in April, to take up mixed farming or market gardening. Can you please give me any particulars respecting bee-keeping in that district? We have an apiary of about a dozen stocks here, in which I do most of the working, as my partner has other duties, and is away most of his time. We have made all our hives on the W.B.C. and Combination patterns. We had a very poor season, but got all our stocks into winter quarters in a strong and healthy condition, and I do not think there has been a single week that the bees have not had two or three days flying throughout the winter. I should also like to know about bee literature in Canada. I am a regular reader of your paper, and look forward to it every week, and get many useful hints from it.—“PORT ARTHUR,” Scarborough.

REPLY.—The southern part of the Province on Lake Ontario is where bee-keeping is mostly carried on successfully, but we cannot say what the prospects would be at Port Arthur. We would recommend you to put yourself in communication with Mr. Morley Pettit, Provincial Apiarist, Ontario Agricultural College, Guelph, Ont., who would probably be able to give you all the information you require. There is an Ontario Bee-keepers' Association (secretary, P. W. Hodgetts, Toronto), and *The Canadian Bee Journal* is a monthly paper, edited by J. J. Hurley, and published at Brantford, Ont., at a dollar a year.

[4092] *Bees at a Railway Station.*—There are several bee-keepers in this locality, the writer being one of them, and during last season a case of some kind of fruit syrup was left on the station platform in a leaking condition, which attracted the bees. This case was taken into the booking office, and the syrup was spilled all the way. The bees took possession of the office, and a porter came for me and asked me to fetch them away. On my arrival I found all passengers at the far end of the platform, the booking office door and windows all closed, and inside were several porters and clerks removing desks and other articles of furniture into

the centre of the room. The windows were covered with bees, and the men were burning brown paper to smoke them out, and killing them as fast as they could. I told them to open the door and windows, as it was getting towards night and it was evident that the bees wanted to go home; also to mop up the syrup with hot water and strong carbolic, and this they did. I want to know what could anyone getting stung have done under the above circumstances. Could the company or any passenger claim damages, and from whom?—“MONTPELLIER.”

REPLY.—We should think that if any ill effects resulted from the stinging, the company would be primarily responsible, and under the circumstances the passenger could proceed against them. The company would have their remedy against the bee-keeper if they could prove his bees to be a nuisance, but in this case the bee-keeper would be able to show contributory negligence on the part of the company.

[4093] *Transferring Bees.*—Will you kindly let me know in your next issue of the B.B.J. the following:—(1) I have an old hive which is tumbling to pieces. Kindly advise me how, and when, to remove the bees into a new one. (2) Last August I put one of Taylor's super skeps on the same hive, as the bees would not swarm; they filled the skep with comb, and yesterday I noticed that the centre comb was partly sealed in the middle. Would this be brood? (3) When ought I to remove the skep, and ought I to provide pea-flour for the bees on sunny days? (4) When shall I be able to transfer the bees from Taylor's skep into a frame-hive, and how?—E.A.B., Ruthin.

REPLY.—(1) The bees should be transferred the first real warm day in March. (2) If the cappings covering the cells are white in appearance it is honey, if light brown and mealy-looking it is brood. If it is honey you can remove it on a warm day. Drive out the bees and run them in at the front of frame hive. If it is brood you must allow it to remain until the queen descends to the frames; then put on an excluder between skep and frames. Three weeks afterwards the skep can be driven as stated above. (3) If pollen is scarce in your district you can put pea-flour out in a box or skep containing shavings for the bees to collect. (4) See reply to first query.

[4094] *Good Bee Districts.*—I am considering taking up bee-keeping. Would you kindly through your valuable weekly paper let me know which of the two districts is the best for honey, East Kent, or the Isle of Man?—E.C.B., Southport.

REPLY.—East Kent is a very good district for bee-keeping, as is also the Isle of Man. We should prefer the former, as in the island the scope is limited. There are a good many bee-keepers there already, and we know of one or two others who intend to settle there and keep bees, so it is quite possible for the place to become overstocked.

THE BEE PEST PREVENTION ACT  
(IRELAND).

RESULT OF PROSECUTIONS.

At Clonroche Petty Sessions, on February 10th, the cases under the Bee Pest Prevention Act, which were adjourned for two months in November, 1910, again came on for hearing.

Particulars appeared in the B.B.J. in November last.

The County Council prosecuted Mr. J. Stephenson, Adamstown, and Patrick Doyle, Kellystown, for refusing to allow the bee inspector to examine their bees.

Mr. J. Elgee appeared for the County Council, and Mr. Scallan for the defendants. The case had been adjourned from a previous court.

The Chairman asked was there any settlement? Mr. Elgee—No.

Mr. Scallan: On the last occasion a deputation was to wait upon the County Council, about the inspection, and Mr. Stephenson, who undertook to have the case settled, took no action in the matter. Mr. Scallan went on to criticise the action of the inspector, who, if the bees were suffering from foul brood, should have ordered them to be destroyed on his first visit, instead of leaving them for six weeks later. Consequently, when the inspector called the last time, the bees were in the honey flow, and Mr. Stephenson would not let him disturb them.

Mr. Doyle did not deny the right to inspect.

Mr. Elgee submitted that that decided the case, as, under the Act, the inspector was empowered to inspect bees at any reasonable time.

Mr. Scallan said that the question was, whether the time was a reasonable time.

Mr. Elgee said that the Act stated that reasonable time was between April 1st and October 31st.

Mr. Scallan said that this was the first prosecution of its kind in Ireland, and it seemed as if the County Council deliberately singled out these men, who were the greatest honey producers in the county, for a prosecution.

Mr. Elgee said that was the reason the two men were singled out. If they refused to allow the Act, when enforced, the smaller bee-keepers would follow suit.

Patrick F. Byrne (bee inspector) gave evidence to the effect that Mr. Doyle refused to allow him to inspect the bees. This was in July. Previous to that Mr. Doyle invited him to inspect the bees.

Cross-examined, witness said that Mr. Doyle gave as his reason for not allowing him in, that inspecting the bees would throw them back in their work. The reason defendant did not get notice to destroy the bees before six weeks, was because the order to destroy them could not be issued until after a meeting of the County Committee of Agriculture.

In reply to the Chairman, defendant said

that he had destroyed a number of hives after they had produced the honey.

Mr. Scallan submitted that the action of the County Council was most unreasonable. When the bees were ordered to be destroyed Mr. Doyle had gone to considerable expense in putting on the crates, and it was unfair to ask him to destroy them when the bees were making honey.

Defendant said that he understood that a deputation was to wait upon the Department to have the time changed to a more suitable one. It seemed there was no truth in that whatever.

Mr. Elgee read a letter from Mr. Gill stating that there would be no attempt made to ask the Department to alter the rules dealing with bee inspection.

The Chairman said he believed Mr. Doyle had given the County Council every facility; however, as he had committed a technical offence, he would be fined 6d., and 4s. costs.

No professional costs were allowed.

In the case against Mr. Stephenson a similar order was made.—*The Echo*.

OLD BEE LITERATURE.

(Concluded from page 79.)

They have (beside) a marvellous order among them: namely, that the youngest Bees fly abroad, and bring home the food; the elder sort biding at home, to dress and prepare it. But that which is yet far more admirable is, that when the young ones arrive, laden with herbs and flowers laboriously, some of the aged sort meet them at the entrance, and help to ease them of their burden. Moreover, such as come so home overcharged, seek the sweetest airs to pass through, and where they are calmest: as fearing, lest rude winds should make them let fall what they have carefully gathered, or dry up their honey, and therefore they fly lower towards the ground: and such as bring home no lading carry little stones or gravel, that by the weight of them they may resist impetuous winds.

By this precedent example, young men are admonished, that they ought to stir and labour in the Commonwealth; and the more aged, to preserve the fruits of their pains. Young men also, that do busy their brains in the blusterings or ambition; should take a lower flight and nearer to the ground, esteeming themselves to be no more than men: considering uprightly in their souls that whatsoever benefit ensueth by their pains to the Commonwealth, they stand

bound thereto by obligation. Let no man therefore overween, or strive to out go or be above other, except his contention be honourable, and that his travel may most advance the good of the Commonwealth.

While thus these poor creatures are labouring abroad, their King, abides at home, having a strong court of guard about him, well armed with their stings, for the defence of his person. He goeth abroad but very seldom, and when it is his pleasure to go forth, he is (in like manner) royally attended. But when he will have his army abroad to any expedition, three days before, loud summons is given for orderly preparation. If any troop of them swerve from following him, they find their error, by smelling to the ground where the King hath past, and so pursue in that tract, until they overtake him. It is to be admired, how highly they are comforted in his presence: for if he be lost by their negligence, the army loseth itself, and then they go to join with another King. Pliny also reporteth, that when their King dieth, they are so full of anguish and sorrow, that they will neither feed nor fly abroad for any provision; so that if he be not taken away dead from before them, they will also die with grief and hunger. Tutoring us herein, that if strifes and variances happen among us, they should not last of any continuance: also how the death of our Prince should be irksome to us, because little benefit cometh by changing governors. Thus we perceive, how many good examples may be derived from the Bees Commonwealth, not utterly unnecessary for our imitation.

## Notices to Correspondents

G.W.A. (Carlisle) *Books on Wild Bees*.—The best and most complete work on British wild bees is "The Hymenoptera Aculeata of the British Isles," by E. Saunders, F.R.S., published by Lovell Reeve and Co., London. This can be had with three structural plates for 16s. net., or a larger edition, with forty-nine coloured plates, for 48s. net. "British Bees," by W. E. Shuckard, by the same publishers, price 9s. net. is an older, but very useful, work, and contains a great deal of information on the habits of bees. "Wild Bees, Wasps and Ants," by E. Saunders, published by G. Routledge, London, price 3s. 6d. net., is a popular little book, but only describes the commoner species.

E.A.M. (Kidderminster) *Respecting an Old Book*.—"The Natural History of Bees," 1744, is a translation from the French "Histoire Naturelle des Abeilles," by le Sieur Bazin. It is not a rarity, as it figures from time to time in second-hand catalogues at prices varying from 2s. to 4s. We are much obliged to you for offering to let us see it, but we have the original, which is in two volumes, and the English translation published in one volume, which you describe.

E.C.P. (Nuneaton) *Dead Bees*.—The bees died of starvation, as the cells are all occupied by bees head downwards. No doubt in the cold they were not able to reach their stores, and have died with plenty not far off. The small quantity of brood is chilled, and there is no sign of disease.

WANTS TO KNOW (Cumberland) *Working for Surplus*.—(1) If the circumstances are the same, the reply given (4087) is equally applicable to your case. (2) In re-queening stocks, remove old queen and introduce new one by any of the methods recommended on pages 135 to 142 of "Guide Book."

R.C.M. (Lincoln) *Disinfecting Combs*.—Fumigation with formalin would be partially effective in destroying spores, as it could only affect those on the surface. Burning infected combs is the safest remedy.

J.U.G. (Kent) *Aylesbury as a Honey District*.—(1) This is considered a good district, but if you will apply to the secretary of the Bucks B.K.A., Miss E. Scott-Walker, 5, High Street, Slough, you will obtain the information you require. We do not think that foul brood and "Isle of Wight disease" are more prevalent there than in other parts. (2) So far, "Isle of Wight disease" seems to have spread from the south towards the north, along the eastern counties, but it is not correct to suppose that more than half the country is infected. Some of the cases in the north have been clearly traced to swarms and driven bees obtained from the south, and these now form centres of infection. There are no legal powers to prevent the spread of the disease or compel the destruction of infected stocks, and until such powers are obtained the B.K. Associations are powerless in the matter.

### *Suspected Disease.*

G.J.F. (Barnet).—Many of the bees have died of starvation, there also appear to be traces of "Isle of Wight disease." Burn all internal fittings of the hive and disinfect it thoroughly.

W.W. (Herts).—The bees have had dysentery first, and then died of starvation; being few in number, they were not warm enough to move to the combs containing food. You had better melt down the combs and disinfect the hive by washing with carbolic acid. See "Guide Book" (p. 198). English and black bees are the same.

W.T. (High Rickington).—There is nothing to show that the bees have any disease, but those sent seem to have died of starvation.

A.T.G. (Trimsaran).—Bees appear starved.

## Editorial, Notices, &c.

### BRITISH BEE-KEEPERS' ASSOCIATION

The annual meeting and conversazione of the British Bee-keepers' Association, which will be held on March 16th at the Gardenia Restaurant, Catherine Street, Covent Garden, W.C., promises to be of unusual interest. Dr. Malden, of Cambridge University, has consented to address the members at the conversazione following the meeting, on the result of his experiments in investigating the Isle of Wight disease. Mr. O. R. Frankenstein has promised to read a paper on "Marketing Honey," and a further attraction will be the bioscope pictures of bee life, by Mr. J. C. Bee-Mason. In view of the efforts made by the council to ensure that members and their friends shall spend both an instructive and enjoyable evening, it is hoped that all who are able to do so will attend. Light refreshments will be provided as usual, and all interested in bees and bee-keeping will be welcome. The meeting place is a most convenient centre, and can easily be found, as it is next door to Drury Lane Theatre.

We should also like to remind readers that insurance policies should be renewed this month. The new forms can now be had from county B.K.A. secretaries, or from the B.B.K.A. office, 23, Bedford Street, Strand. Bee-keepers should not delay in safeguarding themselves from loss by insuring their stocks before the active bee season commences, when the risk of accidents is greater than at any other time.

### FOUL BROOD LEGISLATION COMMITTEE.

A meeting of the above committee will be held on March 16th, at 2 p.m., at 23, Bedford Street, Strand, W.C. As there are a number of items for discussion it is hoped that all members will make an effort to attend.—L. S. CRAWSHAW, Hon. Sec., F.B. Legislation Committee.

### REVIEWS OF FOREIGN BEE-JOURNALS.

By "Nemo."

*War-works of Bees.*—M. Bourgeois says in *l'Apiculteur* that the secretion of wax and the construction of comb are two quite different functions of bees, although frequently confounded. The former does not necessitate the latter, but comb-building requires the secretion of wax. This secretion is involuntary and produced unknowingly by the bee, and if not used im-

mediately the wax-scales are cast off as refuse. The construction of the combs is the united effort of all the members of the colony, whereas wax-secretion is the natural product of each individual bee. The amount of wax which a colony can produce in a season depends on different causes. In practice, M. Bourgeois finds that a harvest of 10 kilos (22lb.) of honey induces a natural secretion of wax varying between 300 to 500 grammes (10½ to 17½ ounces). Certain nectars and pollens cause the production of more wax than others. During hot weather, when it is cloudy and slightly moist, wax-secretion is more abundant than if it is hot, bright, and dry. M. Bourgeois says that it is usually stated the bees confined and fed artificially produce wax by digestion. In practice this is found to be an error, for, though such bees will produce a small quantity of wax, it is at the expense of their health, and if persisted in it ends in the bees dying of exhaustion.

*Baron Bela v. Ambrozy.*—German papers announce the death of the Baron Bela v. Ambrozy, of Temes-Gyarmatha, Hungary, which took place on 18th January last. The Baron was 72 years of age, and a zealous promoter of bee-keeping in Hungary, and rendered special service by his introduction of the moveable comb system, which has largely superseded the old skep methods. He was an indefatigable worker and had an apiary of between four and five hundred colonies, and to the last managed two hundred of them himself. He adopted the Dzierzon twin hives, and attributed his great success to their use, and in order to improve the honey resources of the neighbourhood he sowed *Phacelia* seed extensively. Baron Ambrozy was the author of a Hungarian manual of bee-keeping and a frequent contributor to bee journals. He was also a regular attendant at bee-keepers' conventions, and president of the Hungarian Bee-keepers' Association.

---

### No. 3 THE HAWTHORN (*Crataegus arcantha*).

NAT. ORD., *Rosacea*.

The genus of which this is the only British representative, only differs from *Pyrus* — the genus containing the apple, pear, &c. — in some minor points, and, like it, is spread over all the temperate regions of the northern hemisphere.

Among the numerous and beautiful plants of the hedgerow the hawthorn takes a very prominent place. Its masses of white flowers, their rich fragrance, and the early time of year in which they are found all make the hawthorn a general favourite.

This plant is equally well known by the names of hawthorn, whitethorn, or may.

To the fact that in the autumn it is loaded with bright red berries, which are popular as "haigs" or "haws," may be attributed its first name. Whitethorn is doubtless given to it to distinguish it from *Prunus spinosa*, or blackthorn, the bark of which is darker than that of whitethorn. The third name indicates the time of flowering as in some other similar cases—e.g. (*Hebeborus niger*) the Christmas rose; (*Lilium candidum*) Easter Lily, &c. It is seldom found well in flower in the month of May, because the calendar having been altered since this name was given it, and consequently the month is much earlier than it was formerly.

There is great variety in both form of foliage and colour of flour. The leaves are stalked, deeply serrated, which divide them into three or five segments.

The flowers are generally white, though sometimes pink, and even a deep crimson, and are grouped in little clusters on short, leafy branches, which are botanically known as "corymbs."

There was, some years ago (and it may still be there), near Glastonbury Abbey a famous hawthorn which always flowered twice a year. It is stated that Joseph of Arimathea first brought Christianity to England, and that one day when he was preaching in Glastonbury he thrust his staff into the ground to emphasise what he was saying, and to convince the islanders it at once grew and blossomed, and ever after flowered each May and December.

There are other specimens in England which are known to bloom twice in the year.

Hawthorn is considered by the majority of bee-keepers, I believe, to be a good nectar-producing flower, but I am inclined to think it is not so good as it is thought to be. That it does yield abundantly I will admit, but, as far as I have observed,

it appears rather fickle. For it to yield nectar, climatic conditions must be ideal.

Often, when in bloom, bee-keepers are thinking that their bees are obtaining not only sufficient for the needs of the colony, but also some surplus, although, as a matter of fact, the blossoms may be yielding next to nothing.

Its pollen, which is borne on bright pink anthers, when taken from the flower and viewed by transmitted light, is a dull pale green, but when taken from the bee it is a dull dark green. Its first form is like that of the apple as seen at 1, and measures  $\frac{1}{1000}$  by  $\frac{1}{300}$ . When placed in water it at once assumes

the spherical form with the extine greatly extended as seen at 3 A, and eventually as seen at 3 B.

In oil it is of the same form as when dry, except that the oil makes it transparent. I have never found that pollen grains change their form in oil; but this method of observation often enables one to better realize their construction.

In formalin we get the triangular form with a very granulated appearance, as seen at 4.

From honey we find it triangular and almost spherical, but the triangular is the last form this grain assumes, and it then measures, from base to apex,  $\frac{1}{1000}$ . The colour is a dull yellow.

It will be noticed how much alike are these and the pollen grains from the apple which is of the same natural order.

(To be continued.)

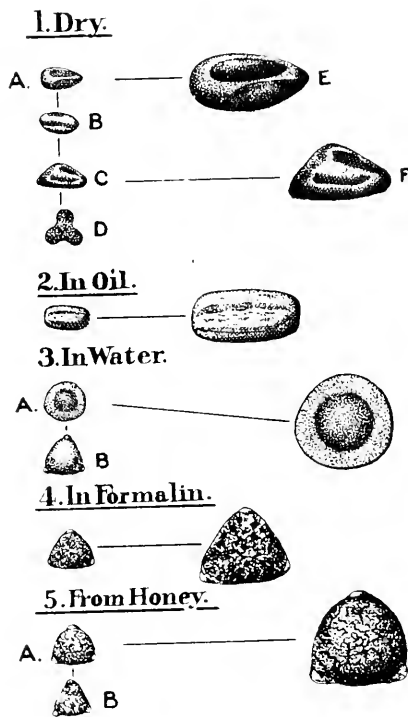

FIG. 6. POLLEN OF HAWTHORN.

## HONEY IMPORTS.

The value of honey imported into the United Kingdom during the month of February, 1911, was £403.—From a return furnished to the BRITISH BEE JOURNAL by the Statistical Office, H. M. Customs.

## Correspondence.

*The Editor does not hold himself responsible for the opinions expressed by correspondents. No notice will be taken of anonymous communications, and correspondents are requested to write on one side of the paper only and give their real names and addresses, not necessarily for publication, but as a guarantee of good faith. Illustrations should be drawn on separate pieces of paper. We do not undertake to return rejected communications.*

### NOTES BY THE WAY.

[8105] March has come in quite lamb-like fashion, with nothing of the roaring of the lion about it, so far. Sunday (the 4th) was a beautiful day, and the bees were on the wing, in large numbers, at the watering places, and away to the woods for natural pollen. The artificial supply provided was cleared up, time after time, during the day, while a large tin of thin warm syrup, given after my return from church, was taken into the hives in an hour or two. These helps, I consider, are worth the trouble they entail, as they induce the extension of the brood nest, and, as I have no other bees nearer than a mile, by open feeding I am giving a supply to my own bees only.

I notice "D.M.M." (page 77) wonders if many beekeepers use smoke at the entrance of hives when they are manipulating. I never think of doing such a thing; I remove the wraps, except the last piece of carpet, then spread out my carbolized cloth, or rather shake it out ready to spread, take the front two corners of the quilt and peel it off the frames and the carbolized cloth takes its place. I at once spread the combs as required for examination of any particular comb; this is easily done in the combination hives with the frames parallel with entrance and a movable dummy at the back of combs. The high thin sides of these hives prevents the cloth being blown off, as is the case with those having frames level with the sides of the hives.

That million dollars (page 77) seems a big sum to spend in a vain attempt to check disease, as we have it on good authority that foul brood is spreading at an alarming rate in the States of America. Yet friend "D.M.M." evidently wishes Britons to accept a Foul Brood Act that will prevent a British bee-keeper from disposing of any product of his apiary if a small outbreak of the disease should be found there by an inspector. Page 89 of our journal shows how the Irish Act is being administered; the prominent bee-keepers are made the scapegoats by the inspectors, who, when once

appointed, are masters in everything pertaining to bees. They can choose their own time to inspect them, even in July, just in the midst of the honey harvest. Consider what it means to a man with one or two hundred hives, to have his whole apiary upset by a hive-to-hive overhaul when every hive is supered. Why, it would cause a loss of several pounds (£ s. d.), as the upset would mean a day's work lost to every colony examined, or, in short, 100 days' work lost to the owner of 100 hives; and then, if the inspector should find one of the hives infected, he would have the power to prevent the owner from disposing of the produce of the ninety-nine healthy stocks—perhaps a ton or two of honey. That was in the draft of the last projected Act, which we are adjured to accept; and anent that Act I noticed a little par. bottom of page 80, and I should like to know the meaning of the last four lines. Are we to be treated in England as the Irish bee-keepers were over their Act, a year or two ago? I trust our British Bee-keepers' Association will never stoop to get an Act through Parliament without consulting the bee-keepers of England, by way of referendum, or that the larger bee-keepers of England shall be exempted from any Act relating to bees, except when they make application for the services of the inspector.—W. WOODLEY, Beedon, Newbury.

### "DZIERZON."

"I want a hero—an uncommon want  
When every year and month bring forth a  
new one."

Byron's ideal hero, however, must be martial, for straightway he enumerates a long list of possible names, all of whom are warriors. Why search for heroes amid the clash of arms? In the daily struggle of life, heroic deeds are done, and unknowingly we rub shoulders with heroes. The world is full of heroism, nor need we the candle of Diogenes to aid us in the search.

The man of intellect in advance of the thoughts of his days who has the courage to nail his theses to the cathedral door, and there defend them against all comers—that man is a hero, and such a one was Dzierzon.

But so recently has the tale of his life been told by more able pens than mine that I need hardly stop to dwell on it. I have in front of me his book, "Rational Bee-keeping," and, as this year is the centenary of his birth, it may interest and will be instructive to ramble through its pages. The preface tells me it was written in 1861, fifty years ago. What marvellous progress have we made since

then. Take this book and the date, and look back to it, as one of the resting places from which we may count our milestones on the high road of progress. How primitive now seem the hives of those days, the Lager and Ständer, the Straw Stülper, Bognestülper and Thorstock, the latter similar in appearance to the straw travelling basket one sees nowadays for dogs and cats. Foundation was just being thought of, for he argues that "it will hardly obtain much practical importance, because it will remain a pretty expensive article, and will be difficult to fit to bars," and he instructs one "to be careful in keeping and preserving from waxmoth all the pieces of comb which he obtains when uniting colonies," to be used as guides.

But when Dzierzon teaches of the feeding of bees then we begin to fear lest we may have lost some treasured secret. As a substitute for pollen he recommends a milk and egg preparation. "The new milk is boiled and strongly sweetened with sugar. The contents of the egg are thoroughly mixed with honey or dissolved sugar, and used as food in that way." When further he says, "This problem has been brilliantly solved by manifold experiments in egg and milk feeding, the results of which have been communicated to the meetings at Halle, Strasburg, and Breslau," one wonders if there is anything in it. Does any modern bee-keeper stimulate or go to the winter feeding his bees in this fashion? It would be interesting to know, and the results obtained.

Again we smile when he comes to his catalogue of "Apicultural Implements," implements of torture, I could almost write. They remind one of the hooks and prongs used in the Middle Ages for political and religious offenders. How "gain" for use would be his smoker, half garden syringe, half old-fashioned domestic bellows, or his bee veil, again to quote him, "In its usual shape, a small oval sieve, with a bag attached of corresponding width, to go over the head, but it is very uncomfortable and very oppressive in great heat." Quite agreed, and also, "but a proper bee-keeper rarely or never makes use of a bee veil." Yes, give the insects a chance. It is scarcely playing the game, except in extreme cases, to so encase yourself that the bees cannot get at you. You have the advantage of the smoker or the carbolic cloth, and need little more.

In all good humour we criticise the conceits of bygone days, but there are thoughts and words of Dzierzon's which are worthy to be written in letters of gold.

Would you read an author who writes? then study the preface of his book. It is a justification of its existence, and from the preface of the German edition I cull

the following sentences: "For he only is entitled to be called a rational bee-keeper who clearly comprehends why a thing is done in a certain way, and not in any other, and who is able to give the reason for everything he does." To comment on this would be akin to painting the rainbow. Let me then hasten to other words of wisdom. "The more intimately he becomes acquainted with the nature of bees, the more wonders he will discover, and the more enjoyment he will derive from bee-keeping," and yet, again (for I am keeping the best wine for the last). "Nothing affords such pure and lasting pleasure as the contemplation of the works of the Almighty, in the wonders of Nature, but nowhere do we find such an exhibition of the wonders of Nature as in a colony of bees."

Science has not stood still since Dr. Dzierzon wrote, and we know now, in a later century, that many of his deductions were incorrect, but he was a glorious pioneer. I have in this article only collected together a series of extracts. I cannot conclude in a better manner than by adding one more, the words of a former editor of the "British Bee Journal"—Charles Nash Abbott—"a work by an authority that contains riches in every page well worthy the study and consideration of all bee-keepers." Such were his opinions when presenting to English readers the translation of the writings of this master mind in the "Poetry of Apiculture."—Jno. SMALLWOOD, Hendon.

#### FOUL BROOD LEGISLATION.

[8106] Little time or desire as I have for controversy I feel constrained to acknowledge my error as pointed out by Mr. Samways (8108, p. 85). I do so the more gladly because the correction helps to establish the point upon which I laid stress (p. 426), viz., that even if on sanitary grounds compensation be granted for losses arising from the compulsory destruction of cattle, pigs, &c., there is no adequate reason for extending it to cover the case of bees. That the principle should have been so clearly recognised in New Zealand is highly satisfactory.

In days when men were scarce upon the land, and the rough and ready system of blood for blood was apt to make them scarcer, the institution of Wergild may well have had its merits. The difficulty lies in connecting it with the modern idea of sanitary compensation.

As to the legal question propounded, I must ask Mr. Samways to pardon me if, in Parliamentary fashion, I let it remain unanswered.—H. J. O. WALKER, Lieutenant-Colonel.

[8107] It seems to me that the opponents of foul brood legislation have seized



on my unhappy case to extract from it arguments in support of their contention that beekeepers should be allowed, without let or hindrance, if they are indifferent to their own interests or those of their neighbours, to spread infection broadcast in their vicinity. Will you permit me to point out to Mr. Samways (p. 85) that my first attack of foul brood was in 1908, when I had no imported queens in my possession; that my next attack was on July 24, 1909, more than six weeks after the imported Italian queen was introduced; and that last year's attack was just about a year after the imported queens and their progeny had been destroyed, and I had then nothing but English queens in my apiary. To put the three annual attacks down to the imported foreign queens in the middle year of the three is, I venture to think, unreasonable.

Besides, what justification has Mr. Samways for being so cocksure that the imported queens brought foul brood? Does it follow always, or even once in a hundred times? On what does he base his belief?

In most things I think the Englishman (and rightly so) is an individualist, and hates interference in the management of his affairs, either legal or otherwise. But the legislation in connection with infectious or contagious diseases, both human and animal, has been found essential to the well-being of the community, and has proved to be of inestimable value—take rabies alone, now stamped out, though serious enough some years ago. I need say nothing about the Acts in connection with foot-and-mouth disease, pleuro-pneumonia, swine fever, &c. I am pretty sure that had bee-keeping been a sufficiently important industry years ago, an Act would have been passed, similar to the Irish Act, and foul brood would by this time have practically disappeared.

I do not say it in any unkind spirit, but I should like some opponent of foul brood legislation to have a man sent down as his immediate neighbour whose hives were full of foul brood, and who refused to destroy them or to take other steps to get rid of the disease, or even to let anybody else do it for him; or, lastly, even to sell his hives to his neighbour in order that the latter might destroy them. I have heard of such a case. I am pretty sure the views of the opponent of foul brood legislation would rapidly change under the force of events.

In my opinion an innocent bee-keeper whose bees were being decimated by foul brood, caused by such action on the part of his neighbour, would succeed in an action for damages if he could prove that the latter, having the disease to his knowledge in his apiary, had taken no prompt and active measures to stop the spread of

infection; and I should certainly recommend any man who finds himself in that position to test the matter by an action. But that is where the merit of the Act would come in. In small communities it is so unpleasant to be at odds with one's neighbour that most men would rather suffer than take proceedings, but with the Act in force, the local authority would be able to put an end to the trouble without causing bad blood between neighbours.

Allow me to thank H. C., Essex (p. 86), for his suggestion; I will certainly take an early opportunity of examining the wood yard.

(LATER).—Chance has placed in my hands to-night (March 4th) a report corroborative of my own suspicions, as well as the editor's, as to my apiary probably contracting foul brood from an infected neighbour, whose name and address are, however, as yet unknown to me. A friend of mine, a lady, who used to keep bees within a few hundred yards of my house, but who sent them early last year to her son in the country, called on a dealer and bee-keeper in London the other day for some appliances. She was being served when the attendant, probably knowing where she lived, volunteered the remark that he had been, a few days before, to see an apiary in——, mentioning a district within less than a mile of my house, "and," he added "he has enough foul brood to infect the whole neighbourhood." I intend, of course, to follow this up, and try to find out further particulars. If I do succeed in getting my neighbour's address, I shall certainly call on him and ascertain his views as to his duty and responsibility in the circumstances.—DEPRESSED.

#### THE AMERICAN STANDARD FRAME.

[8108] I have for the past five years tested the Langstroth American Standard frame side by side with our British Standard, and without hesitation I can say it is far superior to our own. The bees winter well in hives containing these frames, come out stronger and develop surprisingly in the spring with little attention, take to the sections almost at once, owing to the greater warmth coming from the narrow brood nest, give more surplus, and should one get a swarm, it is a "bumper." In my opinion this is the frame for the progressive bee-man, and it only requires our appliance makers to stock frames this size as used by our American cousins (both brood and shallow for supers) to ensure their adoption by beekeepers.—SEVENTEEN YEAR BEE-KEEPER, Bonhill.

We are sorry to disagree with our correspondent, for we have also tried the Langstroth hive, and at one time, in the earlier days of our bee-keeping, some forty years ago, we had ten such hives in an

apiary of forty colonies. Although we succeeded very well with them, we found for general purposes our British Standard frame in every way the more useful, and therefore by degrees eliminated the Langstroth hives. All our large takes of honey have been from hives with the British Standard frame, and we can claim for this all the advantages our correspondent claims for the Langstroth. Dealers some years ago used to stock this hive, but it did not meet with much favour, and we suppose they have discontinued doing so because there was no demand.—ED.]

#### SHAKESPEARE AND THE BEE.

[8109] I have enclosed some lines from Shakespeare which I thought might be of interest to those readers of the B.B.J., who have not read them before.—

W. G. HINDE, Olney.

Therefore doth heaven divide

The state of man in divers functions,  
Setting endeavour in continual motion;  
To which is fixed, as an aim or butt,  
Obedience: for so work the honey-bees,  
Creatures that by a rule in Nature teach  
The act of order to a peopled kingdom.  
They have a king and officers of sorts:  
Where some, like magistrates, correct at home,

Others, like merchants, venture trade abroad,

Others, like soldiers, armed in their stings,  
Make boot upon the summer's velvet buds,  
Which pillage they with mery march  
bring home

To the tent royal of their emperor:  
Who, busied in his majesty, surveys  
The singing masons building roofs of gold,  
The civil citizens kneading up the honey,  
The poor mechanic porters crowding in  
Their heavy burdens at his narrow gate,  
The sad-eyed justice, with his surly hum,  
Delivering o'er to executors pale  
The lazy, yawning drone.

—“King Henry V.” act i., sc. 2, lines 184 to 204.

## Queries and Replies.

[4095.] *Subduing Bees.*—When subduing bees, how long, after smoking, should one wait before opening out the hive? I find they make a loud buzzing noise when smoked. Will this buzzing cease and will they become quite quiet when completely subdued? If so, may they be dealt with as soon as the buzzing stops? Your advice will oblige.—NOVICE.

REPLY.—The buzzing is quite natural, provided the bees have plenty of food in the combs, if you wait about a minute it will give them time to gorge themselves with honey and you can then manipulate with safety.

[4096.] *Stimulative Feeding.*—As a constant reader of your invaluable little journal, may I ask you a few questions?—(1) When should I start stimulative feeding? I see my bees are carrying pollen well; should I provide pea-flour? (2) What flowers are best for planting in the garden for honey-yielding? I am giving up a big piece, formerly used as a vegetable garden, to flowers this year, to provide plenty of work near home for the bees. I am a beginner and have three hives, all of which seem to have wintered excellently. I bought my bees (one hive) at the end of 1909, and did very well last year, considering what a bad summer it was—about 30lb. yield. Other two hives purchased since. I shall be very glad to see you start the suggested “Hints for the Week” (or month) that you say you intend giving. I much enjoy reading the journal. D. A. B., Reading.

REPLY.—(1) Wait for another fortnight before commencing stimulative feeding. If there is not a sufficient supply of pollen from natural sources, you can supply it. (2) Borage, Chapman honey plant, Wall-flower, *Limnanthes douglas*, Arabis, are all good bee flowers.

[4097] *Moving Skep from Bar-Frame Hive.*—(1) Last spring a stock of bees in a skep was put over a bar-frame hive, in order to see if the bees would transfer themselves. The skep has not been removed. Please tell me, through the BEE JOURNAL, what to do. The bees were flying a fortnight ago, but I am afraid they are short of food. (2) Will driven bees settle in a place a quarter of a mile from the old stand? I have your “Guide Book” and “Practical Note Book.” I should be glad to see an elementary weekly course in B.B.J.—BEGINNER.

REPLY.—(1) If there is no brood in the skep you can take it off on the first warm day, and drive out the bees, if any remain among the combs. If there is brood in the skep, you must wait until the queen goes below, and as soon as she commences to lay in the combs in the frame-hive, put on the excluder zinc, making sure that the queen is below on the combs when you do it. In three weeks' time the bees in the skep can be driven and put in the frame-hive, the skep being taken away. If the bees require food, cut a hole in top of skep and put on a cake of soft candy. (2) Driven bees will readily settle down a quarter of a mile from their old stand.

[4098.] *Strange Behaviour of Bees.*—I am sending a report of, to me, strange happenings in my small apiary of five stocks, during last summer, and would very much like your opinion and advice  
(*Queries continued on page 98.*)

## HOMES OF THE HONEY-BEE.

## THE APIARIES OF OUR READERS.

Mr. E. Watts, whose neatly arranged apiary is illustrated below, may be taken as one of the large class of our readers who delight in a hobby of an instructive as well as an enjoyable nature. He has also interested his three sons in the bees, and it is pleasant to hear of a family who are united in this way in a common pursuit. The practical work these boys have taken part in, such as hive making, painting, etc., as well as the initiation into the wonders of bee-life, should be of inestimable value to them in after life. We hope that in the coming season Mr. Watts and his young assistants will be as

cult with such rough material, but our hives are well made and watertight, and, having calico roofs painted, can stand any weather. This hobby (bee-keeping) has taken up most of our spare time, but it has given us infinite pleasure, and we all love our little friends the bees.

"We have had an abundance of swarms, so that our supers have usually been abandoned, with adverse results so far as surplus is concerned, after the bees had filled several sections. On one occasion three swarms united, and clung to a hive where we had recently hived a swarm. This we secured after repeated failure, and it seemed that most of the bees had



MR. E. WATTS' APIARY, LLOYDCROFT, PARTRIDGE GREEN, SUSSEX.

successful in obtaining surplus, and gaining prizes as they have been in increasing their apiary. A short account of their experiences sent to accompany the illustration says:—

"My apiary was established in 1908 by my three boys and myself at Partridge Green, Sussex. We commenced with a small swarm which we found in one of our meadows, and this gave us bee-fever, and now the apiary has increased to the respectable number of twenty-four colonies. Four of the hives were purchased new, but the others seen in the photograph were made by myself and sons during the winter from 1-in. wood piano packing-cases.

"Needless to say, the work was diffi-

entered the hive and killed off the rightful tenants, for it was choked with thousands of dead bees.

"We have been called in by neighbours on several occasions to help with their bees, and in most cases found them in a bad way; but we value these opportunities for placing colonies in a healthy condition. Our bees came through the winter well last year, and some of our swarms last season were about three gallons measure, the brood-frames in many of the hives being solid with healthy food. My eldest son is only sixteen, but we intend this year to compete with our honey at the shows. We have pleasure in testifying to the value of your paper, from which we gain much useful information."

(Continued from page 96.)

through the BEE JOURNAL. On going into my garden in front of the hives at midday early in June last, I saw some twelve to twenty bees running wildly about on a patch of ground about two yards square, and tumbling off into the path, usually finding their way to the lowest point, where they died. This continued several days. Sections had been put on with one or two partly filled from previous years, probably with a little fermented honey in some of the cells. *Might that be the cause of the strange behaviour?* Shortly afterwards I noticed a very peculiar smell when walking in front of the hives in the evening, and on one occasion, when it was very pronounced, the expert for our district came in, and we traced it to the strongest and best-working stock, and examined it. The expert said it was foul brood (I found what I thought chilled brood through spreading it before, when supering), but there seemed only a few cells that he could say were foul brood. I procured apicure and naphthaline and put them in the hives, and in autumn fed with medicated syrup and later with candy. The season was so bad here that breeding stopped entirely early in the autumn, and, when examining, the expert said there were a few cells he thought foul broody. The stock is still as strong as any, and I propose putting in more apicure and naphthaline, and watching results. Is this the best thing to do, in your opinion? If not, kindly tell me how to proceed.—A TWENTY-FIVE YEAR BEE-KEEPER, Shepton Mallet.

REPLY.—From your description, it appears that the bees were suffering from paralysis. The peculiar smell might have been caused by the flowers upon which the bees were working. There is often a very strong odour when they are working upon such flowers as the gooseberry, currants, &c. Unless it were a very bad case of disease, no smell would be noticed outside the hive, and, as you say only a few cells were affected, this could not be the cause. If bees feed upon fermented food it causes dysentery, and does not make them excited. If you persevere with apicure the disease if present will disappear.

#### PRESS CUTTINGS.

##### BEE-KEEPING IN SOUTH AUSTRALIA.

The bee-keeping industry in South Australia has made rapid progress during recent years, as the farmers and gardeners generally are realising the benefits to be derived from possessing a number of hives and working them in conjunction with their other business. In districts where cultivation has not displaced the

native timber, large apiaries of from 500 to 800 colonies are to be found, and in many instances they constitute the sole occupation of their owner. Considerably over 1,000,000 lb. of honey was produced in 1910, and for the coming season many apiarists predict an exceptionally heavy flow. Although the bulk of the honey is consumed locally, an oversea export trade has been built up, and, in anticipation of an increased production this year, the Trades Commissioner in London has already secured orders from different ports in England, Germany, and Holland, where any surplus from the local and inter-State trade has always found a ready sale.—*Field*.

##### BEES AND POLLINATION OF FRUIT-BLOSSOM.

In the course of investigations made at Oregon Agricultural College into the question of self-sterility of apples, some experiments were made to ascertain the part played by the wind and by bees in pollenising fruit-trees. Small glass slides 1 in. by 3 in. in size, smeared with vaseline, were placed at distances varying from 4 ft. to 30 ft. from large trees in an orchard, and at heights from the ground-level to 9 ft. After an exposure of twenty-four hours the number of pollen-grains found on each slide varied from seven to sixteen. The trees were in the height of their blooming period, and a strong wind was blowing, so that it is concluded that the wind cannot be relied upon to transfer pollen from tree to tree. To confirm the point, the blossoms of a tree were emasculated, and the petals, by which bees are attracted, were removed. During the whole period that the pistils of these blossoms remained receptive only eight bees were seen to visit the tree, while more than twice that number were seen in half an hour on a tree that blossomed profusely 20 ft. away. Out of 1,500 blossoms emasculated only five set fruit, from which it is concluded that fertilisation is almost entirely dependent on bees and other insects.—*Gardeners' Magazine*.

##### OLD ENGLISH RECIPES.

A writer in the *Woman's Supplement* of October 15 remarks on our debt for cookery recipes to the Church. Besides the Church, we also owe some good old recipes to our grandmothers. In an old Welsh farmhouse I came across a Book of Recipes beautifully written in violet ink by the grandmother of the present owner (aged 80).

Among them the following:—

“To Thicken Haire.—Take Dead Bees. Put them in an Oven, when dry, powder,

and mix them up with a little honey, and anoint ye balde place."

It was considerate, at least, to console the ashes of the poor burnt bees with some of their own honey.

For heroic remedies our grandmothers would be hard to beat in our own day, as witness:—

"For a bone that sticks in ye throat.—Take a thimble-ful of Gunpowder, and swallow it Downe: it will dissolve ye Bone."

That they knew how to cook pigeons as well as pheasants, as described in the *Woman's Supplement* recently, is evidenced by this:—

"To Pickle Pigeons.—Take your pigeons and bone them, and lay two in one, and season them with pepper, nutmeg and salt, a little thyme and marjoram and shalot, cut very small and put inside your pigeons and soe them up whole. Make your pickle of old cyder, water and salt and two or three bay leaves. Bake them with Boughted Bread, and use cold with oil and vinegar."

The spelling and punctuation are the ancient lady's own. The recipe is easy for us moderns if we like to try it.—A Correspondent in the *Times Woman's Supplement*, October 29, 1910.

TRADE CATALOGUES RECEIVED.

JAMES LEE AND SON, LTD. (*Head Office and Power Works: Martineau Road, Highbury, London, N. Showroom: 10, Silver Street, Holborn. Bee-farms: Fulbourn, Cambs.*).—This, as usual, is a well-got-up catalogue of 44 pages and contains illustrations and prices of this old-established firm's well-known appliances, a new addition being the "Coronation Hive," which is a marvel of cheapness. Also a special point is made of calico-covered roofs. A reduction is also made in the prices of the famous British-make Weed Foundation. Cardboard section-cases are made a speciality by this firm. The catalogue is post free on application.

E. H. TAYLOR (*Hive Works, Welwyn, Herts.*).—Another old-established firm, the catalogue being quite up to the usual standard, containing 80 pages; it also contains prices of poultry appliances and incubators. This firm now manufacture Weed Foundation. Catalogue post free on application.

R. STEEL AND BRODIE (*Wormit Works, Dundee*).—This is a very neat and well-got-up catalogue of 63 pages, which also contains list of poultry appliances: every appliance necessary for successful bee-keeping is illustrated, and Northern bee-keepers especially will do well to write for it, post free.

MRS. SEADON (*The S. J. Baldwin Apiary, Bromley, Kent. Bee Farms: Brom-*

*ley and Farnborough*).—This is a more up-to-date catalogue than any previously issued; it also contains illustrations and prices of bee-houses, incubators, poultry appliances, photographic dark-rooms, and dog kennels, and consists of 48 pages. Special features are a new design in veils, which is very neat, and an improved steam wax extractor. The catalogue is post free.

A. H. WILKES (*Lichfield Road, Four Oaks, Birmingham*).—This contains many illustrations of this firm's specialities in wire excluders, dividers, feeders, &c.—13 pages. Speciality: Spun aluminium feeders, which prevent all rust; and also a candy-holder, of the same material. Can be had post free.

A. W. GAMAGE (*Holborn, London. Bee Farm: Finchley*).—This catalogue consists principally of illustrations, of which there are a large number in the six pages. The catalogue is post free.

WEATHER REPORT.

BARNWOOD, GLOUCESTER.

February, 1911.

Rainfall, 1.28 in.	Coldest night, 1st 15.1.
Below average, .26 in.	Mean temperature for month, 40.1; .9 of a deg. below average.
Heaviest fall, .19 in. on 18th.	Relative humidity, or percentage of moisture in the air, at 9. a.m. 87.
Rain fell on 13 days.	Number of days with sky completely overcast at 9 a.m., 10; do. cloudless, 2.
Total to date, 2.31 in. as compared with 5.7 in. for the corresponding period of last year.	Percentage of cloud, 68. Percentage of wind force, 25.
Mean maximum temperature, 46.7; 1.7 deg. above average.	Prevailing directions N.E. and S.W.
Warmest day 17th. 57 s	
Mean minimum temperature, 33.6; 3.4 deg. below average.	

F. H. FOWLER (F.R.Met. Soc.).

WEATHER REPORT.

WESTBOURNE, SUSSEX.

February, 1911.

Rainfall, 2.17 in.	Minimum temperature, 25° on 2nd. and 14th.
Above average, .19 in.	Minimum on grass, 20° on 1st. and 2nd.
Heaviest fall, .57 in. on 27th.	Frosty nights, 12
Rain fell on 15 days.	Mean maximum, 45.7.
Sunshine, 83.9 hours.	Mean minimum, 34.6.
Below average, 7.4 hours.	Mean temperature, 40.1.
Brightest day, 26th, 9 hours.	Above average, 1.9.
Sunless days, 10.	Maximum barometer, 30.746 on 1st.
Maximum temperature, 56° on 17th.	Minimum barometer 29.498 on 19th.

L. B. BIRKETT.

## Notices to Correspondents.

*Letters or queries asking for addresses of manufacturers or correspondents, or where appliances can be purchased, or replies giving such information, can only be inserted as advertisements. The space devoted to letters, queries, and replies is meant for the general good of bee-keepers, and not for advertisements. We wish our correspondents to bear in mind that, as it is necessary for us to go to press in advance of the date of issue, queries cannot always be replied to in the issue immediately following the receipt of their communications.*

C. L. N. P. (Shalbourne).—*Improvement in Smoker.*—We can hardly tell without seeing it whether the improvement you have made is worth patenting, but all the points you mention are desirable in a smoker. The first four, however, are already secured in the "Bingham" smoker, and possibly some of those you mention are found in others, but we could only tell by examining your design.

L.A. (Lincoln).—*Feeding Bees.*—(1) Certainly you should feed the bees if they are short of stores, as they will not be able to gather much for some time to come. (2) Candy is best at this time of the year. (3) You can use your two-year old honey for feeding later on, but it would be well to add a small quantity of water to bring it to the consistency of syrup. (4) Overheated honey should not be used for bee-food, for from what you say as to its having become dark, it has probably been burned. (5) If your No. 3 hive is over-burdened with stores, you can take out a comb or two and give them to the hive short of food. (6) We thank you for your appreciation of B.B.J., and are glad to find it has been helpful to you, and that you have been so successful.

J.F.A. (Northam).—*Disinfecting Hives.*—The object of applying disinfectants to hives where there are no bees is to destroy any spores that they may harbour. You will notice that the disinfectants used for this purpose are very much stronger than those used when bees are present in the hives, and would be just as destructive to bees as they are to the spores. Certainly the spores cannot hatch in the woodwork, but they remain dormant for a long time, and bees which are constantly passing over the woodwork may dislodge and carry off some of them, which, on getting into a suitable medium, would germinate. The strong disinfectants, acting on the surface as germicides, destroy these spores, and thus render them harmless. Naphthol beta in syrup makes it an anti-septic, which will act on the bacilli, and destroy or prevent their growth.

T. R. (Dumfries).—*Honey Sample.*—The honey is not pure heather; it is a blend of ling, bell-heather, and wild thyme.

The flavour is very palatable, but it has not the jelly-like consistency characteristic of ling-honey, being thin and somewhat unripe. The wet season considerably affected the secretion of nectar in many districts.

### *Suspected Disease.*

J.B. (Steyning).—Bees suffering from dysentery and "Isle of Wight disease."

R.T.R. (Birmingham).—*Beginning Bee-keeping.*—Our estimate of an outfit is quite correct, and there are many who have made a start on much less than £2. If you will examine some of the leading dealers' catalogues, you will see that there is no discrepancy in the prices we quoted, for you will find complete outfits for £1 2s. 6d., including in addition to the articles mentioned, a book of instructions. If you apply to the Secretary of the B.B.K.A. for a pamphlet on "How to Commence Bee-keeping," you will find that you can get such an outfit for £1 1s. 5d. A swarm of bees purchased in the country usually costs 10s., and if you buy of a dealer, it would cost 15s., so that you can see there is nothing misleading in our article. There is no reason at all why the bees should cost £2, or that you should start with other than the common British bee. Nor is it necessary to have a W.B.C. hive, as this was not mentioned in the article to which you refer.

D. C. D. (Minsterley).—There is no trace of brood in the comb, which appears to be perfectly healthy. The cells contain pollen, some of it dry and mouldy. Your bees may have died of starvation, or the stock may have become queenless. The presence of drones in the hive so late in the season points to the latter. You should have seen to the condition of the queen when you noticed that the stock was not doing well in the summer. It will be quite right to melt up the old combs and use the wax as you suggest.

## Special Prepaid Advertisements. SPECIAL NOTICE.

*The prices of advertisements in "Special Prepaid" Column have been revised, and are now as follows:—*

**Two Words One Penny, minimum Sixpence.**

*Orders for three or more consecutive insertions entitle advertisers to one insertion in "The Bee-keepers' Record" free of charge.*

*Trade advertisements of Bees, Honey, Queens, and Bee goods are not admissible at above rate, but will be inserted at 1d. per word as "Business" Announcements, immediately under the Private Advertisements. Advertisements of Hive-manufacturers can only be inserted at a minimum charge of 3s. per ½ in., or 5s. per inch.*

### PRIVATE ADVERTISEMENTS.

**W**ANTED. STRONG STOCKS in straw skeps; state price, when swarmed, how many.—LARKIN, Woburn Green, Bucks. g 63

**H**EALTHY STOCK OF BEES in good frame hive, 17s. 6d.—15, Seaforth-avenue, New Malden, Surrey. g 64

## Editorial, Notices, &c.

### REVIEWS.

*Profitable Bee-keeping for Small-Holders and Others*, by H. Geary (London: C. Arthur Pearson, Ltd., price 1s. net). This is No. 1 of the "Small-holder" Library, in which we are told that no small-holder should be without a few stocks of bees, and if he neglects to provide these adjuncts to his other forms of enterprise, he is not utilising to the fullest extent the means which lie at his hand. The very foundations of success on small holdings, we are told, rest on the tenant deriving his income from more than one source. This, however, entirely depends upon what he understands about his different ventures and his business ability as an income may be easily turned into a loss, even if the business is only on a small scale. As an elementary introduction to bee-keeping this little book will be found useful to the small-holder, as it will show him what he should do if he wishes to succeed.

*Verwertung des Honigs im Haushalt*, by J. Dennler (published by Hachmeister and Thal, Leipzig, price 20pf., equal to 2½d.). This is a capital little pamphlet, by the Editor of the Alsace-Lorraine Bee Journal, on the value of honey in the household. After briefly alluding to the chemical composition and properties of honey and its food-value, M. Dennler describes its use in the kitchen, cellar and sick room. He gives a number of receipts for making cakes, sweets and drinks, such as mead, honey-wine and beer, as well as vinegar. A chapter is devoted to the use of honey as medicine. This pamphlet is No. 77 of the "Lehrmeister Bibliothek," and will be found useful for popularising the use of honey.

### NOTTS B. K. A.

#### ANNUAL MEETING.

The annual general meeting of the above association was held in the People's Hall, Nottingham, on Saturday, March 4th. Captain J. A. Morrison, M.P., presiding. There was a large attendance of members.

Mr. George Hayes, hon. secretary and treasurer, presented the report and balance-sheet. In his report he stated that of late years they had not been able to speak of the honey harvest in very eulogistic terms, and this applies to the last season, which, although somewhat better than the few preceding years, left much to be desired. However, there was every opportunity for putting bees into winter quarters, well fitted to come out this spring in the best condition. One bright

aspect of the coming season was that owing to the late scarcity, there would be very little honey on the market, and it would be an easy matter to dispose of what they might get, while a better price should be obtained.

The Association commenced the year with 269 members, and 41 others joined during the season. There were, however, numbers of bee-keepers in the county, many of whom would, most probably join the Association, if the advantages were put before them. There was plenty of scope here for those members who were willing to assist the industry and the Association.

He had pleasure in being again able to put before the members a satisfactory balance-sheet, for, although there was a slight loss on the year's working, there was still a small balance to the good, and they would see that the funds had been well administered.

The annual county show was held in connection with the Southwell Horticultural Society, on July 21st, and from almost every point of view it may be considered a very successful one. The entries were more numerous than at any previous show, and what was still more pleasing, most of them were staged.

The following members had entered and passed the B.B.K.A. examination for expert certificates (third-class): W. H. Windle, West Bridgford; John C. Mellars, Norton, Cuckney; Thos. N. Harrison, Carrington.

The report was adopted and ordered to be printed and circulated in the usual way.

Mr. Pugh proposed, and Dr. Elliott seconded, that the thanks of the Association be accorded to all the retiring officers, and that her Grace the Duchess of Portland be re-elected president for the ensuing year; the resolution being carried with applause. Mr. G. Hayes was then re-elected secretary and treasurer; Mr. W. Darrington hon. auditor; and the Committee was re-elected *en bloc*.

A vote of thanks was accorded to Capt. Morrison for presiding, who in replying, complimented the Association on the great amount of good work they were doing, and wished them every success. He hoped that every member might have a good return in the coming season. Of all the minor industries he considered bee-keeping the best, and could recommend it as a good thing for all small-holders to adopt.

Tea was then partaken of by about 120 members and friends, after which the meeting was resumed, with Wm. S. Ellis, Esq., in the chair. The medals, certificates, &c., won at the annual show

were distributed, and the delegates to the B.B.K.A. made their reports on the business done at the meetings.

Mr. Puttergill (Beeston) then read a short paper on "The Return of Exhibits from Shows," and suggested a new form of label to be used for this purpose; so that each exhibit could be easily traced. The label was passed round for examination, and it was finally resolved to refer the matter to Committee.

Mr. Dolman (Keyworth) then brought forward the question of "How are our judges to be trained?" stating how he saw great difficulty in getting to know the qualities, &c., of different honeys other than those produced in their own county, and suggested a little co-operation of members desirous of advancing in this knowledge. This brought forth a lively and interesting discussion.

A vote of thanks was accorded these two gentlemen for their papers.

The usual prize drawing brought to a close the meeting, which was considered by all present to have been the most successful on record.—**GEO. HAYES**, Hon. Sec.

#### MID-KENT B.K.A. ANNUAL MEETING.

The annual meeting of the above association was held at the Carlton Café, Maidstone, on March 8th, the President, G. Marsham, Esq., occupying the chair. A very satisfactory report was presented by the Secretary, the number of members having increased from fifty-six in 1909 to eighty-one in 1910, and new members are still being enrolled. The Expert in his tour called upon fifty-nine members, and examined 247 bar-frame hives and twenty-three skeps. He found that where he had given advice as to treatment of foul brood the previous year, in most cases there was a considerable improvement, but as he covered much new ground, the percentage of diseased stocks had not been reduced. In a discussion which subsequently took place, it was admitted on all sides that legal powers were necessary to prevent the spread and renewing of the disease by the carelessness and neglect of owners of diseased apiaries. It was stated that a notoriously badly diseased apiary of about a dozen stocks and empty hives were to be sold by auction, and would probably be scattered all over the county. The President kindly promised to do all he could to help the Association in their efforts to suppress the disease.

It was also decided to consider the desirability of applying for affiliation with the British Bee-Keepers' Association. Two most interesting and instructive lectures were given by Mr. W. Herroll during the year, and a

successful show was held in the autumn. The balance-sheet showed a deficit of 35s., but this is covered by the value of appliances which belong to the Association.  
**JOHN C. ROBERTS**, Hon. Sec.

#### AMONG THE BEES.

##### AN ABNORMAL WINTER.

*By D. M. Macdonald, Banff.*

So much of the past, or passing, winter has been so open and mild that matters are pretty certain to be abnormal in the hive interior. Many enjoyed seeing their bees so very much alive on many occasions, but did it never occur to such that this unseasonable activity must have been carried on at a sacrifice? Stores have been heavily drawn upon, and may be running out already. Bees age more from work than from length of days, therefore more old bees are in evidence. One might congratulate oneself that young bees may take their place. Yes, but this, happening too early, tells adversely in three ways. The queen has a strain put on her untimely, the early breeding is a heavy tax on stores, and the pollen presciently gathered last autumn may run down prematurely, thus stopping all breeding. Further, the heavy tax put on the bees by early brood rearing tells upon their vitality. To rear young bees, water is indispensable; therefore visiting water sources wears out the carriers prematurely. Let a cold snap come, and all the heavy strain imposed may end in disaster. Brood may be chilled, the larvæ may die for want of pollen, and the undue excitement of the adults may result in dysentery. The true winter is a season of repose; too open a winter rouses bees untimely. In general, a severe winter brings bees out stronger in numbers and fitter for work than an abnormal one. Therefore look well to the bees for some weeks in the near future.

*Carbolic Acid.*—The use of this intimidant or bee-quietener should be accompanied with great care and circumspection. Any taint of carbolic about honey should make it unsaleable. Yet at times the cloths are so saturated with the solution that they can scarcely fail to do harm. Moreover, when the dose is too strong it works for evil and not good, as it rouses instead of stilling the bees. At a county honey show during the last season a leading prize-taker forwarded a sample bottle in competition smelling so strongly of carbolic acid that it would have nauseated not only a lover of good honey, but anyone not at all supersensitive in either taste or smell. If using the carbolic cloth, make it up as follows: Obtain a graduated ounce bottle from



your doctor or druggist, pour in loz. of Calvert's No. 5 carbolic acid and 2oz. of water. Provide the bottle with a tight-fitting cork, but, before inserting it, cut a small groove along its length so that when pressed home it will allow the liquid to be shaken on the cloth in small drops. The cloth should not be saturated, but sprinkled until slightly damp. Roll it up and keep it in a small tin box, when it can be carried in the vest pocket until required. In this form it comes in very handy if one is away from home and is called on to do some amateur expert work with bees; but, when taking section honey off hives, I would not care to use any other pacifier than smoke. Personally, I would vote for smoke every time.

*Division Boards.*—Hitherto I have used the word dummy to describe any board used inside the hive to contract the internal space, but in future I will distinguish between loose substitutes for frames and a board touching the sides of the hive. The first will be designated a dummy and the latter a division board. One is always learning. I learned this when sitting at the feet of Gamaliel! The word dummy exactly describes what it is inserted for. The body box, for one or other of several reasons, is contracted by withdrawing one, two, or three frames, and their place is taken by a dummy frame, a solid piece of wood instead of the comb, but measuring 14in. by 8½in., exactly the dimensions of a standard frame. If it is deemed advisable, however, to lessen the inner area, one or more of these dummies are left out and the division board pressed forward to contract the internal dimensions by that space. Both terms are appropriate.

*Cone Escapes.*—I think at least one of these should be fixed on the roof of every hive. They are better than simple pieces of perforated zinc as ventilators, and they exclude drifting wind, sleet, or snow more perfectly. When manipulating hives, if bees are left in the open space between the inner and outer cases, or about the quilts, they are not kept prisoners until death follows, but find a ready exit at these convenient outlets. At times too, early in the season cones serve as super clearers, and racks of sections may be cleared of bees by their aid as quickly and peaceably as by any other means.

*Painting Hives.*—I am not myself a good painter, but there is one consolation (or regret) frequently in my mind—judging by what I see on my travels, many bee-keepers are worse. It is advisable to paint all hives every few years. They look better, resist wet more effectively, and they last longer when painted. My hives trouble me in two ways. In one set after some time the paint comes off

in a powder, often soiling my clothes. In another lot the paint peels off in small or large flakes, leaving an irregular, blotched surface. A painter tells me that in both cases badly made-up paint is the cause, but from different reasons. In the first case the paint has been made up of pure lead and oil only, and has no solidity about it, and lasts so short a time that it has to be frequently renewed, but when being repainted the task is a light one, as the surface, when rubbed down, permits of the new coat being administered easily and smoothly. In the other case the oil and lead has had zinc added, and this has given it a harder and more durable surface. But in course of time this coating begins to peel off and cause an irregular, blotched face. When the hive is being repainted the result is far from pleasing, and on a roof it is a fertile source of dampness. It seems we amateurs don't half mix our paints, and that we mix them up in the wrong proportion. We also coat it on irregularly, give a second coat too soon after the first, and frequently apply it with the wood too damp.

---

## NECTAR-PRODUCING PLANTS AND THEIR POLLEN.

By Geo. Hayes, Beeston, Notts.

(Continued from Page 92.)

### No. 5. THE PRIMROSE (*Primula vulgaris*). NAT. ORD., *Primulacæ*.

This is one of the plants which appears to need no description, for there is none better known nor more widely appreciated. The graceful form of the widely expanded blossoms, the delicacy of their colour and fragrance, their profusion, and the time of the year when they are found are all features that tend to endear them to the lovers of plants. The colour of the flower is peculiarly its own; the delicate sulphur tint of the petal and clear deep yellow throat are always greatly admired.

The generic name is derived from the Latin *primus*, meaning first, in reference to its early appearance; *vulgaris* refers us to the fact that it may be found, as we say, almost anywhere.

Where it grows it is generally found in profusion. Woods, banks, hedgesides, and meadows are its favourite spots, and there is no sight more entrancing than a long hedgerow or coppice starred over with its thousands of delicate blossoms, reflecting back to you the light from the sun.

April and May are the best months in which to find it flowering; though I have a number of transported roots in my garden from which I could gather just a

small bunch as I write, in the month of November, and I shall be able to find a few all through the winter and up to April, the proper time for blooming.

I am unable to say whether bees visit these flowers much where they are plentiful, and, unfortunately, I have no such place near my home; but, judging from the attention given to those in my garden, I should say they will be very helpful to our bees. The description is more particularly given on account of the pollen.

The cowslip, oxslip, and greenhouse

stamens, and the other just the reverse.

The pollen from each of these two varieties is alike in shape, but differs in size. The form is a corrugated or fluted cylinder flattened at each end, l, A and c. The corrugations are eight in number, as seen at D and E. In the long style "A" the measurement is,  $\frac{3}{1000}$  by  $\frac{1}{1000}$  while in the short style. "B," it is  $\frac{1\frac{1}{2}}{1000}$  by  $\frac{1\frac{1}{2}}{1000}$ . The colour, when dry, is of a pale primrose, and when seen under the microscope in honey is very pale in colour, which makes it a difficult subject to photograph.

1. Dry.

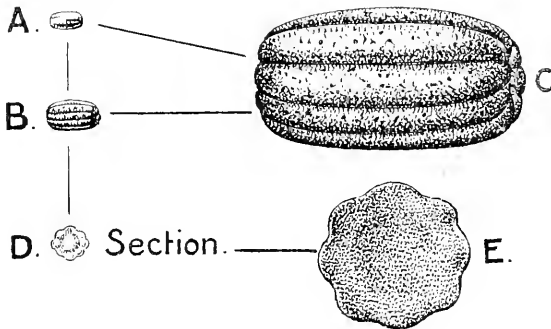

2. From Honey.

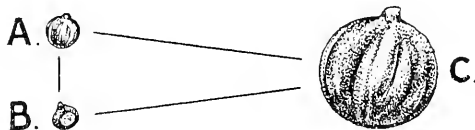

POLLEN OF PRIMROSE.

The magnifications in the first instance are about 150 diameters.

primulas, &c., are other familiar plants of the same genus. In the primrose the calyx is tubular with five points. The corolla is regular shaped like a salver with five deeply notched lobes, ending in a straight tube. The stamens are five in number and inserted in the tube. The style is filiform with capitate stigma. The peculiarity of this genus is that there are really two kinds of flower in each species, which is not perceptible except upon close observation, the difference being in the style and stamens—one variety having a long style and short

This pollen, after being in honey for some time, assumes a spherical form, and sometimes grows a process, but retains its corrugation, in a less marked degree, as seen at 2, A, B, and c.

(To be continued.)

In the morning when thou risest unwillingly, let these thoughts be present—I am rising to the work of a human being. Dost thou not see the little plants, the little birds, the ants, the spider, the bees working together, to put in order their several parts of the universe? and art thou unwilling to do the work of a human being, and dost thou not make haste to do that which is according to thy nature?—*Marcus Aurelius.*

## Correspondence.

*The Editor does not hold himself responsible for the opinions expressed by correspondents. No notice will be taken of anonymous communications, and correspondents are requested to write on one side of the paper only and give their real names and addresses, not necessarily for publication, but as a guarantee of good faith. Illustrations should be drawn on separate pieces of paper. We do not undertake to return rejected communications.*

### NOTES BY THE WAY.

#### ISLE OF WIGHT DISEASE.

[8110.] The spread of the so-called "Isle of Wight disease" at such an alarming rate must be my excuse for inflicting on readers my "notes" again this week. I am pleased to notice on the agenda of the British Bee-Keepers' Association annual meeting, on 16th inst., that Dr. W. Malden will take as his subject the most serious of all bee troubles at the present time. I hope that Dr. Malden will be able to report progress since his last report, and that he has been able to discover the cause of the disease.

I trust that the suggestion made in my "Notes" (page 54) last month may not have escaped his notice, and that he has tested for poisons usually sprayed on fields, orchard trees, weeds, mildew, &c. I notice in Saturday's (11th inst.) copy of the *Hampshire Observer*, kindly sent me by a bee-keeper who has lost thirty stocks of bees another bee-keeper who had over eighty stocks has only one left, and several others have lost all their bees at Nether Wallop, nr. Winchester, Hants. It is suggested that the "Isle of Wight disease" was started with charlock-spraying in the Isle of Wight (can our bee-keeping friends in the island give any information in support of this theory), as it is stated that the disease has broken out since the spraying of charlock has been practised at Nether Wallop. The adult bees are the first to succumb; the first symptoms are the bees crawling on the ground unable to fly. What of the brood? Has disease been found here also? Or does the brood perish from chill, because the nurse bees are all dead. Again, if the suggestion is true that sprayed poison is the cause, I should expect to find the brood fed on the incoming poisoned nectar poisoned also, or at least, some part of the brood dead or dying from the same cause. If the poison affects only the wing-power of the bees it may not affect the young bees in the cells until they are hatched and ready to take their first flight, that is, if there are enough nurse bees left to keep up the necessary warmth for their development.

A bee-keeping friend writes that he has lost during the autumn and winter some thirty out of forty stocks; these have died in their hives principally, only a few on the ground or alighting-boards; some in clusters, and some in heaps on the floor of their hives, and mostly, he says, with plenty of sealed syrup food, which he fed during late summer and early autumn. Here we have fairly strong stocks dying, clustered in usual winter fashion with food in abundance around them. How can this be accounted for? Can this be another form of the "Isle of Wight disease"? Or did the bees perish from cold? These last mentioned losses are the property of a bee-keeper of several years' standing, who is both a careful and painstaking man; a member of our Berks Association, and a successful exhibitor at our local shows.—W. WOODLEY, Beedon, Newbury.

### ROSS-SHIRE NOTES.

#### DUAL-QUEEN SYSTEMS.

[8111.] The current month so far has at times been decidedly wintry, but a sunny day last week permitted an inside inspection of hives. All full colonies and nuclei alike were found alive and with abundant stores. No manipulating was done, the sight of pollen being carried in and downy young bees sporting at the entrance being sufficient to show that all is well with the queen.

The problem of successfully working two or more queens in a hive has a particular fascination for modern bee-keepers. The "Wells" hive is known of all, while here in the North the "Reid" plural-queen hive is being met with everywhere. Over in America they are on the same track, many beemen feeling sure that the way to increased honey production lies along the line of dual-queen hives. The "Ferris" method makes use of a twelve-frame hive, in which two six-frame colonies are wintered with a dummy between. In early summer a second brood box of drawn combs similarly divided is placed on top, thus giving each queen a twelve-frame brood chamber. In this way twenty or more frames are filled with brood previous to the honey flow. One queen is then removed and the other left to head the combined colonies, now contracted to a single brood chamber.

The surplus brood is tiered up in the section supers, and as it hatches out maintains the colony's strength. This scheme was devised to suit a district where the honey flow, although heavy, lasts but a few days, and a large surplus is obtainable only from such powerful colonies as the dual-queen system ensures.

Another means of attaining the same end is exemplified in the "Hand" method

of working a plurality of queens in sectional brood chambers, each separated by excluder. These sections are about the same depth as our shallow frame supers. Two stocks each in a single section are wintered in one hive with a board between, a temporary entrance being arranged for the upper colony. In spring the board is replaced by excluder zinc, the upper exit closed and both stocks work together from one entrance up to the eve of the honey flow. The after management can be varied to suit the locality or season. The combined colonies may be supered as one, or if swarming is feared the entire working force with one queen is shaken on to foundation just as the honey comes in. In this case the swarmed hive, a mass of brood and immature bees, is worked as an auxiliary to the supered colony and both are finally united for the late gathering.—J. M. Ellis, Ussie Valley, N.B.

#### FIGHTING FOUL BROOD

[8112.] A bee-keeper, living near here, whose acquaintance I made (who kept about twenty stocks of bees), told me that he did very well with them before my time, but latterly had been very unsuccessful, although others living in the same district had done well. He spoke to me of his bad luck—no swarms, no honey, stocks dying, &c., and I asked him if he had examined the bees to see if they were diseased. "No," he replied, "I don't believe in manipulations, as that is the way to produce foul brood." I asked if he would let me look at them, and he agreed, but when I went I was only allowed to look at the *outside* of the hives. This man died and a son took over the house and the bees, the son complained of the bees doing badly, and on being asked if they had foul brood, replied in disgust that he was sure his bees would not have that. I, as secretary of an association, wanted to examine these bees, as numbers of members in the district could not keep their hives clean, do what they might. At last a friend of mine obtained permission to look into the hives. *Result*.—No. 1 was found very badly diseased, and No. 2 rotten with disease; both with about a pint of bees in them which the owner intended feeding up for the winter. The bees were dead in most of the remaining hives, but the hives had not been cleaned and were infested with wax-moth, and the entrances had been left open, but we could do nothing with them without the owner's consent, which he would not give. Now this man is going to emigrate, and his bees and hives are to be sold by auction next April. What can we do to save the non-offending beemen in the neighbourhoods

to which they will go. The empty hives will be as bad as those with a few bees in them. Our association is not rich enough to buy and destroy them. Why should a county association, which has worked hard to clear its county of disease, have these abominations planted down in its centre, and then have all the cleansing work to do over again? Would not our friends who are afraid of the "compulsory" bogey wish that it were in our power to legally prevent this man from selling these hives, if there was a chance of their having them placed within easy reach of their own bees? I might mention, in conclusion, that the friend referred to had been opposed to Foul Brood Legislation, but now he is strongly in favour of it. He lives in the neighbourhood and has been a sufferer.—JNO. C. ROBERTS, Maidstone.

#### SPRAYING CHARLOCK.

[8113.] It is a glorious day (this 9th of March), and looking north I see the hills in Berkshire, and in the south the distant hills in the Isle of Wight, Winchester lying snugly in the valley below. It is but five years ago that a picture of my apiary appeared in the *BEE JOURNAL*, but what a difference in appearance there is now! All bee-men on the chalk hills of Hampshire around here tell the same tale of woe—"all dead." We are smitten with that deadly "Isle of Wight disease," while only one slight case of foul brood can be heard of. There are over 100 frame hives empty in about a three-mile radius. In the towns the back-garden bee-keepers are free from it. Now why is this? The last three summers have been wet and cold, and the charlock has bloomed more freely than ever I have seen it before; with the result that spraying has been carried on more extensively than ever. Last August there was a tremendous crop of charlock, so I put on bottles of hot syrup to try to get the bees to take it down; instead of getting nectar from the poisoned plants, but not a drop would they take. We have had a crushing defeat, but I am more determined than ever. The only remedy that I think of is to crowd the bees on three or four frames, giving them no room in which to store surplus, and let them hang in clusters on the flight-board, as we used to see them in the days of the old straw skep. This seems to be the only way we can keep our bees alive; but never more shall we get those lovely sections we used to take off until this spraying is stopped. It is a crime to put down poisoned meat and grain, but not copper sulphate. This is a thousand times worse

than foul brood. I have lost over thirty stocks in two years.—W. DREW, Saint Cross, Winchester.

CAPPINGS OF COMB.

BY L. S. CRAWSHAW, MORTON, MALTON, YORKS.

*Winter Brood Chamber* (page 39).—It must not be forgotten, when comparing the number of frames, that the Langstroth comb area is one-third more than our own. This lends additional point to the argument in favour of ten frames. For my own part, I see little use in reduction, except it be in thin single-walled hives. But who uses these? Of course, if combs are wanted for driven bees, the question is complicated. But whatever may be said, combs are not readily and truly interchangeable. Given the opportunity, bees form a winter nest in their own combs. Whilst, if each colony retains its set of combs, the risk of spreading unsuspected disease is lessened—three very excellent reasons for keeping the combs where they belong. I admit that I have never been in a position to carry out the teaching in its entirety, but am convinced that it is sound, even at the expense of an occasional mouldy comb.

*Parthenogenesis in Greenfly* (page 45).—I cannot think that Mr. G. G. Desmond has either read my note on page 16 carefully, or that he is accustomed to the strict use of language which is essential when dealing with the sciences. Otherwise he would have noted my familiarity with the phenomena he details, and would have appreciated my criticism of "D. M. M.'s" wording. "D. M. M." is, no doubt, familiar with aphidian life histories, and it was only because the phrasing appeared misleading that I commented upon his note. Mr. Bullamore, to whom I am correspondingly obliged, has, however, on page 75, taken up the cudgels for me far more effectively than I could have done, and with such clear detailing of the point at issue, that he has by this time, I trust, made the contention perfectly clear to Mr. Desmond. In this connection I have had a most interesting letter from "Humble Bee," who sends me some greenfly which have survived the winter upon an arum lily in a greenhouse sufficiently cool for ice to form there. As these are apteroces, is it possible that they are a parthenogenetic generation, or may they be hatchlings from eggs which have "hibernated" for a very short period?

*Southern Snatches* (page 54).—Differences evidently exist between South African bees and our own. Ours will hardly touch super foundation after the flow is over, let alone attempt to convert it. My own troubles with conversion have al-

ways been the other way, viz., from worker to drone. Possibly the S.A. bee is slightly smaller, which may account for its rejection of drone base, except under pressure. A slight difference of this kind would also facilitate the travel of workers through excluder zinc. The mere presence of excluder will often deter a queen (as will the wood of sections), even though she may be able to pass through its "meshes." Mr. Martin is clearly a convert to the use of worker base in supers. A wise decision, as the drawbacks of the drone base outweigh its advantages.

*"I.O.W. Disease"* (page 55).—I wish it were possible to believe that Bonner's account referred to this disease, as then we might face the future more complacently, attacks in the past having failed to extirpate the industry. I fear, however, that the consolation is denied to us, and Mr. Bullamore no doubt coupled the account, as a satire upon those who too readily diagnose any case of dysentery as the fell disease. Some of these empiricists are, no doubt, those who at other times saw evidences of foul brood in stored pollen!

*Hives, Nuclei and Driven Bees* (page 56).—Does Mr. Harris describe a floor-board with the usual-sized entrance, several inches back from the front of hive—or is the entrance supposed to be bigger by the corresponding retreat of the alighting slope? In the latter case, are the entrance slides deeper, and the sides of the slope closed by permanent blocks? Or are they of triangular section, and held between hive and floor?

This is a splendid account of an April nucleus. Such a nucleus is far better value than a May swarm. But the price is about the same. A five frame nucleus with a young queen, and an early top-swarm with an old queen, can each be bought for about fifteen shillings. It looks as if swarms are overpriced.

If I might add a proviso, I should disagree with Mr. Harris's verdict upon comparison of 2½lb. of bees in September and 5lb. of bees in October. Of course, October bees should not be expected to seal stores, but should be put upon sealed combs, warmed up and arranged in winter fashion. Whilst if 2½lb. of bees are given much comb filling and sealing to do, let alone comb-building, they will be in poor shape for winter.

*More Winter* (page 63).—Several writers have threatened us with trouble on the strength of Candlemas weather, but a month has elapsed since their prophecies, and the sun is gaining power daily. So much so that everything is on the move and bursting into leaf, birds have begun nesting, and bees are breed-

ing in earnest. If half the winter is still to come we are in parlous case. Yesterday, Sunday, and a fair day, birds hurrying southwards warned us to be ready for bad weather. So all was made snug, garden peas and sweet peas being quickly protected. To-day we see the snow with equanimity, but hope that the proverb will prove to be wrong, and that it is only a parting shake of the white bear's paw.

*The Shunt System* (page 66).—This is being discussed in America as a new thing, under the title of the Hand's Control device. I first made its acquaintance in a now defunct, but not uninteresting, publication called "Bees," published by W. P. Geary. I purchased from him a patent hive. His system was, I found later, forestalled by the Langdon device, which hailed from America, and which writers there appear to have forgotten or overlooked. Good results can be obtained in methodical hands with stocks of medium strength, and most stocks seem to belong to this class. Such strong stocks as described by "J. M. E." would, no doubt, be better "on their own." But, whatever the system, trouble results from a paucity of supers, and the mistake appears to have been in limiting the number to six when more were evidently required. Possibly the supers remained too long upon one of the allied colonies. The conclusion is that the Peter and Paul system is unsuitable for the Well's hive, and needs separate hives which can be tiered up to any extent.

#### THE SPREAD OF BEE DISEASE.

SIR,—Noticing in last week's issue of the B.B.J. that the Berkshire bee-keepers were going to take action with regard to the "Isle of Wight Disease," it might be of interest to your readers if you published the enclosed from the *Hants Chronicle*. I might add that our member (Capt. Baring) is not quite satisfied and is going to press the matter further, at the request of the club.—H. J. DAY, Hon. Sec., Winchester and District Smallholders' Club.

#### BEE DISEASE IN HAMPSHIRE.

We are sorry to hear that what is known as the "Isle of Wight Bee Disease" has obtained a serious hold in many parts not only of Hampshire but of the country generally, and is causing considerable uneasiness among bee-keepers. In the neighbourhood of Winchester there have been cases, and the matter has been vigorously taken up by the Winchester and District Smallholders' Club, of which Mr. H. J. Day, of Lower Stockbridge Road, is Hon. Secretary. Mr. Day has addressed the following letter to *The Smallholder*, in which he clearly sets out his views:—

SIR.—As the "Isle of Wight Bee Disease" is on the increase in this country, especially round Hampshire, I should be obliged if you will insert this letter as soon as possible, so that other Smallholder Clubs can assist us in our movement by taking action similar to ours.

We are getting signatures all around here, from bee-keepers and others interested in the district, to a petition to our member for West Hants, asking them to use their influence with regard to securing legislation at the earliest possible opportunity to try and stamp out this scourge among our little brown benefactors.

I have heard this week of one man near here who has lost thirty hives this winter, and to-day I was told of another; but I can't at present vouch for the accuracy of this.

What we want is proper Government inspectors (as for swine fever and goose-berry mildew) in all districts with full powers to condemn and destroy by burning all hives and remaining stock, with compensation, if we can get it, and to bar that person from keeping bees on the same ground again for two years.

I should, by this letter, like to advise all my smallholder friends not to buy any bees or hives or appliances from a district where it is known that the disease exists without first ascertaining from the Smallholder Club hon. secretary in that district whether the seller has now or has had previously bee disease.

Also, do not buy second-hand hives, as there is nothing to stop a person from cleaning out a hive or two, and offering them at a cheap price—the unsuspecting buyer of the hive would be also buying disease.

If you put this letter in your next issue, then other smallholder clubs will be able to help us in our agitation by taking similar action. By that means we may stamp out bee disease, as swine fever has been nearly stamped out. Thanking you in anticipation, I remain, yours truly,  
HENRY JAMES DAY.

Winchester and District Smallholders' Club, Stockbridge Road, Winchester.

The Editor publishes the following note:—

"Mr. Day, Hon. Secretary for Winchester, has sent me a very important letter on the subject of the dreaded 'Isle of Wight Disease.' It is the usual way in this country that we first allow an evil to take a firm root and then set about curing it with tuppenny-ha'penny remedies. In this case Mr. Day suggests a better method. He wants this dread disease tackled now, before it has spread over the country; and wants it tackled in such a vigorous manner that it will be stamped out as effectively

as 'foul brood,' for instance, has been stamped out in New Zealand. I appeal to every reader in the South of England to help Mr. Day in his most praiseworthy effort."

Mr. Day has gone further and has enlisted the active interest of the Hon. Member for Winchester (Captain Guy Baring), who has brought the matter forward in Parliament.

The following questions and answers are from the Parliamentary Paper of March 2nd:—

Captain Baring asked the Parliamentary Secretary to the Board of Agriculture whether his attention had been drawn to a disease known as the "Isle of Wight Bee Disease," which was causing considerable loss to bee-keepers in certain parts of Hampshire; and, if so, what steps he proposes to take to stamp out this disease?

Captain Clay asked the Parliamentary Secretary to the Board of Agriculture whether he is aware that an outbreak of "Isle of Wight Bee Disease" has occurred in West Kent; when will the Board of Agriculture issue their report on the subject; and, pending the issue of such report, what steps do the Board propose to take to check the further development of this epidemic?

Sir E. Strachey: May I be allowed to reply at the same time to the question to be asked by the hon. gentleman, the Member for Tonbridge. The Board are well aware of the existence of this disease, and it has been under investigation for some years, but no remedy for it has yet been discovered.

In the Parliamentary oral answers for the 6th March the following appeared:—

Captain Baring asked what was the last occasion on which a representative of the Board made an investigation into an actual outbreak of the "Isle of Wight Bee Disease"; and whether any recommendation has followed by leaflet or otherwise.

Sir E. Strachey: An investigation by one of the foremost English pathologists was made into this disease last autumn. The result was negative, and no recommendations could therefore be issued.

Capt. Baring: Is the hon. gentleman prepared to make further investigation into this disease, which is rampant in my district?

Sir E. Strachey: If the hon. gentleman thinks it will have any good effect I will consider the matter.

Mr. C. Bathurst: Is there any scientific knowledge at the Board of Agriculture with regard to this disease?

Sir E. Strachey: I have just informed the hon. member that we have made enquiries.

Mr. Douglas Hall: Is there any reason why the Isle of Wight should be mentioned?

Sir E. Strachey: Reference was made to the Isle of Wight because the disease originated there.

Mr. Douglas Hall: Has the hon. gentleman found authority for that?

Hampshire is a noted honey-producing county, and we trust bee-keepers who have suffered through the disease, or can give information with reference to others, will put themselves into communication with Mr. Day. From the *British Bee Journal* we find that similar steps are being taken by the Windsor Branch of the Berkshire Bee-keepers' Association. As showing the importance of the Bee industry it may be mentioned that in addition to our own supply the quantity of honey imported into England last year was £45,844.

---

## Queries and Replies.

---

[4099.] *Moving Bees*.—I should be much obliged to you if you would kindly give me a little information in your next issue of B.B.J. on the following: I am about to purchase a stock of "Blacks," in the hive they have wintered in—(1) Should I run any risk of losing many bees, as the distance from the seller to their new home will only be about one mile? (2) What would be the best method of carriage? If two strong pieces of wood were fastened under the floor-board, with the ends projecting for handles, could it be carried easily? (3) Is it necessary to put the bees into a new clean hive?—I started bee-keeping last April with a stock of hybrids, but, sorry to say, they were robbed out, so I lost them. I am starting in a different place this time and shall take more care to guard against robbing.—Thanking you for your valuable hints given from time to time in the B.B.J.—E. B., Bromwich.

REPLY.—(1) No risk whatever, especially if the bees have, through bad weather, not been able to fly out for about a week. Move at night, to prevent excitement and possible robbing. (2) Yes. (3) It is advisable to spring-clean the hive, and this is done more easily if the bees are changed into a hive previously cleaned and disinfected.

[4100.] *Painting Hives*.—I have been a constant reader of the B.B.J. since I first took an interest in Bees, two years ago, and find it a great help to me. I should be glad of your advice on the following matters: (1) What distance should the hives be placed, one from the other? (2) Does each hive require to be painted a separate colour, or may they all be painted white? (3) As I make my own candy, I should like to know where I can obtain

pea-meal, and what quantity would be required for 10lb. of sugar, to make a good candy for spring feeding.—X. Y. Z., Carnarvonshire.

REPLY.—(1) About twelve feet apart, if possible, but not less than six feet. (2) You can paint them white, as bees locate the position and not the hive. Stone colour, with a white roof, is best, as it does not show the dirt so readily. (3.) Symington's pea-flower, which can be obtained at any grocers. Quantity required: 1½lb. to 10lb. sugar.

[4101.] *Spring-cleaning Hives.*—Will you kindly tell me, through your columns, if it is necessary to transfer bees to clean hives each year: and if so, when is the best time to do this.—A BEGINNER, Oswestry.

REPLY.—It is not necessary to transfer bees to fresh hives each year: at the same time, the hives must be cleaned out at the beginning of the season, and if you have a clean empty one it makes the work much easier if they are transferred; the one previously occupied can then be well cleaned and washed with disinfectant, ready to transfer the next one, and so on throughout the apiary. The operations should be carried out on fine days in April.

## Notices to Correspondents.

NEW READER (Barnstaple).—*Queen Rearing.*—(1) If you will read the instructions in "Guide Book" carefully, you will see that the young queens do not take their fertilising flight from the compartment in which the cells are raised: in fact there is no provision for this. The queen cells are either placed in nursery cages (fig. 94) or introduced into nuclei. The next chapter (page 132) will give you full instructions. (2) Queens do not usually sting, and if one is caught in the way described on page 136, there is no possibility of her doing so. (3) If you write to the Secretary of the B.B.K.A., 23, Bedford Street, Strand, London, you will get printed instructions of examinations for third-class certificates, which will give you all the information you require.

E. J. (Portbury).—*Making Candy.*—The candy is just a trifle too hard. It has evidently been overboiled.

J. B. (Steyning).—*Parasite on Bee.*—The bees were crushed flat in post, and it was impossible to examine the insects, but from your description we should say they were those of *Braula caca* or blind louse, a parasite which sometimes infests the queen and worker bees.

F. L. (Herts).—*Candy-making.*—The candy has been boiled too much. You can add water and make it into syrup for feeding purposes.

B. J. (Sydenham).—*Telling the Bees.*—It is merely a superstition. The death of the owner would not, of course, affect bees, any more than it would other live stock.

### *Suspected Disease.*

HUMBLE BEE (Yorks).—Bees have died of dysentery. The fouled combs should not be given to swarms even if syringed, and in view of the prevalence of "Isle of Wight disease," we would advise you to destroy them, and thoroughly clean and disinfect hive before using again.

E. T. R. (Aberayron).—1.—Dysentery (see reply to "Humble Bee"). 2.—If the syrup is good you can use it for stimulating, beginning towards the end of March. 3.—Clean and disinfect hive, and supply with new frames fitted with comb foundation. It is best to start with an early swarm in May (see page 145 of "Guide Book").

BOLDEA (Lancs).—Bees contained undigested pollen and numerous bacteria, such as are found in decomposing bees. Your safest plan is to destroy combs, frames, and quilts, and disinfect hive before you use it again, and start with a swarm.

E. P. (Malvern).—Nos. 2 and 8 have been suffering from dysentery, and apparently "Isle of Wight disease." Nos. 6 and 7 were dry, and too long dead to diagnose. The honey should not be given to other bees, but if extracted and boiled, could be used for household purposes. The combs, frames, and quilts should be burned, and hives disinfected.

### *Honey Samples.*

B. B. (Ramsgate).—Neither sample is first-class honey, and No. 1 shows signs of fermentation.

X. Y. Z. (Taunton).—The sample of honey is not a good one and it is fermenting. We should not care to sell it with or without a label.

## Special Prepaid Advertisements.

LARGE MEADOWS RIPENER with lift and strainer, used once, 10/-; also Abbott's extractor, secondhand, good order, 10/-.—F. E. MATTHEWS, Cotton Apiary, Northfield, Birmingham.

COUNTRY STORES wanted, making good living; good bee district preferred.—Particulars to LANCASHIRE, "B.B.J." Office. g 87

FOR SALE, 6 Hives and Stocks, bees healthy; Hives Lee's improved pattern, perfect condition, a bargain.—Particulars, apply H. J. BURGESS, Wheathampstead Road, Harpenden, Herts. g 82

WANTED, Honey in bulk, medium colour preferred.—Particulars and price to JUDGE, Hawley, Dartford. g 83

FOR SALE, 5 or 6 healthy stocks of Bees, in nearly new Sandringham or Buncefield Hives, 35s. each.—21 Maury Road, Stoke Newington, N. g 84



## Editorial, Notices, &c.

### ANNUAL MEETING OF THE B.B.K.A.

It was an exceptionally satisfactory meeting over which the chairman presided on March 16; and if anyone has any idea that bee-keepers are losing interest, and are no longer as enthusiastic as they used to be, such a person would have been undeceived had he attended this meeting. It was one of the largest held for many years, and although there was an attempt to introduce a few discordant notes, the attempt signally failed and the interrupters were "hoist with their own petard."

It is some years since the Council have been able to present such a satisfactory report, for not only was there a large increase in membership, but also a considerable increase in the income of the Association. Owing to the illness of their late secretary and the neglect of his brother to deliver up the books, or do the work which he had undertaken to do, the Council had found a number of accounts for 1909 unpaid, and in consequence of the persistent neglect of the affiliated associations their relations with the parent association were not as cordial as they should have been. The Council thoroughly realised the position, manfully faced the difficulties, and set to work to remedy the trouble; and, as the report shows, have succeeded in re-establishing the friendly relations which should never have been interrupted; so that there is now every hope that when the re-organisation scheme is again considered a mutually satisfactory conclusion may be reached, which will result in a benefit to the industry and in further strengthening the position of the central body. The result of these friendly relations is seen by the increase in the number of affiliated associations which, at the end of last year, was thirty-four, instead of twenty-eight in 1909. Associations in the South African Colonies are also now seeking affiliation with the British.

With the exception of the loss of nine out of the ten colonies at the Association's apiary from "Isle of Wight disease," the report showed satisfactory progress in every other direction, and the members expressed their approval in an unmistakable manner by their constant applause. It was a pity that there was a jarring note, but this brought out more strongly the resentment of the meeting at the unreasonableness of the criticisms. One individual had a grievance, in that, not being a subscriber he was not allowed to bring forward a motion of which he had given notice. He had been allowed, through courtesy, to speak at former meetings, and this he seemed to look upon as giving him a prescriptive right to inter-

fere at a meeting of members, although not a member of the Association himself. The meeting naturally resented such interference. Not finding anything in the report he could find fault with, another criticised the amount spent on postage and petty expenses, without giving any credit for the increased amount of work that had been done. It was notorious that the County Associations had been neglected, even the secretaries and delegates not receiving notices of meetings. This has all been changed, and during the year, with a larger number of affiliated associations, the immense increase of correspondence. It was pointed out by one of the County Secretaries that now they got replies to their letters, whereas formerly no attention was paid to them. The most frivolous criticism was that respecting the apiary account, brought forward, strange to say, by a member of the Council, who was also a member of the Finance Committee and had approved of the accounts. As a member of this Committee it was his business to know the details of the items making up the account, and it is evident that he thought to bring discredit on the Council by springing this "tit-bit" on the meeting. Apart from the bad form of showing such discourtesy to his colleagues, he forgot that he was discrediting himself, and as a result of his temerity, when the ballot was taken for the election of the new Council, he was the only one who lost his seat; the members in this unmistakable manner expressing their feeling that one so ignorant of the work was not a fit and proper person to represent them. The County Associations represented by these delegates have certainly no reason to be proud of them, but notwithstanding these trivial incidents, which at first caused amusement, and when the interruptions were persisted in, resentment, the meeting was a thoroughly enthusiastic one. It marks a turning point in the history of the B.B.K.A., and with the strengthening of the Council by the addition of three new members augurs well for the future of the Association.

### REVIEWS.

*The Illustrated Australasian Bee Manual and Complete Guide to Modern Bee Culture in the Southern Hemisphere.* By Isaac Hopkins, Auckland, New Zealand. (Wellington N.Z., and London. Published by Gordon and Gotch, 15, St. Pride Street, E.C., price 2s. 6d.)

In this revised and mostly re-written fifth edition the various forms of bee diseases and the methods of coping with them receive due attention, and there is added a digest of the New Zealand Apiaries Act which was introduced by the author while Chief Apiarist to the

Government. This Act, as he points out, was the first to prohibit the keeping of bees in anything but movable frame-hives. The author uses the Langstroth hive, which he introduced into Australasia, but he is wrong when he states that this "is used now in all parts of the world with the exception of Great Britain." As a matter of fact, there are many other patterns of hives used even in America, and on the Continent of Europe very few, if any, Langstroth hives are to be found. The British "Standard" frame is also largely used in South Africa. In the 18th chapter, "Bees in Relation to Agriculture," the objections sometimes raised by ignorant farmers to the visits of bees are considered and answered. The next and last chapter contains a useful calendar and some bee-keepers' axioms. The illustrations, though not of very high quality, are sufficient for an ordinary reader; the style is clear and unpretentious; and, generally speaking, the high character of Mr. Hopkins' manual has been well maintained.

*Shady Gardens*, by T. W. Sanders, F.L.S., F.R.H.S., London: Agricultural and Horticultural Association, price 1d.

In this new One and All Garden Book—No. 32 of the useful series—the experienced author deals with Shady Gardens, Borders, Nooks, and Corners fully, telling how to plant them to advantage, and convert even sunless spots into beautiful gardens of shades. The book is fully illustrated by its editor, Mr. Edward Owen Greening, with interesting scenes and photographs on every page.

---

**BRITISH BEE-KEEPERS'  
ASSOCIATION  
ANNUAL MEETING.**

---

The annual general meeting of members was held at the "Gardenia" Restaurant, 6, Catherine Street, Strand, London, W.C., on Thursday, March 16th, 1911. Mr. T. W. Cowan presided. There were over one hundred members present from all parts of the country.

The Chairman called upon the secretary to read the minutes of the previous meeting, when a person present rose and complained that he had been refused permission to bring a motion before that meeting and the Chairman pointed out that as he was not a member of the association he was not entitled to do so, and was out of order.

The minutes of the previous annual general meeting were then read and confirmed.

The Chairman referring to the report said that it had been sent to all the members, and that as they had a great

deal of business to get through that afternoon he would only make a very few remarks. He was quite sure that they would be pleased with the present improved position of the Association, greatly due to the energy and zeal of their new secretary, Mr. Herrod. It will be remembered that owing to the illness of their late secretary and the neglect of his brother who had undertaken to do his work, the Association had got into a very critical position, which gave the Council considerable anxiety. They were unable to get the books and when at last they did do so they found many accounts outstanding that should have been paid. During the year there had been a steady increase in membership from 214 to 361 (applause), and the number of affiliated associations had increased to 34. Referring to the finances the Chairman congratulated them on the satisfactory improvement in the accounts and balance sheet. Their subscriptions had increased from £109 1s. in 1909 to £168 10s. 6d., an increase of £59 9s. 6d. (applause). The total amount of receipts had been £362 1s. 5d. instead of £287 12s. the previous year, an increase of £74 9s. 5d. When they got their books they found that there were outstanding accounts of 1909 amounting to over £112. These had all been paid and £20 had been added to the reserve fund, which now stood at £151 3s. 10d. All accounts for 1910 had also been paid and the £63 15s. for the W. B. Carr Memorial Fund had been invested in Consols. The Association was now entirely free from debt, and had a balance of £57 14s. 11d. to commence the year with, which did not appear so large as that of the previous year which stood at £100 4s. 10d., but at that time there was £112 owing whereas now there were no debts and the reserve fund had been increased. They would find some of their property had been written off, lantern slides reduced from £4 to £3, bees and appliances from £25 to £10, and the tents were worn out and were therefore, of no value. The balance sheet therefore showed that the excess of assets over liabilities amounted to £223 17s. 2d., or £71 more than last year (applause). With regard to the library he would like to say how much the members were indebted to Colonel Walker for the trouble he had taken in cataloguing, indexing, and valuing their books. He spent over a fortnight at the office over the work and found it a dirty job, as the books had all been stowed away and were covered with dust, but now they were all nicely arranged in cases. Some were missing and had not yet turned up. He was sorry that the report of the Apiary was not so satisfactory for they had suffered like other beekeepers had done, and had lost nine out of their ten colonies through Isle of Wight

disease. The exhibitions during the year also showed a satisfactory improvement. At the Royal Show there were 140 entries against 117 the year before, at the Dairy show 95 instead of 87, and at the Groceries 229 against 200 in the previous year. With respect to examinations eight candidates had received second class certificates and 122 third class, and he was sorry that none of the candidates for the first class certificates had been able to satisfy the examiners. As to Insurance there had also been an increase, 12,955 hives had been insured against 11,281 the previous year. There were 751 members and 257 non-members insured, a total of 1,008, against 801 the previous year. He would point out the advantage which affiliated associations had, as their members paid no registration fee, and as this was 1/- for non-members the Associations practically got back their affiliation fee if 21 members insured, the parent Association bearing all the cost in connection with the work. He was pleased that the council were able to present such a satisfactory report and without referring to any of the other matters he moved that the report and statement of accounts be received and adopted (great applause).

The motion was seconded by General Sir Stanley Edwardes.

Mr. Skevington raised the question of expenses of the apiary and postages, two other non-subscribers also speaking on the same subject.

The Chairman replied that as Mr. Skevington was a member of the Council and also—as one of the Finance Committee—had checked and signed the accounts and had presented their report at a number of Council meetings, and that the balance sheet had been passed by the Council, he should know all about it. He would however ask the secretary to explain.

The Secretary said that perhaps, on the face of it the apiary appeared an expensive matter, but when they took into consideration that it included the payment to him of all the lecturing done at the Royal Show, Swanley College, and elsewhere, the provision of bees for these lectures and demonstrations, and also for examination purposes, also a certain amount for travelling expenses, it would be found that the actual cost was only a few pounds. The apiary was established as an experimental one, and not on a commercial basis, as the district was not a good one for honey, but well situated for visitors, of whom there were a number each year.

With regard to the amount for postages he was pleased that this had increased, as it was a testimonial to the fact that he had not neglected the correspondence. The more the Association grew naturally

the postage account would increase. If they referred to the report it would be found that very few members were in arrears with their subscriptions: this had only come about after a considerable amount of writing in the form of applications for payment. Two of the gentlemen who had questioned the amount were secretaries of associations. In one case when it was important to obtain reports of affiliated associations to back up the application for the grant from the Development Fund, he wrote six applications for the report of that Association, and up to the present had not received it. In the other instance, it was with the greatest difficulty he extracted the affiliation fee after about nine letters and a threat to remove the name of that Association from the list according to rules. They would thus see that nearly five per cent. had to be expended to collect that one guinea, and yet that secretary now found fault with the postage account. Also he was now sending out each month sixty notices of Council meetings against twenty-one in previous years. He had kept postage books, with the name of every person for whom even a halfpenny stamp had been used, which were open for the inspection of any member who wished to see them.

Mr. Sander strongly objected to the tone and manner of the criticism. Criticism he welcomed as it was most useful, but the manner and tone of those speaking he considered was a reflection not only on the secretary, but also on the auditor and Council, making it appear as if some-one were dishonest.

Mr. Snelgrove said he had received a whole budget of correspondence from Mr. Herrod where it was impossible in the past to get even one answer. He considered the increase in postage told considerably in favour of the efficiency of the secretarial work.

The matter of apiary was left for the Council to deal with.

Mr. Watson proposed a hearty vote of thanks to the retiring Council and officers. They had passed through critical times, and steady work of the kind they had done would eventually put the Association on a much firmer basis than the violent form of reformation that had been proposed.—Mr. Falkner seconded, and it was carried unanimously.

Mr. Reid rose and asked the chairman, if he was not out of order, that he might say a few words.

He thought it was only right at that juncture to propose a vote of thanks to their secretary. He knew he was a paid official, and the proposition might be a little out of order, but he was quite certain Mr. Herrod had done a lot of hard work outside his ordinary duties, and he

could say in all his work he was thorough and conscientious. He was quite sure the members would be glad of this opportunity to show their appreciation.

Mr. Eales seconded the resolution. He knew from personal experience that the secretary had not spared himself in his labours.

Mr. Pugh heartily supported the motion. He knew the secretary's heart was in his work and to show that the County Associations had his sympathy, he would like to say that he visited the annual meeting of the Notts B.K.A. representing the B.B.K.A. and this without an invitation although it meant a journey of over 200 miles.

The Chairman said he could fully testify to the immense amount of efficient work their secretary had done and their present satisfactory condition was largely due to his efficiency.

The motion was carried unanimously.

The Secretary in reply said this was a most unusual motion regarding a paid servant and it had surprised him so much that he scarcely knew what to say. When, a little over twelve months ago he was appointed secretary, he said he would do his best and he could conscientiously say that he had carried out that promise, and without egotism he could say that the work had been very hard. He would like to pay tribute to the valuable assistance and sympathy rendered him by the chairman and some of the members of the Council—to mention names would be invidious. These gentlemen though occupying high positions in the commercial world, and therefore very busy men, had not grudged time to help the Association gratuitously, and without their help the work would have been much more difficult. One of the Council had remarked that "Herod was paid a thundering big screw and does nothing." He would like that councillor to take the work on for six months, when he thought he would alter his opinion. The work was a labour of love with him, and his one desire was to see the British Bee-keepers' Association second to none in the world. That he was anxious for that was proved from the fact that to help the Association out of its difficulty he had offered to do the work for one year for nothing; this offer the Council would not entertain. The work had been strenuous and had taxed him to the utmost, so much so, that a few weeks ago he seriously considered whether he could go on with it. It had been more than one man's work and he could not have done what he had, had it not been for the splendid assistance given him by his wife; but for that in all probability he would have had to give up. He had tried to be just to all;

it was very difficult to tighten the reins when rules and conditions had been administered in a lax manner for a considerable time. He might have offended some by so doing, but he could assure them that he had tried to do his duty without fear or favour.

His sympathies were with the Affiliated Associations and he wished he had time to visit more of them. Not only did he visit the Notts annual meeting, but on Saturday last he travelled over 400 miles to be present at the annual meeting of the Lancashire Association.

That by this resolution they had shown that they were satisfied with the work he had done was ample repayment for the extra exertion and he sincerely thanked them all for the kind appreciation he would continue in the future as in the past to do his best.

Mr. Lamb proposed the re-election of the vice-presidents, hon. treasurer, analyst and solicitor, this was seconded by Col. Walker and carried.

The Chairman said that he had a letter from Mr. Willard resigning his appointment as auditor on account of failing health. This was accepted with deep regret, and it was resolved that the best thanks of the meeting be accorded to Mr. Willard for his long and valued services.

Mr. Cowan proposed and Mr. Eales seconded, that Mr. Sanders be elected auditor, and this was carried unanimously.

Mr. Sanders said when Mr. Cowan asked him before the meeting if he would accept the post he felt honoured and said yes, but after the acrimonious tone of the criticisms of one or two people he now felt inclined to refuse. He would accept, but he assured them if the accounts were criticised when he had done them, in the same tone as they had been that day he should refuse to undertake the work again.

Mr. Reid proposed, Mr. Dant seconded, and it was carried, that the honorary and foreign corresponding members be re-elected.

The election of Council for 1911 was then proceeded with. The Chairman remarked that there were twenty-three candidates for twenty-one seats. The election could be by show of hands, but if a ballot were desired any three members in the room could demand one.

Mr. Smallwood, Mr. Eales and Colonel H. J. O. Walker demanded a ballot, and the Chairman nominated Mr. Snelgrove and Mr. Salmon as scrutineers. The voting resulted in the election of Miss M. L. Gayton, Miss K. M. Hall, Messrs. T. W. Cowan, W. F. Reid, R. T. Andrews, T. Bevan, C. L. M. Eales, O. R. Frankenstein, E. Garcke, H. Jonas, J. B. Lamb, A. G. Pugh, A. Richards, E. Walker, J. Smallwood, E. Watson, General Sir

Stanley Edwardes, Dr. T. S. Elliot, Capt. F. Sitwell, Col. H. J. O. Walker and Rev. A. D. Downes Shaw.

Mr. Bevan moved pursuant to notice: That rule 5 be altered, the first and second lines to read as follows:—"The Association shall have power to elect honorary members also, etc." This was seconded by Mr. Pugh and carried.

Mr. Coltman pointed out the injustice according to rules of delegates being allowed only to attend and have a say at Council meetings, and not at the annual meeting, and after discussion Mr. Lamb gave notice that he would move at the next general meeting of members that "each affiliated Association should in future be able to exercise all the rights of membership of the British Bee-keepers Association through one of its members." This concluded the business of the meeting.

After the annual meeting the Council and delegates met, but as it was then 5.45 it was resolved to adjourn the meeting to a future date.

*Report of Conversazione will appear next week.*

## Correspondence.

*The Editor does not hold himself responsible for the opinions expressed by correspondents. No notice will be taken of anonymous communications, and correspondents are requested to write on one side of the paper only and give their real names and addresses, not necessarily for publication, but as a guarantee of good faith. Illustrations should be drawn on separate pieces of paper. We do not undertake to return rejected communications.*

### ISLE OF WIGHT DISEASE.

[8114.] I shall be at Southsea the first week in April, and if any afflicted bee-keeper in the Isle of Wight cares to allow me to inspect stocks where the disease is in progress, I shall be glad to avail myself of the opportunity.

With reference to the alleged outbreak among driven bees in the North, I should like to call attention to the views held by skeppists in the days of the sulphur pit. It was considered bad policy to winter stocks that went to the heather and such stocks were usually condemned. If it was necessary to preserve them it was recognised that they built up well in spring if they survived. But it was noticed that many stocks succumbed with the bowel distended with pollen and it was always advisable to feed stocks with sugar syrup to minimise this danger.

In heather, tree, and fungus secretions there are probably astringent principles of which bees can stand but a limited quantity without detriment.

I hope northern bee-keepers will exhaust this possibility before accusing southerners

of sending them a virulent contagious disease.—G. W. BULLAMORE, Albury, Herts.

[8115.] I am sorry to read in the pages of the *Bee Journal*, of the spreading of the Isle of Wight disease amongst bees, so will give you the following for what it is worth. In the years of 1902 and 1903 I kept about forty stocks of bees at Lupton, nr. Kirkby Lonsdale, Westmorland, and had the hives on a southern slope where they got plenty of sun—in fact too much of it, and in those years during the summer months I noticed hundreds of bees crawling on the ground about the hives, unable to fly, though they kept trying to do so. The bodies of some were much swollen, and I thought at the time it was due to the summer heat, so gave them all the ventilation I possibly could, but as soon as I heard about the Isle of Wight disease I thought my bees were just the same—the only difference being that mine came through all right.

Now, about there they use a lot of basic slag for the clover fields. Can that have had anything to do with the disease? There was also a lot of charlock in the cornfields, but I do not know if the farmers sprayed it at all.

I kept bees at Lupton until 1906, and during the last three years I saw nothing of the sort again.

I removed to Derbyshire in January, 1907, and so far have not seen any diseased stocks of that kind, and trust I may not do so, though I visit a great number of apiaries during the spring and autumn. I am much afraid we shall get it in Derbyshire as it seems to be spreading at a very alarming rate.—R. NORTH, Breaston, Derby.

[8116.] Life is not long enough for me to re-enter a barren controversy as to whether aphides reproduce by budding or from eggs. (page 107.) I would suggest that the B.B.K.A. can, by collecting facts relating to each outbreak of "I. of W. disease," get as near to an understanding of the disease and a remedy as one or two pathologists working without an extensive inquiry. I would suggest that you collect information to show, among other things, whether the disease has been accompanied by the spraying of fields with sulphate of copper or what not, the coming into the district of bees from elsewhere, the buying of old hives, the presence of foul brood, the importing of Italian queens, much or ficial pollen, the presence of unusual flowers, much work or breeding asked of the bees, and such other circumstances as it may be deemed wise to ask about. If a great number of papers can

be filled up with "yes" or "no" opposite a row of questions of this sort, it might be an easy thing to pick out the single cause of the disease. I do not believe that spraying has anything to do with it, for example; but since there are some who do, I would certainly include an inquiry as to this in the form which I hope you will see your way to draw up for beekeepers to sign.—G. G. DESMOND, Camberwell.

### B.B.K.A. CONVERSAZIONE.

#### BIOSCOPE PICTURES.

[8117.] At the close of the conversazione last Thursday, I was informed that it was the opinion of several members present that my scarecrow picture was a "fake" viz., that I had placed the bees and combs in the body of the figure just before taking them out.

I can assure all who saw the picture that it was perfectly genuine. The scarecrow stood on a piece of ground belonging to Miss M. E. Messent of Street Farm, Lamarsh, Essex. About the first week in June last I received a letter from that lady informing me that she had seen a stray swarm of bees enter underneath the waistcoat of the scarecrow and that she had tied a sack round it to keep off the rain.

About the middle of July I went to Lamarsh with a cinematograph operator and removed the bees.—J. C. BEE MASON, Bures, Suffolk.

### SOMERSET B.K.A.

#### ANNUAL MEETING

The Somersetshire Beekeepers' annual meeting was held on March 11th, at Taunton, Mr T. W. Cowan presiding over a large gathering of members from all parts of the county. The work done by the association was shown in the ably-compiled report of the council by the hon. secretary (Mr Louis E. Snelgrove). Some of the items were as follow:—Although the year 1910 may be characterised as one of the most unprofitable that Somerset beekeepers have ever known, yet the county association has increased more rapidly than ever before. The balance-sheet shows a total turn-over of £80, as compared with £64 6s. 7d. for last year. The principal work of the association, that of the visiting experts, has been largely increased, and there is every prospect that this increase will be steadily maintained. The balance in hand is £5 16s. The membership for the current year will exceed 400, an increase of about 80 over last year. The experts have made 460 visits and examined about 1,272 hives, of which 62 were reported as suffering from foul brood. Unfortu-

nately, black brood still exists in one small district, but happily the Isle of Wight disease has not appeared in the county. The sales of the association honey label have been small, an inevitable consequence of the meagre honey crop. In every district this has been much below the average, and it is doubtful whether in any part a true surplus was secured. Of the nine candidates who sat for the third class examination, the following obtained certificates:—Messrs. N. J. Reynolds (Huntspill), H. Jarvis (Taunton), T. Jones (Weston-super-Mare), J. Spiller (Taunton), and W. Gliddon (Yatton).

Mr. Cowan, in speaking to the report, said that it must be a matter of satisfaction that subscriptions had increased instead of falling off, after such a disastrous year for bees. The experts' fees were much more, and this denoted how the work of the association was extending.

The report having been adopted, the Chairman presented the various prizes and experts' certificates.

The hon. secretary, Mr. Louis E. Snelgrove, and the assistant hon. secretary, Mr. L. Bigg-Wither, were thanked for their services. Mr. Tite was added to the list of vice-presidents.

The company then sat down to tea, after which, Mr Cowan gave a short address on "The Isle of Wight Disease."

The proceedings shortly afterwards terminated.

### NORTHUMBERLAND AND DURHAM

#### B.K.A.

#### ANNUAL MEETING.

The annual meeting of the Northumberland and Durham Bee-keepers' Association was held on March 11th at Crosby's Cafe, Newcastle, Mr. J. N. Kidd (Stocksfield) presided. The report of the hon. secretary (Mr. G. G. Robson) stated the membership was about fifty. Reference was made to the Isle of Wight disease, which had done much damage in the South of England, and which stated to have broken out in the Chester-le-Street district. As many as 275 hives were insured last year. A new branch had been established in Weardale, and efforts were being made to establish one at Barnard Castle.

The financial statement showed a credit balance of £8 3s. 1d.

Lord Barnard was re-elected president; whilst Mr. H. F. Bulman and Lord Northbourne were elected vice-presidents. The hon. secretary was re-elected.

It was announced that arrangements had been made for excursions to Mr. Kidd's place at Stocksfield and to Cockle Park.

STAFFORDSHIRE B.K.A.

ANNUAL MEETING

The annual meeting of the Staffordshire Bee-keepers' Association was held at the County Council Buildings, Stafford, on March 4th. Mr. A. H. Heath presided.—The annual report was read by the hon. secretary (the Rev. G. C. Bruton). It stated that the number of subscribers was 166, which was an increase on the previous year, and the amount received in subscription, £28 16s., was equal to the average. In his report, Mr. Tinsley, the association expert, said that in those districts which had produced large quantities of honey he found that the supply of white clover was unlimited, and that the land was farmed by scientific agriculturists, and these were a great help to the bee-keeper. The apiaries in the county were kept at a much higher standard than formerly. The percentage of foul brood in the county was the lowest on record, it being 1.2. The drastic methods employed to stamp out the infection, coupled with the willingness of bee-keepers to assist, had alone been responsible for Staffordshire occupying such a satisfactory position in regard to the disease.

Mr. Heath was elected president.

NEW B.K.A. FOR BARNET AND DISTRICT.

A bee-keepers' association for Barnet and district was successfully formed on Friday, March 10th. A large and representative gathering of bee-keepers attended, and welcomed the society as filling a long-felt want. Several able speeches were made by prominent local bee-keepers, and the resolution to form an association was unanimously carried. Thirty members were enrolled at the meeting, and the proceedings closed with a vote of thanks to the chairman, Mr. W. H. Cutbush. Anyone desirous of joining the society can obtain rules and particulars on application to the hon. sec., G. J. FLASHMAN, 37, Falkland Road, Barnet.

Queries and Replies.

[4102.] *Using Drawn-out Combs.*—I write to thank you for reply in B.B.J., but owing to illness, have not been able to send you some bees from the hive which had dysentery. Why that stock should have this complaint I cannot understand, as I have fed all my bees on soft candy since last October; possibly there may have been some unsealed honey in the brood-chamber which I had not noticed. I asked your advice about some

frames I have half-full of honey. I took them out of a hive which died out, something having gone wrong with the queen. I omitted to inform you that the combs were only drawn out last season, and are spotlessly clean, except for a little pollen here and there. If they had been old I certainly would not have thought of troubling with them, but thought as they are perfectly healthy, of putting them on top of a strong stock later on, and having queen-excluder between. When cleaned out and filled with honey, I could extract them, then place them in another hive for a swarm. Would this work out all right? I have been a constant reader of the Journal for a long time, and always look forward to seeing it every week. Regarding the frequent mention of Foul-brood Legislation, I hope that such legislation will not be far distant, as it is very much needed for the protection of the industry.—ANXTOUS, Berwick.

REPLY.—You must not use the brood combs for supering if you wish to use them for a swarm, as by the time they are sealed the swarming season will be over. Use them in the hive in which you put the swarm, interspacing them with frames fitted with full sheets of foundation.

If you use the combs for supering, they might be utilised later for putting driven bees on to.

[4103.] *Bees and Fertilisation of Fruit.*—In the month of July last I started bee-keeping by purchasing a W. B. C. hive, and a stock of bees (hybrid), for which I paid £1 15s. I did not put any extra frames or sections on the hive, so that they might accumulate a good food supply for the winter. I also fed them up with syrup which was medicated with anti-foul-brood mixture, and of this the bees partook very freely. I was very much troubled with robber bees, so much so that the carbotic mixture, as recommended in the "Bee-keepers' Guide," did not keep them away, so I opened the zig-zig entrance very widely, and placed a piece of perforated zinc across the same to enable the bees to have plenty of air. At the beginning of winter I filled the space between the hive and the outer cover with chaff, where it still is, and the robbers, having gone, I removed the zinc from the entrance. All the frames were not covered with bees, so I put those that were covered near each other as directed in the "Guide," using the dummy frame, and placed some candy under the quilt. There were two quilts and two pieces of sacking over these again upon the frames for warmth, and when the weather was very cold I had two sacks put over the hive at night and removed in the day. I find

that the robber bees are again visiting my hive without any movement on the part of my bees, and I have placed the zinc across the entrance, so that they may have plenty of air. On looking under the quilts to-day I could not see any bees between the frames, but this was done hurriedly, and without lifting any of the frames out. Failing to see any sign of life makes me fear that they must be dead, but I do not care to make any thorough examination until the weather is milder. A good deal of the candy appears to have been consumed. I have not seen any dead drones on the alighting board, though there were a good many living ones around the hive last autumn. Will you have the kindness to let me know what I should now do, as I see by the "Guide" book that the hive should not be examined until the end of this month, and I am anxious to know whether the bees are alive or not. My chief object in keeping them was to see whether my fruit-trees would bear better by reason of the bees fertilising the blooms, as notwithstanding the large show of bloom I have every year, the fruit crop is small. Should the colony prove to be dead, I wish to get another lot with as little delay as possible. What kind would you recommend me to have in that event?—W. F., Anglesey.

REPLY.—Your bees have evidently died out from some cause, and the hive is now being robbed. Examine it on the first fine, warm day, and if the bees are dead, remove the hive indoors until it can be attended to, as it will do your neighbour bee-keepers harm to leave sweets exposed for their bees to rob. There is not the slightest doubt but that your fruit trees will benefit by bees being kept, and we advise you to obtain a good stock of English bees as soon as possible.

[4104.] *Hybridising Bees*.—I should very much like to ask the following questions with regard to breeding queens. I have a White Star (Simmins') Italian Queen, some imported queens from Italy, and some ordinary Blacks. I should prefer to try pure Italians, but would be pleased to know if the progeny of a black queen crossed with an Italian Drone would be of vicious disposition, and also which Italian queen would you advise for rearing queens, and which drones. Thanking you in anticipation.—A. WARMUNSTER.

REPLY.—(1) If you hybridise it is almost certain you will get vicious bees; Breed queens from the "White Star" and drones from the imported Italians.

[4105.] *Storing Surplus in Brood-Chamber*.—Last year I was unable to get my bees up into the supers, and consequently had no surplus. The stock was fairly strong, and the bees stored a great deal

of honey in the brood-chamber. If you would give me any information as to the best way of guarding against such an occurrence in the future I would greatly appreciate it. Would it be safe to work without an excluder, as that seems to me to be the cause of the trouble?—I. G., Laisvane.

REPLY.—Last season was a very bad one, and this was most probably the cause of bees not working in supers. On no account must you dispense with excluder if working for extracted honey, but if sections are your object you might do without it, though it is not advisable to do so.

[4106.] *Propolis—Finding the Queen—Sowing Clover Seed*.—(1) Would a privet hedge, in immediate vicinity of hives, be injurious to bees, and would they swarm on it? (2) A large larch plantation lies close to my new apiary here. Bee-keepers here tell me their racks of sections get so glued down with propolis that great difficulty arises in removing them. Is there anything better for greasing bottom of racks than petroleum jelly or vaseline—such, for instance, as lard? (3) Even on a very long swarm board, I have never been able to "spot" the queen when running in. In hiving swarms, if I fixed a strip of excluder zinc at hive entrance, and so prevented the queen getting in, would be objectionable. I ask it, because I am short-sighted. The excluder zinc could be fitted into a narrow wooden framework, made for the purpose of exactly fitting doorways. My hives are Lees' W.B.C.'s. As I do not want increase of stocks this season, and wish to return swarms to the hives from which they issued, I may want to destroy a few old queens and let new ones hatch out from good queen cells in different hives. (4) Will destruction of the old queen materially affect the gathering of surplus honey, and for how long? I work only for sections. My district is a fairly good clover and flower one—and later on ling heather everywhere. (5) What would be the best clover seed for bees, to give a local farmer to sow along with his ryegrass seed, and what quantity per acre?

REPLY.—(1) A privet hedge would not be injurious, and the bees would probably swarm on it. (2) Vaseline is the best material to use to prevent propolization. (3) There is no objection to this method beyond the fact that it takes longer for the swarm to get into the hive. It is the method we advise for anyone afflicted with imperfect sight. (4) Destruction of the old queen will not affect the honey harvest very much, as it is only the old bees that go foraging. It would be



better to have young queens ready to introduce twelve hours after killing the old one, first destroying all the queen cells. (5) White clover seed, about three pounds to the acre, would be very us.

[4107.] *Neighbours and Bees.*—Would you kindly advise me, in your valuable little journal, which I have taken since I began bee-keeping, on the following? I have five hives of bees in my garden in the country, surrounded by a high 5ft. fence, on the other side of which is a right of way. Lately, my neighbours have made a tennis lawn in their meadow, the other side of the right of way, about 70 yards from my fence; they now fear my bees may trouble them, and want me to move them. Am I bound to do this? It would be a great trouble and expense to me, as I should have to move my beehouse too, and I have nowhere else to put them. Would I be liable if any one got stung. The bees have been in this place five years.—ROGGE, Essex.

REPLY.—There is not much danger of your bees interfering with your neighbours under the conditions you name, and unless they can prove they are a nuisance, you cannot be compelled to move them. You can insure against injury to third parties, and we are sending you a form for this purpose.

[4108.] *Uniting Bees.*—Will you answer me the following questions? I wish to unite two stocks. They have wintered well and have plenty of stores, one was a driven lot in August last, which I put on to two frames of brood and stores and four more frames and fed them up well. Would the Queen with the driven lot be a 1910 one. The other stock was a 4 lb swarm, I gave them some soft candy in February, but on March 11th they had eaten the candy and got sealed stores and a little brood on two frames. When shall I start feeding with syrup, and how and when is the best time to unite them. I should like to take them to the country for the honey flow; when shall I move them, is early in May a suitable time?—G. H. W. Burton-on-Trent.

REPLY.—If the driven bees were from a skep that had swarmed, the Queen will be a 1910 one. You can unite the first fine warm day in April, and you should move them about a week afterwards. Syrup feeding may be commenced in first week in April.

[4109.] *Hybridising Bees.*—Of the following Hybrids, which in your opinion produces the gentlest bees. (1) English queen crossed with Carniolan or Italian drones. (2) Carniolan queen crossed with either Italian or English. (3) Italian queen crossed with English or

Carniolan. Your kind advice will oblige.—BUSY BEE, Alnwick.

REPLY.—In all cases you are almost certain to get vicious bees. Our choice would be English queen mated to Carniolan drone. Why not stick to English bees; they are much the best?

## Notices to Correspondents.

*Letters or queries asking for addresses of manufacturers or correspondents, or where appliances can be purchased, or replies giving such information, can only be inserted as advertisements. The space devoted to letters, queries, and replies is meant for the general good of bee-keepers, and not for advertisements. We wish our correspondents to bear in mind that, as it is necessary for us to go to press in advance of the date of issue, queries cannot always be replied to in the issue immediately following the receipt of their communications.*

QUEEN EXCLUDER (Plymouth).—*Wire Netting as Excluder.*—The wire netting will not do to use as a queen excluder, being very inaccurately made. Use the proper excluders sold by all appliance dealers. Particulars as to subscribing to foreign bee journals are being posted to you.

J. H. (Whitley Bay).—*Utilising Comb Honey.*—You cannot "dissolve" honey in the combs without melting the latter down. Give the combs to the bees as they are, they will utilise the honey as food, while the pollen will also be useful to them. Extracted honey can be thinned down with water to the consistency of syrup before being used as bee food.

E. S. (Sandplace).—*Fumigating Combs.*—We do not supply formalin. Write to J. Lee and Son, 4, Martineau Road, London, N.

W. T. (Bridgnorth).—*Stock of Bees Disappearing.*—Judging from the particulars given, the colony has either dwindled away or, as you suggest, the bees have joined another stock. This happens sometimes. The syrup in the comb appears quite right, and it may be used for other colonies.

E. A. B. (Ruthen).—*Making Candy.*—You were right in putting pea-flour into the candy, but unfortunately you have overboiled the latter.

F. C. H. (Lambourne).—*Phenyle Solution.*—1. This disinfectant for washing hives should be in the following proportions. 2 tea-spoonfuls of soluble phenyle to 1 quart of water (see Guide Book, page 198). 2. The candy has not been boiled quite enough.

F. J. M. (Wokingham).—*Honey Sample.*—The sample is of fairly good flavour, but is thin in consistency.

C. F. (Bracknell).—*Buying Skeps.*—You evidently made a very dear bargain. You will have to work the bees down

into proper frame hives (as per instructions on page 149 of Guide Book) before you can hope to be successful with your bees.

- H. E. (Kidderminster).—*Medicating Syrup-food*.—The naphthol beta solution must be stirred in as soon as the syrup is removed from the fire, while hot.
- W. A. P. (Blythe Bridge).—*Driven Bees*.—The Guide Book will give you all the practical information you require if you study it carefully. (See pages 147 and 154 re driven bees.)
- D. M. (Doune).—*Transferring Bees*.—You can only discover when the Queen takes possession of the lower hive, by making an examination of the combs there for signs of brood. It would have been better to have given candy and not syrup, but as you have commenced with it, give the syrup slowly, about half a pint per week, or the bees will store it in the cells, and in consequence there will be no room for the Queen to lay.
- L. A. S. (Broadway, Worc.).—*Parasite on Bees*.—The insects are the *Braula caca*, or blind louse. Puff a little tobacco smoke in at the entrance of the hive, which will cause them to drop, lift off the brood chamber, and brush them off the floor-board which might then be washed with disinfectants. This will get rid of them. (2) The white substance on the comb is simply mouldy pollen. We are pleased to hear you enjoyed reading the B.B.J. even before you were able to keep bees.
- Suspected Disease.*
- M. K. H. (Alton, Hants).—The bees have died of Isle of Wight disease. Burn combs, quilts, &c., as you suggest, and disinfect the hive as if foul brood were present. It can then be used again.
- W. (Harborne).—The bees have had dysentery and there are signs of Isle of Wight disease. Attend to disinfecting the hive, &c., at once.
- G. B. (Droitwich).—Sample is a bad case of foul brood, and we should advise you to burn the contents of hive and disinfect thoroughly.
- W. H. R. (Franklin).—The bees are too dry for us to be able to give cause of death. Queen is a virgin.
- Enquirer (Horsforth).—One bee shows signs of dysentery. The candy is of excellent quality and cannot have been detrimental to the health of the bees.
- A. H. (Four Oaks).—Bees show signs of Isle of Wight disease. Follow instructions given to M. K. H., Alton.
- A. D. T. (Nantwich).—(1) The bees have evidently died of dysentery. (2) Yes, they might be used again if thoroughly

cleaned. (3) We have heard of one suspicious case, but it was not definitely ascertained that it was an outbreak of Isle of Wight disease.

G. S. (Luton).—Your bees have been dead too long and are too dry for proper examination. They appear to have died naturally.

### Special Prepaid Advertisements

**L**IMNANTHES DOUGLASSII, early spring bee flowers, commencing to bloom, 1/6 per 100 free.—HAWKINS, Ashgrove, Queenstown, Co. Cork. h 7

**T**HE PREPARATION OF HONEY and Wax for Show Bench, 7d.—TINSLEY, Stone, Staffs. h 5

**F**OUR GOOD STOCKS OF BEES, in well-made W.B.C. hives, nearly new. What offers?—TURNER, Park Cottages, Pinkneys Green, Maidenhead, Berks. h 3

**W**HITE WYANDOTTE EGGS, 7s. 6d. sitting; pullets mated up and purchased from the White Wyandotte specialist to a cock guaranteed, from 1909 Palace and Dairy winner.—NORRIS, 3, Perivale Gardens, Ealing. h 12

**35**S. HEALTHY STOCK BLACKS, 20th century hive, smoker, veil, excluders, &c., free on rail.—G. SHEPHERD, Northcote, Upper Clapton, N.E. h 4

**H**EATHER HONEY, 1lb. screw jars, 10s. doz.; compressed p.p. pots, 8s. 6d. doz. carriage paid.—JOHN HONEYBEE, Dorchester. h 10

**W**ANTED, PARTNER or MANAGER, or PUPIL to take over Apiary, lease house, end of season.—MATTINSON, Happsburgh, Norwich. h 8

**E**XCELLENT OPPORTUNITY. Bee Hives and Appliances, new, state requirements; cash, or exchange double gold Albert.—BODE, 195, Plymouth Grove, Manchester. h 11

**T**WO STOCKS BEES for sale, in modern frame hives, guaranteed healthy, 1910 queens, 27s. 6d. each.—Particulars, IRVING, Galabank Apiary, Annan. h 9

**O**LD BEE LITERATURE 3 books by Wighton, Mills and Cotton (see issue Feb. 23rd for description), exchange modern literature or nucleus with queen, or part extractor.—19 Pelham Road, Norwich. h 5

**T**O LECTURERS and OTHERS. Bee life on the bioscope, as shewn at the B.B.K.A. Conversazione.—Write for terms to BEE MASON, 27, Ashted Road, Clapton Common, N.E.

**F**OR SALE, A SMALL APIARY, comprising 15 stocks of healthy Bees in bar frame hives, with super and shallow frames, 10 new spare bar frame hives with all necessary appliances.—Apply to HEAD GARDENER, Chicksands Priory, Shefford, Beds. g 96

**W**ANTED, PURE BLACK QUEEN.—State price to M. WILLIAMS, Wheelton, Chorley, Lancashire. g 97

**H**EATHER and CLOVER SECTIONS for sale, first grade only.—P. M. RALPH, Settle, g 98

**B**EE JOURNALS, vols. 1908, 1909, 1910, clean, unbound, cheap, 9s.—J. CHAWNER, Desford, Leicester. g 99

**W**ANTED, BOARD-RESIDENCE with bee-keeping instruction; heather district preferred.—Write inclusive terms (moderate) to HENRY BROOME, 17 Arthur Street, Gloucester. g 100

## Editorial, Notices, &c

### BRITISH BEE-KEEPERS' ASSOCIATION

(Continued from page 115).

#### THE CONVERSAZIONE.

At the conclusion of the annual meeting the members and friends assembled for the usual conversazione. After partaking of the refreshments provided, the company, numbering over 120, adjourned to the lecture-room to hear Dr. Malden's address. Mr. T. W. Cowan presided, and among those present were: Mrs. Illingworth, Mrs. Herrod, Mrs. and Miss Inglis, Miss E. Scott Walker, Mrs. Mason, Miss L. M. Carr, Miss M. E. Carr, Mrs. G. Coates, Mrs. E. E. Ford, Miss E. F. Kettlewell, Mrs. Kidd, Mrs. Paul, Mrs. H. P. Perkins, Mrs. Seadon, Mrs. T. Marshall, General Sir Stanley Edwards, Colonel H. F. Jolly, Colonel H. J. O. Walker, Rev. A. D. Downes-Shaw, Dr. Elliott, Dr. Musson, Messrs. B. Alexander, D. Arthur, W. R. Allen, G. R. Alder, J. C. Bee Mason, S. Beard, D. H. Bracock, T. Bevan, Harry Brice, D. W. Bishop-Ackerman, J. Baddeley, J. P. Biss, C. H. Boccock, G. Bryden, G. W. Bullamore, E. R. Body, J. Cunningham, W. G. Coates, R. H. Colman, L. S. Crawshaw, H. G. Ceiley, J. Cooper, E. F. Dant, O. S. Dawson, H. Edwards, A. C. Elsdon, O. R. Frankenstein, W. G. Fischer-Webb, R. W. Furse, H. Filmer, W. L. Falkner, X. J. Ferry, E. Garcke, G. H. Garrett, L. L. Goffin, C. Grimham, W. L. Goldsworthy, Geo. Hayes, F. C. Hodges, W. Herrod, S. Hill, B. Hudson, J. Hudson, R. Hefford, G. H. Horscroft, A. J. Harris, J. Ide, J. J. Jessiman, W. Jarman, G. W. Judge, W. T. Joyce, P. W. S. Jefferies, G. Ketteridge, A. Kent, J. M. Kidd, G. H. Lander, W. L. W. Larkin, J. B. Lamb, R. Lee, H. J. Marshall, G. Masom, W. Martin, W. P. Meadows, A. E. Palmer, A. E. Paul, H. P. Perkins, A. G. Pugh, W. F. Reid, G. E. Rogers, A. Ross, A. Richards, G. O. Rous, A. E. Smith, V. Eric Shaw, W. A. Simkins, A. W. Salmon, L. E. Snelgrove, H. H. Smart, G. Steventon, E. H. Smiles, J. E. Smiles, S. H. J. Smith, T. E. Stone, E. R. Seadon, J. Smallwood, E. E. Tremlett, N. S. Toms, F. B. White, T. W. White, E. Wells, A. Willmott, E. Walker, E. Watson, F. W. Watts, and W. Ward.

The Chairman, in opening the proceedings, said he was very pleased to introduce Dr. W. Malden, of Cambridge, who had done much work in investigating the "Isle of Wight" disease, and who had kindly consented to address them on the subject, and he was sure that they would be interested to know more about this epidemic from him, as he could speak from experience. He would, therefore, now ask

Dr. Malden to read the paper he had prepared on the "Isle of Wight" disease.

Dr. Malden then addressed the meeting and said:

May I be allowed to thank the B.B.K.A. for inviting me to read this paper to them at their annual meeting, and to say how much I appreciate the honour they have done me.

I told your secretary when he asked me to read a paper on this subject that I had very little fresh information to give you, but I gladly embraced the opportunity offered to me because I wanted to get into touch with bee-keepers in all parts of the country, for it is by them that accurate information must be collected as to the actual facts connected with this disease, if we are to arrive at true conclusions as to its nature and means of propagation. This complaint, after being confined to the Isle of Wight for several years 1904-1908, has crossed to the main land, has invaded many counties in the South and Midlands, and threatens to spread over the whole country, practically exterminating the bees in its devastating progress. The first point I want to deal with is the fundamental one of whether or no we have to deal with an infectious disease spread by actual contact of bee with bee, or is it merely a seasonal complaint due to inclement weather, or to poisoning from some sorts of pollen, improper feeding or starvation? If we examine the facts so far as they are known as to the origin and spread of the disease. I think we shall have no difficulty in coming to the conclusion that it must be of an infectious nature communicated in some way or other from bee to bee. If this complaint is not an infectious disease but due merely to low temperatures, wet weather and absence of honey flow, why should it have remained confined to the Isle of Wight for four years? Surely the same climatic conditions were present all over the country to a greater or lesser extent, and yet there is no evidence of the complaint appearing anywhere except in the Isle of Wight from 1904 to 1908. The same argument applies to the other alleged causes of the complaint such as pollen poisoning, improper feeding, etc. Was the particular pollen which the bees are supposed to have taken peculiar to the Isle of Wight during these four years? and has it since appeared on the main land? Such a supposition is ridiculous.

Again, this complaint, though generally more prevalent in the early summer, may attack a hive at any period of the year. I have cases reported as occurring in nearly every month of the year which could not possibly be the case if the complaint was one due to poisonous pollen, feeding on honey dew, or other unsuitable food.

The argument that the complaint is due to *starvation* is not supported by the facts. I have myself opened numerous hives in which every bee was dead from the complaint and found the frames well supplied with stores, both of honey and pollen, and the same conditions have been reported to me by a great many bee-keepers, so that this supposition may be ruled out.

The complaint was first noticed in the late summer of 1904 at a village a little south of Newport; in the following year it appeared in several villages round about the original starting place (see Map), and in 1906 it had spread over nearly the whole island, but there were a few outlying places where it had not appeared. In the year 1907 when Mr. Imms visited

Cooper, of Thorley, who is a most intelligent and careful observer made a tour round the coast of the main land nearest to the Isle of Wight, and was unable to discover a single instance of the disease. Thus we may take it as a fact that for four years the disease remained confined to the Isle of Wight; had it been due to seasonal conditions or in fact to any cause save infection, is it possible to believe that the conditions which would have given rise to the complaint were not present on the main land during this time?

In the year 1909 the disease crossed the narrow channel and appeared in Hampshire, Dorsetshire, Sussex and Surrey, counties you observe which are

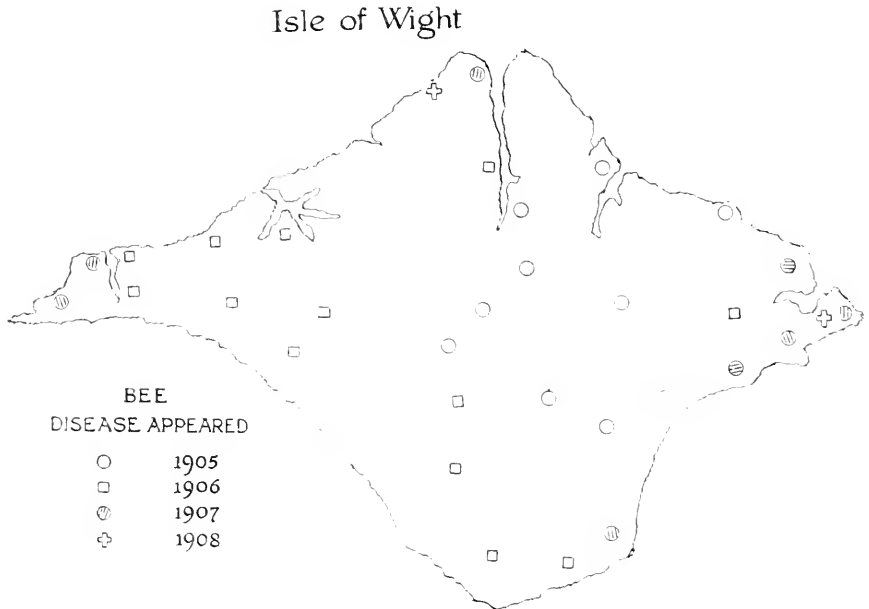

MAP SHOWING THE COURSE OF THE DISEASE IN THE ISLE OF WIGHT.

the island he found that there were only two localities where bees were kept which had escaped. These were Cowes and Norton, places at the extreme angles of the island. In the following year 1908 when I paid a visit to the island I found that the two places mentioned by Mr. Imms had been attacked later on in the year. I made a most careful inquiry all over the island, and as the result I was only able to discover two original stocks remaining which had survived, one at Gurnard, which was at least two miles from the nearest bee-keeper, and one at Bembridge belonging to a bee-keeper who had lost all his stocks but one. These last remaining stocks died in 1908. Later on in the summer of that year Mr. H. M.

geographically nearest to the island. After this my information is not full enough to be able to give you an accurate account of the spread of the disease, and I am hoping to extend my knowledge on the subject this afternoon, and to find out from bee-keepers in other counties when the complaint was first noticed in the localities they reside in or are acquainted with.

So far then as our information extends, the spread of the complaint has been by direct extension from place to place in exactly the same way as an infectious disease among human beings spreads. There may probably have been extensions of the disease into regions lying at some distances from sources of infection brought

about by infected bees sent from one part of the country to another, and this method probably accounts for the fact that the disease has spread much more rapidly during the past two years, since the time it gained a footing on the main land. I think we may take it as proved, so far as the evidence goes, that this complaint is an infectious disease spread from hive to hive.

The next point I would like to consider

that the disease remains confined to them; in only a few cases have I been able to find that the drones were affected, and in none that the brood showed any signs of it. I have myself opened several hives in which nearly all the workers were dead, and the queen with a few attendants alone remained alive while the brood appeared quite healthy and were emerging from their cells. This fact goes a long way towards proving that the disease

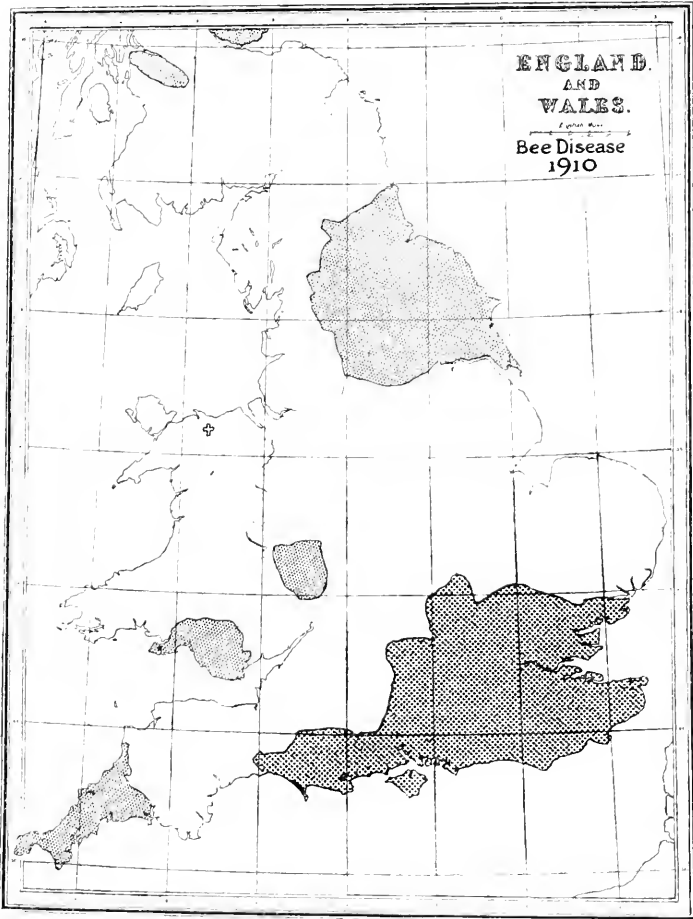

MAP SHOWING INFECTED AREAS IN GREAT BRITAIN IN 1910.

is, how is the disease spread and what is the nature of the infection? Here we are on much more difficult ground and must therefore proceed with the utmost caution taking nothing for granted, but proving every step we take before coming to a decision. When a hive is attacked by the disease, it has been noticed by nearly every bee-keeper with whom I have been in communication, that the foraging adult bees are the first to suffer, and generally

is introduced from outside by foraging bees bringing it back with them, and being in consequence the first to suffer. It has also been noticed by several careful observers that if robbing goes on from an infected hive, that the disease almost invariably breaks out in the hive from which the robbers come. This certainly looks as if the bees conveyed the infection from hive to hive. There may be possibly other ways in which infection is trans-

mitted, such as by a bee visiting a flower which had previously been visited by an infected insect, but this is impossible to be certain of, or if the infection is transmitted by the excrement it is possible that the water supply may be contaminated and thus the disease may spread to healthy stocks.

This takes us to still more debatable ground on which it is at present impossible to dogmatise, and we require a great deal more work on the subject before we shall be in a position to be certain as to the cause of the disease. Arguing from the analogy of other infectious diseases we should surmise that the complaint was either due to a pathogenic bacterium or else to a protozoan, as all the infectious diseases in man or animals with which we are acquainted are due to one or other of these two forms of parasites. The other bee diseases, the pathology of which are fairly well understood, such as foul brood and malignant dysentery, are caused in the first case by a bacterial, and the second by a protozoal, infecting agent, and it is therefore quite natural to expect that the disease under consideration is caused by one of these microbes, though at present we are not in a position to say with absolute certainty what actually is the pathogenic cause. In investigating any disease the first line of research is naturally the anatomical one, and this was the first point to be inquired into when an investigation of this disease was started. What anatomical peculiarities are there about a bee suffering from the Isle of Wight disease, which will enable us to say definitely whether or not it has the complaint? Unfortunately there are none; at least none that are distinctive. The conditions which are usually present are externally, first a disinclination to work, the affected bee flies about in an aimless way or sits on the combs or alighting board. Next the ability to fly becomes less and less marked, till at length the insect is unable to fly at all.

If examined, when in this condition, it is usually sluggish, disinclined to move, or use its sting, its wings are frequently dislocated and apparently the power to readjust them is lost: this peculiarity though very frequently present is not invariable, and may occur in other conditions. The abdomen of an affected bee frequently looks swollen and pendulous in consequence of the enormous distension of the colon with faecal matter. But this again is not necessarily a distinctive characteristic of the disease, since even normal bees when unable to leave the hive through bad weather, and, in consequence, not being able to defecate, get their colons distended in precisely the same manner as do the diseased bees. It



appears that the overloaded colon is only a sign that the bee is unable to fly and therefore unable to void the solid excrementitious matter which fills its gut. The craving for pollen and wax which diseased bees appear to have also tends to cause accumulation in the large bowel, and was considered by Mr. Imms, who first investigated the disease, to be the essential trouble; this, however, is certainly not the case. So far as I am aware there are no other external signs which indicate with certainty that a given bee is suffering from the disease under consideration and those that do occur are not distinctive, but may occur in other conditions. Are there any internal anatomical peculiarities which are distinctive? On removing the digestive tract from a diseased bee, the enormously distended colon is the first object which meets the eye: it is usually of a bright yellow colour, but not invariably--sometimes it is a dirty brown. The contents of the colon are usually very solid, but sometimes quite loose and watery.

On examining the contents of the colon they are found to consist of undigested pollen grains of various sorts, particles of wax, excrementitious matter and innumerable bacteria yeasts and moulds. All these products may be present in the gut of a healthy bee, though I believe it is very unusual to find particles of wax or such enormous numbers of pollen grains except in bees suffering from this disease. The small intestine does not appear different to the naked eye from the normal, nor are there any microscopical differences that I have been able to detect. The chyle stomach is naturally the next organ to be examined and here in many cases there does seem to be some departure from the normal. The organ appears to be more tender than in a healthy bee and frequently ruptures while being withdrawn from the abdomen. Its appearance also is generally different from that of a healthy chyle stomach, which is pinkish in colour with well-marked rings which mark the muscular bundles in its walls: in the diseased state the rings are less evident and the colon more a dirty white or brown than pink. It is more fragile and ruptures more easily apparently in consequence of the degenerated condition of the muscular coat. This degeneration is also very noticeable when the chyle stomach is examined microscopically, the lining membrane which supports the digestive glandular structures is frequently stripped off from the muscular layer and the cells appear to be degenerated. Bacteria can often be seen lying between the cells and behind them and within them. The honey sac does not appear to be the seat of any

marked change in this disease, nor do the gullet or salivary glands. Nothing abnormal has been discovered in any other organs, the vascular and nervous system, air sacs, tracheæ, fat bodies and Malpighian tubes appear to be quite normal.

So far, then, the disease from an anatomical standpoint is confined to the alimentary canal, particularly the chyle stomach.

Investigations of the bacteria contained in the alimentary tract of the bee were rendered long and tedious from the fact that the normal bacteria had never been studied or classified in this country. In America a good deal of work on the subject has been done, but unfortunately this did not prove of much value to us in England as the bacteria of the American seem to be quite different from those which occur in the English bee. It was found that bacteria were generally present in normal bees from the honey stomach to the anus, and that they increased in number the nearer you got to the lower end of the gut, that there were very few in the honey stomach, more in the chyle stomach, and very large numbers in the colon.

In diseased bees there always appeared to be many more bacteria in the chyle stomach, when smears were made and examined microscopically. Among the bacteria which were commonly found in the diseased chyle stomach was one which had never been observed in the healthy bee, and it was therefore considered possible that this organism might be the cause of the disease. From its morphological appearance and staining qualities I called it *B. Pestiformis apis*. It is a short, rather thick, bacillus, with rounded ends, which with aniline dyes stains deeply at the ends, leaving a band of unstained or only lightly stained material in the centre  this peculiarity gives it the appearance of being a diplococcus, it frequently occurs in pairs which lie at an obtuse angle  to each other. This organism was found to be present in about sixty per cent. of the diseased bees which were examined. Attempts to cultivate the bacillus were not very successful.

We had no idea as to what were suitable media for bee bacteria to grow upon, and the American work did not help us very much. There are a large number of different media for growing bee bacteria, and I have tried most of them, but so far have not found them of very great value, and a great deal more work is required on that particular point to find out what are the best media for growing the bacteria in diseased bees.

(Continued next week.)

## Correspondence.

*The Editors do not hold themselves responsible for the opinions expressed by correspondents. No notice will be taken of anonymous communications, and correspondents are requested to write on one side of the paper only and give their real names and addresses, not necessarily for publication, but as a guarantee of good faith. Illustrations should be drawn on separate pieces of paper. We do not undertake to return rejected communications.*

### ROSS-SHIRE NOTES.

[8113] The cold weather of March has kept things quiet in the apiary—outwardly at least. Inside the hives there is progress, shown by the increasing warmth of the quilting. Judged by the temperature test, a double-storey stock of "White Star" Italians is easily first, and should provide a sight worth seeing some sunny day when the still hibernating cluster dissolves for the first flight. Colonies wintered with the section racks left on appear to be flourishing. Instead of extracting unfinished sections last season, I replaced them in the racks without dividers and put them on strong colonies when winter packing. These racks containing about 12lb. of honey are ahead of candy cakes as a provision for reserve stores and winter passage combined. In spring they do duty as feeders, while in early summer, when every inch of the brood combs is wanted for brood alone, the queen is accommodated by the shifting of honey to the storehouse above. Such colonies may yield an earlier and heavier surplus than any others in the apiary.

Controversy often rages as to the respective merits of autumn or spring feeding of bees. In this part of the country we seldom need to practise either, as in most seasons the late crop provides sufficient stores to last until the following April. Then comes equalising of the food supply, exchanging heavy combs from honey bound stocks to those less wealthy (à la Lloyd George). During May, pollen comes in fast, the brood nest is rapidly extended, and stores run low with no prospect of outside gathering. Then is the time to feed, and keep on feeding right into June, or even July, if necessary. For clover may bloom, but if the weather is unfavourable our bees may die in the midst of plenty.

What with the advancing tide of foul brood and "Isle of Wight" disease, our pleasant craft is sorely threatened. The B.B.J. these days teems with "In Memoriam" notices of defunct apiaries. In this happy land of good bee forage and excellent honey prices, disease is

unknown and starvation the only trouble that proves fatal to the bee people. But in this case the bee-keeper and not the bees should be singled out for treatment.—J. M. ELLIS, Ussie Valley, N.B.

#### SPRAYING CHARLOCK AND DISEASE.

[8119.] It may interest BEE JOURNAL readers to know that I have for about five or six years been spraying charlock (sometimes my own fields and sometimes my neighbours), and that to the best of my knowledge it has done no injury to my bees, of which I have about sixteen colonies. It is true I lose a few stocks (three this winter), but the spraying was done in June last. Spraying certainly robs the bees of much honey. If it is proved to do harm to the bees the spraying should be done in May before the charlock comes into bloom. I have thought that by putting "weed killer" on the paths of the garden I have lost numbers of bees, and I only did this once, preferring to salt the ground round the hives. This answers my purpose and does not seem to hurt the bees.—J. M. STEPHENS, Herefordshire.

[8120.] I think most bee-keepers will agree with Mr. Desmond (8116, page 115) that a referendum should be taken of those concerned, in order to discover the cause of the outbreak of what is known as the "Isle of Wight" disease, though personally I think bee-keepers themselves should voluntarily send in to the BEE JOURNAL those particulars, without depending upon the B.B.K.A., which would be put to a lot of trouble and expense which could be avoided. And, after all, it is the bee-keepers themselves who stand to lose most.

Unlike Mr. Desmond, I am fully convinced that spraying with sulphate of copper is the cause, and that the bees die of a poison which causes paralysis, a well-known symptom of the "disease."

Until last summer, spraying had never been done in this district, so far as I can discover; and when I saw it being started I felt certain what would follow, though older bee-keepers, to whom I mentioned it, seemed to think differently.

Now, since the bees were packed down last September, over thirty stocks have died in what might be called the Itchingfield District, which is under two square miles in extent, and all around us we hear the same tale. A large proportion of the colonies still alive were driven bees, fed up with syrup last autumn, and had not any natural stores in the hive.

It seems to me that if sowing poisoned corn is unlawful, spraying charlock should

be equally so; especially as the spraying is done just when the charlock is coming into bloom, when it is certain that the bees will visit it.—ARTHUR CHEAL, HORSHAM.

#### A CORRECTION.

[8121.] I am sorry that, through my not making myself plain perhaps, an erroneous idea has got about as to the very large profits I have made by my bees. It has been stated in the daily Press, in a report of Dr. Malden's address at the B.B.K.A. meeting, that I sold £240 worth of honey during 1906 *from my own apiary*. This was not the case, and I did not hear Dr. Malden make such a statement, or I should have corrected it at the time. There are several other bee-keepers in the Royston district, and I buy their honey, if of good quality, to sell in addition to what my own bees produce. In 1906 I did this and the market being good disposed of a considerable amount. I much regret to have unintentionally misled the members at the meeting in this respect. I was only trying to show that I had been very successful in selling all the honey I could get even in the best years. The past four seasons have been very bad, 1909 being an utter failure with me, and in 1910 I lost nearly all my 160 stocks, which is disastrous when one is wholly depending on the bees for a living as I am. I had no intention of saying anything when I went to the meeting, and I now wish I had not done so, as my neighbours are telling me that I ought to have made a fortune by now, and must be "well off," which unfortunately is a very long way from being true. I have lost nearly all my bees, and with them my livelihood, as at 64 years of age I am too old to start anything else. I hope you will insert this correction in the BEE JOURNAL. I merely said that I sold in 1906 about £240 worth of honey and did not say that it was from my own apiary, on increasing which I have spent nearly the whole of the profits made, only to lose all within a few months.—W. JARMAN, Royston.

#### THE B.B.K.A. CONVERSAZIONE.

[8122.] It was rather unfortunate that the order of proceedings at the B.B.K.A. Conversazione should have been altered, as many of those who had to leave early to catch their trains were unable to see anything of the cinematograph entertainment. Had the original order been adhered to, it would have been possible even for those having some distance to go to have both seen the cinematograph and also to have heard Dr. Malden's paper,



only missing part of the discussion which followed, of which a very good idea might have been obtained by reading the printed report in the B.B.J.

I had brought a young friend with me, who is anxious to begin bee-keeping on his own account, and the pictures would have been much more interesting to him than the technicalities of the "I. of W." disease, but we were obliged to leave without seeing anything of them.

I beg to suggest that, in future, those subjects (where there is anything to be shown, such as pictures, specimens, appliances, etc.) which cannot be adequately described in print, be taken first, especially such as are unlikely to give rise to any lengthy discussion, and that no one subject should occupy more than an hour, each speaker after the first being limited to from five to ten minutes or less as the chairman may determine.

In this way nearly everybody would be able to hear something of more than one subject, and those obliged to leave before the end would miss nothing but what they could see a good account of in the B.B.J.

*"Isle of Wight" Disease.*—Am I right in assuming that this scourge has destroyed every hive-bee in the island, and that bees cannot be re-introduced there? If so I take it the Isle of Wight has been beelless as far as the hive-bee is concerned for two or three years. It would be interesting to know how this has affected farmers and fruit-growers on the island with regard to the fertilisation of flowers and its effect on crops.—L. ILLINGWORTH.

[An endeavour is generally made at these meetings to take the most important subjects first and to consult the convenience of those who have been invited to read papers. It cannot be questioned that Dr. Malden's paper was of great importance to bee-keepers and many came long distances expressly for the purpose of hearing the matter discussed, and they had to return the same evening by train. Dr. Malden also had to get back to Cambridge, and when scientists are invited by the B.B.K.A. to address its members it would hardly be courteous to allow a cinematograph entertainment to take the precedence, for after all this is more of an amusement which can be seen at many of the electric theatres throughout the country. No, the island has never been without bees, and we have had reports from bee-keepers all the time. The value of bees in fertilisation is so well established, that any scarcity of them must be detrimental.—Ed.]

#### FOREIGN BEES AND DISEASE.

[8123.] I have just lost my bees through the "Isle of Wight" disease, and being a "back garden" town bee-keeper, char-

lock spraying, as a cause, can be counted out.

Having thought over the matter for some time past, I am convinced that the cause is one for which we have no one but ourselves to blame.

It is a well-known fact that human beings from more favoured climes cannot stand the climate of England. How many negroes do we find acclimatised in this country, for instance? And is it not logical to infer that the continued importation of Italian queens to this country, followed by the succession of bad seasons we have lately had, together with the cold, damp winters, have been largely to blame for the creation of this new plague? The constitution of the good old Black British Bee, through countless centuries strengthened to resist the rigours of our islands, has been seriously undermined by this unnatural propagation of an alien species, and, like the introduction of rabbits in Australia, and thistles in California—the dread results are with us and are likely to remain.

I should like to sound this note of warning to fellow bee-brethren if it be not already too late: Let us have no more foreign blood introduced; opinions as to its advantage from the honey harvest point of view are about equally divided, and it is at least possible that your humble servant has not understated his case against this more handsome race of bees.—A. SCHOFIELD, Beckenham.

---

#### SPECIAL NOTICE.

Next week a leaflet will be inserted in every Journal, and we shall esteem it a favour if each one of our readers will help to increase the circulation by placing this in the hands of a bee-keeping friend, or one interested in bees, who is not already a reader.

---

#### AMERICAN AND COLONIAL PAPERS.

EXTRACTS AND COMMENTS.

By D. M. Macdonald, Banff.

*University Classes.*—Syracuse University, New York State, proposes to give a short apicultural course early in May. The lectures will be followed by demonstrations of the actual manipulations required in the treatment of bees and bee diseases. *Gleanings* expresses approval of this movement, and congratulates the bee-keepers of the State on this advance in apicultural instruction.

*Enlightened Bee-keepers.*—An effort is being made in Michigan to get a new foul brood law passed, and the most extensive bee-keepers of the State are foremost in the movement, pleading for "very stringent measures to stamp out disease." One of the very largest bee-keepers writes: "Remember, brother bee-keepers of Michigan, we are depending upon *you*, and *you* alone, to get this measure through."

How very differently do these Princes of Beedom view the subject from some of our so-called extensive bee-keepers in this country! (And, N.B., the proposed Act contains "disinfection.") Another extensive bee-keeper and F.B. inspector, writes: "We use the McEvoy treatment entirely, and also require disinfection of hives by burning them out." He further adds: "Black bees prevailed in these small apiaries, yet where the work was faithfully performed I know of no failure in the cure." Yet another 1,000 colony man writes: "Hip! hip! hurrah! Vermont at last has a Foul Brood Bill. If the big bee-keepers of Australia, New Zealand, Canada, and the United States, rejoice over the passing of effective repressive measures, why should our big men moan and groan over the very mention of a Bill? On second thoughts, I must retract that statement, or rather modify or qualify it by saying some extensive bee-keepers, because I know personally, that many of our leading apiarists are enthusiastically in favour of legislation.

*Old Combs.*—Some good bee-keepers believe in regularly renewing their combs, mainly to prevent the spread of disease, but some do so fearing that the constant shredding of the larval cocoons will, in course of time, contract the area of the cell, and so bring about a lessening of the life of the young bees. Many who have old combs can take comfort from the following, from Dr. Miller: "I will be a bee-keeper fifty years next summer, and I never yet melted a comb because it was old."

*Enthusiasm.*—Here is that "young man of ninety years," the sage of Marengo, as enthusiastic as ever, singing the praises of bee-keeping. A bee-keeper's life never becomes monotonous. He is enjoying life every day as he goes along. The pursuit is a healthy one. It is a "home" business, carried on in the centre of the family circle. It lengthens the span of a man's life, and, moreover, lengthens the span of his *efficiency*. This last idea pleases me well! "Age is not much of a handicap in bee-keeping. My largest crop of honey was harvested when I was seventy-seven years old." We will hope a yet larger crop will be the good Doctor's reward in this year of grace, when he will be eighty! Riches may not always be the bee-keeper's reward, but here is something better—A long life and a happy one!

*A Nonagenarian!*—Mr. John Cline, Wisconsin, has the reputation of being the oldest bee-keeper, having had bees for eighty-six years. He harvested over 1000 lb. of comb honey last season. He

reads three bee papers, and adds, "I can't do without them."

*Swarm Control.*—Mr. Hand, in *Review*, distinguishes between swarm prevention and swarm control. The former, he maintains, "exists only in the minds of brainless philosophers." His system of swarm control secures the end by "forestalling the event by substituting the artificial for the natural." In fact, it is "shook swarming" without the shaking. He contends that he saves labour, saves bees, and saves brood; all this the new system means to bee-keeping. And then, after dangling all this aggravatingly before our eyes, he proceeds to inform us that the equipment can only be had "through his regular authorised agents."

*Buying or "Raising" Bees.*—Mr. Hutchinson reports that he increased forty colonies by 136 per cent., and that his results paid him better than if he had purchased more bees. If a colony is worth \$5 it figures out about as follows: Hive, \$1; Queen purchased, 75 cents; food, 75 cents; foundation, 50 cents; total, \$3. He does not see why even a large apiary should not be thus dealt with, and pay in even an average year.

*A Lively Imagination.*—A writer from this country makes the astounding assertion that Italians are less inclined to "resort to the fluids excreted by aphides, to damaged fruits, &c., than the black bees. No wonder Dr. Miller writes: "That's new. I wish the proof had been given." I looked up the reference, and was pleased to note that even the writer has doubts of his own "theory," and has the grace to add that with increase of knowledge even the *theory* "may require considerable modification." A little knowledge is a dangerous thing!

*A Winter Brood Nest.*—A rather interesting discussion has been going on for some time, dealing with this feature of successful wintering. Messrs. McEvoy and Byer, both of Canada, maintain that if bees are placed on solid blocks of sealed combs they will winter safely. Mr. Root, on the contrary, contends that a certain part of the lower half of combs in the centre of the brood nest should have vacant cells. We, in this country, favour this space, believing as we do, that this area forms the ideal clustering ground of the oval-shaped ball the bees instinctively form themselves into on the approach of zero weather. There is thus no severing of the solid phalanx as would result if one or more cold solid combs of sealed stores cut it into divided sections. Every cell will have a bee lying in semi-repose, with its head almost touching three bees on the other side of the comb in contiguous cells. This double layer is

protected by a clinging mass of bees in the space between each frame, rising up to the top of the cleared space, in order that all may be in direct or indirect contact with the fountain of life contained in the sealed cells wherein the nectar is stored. When feeding up driven bees I always like to re-arrange the combs, if all are solid slabs of honey after heavy, rapid feeding, and I would like to feel that they have such a space when winter packed as would show, say, three frames, with empty cells in the lower third of each frame.

## Queries and Replies.

[4110] *Storing honey in barrels. Super-clearers.* I beg once again to ask the aid of your knowledge and advice on the following points. (1) Is there any evidence of the enclosed bees having died of "Isle of Wight" disease? They were taken from two stocks I bought three weeks ago, but the owner has, I find, had one or two stocks die recently. If these are affected, have I time to stop infection spreading to my other colonies? (2) Would you also kindly state whether casks or barrels are ever used by honey producers or wholesalers for carrying or storing honey? (3) Is it usual for commercial bee-keepers for use, say one to each hive? Or do they use the same for only certain hives taking super (bees included) to the bee-house, and there brushing bees off combs? (4) Do you know of any bee-keeper having used "Galvanit" to re-tin a honey ripener or can, or an extractor? I thought of experimenting with same on the bottom inside of my extractor. With many thanks and good wishes—A SMALLHOLDER, Stockbridge.

REPLY. (1) There are signs of "Isle of Wight" disease in the bees, destroy bees, all combs and internal fittings of the hive at once, and disinfect it. (2) These are used frequently abroad but not often in this country. They should be painted inside with melted beeswax first to prevent tainting the honey. (3) All supers should be cleared while on the hive with a Porter escape. To do as you suggest might induce robbing. An average of one escape to three hives will be ample. (4) We have no experience of this process.

[4111.] *Obtaining Drawn-out Combs.*—As I am a reader of the "British Bee Journal" I should like to ask you a question about a subject of which I am in doubt. If I place a frame with foundation in a hive containing drawn-out combs the result is an irregular comb. It states in the "Guide Book" that on no account should built-out combs be alternated with sheets of foundation, or the result will be irregular combs. Taking this into account

by what process can I obtain built-out combs from foundation without them being irregularly constructed?—CAKE, Belvedere.

REPLY.—If you read the "Guide Book" carefully you will see that in spring straight combs can be obtained by putting sheets of foundation between drawn combs, as at that time the bees are desirous to build comb. In autumn (and this is the part you have read) the opposite is the case; the bees then store food in the combs already built, and for this purpose will elongate the cells in preference to building new combs. Refer to pages 24, 25, and 151 of "Guide Book," when you will see the instructions you have read are for dealing with driven bees.

[4112] *Making W.B.C. Hives.* I shall be grateful if you will kindly answer the following questions: (1) I am going to make some W.B.C. hives: which wood is the best for the purpose, red deal or ordinary pitch-pine? (2) How thick should the wood be if the hives are to be double-walled? (3) What is best material for covering the hive-roofs, sheet zinc or calico painted? (4) Is there anything to prevent the tin honey-extractor rusting while not in use? (5) As I am going to form a nucleus, where should I place it, near the parent stock or close to the stock which is to be re-queened when the proper time comes? (6) Where is the best place to keep foundation until required? I am a beginner, having started with one stock of natives last spring which gave 32lbs. of extracted honey, and is evidently doing very well now judging by the amount of pollen and water the bees have been carrying in. I find the "B.B.J." a veritable boon to me, and always look forward to receiving it every Friday. I also have the "Guide Book" and "Note-Book," both of which I find very useful for reference.—C. C., Stourbridge.

REPLY.—(1) Yellow pine is the best wood on account of its freedom from knots. (2) At least  $\frac{1}{2}$  in. thick. (3) Calico painted, as it does not get so hot. (4) Immediately after the extractor is done with well wash in hot water, dry it before a fire and rub with a vaseline cloth. (5) About a couple of yards away from the colony to which the nucleus is going to be united. (6) Keep it in a dry warm place. As you have the "Note-Book" you will see that the thickness of the wood is given for all parts of the W.B.C. hive. Many thanks for your appreciation of the Journal, we are glad it is a help to you.

[4113.] *A Novice's Queries.*—Kindly reply to the following questions. (1) Are bees total abstainers because they will not touch stale beer as wasps and flies do? (2) We buy 1lb. jars that have been used for jam. The weight of honey they can hold is more than a pound in each jar: is

it a great waste of honey. (3) Where can we get 1 or 2 oz. jars suitable for samples, and state price. (4) How can the bees work in dark hives that have no windows, and why don't they go out in the night? (5) I see in the paper entitled "How long animals live," the life of a queen bee is one or two years. Is this correct? (6) Which is the best sort of willow to plant for the bees?—W. H. (Cambridge).

REPLY.—(1) Bees are clean feeding creatures, wasps and flies are carnivorous and act as scavengers, hence the former's objection to stale beer. (2) The question is not quite clear. If for home use there is no waste, but if sold as a pound of honey then you are not wasting, but giving it away. To prevent robbing yourself, weigh the jar first, and then charge for the actual weight of honey put in. (3) Write to the dealers who advertise in our columns, no doubt they will be able to supply you. (4) The hives are not totally dark, also by means of the antennae the bee can find its way about inside the hive by the sense of touch. The temperature is too low as a rule for bees to fly at night, and also you must know that the majority of flowers close up at sun down. (5) The queen in a natural state lives about five years. (6) The ordinary willow (*Salix caprea*), which produces pollen in abundance.

## Notices to Correspondents.

(Mrs.) J. (Winchester).—*Bees Dying*.—The bees have apparently dwindled through the queen being too old. Melt the combs down for wax, and start with full sheets of foundation in clean frames.

### *Suspected Disease.*

A. F. B. (Bexhill).—The bees appear to be suffering from "Isle of Wight" disease. Destroy the stock at once, burn combs and all internal fittings and scorch out the hive as if disinfecting for foul brood.

C. T. (Ashford).—If you will send on a few live bees from the affected hives we shall be better able to say what is the matter with them.

W. M. P. (Enfield).—We regret to say that the bees show every sign of "Isle of Wight" disease.

F. T. (Eadworth).—We cannot find any trace of "Isle of Wight" disease. It is evidently a case of spring dwindling.

ANXIOUS (Four Oaks).—The bees have dysentery; there are also signs of "Isle of Wight" disease. On no account must you use the combs or food for other stocks. Best destroy these and disinfect the hive as for foul brood. It can then be used again.

H. G. G. (Farnborough).—The bees were too dry for us to say if they died of disease. So far as we can judge starvation was the cause of death. Please note change of address.

WARWICKSHIRE READER (Hockley Heath).—Your supposition is right, the bees have dwindled, and want of warmth has prevented them moving to the food. They have consequently succumbed to starvation.

J. G. S. H. (Ashbourne).—The bees were so crushed in post through bad packing that we could do nothing with them. They should have been enclosed in a tin box.

(Several letters, &c., are in type, but are unavoidably held over till next week.)

## Special Prepaid Advertisements.

### SPECIAL NOTICE.

The prices of advertisements in "Special Prepaid" Column have been revised, and are now as follows:—

**Two Words One Penny, minimum Sixpence.**

Orders for three or more consecutive insertions entitle advertisers to one insertion in "The Beekeepers' Record" free of charge.

Trade advertisements of Bees, Honey, Queens, and Bee goods are not admissible at above rate, but will be inserted at 1d. per word as "Business" Announcements, immediately under the Private Advertisements. Advertisements of Hive-manufacturers can only be inserted at a minimum charge of 3s. per  $\frac{1}{2}$  in., or 5s. per inch.

## PRIVATE ADVERTISEMENTS.

WANTED, GOOD HONEY EXTRACTOR.—Particulars and price to RAYMOND PENNY, Knowls, Taunton. h 18

HONEY. One 28lb. tin to spare, 8d. lb. WAIN, 18 Thorpe Bank, Wainfleet. h 19

4 GOOD SKEPS BEES, 15s. each.—A. J. PHILLIPS, 23 Albert-street, Stevenage, Herts. h 20

WHAT OFFERS? 3 bound volumes of "B.B.J.," 1887, '88, '89.—CADMAN, corn merchant, Ilay. h 21

WANTED, EXTRACTOR, LAMP, UNCAP-PING KNIVES, in good condition.—MISS GORDON, Wethersfield-place, Braintree, Essex. h 22

LADY BEEKEEPER OFFERS BOARD; simple life, lovely country.—McPHERSON, Bredons Norton, Worcestershire. h 23

TWO STRONG STOCKS FOR SALE, with rack sections, 25s. each.—HALL, 230 High-street, Rochester, Kent. h 14

WANTED, 2 or 3 cwt. LIGHT ENGLISH HONEY; price with sample.—R. CARTEK, Chartridge, Chesham, Bucks. h 15

20 HIVES, including standard frames, 5s. each for 10 or 16 frames; also 4 Ford Wells, 8s. each, with plenty of lift, newly painted, only safe and sound goods forwarded; can be seen at 3 Gladstone Cottages, Norwood Green, Southall.—Address, P. HANSEN, gardener and bee expert, 59 Castlebar-road, Ealing, Middlesex. (h 16

SALE OR EXCHANGE, SEVERAL WELL-MADE HIVES; guaranteed sound and healthy.—ASTON, Powick, Worcester.

WANTED, SEVERAL STOCKS OF BEES; state number and full particulars.—WEBB, Broomfield Gardens, Sunningdale, Berks. h 26

## Editorial, Notices, &c

### THE "ISLE OF WIGHT" DISEASE.

Now that the prevalence of this disease has been brought so prominently forward by the British Bee-keepers' Association, it is desirable that bee-keepers throughout the country should co-operate for the purpose of obtaining such information as may lead to a better knowledge of the cause of the great mortality among bees. When this knowledge has been gained we have no doubt that means will be devised for either checking the spread of the disease or of efficiently curing affected colonies. Although the Board of Agriculture have had the matter under investigation for some time, much more information is needed before any conclusion can be arrived at or recommendations made. Dr. Malden has asked the B.B.K.A. to appoint a committee to assist him in collecting more information and to be of any use we must have the co-operation of bee-keepers in obtaining it. The question is a national one, as it not only affects bee-keepers, but fruit growers as well; we would therefore ask to have such particulars sent to us as Dr. Malden asks for on pages 132-3, and we will properly tabulate them so that they may be available for reference. As there appears to be some idea that the mortality may be due to poisoning owing to charlock spraying, full particulars should be given as to when it first commenced among the bees, and whether it was before or after the spraying. So far chemical examination of the bodies of large numbers of diseased bees has failed to show the presence of either arsenic or copper. It is, however, a matter that could easily be decided, and no doubt some of the Agricultural Colleges would undertake it if asked to do so by the proper authorities. We would therefore ask our readers to help in the way we have suggested so that progress may be reported during the coming season, and some solution of the trouble discovered.

### BRITISH BEE-KEEPERS' ASSOCIATION

#### THE CONVERSAZIONE.

(Continued from page 125).

Cultivations from the chyle stomach of the affected bees frequently showed no colonies, although numerous bacilli had been seen in the smears. In a very large number of instances some variety of the hay bacillus was present which grew so rapidly as to cover and obliterate all other bacteria. In only a very few instances was it possible to isolate the pestiform organism, which grew very slowly.

The cultural characters of the bacillus were fully described in my report to the

Board of Agriculture, and I will not here repeat them. In order to prove that a particular organism is the cause of a particular disease, it is essential that the organism must first be grown in pure culture and then by inoculation or feeding reproduce the disease in healthy specimens. Inoculations are, of course, out of the question in work on bees, and since the disease probably gains access to the body of the bee by the mouth, it was natural to expect that feeding experiments would prove whether the pestiform bacillus was capable of producing the disease in healthy bees. In this, however, the results have been negative, and so far the disease has not been reproduced by feeding healthy bees with syrup with which the bacilli had been mixed. So far also other infection experiments have given negative results. Infected bees, or at least bees from infected stocks, have been introduced into hives containing only healthy bees, but up to the present time it has not been found possible to introduce the disease by this method. A great deal more work is required before these points can be regarded as settled one way or another, and these experiments must be repeated because though the evidence seems to point strongly to the fact of the disease being an infection, so far the infection experiments have given negative results. If you carry out experiments in a neighbourhood where disease is already present, it would be folly, because the bees might introduce it in that way, and your results would be wrong. We have found that it is possible to keep bees in confinement in a building with a large muslin cage in front, and when fresh flowers are put there every day, they will live for upwards of a year, but it is not absolutely a normal condition, and it does not do to attach too much importance to an experiment of that nature.

On Monday, March 13th, 1911, I visited Mr. Walter Jarman, Royston, who told me that he had kept bees since 1885, and for the last ten years had been solely dependent on them for his living. The best year he had was in 1906, when he sold honey and wax to the value of £240. He had invested a good deal of money in hives and appliances and tried so far as he could to have everything as perfect as possible. He painted his hives every spring and kept them clean; they were all modern box hives, well made and warm. He had only twice been troubled with foul brood, which was introduced by foreign combs, but had easily got rid of that complaint. In June, 1910, he had 160 hives in his apiary, which was situated close to his house. He had thought that his stocks looked stronger and better than they had ever done before, and he

quite contemplated getting a good honey harvest after three rather bad years. About the middle of June he noticed that the bees from one of his strongest and best hives were dropping on the grass in front of it, and were unable to fly off the ground. On opening the hive the brood was plentiful and seemed healthy, and there were plenty of stores. The bees continued to die off rapidly and were all dead by September. About one month after, that is the middle of July, the next hive to the one first affected showed signs of the disease; there had been no robbing that he could detect from the first hive. All the bees were dead by September. At the latter end of July a third hive, situated some distance from the first two, began to be affected, and in a few days a fourth, not very far off, also developed the disease. From the middle of August the disease spread rapidly, first affecting the hives nearest to those that were originally infected, and a good deal of robbing now went on, and was impossible to prevent. By the end of October fifty hives had gone, and the disease continued to spread all through the winter, so that now he has less than thirty remaining, and several of these show signs of being affected. The nearest apiary in which disease had appeared before his own began to suffer is situated about  $1\frac{3}{4}$  miles from his house. He had imported no outside stocks or queens, all his appliances were new, and he never used frames or sections a second time. Mr. Jarman has no doubt in his own mind that the disease is an infectious one, and was either introduced from the apiary,  $1\frac{3}{4}$  miles away, or else, from the foundation wax which he used for his frames. He is of opinion that the young bees are affected very soon after emerging from their cells. He frequently noticed that batches of young bees on their first flight were unable to fly far, and frequently tried to enter other hives, and consequently were killed. He had never seen any appearances to make him think that the brood was affected, and the queens never showed any signs of the disease. His bees were almost entirely English, with only a very slight strain of Italian blood in them.

This tale of disaster, which has practically ruined a hard-working and previously successful bee-keeper, gives much ground for reflection. What has happened in this case has happened before in other parts of the country, and will assuredly happen again in any apiary to which this virulent pest gains access. Had this man burnt the first lot that showed sign of disease he might have escaped the great loss that has fallen on him. I say he might, I cannot say for

certain that he would have escaped, as we do not know the exact incubation period, or when a newly infected hive becomes capable of spreading the infection, but it is the only safe treatment to adopt, and the bee-keeper who trifles with sulphur or medicated syrups is lost.

There are two points in this little history that deserve notice:

(1) That the young bees appeared to be affected early, if not at the very beginning of the outbreak. This point has not, to my knowledge, been noted previously, and if it is a fact, it goes some way towards proving that the disease originates in the hive and is not conveyed to it by foraging bees, which was the explanation I had always considered the most probable. I hope all bee-keepers who are unfortunate enough to have outbreaks of the disease in their apiaries will make careful notes on this point.

(2) The theory that the disease may be introduced by means of infected foundation wax. This theory, on the face of it, seems to be extremely improbable, when the process of cleaning and preparing wax for foundations is enquired into.

I believe it is a fact that the impure wax, which has previously been melted into cakes, is subjected to the action of superheated steam. This, if continued long enough, would certainly destroy any germs, even spores, that were present in the wax. Experiences of other observers do not lend any support to this theory. In several instances swarms have entered hives whose original inhabitants have died from this disease and made use of old combs, without contracting the complaint. In some instances frames from infected hives have been placed in healthy ones without communicating the infection. To my mind, it requires most conclusive proof of the possibility of any germs escaping destruction in the process of purifying the wax before we can accept this as even a possible source of contamination.

I am now making some experiments with the crude wax, melted down from combs, and also with foundation wax, to see if there is any possibility of infectious germs being carried in this manner.

May I be allowed, in conclusion, to lay before the Association a few of the points on which more information is required, and ask for the co-operation of its members in obtaining it:

(1) Accurate information as to how the disease is introduced into an apiary. This is sometimes a most difficult matter to be sure of, and sometimes it is

quite impossible to be certain of how that introduction takes place; but a careful observation of the facts, coupled with our present knowledge of what has happened in other cases, will enable a bee-keeper to arrive at a reasonably fair conclusion.

- (2) Whether the disease appears first in the foraging bees or in the young ones before they have left the hive.
- (3) Whether the drones are affected. Information on this point is scanty, and it is desirable to know if the drones acquire the disease in the same way as the workers.
- (4) Whether there are any cases in which a stock has recovered after being affected by the disease. At present I have no recorded cases of complete recovery; in some there has been a partial recovery, but the complaint has eventually destroyed the entire stock.
- (5) Whether English or foreign bees appear most susceptible. It has been suggested by some bee-keepers that Italian or hybrid stocks are more resistant than the English, but the point is not quite clear.
- (6) Accurate observations as to the first appearance of the disease in different localities.
- (7) Information as to any remedial measures which have seemed to be of value in checking the complaint.
- (8) Information as to the incubation period of the disease—*i.e.*, how long an interval elapses after one hive is affected before a second one shows signs also.
- (9) Some method of collecting and tabulating information on these points, so as to make the information of practical value in adding to our knowledge.
- (10) Providing a supply of diseased bees for further bacteriological research.

The Chairman (Mr. Cowan) said they all felt very much indebted to Dr. Malden for addressing them on this subject; it was a most important one, and a serious matter to bee-keepers, because of the rapid spread of the disease. Dr. Malden had asked for information, and he would be pleased if there was anyone present who could help in this respect. He would like to ask Dr. Malden with regard to the brood, whether he understood him correctly that the brood was not affected, and if this was so whether it was safe to give the brood of a hive that has died out, or is dying out with this disease, to another colony, taking care not to give any of the affected adult bees.

Mr. Bullamore understood Dr. Malden to argue that the trouble could not be due to poisonous pollen or honeydew. Supposing, for instance, it is one of the plant parasites similar to bunt that attacks the pollen. When the bee gathered that it would be stored and used in every

month of the year, because the bees use pollen all the while they are breeding. There had been a great increase of parasitic disease in plants owing to the bad weather, and if during a spell of fine weather the particular form of plant parasites that are produced by honeydew are prevalent, the bees would gather that in the absence of other nectar. That would be poisonous, when it got into the stomach, if absorbed by the bee. If they looked into the history of bee-keeping, they would find that whenever there were spells of bad weather, this sort of trouble appeared. He found that in 1861 Mr. Woodbury stated that this form of dysentery in which the abdomen was distended was only too common, and was due to starvation or damp hives, and suggested that the bees had died of internal moisture. They never seemed to have bees die of starvation or internal moisture now, but it is generally put down to the Isle of Wight disease. He had hunted up some five or six cases himself, and when he had got genuine information about five of them he had found they all had food trouble. When the bowel contents are examined, one finds, in addition to pollen, a large amount of yeast, plants which should not be present in the bowel of properly fed bees. He thought that the whole difficulty in investigating the disease was because they thought it an infectious disease instead of a food trouble, and he would like the disease investigated from that standpoint.

Mr. Sander said that in the latter part of last summer his neighbour, who had only started bee-keeping that year, lost all her bees. She removed before Christmas, and he had taken her house, and about the 12th December he moved his bees into this next garden. He had at the time four strong, healthy stocks. Some time early in the year when he looked at one of the hives he found that the bees were all dead. A few weeks later, in February, he thought, to make sure that the bees had enough food, he would give them some candy. In the first hive he opened he found the bees were all dead. The other two were alive and he gave them candy. Since then there was a suspicious quietness about the hives, and the other day—last Saturday week—he opened them and found they were quite cold inside and the bees dead. That seemed to point to the fact that it was the site that developed the disease, as in the garden next door they had been perfectly healthy. They were warmly protected, and the hives were full of stores, so that they could not have died of starvation. Nevertheless the fact remains that they all died.

Mr. Paul said his experience was similar to that of Mr. Sander. He had three stocks, and about the middle of December he found the bees crawling about outside

on the ground, and a great number of them died. He sent some up to the "British Bee Journal" and got the answer too familiar to most of them, that it was evident they had the Isle of Wight disease. Very shortly afterwards he found two stocks had died out, and the third stock appeared to be all right, but a few days ago, seeing some of the bees crawling about on the ground, he opened this and found the bees reduced to a mere handful, so he had lost almost all his bees. His apiary was about a quarter of a mile away from Mr. Sander, so the disease was in the district.

Mr. Toms said in his experience he found the disease occurred about the beginning of July. He had five hives, and noticed one day that some of the bees were crawling about on the ground, but as there had been a good deal of rain, he thought that they had been beaten down by it, and took no further notice for a few days. A few days later he found a great many more crawling about, and since then all the colonies had died out. The young bees were attacked, and it was a pitiable sight to see thousands of young bees unable to rise from the ground. The colonies were all in good condition, and the bees were descendants of those he had in his apiary for years and they were not imported or foreign bees, and as far as he could see there was no reason for them to get the disease from surroundings. At the end of September he got two lots of driven bees and put them into hives with combs from which the bees had died, and he was anxiously waiting to see whether the bees will emerge and get the disease from these combs and hives or not. He sincerely hoped that Dr. Malden would find some remedy, so that they would be able to overcome this disease.

A question was here sent up asking, "Have experiments been tried with bees in hives constructed of material other than wood or straw?"

Rev. Downes-Shaw said it was extraordinary how this disease seemed to jump about over intervening parts of the country. He believed that it was in the South of Cambridgeshire, and he had heard of no case in the North, but last year one of their most successful bee-keepers—a man who took prizes at most of the shows—lost nearly all his apiary. This disease had jumped right into Norfolk. Of course the question was why did it jump across these tracts of country, and the only reply he could find was that people were in the habit of buying honey and wax from all parts of the country, and in this way they have probably brought the disease in the honey. He did not know, but this seemed a plausible reason why the disease got right into their midst. If it was anything to do with the flowers why

did not his bees have it, but he had had no case in his apiary. When they got to Massingham the bee-keepers there say nearly every stock was swept out.

Mr. Crawshaw asked Dr. Malden if it was found that continuous culture had been effective, and if so what medium was found to be the best? Whether diluted honey would be possible or suitable as a medium? He rather gathered that he adduced the inability of the bees to fly to a kind of paralysis of the muscles. He would like to know how he reconciled this with the fœces of the bees in the hive.

One of the audience here mentioned that in 1907 the disease broke out at Albury Heath, near Guildford, where 32 out of 35 stocks were lost. In the same year about one hundred stocks perished in a corner of Bucks and Herts.

Mr. Herrod asked Dr. Malden if ever he had found queens affected.

Another speaker believed the disease was due to pollen poisoning. It broke out early in June in his locality when bees were gathering from wild mustard, and again in the autumn when working on cultivated mustard. In bad cases he had found a small number of the larvæ affected. Dr. Malden had said that the bee-keeper who trifled with sulphur was lost, but he had found this the only thing that had been of the slightest use.

Mr. Kidd thought that if they had to theorise it seemed to him that the outbreak in the Isle of Wight might be due to foreign honey, and he would suggest that investigations be made in foreign countries where the honey comes from and see if any disease in the bees could be traced. This will help them in the matter.

Mr. Reid said Dr. Malden had given them some very interesting information, and he thought they were naturally bound to give him any scraps of knowledge gained in their apiaries.

It is, of course, most important, if they could possibly trace the origin of the disease. He got it into his apiary and lost all his bees in about two weeks. He believed it came to him from the Woking direction, because he traced the apiary that was infected next to his, and at Woking three or four years ago there was a case in the apiary of one of their own members who was present. It seems that the infection was first at Maybury, then it came to Addlestone, and there all the bees have died. He had tried various remedies, and the only thing that he had found of any use in prolonging the life of the bees was Bulgarian sour milk. Using it regularly in the household he had it fresh every day, and he gave it to the bees with diluted honey. The two colonies that were not treated in this way died very soon, but the other four hives he kept all



the autumn. They were weak when they went into winter quarters, but by degrees, as he had not time to persevere with the feeding, the last lot died out. He did not know whether this was a remedy which might be utilised; but at all events there was partial success with it, and if he had had more time to devote to it he might have carried it out with more success. It would be worth while for others who have time to try it, but it is only a remedy, and not a cure. He was quite sure his bees did not get their disease from mustard because there was none in his district. He did not think it had anything to do with the flora because they had the disease in patches, only in certain places, and you must either trace it in having been brought by foreign honey into this country or otherwise by means of bees and swarms. It is most difficult to say how the disease (in these days of rapid transit) is carried. They lived under different conditions from their forefathers, and thought nothing of sending bees and bee-products from country to country, or from one part of the country to another, and if they could prevent the introduction of foreign bees and bee-products he thought they would have a better chance of keeping their stocks alive.

(Concluded next week).

## AMONG THE BEES.

### BEE-KEEPING IN NEW ZEALAND.

By D. M. Macdonald, Banff.

*The Genesis of the Industry.*—Just about seventy years ago the first Bishop of New Zealand left our shores and with him as his chaplain went the Rev. W. C. Cotton, author of "My Bee Book." An enthusiastic bee-keeper at home he determined to carry with him some hives of bees, being encouraged thereto by a statement in one of the earliest works published on the Colony, wherein is recorded that "many of the flowers abound with honey." Mr. Cotton determined "to make a good try at bringing it to pass that bees should be established there," and so he able to confer on the natives and colonists the pleasure and profits of having bees of their own. A true patriot, he believed that "the bee of England like the man of England is surpassed by none in the world," and so he determined to have nothing to do with bees from India, America, or New Holland, but to carry with him over the 6,000 miles of ocean the genuine home product. In his "Bee Book" he gives us a lucid description of his mode of procedure in preparing them for the lengthy journey. In order that he might accomplish his purpose with at least a measure of success he had several alternative schemes. If one went wrong the other might succeed. Even at that early

date, the Rev. Mr. Cotton made a resolution that bee-keeping should be inaugurated in the Colony on "the no killing way."

*A Languishing Industry.*—Let me give just another kaleidoscopic glance at the industry after a period of nearly fifty years. With so fine a climate as the greater part of New Zealand is blessed with and such a wealth of bee flora as is seldom met with anywhere else one would imagine the industry would advance by leaps and bounds. Unfortunately, ignorance of the habits and requirements of *Apis Mellifica*, the lack of interest in the industry, the faulty homes of the honey-bees used, the scant demand for the produce, and the difficulty of packing, forwarding, and disposing of surplus, hindered its rapid development. Few, too, appreciated the value of the industry, and bees were scarcely to be purchased for love or money. Then, more unfortunately still, when some began importing, foul brood was introduced. With that the woes of the antipodean apiarist began. Box hives and log gums were the favourite form of hives for a long time. Eventually, however, frame hives became more common, and now these only are authoritatively recognised as legal bee-domiciles. The act automatically drives out the ignorant and careless, leaving only the men who adopt up-to-date appliances. Each man before this period was a law unto himself, and consequently the industry could not prosper. Indeed, it languished almost to the point of utter extinction.

*A Rising Industry.*—Several pioneers battled against the severe handicap, some even starting anew repeatedly after their apiaries had been devastated. One man deserves special mention for the part he took in the good work of rejuvenating apiculture, viz., Mr. Isaac Hopkins, who afterwards became Government Apiculturist, a position from which he retired only last year. The restoration of the industry may be largely ascribed to his untiring efforts. Another power for good was the fact that the New Zealand Department of Agriculture considered bee-culture worthy of recognition. They now run two State apiaries, one a model apiary (the illustration in recent Bulletin would lead one to conclude that it really deserves its name), at Ruakura, and a queen-rearing apiary at Waerenga. The Department issued last year an excellent Bulletin, the former one of 35,000 copies being exhausted. It deals with every phase of the industry, and is a most informative compilation. The State also supports a "Cadet" department in their model apiary, where young people of either sex may engage in a course of instruction, with an opportunity of gaining a certificate at the conclusion of their course. Further, these apiaries are open

to all persons desiring instruction. Ladies, it is pleasing to record, take "an active part in actual work, even putting together and painting the hives, making the frames, and doing everything necessary on a bee-farm." A lady, a first-class expert of the B.B.K.A., and an ex-student of Swanley College, is in charge of the model apiary.

*A Paying Industry.*—The fact that the Department of Agriculture took bee-keeping under its regis put new life and energy into the industry, but nothing could have made it so prosperous as it now is if the authorities had not wisely passed "The Apiaries Act"—the most efficient for dealing with foul brood in the world. Two of the most commendable features of this Act are—1st: Frame hives only are recognised as fit domiciles for bees. 2nd: Disease where it makes itself manifest is stamped out thoroughly, and drastic disinfection follows every attempt at a cure. Clover is the staple source of nectar supply, and yields the finest honey, but "bush" honey is abundant over a wide area and supplies the largest surplus takes. Mr. Hopkins advises that bee-keeping should be carried on in combination with some other industry, and he instances fruit-growing and poultry-farming as the most suitable to associate with it. A few extensive apiaries are found, one consisting of nearly 1,000 hives, and the owner claims to turn out 33 tons of honey annually, finding a ready sale for it, at a satisfactory figure. Intending emigrants could get information about the best locations from the Government Apiarist, Wellington, or the High Commissioner, London.

*The Future of the Industry.*—With the suppression of the box-hive, the curbing or destruction of disease, and the enlightened aid of the Department of Agriculture in fostering, extending, and encouraging bee-keepers, the industry has every prospect of a bright future in the Dominion. In many parts the climate is as fine as any in the world, bee-flora is abundant, and honey of a fine quality can be produced. The trained cadets will yearly spread over the length and breadth of both islands and disseminate a knowledge of the practice of apiculture at its best. The fine queens turned out from the Government queen-rearing apiary, must greatly improve the stock and gradually "leaven" the entire race.

The good ship "Tomatin" arrived in New Zealand just seventy years ago almost to a day. That was the day of small things. Mr. Cotton's "four stocks of bees" is now represented by a large army numbering many thousands. I would prophesy that the industry is only in its infancy and that it will yet make great and giant strides in New Zealand, a land so highly favoured climatically for the successful prosecution of our industry.

## Correspondence.

*The Editors do not hold themselves responsible for the opinions expressed by correspondents. No notice will be taken of anonymous communications, and correspondents are requested to write on one side of the paper only and give their real names and addresses, not necessarily for publication, but as a guarantee of good faith. Illustrations should be drawn on separate pieces of paper. We do not undertake to return rejected communications.*

### CHARLOCK SPRAYING AND DISEASE.

[8124.] I have read with great interest the correspondence which has appeared in the B.B.J. on the subject of the "Isle of Wight" disease, and especially the first part of Dr. Malden's address, published in the issue of March 30th.

There is one definite hypothesis put forward of the origin of the disease, and that is the spraying of charlock. Whether there is any likelihood of this hypothesis being a correct one, I am not in a position to say, but unless the attribution of the disease to the spraying of charlock is altogether absurd, what I wish to ask you is, what steps is it proposed to take to test the only definite theory which has hitherto been propounded? It would surely be the greatest folly, in view of the enormous damage caused by the disease, to let another season pass without carrying out some experiments to ascertain whether the theory is correct or not. It would not require much ingenuity, to my mind, to devise some means by which some stocks of bees could be allowed access to charlock sprayed with sulphate of copper, and others denied access to it, the forage being in other respects the same. Let such an experiment be repeated two or three times, and there can be no further doubt for ever after whether the "Isle of Wight" disease is caused by the spraying of charlock or not.

Dr. Malden, throughout his address (and especially in a paragraph printed on p. 122 where he speaks of "any cause save infection"), would appear to assume that if the disease is caused by infection it cannot be caused by anything else. But why not? I criticise with all deference, being neither a bacteriologist nor even a very proficient or experienced bee-keeper; but to my lay mind there seems to be nothing impossible in the conjecture that the disease may originate with the poisoned charlock in the first instance, and may afterwards be conveyed from bee to bee. Should this be a true account of the case, neither can Mr. Schofield (B. B. J., March 30th, p. 127) be sure that the loss of his bees was not due, ultimately, to the spraying; nor can the back-garden bee-keepers men-

tioned by Mr. Drew (B. B. J., March 16th, p. 106) count with certainty on the immunity which they have hitherto enjoyed.

I most heartily agree with Mr. Desmond (p. 115) and Mr. Cheal (p. 126) that all possible information on the subject should be obtained and examined. Was the charlock spraying practised for the first time in the Isle of Wight in 1904, or for the first time in 1908 in that portion of North Wales marked with a cross in the map accompanying the report of Dr. Malden's address? Supposing the answers to these two questions were in the affirmative, they would constitute the strongest presumptive evidence that spraying is the cause of the disease. The answers cannot be difficult to obtain: surely, then, it is our duty to obtain them.

Mr. Stephens' letter (Journal, March 30th, p. 126) is not conclusive. He says he loses a few stocks, but he does not tell us if he has noticed the symptoms of "Isle of Wight" disease.

It may be that charlock-spraying has been carried on in some cases without the bees taking any harm. But we must not conclude from that that it may not be the cause in other cases. Bees may be visiting other flowers, and not the sprayed charlock. Or again, it might be a matter of degree. A little poison is often innocuous where much is fatal. That is why, in any experiment, the bees must be carefully watched to see that they visit the poisoned flowers, and the sulphate of copper must be applied in varying quantities.

As to the experiments I suggested, let me say that I for one would be very glad to subscribe to a fund devoted to the purpose of having them carried out. I must confess to a feeling of irritation when I read so many unverified surmises in the Journal, and so few statements based on reliable evidence. We need more data, better sifted; that is certain; probably more open-air experiment, carefully carried out; and of laboratory research it is, of course, impossible to have too much.—H. BALFOUR GARDINER.

[Up to the present, chemical examination of diseased bees has failed to show the presence of poison, but we hope a thorough investigation, as suggested by our correspondent, will be made with a view to determining whether spraying has anything to do with the mischief. We certainly need more data, based on reliable evidence, and this is what the Board of Agriculture are endeavouring to obtain.—Ed.]

#### NOTES BY THE WAY.

[8125] The month of March has sustained its character for varied weather,

rough and cold days predominating. How have the bees fared during this cold spell? There have been but few days on which they could leave their hives in search of the needful pollen and water; those bee-keepers who have taken the trouble to provide a constant supply of both in a sheltered spot near the hives, especially where a large number of hives are kept, will be amply repaid by the flourishing condition of their stocks. Small apiaries can generally find sufficient natural pollen and do not require any substitute. There has not been a day during the month when hives could be examined with safety to the brood, and so I have continued to feed candy and some thin syrup in the open, when the weather has been warm enough for the bees to be about. "Is the 'Isle of Wight' disease infectious?" asks Mr. Bullamore. I have a letter from a gentleman in Scotland, living some 30 miles from Glasgow, who writes, "In June, 1909, I purchased a swarm from Surrey and hived the bees on foundation in the usual way. Soon afterwards I noticed something was wrong with them, some were crawling about on the alighting board and others up the legs of the hive; remedies were tried, but the stock died and also twelve others out of the fourteen comprising the apiary. The remaining two stocks died during the winter of 1910." This occurred some 300 miles north of the source of contagion or infection and is proof enough for me that this swarm carried the disease with them, and that the healthy stocks in the apiary were infected by this means, as the nearest apiary was three miles distant in a bee-line, and there have been no losses amongst other bee-keepers in that district.

I notice in report of British Bee-keepers' Association meeting that the bees at the Association's apiary have nearly all perished from the "Isle of Wight" disease. Can Mr. Herrod give any clue as to its first outbreak in that place? and if any remedies were tried; also if other bees have died in or near Swanley. I trust that every bee-keeper who is so unfortunate as to get this disease in his apiary will give his experience in the BEE JOURNAL, and endeavour to prevent its spread as much as possible by burning and burying the ashes of all frames, combs, wraps, and bees, disinfecting the hives if worth keeping, or if old, split them up for firewood, making sure that the wood is put where foraging bees cannot reach it. The ground should be dug over, taking care that the top soil is well buried. Those whose bees are infected should not examine any neighbouring stocks after handling diseased hives, as you may convey the germs to healthy stocks. I appeal to bee-keepers not to sell stocks or swarms from infected apiaries—except to neighbours who wish to re-start—and I hope our Editor will publish a list of the

names of districts where the "Isle of Wight" disease is known to exist, so that bee-keepers may not order from those places. We must remember that this "Isle of Wight" disease is much more deadly than the worst type of foul brood.—W. WOODLEY, Beedon, Newbury.

#### CAPPINGS OF COMB.

BY L. S. CRAWSHAW, NORTON, MALTON, YORKS.

*Honey prices* (page 78).—The "Concrete Example" which D. M. M. adduces does not quite demonstrate the tendency of honey to decline in price. Thus, taking his figures, when pork was 5 cents per lb., honey was  $6\frac{1}{2}$  cents; when pork rose to 10 cents honey was 9 cents. So that the value of honey shows a distinct and gratifying increase, even though there may not have been the same forces behind the prices. Will D. M. M. give the Banff prices to which he refers? And is the inference that less income, due to the drop in price, is derived from the sale of honey than used to be the case "some years ago?"

*Nucleus or Nuclei* (page 78).—Dr. Miller and D. M. M. seem to have had quite a little verbal "set-to" over points of grammar. They are both learned men, and I fear them accordingly. But D. M. M.'s argument that "forming-nuclei" and "nuclei-forming" are interchangeable terms would seem to be a good reason for sticking to the better-known and more orthodox phrase. Certainly if one were to use the latter in an examination paper without at the same time a long explanatory note (and even then!) it would not be unlikely that each obtuse and hard-hearted examiner would exercise the point of his blue pencil! I am irresistibly reminded of the child story about "keeping a bee." If it is to be understood that a bee-keeper is a keeper of bees, could he write himself a bee-keeper to make it plain, without transgressing the "rules of common sense?"

As to "queen-right," is not D. M. M. over-critical? I feel like Saul among the prophets, but it does seem to express shortly a condition which would otherwise require a sentence. "Shook" swarming, and "chunk" honey are, no doubt, reprehensible slang, but surely "apron" and "lid" are good English. "Apron" has several technical meanings, and may include the alighting board, whilst "lid" is appropriate to the American type of roof. I do not, however, suggest that these are the best terms, as I believe in uniformity of technical terms. Thus, I hope we may yet see "European" and "American" foul-brood replaced across

the water by "black-brood" and "foul-brood." Should there be, as is suggested, any local difficulty with nomenclature in existing disease laws, it may be possible to amend the laws to cover mere change of terminology, and new laws will no doubt make their inclusiveness clear.

*Colour and Cholera* (page 81).—It is doubtful whether D. M. M. will have altogether disposed of the theory that colour affects the temper of bees. These things die hard. Many of the cases he gives are hardly effective evidence. For instance, bees induced to sting by pressure of a garment. Such bees are not intending to sting, and are not free to choose their locus. Their action merely proves that like begets like, the pressure of a collar inducing temper! But I should expect a white garment which had been worn for a week to be more provocative than a Sunday black! For I believe in the efficacy of cleanliness as an associate of godliness. No doubt some of the past evidence has been due to the kindly fact that black does not show the dirt. Bees are, however, creatures of habit, and will follow a friendly lead, so that a coat which has been once stung is more likely to become a "cloak of maliciousness" than a "garment of salvation."

*Foul-brood Legislation* (page 84).—(1) The comparison between a reduction from 30 per cent. to 5 per cent. and a reduction from 60 per cent. to 7 per cent. is not necessarily favourable to the latter. Expressed graphically it might give a curve showing greater difficulty in disposal of the later 2 per cent. than an earlier 30 per cent.

(2) Mr. Samways attacks my suggestion of a gauze tent upon, I think, mistaken grounds. Perhaps he has not actually used one. It is not essential that the tent should interfere with the hive entrance, nor that the top should be closed.

(3) I am willing to admit my dulness, but I do not quite see the point of his remark about *meum* and *tuum*. Does he mean that the Irishman in pursuit of simple pleasures should be allowed to breed disease because the bees are his own, as he might be allowed to enjoy smallpox unchecked or keep a mad dog?

(4) Official compensation and insurance are quite different things, and must not be confused.

(5) May I assure Mr. Samways that it is indeed the few who are against legislation, and the many who favour it. I hope shortly to be able to prove this to his satisfaction. I may say that the whole subject is under discussion by the committee, and we yet hope to be able to meet the views of critics, and to get such bee-keepers as Mr. Samways into line with us on the subject.

## WEATHER REPORT.

WESTBOURNE, SUSSEX.

March, 1911.

Rainfall, 1·89 in.	Minimum temperature, 27° on 10th and 17th.
Below average, ·19 in.	Minimum on grass, 23° on 10th.
Heaviest fall, ·82 in. on 12th.	Frosty nights, 9.
Rain fell on 15 days.	Mean maximum, 48·1
Sunshine, 126·1 hours.	Mean minimum, 35·9.
Below average, 18·2 hours.	Mean temperature, 42·0.
Brightest day, 22nd, 10 hours.	Above average, 0·1.
Sunless days, 3.	Maximum barometer, 30·384 on 3rd.
Maximum temperature, 60° on 22nd.	Minimum barometer, 29·436 on 13th.
	L. B. BIRKETT.

## FERDINAND AND THE CENSUS.

(In Austria the census inquirers are strict. If you keep bees you must enumerate them in detail.)  
A mile outside Vienna Ferdinand had stocked a farm,

And he tilled it single-handed: for he much enjoyed the charm  
Which the soil exudes for people who enjoy that sort of thing.  
While he worked (his neighbours noted)  
Ferdinand would laugh and sing.

Life was pleasant for young Ferdie. First,  
he'd pat a fav'rite cow,  
Then he'd traverse several acres at the tail-end of a plough.  
He'd scratched the porcine vertebræ, the happiest man alive.  
Oh, sorry was the day on which he went  
and bought a hive!

Was it mere financial reasons or some temperamental gust  
Which led him thus to go upon an apiarian bust?

Ask not. I cannot tell you. But I know the place was warm  
When Ferdinand's big buzzers started, instantly to swarm.

He liked to see them swarming: and their numbers quickly grew  
Till a census-man came bearing, like a meteor from the blue.

A paper, asking Ferdinand how many bees he had,  
Upon receipt of which he went completely to the bad.

He lives in crowded London: his farm neglected lies.

He has bumps upon his forehead. The twelfth bee blacked his eyes.

His nose is very shapeless, and his brain is apt to freeze

When he contemplates his state if he had counted all his bees.

## Queries and Replies.

[4114.] *Early Drones*.—I have a solitary stock—super not removed—which last year was normal and cleared itself of drones in the autumn. There are now quantities of drones in the hive, and with cold north winds blowing—what is the best method of introducing a queen?—M. M. W., Chorley.

REPLY.—You must first make a thorough examination for the unfertile queen, which in all probability is present in the hive. It may, however, happen that there is a comb of drone cells where bees have clustered and commenced breeding, and this is the cause of the early appearance of the drones. In the latter case the queen will be all right. In the former, when found, kill her, and allow the bees to be queenless for at least twelve hours. Then introduce a fertile queen in the usual way. Choose a fine warm day for the examination.

## Notices to Correspondents.

W. H. W. (Haydon Bridge).—*Hermaphrodite Bee*.—The bee is a hermaphrodite, having a drone's head, and the male organs are partly shown in the abdomen. There are five segments to this, no sting, and, curiously enough, there were wax-scales in the wax-pockets.

W. F. (Amlwch).—*Bees Found Dead—Painting Hives, etc.*—(1) The bees have been dead for too long a time to enable us to say if they have died from disease or not. So far as we can judge they have died of starvation. The "odd bee" was the queen. (2) You can buy a stock of bees or wait until later and procure a swarm. We do not advise you to buy skeps. (3) Paint the hive now while it is empty. Hives should not be painted when they contain bees.

J. J. B. (Newton).—*Natives v. Italians*.—(1) Native bees are best for this country for many reasons. (2) Buy a swarm, prices of which will vary according to size, time of purchase, etc. You will easily obtain what you require through our advertisement columns.

A. M. B. W. (Cheadle Hulme).—*Rearranging Apiary*.—The position in which you propose to place your hives will answer quite well, and there will be no need to raise the hives on boxes. The 6ft. hedge is useful, as it will cause the bees to fly high, and minimise the risk of their stinging passers-by.

AMATEUR (Paignton).—*Stimulative Feeding and Robbing*.—We cannot quite grasp your meaning. It is impossible for bees

to steal from themselves, but if you mean—Will bees in a garden rob each other? the answer is yes.

A CAMBS. BEE-KEEPER.—*Using Combs from Infected Hives.*—Until something more definite is known about "Isle of Wight" disease, we should not consider it safe to use the combs for healthy bees.

H. S. (Cheshire).—*Syrup-feeding.* and *other Queries.*—(1) You can commence syrup feeding about the first week in April. (2) The stock can be transferred on any fine, calm, warm day when the bees are flying. (3) We have not heard of "Isle of Wight" disease being very prevalent in the district you name. The Journal and Record covers can be used for any year.

X. Y. Z. (Ramsgate).—*Stockholm Tar and Bees.*—It will be quite safe to paint your bee appliance shed with Stockholm tar or pitch, as neither will be injurious to your bees.

#### *Suspected Disease.*

H. A. (Ecclesden).—The symptoms you describe are those of "Isle of Wight" disease. Destroy the affected stock at once, burn all combs, etc., and disinfect the hive as for foul brood. The bees should have been enclosed in a tin box when sent, as they were so crushed in post that we could not examine them.

H. C. F. (Eastleigh).—The bees have died naturally of old age. Those you notice outside have been cleared out of the hive by the bees. The candy may be given, but it will soon be time to feed with syrup.

A. P. W. (Alfreton).—The stock is badly affected with foul brood. Burn everything without delay to avoid contaminating the rest of the apiary. The hive itself can be retained if very thoroughly disinfected.

T. E. A.—Bees have evidently died from "Isle of Wight" disease. See reply to H. A. (Ecclesden).

L. B. (Midlothian).—Bees have dysentery. There are also suspicious signs of "Isle of Wight" disease.

H. J. K. (Sidcup).—We cannot find any disease. The bees appear to have died of starvation.

BILL BAILEY (Devon).—A bad case of foul brood. See reply to A. P. W. (Alfreton). Do not use the syrup in combs for healthy bees.

F. N. (Sussex).—We regret to say that there are indications of "Isle of Wight" disease in several of the bees sent. We cannot be absolutely sure, but it will be safest to burn combs, etc., and thoroughly disinfect the hive and the ground on which it has been standing as an extra precaution.

### Special Prepaid Advertisements.

#### Two Words One Penny, minimum Sixpence.

Orders for three or more consecutive insertions entitle advertisers to one insertion in "The Beekeepers' Record" free of charge.

Trade advertisements of Bees, Honey, Queens, and Bee goods are not admissible at above rate, but will be inserted at 1d. per word as "Business" Announcements, immediately under the Private Advertisements. Advertisements of Hive-manufacturers can only be inserted at a minimum charge of 3s. per ½ in., or 5s. per inch.

#### PRIVATE ADVERTISEMENTS.

**F**OUR GOOD HEALTHY STOCKS, 1910 Queens, in excellent standard Hives, 25s. each; genuine bargains.—WINKWORTH, Pangbourne, Berks. h 28

**S**EVERAL GOOD STOCKS OF BEES for Sale, Standard Frame Hives.—THOS. HILL, Scotlande, Cannock-road, Wolverhampton. h 27

**F**OR SALE.—30 Brood Boxes, 27 Roof Tops, 53 Section Racks to take 21 lb. sections, all at 9d. each; 400 Slotted Tin Dividers, 3s. 6d. per 100; 480 empty Sections, some drawn out, 15s. the lot; geared Extractor, reversible cages, take two Frames, and 1cwt. Honey Ripener, 25s. the two; Observatory Hive, take 1 Frame and 4 Sections, 7s. 6d.; all second-hand.—SHARLAND and MITCHELL, Dorset Apiary, Broadstone, Dorset. h 58

**S**EVERAL STRONG HYBRID NUCLEUS FOR SALE; overstocked; 1910 Queens, perfectly healthy; exchange cycle, or from 10s. to 15s. each.—JOSHUA CREWES, beekeeper, Truro, Cornwall. h 34

**W**ANTED, SECOND-HAND OBSERVATORY HIVE, Lee's make preferred; particulars.—STEBBINGS, Hilborough, Norfolk. h 37

**T**WO STRONG HEALTHY STOCKS in good Hives, 1910 Queens, 30s. each.—C. TOWNSEND, Lawnfield, Maidenhead. h 36

**C**HAPMAN HONEY PLANT SEEDS, about 2 lbs. FOR SALE, cheap. What offer?—P. W. MILES, Alburgh, Harleston, Norfolk. (h 35)

**G** COTTAGE HIVES, 10 Frames, dummy, lift legs, crate, 21 sections (unused), the Hives used one season only, painted 3 coats, guaranteed healthy, 7s. each; also large Meadow's Ripener, with lift and strainer, used once, 10s.—F. E. MATTHEWS, Cofton Apiary, Northfield, Birmingham. g 62

**W**ANTED, CHOICE ENGLISH HONEY.—Address L., "B.B.J.," 25 Bedford-street, Strand, London, W. h 40

**S**EVERAL STOCKS OF BEES, 1910 Queens, on Bar Frames, for Sale, guaranteed healthy; also several Nuclei.—RECTOR, Elston, Newark. h33

**F**OR SALE, HARMSWORTH HISTORY OF THE WORLD, complete 52 parts, as new, 25s.; or exchange one healthy Stock Bar Frame, or two Skeps Bees.—R. WOOD, 7 Spring Bank, Ripon. h 30

**H**EALTHY STOCK OF HYBRID BEES FOR SALE, with Hive, 30s.—ANDERSON, 128 Castelnau, Barnes, S.W. h 29

**F**OR SALE, A SMALL APIARY, complete, in very best condition; 5 Stocks Hybrid Bees in Lee's best W.B.C. Hives, started from swarms (W.B.C. Apiary Luton) in 1909; have had no disease of any kind, now very fit and strong; also 3 spare Hives (Lee's W.B.C.) as good as new, all accessories and appliances lifts, supers, Cowan's Extractor, Ripener, Lee's Extracting Tray and Table; owner selling only as he has to live near London; open to inspection. Price, the lot, £12.—Apply, MAJOR E. BARNES, Winton Hill, Stockbridge, Hants. h 31

**G** BEE HIVES FOR SALE, 5 with good strong stocks; also Frames and Sections ready for this season. Homer Extractor, Smokers, &c.—Apply Mrs. BAGNALL, Breton, Stafford. h 32

**I**NSTRUCTION AND PRACTICE IN BEE-MANAGEMENT; varied courses during May and June; 40 Colonies.—BUGDEN, Wye, Kent. h 41

## Editorial, Notices, &c

### THE "ISLE OF WIGHT" DISEASE.

We have received letters from Kent and Sussex referring to the map published on page 123 of B.B.J., and complaining that the whole of the counties are marked black, whereas there are many districts still free from the disease. The map is an exact copy of the one accompanying Dr. Malden's paper, and is certainly not intended to convey the idea that the whole of the marked areas are infected, but is simply meant to show the progress that the disease has made in the different counties. It is evident that on a small scale map of this description, it is impossible to mark every spot where colonies have succumbed to the disease, and the only way is to show in which counties it is present. The Southern counties are shown darker, because the disease has been prevalent in them longest. It has spread from the Isle of Wight to Hampshire, Surrey, Dorsetshire, Sussex, Kent, Berks, Bucks, Middlesex, Essex and Herts. It does not necessarily follow that because the county is shown black that every part of it is infected. It would, indeed, be a serious matter for bee-keeping if it were so, and we are pleased to know that there are districts still free from the disease, and sincerely trust that they may remain so. When we get reports of the wholesale losses of colonies in different districts, it is just as well that bee-keepers should know that there is danger, so that they may take every precaution to guard against it. Until the investigations of the Board of Agriculture and Dr. Malden are completed, and we know more about it, the disease should be treated as an infectious one, especially as all the evidence, so far, tends to show that it is so. Therefore, we would again urge on our readers not to trifle with the disease, but, on the first outbreak, to destroy the bees, and thus prevent it from spreading in the apiary and neighbourhood. Bee-keeping is of national importance, as not only bee-keepers, but fruit growers also are dependent on bees, it is, therefore, better to adopt drastic measures to cope with the trouble, and leave experimenting in the endeavour to cure to those who understand dealing with infectious diseases, otherwise more harm than good will be done. We would also ask bee-keepers to give the Inspectors of the Board of Agriculture who are now collecting evidence in affected districts all the assistance in their power.

### BRITISH BEE-KEEPERS' ASSOCIATION THE CONVERSAZIONE.

(Continued from page 135).

Mr. Jarman said he had tried sulphur, but it did no good, and he had lost in six months one hundred and twenty stocks.

Col. Walker said he would suggest that attention be paid to the possibility of the wind being the conveyor of the disease, as it might explain the problem. It would also help to explain how, after being confined to the Isle of Wight, the disease crossed to the mainland, but if that was the case, he thought they ought to look on pollen as a possible cause, and it was to the trees that they should look for the explanation. He did not think it would do to look to the minor complaints such as moisture, because that could not possibly be conveyed, but it might be pollen from trees that were diseased, or possibly the germs. He would only suggest that they did not lose sight of that possibility.

Mr. Salmon would like to ask whether there was the possibility that in-breeding was the primary cause of the disease, as in the Isle of Wight bees they were more or less isolated. In the case mentioned by Dr. Malden, he said that the bee-keeper had not imported foreign bees or bees from any other districts, and so in breeding from the I60 stocks they would come more or less from the same hives of bees. He thought it might possibly have something to do with the bees.

Mr. Osborn would like to support what Dr. Malden had said in regard to sulphur treatment, as he did not think it of the slightest use. He would also like to mention that in his experience with six stocks of diseased bees, he had distinctly found the young bees affected—some of the very youngest of the bees—and directly they took to leaving the hive they became affected. With reference to the charlock theory, he had seen a good deal about it in this week's "British Bee Journal." Where his bees were situated he did not know of any charlock within four or five miles.

Mr. Cowan, in closing the discussion, said that they had had certain evidence that went to show that the disease had been carried from one place to another. When it broke out in Durham they had managed to trace the disease to its source, which was the importation of driven bees from Essex. One or two other cases have been traced in the same way, and cases in Scotland had been traced to the bees having been received from the south. He thought that tended to show that the disease was conveyed and that it was an infectious disease carried from one locality to another, and when once it had been established in one locality, it was very easy for it to spread. Those cases of Mr. Downes-Shaw were clearly cases of

importation, and they formed the nucleus for starting the disease in that neighbourhood and were centres of infection. How the disease had got into Cornwall he did not at present know, because he had not had any report about it. He would mention that the disease does not go through an apiary regularly attacking one hive after another. He had a chart of the outbreak of the disease in the North of Wales (which the speaker held up for inspection), where the disease had attacked colonies promiscuously commencing with one colony and jumping to quite another part of the apiary. As the ground had been well covered, he did not think he need say any more, especially as it was getting very late and they had other entertainments to come on. He would now ask Dr. Malden to reply to the questions that had been put.

Dr. Malden, in replying, said that the Chairman and Mr. Reid, had saved him a great deal of trouble in answering many of the questions, because their remarks applied to many of the things asked, particularly as to the spread of the infection. He had no doubt that if they possessed the means they would be able to trace in every case how this disease has been spread from one locality to another. Although very difficult, and in some cases impossible to say for certain how it had taken place, he believed it would be found to be by means of communication.

Several points had been raised. Of course if it was a pollen disease and the pollen was from honeydew, it would be eaten during the winter and produce the disease. His objection was that he could not imagine that the infected pollen was only present in certain localities, unless it was a pollen disease which was spreading about. The disease first appeared in the Isle of Wight without being present everywhere. Then, again, we know that any disease tends to lower the digestive functions, and there is no doubt about it that in a diseased bee you are more likely to find strange matters in the bowel which would not occur in a healthy bee, such as various fungi which had been mentioned. He believed it was a fact that in this disease when brood dies it is because there are not sufficient bees to keep the larvae warm and look after them; otherwise they are healthy. He was sorry to say that the experience of the two gentlemen from Kent was the same as that of others. It was quite typical of the way in which the disease was being spread. He was interested to hear that other people have observed younger bees being affected, as he had not noticed it before, and in the Isle of Wight the idea seemed prevalent that the disease was due to the foraging bees. He hoped all bee-keepers would make an important note of this point, as it would

help to solve the difficulty of how the bees become affected.

With respect to continuous culture, he had kept the germs alive on artificial media, and he had found ordinary nutrient agar, with two per cent. of honey, the best culture medium.

Where did the bees come from in the outbreak of the disease in Surrey in 1907? He would not be surprised if it was found that they had come from the Isle of Wight. He had never seen a queen affected, although he had frequently examined hives in which the queen was the only one alive except some emerging brood. It appears that the queen is not susceptible; that may be a question of feeding, but that is a point that requires further investigation.

He was interested to hear the remarks about the outbreak in Fife being traced, because that was very important, and answers Mr. Downes-Shaw's question about the disease jumping about from place to place. It all tends to prove that it is an infectious disease, and not a pollen or food disease. Sulphur had been mentioned as of some use in checking the disease, but he still thought it very dangerous for a bee-keeper to trust to it. He had far better destroy the first lot than risk the spread of the disease by trusting to sulphur.

He had searched carefully, but had found nothing descriptive of bee diseases occurring on the Continent or in America that quite resembled this disease; it appeared to be something entirely fresh. He was interested to hear that Mr. Reid had been partly successful in feeding bees with Bulgarian Sour Milk. It was quite a rational treatment, because we know that in some cases of human disease the introduction of sour milk enables one to get rid of the digestive trouble, and this disease of bees is mainly one of digesting pollen. He hoped that some other bee-keepers would experiment on these lines and note the results. He thought it possible that the wind may have conveyed the disease from the Isle of Wight to the mainland, but it was very difficult to prove, and he did not think one could get evidence on that point. He had asked bee-keepers in the Isle of Wight, but they did not think that the bees flew across the narrow channel, and he thought it more likely that the disease was conveyed by bees being transmitted from place to place.

The Chairman's remarks also bore out his own proposition that it was an infectious disease, but when once it got into an apiary it was difficult to say how it was spread because it did not go from hive to hive, and they could not be certain if it was through robbing by some particular colonies which were the first to go, or whether they were infected through the water supply.



The question was asked whether experiments had been tried with bees in hives made of other material than wood or straw. What work he knew of had been done in wooden hives.

The Chairman (Mr. Cowan) said they were all very much indebted to Dr. Malden for giving them so much information on this subject, and he was sure that they would all join in thanking him. There was one thing he had alluded to which he (the Chairman) would like to emphasise, and that was not to tamper with the disease, or with remedies, but at the first outbreak of the disease to destroy the bees at once. This was much safer than tampering with uncertain remedies. As soon as the nature of the disease was known remedies would be found, but until then he thought the safest plan was to destroy the bees. He would like Dr. Malden to tell them exactly how he would like samples sent for his inspection. He mentioned this because most of the bees sent to the British Bee Journal were quite unfit to diagnose, and he had not only received recently dead bees, but also those that had been dead for some time, and others dried up. He thought they should know that such bees were no good, and that only live bees from affected colonies were of any use for examination.

In reply, Dr. Malden gave the following particulars of how to send samples for inspection, to be addressed to him at the Pathological Laboratory, Cambridge University. The bees, to be of any value, must be alive, and there must be a sufficient number of them to keep each other warm. They must have food, and be in ventilated boxes. He had found the best way of sending them was in a small box with perforations for ventilation, with a little candy in a muslin bag fastened in a corner. Two or three hundred bees, if possible, should be sent, and a bit of wood or cotton-wool fastened in the box for them to stick to. If they were sent in that way they would remain alive for several days, and give a chance of arriving at some satisfactory conclusion.

He would like the Association to appoint a small committee to help him in investigating this disease. It was a national question now—(hear, hear)—and it appeared that if no steps were taken the bee industry would be paralysed, and he thought that the British Bee-Keepers' Association should urge that steps be taken in the matter, and if they could see their way to appointing a small committee to confer with him on the difficult points that require investigation he would be very much obliged. It would be of enormous value to him, and he was certain that they would arrive at much better results than would be possible if only one man was

working alone in a laboratory. It wanted the careful co-operation of bee-keepers all over the country to arrive at the best results.

The cinematograph entertainment which Mr. J. Bee Mason had provided next took place, and those present were able to see depicted on the screen the removal of bees from a farm-house wall. The operation of removing the tiles, smoking the bees, cutting out the combs, throwing the bees out on to a sheet and their running into the hive were shown in a realistic manner. Transferring bees from a tree and barrel to frame hives and work on a modern bee farm were very attractive, and highly pleased the audience, who expressed their appreciation by frequent applause. At the conclusion the Chairman, in thanking Mr. Mason for the treat he had given them, congratulated him on the expert skill he had displayed in carrying out such difficult operations, as he was sure it was a good lesson for those there who might contemplate removing bees from difficult places (Applause).

Mr. Mason, in returning thanks, said that in removing bees he had noticed points which he would like to mention. There was the absence of wax moth. He did not think he had noticed a single case in which it was present with bees under natural conditions.

It occurred to him that quilts were responsible for the increase of wax moth. Another thing was that bees were more vicious, because bee-keepers had a tendency to re-queen from stocks of a gentler nature. But were they thus studying the welfare of the bees? In their wild state bees are more or less vicious, and those that are tame are liable to be robbed out. All his bees were more or less vicious, and he found no tendency in them to rob each other.

Queens living under natural conditions were smaller than those in the modern hives. In adding beauty and size to the queen it occurred to him whether breeders were not studying their requirements at the cost of the vitality of the queen, because he had proved that bees in their wild state were much smaller, but very hardy and active.

A vote of thanks to the Chairman closed the proceedings and one of the most enjoyable conversaciones held by the Association.

---

#### HONEY IMPORTS.

The value of honey imported into the United Kingdom during the month of March, 1911, was £1,572.—From a return furnished to the BRITISH BEE JOURNAL by the Statistical Office, H.M. Customs.

## REVIEW.

*Guide to Bee-keeping in British Columbia*, by F. Dundas Todd. This is Bulletin No. 30, issued by the Department of Agriculture, Victoria, B.C. The bee-keeping industry has not been so much developed in British Columbia as in the Eastern provinces, especially in Ontario, where a great many depend on it entirely as a means of livelihood. In British Columbia bee-keeping is common only as a side issue and in dairying and fruit growing districts a small apiary seems a necessary adjunct to almost every ranch. In some localities there is one keeper of bees to every twenty people. There is therefore no necessity for home-seekers in this part of Canada to bring bees with them as there are plenty to be had. This bulletin has been specially compiled to meet the demand for practical information, and has been adapted to the conditions prevailing in British Columbia. The author recommends the 8 frame Langstroth, but states that there are other hives in use, some bee-keepers on the mainland using the "British Standard" frame; this is probably owing to the fact of the "British Bee-Keepers' Guide Book" being the recognised standard of the Department of Agriculture. The information which the author gives is derived from practical work among bees, and it is interesting to find some of the well-known half tone illustrations from the "Guide Book" reproduced, though following a far too common practice, no permission to use them was asked, nor mention made of their source. The bulletin, which consists of 50 pages and is divided into 14 chapters, is well illustrated and will be useful for those who contemplate bee-keeping in British Columbia. Chapter 4, "The Cycle of the Bee-year in British Columbia," gives instructions for work to be done in every month, from March to November, also a diary of plants in flower. At the end there is a useful list of bee-keepers in the province.

APICULTURAL EDUCATION IN  
ENGLAND AND WALES.

*By W. Herrod.*

In most foreign countries the whole of the teaching of bee-keeping is provided for at the Government cost, while in England and Wales the major portion is carried out by voluntary work on the part of Bee-keeping Associations. These are in some cases helped by grants from County Councils, but altogether the amount thus provided from Government funds is totally inadequate for such an important industry. No money is spent at all on such scientific research as for instance is the case in America, and the disadvantage of this was clearly shown in Dr. Malden's paper on the "Isle of Wight" disease.

It is time that more were done, and fruit-growers are beginning to realise that their industry will suffer considerably by our misfortune. By the united action of both bee-keepers and fruit-growers at this juncture, it should be possible to wake the Government from its lethargy and make them do something for us.

Below I give a list of counties where aid is given, with the number of lectures and the average attendance in 1908-9 and 1909-10. Also a list of those counties where no instruction of any kind is given. Those marked with an asterisk spend money in their Agricultural Colleges &c., on bee-keeping.

County.	No. of Lectures.	Average Attendance.
*Beds .....	60 .....	70
Bucks .....	— .....	30
Cambs. ....	3 .....	well attended
Cheshire .....	— .....	well attended
*Cornwall .....	— .....	well attended
*Cumberland ...	13 .....	—
*Derby .....	5 .....	59
Devon .....	36 .....	30
Essex .....	4 .....	17
Glos. ....	10 .....	20
Hereford .....	— .....	—
Herts. ....	40 .....	60
Hunts. ....	3 .....	26
Kent .....	60 .....	11
Lancs. ....	10 .....	32
Lincs., Holland ...	5 .....	68
Lincs., Kesteven	6 .....	9
Lincs., Lindsey ...	12 .....	50
Middlesex .....	— .....	—
*Monmouth .....	— .....	—
Norfolk .....	34 .....	25
Northants .....	16 .....	—
*Notts. ....	3 .....	—
Oxford .....	— .....	—
Somerset .....	— .....	52
*Staffs. ....	10 .....	—
E. Suffolk .....	2 .....	40
W. Suffolk .....	4 .....	—
*Surrey .....	33 .....	250
Warwicks. ....	— .....	—
*Wilts. ....	48 .....	—
Worcester .....	12 .....	51
York (West Riding)	12 .....	68
Carnarthen .....	— .....	—
Flint .....	10 .....	9
*Glamorgan .....	20 .....	—

In the blank spaces no particulars have been furnished.

Those counties where no teaching or lecturing is done are as follow:—Berks, Dorset, Durham, Isle of Ely, Hants, Isle of Wight, Leicester, Northumberland, Rutland, Salop, E. Sussex, W. Sussex, Westmoreland, Yorks., E. and N. Ridings, Anglesey, Brecon, Cardigan, Carnarvon, Denbigh, Merioneth, Montgomery, Pembroke and Radnor.

## Correspondence.

*The Editors do not hold themselves responsible for the opinions expressed by correspondents. No notice will be taken of anonymous communications, and correspondents are requested to write on one side of the paper only and give their real names and addresses, not necessarily for publication, but as a guarantee of good faith. Illustrations should be drawn on separate pieces of paper. We do not undertake to return rejected communications.*

### THE "ISLE OF WIGHT" DISEASE.

[8126] In response to the request made by our Editors and Dr. Malden, for facts in regard to this malignant and insidious trouble, I am able to supply the following six: (1) I received a splendid swarm in 1907 from Hants which did good work up to some time in September. It showed distinct symptoms in October and died out by May of the following year; proving that the disease can be conveyed a distance by an apparently healthy swarm. (2) Two colonies on one side of the diseased swarm, and three on the other, showed signs of distress during the summer of 1908, gradually got worse and were like the original stock destroyed; proving that the trouble is contagious. (3) All brood frames were burned, but several combs of honey were preserved for future swarms, the extreme virulence of the disease then not being fully understood. The honey conveyed the infection to these perfectly healthy bees, proving that honey partaken of, conveys the disease. (4) Hives affected were cleaned out, but not over carefully disinfected. They retained the seeds of disease and affected driven bees lived in them on clean frames, proving that the germs and spores are persistent. (5) The queen of the original swarm, being a prolific one was transferred to a queenless stock, and did good work during that and the following season, while two of her daughters are now heading powerful colonies; proving that queens are not affected by the disease. (6) We have practically no charlock near here, and no *spraying*; proving that this was not the source of the disease in any of the deceased stocks.

Making a holocaust of frames, combs, quilts and everything movable about the hive, and thoroughly disinfecting the interior of all empty hives with a painters' blow-lamp flame is the only cure I would advise. Let me earnestly plead that no colonies, swarms, or driven bees should be sent north from any infected area this season, and all ordering these should ask a guarantee of health.—  
D. M. MACDONALD, Banff.

### BEEES IN DARKEST AFRICA.

[8127] I am sure you will consider the above title very apropos when you read the story of my present season's experience in bee-keeping, which, I hope, is sufficiently interesting to occupy a corner of the B.B.J., as I should like British beekeepers to occasionally give a kind thought or word to us in this new bee-keeping world, where we are nearly all learners, and where teachers are scarce, and experience very dearly bought.

My first honey of the season is gathered from eucalyptus, peach, apricot, grapes, apple &c., in the months of September, October, and November, but, owing to a large plantation of eucalyptus, nearly half a mile square, being cut down last year during the winter, for the use of the Rand Gold Mines, the principal source was eliminated. My second crop was supposed to come from the veldt flower and alfalfa, or as it is generally called here, lucerne, but, owing to continued dry weather, month after month, the bees were hardly able to gather sufficient for their own requirements. I opened up eighteen hives last week, most of which are supered for extracting, but could only find one frame well sealed. I have not seen a single swarm so far, and as the honey flow is completely finished for the district by the end of March, I am afraid this season must be written down as a failure. Most of my bee-keeping friends tell the same story. At the end of this month I shall close all hives down for the winter, with a rack of shallow frames with extra wide ends above the brood chamber, for, owing to the winter climate being quite warm in comparison with that in England, and the bees breeding throughout the winter, together with the fact that we have no snow or rain during that time to prevent them from flying, I have found, from experience, that they winter better that way than if treated on the "Guide Book" plan. There is no danger incurred by thoroughly overhauling a colony during winter; in fact, it seems to act in the same manner as our American friends' "Jouncing" plan.

We have to congratulate ourselves in this country on the fact that we have no foul-brood, and no "Isle of Wight" disease to contend with, and I trust our bee laws will protect us from these diseases. The South African has had too much experience, with stock diseases and pests, to tolerate or compensate any person who endangers the safety and health of the property of others. But our bees have their work cut out to make a living, menaced as they are by other enemies, such as ants, wasps, beetles, and spiders of all kinds, besides a few specially-designed South African insects, without

having added *Bacillus alvei*, *Burri*, and *Co.* I should like to corroborate the remarks made by H. Martin, of Dannhauser, Natal (B.J., page 54), regarding the use of drone foundation, which so exactly coincide with my own experiences, that I fear, if I relate them, I shall be accused of plagiarism. I have drone-comb foundation in shallow-frames which have been on one hive or another for the last two years, and so far they have only been made a mess of. I have only had one frame fairly well sealed during that time out of eight sheets originally put in different hives, and even that frame was finished in the manner Mr. Martin so ably describes. This foundation was made by the same firm who manufactured most of the foundation I have used, and is of excellent quality, so neither the wax nor the making can be blamed. I am willing to admit all the advantages claimed for the plan of using drone foundation for surplus honey, but from my own past experience, the original one pound I bought will last me for many years to come.

As regards Mr. Martin's opinions as to the use of excluder zinc, they differ from mine, for I use it on every hive I super, either with frames or sections. Last year, being short of excluders, I had to make shift on one hive with a piece of zinc about 1ft. square, trusting to its being sufficiently large to keep the queen below on the twelve frames in the body-box, but on taking off the first rack of sections finished, I found four of them contained drone larvæ, which was sufficient proof for me that a full sheet of zinc is necessary to keep the queen below, especially if the frames in the brood-chamber are spaced as I space mine during the honey-flow, 1½ in. apart. This hive was also the only one which swarmed.

I suppose bee-men in England are all getting ready for the 1911 season. I hope they will have a more successful season than we have had. Nothing remains for us in the Pretoria district but the bee-keeper's oldest and staunchest friend—"Hope" (for better times).—J. L. TAYLOR, Winterboom Apiary, Pretoria.

#### IF YOUR BEES ARE A NUISANCE.

[8128] "A fellow-feeling makes us wondrous kind." Of course anyone "wi' a bee in his bonnet" can excuse another, who is similarly afflicted, keeping bees in a garden just close by where there is so much traffic, 'cause why; when once a man has caught the bee-fever, Dzierzon says: "It will not be an easy thing to induce a wise bee-keeper to exchange bee-keeping for any other occupation."

The man who has to grind, grind, grind daily at his business (and this, doctors tell us, spells nervous breakdown), how many

hours of healthy distraction does not he owe to our little winged friends?

Yet who would wish that that which is his enjoyment should be a trouble to others. Æsop in his fables tells us how an old frog croaked out the warning from his pond to the boys who were pelting him with stones, "What is fun to you is death to us." Apply the same moral at home. Should you have a vicious stock in your apiary, and perhaps your neighbour's horses get in the bees' line of flight, or his fowls develop a taste for bees as a dietary article, then, as Robert Stephenson said of the "coo" suggested to have got in front of a railway train, it would be a bad job for either of them. A. I. Root mentions a case where horses had to work in front of a hive and how he enveloped them in horse blankets and mosquito netting, but this is not always practicable, and it is slightly ridiculous.

It may be that this is only the curtain raiser to the scenes to follow. The owner of the horses or chickens which have been stung obtains an imperative command (served on you to the edification of the whole village by a blue-coated myrmidon of the law) to abate the "nuisance," and by post you receive a letter from a lawyer, demanding that the sum of twenty pounds (with six shillings and eightpence for his courtesy in writing you this letter) shall be paid as compensation for damages done, or proceedings will be taken forthwith. Naturally you resist, the day of trial comes on, and the local Serjeant Buzfuz pictures to the jury the enormity of the crime of the villain who keeps bees to the peril of His Majesty's liege subjects, and to their grievous bodily harm. Of course, you lose the day and are mulcted in heavy costs. You sell your bees to pay the fine, and retire from bee-keeping in disgust. You think I am exaggerating! I have chapter and verse for every statement I have made.

And are you to take all this "lying down?" Is there no preventative? And if the extreme happens have you no help? There are preventatives, and if you are provident there is help. Let us discuss both the first and the last.

It is a matter of common knowledge that bees, when starting on a foraging expedition, if forced on leaving the hive to mount on high do not afterwards descend; therefore, erect an obstacle on the side where the danger lies to the height of 12 or 14 feet. This may easily and cheaply be done by surmounting any fence surrounding your apiary with lattice work, or even wire netting, and train to grow over this wild hop, Virginian creeper, any of the various climbing plants, or the beautiful rambling roses. This will enhance the picturesqueness of your garden and give greater privacy.

But should you be blest (or cursed) by a neighbour next door who will not be comfortable, throw a sop to the Cerberus; allegorically choke him, not with melted butter, but with a jar or two of honey or a few sections. Don't give him time to speak, give to the wife or "kiddies." You will have, then, powerful friends at court, and their advocacy will be cheaper than a lawyer.

So far for preventives. Now what help may you hope for in your time of need?

The old adage runs thus: "What is everybody's business is nobody's." Therefore have the "nobodys" combined to form "somebodys," and the results as seen in the State, in trade, in agriculture, are Parliaments, Chambers of Commerce, and Agricultural Societies, who each in their own sphere agitate for the common good. And we have our combination yeleft, "The British Bee-keepers' Association," whose special rôle it is to interest itself in matters apicultural. Much good work has it done and various, notably that which interests us at the moment—its scheme of insurance. Eight years ago an arrangement was made at "Lloyds," whereby the members of the Association or affiliated Societies were insured against any liability for damage done by their bees to a third party up to the amount of £30 in any one year, and at what cost? The ridiculously small premium of one penny per hive. The privilege was afterwards extended to non-members for an entrance fee of one shilling.

Great has been the success of the scheme. In 1910 there were 1,008 bee-keepers who availed themselves of the benefit representing 12,955 hives, and claims in that year amounting to £22 5s. were speedily settled to the satisfaction of all concerned. At the nominal outlay one wonders why every keeper of bees does not insure. And the procedure is so simple. Write to the Secretary of your Association for the needful forms, or to the British B.K.A. if you belong to no affiliated branch. Pay your pennies, and if a claim arises, don't worry. Make your demand on the Association, go to sleep, and they will do the rest.

Life is too short for worries. We have not time for them. We prefer to spend it on something else, to "cut our losses." Why, therefore, if you can avoid it, incur the risk of the haunting thought that your neighbour "has the law of you" to accompany you to your pillow, and to be the first thought in the morning. Better to turn this "Comedy of Errors" into a "Midsummer Night's Dream" by insurance. In which case if Dame Fortune is unkind and the day should go against you, all your work will not be "Love's Labour Lost."—L. SMALLWOOD, Hendon.

#### EARWIGS AND BEES.

[8129] Having read in the B.B.J. several times that earwigs are not injurious to bees or honey in any way, I thought the enclosed specimen might interest you.

I noticed two bees bringing something out of the hive; one of them flew away and, on looking, I found the other one trying to sting the object, which proved to be an earwig, which had its nippers firmly embedded in the body of the bee. The bee died whilst I was looking at them. The earwig also dying about half-an-hour afterwards without having been able to free itself.—Geo. S. GIBSON.

[We are exceedingly obliged for the specimen sent, which is unique. We have never seen this happen before. Earwigs will, at times, damage the cappings of combs by perforating them; they also lodge in the cells, sometimes making the combs objectionable by soiling them with excreta.—Ed.]

#### BOARD OF AGRICULTURE AND BEE DISEASE.

[8130] I have read with much interest your articles this week on "I.O.W." bee disease, and shall be glad if you can spare room for the enclosed. Our Member is taking up the matter very thoroughly, and we are seriously considering the advisability of introducing a Bill into Parliament at an early date to make the disease a notifiable one, by which means we think it would tend to arrest the spread of the disease in this country. It is very bad in our district. I have this week lost my first colony. With regard to charlock-spraying being the cause, I have had an interview with the Hants C.C. expert, and he considers that the trouble may be caused by fermentation or decomposition after the spraying. I send a cutting from the *Hampshire Observer*, giving Captain Baring's questions, and the answers, in the House of Commons; the previous ones appeared in your journal, page 108.—H. J. DAY (Winchester and District Smallholders' Club).

In the House of Commons, on Monday, Captain Baring asked whether the Board of Agriculture is fully equipped, both financially and scientifically, for conducting inquiries into the diseases affecting bees.

Sir E. Strachey: Yes, sir.

Captain Baring asked whether the agricultural departments of several foreign governments have bee farms of their own for purposes of investigation and research, and whether he will consider the desirability of following their example.

Sir E. Strachey: The Hungarian Government have a State Bee Farm which, however, has for its object instruction in bee-keeping rather than investigation and research. In Berlin the Imperial Biological Institute conducts investigations into bee diseases. I will consider the hon. Member's suggestion.

Captain Baring asked what immediate steps his Department is taking to collect further information on the "Isle of Wight" bee disease.

Sir E. Strachey: The Board Inspectors are collecting very detailed information from bee-keepers as to all the various circumstances connected with outbreaks of the disease, and we are making arrangements for its further scientific investigation at Cambridge, under the charge of Dr. Graham Smith.

As we intimated last week, the Board of Agriculture promised that an inspector should visit the locality within ten days. The period expires to-day, but no communication has been received stating whether he may be expected. No more fresh outbreaks are recorded, but Mr. Day, suspecting that one of his hives was infected, took the precaution of destroying all the bees in it and sealing it up, pending the arrival of the inspector. Bees have for some time swarmed in the roof of Lainston House, and these have been attacked, as have all Mr. Bostock's hives. The bees in the roof crawl out, and not having strength to fly, drop off on to the ground, where they are picked up dead. The action taken by the Winchester and District Smallholders' Club has initiated quite a campaign all over the country, and bee-keepers are waking up to the dangers facing them, and the need for protective measures. There will be much less English honey produced this year than in former years.

## Echoes from the Hives.

To-day (April 3rd) being the first opportunity I have had this year, I took advantage of the exceptionally fine afternoon and had a peep into my hives, seven in number, situated at Consett, and found they had wintered very well. All queens are last season's, and are laying. Those stocks left with sufficient natural stores gathered from the ling have come out the strongest by far. On October 6th, last year, there were drones in all hives, and this being the latest I have ever seen drones allowed to remain under ordinary conditions, I overhauled my hives in consequence, and found all queens laying on that date. I packed down for winter, leaving sufficient sealed stores to last to about the middle of May. Trusting

all bee-keepers may have a record season during 1911, JOHN WATSON EGGLESTONE, Bishop Auckland.

### NOVELTIES FOR 1911.

Mr. A. H. Wilkes, Four Oaks, Birmingham (of queen excluder fame) has been responsible for bringing out some useful appliances in the bee world, and this year he has utilised the resources of aluminium in the perfection of feeders.

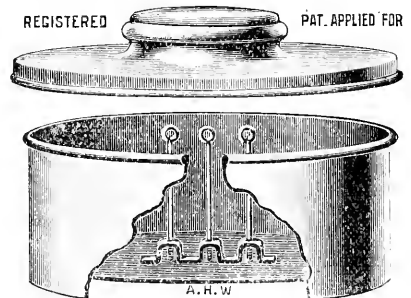

FEEDER WITH SCREW VALVES.

This feeder is made from pure aluminium, spun, similar to a piece of clay, moulded on an arrangement identical to the potter's wheel. As will be noticed, it has three screw valves for regulating the syrup. As a Spring feeder it will assist the bee-keeper considerably in stimulating colonies, and at the same time supply the exact quantity of food for the bees' requirements. The regulating of food in the Spring has always been a difficult task. Too much is as bad as too little. By using this invention the syrup can be accurately gauged to the exact amount of food necessary for stimulation. The greatest point in its favour is the fact that aluminium will not rust.

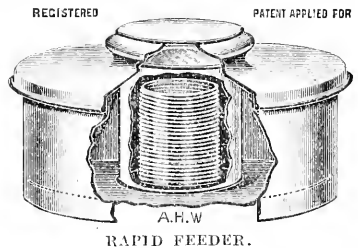

RAPID FEEDER.

An aluminium rapid feeder, which is also seamless and non-rusting, is another

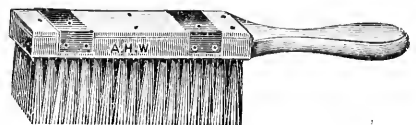

STEEL BRUSH.

excellent article. The capacity is one quart. It consists of four pieces, lid, cup with glass top, vessel, and a cork circle

from which the bees feed. The feeder when on the hive covers six frames. The syrup flows from the outer chamber to the inner one, and the bees walk up the narrow funnel, the rough surface enabling them to get a good foothold. As an autumn feeder it is exceptionally serviceable.

A labour-saving device is the steel-wire brush. This is specially designed for quickly removing any refuse from the floor-boards during spring-cleaning. This appliance will be extremely welcome, doing away with the laborious task of scraping the floor-boards with pieces of tin and glass.

#### TRADE CATALOGUE RECEIVED.

E. J. BURT (*Stroud Road, Gloucester*). This is a very neat list of twenty pages; replete with good illustrations of the articles sold. In addition to bee appliances particulars are given of bottles for fruit-bottling, mouldings for framing pictures, and all appliances for fitting up Sunday and other schools on the most modern lines. Catalogue sent post free to all applicants.

#### Notices to Correspondents.

J. C. R. (Maidstone).—*Isle of Wight disease*.—We deal with your letter in an editorial this week. No case, so far as we can find out, has been reported from your immediate district.

A. H. (Perth).—*B.B.K.A. Conversazione*.—There is evidently an error in the report of this conversazione to which you allude, as the "Chairman" did not say that "he had lost one hundred and twenty hives in six months," but this was said by Mr. Jarman, to whom allusion was made by Dr. Malden.

H. J. D. (Winchester).—*"Isle of Wight" Disease*.—The Board of Agriculture have been for some time making investigations in different districts, and we are pleased to hear that your Member has got them to send an inspector into your neighbourhood. The Board have never allowed the matter to drop, but we know, as a matter of fact, that they have not had the funds to devote to the necessary investigation, although the matter has been brought before them repeatedly. If your Member of Parliament, as well as the others who have been interested in the industry, could induce the Treasury to provide the funds for these investigations, they would be rendering considerable service, as it would enable the Board of Agriculture to proceed more rapidly. So long as the honey is not given to bees, it is

quite good to eat or for household purposes.

J. L. (Great Broughton).—*Bee Flowers*.—There is a list of suitable bee flowers on page 159 of "Guide Book," also on page 51 of B.J. for 9th Feb. last. Annuals can be sown where they are to flower, and perennials and biennials can either be sown and transplanted or purchased of nurserymen who generally keep a stock of plants on hand. Among the best annuals are Common Borage, 2ft. to 3ft.; *Limnanthes Douglasii*, 6in. to 9in.; Forget-me-not, 9in.; *Nigella*, 18in.; *Phacelia tanacetifolia*, 18in.; Mignonette, 1ft. Of perennials and biennials you can select: *Arabis*, P., 3in.; Canterbury Bell, B., 2ft.; Wall-flower, B., 18in.; French honeysuckle, P., 3ft.; Clovers of sorts, 9in. to 18in.; Sainfoin, 18in.; Sedums 6in.; Vetch, 18in. Annuals should be sown now, and the others in June.

M. C. (Beddenham).—*Making W. B. C. Hives*.—You can obtain all instructions for making the above in the "Bee-keeper Practical Note Book," post free from this office, 1s. 1d.

J. D. (Warrington).—*Maggots in Combs*.—The bees have died from starvation, and the bodies becoming decayed have attracted flies, which, according to their habit, laid their eggs in the decomposed matter. The creatures you see are fly-maggots, therefore your bees have not caused the trouble.

E. H. L. (Hull).—*Ridding Skeps of Warmoth*.—Kill all the grubs you see before putting the skep on top of brood-chamber of new hive; an occasional examination, to see that none transfer themselves with the bees, will be advisable. The use of "Apicure" in the hive will kill them off effectually.

KING'S NORTON. *Dwindling Stock*.—The queen is a virgin. Please note change of address.

W. L. W. M. (Chatham).—*Renewing Brood Combs*.—After the second year, at least two sheets of comb foundation should be given to each colony. To do this, remove the two worst combs when making the first examination in spring, when naturally, they will contain no food; close up the eight frames remaining, by means of the dummy. When these are well crowded with bees, place the two new frames of foundation on either side, outside the brood nest.

J. A. (York).—*Unsealed Stores*.—As apparently the unsealed food has not harmed the bees during their confinement, during the winter, it is in wholesome condition, and now that the bees can take flights it will do no harm. The way to test for sourness is by tasting.

M. P. B. (Attleborough).—*Bees for Fruit-*

*fertilization*.—If you wish to establish the bees at once in your orchard you could buy a stock, or commence with a swarm in May. Either can be obtained from advertisers in our advertisement columns. We should advise your studying the "British Bee-keepers' Guide Book," before commencing.

"**BOTHERED WITH SWARMING.**" — *The "Alexander" Method*.—The methods followed in other countries are, as a rule, not suitable for our erratic climate. The plan has already been referred to several times in our columns. You can obtain full particulars in "Alexander's Writings on Bee Culture," which can be had from this office.

A. H. C. (Southampton).—*Small-holders' Clubs and Bee Disease Legislation*.—The B.B.K.A. are proceeding with a Bee Diseases Bill. A meeting of the Committee appointed to deal with the matter was held on March 16th, a report of which will appear in our pages shortly. We are pleased to hear of your endeavour to promote co-operation between your club and the B.B.K.A. on the subject of legislation, and wish all bee-keepers would do likewise.

J. B. (Middlesbro).—*Bees Short of Food in April*.—(1) There is very little for bees to get outside the hives at present. Feed with syrup, if you are afraid they are running short of food. On no account must you open the hive in cold and windy weather; but, on the first calm, warm day, make an examination, but even then get through the operation as quickly as possible. (2) We are sending you particulars of Insurance. (3) The County Bee-keepers' Association nearest is the Yorkshire. Write to the Hon. Secretary, Mr. W. E. Richardson, 14, Carter Mount, Whitkirk, Leeds.

COTTAGER (Tonbridge).—*United bees and Queenless colony*.—(1) It is impossible to say which of the two queens heads the colony, as you kept no record when you united the second and third swarms. (2) Your best way would be to unite the queenless colony to one having a queen. If you give them a comb of brood from another hive they may raise a queen if they have not been queenless too long. You would have to take the chance of there being drones ready to fertilise her. (3) Naphthol beta dissolves readily in methylated spirit, but the powder you send will not do so, and even pure alcohol has no effect upon it, so we think your chemist must have made a mistake. It is quite useless for making naphthol beta solution.

#### *Suspected Disease.*

F. S. (Worcestershire).—Through improper packing the bees arrived badly crushed. We could not examine them properly,

but from their appearance they may have died of starvation.

W. W. (Swindon).—Bees have evidently died from starvation.

A. C. H. (Lambourne) and "Sarumite."—The bees show every sign of "Isle of Wight" disease.

C. F. (Hants).—(1) The specimen bees were so dry that it was impossible to diagnose cause of death with certainty, but, so far as we can judge, they died of starvation. (2) These show signs of "Isle of Wight" disease.

BEE SWAX (Devon).—E. E. C. (Woodham Terrace)—and Scot (Falkirk).—Bees are affected with "Isle of Wight" disease. Destroy at once.

H. H. (Hampstead).—There does not appear to be any disease. The bees have been chilled by the cold weather.

E. A. H. (Epsom).—The symptoms are those of "Isle of Wight" disease.

### Special Prepaid Advertisements

Two Words One Penny, minimum Sixpence.

Orders for three or more consecutive insertions entitle advertisers to one insertion in "The Bee-keepers' Record" free of charge.

Trade advertisements of Bees, Honey, Queens, and Bee goods are not admissible at above rate, but will be inserted at 1d. per word as "Business" Announcements, immediately under the Private Advertisements. Advertisements of Hive-manufacturers can only be inserted at a minimum charge of 3s. per ½ in., or 5s. per inch.

### PRIVATE ADVERTISEMENTS.

**SEVERAL STRONG STOCKS** in good Hives, 1910 queens, 50s.—C. TOWNSEND, Lawnfield, Maidenhead. h 52

**FOR SALE, CASSELL'S TECHNICAL EDUCATOR**, 24 parts complete, 11s., or exchange one healthy skep bees.—LEWIS, St. Clears, Warburton-road, Brockley. h 51

**WANTED, SIMMINS' CONQUEROR HIVES**, warranted free from disease.—GILLMAN, Stapleford, Notts. h 44

**FOR SALE, Small APIARY**, comprising nine stocks of healthy Bees in modern 10-frame Hives, one lot in skep, four spare hives, and appliances. What offers?—COOPER, Michelmersh, Romsey. h 45

**HIVE complete**, with two supers, sections, feeder, smoker, gloves, veil and skep, 16s.—THOMPSON, Maybush, Felixstowe. h 48

**WALLFLOWER, strong plants**, 3s. 100; fine show Pansies, 1s. doz; Violas, named, 1s. doz.; Carnations, named, 6d. each; samples, 7d.—GORDON, Springboig, Shettleston. h 49

**PRIME STRONG SWARMS**, guaranteed healthy, May, 14s. 6d.; June, 12s. 6d.—BARFIELD, Broom, Biggleswade. h 42

**FOR SALE, four Stocks of Bees**.—Apply, T. NORWOOD, Thurning, Oundle. h 45

**FEW STRONG HEALTHY STOCKS FOR SALE**.—CLARKE, Polard's Hill, Norbury. h 46

**GLOUCESTERSHIRE BEE-KEEPER'S ASSOCIATION**.—CERTIFICATED EXPERT required to work in the district.—Apply, stating terms, to the Rev. F. H. FOWLER, Barnwood Vicarage, Gloucester.

**WANTED, CHOICE ENGLISH HONEY**.—Address L., "B.B.J.," 25 Bedford-street, Strand, London, W. h 40



## Editorial, Notices, &c.

### REVIEWS.

*Propolis*, by Dr. M. Küstenmacher. (Berlin: Berichte der Deutch. Pharm. Ges. Jahr XXI., Heft 1.). Of honey and wax as products of bees much has been written, but propolis has been neglected. The author of this monograph has taken the subject in hand with the result that he is able to throw a good deal of fresh light upon it. It has always been stated in bee-books that propolis was obtained from the buds and limbs of trees, and that it was carried like pollen on the hind legs of bees. The author on the other hand shows that it is the oil or balsam derived from the outer coating of pollen grains. In order to understand its origin he traces the development of the pollen from the primitive cells to the production of the colouring matter. With the appearance of colour the balsam begins to form, and it is this that appears later in the hive as propolis. This balsam flows between the cellular layers and covers the pollen cells generally with a yellow to reddish oil. In botany this oil has hitherto been called a "fatty oil" as it dissolved in alcohol. The author believes, however, that it is a balsam—i.e., a natural resin dissolved in ethereal oil, as he has been able to obtain it from many pollens from plants as well as from those brought into hives by bees, a fact which he has been able to demonstrate by chemical analysis. The author describes the way propolis is introduced into the hive and how it is elaborated in the stomach of the bee, also its use in comb construction and for other purposes of the hive. He attributes the different colours which wax assumes to propolis. Dr. de Planta, it will be recollected, attributed the colouring of wax to pollen, so that if propolis is derived from pollen it would corroborate Dr. de Planta's findings. The author goes very fully into all its bearings in relation to the bee community and shows its importance in the economy of the hive. Its chemical analysis and composition are carefully exposed and in the last chapter Dr. Küstenmacher shows why he considers that the source of propolis is not from the buds of trees. This monograph of 30 pages is certainly a valuable addition to our knowledge and shows that propolis is of very much greater importance to bees than has been hitherto supposed.

*Chrysanthemums*, by Richard Dean, V.M.H. London: Agricultural and Horticultural Association. Price one penny.

This book on *Chrysanthemums* by the late Secretary of the National Chrysanthemum Society adds a new feature of great value to the series of *One and All Garden Books*. The illustrations clearly

show the varieties of the popular flower, and help to explain the author's cultural instructions.

### AMONG THE BEES.

#### QUEEN'S.

By T. M. Macdonald, Banff.

As the queen is the parent of every bee in the hive it must be seen that the difference between a good and a bad one makes all the difference possible in securing the success and progress of the colony. One queen mother laying a thousand eggs in a given time must have an immense pull over another laying only a few hundreds in the same period. The first colony comes to the crest of the wave a long way ahead of the weaker one, so that the progeny of the better queen is fit for honey-gathering and storing at the auspicious period when forage yields its best, while the laggard, being weeks behind, fails to obtain a full force until the supply of nectar has run dry. Here is a high ideal to work up to. Endeavour to have all queens of the best.

I have from time to time given many different plans for introducing purchased queens, but I think, all things considered, for the majority of bee-keepers the caging method is the best and safest. The cages now generally used serve the purpose admirably, and the printed instructions accompanying them are so precise and lucid that even the beginner can follow them with the best results. When the imprisoned queen is enclosed with candy, covered with thin cardboard, requiring a fair period to elapse before the bees liberate her, there is scarcely any chance of non-success following the operation of introduction. All stocks should first, however, be carefully examined to make it positively certain that there is no virgin in the hive. In the majority of cases where failure takes place it can be attributed to the presence of an unsuspected unmated queen whose personality, however useless, the bees have come to hold in a measure of respect.

*Three Honey Recipes*.—I have forgotten the source of these, but I give them for what they are worth. (1) If threatened with a cold just before jumping into bed, take this drink. One spoonful honey, one half lemon juice stirred in a tumbler of boiling water. Drink as hot as possible. (2) For all burns, sores on the skin, chapped hands, and kindred ills take two table-spoonfuls of honey, one of camphor, a small piece of wax, all heated together, and then let cool. (3) For coughs and sore throats take one table-spoonful of spruce gum, pounded fine and dissolved in a pint of honey.

*A Very Old Bee*.—"In a sarcophagus in a museum at Cairo can be seen a bee with wings outspread, but whose legs are

glued to the linen stripes enveloping a mummy. The insect doubtless had been caught at the moment the embalmer was smearing the body, and that may have been 4,000 years ago. Time has respected the delicate structure of the bee, and she still remains as if quite ready to fly away."

Here is another extract dealing with bee-keeping in very ancient times. A nomadic people living thousands of years ago are being described. "They dwelt in the mountains under the shade of thick trees, and in caves, and other places that naturally afforded them a shelter and covering, the building of houses not being found out. They were very ingenious, and therefore invented many things very useful and profitable, for they were the first to teach how to manage flocks of sheep, and to tame and bring up cattle, and how to gather honey."

The concluding words convey to us the first germ of bee-keeping. Then, and for long after, it was a process of simply "gathering honey." Many and various were the domiciles in which the bees dwelt at that time. The clefts of the rocks, the carcass of a lion, and a site on a sheltered tree-bough are some of the places mentioned in ancient history. That honey was plentifully produced in these sunny lands of the Far East is abundantly proved by extracts I lately made from the Bible. The Koran also has much to say of bees and bee-keeping. "Bees are sacred insects, blessed by God, and placed above all His creatures after the human race." "She alone has the honour of providing with its pleasant scent a substance created to be used in hours of devotion, and which lights up the House of Prayer for all religions." "Led by her Creator in all she undertakes, it is useless to look after her; she knows what to do, nature advises her." Then honey is described as "His sweet, wholesome substance, which sustains and strengthens the body, and which cures all maladies." Truly a high eulogium on the bee, its honey, and wax.

*Shifting Hives.*—The best time to remove bees a short distance is after a long spell of cold or stormy weather, during which they have been kept close prisoners to their lives. They should be handled very gently, and carried carefully without in any way jarring the hives during their transit. It helps them very much to locate the new site if the entrance has a piece of glass, about twelve by six inches, placed slanting up to the entrance, so that they have to look about them when they first seek egress, and so mark their new bearings. They will be aided in this by further placing a board resting against the front of hive, or a green bough may be suspended above the entrance to fix in their minds that there is a change of

location to note. An excellent preventive of wandering back to the old location is to pack the entrance pretty closely with moss or dry grass. The bees make persistent efforts to find a way out, and gradually nibble the obstruction, when seeing everything strange on issuing they mark the new site of their future home. The new "Claustral" chamber in front of a hive serves the same purpose effectively. The beating and tossing about of the bees during the process of driving enables them to forget the bearings of their old home, and driven bees settle down anywhere quite contentedly. The same has been claimed for the lately invented system of "shaking" bees.

### LEICESTER B.K.A.

#### ANNUAL MEETING.

At the annual meeting of the Leicester-shire and Rutland Bee-keepers' Association, held at the Highcross Coffee House, Leicester, on April 1st, the 29th annual report presented by the Council, recorded that the work accomplished during the year and the financial position of the Society were satisfactory, having regard to the fact that the past honey season, although somewhat better than the three preceding ones, had been unfavourable for bee-keeping in all parts of the country. During the year thirty-six new members were enrolled, and the number on the books was now 301, compared with 321 in 1909. The receipts during the year amounted to £75 12s. 3d., and there was a balance in hand of £7 4s. 9d.

Mr. E. J. Underwood (Leicester), who presided over a good attendance of members, pointed out that while the financial position remained about as it was a year ago, they had lost a number of members owing to the bad season, and in some cases to a want of regard for the work of the association. He emphasised their desire to encourage a more intelligent culture of the bee, and to extend interest for the love of the cult, so that they might preserve to the country-side some of those pleasures which bound men to their homes.

A vote of thanks having been accorded the retiring officers, Lady Levy was again elected president, and Mr. A. E. Biggs (Cropstone) was chosen chairman for the year in succession to Mr. J. G. Payne. The Executive Council was constituted by the election of Messrs. S. Clarke, J. G. Cotton, G. W. Dunn, J. Fewkes, J. Hayward, C. Halford, E. A. Jesson, G. J. Levers, A. J. Marriott, A. Spencer, J. Thompson, T. H. Wright, W. H. Wood, with Messrs. W. P. Meadows, J. E. Roper, and E. J. Underwood as hon. past chairmen.

Other officers appointed were Mr. W. K. Bedingfield, hon. treasurer; Mr. E. J. Underwood, hon. auditor; Mr. John Waterfield, hon. secretary.

Mr. Falkner and Mr. Meadows presented reports as delegates to the British Beekeepers' Association.

After tea the programme included a lecture on "Bee curiosities and green-craft," read (in the absence of Mr. W. K. Bedingfield, through illness), by Mr. Morris. There was also a paper on "Difficulties and pleasures of expert work," by Mr. F. H. Hubbard, and the introduction of novelties and matters of interest by Mr. W. P. Meadows.

## Correspondence.

*The Editors do not hold themselves responsible for the opinions expressed by correspondents. No notice will be taken of anonymous communications, and correspondents are requested to write on one side of the paper only and give their real names and addresses, not necessarily for publication, but as a guarantee of good faith. Illustrations should be drawn on separate pieces of paper. We do not undertake to return rejected communications.*

### THE "ISLE OF WIGHT" DISEASE.

[813] The warmest thanks of the bee-keeping community are due to Dr. Madden for his painstaking and laborious endeavours to throw some light upon the distressing trouble that has overtaken so many of your readers and others.

Fortunately, having had no personal experience with this new disease, I am not in a position to say that a cure can positively be effected; and, like others, I am still in the dark as to the origin of the complaint. Nevertheless, I am convinced the trouble can both be kept under and ultimately cured if bee-keepers will only take reasonable precautions.

I fear there have been some loop-holes left open through which the plague has been enabled to escape from earlier sources, and thus attack many apiaries that might otherwise to-day have remained healthy and prosperous. It appears to me that the Committees of the various Bee Associations should at once take some effective measures to help prevent the spreading of this new disease.

To my mind the most important of these is that an expert should have strict injunctions to cancel any further visits to other apiaries should he come across a case, or a suspected case, of "Isle of Wight" disease during his tour of inspection.

Next, I need hardly propose that should any recognised or appointed expert himself have the same disease in his apiary

he should be at once restrained from visiting other apiaries, though his own common-sense would probably save him from such a blunder.

Moreover, until we know and fully understand the nature and course taken by this particular disease germ, foundation manufacturers will be benefiting themselves, as well as studying the interests of their clients, if they studiously decline to buy wax from known sources of infection; or better still, let them insist upon a guarantee that the wax offered them does not come from such depleted apiaries.

Finally, as far as possible, bee-keepers should be discouraged from visiting other apiaries when that of either may be known to have the "Isle of Wight" disease.

It goes without saying that the sales of bees or tenantless hives from infected districts is a matter that would not be entertained by any conscientious person.

Now, it is to be noted that late in the summer of 1908 Mr. H. M. Cooper made a tour of inspection along the coast of the mainland, and was unable to discover a single case of the "Isle of Wight" disease, but in the following summer the disease was found to be prevalent in the counties nearest the Isle of Wight. This visit of Mr. Cooper's is a matter for the most serious consideration, and we may well ask if that visit of inspection had anything to do with the outbreak on the mainland. Had he recently been in an infected apiary as well as coming from an infected district? Had he recently carried out any experiments with the disease, and did he take with him his own veil (if one) or his smoker? Did he wear the same boots or clothes he may have used in his own diseased apiary?

All these points may be satisfactorily cleared up, but they should in any case tend to throw some light on the methods of spreading the disease unconsciously by bee-keepers.

I had never accepted Mr. Woodley's theory that brood diseases were spread by experts, as simple precautions, well known to them, would usually avert any trouble in that way; but this new disease is so far a baffling one, and probably spreads more easily by contact (or without direct contact) than the older and well-known trouble.

The map illustrated in the March 30th issue of the "B.B.J.," showing how the disease spread in successive years over the Isle of Wight, is of considerable interest; but that of the mainland is indefinite, and neither helpful nor instructive, to my mind. Notwithstanding one doubts the wisdom of blacking whole counties when large areas thereof remain free of the complaint, we must agree with the Editor

and Dr. Malden that there were obstacles in the way that made it most difficult, if not impossible, to clearly define the districts actually affected; or even more so, to show the order in which they became so.

With the true spirit of the scientist and the born investigator, Dr. Malden has pursued his researches, not hesitating to attempt the infection of healthy bees, though without success. May it be that he has not yet secured the really mischievous germ? Many normal colonies will have an occasional bee after winter, or during a long, cold spell in spring, that has the appearance of the bees he describes, and though not always worn out, these have every appearance of being paralysed. After a warm spell, nothing more of the kind is to be seen. I shall look forward with interest, and in earnest anticipation, with regard to Dr. Malden's further investigations.—SAMUEL SIMMONS, Heathfield, Sussex, April 15, 1911.

#### FOUL BROOD AND DISINFECTIOIN.

[8132] Referring to Mr. R. Whyte's letter in your issue of Jan. 5th last, page 8, wherein he appears to support the views of the anonymous writer in the "Canadian Bee Journal" for October last, re disinfection in New Zealand, I must ask that gentleman to read my reply in the same Journal for January; he may then modify his opinion of the value of the anonymous writer's statements.

The general consensus of opinion is overwhelmingly in favour of disinfection of hives and all appliances that have been in contact with diseased bees. I cannot call to mind a single scientific investigator of bee diseases who does not recommend disinfection; and I would ask, are the opinions of such investigators as Drs. Maassen, Burri, Zander, G. F. White, Messrs. Imms and Cheshire and others, to be set aside in favour of those of a few laymen? I have nothing to say against those who believe they have good reasons for the faith that is in them, but until the matter is finally set at rest by a thorough and complete investigation, scientifically and practically, I am going to follow the advice of those gentlemen quoted, and disinfect.

Mr. Whyte, in drawing attention to a communication of mine in October "Gleanings," in which a Digest of our Apiaries Act is given, seems surprised, seeing that I am in favour of disinfection, that no mention of it is made in the Act. He says: "If disinfection was an essential part of the treatment in eradicating foul-brood in New Zealand, would it not be mentioned in this Digest?" My reply to Mr. Whyte's query is that in putting it

of including any schedule of treatment in an Apiaries Act. I was fully aware of this when dealing with the draft; had I inserted any part of a treatment to be made compulsory it would have appeared meaningless unless the whole treatment had been included.

Supposing for a moment that the McEvoy or some other treatment had been made compulsory, there would have been nothing to hinder an unscrupulous person who had done nothing to rid his bees of foul-brood saying:—"I have treated my bees according to the instructions in the Act, and, cured or not cured, there they are." A nice muddle would result, for his word would count for as much as an inspector's in court. All mention of the kind of treatment was purposely left out; the use of frame hives, however, is compulsory, and also that where there is a possibility of cure the bee-keeper must undertake to get rid of the disease. The treatment is left entirely to himself, and all that I have done in my bulletin, apart from the Act, is to suggest or recommend the McEvoy method as having been tried and proved to be effective, together with disinfection. Who knows what to-morrow may bring forth? Any present treatment may be superseded, therefore, in my opinion, all Apiaries Acts should be free in this respect. I am pleased to see the Editor holds sound views of bee legislation and disinfection.—J. HOPKINS, Auckland, New Zealand, March 10, 1911.

[We have ample evidence to show that disinfection of hives and appliances is necessary, and in the Guide Book have repeatedly stated that this starvation method, good as far as it goes, has failed from the fact of its not embracing disinfection of hives and appliances. Knowing, therefore, the risk run, we shall continue to recommend disinfection.—Ed.]

#### "ISLE OF WIGHT" DISEASE.

[8133] It is a great pity that isolated outbreaks such as that described by Mr. Woodley on page 137 are not investigated at the time. The account of trouble differs considerably from that given on page 135 by Mr. Macdonald. In the latter case none of the imported bees appear to have been affected, as it is improbable that any of the original swarm (with the exception of the queen) was alive when the disease manifested itself. Unsuitable food would account for the facts given, but if we accept the statement that, in the latter case, it was caused by a germ, it is difficult to understand how we can be certain that the honey was contaminated. If the hive carried the disease there seems a possibility that the frame round the honeycomb would do so.

Although I am hopeful that the matter will be cleared up this season, and foresee the possibility of a new contagious bee disease being in our midst, I cannot overlook the fact that these heavy losses have occurred in the past owing to bad seasons. It is a curious fact that may mean much or nothing that the South of England, East Anglia, and Wales have had a rainfall far in excess of the average. This is also true of part of Yorkshire, so that a map showing the wettest and driest counties for 1910 will roughly resemble a map showing the progress of "Isle of Wight" disease. Much of the bee mortality is due to the weather, and the only question is whether all the cases that come up for investigation are not of that class. Several writers in "Gleanings" complained of a similar trouble last year, and it is noteworthy that Mr. J. M. Pulley, in an article published October 1st, gives his experience that it is correlated to wet weather. He suggests sugar syrup as a remedy, and this might prove effective in some of the cases over here.

There is no means whatever of differentiating "Isle of Wight" disease from any other form of bowel stoppage. When a case can be found which will convey the disease to another stock at the will of the experimenter we shall have made a big advance in the solution of the problem.—G. W. BULLAMORE, Albury, Herts.

#### FRUITGROWERS AND BEE DISEASE.

[8134] Herewith I send you a copy of a letter I have sent to the *Fruitgrower* re the "Isle of Wight" disease. The aforementioned paper, which is the real live organ of the British fruit-growing industry, has lately been giving the subject of this fell disease its attention, and was last week lamenting the impotence of the Board of Agriculture to issue any order for destruction of diseased stocks. If my scheme for relieving the present distress meets your approval, will you lend it the weight of your advocacy?—Yours truly, H. E. SCROPE VINER.

[Copy.]

Overbury Fruit Farm,

Nr. Tewkesbury.

To the Editor of "The Fruitgrower."

I see you are taking up the subject, most important to both fruitgrowers and bee-keepers, of the new bee disease, known as the "Isle of Wight" disease, and hope as a result there will be some concerted action on the part of all concerned to get this plague stamped out before it is too late.

You say the Board of Agriculture have no power to deal with the matter. While they may have no power to enforce destruction of all diseased stocks and affected

hive-fittings and skeps, there is a course of *immediate* action open to them which I may suggest, and which would, I believe, prove of great benefit.

Cannot the Board publish a *short* leaflet giving in *clear, concise* language a description of the symptoms of the disease, and ending with a forceful recommendation in the interests alike of owner and neighbour to destroy all stocks showing signs of suffering from it? These leaflets, carrying all the weight of authority of the Board, could then be handed over to the British Bee-keepers' Association, and by that body passed on to the various county B.K.A.'s throughout the country, whose individual members, assisted by all other intelligent bee-keepers, would, I am sure, undertake to see that every bee-keeper in their immediate neighbourhood had a copy. Are we not getting too much into the habit of sitting inactive waiting for the Government to do everything for us, and is it not better to first try the effect of education and persuasion, instead of resorting at all times to arbitrary force in matters affecting the good of the community? Whatever is done should be done *at once*, before another bee season has commenced, and spread the disease to at present unaffected districts.—H. E. S. VINER.

[We need hardly say that we thoroughly approve of any means that will tend to arrest or cure this disease, and will give it our hearty support. It is true that the Board of Agriculture have no power to enforce destruction of diseased stocks. They can, however, issue such a leaflet as our correspondent suggests, and, as the matter has already been represented to them, we hope that it will not be long before such leaflets are ready for circulation.—Ed.]

#### PAINTING HIVES.

[8135] Good boiled oil and white lead will not rub off in the manner stated by D.M.M. (page 103). I always use this as the body of my paint and have not been troubled by its rubbing off. Some 30 years ago a friend who was managing a smelting works told me he had found a paint which was far better than lead-paint for resisting the atmosphere. He gave me the name, but I have forgotten it, not being, at the time, much interested in paint. Perhaps some reader knows of such a paint.

*Bees and Smoke.* I was much surprised a few days ago when burning some weeds to see a bee hovering round and persistently keeping in the smoke, it then settled on the heap of rubbish on the lee side where smoke was issuing and sucked up the moisture. Is it only in the hive that smoke agitates them?

*Increasing Stocks.* I have five stocks and propose increasing to eight this season, at the same time securing as much surplus as I can. The plan I contemplate is to let the strongest stock swarm, and then divide the parent stock into three, putting three frames into each of two fresh hives, and filling up with frames fitted with foundation. Do you approve of the method?—W. A. C., Castle Cary.

[Your plan of increasing stocks might work out successfully, but a better one would be to make a nucleus as early as possible; when the queen is fertilised, make a nucleus swarm from the strongest stock. When these two have worked up into strong lots, make an artificial swarm from each. If you could obtain a couple of fertile queens to introduce to the stocks directly after the artificial swarms are made success should be assured.—Ed.]

#### THE "ISLE OF WIGHT" DISEASE.

[S136] All bee-keepers must have read with intense interest Dr. Malden's address on the above subject to the British Bee-keepers' Association. The article in the *Record* for April is headed: "The New Epidemic Among Bees," while the Editor, in the same issue, seeks to administer consolation by pointing out that "similar epidemics have occurred before, but bee-keeping has recovered in those places which had been devastated." Are we to understand, then, that the disease is only an old enemy under a new name? I venture to submit that the latter is the case, and that the mysterious outbreaks of disease dealt with by old writers differ only in name from that which is spreading gloom through the community of bee-keepers at the present time; and further, that the *fons et origo mali* is the weather. If spraying field-crops with sulphate of copper were at the bottom of the mischief it is unthinkable that bees should have escaped in countries where spraying is practised as commonly as in infected countries; moreover, it is physically impossible that a mineral poison should cause an infectious or contagious disease. It certainly seems reasonable to suppose that the introduction of foreign strains from milder climates should have produced a race of bees less capable of withstanding the rigours of our climate, nor is it sufficient answer to reply, as some have done, that foreign bees were introduced many years ago, if former outbreaks of disease were identical with the present one. Dr. Malden has come to the conclusion that the disease "must be of an infectious nature communicated in some way or other from bee to bee," but he is unable to agree that it is "due to low temperatures, wet weather, and

absence of honey flow." And yet the latter theory seems reasonable enough, especially if it be granted in addition that pollen may become unwholesome or diseased by the action of unfavourable weather conditions. Of course, there is the grave objection that the complaint should have been, so far as is known, confined to the Isle of Wight for at least four years, although much the same weather conditions prevailed in the mainland; but might not the same be said of "the plague," the bacillus of which is said to resemble that of the bee disease? How can one account for the plague originating from certain definite spots, and spreading thence as an infectious disease, although the same unhealthy and malarious conditions must have prevailed widely in the East? I speak under correction, but there appears to be some analogy between the two cases. It is noteworthy that the cycle of bad weather, from which we are suffering now, began in 1903—the year of the remarkable rainfall; and the features of this cycle have been—damp and mild winters, cold springs, cool and sunless summers. These are the very conditions, as everyone knows, adverse to bees—dependent as they are for their health and very existence on warmth and sunshine in spring and summer—and susceptible to damp, far more than to cold, in winter. Statistics are wearisome, but they are necessary to support my contention. In 1903, January, February, March, October, and November, had a temperature slightly above the average, the other seven months were all below the average as regards temperature, April, June, and July especially so; in 1904, every month was colder than the average, except January, which was a fraction of a degree warmer; in 1905, February and March had a temperature above the mean, while that of the other ten months was below; in 1906, the mean temperature of all the months was below the average, except in the case of January, August, October, and November; in 1907, March, November, and December were slightly warmer than the average, the other nine months were colder; in 1908, February, October, and November, were above the average for temperature, May was exactly normal—all the other months were below; in 1909, every single month was colder than the average, with the sole exception of October; in 1910, January, February, October, and December were warmer than the average, the other eight months, being below the normal for warmth. The wonder is that bees have survived at all! The inference is that plenty of sunshine and reasonable warmth will destroy the germs of disease, aided by the unselfish and enlightened efforts of the bee-keepers

themselves. May Coronation year, and "King's weather," inaugurate better times for bees and their masters!—F. H. FOWLER.

## HOMES OF THE HONEY-BEE.

### APIARIES OF OUR READERS.

We have pleasure in presenting to readers a picture of the apiary of Mr. G. Kennedy, and as we have visited the same we can say it is thoroughly up-to-date in every respect. The description given shows what village lads can do if they are energetic and willing to make the most of their opportunities.

Mr. Kennedy sends some interesting notes to accompany the picture, and writes as follows: "I have for some time been an ardent reader of the "B.B.J.," which has added much to my knowledge in the craft of bee-keeping.

a rack of sections. Unfortunately the weather became bad, and therefore very few of the sections were completed.

This hive having been well prepared for winter came out very strong the following spring. As we wanted increase, we left it to swarm, and by the end of the season we possessed three stocks of bees in good condition, with provision for the coming winter, besides having obtained sufficient honey for our own use and for friends.

Fortunately, at the end of this our second season, Mr. W. Herrod came to give a course of lectures for the County Council on bee-keeping in a neighbouring village schoolroom, and as we wished to increase our knowledge we attended, and by this means we soon gained a fair knowledge of the subject, for which we are deeply indebted to our instructor.

In our third season we felt quite capable of managing a much larger apiary, so



MR. G. KENNEDY'S APIARY, ODELL, BEDS.

I have been particularly interested in the various experiences shared by many as related in the "Homes of the Honey-Bee" articles, and think that a brief outline of my own career as a bee-keeper may be of some interest to your numerous readers. I first became enthusiastic about bees nine years ago, when at work with a friend (whose parents kept bees), who on being told that a swarm had issued from one of his father's hives, asked me if I would like to assist him in taking it. Having been successful in the new enterprise, we decided to become partners, and then took possession of a bar-frame hive properly fitted up, the ten frames having full sheets of "Weed" foundation. In the evening we allowed the swarm to enter the prepared hive. At this time the weather was very favourable for bees, and there being plenty of forage around, our swarm soon filled the brood-chamber and required more room, so we gave the bees

year by year we invested money in buying bees and eventually became possessed of from thirty-five to forty stocks.

The apiary at the present time contains twenty-three frame hives and two straw skeps. The majority of the hives are home-made, and of the "W.B.C." pattern, which we strongly advocate and hope eventually to use no other type than this simple yet efficient hive.

The apiary is not situated in the best of bee districts, therefore we cannot boast of big "takes," the largest being about 50 lbs. from any individual hive, but this we consider very fair for this district. The main crop is obtained from limes and clover, the limes being the principal source. One great disadvantage is that our bees have such long distant flights to the forage, which, of course, hinders the work considerably.

Although our crop has never been large, we have always had honey of the best

quality, which is proved by the numerous prizes we have taken at the local and other shows.

We find no difficulty in disposing of our produce; in fact, we never get enough to supply the growing demand of our customers.

For several years past we have raised our own queens, but this has been very tedious work, owing to the adverse weather, which has made it most difficult to get the queens mated.

For the last two years we have made bee-keeping more of a business than a hobby, and have the management of a good number of apiaries, consisting of several hundred stocks, and often we are called upon to examine bees. Yes, alas! how often, too, to find them suffering from that dreaded malady "Foul Brood," and we have gained considerable experience in dealing with this most contagious disease, with, in most cases, complete success.

At the time of writing we know of hives which last year were contaminated with disease, and regret to say we have been unable up to the present time to induce the owners to destroy them. Therefore, we are of opinion that bee-keeping is handicapped to a very great extent, and will be more so in future unless an act is passed to enforce the destruction of diseased stocks; and we shall welcome such legislation.

Four years ago our apiary had an attack of "Odourless Foul Brood," which, however, is easily cured. Since this we have made special efforts to keep out disease by keeping our stocks strong, by medicating all syrup and candy, by having naphthaline in the hives, and since the invention of "Apicure" we make it a rule to keep this in the hives too, renewing it as required. I may mention that Mr. R. S. Askew, my late partner, has emigrated to New Zealand, where he hopes to follow up this same pursuit.

---

## Queries and Replies.

---

[4115] *Mice in Hives*.—I take several bee papers, but can find nothing in them to enlighten me as to the following strange occurrence: About a month ago, on a very fine day, I changed one of my two stocks of bees from an old hive to a newly painted one, and placed it within a couple of yards of its old position. The bees seemed to settle down at once. There was plenty of stores in the combs at the top corners of the right-hand side, and I also put in a cake of candy. I kept the entrance well open, but on return of the cold weather I closed it to within  $\frac{1}{4}$  in. On

my morning and evening visits, especially during the past week, I have noticed a considerable amount of débris about the lighting-board ejected from the hive, but put it down to spring cleaning inside. On Saturday last, not seeing much signs of activity, I looked inside, and was surprised to find the stock reduced to about a quarter, or less, than the former numbers; the bees crowded into a foodless part of the combs, were all dead, with the exception of about half-a-dozen—candy untouched. The greater surprise, however, was finding a mouse-tail gnawed off, apparently at the stump. The combs were all badly bored, honey and wax was eaten wholesale, and one of the sliding opening bars was gnawed as if the mouse, having been imprisoned by my reducing the opening, had made its own way of escape. Would you kindly let me know if you think the bees have simply been frightened off their food and out of the hive to starve, by the depredations and smell of the mouse? Do you think they are diseased? If the latter is the case I suppose you advise the destruction of the whole lot. In the meantime, I am hunting a "manx" mouse and its progeny, bristling, I hope, like a poreupine with stings.—D. B., Ormskirk.

REPLY.—There are signs of constipation in the bees, but we should say the main cause of death was the depredations of the mouse. The combs will not be worth saving; burn them and disinfect the hive well before using again.

[4116] *Bee-farming as a Business*.—If the following questions are not considered absurd, answers to them through the columns of your much-appreciated paper will be welcomed by a "Budding Apiarist": (1) Can Bee-farming pure and simple, be made to pay commercially in England at present? (2) What, in their order of merit, are considered the best bee counties? (3) How many colonies in a year, when the honey-flow is ordinary, would one require to have to make a living out of bees.—A. H., Skye.

REPLY.—We are at all times pleased to help our readers, and your questions are anything but absurd: (1) Climatic conditions, so variable in this country, prevent bee-keeping alone being lucrative enough to be the sole means of livelihood. (2) All the following counties are good: Suffolk, Norfolk, Cambs., Lincs., Berks, Hants, Kent. (3) In a good season and district each hive will give an average return of twenty shillings if properly managed.

[4117] *Curious Behaviour of Bees*.—May I ask for your invaluable advice on a point of difficulty? I have a skep occupied by a last season's "cast." I have



seen so few bees throughout the winter that I almost thought they had died off. A week ago to-day I cut a small hole at the top of skep and placed a cake of medicated candy there, and after two or three hours three bees had come up.

At 2.30 this afternoon, in sunshine, to my surprise, bees poured out of the entrance until the air was full of them, and then nearly all suddenly sank to the ground, settling on bushes, grass plants, and ground generally, leaving about a dozen flying at the entrance. Horrible visions of "Isle of Wight" disease seized me, when the bees, as suddenly, all rose and crowded back until the large board on which the hive is fixed was black with them. When nearly all had passed in the queen suddenly appeared round the back of the hive and passed in with the remainder, *apparently* unnoticed by the workers. They are now distinctly irritable, objecting to anyone standing near. Can you explain this behaviour, and why the queen was walking about outside the hive, why bees should have settled on the ground even as far as 12ft. away, apparently at a given signal, to return? What am I to gather from this behaviour? I placed naphthaline on the floor-board, pushing it well back, four months ago, as the skep with bees was given to me. I know the skep is a very old one and *possibly* with diseased combs.

I had already carefully closed up all cracks at the base, and there is only one possible doorway, so the queen must have come out by the front door and walked round the skep on the floor-board outside.—INTERESTED, Branscombe.

REPLY.—The bees were no doubt short of stores, and this accounts for their action. When this is the case in March they will sometimes come out and cluster exactly as a natural swarm would.

[4118] *Charlock-spraying and Disease.*—Was charlock sprayed with sulphate of copper in the Isle of Wight four years before any spraying was done on the mainland? The answer to this seems to me a sufficient test, if spraying is the cause of the disease. Many thanks for reply to last letter. I have destroyed everything in hive. Is the feeder I used last autumn likely to be infected? Unfortunately I do not know which I used on this hive.—A. P. W., Alfriston.

REPLY.—In answer to the first part of your query we cannot say. Disinfect *all* appliances most thoroughly before using again.

[4119] *Increase—Disinfecting Hives.* I should like a reply to the following questions, in the "B.B.J.," which I take every week and look for it with pleasure: (1) I have lost five stocks of bees, and having

one left alive, I am anxious to try again. Would you advise me to wait for a natural swarm, or to work up to get an artificial one, if it can be done from my own hive? (2) I would like to disinfect the empty hives so that they will be fit for use this summer. Would washing with carbolic acid, soft soap, and boiling water, afterwards putting them out in the air to dry, answer the purpose? If so, what proportion of carbolic should I use?—W. D., Hershham.

REPLY.—(1) Proceed to make a nucleus as early as possible, then when the queen is fertilised make a nucleus swarm. (2) The best way to disinfect hives is to scorch the inside with a painter's spirit-lamp, or, failing this, wash the hive with paraffin, set it alight, and when scorched put out the fire by smothering with a wet sack. Fire is the best disinfectant known.

### THE POLLINATION OF FRUITS.

#### SUGGESTIONS FOR EXPERIMENTS WITH THE OBJECT OF GAINING PRACTICAL INFORMATION.

1. Choose flower buds of apple, pear, plum or cherry, a few days before the blossoms expand, open the blossoms and destroy the anthers by carefully removing them, and when the blossoms are fully expanded (a) pollinate half the flowers with pollen from a different variety of the same kind of fruit; (b) leave the other half to the care of the bees and see which gives the best result. (An experiment of Thomas Andrew Knight, 100 years ago.)

2. Place paper bags over bunches of flowers of apple, pear, plum and cherry of different varieties before any flowers open, and tie so as to exclude insects, then notice whether they set fruit with their own pollen—i.e., are "self-fertile," or do not set fruit—i.e., are "self-sterile."

3. Choose some of the best market varieties of apple, pear, plum and cherry, two sets of blossoms on each variety, selecting two or three unopened flowers; in group A, when these flowers are nearly ready to open, twist off petals, and snip out stamens with small sharp scissors with long handles by preference, or pull out with tweezers; then pollinate stigmas with pollen of some other good market variety, either by touching with anther or with pollen on spatula or brush, then bag and tie, label and note in book. In the case of group B, treat flowers in a similar way, but pollinate with pollen of the same variety, label (with number, date and what has been done) and keep paper bag on for, say, three weeks or more. When mature, notice whether the blossoms receiving foreign

pollen produce better fruit than those which received pollen of the same variety, also examine the number and size of pips in the apples and pears in each case. It is recommended that the flowers to be used as pollenizers should have bags placed over them before they open, so as to be sure of the pollen being absolutely true; a twig of flowers for pollen may be cut off, placed in a jar of water and kept indoors or in the glasshouse, for convenience in collecting pollen; pollen can be placed and kept in a small bottle if quite dry.

4. In order to ascertain which varieties are good pollenizers apply the pollen of one variety of say apple or pear to different varieties of the same; also try the different pollens on some good variety, such as Cox's Orange Pippin or Williams' Bon Chretien pear, to find the best pollenizers for these varieties.

Preferably make all trials in duplicate.

5. In the case of berry fruits, such as gooseberry, black and red currant, strawberry, raspberry, blackberry, loganberry, place muslin or paper bags over some unopened blossoms to exclude bees and note result as to whether any fruit sets, whether seeds are smaller, whether fruits are more juicy.

Please send record of your trials to the "B. B. J.," or any horticultural paper or journal, or to Cecil H. Hooper, Fern Villas, Wye, Kent.

#### TRADE CATALOGUES RECEIVED.

C. T. OVERTON AND SONS. *Crawley, Sussex*.—This catalogue, which can be had on application, post free, is replete with every requisite for the beekeeper. It also includes poultry houses, incubators, greenhouses, and rabbit appliances.

#### WEATHER REPORT.

BARNWOOD. GLOUCESTER.

March, 1911.

Rainfall, 2.08 in.	Coldest nights, 16th, 25.
Above average, .53 in.	Mean temperature for month, 41.9; .6 of a degree below average.
Heaviest fall, .66 in. on 12th.	Relative humidity, or percentage of moisture in the air at 9 a.m. 87.
Rain fell on 19 days.	Number of days with sky completely overcast at 9 a.m. 17; do. cloudless, 2.
Total to date, 4.39 in., as compared with 6.35 ins. for the corresponding period of last year.	Percentage of cloud 73.
Mean maximum temperature, 47.9; .1 of a degree below the average.	Percentage of wind force, 29.
Mean minimum temperature, 35.9; 1.1 deg. below the average.	Prevailing direction, N.E.
Warmest day, 2nd 59.5.	

F. H. Fowler (F. R. Met. Soc.).

## Notices to Correspondents.

J. S. (Frampton).—*Early Queen-Mating.*

—There is just a possible chance of the queen being fertilized. No, this is not a record, as we have seen queens reared earlier than the date you give, but as a rule they are not of much use.

T. G. D. (Loughboro).—*Bees and Neighbours.*

—There is no danger whatever to your neighbour if the hive is placed in the position indicated in your plan. He ought to be grateful to you for keeping bees, as undoubtedly his fruit trees will be greatly benefited by their visits. You can insure against damage. The Sec. of the Leicestershire B.K.A., Mr. J. Waterfield, Jr., Kilworth, Leicester, will send you particulars if applied to.

#### SUSPECTED DISEASE.

J. H. B. (Lincoln).—The bees have died from "Isle of Wight" disease.

A. J. S. (Somerset).—The bees are all constipated, and there also appear signs of "Isle of Wight" disease.

B. (Herefordshire).—(1) "Isle of Wight" disease has been the cause of death, not suffocation. (2) We should not advise you to use the combs again; it is best to destroy them, together with all the internal fittings of the hive, which should then be thoroughly disinfected.

#### Special Prepaid Advertisements

Two Words One Penny, minimum Sixpence.

Orders for three or more consecutive insertions entitle advertisers to one insertion in "The Beekeepers' Record" free of charge.

Trade advertisements of Bees, Honey, Queens, and Bee goods are not admissible at above rate, but will be inserted at 1d. per word as "Business" Announcements, immediately under the Private Advertisements. Advertisements of Hive-manufacturers can only be inserted at a minimum charge of 3s. per ½ in., or 5s. per inch.

#### PRIVATE ADVERTISEMENTS.

QUEENS. Six young, healthy, fertile, native queens, 4s. each.—HILLMAN, Stonehouse, h 55

WANTED, EXTRACTOR; also Uncapping Knives. Particulars and lowest prices.—HARGREAVES, Knottiswood, Todmorden. h 53

WHAT OFFERS FOR PLATE GLASS TROPHY STAND, up to date, taken first prizes at the County Show.—WOOD, expert, Arnold, Notts. h 57

SEVERAL STRONG STOCKS on 8 Frames, guaranteed healthy; no Hives; £1.—L. MATTHEWS, Gt. Rollright, Oxon. h 54

BEEES FOR SALE, on frames, 17 Stocks.—GARWOOD, Ptr. Heigham, Gt. Yarmouth. h 58

SEVERAL STRONG STOCKS in good Hives, 1910 queens, 30s.—C. TOWNSEND, Lawfield, Maidenhead. h 52

## Editorial, Notices, &c.

### BRITISH BEE-KEEPERS' ASSOCIATION

The monthly meeting of the Council was held on April 20th, 1911, at 23, Bedford Street, Strand, London, W.C. Mr. T. W. Cowan presided, and there were also present: Miss M. L. Gayton, Messrs. W. F. Reid, A. G. Pugh, E. Gareke, E. Watson, C. L. M. Eales, J. Smallwood, A. Richards, T. Bevan, R. T. Andrews, J. B. Lamb, J. E. Smiles, and G. W. Judge (Crayford), L. McNeill Stewart (South Beds.), and W. Herrod (Secretary).

Letters expressing regret at inability to attend were received from Col. H. J. O. Walker, Messrs. O. R. Frankenstein, and E. Walker.

The minutes of the Council meeting held Feb. 16th were read and confirmed.

The following officers were elected:—Chairman, Mr. T. W. Cowan. Vice-chairman, Mr. W. F. Reid. Finance Committee: Messrs. T. Bevan, C. L. M. Eales, A. Richards, J. B. Lamb, J. Smallwood. Exhibition Committee: Messrs. T. Bevan, C. L. M. Eales, O. R. Frankenstein, A. G. Pugh, E. Walker, E. Watson. Publication Committee: Messrs. T. Bevan, E. Gareke, J. B. Lamb, W. F. Reid, J. Smallwood. Emergency Committee: Messrs. W. F. Reid, J. B. Lamb. Committee to help Dr. Malden: Messrs. A. Richards, J. Smallwood, E. Walker and the Secretary.

The following Associations applied for affiliation and were accepted:—Mid. Kent, Hertford, Ware and District, South African Association, The Pretoria and District B.K.A., South Africa.

The following new members were elected:—The Honbl. Rose Booth Wilbraham, Blythe Hall, Ormskirk; Miss F. M. Durham, 7, Cannon Hill, Terrace, Merton Park, London, S.W.; Miss M. V. Holmes, Powis Castle Park, Welshpool; Mrs. E. A. Birch, Brandize, Okelhampton, Devon; Mrs. Barry, Clifford Vicarage, Boston Spa R.S.O., Yorks; Mr. S. Moon, The Cottage, Chessington, Surbiton; Mr. A. Beetham, Bishop Monkton, Leeds; Mr. P. M. Ralph, 2, High Hill Grove, Settle, Yorks; Mr. G. G. Desmond, 109, Grove Lane, Camberwell, London, S.E.; Mr. W. H. Sims, Darley Dale, Stratford Road, Hall Green, Birmingham; Mr. G. Thomas, Coedmelyn, Stackpole, Pembroke; Mr. S. Simmins, Queenland, Heathfield; Rev. T. H. Haynes, Staunton Rectory, Glos.; Mr. T. O. Greenwood, Pretoria, South Africa; Dr. W. E. C. Musson, L.R.C.P., M.R.C.S., 61, Bridge Avenue, Hammersmith; Mr. F. C. Holmes, Powis Castle Park, Welshpool; Mr. W. Lloyd, 2, Bank Road, Lancaster; Mr. G. Bryden, 46, Star Hill, Rochester; Mr. G. H. Ceiley, Caythorpe, Fortis Green,

London, N.; Mr. E. R. Bodey, 6, Haycroft Road, Brixton Hill, London, S.W.; Mr. J. C. A. Nesbit, 32, Stracey Road, Harlesden, London, N.W.; Mr. J. W. Eggleston, Reservoir House, Consett, Durham; Mr. H. Goude, F.R.H.S.; East Dereham, Norfolk; Mr. A. J. Griffiths, Post Office, Trimisaran, Kidwelly, Carmarthen; Mr. H. Edwards, 22, Carnarvon Road, Reading.

The following names of delegates were submitted and approved: Mr. A. R. Moreton and Mr. J. P. Phillips (Worcester), Dr. P. Sharp (Lines.), Mr. J. N. Kidd and Capt. Sitwell (Northumberland and Durham), Mr. E. E. Scholefield and Mr. R. W. Furse (Devon), Mr. H. Collins and Mr. R. Hefford (Northants), Rev. G. H. Pratt and Mr. T. Cooper (Shropshire), Mr. J. Vicars and Mr. J. Lumin (Cumberland and Westmorland), Mr. W. W. Falkner (Leicester), Mr. A. Willmott and Mr. Guy (Hertford Ware and District).

The report of the Finance Committee was presented by Mr. C. L. M. Eales, and it was resolved that payments be made amounting to £51 8s. 6d. The receipts for the month of February were £31 7s. 6d., and for March £56 0s. 2d. The balance in hand at the end of March was £159 6s. 11d. It was resolved that "a form for the submitting of names of delegates by Association Secretaries be drawn up," and this was left to Mr. A. Richards to draw up and submit to the next meeting of Council.

The First Class Examination was fixed for May 19th and 20th. Col. H. J. O. Walker was appointed examiner.

The Second Class Examination was fixed for November 24th and 25th.

It was resolved that "Mr. T. W. Cowan, Col. H. J. O. Walker, Mr. W. F. Reid, and Rev. A. D. Downes Shaw, be the examining board for First and Second Class Examinations."

The examiners' report on third class examinations held at Pretoria, South Africa, was presented, and certificates were awarded to Mr. J. L. Taylor, Wonderboom Apiary, Boom Street, Gezina, Pretoria, S.A., and Mr. D. Cairncross, Church Street, Pretoria, S.A.

An application for medals and certificates for the Grocers' Exhibition was received, and these were granted, Mr. T. W. Cowan and Mr. E. Walker being appointed judges at same.

The Staffordshire Association applied for the appointment of Mr. A. G. Pugh as judge and examiner at their show on July 19th and 20th; this was granted.

The amended leaflets of the Association were presented and accepted. A hearty vote of thanks was accorded to Mr. Gareke and Mr. Lamb for their labour in revising same.

The Pretoria Association applied for the appointment of permanent examiners and it was resolved "to appoint Mrs. Stewart Russell and Mr. H. L. Attridge for twelve months only, to date from this meeting."

A letter was read from the British Dairy Farmers' Association asking for a grant towards the prizes for honey at their show in 1911; it was decided that the state of the finances would not permit of this being done this year.

#### MIDLOTHIAN BEE-KEEPERS' ASSOCIATION.

At a recent meeting of this Association, Mr. J. W. Moir in the chair, it was unanimously agreed to support legislation against bee diseases.

A more active propaganda was decided on, and now the Edinburgh and East of Scotland College of Apiculture has arranged that the well-known Scottish expert, Mr. R. Steele, shall give four lectures on bee-keeping in the Scientific Hall, Dalkeith, on Friday, 21st April, and the following Fridays, at 7.30 p.m. Admission is free and discussion is invited.—  
JOHN W. MOIR.

#### HELPFUL HINTS FOR NOVICES.

By W. Herrod.

*First Examinations.*—These should be carried out only in suitable weather; do not be too anxious to manipulate so long as it is seen that the food supply is adequate, and that it will be sufficient until a nice, still, warm day comes along, enabling a proper examination to be carried out. Though the sun may be shining, oftentimes there is a keen wind blowing, and exposure to this, be it ever so short, will chill the brood and so do an immense amount of harm. Also watch very closely for the bees balling the queen, and above all, do not attempt to handle the queen during the first two or three examinations or it may quickly cause this to happen.

*Water and Pollen.*—Attention to the supply of these two necessary articles will save the bees a tremendous amount of labour. Artificial pollen can be supplied by placing a box of shavings, cut straw or hay, in a sunny position well-sheltered in case of rain, with Symington's pea-flour dusted upon it. I say Symington's, not because I hold a brief for this firm, but because it is a fine powder, instead of being granular, which is the case with some kinds of pea-flour. Water can be given in a shallow vessel, filled with stones

to prevent the bees being drowned; corks move too much, and very often precipitate the bees into the water. If the bee-keeper is at all handy with tools, it is an easy matter to make a grooved board upon which a bottle, full of water, can be inverted. A little salt should be added to the water, so preventing the bees from going to objectionable places for saline matter. Drinking-vessels and pollen-box should be placed where it is impossible for animals or poultry to get to them, or a good many bees will be sacrificed.

*Spring Cleaning.*—This operation should be carried out as soon as possible and should be done in a methodical manner and not haphazard, which is so often the case. Examine one comb first to see that the bees are healthy, then scrape off from the top bars all brace combs and propolis. Examine each frame carefully when separated for this purpose; all bits of dirt which have lodged between the combs from the first operation will fall on to the floor-board, and this is the reason that the top bars should be cleaned first. Close the bees on to the number of frames they cover; to conserve the heat put back the quilt. Place the lifts and outer-case, one on the top of the other, corner-ways for stability, and then lift the brood chamber and stand it corner-ways on the top of these; by so doing, no bees are crushed, and dirt and stones do not cling to the bottom bars or edge of the brood chamber, which is the case if it is placed right on to the ground. Have a box handy, and scrape all the refuse into this so that it can be burnt when the work is over, and the ground round the hives kept neat and tidy. The scraper should be held tight down on to the floor-board, so as to avoid maiming bees. Put the brood chamber back carefully with a gentle screwing motion, so that any bees on the under edge will run away upon the slight pressure being put upon them. Renew the supply of naphthaline: see that all is covered down snug and warm. Colonies that are weak should be united at once, also those which have useless queens. One strong colony will give surplus, but weak ones will only be able to build up strong enough for wintering. The bee-keeper, as a rule, does not like to reduce the number of his colonies in this way, but it is the only profitable method. Where uniting is necessary, flour the bees well, interspace the frames, and be sure to cage the queen for at least twelve hours.

*Touring Experts.*—The experts have now started on their spring tours, so have everything in readiness for them, so that their work may be expedited.

*Insurance.*—Don't neglect this; it is a foolish policy "to lock the stable door when the horse is stolen." *Do it Now.*

NECTAR-PRODUCING PLANTS AND THEIR POLLEN.

By Geo. Hayes, Beeston, Notts.

(Continued from page 104)

No. 6. THE SYCAMORE.

(*Acer pseudo-platanus*).

NAT. ORD., *Aceraceae*.

The sycamore tree next claims our attention. There are many species, six of which are indigenous to Europe, but this one only deserves our notice as a source of nectar. One well-known species is *Acer saccharinum*, the American sugar-maple which supplies the maple sugar of commerce. The great maple, or mock-plane, is the one under consideration, and it is generally known best in this country by the name of sycamore.

Sycamores grow rapidly and attain a great height. The timber is close and compact, easily cut, and not liable either to splinter or warp, and on this account is useful for a variety of purposes, such as carvings, mouldings, &c., and in earlier times was used extensively for making platters and bowls.

As the juice of the maple, both in the leaves and in the tree, is sweet, it attracts numbers of insects. At certain seasons wild bees and wasps may be seen about the tree in crowds.

The flowers are loose, oblong, hanging racemes, and are conspicuous by retaining their green colour similar to the surrounding leaves, but are well worthy of a closer examination. They yield nectar abundantly, which, although suitable for the bees' requirements, does not produce a very desirable honey. I am inclined to think that in certain seasons our bees will avail themselves of the saccharine matter exuded from punctures by other insects

of the leaves. &c., which further deteriorates the honey. Apart from this, the sycamore is looked upon as one of those sources very helpful in bringing our bees up to full strength ready for the later and better flow of nectar of clover and limes.

It yields pollen in fairly large quantity, and this, when taken fresh, is of a greenish yellow colour, measuring, dry,  $\frac{2\frac{1}{2}}{1000}$  in. by  $\frac{1}{1000}$  in. and from honey  $\frac{2}{1000}$  in. by  $\frac{1\frac{1}{2}}{1000}$  in. This is a fairly large grain, especially when compared with the chestnut; it is oval in form, with

three long indentions reaching nearly from end to end, and distributed at equal distances around it. The surface is slightly striated when it is dry, but more pronounced in oil or honey. Its general form may be seen at 1, c and e, and other variations at 1, A, B, and D. In water it assumes a spherical appearance, with three slight processes. The extine expands and the fovilla concentrates, appearing as at 2, the inner part being of deep yellow colour, and the outer ring almost colourless. From honey the three indentions have become three long protrusions, and in the centre of each is seen a small process, as shown at 4, A and B, and enlargements. A

1. Dry.



2. In Water.



3. In Formalin.



4. From Honey.

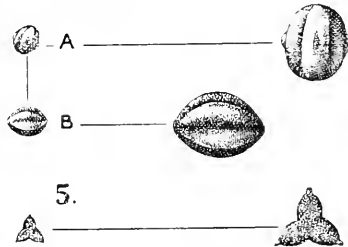

POLLEN OF SYCAMORE.

section through the middle is shown at 5, to make this more clear.

**Correspondence.**

The Editors do not hold themselves responsible for the opinions expressed by correspondents. No notice will be taken of anonymous communications, and correspondents are requested to write on one side of the paper only and give their real names and addresses, not necessarily for publication, but as a guarantee of good faith. Illustrations should be drawn on separate pieces of paper. We do not undertake to return rejected communications.

GLASS SIDES FOR OBSERVATORY HIVES.

[8137] In 1907 I began experiments with

observatory hives by buying a 2-frame, second-hand one, advertised in the "B.B.J." I improved it in various ways, stocked it, and exhibited it at a show in Edinburgh, taking first prize. It could be gently warmed by an electric heater.

In 1908, I had a 6-frame hive made. Each standard frame was contained in a separate box. These can be placed alongside of each other, with or without glass, making, in the latter case, an ordinary 6-frame hive. At the top and bottom of each frame-case are communicating doorways, and each of these has a long sliding door in four parts, viz., open, shut, ventilating and queen-excluding.

It can be erected to show each side of each frame, being mounted on brass discs, and an entrance of Messrs. Jas. Lee & Sons' make.

I had the greatest difficulty in getting it finished for the Royal Agricultural Show at Newcastle, for which I had entered it. I suppose that the cabinet-makers found it more troublesome to make from my drawings than they expected. Anyway their promises remained unfulfilled. On the 29th of June, I went down to the workshop myself and found my hive well begun: no more. I had sent down all the metal work and glass. I got several men on the job and we worked and planed and sawed and screwed till after midnight, when it was completed. I got home with it about 3 a.m. of the show day, put in the frames of comb and the bees.

How these little ladies resented this very untimely manipulation in the dark! I never knew them so wicked, and would not have succeeded, but for my wife's help, and the use of thin syrup, plentifully sprayed over them. I caught the morning train to Newcastle, and on arriving in the showyard, was delighted to find that my little demons had become little angels. Unfortunately, in erecting the frames, the last fell over on the bench as I mounted it to set it in place. The glass broke, some bees escaped, and the judges came round and disqualified my exhibit. I slipped down to the town, had two or three sheets of glass cut, and with much difficulty got permission to erect my hive. Willing helpers were at hand, and I soon had my bees enjoying the open air.

Some of the twelve glass sides of this hive were double. But moisture was apt to condense between the sheets of glass, and in warm weather single sheets, covered at night, are protection enough.

But I lost two small stocks in the dreadfully cold April of 1908, before I got my small 2-frame observatory hive stocked for the Scottish National Exhibition at Edinburgh, where I had volunteered an exhibit in the Nature Study Section.

So I determined to try experiments this year with double glass sides.

Consulting Dr. Macgregor, Professor of Natural Philosophy in the Edinburgh University, as to the best distance between the glass plates, he informed me that little was known about the convection currents in layers of air contained by sides at different temperatures, and urged me to experiment. As far as conduction is concerned air conducts about 50 times as badly as glass. I am therefore beginning with about 1-64 in. air space, and this will equal nearly an inch of solid wax. Then 1-32 in., 1-16 in. and 1-8 in. equal respectively to about 2, 4 and 8 inches of glass. I am trying these smaller air spaces first, as the professor evidently thinks the convection currents are far more serious than one would think. The larger the air space the less loss by conduction; the thicker the layer of air, the more loss by convection.

He has kindly compared some fine thermometers in his laboratory for me, and I mean to take careful, simultaneous observations. But I pointed out that my bees would do much to vitiate my experiments, by seeking to maintain the best temperature for their own work. And he has nominated a very clever student for a Carnegie Scholarship for the purpose of studying the transmission of heat in such cases.

Meantime if any bee-keeper can tell me where to find records of any experiments already made, or if any scientist can inform me of such published records, I would be exceedingly obliged if they would inform me, and I hope to be able to give, before many months, some definite results of my experiments.—JOHN W. MONK, Edinburgh.

[We do not know of any experiments that have been made with a view to ascertaining the best distance between the double glass. It would be useful to know more about how the heat from the bees is communicated by radiation, conduction, and convection. We know that the glass in an observatory hive is constantly cooling by radiation, and thus convective movements are established, but to what extent has not yet been determined. When we worked our observatory hive, there was a quarter-inch space between the two sheets of plate glass, and the doors were lined with green-baize and wool, which proved sufficiently satisfactory. We shall be pleased to record the results of any experiments our correspondent will supply us with.—Ed.]

#### "ISLE OF WIGHT" DISEASE.

[8138] A good deal of space in the "B.B.J." has lately been devoted to the subject of "Isle of Wight" disease and its probable cause, but up till now no one has suggested what appeared to me may possibly account for it, and I should like

Dr. Malden and some of our prominent bee-keepers to give it their consideration in carrying out future experiments. Naphthol Beta solution is prepared with alcohol, and I believe a great number of bee-keepers are in the habit of giving this to their bees in their spring and autumn food. It has been proved beyond doubt that alcohol has a most disastrous effect on the human body, and if so bad for the human body, why not even worse for the bees with their delicate little stomachs and nervous systems? I believe bees have a great aversion to being manipulated by persons who habitually use alcohol, and I think it a pity for them to be forced to take it in their food after being robbed of their pure honey at the close of the season, or in their stimulative food in the spring. I should like you to publish this letter, as it may help to solve the problem and save us from the loss of the whole of the bees in Great Britain.—T. H. WITNEY, Walthamstow.

[Our correspondent's apprehension of the harm done by alcohol is groundless in this case, for in the first place half an ounce in seven pints of water would be such a dilution as to be imperceptible, and in the second place, the solution is added to the syrup while the latter is still hot, and is evaporated before it gets cold. The alcohol is used as a vehicle for dissolving the naphthol beta, which becomes sublimed and diffused in the syrup as the alcohol evaporates. For twenty-five years we have used this dilution in all food given to our bees without any ill-effects.—Ed.]

## BEE DISEASES.

### NEED OF LEGISLATION.

[8139] It is no doubt news to most people who live outside the little world of bee-keepers that Dr. Malden, of Cambridge, has been engaged for some two years, at the instance of the Board of Agriculture, in investigating the nature and possible cause of "Isle of Wight" disease. In the most able and exhaustive paper which he read at the Annual Meeting of the B.B.K.A. on March 16th, he states that "if we examine the facts so far as they are known as to the origin and spread of this disease, we shall have no difficulty in coming to the conclusion that it is of an infectious nature, communicated in some way from bee to bee, and that it is introduced into a healthy stock by the adult bees (who are the first and generally the only ones, to suffer) robbing from an infected hive."

The special correspondent of the *Daily Mail*, writing under the date of April 10th, mentions "the derelict hives which one sees in all parts of the island." If this be the case it is not surprising that bee-keeping is hopeless there, for these

derelict hives, left probably just as they were when the bees died out, are a constant and continuing source of infection. Alas! derelict hives are not peculiar to the Isle of Wight. Go where you will in almost any county of England, you see the same sad sight, not perhaps brought about by the same cause, but by the ravages of foul brood. And there they stand, a source of infection to all the bees of the neighbourhood. Surely it is time that an Act of Parliament was passed which would put an end to this state of things, and compel ignorant and careless keepers of bees—you cannot call them bee-keepers—to cure the disease, which is easily done by proper treatment, and to burn or disinfect and store away all contaminated hives, and thus prevent them injuring their neighbours.

Until a Bee Diseases Bill is passed which will bring bees within the scope of the Contagious Diseases (Animals) Act, and put the diseases to which they are liable in the same category as pleuropneumonia, anthrax, swine-fever, rabies, &c., and confer upon the various County Councils the power, and impose upon them the duty, of appointing properly qualified Inspectors with power to inspect any hive of bees and to order destruction by fire if found to be diseased, we shall never be able to stamp out infectious diseases or to make bee-keeping a paying industry in England. In this matter of legislation England lags behind other countries. In South Africa there are stringent rules against importing bees or bee appliances except under certain conditions. In New Zealand the Apiaries Act, amongst other wholesome regulations, makes it an illegal and highly penalized act to keep bees in anything but movable comb hives. The present mysterious epidemic may prove a blessing in disguise if it will lead to drastic legislation which will weed out of the ranks of bee-keepers those who are unfit to keep bees, and allow those who make a study and business of it to carry it on comfortably and profitably.—PHEG.

### DEALING WITH "ISLE OF WIGHT" DISEASE.

[8140] It appears from the correspondence in the "B.B.J." that the so-called "Isle of Wight" disease is making havoc among our brethren in Hampshire, and Mr. Woodley has reported in the "B.B.J." of March 16, serious losses in his county where some bee-keepers there have lost 30 and even more stocks, one having only a single stock left out of 80. I should like to know the name and address of this unfortunate bee-keeper, and should he still have in his possession some of the combs on which the bees have died, I shall be

glad if he will kindly forward to me a set of the frames in a ventilated travelling box, first extracting the honey, if any. The top bar should be cleaned and the name of the owner written on it so that he may identify his own frame again. I will place these frames in my hives, get them filled with brood and return them free of charge. I should like them to remain with me for thirty days, so that I may see the first hatched bees ready to fly. Combs must be guaranteed free from foul-brood, and should reach me in early May. I will undertake to prove that the disease is not always in the combs. The first symptoms of "Isle of Wight" disease were seen in this part in 1904, and for two or three years the malady was so deadly that it reduced my apiary of about sixty stocks to fourteen, ten of which were very weak and four in medium condition. I began experimenting with these, and discovered that it was safe to use the best combs again. I next took a set of the very worst soiled combs, and made an artificial swarm, giving these combs to the swarm. They are on them to-day, in a perfectly healthy condition. When I found the worst-soiled combs could be used again I made rapid increase and saved all my combs and increased the fourteen stocks mentioned to fifty, and sold over half a ton of honey. I have still continued to increase, the number of my colonies being now ninety-five, and I have all the combs in use on which the bees died when the disease was devastating my apiary. There is not the slightest trace of disease in any of the hives, and all have wintered so far well. Some are covering two sets of frames, while many two-frame nuclei made in July last are breeding well also. If the weather is favourable enough to ensure a plentiful food supply, little need be feared of any loss. My apiary is open for inspection, and lessons given free of how the so-called disease may be, and is, bred out.—T. STAPLETON, Gwinear, Hayes, Cornwall.

#### PAINTING HIVES.

[8141] I should like to endorse what W. A. C., Castle Cary (page 155), says regarding painting hives, and to add that it is necessary to have the proper quantity of turpentine and driers, with the boiled linseed oil and good white lead.

In my early bee-keeping days I used unadulterated white lead, which was very satisfactory and durable; but after a time I bought some paint ready mixed in tins, which easily rubbed off a few months after use; and, more unfortunately still, I gave a coat of this mixture over the genuine white lead paint, and one soon destroyed the other. In fact, the hive

was no better than if it had been only covered with oil and a little whiting.

I don't use paint for any of my new hives now, but give them two coats of "Solignum" or Pitcher's "Stop-rot," which in my opinion is much cheaper, more quickly applied, more lasting and far superior as a preservative for the wood.—D. HANCOX, Oxon.

#### EARLY HONEY-GATHERING.

[8142] To-day (the 24th April), on opening my hives for the first time this season, I was astonished to find a box which had contained candy filled with new honey, two of the brood frames also being in like condition. The stock of bees, which are strong and healthy, wintered on nine frames and were a late swarm (which issued from the parent hive on July 21st last year). In another hive (a stock which also swarmed last year) the bees had built drone-comb in the candy-box and the queen had filled every cell with eggs. There were two frames with plenty of room for the queen to lay, but there was not an egg in either of them. A bee-keeper of wide experience, who was present at the time, tells me he has never seen such a thing so early in the season.—D. ERNEST, Essex.

#### AMERICAN AND COLONIAL PAPERS.

##### EXTRACTS AND COMMENTS.

By D. M. Macdonald, Banff.

*Queen Excluder.*—My dislike of this appliance has been recorded in the past. Here are two short quotations, one from Texas, and one from Australia, condemning its use. Mr. Chambers writes as follows: "Certainly I do not believe in excluders. I cannot comprehend how anyone should wish to use an excluder that enforces such discomfort on the bees. I agree with Mr. Scholl, when he says that it is a honey excluder, as well as a queen and drone excluder, and I regard excluders as a handicap of the most unpleasant kind." This sentiment in *Gleanings* is supported by the testimony of the Editor of "*The Australian B.K.*" who says: "I do not use a honey-board on any honey gathering colony, nor can I see any advantage to be gained therefrom."

*Honey Cooking Recipes.*—Much good would be derived from a collection of these, if published in a handy form, and Mr. Root is preparing such a compilation. He has a new list of over 100 recipes after throwing out duplicates and doubtful cases. The list includes cakes, cookies, bread, biscuits, gems, dough-nuts, jelly and preserves, candy, popcorn balls, &c., &c. It is certain that a booklet giving a large number of practical ways of using honey in cooking will help considerably in



educating the public as to the value of honey as a food, and I should think extend its use.

*Reciprocity.*—It appears that Canadian beekeepers are not deeply in love with the proposed tariff arrangements between their Dominion and the United States. Mr. Byer says: "Many Ontario beekeepers feel that the markets they have been building up for years will now, by reason of geographical conditions, be snatched away from them. Whether it will work out as bad as it looks is for the future to decide, but I believe nine-tenths of the bee-keepers of Canada would prefer matters as they are." The "*Canadian B.J.*" takes even a gloomier view. "Now a new danger threatens us. Bee-keepers with honey to sell will soon have the privilege of selling it freely where they wish, and the honey business is likely to be ruined as a consequence." And yet before the paragraph ends one concludes the wail is not to be taken seriously. Perhaps the extended market may only work towards good and not evil. I hope so.

*A Woman's Column.*—The "*Canadian*," imitating the "*American B.J.*" and "*Gleanings*," is providing readers with a Lady's Department, conducted by Miss Robson, the resourceful young lady beekeeper I mentioned in January Extracts. This is a healthy feature in apiculture. I know none of the small cultures which can hold a candle to our craft, when viewed as an occupation suited to the gentler sex, and I see no reason why many of them should not take a place in the front rank of apiculture.

*The Ideal Colony.*—It goes without saying that strong and powerful colonies are of primary importance in working towards success. Still, mere numbers will not alone avail. Something in the inner polity and government of the hive, something in the character of the strain of bees, and something yet further depending on the condition of the brood nest are determining factors. Dealing with the first and last of these factors, I quote from "*Review*:" "The ideal colony must not be over-populous. A hive is so when the working force is too great in comparison with the dimensions of the hive, and with the number of wax-building bees. The bees seem to see the combs all but filled and capped, and anticipate that they will soon be crowded. Such a condition is intolerable, and their instinct teaches them to begin loafing even before the hive is over-populous." Mr. Bentine, in "*Australian B.K.*" deals with the second point, the question of strain: "My queens of the golden variety would at first out-strip all others in the number of combs of brood and the number of bees in the hive, but a record of yields of honey kept accurately for a number of seasons showed that they

were considerably behind other hives less populous, but evidently with longer lived bees. The average bee-keeper breeds from these most prolific queens, but sooner or later everything goes wrong with the progeny of such mothers." I endorse this statement regarding this strain.

*Bees Under Snow.*—Doolittle considers that hives snowed over are not favourable to safe wintering, as he holds that the pure air is cut off to a certain extent, and this, combined with the generated warmth, brings about conditions so unnatural that loss follows. "Most of the colonies were dead, and the few left were very weak in bees, while the combs were foul with excrement." In Canada, where the test should be more severe, a beekeeper reports that after three months had passed with the hives drifted over, he found the bees in *perfect condition*. That would be somewhat like our experience in these cold northern climes. The drifted snow acts like a warm blanket, preserving the internal heat, keeping the bees quietly clustered all winter, and greatly conserving stores.

*"Topsy Turvy Land."*—Just at present our kith and kin over in New Zealand and Australia have completed the "reaping" of their honey harvest. In many parts the best flow began about the New Year. There at present the bee-man's thoughts are on checking robbing, supplying artificial stores for winter food, uniting weak colonies, small nuclei, or any queenless lots, and in general doing such necessary work as we feel is incumbent on us to perform in October, when preparing our bees for winter quarters. In most parts the honey harvest has been a bountiful one. One says "too much" honey; and that introduces the question of too low a price!

---

## Echoes from the Hives.

---

The effects of last year's bad season are manifesting themselves this spring in South Oxfordshire. I have examined the hives of several people and find many colonies short of food. The other day I was asked to examine a hive in which the bees had died, the owner thought from disease. The moment the quilts were removed the cause of death was evident. A closer inspection disclosed the fact that there was not a drop of honey in the combs. About a quart of bees lay dead on the floor-board, while others had remained in a cluster after death. The combs were quite clean and healthy. To me the sight of a heap of dead bees is always a pitiful one, and, thinking that the living colony hard by might be in straits, I undertook an examination. These were not quite so strong as the others had been: but they were rapidly running short of food, and in a day or two the colony would have been extinct.

I advised putting on the feeder that evening, using for just one feed any sugar available. A week earlier I accepted the invitation of a friend to look over seven colonies he had bought. Three had fifteen frames in the brood nest, and all but one colony had supers left over from last season. I took these off, and we estimated that they contained 90lb. of honey. This had for the most part granulated. Only one of the seven colonies was a little weak, and as for three, they were in grand condition, and, should good weather prevail, there will be early swarms. The ways of some beekeepers are mysterious. The man from whom these bees were bought had boasted, on hearing others talk of putting supers on, that he had already taken sections off. I hope beginners in the craft will not regard this method as a wrinkle for getting early sections for the show bench. By the way, my friend who now owns these fine colonies lost four or five about February. He told me that he fed his stocks very late in the autumn, but that when the bees died he discovered that though there was an abundance of food in the hive granulation had set in so that the bees starved in the midst of plenty. I did not see any of the combs with these granulated sweets and can only give hearsay evidence. On Easter Monday I went to see some bees which were for sale at a remarkably low price. I found that two stocks in skeps had been "transferred." In one case "transformed" would be a better word, for the gentleman who owns the bees had transformed what to all accounts was a prosperous colony into half a tea-cupful of bees which he had got on ten frames of combs and comb foundation. The queen had spent forty-eight hours in the open air and, as I was told, "could scarcely crawl when put back into the hive." The next stock to this was fast becoming strong, but I had the unpleasant duty of informing the owner that he had foul-brood in his apiary. I was shown the combs in the skep and found them badly infected with foul-brood. This hive had been placed in front of the others in order that the bees might lick up the honey. Who can wonder that foul-brood spreads?—C. H., Reading, April 18.

---

## Queries and Replies.

---

[4120] *Scaled Stores*.—I have a hive which contains about three frames of bees, including a queen, which I have kept through the winter. Upon examining the stock I find it has three frames full of winter syrup all sealed up.

Will you kindly inform me, through the

"B.B.J.," whether I should uncap the frames in question, and if so, if it will be necessary to supply the bees with syrup during the spring? I am thinking of building this small lot up by taking frames containing brood from my other colony.

Kindly say if I shall be doing right, also what would be the right date to remove the brood frames.—W. ELRIDGE.

REPLY.—If you uncap the food round the brood nest it will stimulate the bees. Until the warm weather comes it would be unwise to give frames of brood, as the small lot of bees would not be able to maintain sufficient heat to keep them alive and the brood would be chilled.

[4121] *Making Stocks Strong*.—Many thanks for the information you gave me last autumn regarding moving my bees. I carried out the operation successfully.

I shall now be glad if you will kindly answer the following queries:—

I have three stocks of bees. No. 1 is very strong, and of good working qualities. No. 2 is of medium strength; this lot is only now working down into a frame from a box in which they were placed last summer as a swarm. No. 3 is decidedly weak; I am afraid the queen is old and useless. I want to get three good average stocks if possible, and should be glad if you would inform me the best way of doing this. (1) Would it be possible to work as described (at foot of p. 126 and top of p. 127), in Guide Book, dequeening No. 3 after having strengthened it a week or two previously by a frame or two of sealed brood from No. 1, also taking the frame of eggs from No. 1?

(2) Or would it be better to work as described on page 130, fig. 93, using No. 1 hive for this purpose? My difficulty in using this method is that I have never yet been able to "spot" the queen in No. 1 hive on account of the quantity of bees.

If you recommend No. 2 plan (a) Would the frame of eggs serve the same purpose as the special queen-cell carrier advised? and (b) Would this frame have to be put into hive No. 3 as soon as the queen cells were sealed over, having made the stock queenless three days beforehand? (c) Could the young queen remain in the special compartment until she was fertilised? The objection to this course seems to me to be that the young queen returning from her nuptial flight might enter the wrong side of the compartment and be killed. Or can you suggest any other simple method of giving No. 3 a good young queen from No. 1?

(3) When is it necessary to remove frames of sealed and unsealed honey when packing up for the winter and there are no other stocks requiring food, and one does not possess an extractor, can they be kept till spring, and in what manner?

(4) In my opinion it would greatly add to the value of your useful little journal if

you gave, week by week, a few seasonable hints, having due regard of course to the weather, locality, etc.—F. S.E., Ipswich.

REPLY.—(1) Yes. The plan you suggest would work all right. (2) Under the circumstances it would be best to adopt plan No. 1. (3) Keep the combs of honey in a warm, dark, dry cupboard. (4) You will see your suggestion is carried out this week, and will be continued fortnightly.

[422] *Working for Honey and Increase.*—I shall be much obliged for a reply to the following in the "B.B.J." I have at present three hives, one containing nine frames of bees to which I added a frame of foundation, as the hive is rather strong and contains large quantities of brood. The other two hives are empty. I should like to get some honey and also to increase my stocks. The average yield of honey per hive in the district is 30lbs. How many lots of bees (nuclei) could I get strong before winter from a 10-frame hive of bees? I should be glad if you can tell me (1) Can I get both honey and a swarm from one stock? (2) Can I obtain a nucleus from two hives, and also get surplus honey? (3) How strong will the nucleus be when the time for wintering arrives?—H. S., Cheshire.

REPLY.—It will need very careful management and a good season to do as you desire. (1) When the hive is brimful of bees make an artificial swarm, letting it remain on the old stand, and super the swarm, but not the stock. (2) Yes. (3) All depends upon the care expended and the season. If conditions are favourable you can work up the nuclei into a stock covering ten frames.

## Bee Shows to Come.

**June 26 to 30, at Norwich** (Royal Agricultural Society's Show).—Bee and Honey Section under the management of the B.B.K.A. Prizes arranged in groups of counties for Associations affiliated to the B.B.K.A. Schedules from W. Herrod, Secretary, B.B.K.A., 23, Bedford Street, Strand, London, W.C. **Entries close May 31.**

**August 23, at Radstock, Somerset.**—Honey Show in connection with the Radstock Horticultural and Farmers' Association. Open and gift classes. Write for Honey Schedule. B. M. Clark, Foxhills, Radstock.

### BEE CONTROL CLOTH.

The Irekling Corporation write with reference to our notice of the Gillies transparent bee control cloth which we published under the heading of "Novelties" that the cloth in question has been used throughout Ireland and in many parts of England and Scotland for over seven years, and that its use is continually extending. They also ask us to state that it is not exclusively a fine weather cloth. In a gale, however, the operator must face

the wind working forward, and *vice versa*. Then the wind helps.

## Notices to Correspondents

*Letters or queries asking for addresses of manufacturers or correspondents, or where appliances can be purchased, or replies giving such information, can only be inserted as advertisements. The space devoted to letters, queries, and replies is meant for the general good of bee-keepers, and not for advertisements. We wish our correspondents to bear in mind that, as it is necessary for us to go to press in advance of the date of issue, queries cannot always be replied to in the issue immediately following the receipt of their communications.*

W. B. (Torpius).—*Working for Extracted Honey.*—Buy the "British Beekeepers' Guide Book," which will give you all particulars with regard to supering. An ordinary queen excluder is better than a Raynor Honey Board. These can be had from all appliance dealers.

W. E. B. (Dudley).—*Suspected Virgin Queen.*—The queen is an unfertile one, and would have been useless if you had kept her.

Y. R. (Bath).—*Stock Dwindling Away.*—The queen is evidently old and worn out, and in consequence the stock has become very weak.

### *Suspected Disease.*

X. Y. Z. (Lewis).—Bees are affected with "Isle of Wight" disease.

R. E. J. (Ware).—There is no trace of disease, bees dying head downwards in the cells betray a condition of starvation. In all probability the feeder had become blocked.

R. E. (Edenbridge); J. McH. (York); E. P. H. (Southampton); **Anxious** (Eastleigh).—Bees have died from "Isle of Wight" disease. Burn all internal fittings of the hive, dead bees, &c., and scorch the inside of the hive with a painter's spirit lamp.

E. D. (Sleights).—Your parcel was badly packed and became so crushed in the post that it was impossible to examine it.

G. R. (Carrington).—The bees were too dry for us to say if disease was the cause of death, but we think not. Yes, try again.

H. W. (Smethwick).—There are symptoms of "Isle of Wight" disease. The stagnant water would not cause death.

R. S. (Cambridge).—Starvation only has caused the death of your bees.

W. A. T. (Herts).—Nos. 1, 2, and 4 show distinct traces of "Isle of Wight" disease. No. 3 is too dry to diagnose cause of death.

W. J. B. (Wylde Green).—The stock has dwindled through being queenless. There are one or two cells containing chilled brood which has been dead for a very long time.

W. H. H. (Methwold).—We cannot find disease in either sample of comb.

**Special Prepaid Advertisements****Two Words One Penny, minimum Sixpence.***Orders for three or more consecutive insertions entitle advertisers to one insertion in "The Beekeepers' Record" free of charge.**Trade advertisements of Bees, Honey, Queens, and Bee goods are not admissible at above rate, but will be inserted at 1d. per word as "Business" Announcements, immediately under the Private Advertisements. Advertisements of Hive-manufacturers can only be inserted at a minimum charge of 3s. per  $\frac{1}{2}$  in., or 5s. per inch.***PRIVATE ADVERTISEMENTS.****S**WARMS, guaranteed healthy, May 3s., June 2s. 6d. lb., boxes returnable, cash with order.—**ANDREWS**, Longthorpe, Peterboro'. h 66**C**LEAN STANDARD COMBS, 6s. doz.; shallows, 5s.; appliances cheap.—**MULBERT**, Astwood-road, Worcester. h 62**B**EES.—Good healthy lots in Skeps, 15s.; good Stocks on standard bars, 30s.—**PHILLIPS**, 25, Albert-street, Stevenage, Herts. h 74**B**EES.—Healthy Stock and Hive for sale, 25s.—59 Auckland-road, Ilford. h 73**Q**UEENS.—Few surplus, healthy, 3s. 6d. each.—**ARNOLD KING**, Alma-terrace, Silverhill, St. Leonards-on-Sea. h 72**S**EVERAL Stocks and few empty telescope Hives, Crates, complete; owner going abroad. What offers? — **VARLEY**, Cowick, Snaith, Yorks. (h 69)**T**HREE HEALTHY STOCKS in Standard Hives, 4 section racks, 2 excluders, feeders, smoker, pair Birkett gloves, the lot £5.15.—**NELMES**, Cathcart. h 67**F**OR SALE, 3 choice 1910 English Queens, 5s. each.—**CROWE**, Central Avenue, Wigston, Leicester. h 65**R**EMOVAL SALE.—13 Burt's W.B.C. Hives, new, 3 coats white lead paint, calico covered roofs, 23s. each (includes legs, &c., 10 brood frames and ends, 2 shallow boxes, 8 frames each, wide ends, all full sheets, weed foundation wired); 12 Nucleus Hives, with 8 frames and euds, used one season, 3s. 6d. each. Following 2-year-old hives repainted: 6 Garner's Sleaford, 11 frames and ends, 2 lifts with 9 shallow frames, wide ends, all full sheets, wired foundation, 13s. 6d. each; 3 Garner's Cottage, 11 frames and ends, 5s. 3d. each; 4 Lee's Alliance, 10 frames and ends, 6s. 3d. each; all on rail; 9lbs. weed foundation, thin brood, 18s., post free;  $\frac{1}{2}$  ditto, 9s. 3d.—**REV. W. E. MATTINSON**, Happsburgh, Norwich. h 76**F**OR SALE, Shallow Frame Racks with 8 clean, healthy drawn out Combs, wide ends, complete, 4s. 6d. each, or £1 for 5.—**A. GREEN**, Tangley, Andover. h 63**B**EES FOR SALE, on frames, 17 Stocks.—**GARWOOD**, Ptr. Heigham, Gl. Yarmouth. h 58**W**ANTED, **SIMMINS' CONQUEROR HIVES**, warranted free from disease.—**GILLMAN**, Stapleford, Notts. h 44**W**ANTED, good Brindle bull-terrier dog pup.—**W.**, "B.B.J." Office, 23, Bedford-street, Strand.**BUSINESS ADVERTISEMENTS.****J**UST THE THING FOR BEES.—Michaelmas Daisies, large clumps, fine mixed varieties, 1s. 6d. doz.; 50, 3s. 6d.; also Hardy Perennials, various, mixed, large clumps, 20 for 2s. 6d.—**A. JENSEN**, Kingston, Hornchurch. h 78**Special Prepaid Advertisements.—Continue****S**WARMS.—Guaranteed healthy, May 15s., June 13s.; boxes returnable.—**ADAMS**, Farnham, Blandford. h 68**35**TH YEAR.—Three framed Nuclei, healthy queen, bees, brood, 12s. 6d.; empties returned, paid.—**ALSFORD**, expert, Haydon, Sherborne. h 61**H**ONEY WANTED.—Price and sample to **S. W. CATTON**, Rose Cottage, Old Lenton, Nottingham. h 75**1911** VIRGINS, Blacks, Carniolans, Italians, 1s. 6d.; Americans (Golden), Cyprians, 2s.; Swiss, 2s. 3d. Send for price list. Cash with order.—**FREDERICK VOGT**, 38 Clementina-road, Leyton. h 70**Q**UEENS, fertile, in introducing cage; delivery guaranteed, 5s. 6d.—**BRICE'S APIARIES**, Otford, Kent.**G**OLDEN PURE CYPRIAN fertile Queens, gentle strain, five yellow banded, 6s. each, post free.—Write to **DERVISHIAN BROS.**, Nicosia, Cyprus. h 71**S**TRONG STOCKS in Skeps, 18s. 6d. Swarms, May 15s. 6d., June 12s. 6d.; boxes 6d.; guaranteed healthy.—**HIGGINSON**, Egerton, Kent. h 64**N**OTICE.—The tone blocks used for printing the pictures of "Homes of the Honey Bee" in "B.B. Journal" may be obtained from this office, post free, 2s. 6d. each. They are useful for advertising purposes, or for picture post-cards. Room wanted, and those now in stock will be kept for a short time only.**F**OR SALE, 2 gross  $\frac{1}{2}$ lb. Best White Granulated Honey, screw top, 5s. doz.—**FRUSHER**, Crowland, Peterborough. h 60**A**LNWICK BEE FEEDER, price 6d. each; postage of one costs 3d.; two, 4d.; six, 6d.; dozen, 10d.—**J. BALMBA**, East Parade, Alnwick. h 56**1910** QUEENS.—Natives, 5s.; goldens, 7s. each, healthy.—**O. KNIGHT**, Epney, Stonehouse, Glos. h 59**I**NSTRUCTION AND PRACTICE IN BEE-MANAGEMENT; varied courses during May and June; 40 Colonies.—**BUGDEN**, Wye, Kent. h 41**W**ILKES' ALUMINIUM FEEDERS are a pleasure to use; they never rust. Sold by all dealers. 1911 list of latest ideas free.—**A. H. WILKES**, Four Oaks, Birmingham.**C**OMFORTABLE APARTMENTS for Brother Bee-keepers visiting Douglas. Terms: Tea, bed, and breakfast, 3s. 6d.; or full board, 5s. per day.—**HORSLEY'S**, Merridale House, top of Castle Drive, Douglas, Isle of Man.**B**UFF PLYMOUTH ROCKS. Bred from winners at the Burnley and Street laying competitions. Eggs—15, 3s. 6d.; 50, 10s. Chicks—13, 6s.; 50, £1.—**J. HOUSEHAM**, Huttoft, Alford, Lincs.**C**OVERS FOR BINDING "B.B. JOURNAL" and "RECORD," cloth gilt; "B.B.J." 1s.; Record, 10d.; post free.—"B.B.J." Office.**P**HOTO OF FOUL BROOD. Reduced price, 9d. post free.—"B.B.J." Office, 23, Bedford-street, Strand, W.C.**W**ANTED, bound volumes of Reports of British Bee-keepers and Affiliated Associations for year 1897.—**K.**, "B.B.J." Office, 23, Bedford-street, Strand, W.C.

## Editorial, Notices, &c.

### "ISLE OF WIGHT" DISEASE.

We would call the attention of our readers to the notice issued by the Board of Agriculture and Fisheries, respecting the investigations which are being carried on, and to urge on them the necessity of giving all the information they can. The matter is of national importance, so that every reader should endeavour to obtain all particulars from any bee-keeper who has lost colonies from this disease. It is a matter also that Bee-keepers' Associations should take up, so that the question may be solved during the coming season. We would therefore urge our readers to send for the circular alluded to, and do their best to supply the information.

The Board of Agriculture and Fisheries desire to inform bee-keepers in Great Britain that investigations are being carried on by their scientific advisers into the causes and characteristics of the disease among bees which has now broken out in many counties, and which originally made its appearance in the Isle of Wight. The Board would be glad to receive communications from bee-keepers whose bees have been affected by the disease, and who would be willing to supply information likely to be of service in connection with the investigations. A statement of the points upon which it is desired to obtain particulars will be sent on application. Information as to new outbreaks in districts only recently infected is especially desired. In certain cases specimens of diseased bees will be required. Correspondents are, therefore, requested to say whether they could send bees for examination. Bees should not be sent to the Board until asked for. Communications should be addressed to the Secretary, Board of Agriculture and Fisheries, 4, Whitehall-place, London, S.W.

### REVIEWS.

*Der Bau der Biene*, by Dr. Enoch Zander (Stuttgart: published by Eugen Ulmer, price five marks or five shillings). This is the third part of the handbook respecting the bee, the first two of which, namely those on "Foul Brood and Diseases," and "Enemies of Bees," we have already noticed. This book on the structure of the bee is the result of careful work, begun fifteen years ago, and some of which has from time to time been imparted to bee-keepers. In it Dr. Zander describes the outer and inner structure of the bee, and deals with a great many of the hitherto unsolved problems in connection with the anatomy of this insect. The work is profusely illustrated, there being

149 engravings in addition to twenty very fine plates consisting of seventy-five figures, reproductions of photographs, mostly of microscopical preparations. A useful feature of the work is the comparing the anatomical structures of the bee, with analogous parts of wasps and other hymenoptera. For instance, in the honey bee, the wax glands are situated on the inner sides of the lower abdominal rings, whereas in *Melipona*, they are under the dorsal rings. The sting is carefully worked out, and much additional knowledge is imparted. Here again, the comparison with the stings and ovipositors of other insects is most instructive. Chapter VII., treating of the alimentary canal, is full of useful information, and the description and illustrations show with what painstaking care the author has worked at this part of bee anatomy. He is also able to throw new light on the use of some of the glands. The author deals with parthenogenesis and shows that it not only obtains in bees, but is much more common than has been usually supposed. A chapter deals with the preparation and mounting microscopical specimens for study, which will be found most useful. This work is far in advance of anything we have respecting the anatomy of the honey bee, and the photographs of the dissections show the perseverance and skill with which Dr. Zander is endowed. We are pleased to welcome this book, and recommend it to our readers who are interested in the anatomy of the bee.

*La Loque des Abeilles*, by Fritz Lenenberger (published by M. Keller, Morat, Switzerland). The author of this pamphlet on foul brood, is the Chief of the Insurance Department of the Swiss Bee-keepers' Society. The object of the pamphlet is to describe foul brood in such terms as to make it easily recognisable by the uninitiated. The differences in the appearance of mild and virulent foul brood as well as sour brood are described. The author treats briefly on the rapid multiplication of the germs, their vitality and the way in which an epidemic is propagated. Lastly, the methods of treatment are described, great stress being laid on the importance of disinfection.

We have also received from the same author: *Bericht über die Faulbrutversicherung des Vereins Schweizerischer Bienenfrennde für 1910*. This is a report on the results of the working of the foul brood insurance scheme in Switzerland, during 1910. There were 7,498 members who insured 192,197 colonies. It was satisfactory to find that the number of cases of foul brood had decreased owing to the work of the inspectors, from 137 in 1900 to ninety-six in 1910, or a decrease from 1.3 per cent. to 0.9 per cent. This is a

result which shows that the measures adopted had not been fruitless, and that the inspectors are on the right road to success. Some of the Cantons, Appenzell, Zug, Uri, Glarus and Schaffhausen, are now quite free from foul brood, not a single case occurring during the year. In Graubunden, a badly infected canton, it has been reduced from nineteen to eleven cases, and in Canton Zurich out of 19,280 colonies there was only one case of foul brood. On the other hand, in Canton Tessin, the disease is still firmly established, and 25 per cent. of the insured colonies had foul brood. This canton is the home of the Italian bee, and, as the report points out, also the home of foul brood, which is of so virulent a nature that the re-infection of colonies is the rule, and not the exception, as in other cantons. The Canton Valais shows 6.6 per cent. of cases, and in this, both Italian and native bees are cultivated. Unterwalden shows 3 per cent, Graubunden 4 per cent., and the others less than 1 per cent. Notwithstanding the high percentage in Canton Tessin, the total number of cases in the eighteen cantons works out at 0.9 per cent., which is very satisfactory for one year's work in insurance and inspection, assisted by legislation, and should do something to convince the sceptic as to the value of legislation. In most of the cantons the premiums paid amounted to more than would cover the compensation, but in some of them the latter greatly exceeded the premiums. For instance, in Canton Tessin, the premiums amounted to only 89.80 francs whereas compensation, owing to the large number of cases, cost 1157.80 francs. On the other hand, there were cantons where there was no need for compensation, and where the premiums amounted to large sums. The total of premiums amounted to 13,924.25 francs, and compensation to 12,211.44 francs. Altogether the year's work shows very encouraging results.

#### WARWICKSHIRE B.K.A.

The annual meeting of the above Association was held on April 6th, at the Grand Hotel, Birmingham, when the report and accounts were duly approved. Mrs. Oliver-Bellasis, of Coventry, presided. In the report the committee record an increased membership in spite of another very unfavourable season from a bee-keepers' point of view. The income for the year amounted to £131, and the expenditure to £144, so that the year closed with a deficit of £13. The association held a show of honey, appliances, &c., in conjunction with the Warwickshire Agricultural Society, at Leamington, which proved to be one of the most successful exhibitions the society had ever held,

notwithstanding that the yield of honey in some parts was most indifferent. The bee tent was crowded each day, thus testifying to the continued interest in apiculture. Demonstrations under the auspices of the Warwickshire County Council were given by the experts (Messrs. George and Edward Franklin) at the following places: Coventry, Stratford-on-Avon, Allesley, Kenilworth, Tysoe, Marston Green, Leamington, Clifton-on-Dunsmore, Bedworth. Arrangements are in progress for holding an exhibition in August next at the Coventry Show of the Warwickshire Agricultural Society.

After the business part of the meeting was over, Mr. Geo. Franklin gave an interesting address on "Hints for the Bee-Keeper's Calendar," thus bringing an enjoyable evening to a close.—J. INGERTHORPE, Hon. Sec.

#### MIDDLESEX B.K.A.

##### ANNUAL GENERAL MEETING.

The annual meeting of the above association was held at 23, Bedford Street, Strand, on Thursday, April 6th. Mr. T. Bevan, and later, Mr. J. B. Lamb, presided, and there were present: Messrs. J. N. Farrant, S. C. Hadley, T. F. Judd, C. J. Heywood, C. A. Pond, J. Daniells, Andrew Clark, J. B. Lamb, J. R. Brooks, J. F. Fitch, J. Smallwood, and Miss Bennett and Mrs. Cranfield.

The minutes of the last general meeting were read and confirmed. The report was read and adopted, and the statement of accounts passed.

A cordial vote of thanks was carried unanimously to the Editors of the *British Bee Journal* for placing their office at the disposal of the committee for the meeting.

It was decided that His Grace the Duke of Bedford be invited to accept the office of president of the Middlesex Bee-keepers' Association. The following vice-presidents were also elected:—Right Hon. Lord G. Hamilton, Lord Avebury, T. W. Cowan, Esq., Sir E. M. Nelson, K.C.M.G., H. C. Stephens, Esq., and Major Fair. Mr. J. B. Lamb was unanimously elected Chairman of Committee, and Major Fair treasurer, vice Mr. Way, who has retired. Tansley Witt, Esq., J.P., was re-elected hon. auditor. A cordial vote of thanks was accorded him for his services.

It was proposed and seconded, and carried unanimously that Mr. W. Herrod be hon. secretary of the association in room of Major Fair who retires. A cordial vote of thanks was passed to Major Fair for the great interest he has taken in the association by acting as general secretary for many years. The following were elected on the committee:—Messrs. J. B. Lamb, Andrew Clark, J. N. Smallwood,

J. N. Farrant, T. Bevan, W. T. Iggulden, and Mrs. Wakefield. At a meeting of the committee after the general meeting it was decided to meet on the last Thursday in February, May, July and October, at five o'clock, but this year to call meeting late in May or early in June, so that the report may be in print.—A. W. FAIR, Hon. Sec.

## AMONG THE BEES.

IS IT QUEENLESS?

By D. M. Macdonald, Banff.

If you are searching for a queen which you cannot find, should you give up the work as a bad job after examining the combs more than once? is a question forwarded to me recently. If the handling of the frames has disturbed the bees so much as to stampede them, you should at once close the hive and try another day. If you have reason to conclude that some kind of queen exists in the hive, try the following plan, which reveals her presence as nothing else can. Take a frame of comb with eggs and unsealed larvæ from another hive and put it into the centre of the one you wish to search. Leave it undisturbed for about forty-eight hours, then examine the comb, and if you discover the formation of endimentary queen cells, you can safely conclude that there is no queen present. You are absolutely safe in this conclusion without any further searching. If, on the contrary, the bees have simply carried on the feeding and the sealing of the developing larvæ, you can be as fully confident that the bees in that colony have something that they recognise and treat as a queen, however worthless as a mother it may be. Should your aim be to re-queen, then a diligent search must be made until she is found and deposed. Without this preliminary proceeding, no care in introduction will assure the reception of your purchased queen. However valuable she may be the veriest scrub will be more welcome to the community than this alien queen.

In the height of the season, if you are doubtful of the presence of a queen, and after diligent searching do not find her, then look in one of the centre combs, and if you see a roundish oval part near the middle of these combs quite dry, cleared of honey, and highly polished, you may all but safely conclude that a queen is present and that the prescient little brains of the busy workers have decided that she will soon begin ovipositing. In looking for eggs in a broodless hive, don't waste time examining frames unless you discover some cells thus dried and polished. There, if anywhere, you will find the eggs deposited by a lately-fertilised queen, and as likely as not, she will make her presence manifest on one or other of these patches.

Small virgin queens are often very hard to find, owing to their being so little dissimilar to the ordinary workers in size, and indeed in general appearance, if the glance is only a casual one. Then she is very elusive in her movements. She dodges round the corner of a frame and back again in a most provoking and secretive manner. She hides under the sheltering shade of a bunch of bees, so that she is often imperceptible to even the sharpest eye. She makes for any cluster found on the floorboard, or sides of the hives, and she even takes wing from one point to another, in order to elude observation. There is nothing staid, queenly, or motherly about her movements. The graceful stately stride of a fertile queen has not been acquired by this flighty, fickle creature.

At times another form of queen is hard to find. You open a hive and discover unmistakable signs of the presence of a drone breeding queen. I think she uses no artifice to elude your observation, like the young bashful virgin. She simply lies low. She has not the heart to care whether she is seen or not it would appear. Life is no joy to her, she is simply a machine, and lies inert, almost lifeless, regardless of the future. You may withdraw the combs carefully, using little or no smoke, you may search them diligently one by one. All are laid aside, or returned to the hive, but your queen remains invisible. Repeat the process from the other side, and end where you began, and yet you frequently find your work profitless, and your searching vain. Recently three pair of eyes fruitlessly tested the truth of this statement. The light was not very good, but after a double search the drone-breeder remained queen of the hive. One of the chief causes for the non-discovery of a queen in a fairly populous hive is the use of too much smoke at the very beginning of the investigation. Set the bees once on the run and you may as well close up the hive and begin your search on some other day. Very little smoke should be given when the frames are exposed, and after, as the examination proceeds, simply waft a slight zephyr over the tops or sides of the frames. No clouds, no strong blasts, no hurricanes, are permissible, as these fairly stampede the bees and send them "all over the shop."

In ordinary circumstances proceed as follows: Expose two or three frames at most, and check the meditated outrush of bees by a few gentle puffs. Withdraw the dummy and place it aside (I always insert the dummy at the right side of the hive looking forward, and therefore know it is always there). The first frame is generally withdrawn and deposited at the side of the hive. A glance is given down the near side of No. 3, as the second comb is with-

drawn, and this is attended to as future combs are raised. Very frequently indeed does the shiny glance of her abdomen, as she walks down to take shelter behind the next frame, reveal her presence. In that position she shows off her queenly appearance better than in any other. If, however, she is not seen, the second frame is raised to the level of the eyes, the back turned towards the sun, and, on examination showing she is not there, the right hand is depressed, the left raised and a half-turn given to the frame, when all the second side is exposed in the best light to full observation. No time should be lost in returning this frame or laying it aside to give more room. Without devoting much time to the exposed side of the next frame, it is quickly reversed and examined. The same process is carried out until every frame is examined. In nine times out of ten she is discovered. In the odd case a re-examination of the frames in reverse order reveals her presence as a rule, but at certain times in very populous stocks the task is not a light one.

In a special case bees could be shaken from every frame, and allowed to run into the hive, when the queen is easily noticed if bees are allowed to enter slowly. In an extreme case they could be allowed to pass through excluder zinc, which would hinder her entrance.

---

## Correspondence.

---

*The Editors do not hold themselves responsible for the opinions expressed by correspondents. No notice will be taken of anonymous communications, and correspondents are requested to write on one side of the paper only and give their real names and addresses, not necessarily for publication, but as a guarantee of good faith. Illustrations should be drawn on separate pieces of paper. We do not undertake to return rejected communications.*

---

### APICULTURAL NOTES.

#### SERING FEEDING.

[8143] The season for 1911 has now commenced in earnest, and bees seem to have wintered well in this locality. I have two blanks caused by queenlessness out of fifty colonies, which I consider very satisfactory.

At this period of the year a few remarks on that ever-seasonable topic—the feeding of bees—might not be inapropos. Some years ago I paid a visit to an old lady bee-keeper—one of the old school—and, being like most other ladies fond of a cup of tea, she told me that tea was good for the bees, and that she had been in the habit of melting sugar with the hot tea out of the tea-pot, and feeding it to the bees by means of shallow tin troughs, pushed in at the entrances of the hives,

which, in her case, were straw ones; her opinion being that the bees liked the tea-flavoured syrup, and that it was very good for them.

In thinking the matter over, I resolved to give it a trial. Last autumn, when boiling sugar, I put in the pan as much tea as gave the syrup the colour of what would be considered a nice shade and strength for a cup of tea. All the hives I fed with this tea-syrup—and I fed some of them heavily—came out well in the spring, showing no sign of dysentery. This, I consider the more noteworthy, seeing that the sugar I used was not the most suitable for bee-food.

My experience leads me to think that the astringent, to say nothing of the stimulative, properties of tea, would, when mixed with ordinary beet or other sugar, prove as good, if not a superior winter food to syrup made from the best cane sugar.

There is no doubt we often use beet-sugar while thinking we are using cane. The only thing we are sure of being that we *paid* for cane. If the inference I have drawn from the result of my experiment be correct, it would mean a saving of expense to the bee-keeper.

*Manner of Feeding.*—During my long experience of bee-keeping I have tried many methods of feeding, and incidentally many different kinds of feeders. For the most part, I have practised the usual plan of placing the feeder on the top of the hive or brood-nests. But, in most cases where feeding has to be done, I have come to the conclusion that a better way is to place the feeder on the floor-board, just outside the rear division-board. To give access to the feeder in this position, the simplest and best way I have found is to take a half-inch thick board, about 6in. broad, and the same length as the dummy or division-board. In the centre and on one side, cut an opening which might extend to six inches long, and four inches into the board. On the top of the opening, if feeding is done by means of an inverted bottle, perforated zinc should be put: but, with ordinary flat feeders, this would not be necessary. This makes a nice feeding-stage, and there are two ways of giving access under it: one is by making a corresponding opening in the bottom of the division-board, or by simply lifting it up and pushing the stage underneath. The advantages I claim for this method of feeding are its convenience, and more important still, it does away with the necessity of removing any part of the covering over the brood nest, and, if properly carried out, there need be no jarring which might disturb the bees. I am convinced that it is a matter of vital importance that the heat, generated in the brood-nest, should



not be allowed to escape, as so frequently happens when the whole, or even part, of the covering is removed. Everyone knows what would happen if, on a cold night, the bed-clothes were wholly, or even partially removed; and the same result happens to the bees when their bed-clothes are taken off. It should be borne in mind that it is not the covering that warms the body, but the body that warms the covering—and it takes some time to do it. In the case of the bees it is the time required to do this in which the danger lies. This applies to any season, but more particularly to spring, if feeding has, of necessity, to be resorted to at that time.

Of course, feeding, as described, can

it I would seriously advise him not to take the tea out of his wife's tea-caddy. This is what I did and was *found out*—the result can be imagined. It proved the truth of the saying: "The way of transgressors is hard."—ALEX. REID, Balloan, Ross-shire.

#### A SOUTH AFRICAN APIARY.

[8144] I have pleasure in sending a photo of my home apiary which I hope is good enough for reproduction in the "B.B.J." Most of the hives shown are W.B.C. pattern, and my own make from  $\frac{1}{2}$  in. clear pine. The one in the front on the right is an observation hive. The trees all round are gum trees of various kinds, which provide both honey and



WONDERBOOM APIARY, GEZINA, NEAR PRETORIA, S.A.

only be carried out in hives that have sufficient space outside the dummy; or hives of the combination type, having the frames running across the entrance, and with space-room at the rear.

I shall be pleased if this small contribution to the pages of our *Bee Journal* shall elicit any discussion or criticism, as a change from the all absorbing and apparently never-to-end discussion on the subject of bee diseases. I feel like my friend, Mr. Ellis, that one almost requires to be disinfected after reading it in case of carrying infection to one's own bees.

In conclusion I must say one word more about this tea-feeding theory. If any married bee-keeper should think of trying

pollen in early spring and give my bees a start. The conditions are such in this district that I have by syrup feeding increased a five frame colony up to ten full frames during the winter time. I obtained the 1st prize medals at the last Pretoria Agricultural Show, for sections, granulated and liquid honey, of which we were very proud. My wife takes as much interest in bees as I do, in fact she claims the medals as her property. As I am not a judge of English honey, will you please tell me in what respects the sample of my honey sent by same post differs from the English of the same class. My biggest take from one hive—not assisted by other colonies—is 87lb. partly section, and partly extracted. So far this year I

have only 47lb. as a record, but as the honey season is not yet finished that amount may be increased. As highly qualified bee-keepers are very scarce in South Africa, I have had to rely on the "Guide Book," and my own experience for the knowledge I have gained. Mr. F. Sworder very kindly assisted me in my first attempts, and I am willing to return his kindness by assisting every bee-keeper I meet in any manner possible.—J. L. Taylor, Wonderboom Apiary, Gezina, Pretoria.

#### PARTHENOGENESIS.

[8145] With regard to queens being able to control the sex into which the egg will develop, I expect it would be found on observation that this is not confined to the bee. I am sending two gall-nuts which were found growing on stunted oak trees. I do not refer to the oak-apple, which is much larger. This gall, I think, is supposed to have been introduced to this country some years ago. In one of the specimens I am sending it will be seen that there is a centre cavity which contained the larvæ; in the other as well as the centre cavity there will be seen several smaller ones near the base of the gall-nut. From these male gall flies were hatched and they appeared a considerable time before any females; they were much smaller than the females, and darker in colour. Out of twenty of these gall-nuts which I kept under observation only one produced males, that is the one with five openings; all the others contained but the single female in the centre of the gall-nut. The arrangement of the males at the base of the nest, and five or six eggs being laid instead of one seems to me to prove that the gall fly was quite aware of the sex of the egg which she was depositing. There has always seemed to me to be many difficulties in the way of proving parthenogenesis with queen bees. For one thing I doubt whether there is any time of year that drones may not be found under some conditions. Late in the autumn I have found a single drone in a strong hive that appeared to have escaped the general massacre, and was being tolerated probably to spend the winter in the hive. With wasps it is different; males only fly late in the summer, and with some species very late. Last summer I found a nest of *Vespa Britanica* attached to a branch on a gooseberry bush. I cut it off and removed it to the side of my window, where I could observe the inmates. Most of the wasps remained and went on with their work as usual, but some—I expect the older ones—returned to the old spot, where they commenced building a very irregular sheet of

paper which could hardly be called a nest. In the centre of this is a small piece of brood comb was built and to my surprise on looking one day I found it full of larvæ. The weather then turned cold and something seemed to have destroyed all the wasps and larvæ when I again looked at it. The first time I am able to repeat the experiment I shall hope to do so; whether the young larvæ would have turned out to be males or females. I cannot say, but from the size of the cells built I should almost have expected that they would have developed into females. I never saw the old queen amongst those that returned to the bush, and feel convinced that the eggs must have been laid by the workers. The males did not leave the nest that I had at my window for a considerable time after. I wonder what our Swiss friend would say to this. I am sending the rudimentary nest made by the workers for inspection, and also one made by a queen wasp. The difference in the construction of the two is remarkable.

I have no doubt that our friend Mr. Crawshaw was right as to the date when the queen in my baby nucleus hive was mated last year, but I could not be certain as to this owing to her being able to pass through the excluding zinc at her own sweet will, and without my leave. Speaking of wasps I ventured my head very close to the entrance of a nest to see if they passed their legs over their antennæ on emerging into the light, as I think all bees do. I was not able to see that any of them did so, but I am convinced that it is not the cleaning of the antennæ previous to taking flight with the bee; when this is done it is a much more leisurely proceeding.

*Swarming*.—It is often said that bees dart through the air in every direction when swarming. Is this correct? I believe it is not; on the contrary they fly very slowly, many being young, and all with their honey sacks filled. The appearance of darting through the air is, I think, an optical delusion. If one bee is carefully followed in its flight, it will be noticed to fly very slowly.—Humble Bee, Allanvale.

#### RE-PAINTING HIVES.

[8146] May 1, as a practical man of twenty-six years' experience, point out the probable cause of the paint rubbing off as described by D. H. M., page 103. In the event of genuine English white lead being used too much, turpentine was added; or on the contrary foreign or broken-down lead was probably used. I may add that up to the present I have not found a ready-made paint or substitute to take the place of white lead. If your readers will try

the following method, I do not think they will be troubled with leaky roofs or with paint rubbing off. The first coat should consist of boiled oil and red lead, to which, if time is pressing, may be added a little patent driers. Then the work should be well stopped. Three coats of paint should follow, made as follows: Genuine English white lead, boiled or raw linseed oil, and patent driers in the proportion of 1lb. driers to six or seven of lead; a little turpentine, say about quarter portion, may be used in the first two coats to harden off quickly, the last coat to be oil only. If the hive is to be painted white, raw oil should be used, and a touch of drop black or blue added. Boiled oil being dark is suitable for stone or other colours.—G. J. F. Barnet.

#### DISEASE IN ESSEX.

[8147] "Isle of Wight" disease appears to have wiped out all the hives in the village of Thornham, near Hunstanton. The village is on the corner of the Wash and is, I believe, twelve miles from Massingham, the nearest known place where the disease has appeared. The bees, I am told, crawled about in thousands, unable to fly.

Sulphate of copper is used in the village for sprinkling. Does this not appear to have had something to do with the disease? I do not think that any queens or stocks are ever purchased from any other district by the Thornham beekeepers.

I am glad to say that this part of Essex has so far escaped the disease.—E. J. A., Bocking, Essex.

#### EXTRAORDINARY PHENOMENON.

[8148] During the recent severe weather, some clear liquid honey (labelled pure Californian), contained in a glass jar, formed again into the original comb, the latter being in a slanting nearly upright position in the middle of the liquid honey.

Can you or any of your readers kindly inform me if this is a usual occurrence in cold weather, and if so, what is the law of mutual attraction by which the atoms of wax re-adjust themselves into so complex and accurate a form as that of the comb, under pressure of atmospheric conditions only?

I shall feel greatly obliged if you will kindly inform me on this point.—Miss I. M. Fellowes.

[Dealers sometimes sell as pure Californian honey, a piece of honey-comb surrounded by glucose. It may be this that you have found. Such an occurrence as you describe would certainly be an unusual one, if there was no comb before, as there is no law of mutual attraction by which

atoms of wax which do not exist could re-adjust themselves.—Ed.]

#### CAPPINGS OF COMB.

BY L. S. CRAWSHAW, NORTON, MALTON, YORKS.

*Cost of Disease* (page 93).—It is possible that friend Woodley is in error in supposing that the million of dollars is actually spent in a vain effort to combat disease in America. Is it not likely that the very round figure is an estimate of the loss which U.S. beekeepers annually incur through the existence of disease? Perhaps D.M.M., who has access to the U.S. bulletin in question, will put me right. It is a little early yet to say whether the proposed diseases of bees legislation will prevent beekeepers from selling their products. The whole text of the Bill is under consideration by the Committee appointed to deal with it, and the result will appear in the "B.B.J." in due course. But if this objection to the recently published text should be removed, may we hope that Mr. Woodley will come into line? As to the referendum, I may set his mind at rest by informing him that no move will be taken by the Committee, until he, in common with other beekeepers of the land, has had an opportunity of expressing his views for, or against, the proposed legislation.

*Size of Frame* (page 95).—It is quite possible that, in exceptionally good districts, the standard frame may be on the small side, but as an all-round frame it has distinct merit. I refer, of course, solely to the size relation, and not to the vexed question of construction.

Has No. 8108 compared the results from the Langstroth, which he praises, with those from a standard, plus shallow combination frame. If not, may I suggest to him that he try the combination.

Some years ago, I made experiments such as I suggest, with promising results, but the combination proved to be unsuited to the district. The super of shallow frames is to be considered as a part of the brood nest, and allowed to remain on the hive for the winter. Later the shallows may be either raised to induce the bees to enter supers, or placed underneath the brood nest to stimulate breeding, or temporarily removed to form nuclei, assist a needy stock, or even for extraction. In fact, there are many manipulations which will no doubt suggest themselves to the experimenter. Queen cells, for instance, may be easily discovered on the lower edge of the shallow comb without much disturbance of the brood nest. It is advisable, however, to vaseline the outside of the frames to prevent attachments.

*Division Board or Dummy* (page 103).—I am glad to find D.M.M. also amongst the prophets, and would congratulate him upon the fact, even at the expense of my

being called "Gamaliel." I did not at first recognise myself. But would D. M. M. have known himself as Saul? Not the Son of Kish, of course, but his Tarsine namesake. Be that as it may, I am very glad to second D. M. M. in his plea for definition. Simplicity of terminology is not always obtained by the elimination of terms. Thus Dr. Miller, who admonishes D. M. M. would apparently abolish the word "stock," and confine us to "colony." Yet the term "stock," as used in this country, has its definite use as opposed to the term "swarm," whilst colony would surely, speaking strictly, include both. But perhaps Dr. Miller will explain.

*Spraying Charlock* (page 106).—It is all very well to theorise, but theories must be tested by the light of facts. Spraying is quite modern, whilst there is some evidence that similar outbreaks of disease have been known in the past. Again, the disease has appeared in northern districts, and in all cases I believe it has been traced to the importation of southern bees. Certainly the immunity of the brood points to food trouble, but in that case it is not primarily a disease at all, and the search for disease germs is futile. In support of this, I understand that failure has so far attended attempts to reproduce the disease with the various cultures. But does the "Isle of Wight" disease rage with greatest severity at spraying time? If spraying charlock be the cause, the trouble should be prevalent in autumn. On the other hand, the disease has been identified by some authorities with May pest. Whether or no, if spraying with sulphate of copper be the cause, it should be possible to reproduce the symptoms by adding Bordeaux mixture to the feed.

## Queries and Replies.

[4123] *Artificial Increase and Requeening*.—I should like your advice in the following. I have three stocks of bees in W.B.C. hives, one seems very prosperous (working early and late), and is headed by a native black queen, which I bought last year. I wish to do away with the other two queens—hybrids—and would like to rear queens from the first-mentioned hive. Is it possible to succeed with the following plan? To let the stock containing the black queen swarm naturally and take away the parent hive and bees, putting the swarm on the old stand. Then form three nuclei from the nine frames from the old stock. When the queens commence to lay, introduce one each to the other two hives, and join all nine frames, with bees, together again with the third queen, thus forming a new stock.—Beginner, Flint.

REPLY.—Your proposed plan should

work successfully, especially if you want to increase the number of your stocks.

[4124] *Storifying for Surplus*.—I shall be much obliged if you will give me an answer to the following. (1) I am feeding all my stocks—eight in number—with syrup, which they are taking greedily. The apple trees are just coming into blossom, so I suppose it will be unnecessary to feed much longer—for a time at any rate—as there are in my garden a lot of raspberries, strawberries, and some time trees. I am not sure whether there is white clover sown close at hand—but if not I suppose, after the above-mentioned blossom is over, I ought again to feed them. They are carrying in large quantities of pollen now. (2) One at least of my stocks looks very strong, though the weather so far has not allowed me to examine it. I propose to employ this for surplus extracted honey, and to proceed as advised in "Guide Book," page 61, by placing a second brood-box on the top of the other, or to place the brood combs in another brood-box above it, and put fresh combs down below. The word hive is mentioned; I suppose brood-box is meant, as a hive would mean a separate entrance, and this would not do perhaps. (3) I have only just discovered that the syrup I have made is not from cane-sugar—at least I understand it is probably beet and cane mixed at the best. I propose to make it in future from pure cane. I suppose no harm is being done.—Devon.

REPLY.—(1) As a rule it is not necessary to feed after May. (2) The plan adopted by most bee-keepers is to use shallow-frames for extracting purposes. If you double as you suggest you must have only one entrance: it can be done most comfortably with a double-walled hive. (3) The bees will probably suffer no injury, but it is best to use cane-sugar.

[4125] *Supposed Virgin Queen*.—I have one stock of black bees, which was built up from two driven lots in September, 1909. Last year they stored a small quantity of surplus, and when the super was removed (about August 7), I noticed several queen cells on the brood frames. At that time there were a number of drones in the hive, and also a good-sized patch of drone brood. The drones were cast out about the middle of September, and after being fed up with syrup, the stock went into winter quarters, covering about six frames.

The colony does not seem to have dwindled or increased perceptibly since last September, but though the bees still have plenty of sealed stores, and seem to be carrying water to the hive on warm days, I have not been able to see a single load of pollen.

I believe I remember a note by a corres-

pendent of your journal, which inferred that queens mated late in the autumn frequently do not begin to lay till well on in the spring, and then build up the colony very rapidly. Is this so, or am I to conclude that the bees' attempt to regučen last autumn was unsuccessful and that a fresh mother must be purchased in order to save the stock?

I may say I have only just moved to this locality and the bees were carried from South London, also that until the last fortnight I was not able to keep them under observation, only paying visits about once a month to the place where they were kept.

I should be grateful for any advice you can give me, as a novice, through the medium of your paper.—T. M., Ilford.

REPLY.—On the first warm day examine the brood nest. If there is brood all is well; if not obtain a queen and introduce her as soon as possible.

### A PETRIFIED BEE-HIVE.

EXTRACT FROM THE NATURAL HISTORY SECTION OF THE ANNUAL REGISTER, 1767.

The following is an account of a petrified bee-hive discovered on the mountains of Siout in the Upper Egypt, by M. Lippi, Licentiate in physic of the faculty of Paris.

"M. Lippi found on those mountains at the entrance of a vast cavern, a body of real stone, of an irregular figure, but quite porous, which he had the curiosity to open. He was very much surprised to see the whole divided into oval cells of three lines in breadth, and four lines in length, placed all manner of ways about each other, but nowhere communicating, all of them lined with a very thin membrane, and what was more wonderful, each enclosing a maggot or a fly perfectly like a bee. The maggots were very hard and very solid and might pass for petrified; but the flies were only dried up and well preserved as ancient mummies; and small oval grains which appeared to be eggs were often found under them. There was at the bottom of many of the cells a thick juice, blackish, very hard, appearing red when exposeth to the light, very sweet, making the saliva yellow and inflammable as resin. It was in short real honey; but who should ever think of finding honey in the bosom of a stone.

"M. Lippi conceives that this was a natural hive, which at first had been formed in a loose, light and sandy-earth, and afterwards was petrified by some particular accident. The animals that inhabited it were surprised by the petrification, and as it were fixed in the state they were then found. Their dried up mucosity had formed the membrane that lined the cells. At the time when the hive was yet soft the bees went out of it to seek their food and leave their honey in it.

"Still seeking in the same place other particulars to clear up this fact M. Lippi found in several parts the beginnings of a like hive. It was as it were the first-bed formed of a number of little cells for the most part open and containing the animal in all its different states but dried up and very hard. As well as the hives he saw bees-wax on one of the first beds, a second composed of a heap of little hillocks of about five lines in length, and an inch in diameter at their base. They were granulous, easily reducible into dust, and nearly resembled the hills thrown up by moles. M. Lippi opened them by striking gently and found in every one of them two or three oval cells filled with a yellow maggot."

## Notices to Correspondents

*Letters or queries asking for addresses of manufacturers or correspondents, or where appliances can be purchased, or replies giving such information, can only be inserted as advertisements. The space devoted to letters, queries, and replies is meant for the general good of bee-keepers, and not for advertisements. We wish our correspondents to bear in mind that, as it is necessary for us to go to press in advance of the date of issue, queries cannot always be replied to in the issue immediately following the receipt of their communications.*

OPTIMIST (Somerset).—*Spraying Trees.*—(1) Spraying with arsenates should be done after the blossoms have fallen and the apples are formed. Spraying when the blossom begins to burst is no use, and would not only damage the blossom, but also affect the bees. We have found the most efficacious time for spraying to be from two days after the blossom has fallen, and not later than ten days, as the calyx remains open for that time, so that the arsenic lodges in the eye, and when the calyx closes over it keeps the poison in position. (2) Bees gather nectar from swede blossoms, which they convert into honey. (3) The shade temperature at which nectar is secreted varies for different flowers with the amount of moisture in the ground and atmosphere, as well as the time of the day, and ranges from 68 to 83deg. Fahrenheit.

W. T. B. (Wansford).—*Sugar for bees.*—No. 1 sample is most suitable.

### *Suspected Disease.*

H. B. (Stonport).—The bees were too dry for us to discover cause of death. It will be safer to melt the combs, disinfect the hive, and start with new frames and foundation.

M. D. (Blandford).—The comb is slightly mildewed. This frequently happens in winter; they will become all right when the warm weather comes.

P. W. (Oilton) and A. E. H. (Essex).—Bees have died from "Isle of Wight" disease. Ayrshire, N.B.—The comb is affected with foul brood.

**Special Prepaid Advertisements****Two Words One Penny, minimum Sixpence.**

Orders for three or more consecutive insertions entitle advertisers to one insertion in "The Bee-keepers' Record" free of charge.

Trade advertisements of Bees, Honey, Queens, and Bee goods are not admissible at above rate, but will be inserted at 1d. per word as "Business" Announcements, immediately under the Private Advertisements. Advertisements of Hive-manufacturers can only be inserted at a minimum charge of 3s. per  $\frac{1}{2}$  in., or 5s. per inch.

**PRIVATE ADVERTISEMENTS.**

**15 HIVES FOR SALE**, for 10 or 15 Standard Frames, 5s. each, Section Crates, with sections, 2s. each; only safe and sound goods forwarded; can be seen at 3, Gladstone Cottages, Norwood Green, Southall.—Address, P. HANSEN, gardener and bee expert, 59, Castlebar-road, Ealing, Middlesex. h 99

**FOUR STRONG STOCKS ENGLISH BLACKS**, in 1911 Gamage W.B.C. Hives, each 3 lifts, 29s. each; also 4 new empty W.B.C. Hives 7s. each.—J. B. WALSH, Thornton Marsh Villa, Thornton, Poulton-le-Fylde, Lancs. h 95

**HIVES FOR SALE:** 1 Conqueror, 1 W.B.C., double walls.—HARDY, Aldbrough, Hull.

**HIVES**.—5, practically new, well painted, for sale, cheap; also Supers, etc.—Full particulars, FREEMAN, Singleton, Sussex. h 94

**TWO NEW BAR FRAME HIVES** with lift and 10 Frames, wired, canvas covered roof, painted, 11s. each; photo and particulars.—HEARD, Orchard Hill, Bideford. h 98

**WHAT OFFERS** per lb. for about  $\frac{3}{4}$  cwt. of excellent 1910 CAMBRIDGESHIRE HONEY? Sample in screw top glass jar, 3d.—SCHOOLMASTER, Bourn, Cambridge. h 97

**WHITE FANTAIL PIGEONS**.—Several pairs of last year's birds for sale, 3s. a pair.—SCHOOLGIRL, Elston Rectory, Newark. h 92

**WANTED**, a few Colonies of healthy BEES on frames; boxes for travelling will be sent.—T. LEWINGDON, The Club, Wokingham. h 91

**HONEY EXTRACTOR** for sale, nearly new, 12s. 6d.—WRIGHT, Roxby, Doncaster. h 88

**EXTRACTOR**, 2 guinea Cowan, good order, 15s.; 3-division Mahogany Showcase for 12 sections, 6s.; 100 Super Boxes to hold 7 sections each, 25s.; 500 tin Dividers, 4 $\frac{1}{2}$  in. by 4 $\frac{1}{2}$  in., 5s.; 120 pieces glass, 4 $\frac{1}{2}$  in. by 4 $\frac{1}{2}$  in., 2s.; 60 springs in blocks, 3s. Going abroad. E. Davis, Great Bookham, Surrey. h 87

**STRONG HEALTHY STOCKS** on 3 Frames, 1910 queens, £1 each.—J. C. JUDD, Welfare Apiaries, Pinkney's Green, Maidenhead, Berks. h 86

**EXPERIENCED BEE-KEEPER WANTED** to look after Apiary in Scotland. Send all particulars.—D., "B.B.J." Office, 23, Bedford Street, Strand, W.C. h 85

**12 STOCKS OF BEES** in good Hives for sale.—SPECK, 855 Stratford-rd, Spark Hill, Birmingham. h 84

**PURE HONEY** in 1lb screw top bottles for sale; also Honey in Combs; took first prize about 3 years ago Taunton Flower Show.—THE VICAR, Stoke Saint Gregory, Taunton. h 83

**GOOD LIGHT HONEY**, granulated, 14lb. tins, 9s.—WILLAN, Sizergh, Kendal. h 78

**ENGLISH HONEY**, dark, good flavour, 14lb. tin, 5s.; 1 strong Stock Bees, guaranteed healthy; 3 empty Hives, all good, worth £1 each; geared Extractor appliances, £2 the lot; going abroad.—R. SAINSBURY, 54 Charlton-rd, Southampton. h 80

**8 SHALLOW FRAME RACKS**, complete, with 8 healthy wired Combs, metal ends, 3s. 6d. each; 30 shallow Frames, full sheets foundation, 5s.; 7 Queen Excluders, 3s.; 60 standard brood Combs, free drone cells, wired, metal ends, 6s. dozen; 12 Standard Hives, made of  $\frac{3}{4}$  red deal, double walled, 4s. each.—Particulars of above from W. WATTS, Westbay Farm, Chickereff, Weymouth. h 79

**Special Prepaid Advertisements.—Continued**

**BEES FOR SALE**, 3 strong, healthy Stocks, 1910 queens.—Apply, P. HEATH, Thremhall Priory Cottages, Bishop's Stortford, Herts. h 77

**SWARMS**, guaranteed healthy, May 3s., June 2s. 6d. lb., boxes returnable, cash with order.—ANDREWS, Longthorpe, Peterboro'. h 80

**THREE HEALTHY STOCKS** in Standard Hives, 4 section racks, 2 excluders, feeders, smoker, pair Birkett gloves, the lot £3.15.—NELMES, Cathcart. h 67

**REMOVAL SALE**.—13 Burt's W.B.C. Hives, new, 3 coats white lead paint, calico covered roofs, 23s. each (includes legs, &c., 10 brood frames and ends, 2 shallow boxes, 8 frames each, wide ends, all full sheets, weed foundation wired); 12 Nucleus Hives, with 8 frames and ends, used one season, 3s. 6d. each. Following 2-year-old hives repainted: 6 Garner's Sleaford, 11 frames and ends, 2 lifts with 9 shallow frames, wide ends, all full sheets, wired foundation, 13s. 6d. each; 3 Garner's Cottage, 11 frames and ends, 5s. 3d. each; 4 Lee's Alliance, 10 frames and ends, 6s. 3d. each; all on rail; 9lbs. Weed foundation, thin brood, 18s., post free; 4 ditto, 9s. 3d.—REV. W. E. MATTINSON, Happisburgh, Norwich. h 76

**BEES FOR SALE**, on frames, 17 Stocks.—GARWOOD, Pir. Heigham, Gt. Yarmouth, h 58

**WANTED**, good Brindle bull-terrier dog pup.—W., "B.B.J." Office, 23, Bedford-street, Strand.

**BUSINESS ADVERTISEMENTS.**

**FOR SALE**, overstocked.—Shallow Frame Crates, 8 clean drawn-out combs with ends, 4s. 6d. each, 5s. 2/6; do. full sheets wired drone base (new), 3s. 6d. each. Kitson, Stansted, Essex. h 90

**STRONG**, guaranteed healthy SWARMS, expected daily, 15s. 6d., boxes 6d.; June, 12s. 6d.; strong, healthy Stocks, Frame Hives, 29s. 6d.; Skeps, 18s. 6d.; satisfaction assured.—HIGGINSON, Egerton, Kent. h 82

**SWARMS**.—Guaranteed healthy, May 15s., June 13s.; boxes returnable.—ADAMS, Farnham, Blandford. h 68

**35TH YEAR**.—Three framed Nuclei, healthy queen, bees, brood, 12s. 6d.; empties returned, paid.—ALSFORD, expert, Haydon, Sherborne. h 61

**1911 VIRGINS**, Blacks, Carniolans, Italians, 1s. 6d.; Americans (Golden), Cyprians, 2s.; Swiss, 2s. 3d. Send for price list. Cash with order.—FREDERICK VOGT, 38 Clementina-road, Leyton. h 70

**QUEENS**, fertile, in introducing cage; delivery guaranteed, 5s. 6d.—BRICE'S APIARIES, Offord, Kent.

**GOLDEN PURE CYPRIAN** fertile Queens, gentle strain, five yellow banded, 6s. each, post free.—Write to DERVISHIAN BROS., Nicosia, Cyprus. h 71

**NOTICE**.—The tone blocks used for printing the pictures of "Homes of the Honey Bee" in "B.B. Journal" may be obtained from this office, post free, 2s. 6d. each. They are useful for advertising purposes, or for picture post-cards. Room wanted, and those now in stock will be kept for a short time only.

**WANTED**, a Well-Educated YOUTH to learn Bee-Keeping, either for three or six months, live with family.—Apply, LEWIS J. HOBBLEY, Chilver's Coton, Nuneaton. h 93

**BEES**, Stocks on Combs, guaranteed healthy, six, eight, and ten frames, 20s., 25s., 30s.; empties returned.—F. A. BEAN, Snaith, Yorkshire. h 89

**WANTED**, SWARMS.—Reply, giving price per pound in May and June, to HERROD and STEWART, Apiary, Laton, Beds.

**SWARMS**, guaranteed healthy, May and early June 10s. 6d.—COMLEY, Dynever Place, Fairford, Glos. h 81

## Editorial, Notices, &c.

### SHROPSHIRE B.K.A.

#### ANNUAL MEETING.

The annual meeting of the Shropshire Bee-keepers' Association was held at the Mayor's Court, Shrewsbury, on Saturday, April 29th. Mr. Roff King presided.

The report of the committee stated that they had the pleasure of announcing a very successful step lately taken in the interests of practical bee-keeping. The examination held last August was in every way satisfactory, most of the candidates having satisfied the examiner. The annual show held in the Quarry in conjunction with the Shropshire Horticultural Floral Fête last August was very successful, the entries exceeding the number in 1909 by 85.

The balance-sheet showed a balance in hand of £21 4s. 5d., as compared with £30 15s. 1d. in 1909. The decrease was attributed to the increasing of the awards at the show.—The report and balance-sheet were adopted.

The Mayor of Shrewsbury was unanimously elected president for the ensuing year, and Mr. Beville Stanier, M.P., and Mr. Wm. C. Bridgeman, M.P., were elected vice-presidents. The Treasurer (Mr. Holland) and the Secretary (Mr. Cartwright) were unanimously re-appointed, and Mr. P. Scott was again appointed expert to the Association. The committee were re-elected, on the proposition of Mr. Oliver, seconded by Mr. Holland.—Mr. Cooper proposed, and Mr. Holland seconded, the re-election of Mr. Roff King as chairman.

Votes of thanks were passed to the officers for their services.—The Rev. G. E. Pratt and Mr. T. Cooper were appointed delegates to the British Bee-keepers' Association.

On the motion of the Rev. G. E. Pratt, it was decided to support the Central Association in their endeavour to obtain a "Foul Brood Bill," and that the Shropshire M.P.'s should be asked to do likewise.—S. CARTWRIGHT, Hon. Sec.

### ABERDEEN B.K.A.

#### ANNUAL MEETING.

The first annual meeting of the Aberdeenshire and District Bee-keepers' Association (in affiliation with the British Bee-keepers' Association) was held on Saturday, April 8, in the Agricultural Classroom, Marischal College, Aberdeen. There was a fairly large turnout of members, over which Mr. Middleton, Maryculter, presided.

Mr. Low, the secretary, submitted a report of the business of the association

since its formation in June last. This report was considered highly satisfactory, the membership being now close on 100.

Mr. Moir, station agent, Grange, then gave a most interesting practical demonstration on the making of bee candy, showing the advantages of some slight alterations in the customary recipe which is given in every bee-keepers' text book. These alterations consist in, first, adding about a teaspoonful of cream of tartar to the text book ingredients, and, second, in reheating the candy during the final operations. Mr. Moir explained that the bee-keepers' difficulty in making candy is to get it without granules. It should be "just like putty."

After the discussion, the secretary read correspondence with regard to examinations in connection with the British Bee-keepers' Association. Further, it was agreed to alter one of the rules as to the size of the committee, making it smaller, but in the future including in it all the district secretaries. The usual votes of thanks brought the meeting to a close.—A. Low, Hon. Secretary.

### HONEY IMPORTS.

The value of honey imported into the United Kingdom during the month of April, 1911, was £4,441.—From a return furnished to the BRITISH BEE JOURNAL by the Statistical Office, H.M. Customs.

### BEE-KEEPING IN LEWIS.

BY J. ANDERSON, M.A., B.Sc.

If you glance at the map of Scotland you will notice that the north-western coast is guarded by two groups of islands—the Inner and the Outer Hebrides. Lewis is the northern and larger part of Long Island, which, in turn, is the largest of the Outer Hebrides. It has a population of almost thirty thousand, nearly all of whom can speak Gaelic, and a considerable number understand very little English. There are many square miles of heather, acres of white clover, and countless varieties of wild flowers, yet when we started bee-keeping in May, 1909, there wasn't a hive bee in the island.

The writer happens to be science master of the largest school in Lewis, and bees were introduced as a branch of the practical science course. The usual volume of cold water was thrown upon the scheme. "The bees would sting the children." "It had been tried before and the climate had proved too damp." "It was exposed to cold winds, and bees would not live without trees." But our experience goes to show that Lewis is specially suited to bees. They winter well, consuming very little honey during the cold period; they



start work as early as in any part of Scotland, and the season lasts much longer than in the south of England. Last year we had bees working in supers in the third week of October. The absence of timber means the absence of propolis, so that our sections are unsurpassed for whiteness and beauty.

This season our best stocks began breeding just after the New Year, were collecting pollen in the second week of February, and now (28th March) have brood on four frames. One stock has actually a small patch of capped drone

honey collected in the fag-end of the season.

The fear of stings proved groundless. We can walk round the hives singly, in groups, or in classes, and the bees pay no attention. The boys—and girls—can manipulate without veils or gloves, and the teacher never has a more interested class than when he is opening a hive. How the little ones tumble over each other in order to "see the queen!"

Four of the big boys are "Bee Specialists." These have examined the bee under the compound microscope, and



MANIPULATING WITHOUT VEIL OR GLOVES.

brood—and yet they have had no syrup this season.

The most profitable colony last year was a late June swarm from the south of England. It was hived in Devonshire on 20th June, and travelled northward by train and steamer on seven frames of foundation. It was transferred from the travelling box by what little light remained after it arrived here about 11 p.m. on the 22nd. The first bee began foraging in Lewis on the morning of the 23rd, and this swarm never received any feeding. Yet it filled two racks of sections, and gave six frames of heather honey. This, with thirty pounds to winter on, makes at least 100 pounds of

have made beautiful drawings of every part. They have made themselves hives in the school workshop, and the teacher is going to advance them a swarm each, for which they will pay out of the proceeds of their first hundredweight of honey. They can find the queen, identify brood in all stages, and manipulate (without veil or gloves) like trained experts.

After examining various observatory hives, and making extended tests of one or two commercial forms, we devised one of our own, which we have proudly named the "Nicolson," after the name of our school. At the end of last season this hive was sent to Mr. Brodie, of Messrs. Steele and Brodie, and his varied



experience, gathered in two continents, was able to suggest certain useful modifications. The "Nicolson" Observatory resembles the "Brice" in taking just one standard frame, but there are material differences which we believe to be improvements. The chief difficulty in a one-frame hive is the disproportionate lateral extension of the cluster, and the consequent rapid loss of heat. In some commercial forms this difficulty is increased, because the structure of the observatory permits a cold draught through the hive. In the "Nicolson" this loss of heat has been minimised by providing ample room for quilts, by double glazing, and by fitting cosy, removable shutters to the sides. The hive opens at top and bottom, so the bees can be manipulated as easily as in a standard hive.

The turntable is fastened by four screws to the inside window-sill, and a passage under the table leads to a flight-hole in the window-frame. In windows too valuable to be auger-bored, we make the flight-hole in a flat piece of wood clipped under the raised sash. Outside there is a small alighting-board. The hive can be turned round on the table with perfect ease and freedom from jar, and every bee in the hive can be seen. If wanted for a lesson in another room, the hive is simply lifted off its table, the entrance being temporarily closed by a slide. Any bees outside at the time of removal can cool their heels in the passage till the lesson is finished.

These observatories—we have usually three or four in use—arouse extraordinary interest. And it is not only the pupils—many grown-up people pay special visits to the laboratory to see the bees. We have placed them in windows facing the south, so the sun shines in during the part of the day when the bees are most active. We turn the hive at right-angles to the sun-rays, and direct the light on the comb with a hand mirror. In this way we can see the bottom of any cell, examine the new-laid egg, observe when the tiny grub first appears, and follow its history till it emerges as a downy youngster and starts to preen its wings on the comb.

We have made a large number of observations during the last two seasons, but these are not yet ready for publication. Some of these confirm accepted beliefs as published in certain bee-manuals, others are a trifle unorthodox. For instance, we have confirmed to the very letter certain observations made by Videt Bernhard, a little English girl of nine, who wrote to "Uncle Amos," of *Gleanings*, in 1884. These related to the storing of pollen and are like this: A pollen-bearer comes fussing over the comb, shaking its body

in a characteristic way. It appears to waste much precious time in searching for a cell with the same kind of pollen. When such a cell is found at last, the bee hangs on to its upper wall with its front feet, its abdomen is curved as in stinging, and the hind legs inserted in the cell. The pellets are pushed off by the middle pair of legs. The bee gives itself a final shake and marches away over the comb. In a very short time another and apparently younger bee comes along, and peeps into the cell. It sees two little pellets resting on the lower wall, thrusts in its head, moves round for about two minutes, and withdraws. Another glance into the cell will show that this fresh accession of pollen has been neatly incorporated with that previously packed in the cell. The books say that the pollen-bearer packs her own load, but we found that Videt was right every time.

It seems to us that bees are very suitable as subjects for nature study. All



THE "NICHOLSON" OBSERVATORY HIVE.

schools may not have accommodation for full stocks, but nearly all can have a one-frame observatory. We are sure any bee-keeper would supply a frame of bees. If it contained eggs, the rearing of the queen might be followed. The bees could be returned at the end of the season. The ideal arrangement, however, is to have the observatory for minute study, and one or more standard hives in the school garden as well. We have seven full stocks and four observatories, but then we have over a thousand children.

Our school apiary has had remarkable secondary effects. In 1909 ours were the only bees in Lewis; three other bee-keepers started in 1910; other four are beginning this season: and May, 1911, will see twenty-two stocks in Lewis, without counting possible swarms. The honey is

of excellent quality, and is sold locally as soon as it comes off the hives.

Bee-life in our little observatories seems to be quite normal. One of them actually swarmed last season, and all the usual phenomena were exhibited. Two queen cells were built and one of the queens was duly mated. Before she began to lay, however, one of the workers lost patience, and began to display great energy in egg-laying. We saw as many as five eggs in one cell, and eggs on top of honey and pollen. Extra eggs are said to be removed, but more than once we counted at least two grubs in one cell. When the queen began to lay, those drones were all cleared out.

nut, and beech trees in bloom. In addition to this welcome spell of fine weather we have another cause for thankfulness in that we have in this district so far escaped the "I.O.W." disease, and I hope Mr. Bullamore's prophecy will come true, that, given a good bee season, we shall not hear much more of this most deadly of bee pests.

The case I mentioned in South Scotland of the outbreak which occurred in an apiary of fourteen stocks, through the introduction of a swarm from Surrey, and in which disease developed shortly after they were established, showed the well-known symptoms of the "I.O.W." disease—this was in June, 1909. The bee-



THE BEE-KEEPING CLASS AT NICHOLSON SCHOOL, LEWIS.

## Correspondence.

*The Editors do not hold themselves responsible for the opinions expressed by correspondents. No notice will be taken of anonymous communications, and correspondents are requested to write on one side of the paper only and give their real names and addresses, not necessarily for publication, but as a guarantee of good faith. Illustrations should be drawn on separate pieces of paper. We do not undertake to return rejected communications.*

### NOTES BY THE WAY.

[8149] The present month of May, especially the last few days, has brought ideal bee-weather, and the bees are making the most of it here. Though it cannot be said that there is abundant forage just at present, the dandelion is now beginning to flower in every piece of old lawn and meadow, and the brilliant sunshine has brought the turnips into full bloom, which is an additional help, though over a restricted area. In a few days we shall also have the sycamore, horse-chest-

keeper, instead of lamenting his loss, set about repairing it at once. For the loss of wing-power he administered nervines in food, hoping to discover a remedy; this failed to prove of benefit, so he tried other remedies, and at last hit upon a herbal powder, with which he fed last summer, and to-day he has his apiary of fourteen stocks in a healthy condition.

My friend, also referred to as having lost some thirty out of thirty-seven or thirty-eight stocks, in the Reading District, is trying this Scotch remedy on his surviving colonies. I hope to be able to give the result in my next notes.

I thank Mr. Crawshaw for note, page 177, *re* F. B. Bill, still under consideration—and it seems to me that it will require very serious consideration before we shall willingly allow travelling experts to handle our bees after they have been in contact with all and sundry bees, and old appliances. Just now, with the "I.O.W." disease rampant in the

southern division of the country, I would not, under any conditions, allow a Berks., or, for that matter, a Government inspector to overhaul my apiary unless I was guaranteed compensation for any disease he might introduce by his investigation. The present condition of things apicultural makes one feel really glad that we rallied our forces five years ago, and scotched the Bill of those days, otherwise, if so-called experts had had the run of the country, we, as bee-keepers, would most probably have been wiped out entirely with this deadly new pest. As regards the position I have taken regarding the spread of disease by careless experts, Mr. S. Simmins, page 153 "B.B.J.," admits the possibility of spreading this new pest, and till the visit of Mr. Cooper among the bees on the South Coast is investigated, I shall be inclined to think that this had something to do with the outbreak. Again, how are the bees in the Island faring now? Are any new apiaries established, and were the infected hives used again? I hope our friends in the Island may give us some information on these points, so that we may know how to proceed if we should get the dread pestilence in our apiaries.—W. WOODLEY, Beedon, Newbury.

#### ROSS-SHIRE NOTES.

##### "ISLE OF WIGHT" DISEASE.

[8150] For some time back we Northerners have impatiently skimmed the disease-reeking pages of the "B.B.J.," but the appearance of the trouble in our midst engenders a fellow-feeling for other sufferers. Last summer I invested in some English swarms, which did well at honey-gathering and wintered safely. In March I noticed that one lot, while flying strongly, carried in no pollen, although all the rest were busy. Suspecting queenlessness, I examined the hive and found two combs of brood and ample stores. Last month I saw dying bees crawling about under the hive, and on making an inspection found the colony reduced to a mere handful, with the queen still making a pitiful attempt to fulfil her life's work. Then I understood what the trouble was, and after sulphuring the bees, scorched the floorboard with flaming petroleum.

None of my other stocks, native or imported, show any signs of disease as yet, but I am keeping a watchful eye for the first symptoms.

This disease is a most serious one, and, until mastered, must have a paralysing effect on the craft as well as the bees. Who would venture to buy stocks, swarms, or nuclei, even with a guarantee given? The vendors may honestly believe their bees to be healthy, but the disease in its initial stages may be there, all unsuspected.

Again, why purchase hives, sections, &c., when we know not the day or the hour that disease may come and wipe out our bees? Many theories, ingenious or amusing, have been advanced as to the origin of the trouble.

Charlock-spraying is unknown here—the imbibing of alcohol is not, but its paralysing effects are temporary and confined to the human species.

However, while the scientific men are investigating the cause, and the possessors of ruined apiaries lamenting the effects, those who have bees left are chiefly concerned about finding a cure.

In the treatment of foul-broody stocks, total destruction by fire and brimstone was at one time thought necessary. Nowadays all that is changed, and diseased stocks can be cured and made to store a heavy surplus the same season. Sooner or later the "Isle of Wight" disease will be overcome in like manner.

A sharp distinction must be drawn between foul brood and bee-paralysis. The former, as the name implies, is essentially a brood disease, while the "Isle of Wight" pest affects only the adult bees. In both troubles alike the elements of health and disease are present together, and the bee-keeper, by removing the diseased portion, can aid Nature in the fight for life. Foul brood is curable by destroying the diseased brood and starting the colony anew as a swarm. Conversely, bee-paralysis should be curable by destroying the entire population of an affected colony, and building up afresh from its brood. Desperate diseases require desperate remedies.

However, there need be no real loss if an artificial swarm is put on the naked brood. When a case of paralysis is noticed, deprive the diseased bees of all their brood, except a small patch of larvæ, to prevent their swarming out. This should be done on a warm day when bees are flying freely, and the totally beeless brood placed on the stand of a powerful colony, the latter being moved to a new site. Then, in the evening, brimstone the diseased broodless bees. Three days later a vigorous young queen can be given to the new colony, and both lots built up strong for the coming honey-flow.

Perhaps some sufferers may give this plan a trial now.—J. M. ELLIS, Ussie Valley, Conon Bridge.

#### CURIOUS BEHAVIOUR OF BEES

##### AND RAILWAY PORTERS.

[8151] First the bees.—Last October a kind friend sent me, unasked and unexpected, bees driven from six boxes in one swarm-box. I did not want to disturb

my hives, so hived them in an empty one, giving at first, as it was abnormally warm for a few days, warm syrup in a rapid feeder. When the weather cooled I put on a 4lb. cake of candy, and later another 4lb., which they did not quite finish. They probably started with six queens (I saw three) as they desired to go into several places—under the hive, on the sides, etc., and were finally got in with the aid of brush and dustpan. The last bee was dead and the hive empty of live bees a week ago—on one frame was a patch of dead brood about 2½ in. in diameter, and in another comb was a hole an inch across, with one perfect queen cell open, lid and all complete, and three abortive cells on its edges. When did they rear that queen? Three hives here have built comb and stored about a teaspoonful each of honey in candy-boxes already.

Second, the railway porters.—A few days ago I packed one of Lee's Claustral Hives containing a strong stock of natives for transmission to Bourne-mouth. It arrived in the morning instead of the same night, with the alighting board and one leg broken (the alighting board was tucked under the cordage). The Company must have put an expert on the work—though not a bee expert. Of course, combs and bees suffered in proportion to the outer damage.—W. E. C. Missox.

[The hive having become queenless from some cause or other, the bees would immediately commence to rear another queen.—Ed.]

#### CHARLOCK SPRAYING AND DISEASE.

[8152] Your correspondent, Mr. H. Balfour Gardiner, in the "B.B.J." for April 6th, asked for an answer to the following question: Was charlock spraying practised for the first time in the Isle of Wight in 1904, or for the first time in 1908 in the portion of N. Wales marked with a cross in the map accompanying the report of Dr. Malden's address? As the unfortunate occupier of that cross in the second district named, I am able to answer the second part of his question.

First of all, the disease did not break out in this apiary in 1908; in fact, not until October, 1910. The apiary is on a hillside; around and below it respectively are a garden and orchard and many fields, extending to the valley of the Clwyd. On enquiry I find that the spray was used by a farmer near Denbigh, six or seven years ago, seven miles from this apiary. A neighbouring farmer used it in 1908. His fields lie nearly a mile to the north of us, over the spur of a hill, and the bees from here do not fly in that direction. There is much more eligible

pasture near at hand, for our own orchard and fields extend for half a mile to the north, one mile to the west, three quarters of a mile south, and half a mile east. There has been no spraying of any kind in the garden or orchards.

In 1903 and 1905 charlock was sprayed in many of our fields. The stocks were normally fit in 1903 before the spraying, and remained normal each year until last September, when they went into winter quarters, nineteen very strong colonies, in a most satisfactory condition. Of those nineteen, sixteen had perished to a bee between January 9th and March 17th, 1911, the first symptoms being noticed on October 10th, 1910. Every precaution has been taken to remove all traces of disease. The three remaining colonies also have been removed to a different part of the orchard, a hundred yards away from the apiary, and twenty yards apart. One of them is weak owing to excessive activity during the fine days of mid-winter, but is perfectly healthy to all outward seeming; one other is as good as a stock coming out of winter should be, and the third is already supered (May 1st), has seven combs covered with brood, including some drones, and it has been necessary to substitute a comb of this year's honey weighing 4lb. by an empty comb, to give the queen more room to lay.—S. J., St. Beuno's College, St. Asaph, N. Wales.

#### SLIDING SUPER CLEARER.

[8153] I venture to draw your attention to a novel device for clearing supers in hives for the purpose of removing honey, etc. This ingenious piece of apparatus was invented by Mr. D. J. Williams, Head Teacher of Lampeter Velfrey School, near Narbeth, Pembrokeshire.

The object of the inventor was to simplify the teaching of practical bee-keeping to his pupils, this subject being taken up in this school as a branch of nature study, an example which might well be followed with great advantage to children attending elementary schools throughout the rural districts of this country.

I asked Mr. Williams to make the enclosed model so that I might draw your attention to it for the benefit not only of school masters who have been unable to overcome the difficulties of teaching bee-keeping to classes of school children, but also of numerous amateurs throughout the country.

The super-clearer, as you will see by the enclosed model, consists of two sheets of queen excluder zinc, the upper sheet of which slides over the lower just sufficiently far to open or close the perforations in the two sheets. The upper sheet, which is the movable one, has a small

flange or handle which projects outside the back of the hive when the apparatus is placed between the brood-chamber and the super.

In order to clear the super, the handle is pressed forward, thus shutting off the bees in the brood-chamber from the super. The bees in the super are allowed to escape by turning back a portion of the quilt and replacing the roof containing a cone escape. By this means the frames can be removed without any danger of the operator being stung.

I shall be glad to hear your opinion on the value of this device, from both practical and educational standpoints. Mr. Williams informs me that he will be very pleased to furnish you or any of your readers with further details, should they be required.—R. GRANT.

[Such a device was shown by Mr. E. Nuttall, of Wolverhampton, at the Conversazione of the British Bee-keepers' Association, held on 7th October, 1909, and a description of it will be found on page 442 of the "B.J." of that year, together with the advantages claimed for it by the inventor. The main objection raised during the discussion was the great number of bees that would necessarily be cut in halves in sliding the zinc, as there are always a great many bees passing to and fro. Another objection was the great difficulty of getting the openings to fit sufficiently accurately over each other.—Ed.]

#### BEES AND FRUIT POLLINATION.

[8154] I should be very grateful if you can elicit for me by a query in your valuable Journal any information on the proportionate number of hives of bees to acreage of fruit; thus, whether fruit growers who believe in bees (or expressed differently, have realised the value of bees) recommend one hive per acre, one to four acres, or what proportion; the proportion will also depend on the variety of fruit to be pollinated. The question might elicit the opinion of cherry growers, raspberry and strawberry growers as to their experience, etc.—CECIL H. HOOPER, Fern Villas, Wye, Kent.

#### CRITICISMS.

A LITTLE LEARNING IS A DANGEROUS THING.

[8155] A sentence referring to a theory of disease is quoted on page 128 to show that I have doubts as to the truth of my statement that Italians are less prone to resort to nectar substitutes than the black bees. This misapprehension, due probably to careless reading, occasionally occurs in Mr. Macdonald's writings, and I would like to point out some instances:

When Mr. J. Gray was referred to as the originator of the flour method of queen introduction, Mr. Macdonald objected, and said that flour as a pacifier was introduced by a Scotchman. It is true that, "A Carluke Amateur," in the "B.B.J." for 1891, explained its use for uniting stocks, but he does not mention its value for introducing queens. If Mr. Macdonald had told us of a Scotchman who had published an account of its use in the latter operation, it would have been more to the point. The honour of first mentioning the process, I believe, is to rest with Mr. Woodley, who described it in 1905. It then passed unnoticed, and Mr. Gray re-described it in 1909. I do not remember that Mr. Macdonald mentioned it until 1910.

In Kirby and Spence's "Etymology" is the following:—

"I have never met with any honey-dew which did not seem to me very clearly referable to *aphides* as its origin; though from the circumstance of their having been all swept away by the attacks of their natural enemies and other causes, while their saccharine excretion remains on the leaves for weeks . . . a casual observer may often be plausibly led to a different conclusion."

We find Kirby and Spence given in the list of authorities who oppose this view of the origin of honey-dew.

Kirby and Spence state that "the sexual intercourse of one original pair (of *aphides*) serves for all the generations which proceed from the female for a whole succeeding year." I think that we have here the source of the idea that *aphides* are hatched from fertilised parthenogenetic non-existent eggs.

In Bulletin No. 1 (New Series), on "Foul Brood in Bees and its Treatment," issued by the New Zealand Department of Agriculture, we find the following sentence: "The experience of bee-keepers in New Zealand and elsewhere, in curing thousands of cases without disinfectants, goes to show that recombining is the most simple and effective method that the bee-keeper can adopt." That is the McEvoy system, and any system, however admirable, which necessitates the use of disinfectants is not the McEvoy system. The Bulletin was issued in August, 1910, so it is thoroughly up-to-date.

Salt has often been suggested as a remedy for bee-stings. Butler gives salt and vinegar; Nutt (1832-1848, seven editions), gives salt; modern writers, salt and water. Mr. Macdonald recently mentioned salt as a novel (!) remedy. A little knowledge may be a dangerous thing, but reading that is forgotten is not very safe either.

The author of "Forty years ago among Bees," notwithstanding his vast store of

information, is willing to consider evidence for what he looks upon as a new statement. It is a great pity that our Northern friend's prejudices will not allow him to do the same.—G. W. BULLMORE, Albury, Herts.

#### DEALING WITH "ISLE OF WIGHT" DISEASE.

[8156] I shall be obliged if you will kindly insert this letter in the *BEE JOURNAL* at an early date, as my communication which appeared on page 165 of the "*B.B.J.*," not only caused great anxiety to readers, but I received so many letters that our village postal staff was quite alarmed until I told them it was only the result of a bee-note which appeared in the *BRITISH BEE JOURNAL*. I now want you to place before your readers the fact that I am not an educated person, and am, therefore, unable to reply to the personal enquiries. I am obliged to seek the aid of a friend in order to send a letter to the "*B.J.*" In answer to those who wish to know whether it would be safe to give combs of food from diseased hives to healthy bees, it is beyond my power to say at such a distance. I would recommend extracting the honey and syringing the combs, giving them to the bees after throwing out the water. I usually fumigate them with brimstone in order to destroy the wax-moth, should there be any. I do not agree with the theory of the disease being conveyed from one hive to another by the adult bees. Burning and burying has but little effect, if any. Follow the method given by me in 1907, on page 355, "*B.B.J.*," until a better one is discovered. T. STAPLETON Gwinear, Hayle, Cornwall.

## Queries and Replies.

[4126] *Bees Building in Candy-box.*—I gave my bees some candy this spring, and when fine weather came they built comb in the candy-boxes, and nearly half filled them with honey. I have not yet removed the boxes. What had I better do?—D. WILLIAMS.

REPLY.—Remove the candy-boxes at once, and put on supers.

[4127] *Preventing Brace-Combs.*—When looking through a stock of bees a friend of mine had bought the other day, I found several of the combs joined together by brace-combs right in the centre. What would be the best thing to do to stop the bees joining them up again? Is it possible to extract honey without an extractor? If so, how is it done? I enclose a cutting from the "*Bury Free Press*," dated April 29th,

1911. "A hive of bees belonging to Mr. John Brame, of Stonham Road, Stowupland, swarmed on a gooseberry bush on Saturday. Mr. Brame has kept bees for over 40 years and had never known of a hive swarming in April." What do you think of that for early swarming? It must have occurred about the 22nd inst.—J. S. W., Mildenhall.

REPLY.—Occasionally bees will brace combs together in this manner in bad seasons. If the frames are spaced the right distance apart there will be little trouble in this way. You can get the honey from the combs by breaking them up, putting them in an earthenware vessel which is placed in hot water until the honey and wax is melted. When cold the wax is removed from the top and the honey strained. By using this method all the advantage claimed for extracted honey—*i.e.*, being able to give back the combs to the bees to fill again—is lost.

The swarm referred to in the *Press* cutting would not be a natural one, but what is known as a "Hunger Swarm."

[4128] *Symptoms of "Isle of Wight" Disease.*—Will you be kind enough to give me a description of the signs of the "Isle of Wight" Disease? I have a stock which is ailing. The brood is fine and healthy-looking with pearly-white grubs; it also hatches out all right, but the trouble is with the adult bees. I noticed lots of them crawling about near the hive with tongues fully extended, wings disjointed and shaking all over. They do not go back to the hive. I put it down as dysentery or paralysis owing to unsuitable stores, so removed all stores and gave them syrup. They recovered slightly, but lately they are growing worse again. It might be the food, because I gave them a fully-stored and sealed comb a week ago. A reply in the "*B.B.J.*" will oblige,—DOUBTFUL, Cleator Moor.

REPLY.—The characteristic features of the disease are a more or less rapid mortality amongst the bees, disinclination to work, some distension of the abdomen, frequently dislocation of the wings, and, later, inability to fly. The disease can only be recognised by observing the general condition of the stock. It is a disease of the adult bees only, and the brood is not affected, except that owing to the dwindling of the stock the brood may become chilled from insufficient bees to cover it. The actual cause of death is uncertain, but is attributed to malnutrition, possibly combined with the absorption of a specific poison and of the products of decomposition in the colon. Foragers and robbers of infected hives are first attacked, and communicate the disease to other members of the hive. No

remedial measures are at present known, and diseased stocks should be destroyed to prevent the malady from spreading to healthy hives.

[4129] *Spring Management — Hive Making.*—Will you kindly answer the following questions through the columns of your "B.B.J."? (1) When is a convenient time for stopping syrup feeding? (2) also to commence inserting frames of brood foundations? and (3) when to start supering or putting on shallow frames? (4) I should like to know the dimensions for making a standard hive, holding ten frames. I see in one of your previous issues that you referred the reader to your purchase library. We novices do not expect detailed plans and elevations; a few measurements will suffice. Thanking you in anticipation.—E. H., Todmorden.

REPLY.—(1) As soon as the weather is properly settled, and there are plenty of flowers, or when the bees have sufficient stores in the hive. (2) When all the frames already in the hive are crowded with bees, and the weather is warm. (3) Supering may be commenced when all the ten frames are crowded with bees, and nectar is coming in freely. (4) All measurements are given in the Bee-Keepers' Note Book." It would be of no interest to the greater number of our readers were we continually reprinting these.

## Bee Shows to Come.

**June 26 to 30, at Norwich** (Royal Agricultural Society's Show).—Bee and Honey Section under the management of the B.B.K.A. Prizes arranged in groups of counties for Associations affiliated to the B.B.K.A. Schedules from W. Herrod, Secretary, B.B.K.A., 23, Bedford Street, Strand, London, W.C. **Entries close May 31.**  
**August 23, at Radstock, Somerset.**—Honey Show in connection with the Radstock Horticultural and Farmers' Association. Open and gift classes. Write for Honey Schedule. B. M. Clark, Foxhills, Radstock.

### TRADE CATALOGUES RECEIVED.

**MESSRS ABBOTT Bros.** (Southall, London).—This old-established and well-known firm issue a catalogue which is an improvement on any before sent out. The latest reductions in prices of various goods are set out in a special leaf inserted at the front. There are also goods catalogued which are not found in the list of any other dealers. It is sent post free on application, and is well worth the perusal of bee-keepers.

**FREDERICK VOGT** (38, Clementina Road, Leyton, Essex).—This is a handy little leaflet dealing with foreign bees, as well as natives. It contains testimonials showing that Mr. Vogt tries to meet the wishes of his customers in every way.

### WEATHER REPORT

WESTBOURNE, SUSSEX.

April, 1911.

Rainfall, 1.49 in.	} Minimum temperature, 27° on 6th and 8th.
Below average, .31 in.	
Heaviest fall, .31 in., 1st and 26th.	} Minimum on grass, 22° on 6th and 8th.
Rain fell on 13 days.	
Sunshine, 173.7 hours.	} Frosty nights, 9.
Below average, 5.8 hours.	
Brightest day, 24th, 12.6 hours.	} Mean Maximum 51.2.
Sunless days, 2.	
Maximum temperature, 59° on 15th and 24th.	} Minimum Minimum 38.1.
	} Mean temperature, 44.6.
	} Below average, 1.6.
	} Maximum barometer, 30.427 on 21st.
	} Minimum barometer, 29.400 on 29th.
	L. B. BIRKETT.

## Notices to Correspondents

*Letters or queries asking for addresses of manufacturers or correspondents, or where appliances can be purchased, or replies giving such information, can only be inserted as advertisements. The space devoted to letters, queries, and replies is meant for the general good of bee-keepers, and not for advertisements. We wish our correspondents to bear in mind that, as it is necessary for us to go to press in advance of the date of issue, queries cannot always be replied to in the issue immediately following the receipt of their communications.*

**J. H. W. (Mold).**—*Wild Bees.*—The solitary bees are males and females of *Andrena fulva*, one of the prettiest and also one of the commonest of the spring wild bees. This species often makes its burrows in lawns.—(F. W. L. S.)

**W. A. C. (Castle Cary).**—*Artificial Increase.* (1) Yes, you could work in that way. (2) You must not brush bees off the combs, or you will make that stock too weak.

**L. C. T. (Edenbridge).**—*Insect Nomenclature.*—The insect sent is neither bee nor wasp, but a kind of saw-fly belonging to the genus *Trichiosoma*. The larva of this is a caterpillar, which feeds on the leaves of certain trees. The insect is common in spring.—(F.W.L.S.)

### Suspected Disease.

**B. B. (Ashford).**—The bees have "Isle of Wight" disease. Destroy everything inside the hive by burning, and scorch the hive interior with a painter's blow-lamp.

**PLUNA (Ruislip).**—Bees sent were too dry to diagnose cause of death. It is quite possible that "Isle of Wight" disease is spread through robbing.

**E. S. C. (Leicester).**—The bees are badly constipated, and there are also symptoms of "Isle of Wight" disease. You had best destroy the stock.

**Special Prepaid Advertisements**

**Two Words One Penny, minimum Sixpence.**  
Orders for three or more consecutive insertions entitle advertisers to one insertion in "The Beekeepers' Record" free of charge.

Trade advertisements of Bees, Honey, Queens, and Bee goods are not admissible at above rate, but will be inserted at 1d. per word as "Business" Announcements, immediately under the Private Advertisements. Advertisements of Hive-manufacturers can only be inserted at a minimum charge of 3s. per  $\frac{1}{2}$  in., or 5s. per inch.

**PRIVATE ADVERTISEMENTS.**

**3 STRONG STOCKS ENGLISH BEES** (1910 Queens), guaranteed healthy, in new W.B.C. Hives, painted 3 coats, covers 20in. square, calico covered roofs, legs tarred, extra lift, 35s. each.—F. P. CHEESMAN, Sutton Valence, Kent. j 4

**1 ONLY, COTTAGE HIVE**, 8s.; 2 W.B.C. Hives, 15s. each, all complete, painted and unused; Meadows' Extractor, 13s.—MRS. PRITCHARD, Carterton, Oxon. j 20

**EXCHANGE** splendid white or black WYANDOTTES for Bees, Stocks, or Swarms, guaranteed healthy.—DYCHE, Flackwell Heath, Bucks. j 19

**4 STANDARD FRAME HIVES** and Cylinder Honey Extractor, good condition, price 40s., or exchange.—ELLERKER, Nawton, York. j 2

**TYPEWRITER**, Williams, visible writer, cost £22, splendid condition, 60s., bargain.—WAKEFIELD, Newhall Hill, Birmingham. j 3

**STRONG, HEALTHY STOCK**, 10 Frames Hybrid Blacks, young Queen, 18s. carriage forward; travelling box must be returned.—PHILIP JONES, Blakeney, Glos. j 5

**FOR SALE, COUNTRY BUNGALOW**, brick, large garden, well stocked with trees, small Apiary, good bee district, owner going abroad.—B., "B.B.J." Office, 25 Bedford-street, Strand. j 8

**GOOD HEALTHY STRONG STOCKS**, 32s., guaranteed; 5s. extra on box, returnable.—J. PHILLIPS, 23 Albert-street, Stevenage, Herts. j 9

**TAYLOR'S No. 3 HIVE**, never used, painted 3 coats, 10 Frames, wired foundation, Sections also full sheets, exchange Stock on Frames, or good early Swarm.—GORNALL, Thornycroft, Oxted. j 10

**W.B.C. HIVE**, with exceedingly strong Stock English Bees, will swarm early. Spare hive, sundries, equal new, the lot, cheap.—DART, West Horsham. j 12

**2 STANDARD BAR-FRAME BEE-HIVES**, almost new, fittings complete, 23s.; 100 new Standard Frames, made up, 7s. 6d.; 4 doz. new zinc Excluders, 18s. large size; satisfaction guaranteed.—BODE, 195 Plymouth Grove, Manchester. j 14

**BEE and POULTRY FARM**, Honey, Appliances and Day-old Chick Business, six-roomed house, grain shed, stable, coach-house, incubator house, workshop and sheds, large well stocked garden, two acres wired, miles of heather, low rent, stocks of bees, incubators and appliances to be taken over; within 10 miles of Bournemouth.—Stamp for particulars to C., 25 Bedford-street, Strand. j 16

**8-ROOMED COTTAGE TO LET**, £6, or would sell cheap, garden, good bee district Suffolk, healthy district.—SANDYS, Drayton, Berks. j 17

**SWARMS** from Bar-framed Hives, guaranteed healthy, May, 15s.; June, 13s.; Stocks, 30s.—J. REAVELY, Starbeck, Harrogate. j 18

**HIVES FOR SALE**: 1 Conqueror, 1 W.B.C., double walls.—HARDY, Aldbrough, Hull. j 19

**WANTED**, a few Colonies of healthy BEES on frames; boxes for travelling will be sent.—T. LEWINGDON, The Club, Wokingham. h 91

**Special Prepaid Advertisements.—Continued**

**BEES FOR SALE**, 3 strong, healthy Stocks, 1910 queens.—Apply, P. HEATH, Thremhall Priory Cottages, Bishop's Stortford, Herts. h 77

**REMOVAL SALE**.—13 Burt's W.B.C. Hives, new, 3 coats white lead paint, calico covered roofs, 23s. each (includes legs, &c., 10 brood frames and ends, 2 shallow boxes, 8 frames each, wide ends, all full sheets, weed foundation wired); 12 Nucleus Hives, with 8 frames and ends, used one season, 3s. 6d. each. Following 2-year-old hives repainted: 6 Garner's Sleaford, 11 frames and ends, 2 lifts with 9 shallow frames, wide ends, all full sheets, wired foundation, 13s. 6d. each; 3 Garner's Cottage, 11 frames and ends, 5s. 3d. each; 4 Lee's Alliance, 10 frames and ends, 6s. 3d. each; all on rail; 9lbs. Weed foundation, thin brood, 18s., post free; 4½ ditto, 9s. 3d.—REV. W. E. MATTINSON, Happisburgh, Norwich. h 76

**BUSINESS ADVERTISEMENTS.**

**WANTED, EXPERIENCED MAN** in Apiary, must understand Queen rearing, increase, etc.; only capable man need apply.—CHARTER, Tattingstone, Ipswich. j 23

**LAST SEASON** we dispatched over 100 Swarms. Am booking orders for after June 7th, 2/6, guaranteed; cash with orders given preference.—SOUTHCOTT, Gittisham, Honiton. j 1

**60 NATURAL SWARMS**, guaranteed healthy, May, 3s.; June 2s. 6d. lb.; packages free.—MASON, expert, Moorend, Stony Stratford. j 6

**PRIME NATURAL SWARMS** already arriving. Send at once, 15s. 6d., boxes 6d.; June, 12s. 6d.—HIGGINSON, Egerton, Kent. j 7

**QUEENS**, 3s. 6d.; Strong Stocks, £1; 3 Frame nuclei, 7s. 6d.; Swarms, May, 12s. 6d.—WILSON, Burry-rd, St. Leonards. j 11

**GOOD ENGLISH HONEY**, medium colour, 28lb. tins, 17s.; sample, 2d.—W. H. STOPPARD, Tiptree, Essex. j 13

**SWARMS** (surplus), sale on issuing; Pupil-assistant wanted.—BUGDEN, Wye, Kent. j 15

**SWARMS NOW READY**, 14s. 6d.; send 1s. 2d. sample new Straw B Skeps.—H. SEAMARK, Willingham, Cambs. h 100

**GUARANTEED HEALTHY SWARMS**, 3s. lb., cash with order.—WATSON, Pine View, Mildenhall. j 21

**STRONG HEALTHY STOCK** (1910) in Skep, soon swarm, 18s. each.—WATSON Pine View, Mildenhall. j 22

**35TH YEAR**.—Nuclei, 3 frames, 12s. 6d.; 4, 14s.; 8, 20s.; all wired, healthy; empties returned paid.—ALSFORD, expert, Haydon, Sherborne. j 24

**THE PREPARATION OF HONEY AND WAX** for Show Bench, 7d.—TINSLEY, Stone, Staffs. j 24

**1910 QUEENS**, natives, 5s.; golden, 7s. each; healthy.—O'KNIGHT, Epney, Stonehouse. h 59

**SWARMS**.—Guaranteed healthy, May 15s., June 13s.; boxes returnable.—ADAMS, Farnham, Blandford. h 68

**1911 VIRGINS**, Blacks, Carniolans, Italians, 1s. 6d.; Americans (Golden), Cyprians, 2s.; Swiss, 2s. 3d. Send for price list. Cash with order.—FREDERICK VOGT, 38 Clementina-road Leyton. h 70

**GOLDEN PURE CYPRIAN** fertile Queens, gentle strain, five yellow banded, 6s. each, post free.—Write to DERVISHIAN BROS., Nicosia, Cyprus. h 71



## Editorial, Notices, &c.

### PROMINENT BEE-KEEPERS.

M. ALPHONSE WATHELET

We have much pleasure in presenting to our readers the portrait of M. A. Wathelet, a prominent Belgian bee-keeper, and the genial and able editor of the *Rucher Belge*.

M. Wathelet was born at Louveigné, in the province of Liège, on 27th December, 1855, and is therefore 56 years of age. Destined for the teaching profession, he completed his studies at the normal school

the instructions. These were the first two books on modern bee-keeping which he was able to study, and which were the means of making him a bee-keeper. M. Wathelet still possesses his first Cowan hive, which with a Dadant-Blatt, accompanied him to more than a hundred places in six provinces where he gave lectures during the years 1890 to 1895, for the purpose of making known modern methods of bee-keeping. The cost of these lectures was defrayed by the Government, and they have been the means of greatly extending and popularising bee-keeping in Belgium. For the last 22 years, M. Wathelet has ably conducted and edited



MONSIEUR A. WATHELET.

of St. Roche. Although his parents had always kept bees, and he was more or less familiar with skep bee-keeping, it was not until 1886 that he became acquainted with modern methods, when he saw the first two hives with moveable combs, and by a curious coincidence both these happened to be English hives, one a Cowan hive, and the other, one of Blow's. It was quite a revelation to him, and he was induced to obtain Bertrand's "Conduite du Rucher," and the "British Bee-keeper's Guide Book," and carefully carried out

the *Rucher Belge*, a journal which belongs to the Société d'Apiculture du Bassin de la Meuse, of which he was one of the five founders. To this journal he has devoted all the spare moments which other occupations have allowed, for he is a busy man, and has for the last 35 years directed a school of 170 pupils. M. Wathelet is the happy father of eight children, six of whom are still at home with their father and mother. Bee-keeping employs much of his time as he has an apiary of sixty colonies. These are

transported every year to more favourable pasturage than obtains in the industrial commune of Prayon, Trooz, in which he lives. He is also the secretary of the Bee-keeper's Society, and has to do all the correspondence in connection with its business. M. Wathelet is able to do all this because he enjoys excellent health, knows how to work, and experiences nothing but satisfaction and encouragement from his family. He has learned English, German, Italian and Spanish, sufficiently well to enable him to translate what he reads in the journals of these different languages. The reviews appearing in the *Rucher Belge* bear testimony as to his proficiency in these languages. He has visited many of the large apiaries in France, Germany, Switzerland and Italy, and he will receive a welcome when he visits this country again as a bee-keeper. M. Wathelet has done much to advance bee-keeping in Belgium and we hope he may enjoy many more years of good health and continue his good work in connection with bee-keeping and editing the *Rucher Belge*.

## THE "ROYAL" SHOW AT NORWICH.

### DATE FOR CLOSING ENTRIES.

We should like to remind intending exhibitors at the above show that the date for closing entries is Wednesday, 31st May, and therefore no time should be lost in applying for schedules. Provision will be made as usual for the return of entry fees in cases where adverse weather prevents honey of the current year being staged. We trust that bee-keepers will make an effort and, by entering and staging exhibits, assist in making the "Coronation," Royal Show worthy of its name. No doubt many Colonial and foreign visitors will take the opportunity of seeing the exhibition of one of the most world-renowned Agricultural Societies, and we trust that the honey department will do credit to British bee-keepers, and show them that the "Old Country" can hold its own in honey production in spite of the many drawbacks with which the industry has to contend at the present time. The appliance manufacturers as a rule make a very creditable appearance at the "Royal," and we hope that the honey producers will this year emulate their good example, and all who have, or expect to have, honey in June, will make an entry without delay.

## AMONG THE BEES.

### THE PRESCIENCE OF THE BEE.

By D. M. Macdonald, Banff.

This in my opinion is a thing apart from, and on a higher plane than, the wisdom

of the bee, or the mere instinct which guides it to do right and to keep it from what is wrong. Foresight and forethought have been given to the bee in lavish measure. By this gift bees gather not only rich stores of nectar which are an utter necessity for carrying them through the long winter, but it also teaches them to store up a supply of "bee bread" for consumption in early spring, in order that young bees can be reared before natural pollen sources can be tapped. Not only so, but their prescient knowledge teaches them that they must store it in such a way that long keeping will not deteriorate it. Hence they fill the cells only half or three quarters full, and above this place a layer of honey to preserve the pollen fresh as if new gathered when they tap it in spring. Study the almost prophetic preparations made for superseding the mother bee when some wise instinct teaches them that she is failing in her powers of ovipositing. They start by an act almost creative in its marvellous powers of adapting means to an end, and, giving no rein to chance, they guide and direct all future developments until complete success crowns their efforts. One, two, or three cells even might fail, so they more than double that number. A few drones might fail at the critical moment, so, although one is sufficient, they produce several hundreds. As the season wanes, if they have a fertile queen they callously evict these hitherto indispensable, presciently aware that they are useless encumbrances. But let the mother-bee fail to meet the father of the hive, and then they will feed and pamper these males, and preserve them even to another season.

*Good Honey.*—I lately came across the following description of Sicilian honey: "It is the best honey in the world. It is the most perfect in taste, and its perfume is exquisite. No other honey is more savoury, more richly coloured, more unctuous to the tongue. It is so thick that, by dipping the finger in it, it will form a thread of honey reaching to the ground without breaking." This is the test amongst the Arabs as to whether honey is fully ripe, but, indeed, it is a very old test as to the highest quality of honey, as is shown by the following description of prize-taking nectar: "Good honey is clear, odoriferous, yellow like pale gold, sharp, sweet, and pleasant to the taste, of a mean consistency between thick and thin, but so clammy that, being taken up with the finger end, in falling it will not part, but hang together like a long string, as that does which is clarified." Virgil wrote of "Combs of golden juice," but he favoured that which was pure and clear; Pliny had a

preference for honey with a slight tint of yellow, "gathered in the dog-day," i.e., when it was most certain to be well bodied and consistent. Even so early as the days of Aristotle it was noted that the best honey in the extracted form lay at the bottom of the receptacle. Butler, about 1,600, describes "right virgin honey," and Rusden in Charles II.'s time copies his exact expression to inform us of the nature of the honey he sent to the King's table from the Royal Apiary. Fortunately for us all honey now sent out in the comb is "right virgin hooni," and as pure as honey can be.

*Cleaning Propolis.*—Frequently this substance proves so adhesive that it is most difficult to clear it off the fingers as well as from dividers and other articles with which it comes in contact. I retained some notes giving recipes for clearing it off, but they are a little mixed, so that I am unable to give their source. "A few drops of gasoline will remove propolis from the hands. Kerosene is about as good as it clears it off almost instantly." "Lava soap is one of the best articles that could be used for removing propolis from the fingers; our employees are very partial to it for removing it." "I lathered and soaped my fingers, but the more I worked the more it seemed to stick. I then went to the benzine-can rubbed my hands with the liquid and had the satisfaction of seeing the propolis roll off quickly." "I boiled my tins and tin dividers in water to which I added concentrated lye, and the propolis disappeared as if by magic. Washing fluid might take the place of the lye. The tins came out as clean as new." I think all the foregoing have an American savour about them, so has the following one: "The propolis is scraped from the supers by means of a hatchet"! With wood and tin it depends considerably on the temperature how the propolis adheres. The A.B.C. advises to dip the fingers in vaseline as a preventive of propolis adhering at all. Alcohol is mentioned by the same authority as the best article to use for removing propolis from the fingers.

*United Action.*—At this critical juncture in the history of apiculture in Great Britain this is the great desideratum. Empty platitudes are worthless, wild guessing as to cause is vain, and a waste of printers' ink. Action is what is urgently required, and to be effective it must be united. I would suggest that every bee-keeper in the United Kingdom should write the M.P. for his division, and urge that pressure should be brought to bear on our hitherto supine Department of Apiculture urging it to act, and act promptly, in order that our craft may be saved from extinction. I have been in correspondence with several who would be

prepared to act if they knew how it would be best to go about the business. It is not apiculture alone that will suffer, but every farmer, seed-grower and fruit-grower will inevitably feel the effect prejudicially if *Apis mellifica* continues to be wiped out at the rate which has lately prevailed in almost every corner of our island. The B.B.K.A. is the body which should give the lead I have craved for above, and I would further make a most urgent appeal to those opposed to legislation to sink private opinions and fall into the ranks in order that we may act, unitedly. United we stand; divided we fall!

---

## Correspondence.

*The Editors do not hold themselves responsible for the opinions expressed by correspondents. No notice will be taken of anonymous communications, and correspondents are requested to write on one side of the paper only and give their real names and addresses, not necessarily for publication, but as a guarantee of good faith. Illustrations should be drawn on separate pieces of paper. We do not undertake to return rejected communications.*

---

### BEE-KEEPERS AND BEE-DISEASE.

[8157] As a bee-keeper of only one season's experience, I have naturally spent a great deal of time in wonderment at the extraordinary qualities possessed by the honey-bee. I think, however, that the extraordinary qualities possessed by the average bee-keeper have made an even deeper impression on my mind, and among these my attention has been chiefly rivetted on the extremely dogmatic opinions held by the majority of bee-men, and to the great reluctance shown by them to accept the convictions of each other.

This is especially noticeable in discussions relating to disease questions, and to legislation regarding same. Surely there is common ground for compromise, and if I may trespass on your space, I would like to put forward a suggestion which, though lacking the stamp of originality, may yet not be beneath the consideration and criticism of bee-keepers.

I suggest that the "B.B.K.A." approach the Board of Agriculture and ask for their co-operation and official sanction for the appointment of *advisory* experts whose duties would be to visit all bee-keepers within their district, and offer them advice and help gratis.

Space will not permit me to point out how far reaching and beneficial this system might become, but I think it will be obvious to all experienced in the craft. Tact, I am afraid, would be a necessary qualification of the expert, who if invested

with no powers at all would I am sure be allowed to open many a hive and help disinfect many a derelict, which could only be accomplished under other circumstances by the declaration of civil war.

As usual the question of £ s. d. would probably be the stumbling block, but with the fruit growers pressing on one side and the "B.B.K.A." pulling on the other, the Board of Agriculture might perchance open its purse.—E. G. TREMLETT, Harrow.

#### OBSERVATORY HIVES.

[8158] The mention of the most recent thing in the way of observatory hives, the "Nicholson," spoken of in the "B.B.J." for May 11th, reminds me that only a few days ago, while looking up a very different matter in Pepys' immortal "Diary," I came upon the following interesting entry, under date of 5th May, 1665. "After dinner to Mr. Evelyn's; he being abroad, we walked in his garden, and a lovely noble ground he hath indeed. And among other rarities, a hive of bees, so as being hived in glass, you may see the bees making their honey and combs mighty pleasantly." Now, can any of your readers tell us of an earlier mention than this, of observatory hives?—F. DE SILVA, Bath.

#### HIVE FLOORS.

##### WITH ENTRANCE SET BACK.

[8159] I have experimented in various ways with a view of improving hive entrances, and consider the one shown in section sketch simply A.1. It is almost impossible for it to get choked in any way; it is easy for the bees to remove dead ones, and many bees seem to fly right into the entrance. It ventilates the hive, so that one seldom sees a bee fanning, and they never seem to cluster on the alighting board. The slope starts 4in. back from the front of floor, instead of in the usual manner at the edge of floor.

The sketch shows a section of hive through centre, and it will be seen that a triangular block about 4½in. wide and 1½in. thick, tapered off to "nothing" forms a continuation of the floor. The under or bevelled side is cut out to form an entrance 10in. long and 3-8in. or 7-16in. deep. The front or thick edge is "rebated," to form grooves for slides. Oak studs are inserted into the joists to keep the slides in position. Thus, the floor is complete in itself, separate and independent from outer cases. Like Mr. Woodley, I prefer an 11in. outer case, and room for not fewer than twelve frames. I also prefer to make the outer cases "weathered" just their own thickness,

with cleats or "fillets" nailed on inside, instead of the unscientific and unpractical outer plinths!

*Driven Bees.*—In early September 2½lb. lots, if fed daily for the first fourteen days, with about a pint of syrup, then for the next fourteen days fed every third day, will have several combs of brood in various stages, as well as young bees, and by the end of October be in a far better condition than a 5lb. lot at that date. That, anyway, is my experience. Of course, I use feeders that can be refilled without disturbance. The bees have a bee-way (over five or six frames) under the feeder, the latter having a sliding glass top. Not a tithe of the trouble with inverted jars, and bees never seem to start robbing.

*Painting Hives.*—It is not so much a question of mixing the paint or the skill of the painter. If it is real genuine

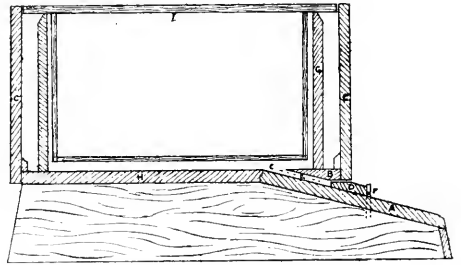

- A. Alighting board.
- B. Triangular block bevelled on under side to form E. with thick edge rebated to form groove for slides.
- C. Front and back of hive.
- D. Slide.
- E. Entrance formed by bevelled-edge of B. and alighting board.
- F. Stud inserted in joist to keep slides in position.
- G. Sides of brood-box.
- H. Floor of hive.
- I. Frame for brood foundation.

white lead, and well-seasoned, genuine cold drawn linseed oil, Patent Driers in proper proportion, and dry wood, the paint will neither rub off, nor crack and chip off. I have some hives painted fourteen years ago (they were several years old then) as sound now as when painted.—A. HARRIS, Wavendon, Bucks.

#### RAVAGES OF DISEASE.

[8160] Since I had the pleasant hour's chat with the editor, at the "B.J." office last November, things have become worse in this district in respect to the Isle of Wight disease. On a cursory jaunt round within a radius of two miles I find empty hives thrown into odd corners of cottagers' gardens, and results like the following:—

twenty stocks, in bar-framed hives, all dead; twelve, also in frame-hives, dead since Christmas. Of eight skeps belonging to a poor cottager only one late swarm was left alive. Five stocks all dead, three dead, seven dead, and so the tale runs on to another dozen lots. My own apiary, consisting of nine colonies, I had split into six, two and one, placing each division a mile apart. Of the six-lot division, two died in August, one in November, and one in December, or, rather, I destroyed the last mentioned. This stock had brood on two frames, so this looks as though bees were breeding right through this mild winter. The lot of one died off after giving surplus at the heather. Of the two-lot colonies both appear healthy. The two lots left from the six-lot division appeared at their best, until yesterday, when I found half-a-dozen bees with the usual symptoms, viz., unable to fly, and full of yellow fluid. I should think a low estimate of this district for ten miles around would be 80 per cent. dead, and if no remedy is found shortly I see no hope of any bees at all remaining at the end of a few months. This can hardly be taken as a very poor district last year, as where bees were properly handled they gave a small surplus, and have still sufficient stores of their own last year's gathering. I would suggest that instead of so many lectures during the coming season the different societies should make up a fund for an independent investigation to try and get to the root of the trouble, as at present it is not so much a question of making new bee-keepers, as the saving of present stocks that is required rather than increase that may be wiped out at any moment. The disease seems to take two forms, one in which the bees start to drop outside the hive in small clusters, and die off only in small numbers during several months, and the other without any signs outside, but bees suddenly found dead in the hive shortly after having been working strongly. Abundance of stores left in both cases!—W. D. O. KEY, Godalming.

#### SPRAYING CHARLOCK AND DISEASE.

[8161] I am writing to tell you my experience this spring. Nearly all the bees for miles round here have died of "Isle of Wight" disease. In this village I was the only one to escape. Last autumn I had three stocks and from two I extracted all honey, and fed up with medicated syrup as per "Guide Book" recipe, the third stock had two frames with a little honey left in, which were put on the outside of brood-chamber, so that syrup could be stored in the centre. A week ago

I examined them, and they had just about used up the syrup stores and were apparently in good condition, with plenty of sealed brood, young bees, &c. Yesterday (Easter Monday), I found they were not working, so I raised the roof, and was surprised to find they were all dead with one frame still full of honey, and the other partly so. I am now enclosing some of the bees, hoping you will be able to let me know through your valuable journal if my bees have at last got the disease. I see there has been a lot of correspondence in the *Journal* lately about this disease, and some think it is due to charlock spraying. Without venturing to give an opinion, I should like to say that I do not think that has had anything to do with the outbreak here, as I have made inquiries of all the farmers within a five-mile radius, and I find none of them sprayed any charlock last year. One farmer sprayed a field about seven miles from here, and had bees of his own within 200 yards, which are now strong and well. I for one should like to see a law passed to deal with bee disease. We have just had an experience in this district of a foot-and-mouth disease order of the Board of Agriculture which, although pressing very heavily on us who deal in live stock, is nevertheless very necessary for the good of the community, and the results have proved satisfactory as the outbreak was confined to the one case.—A. H. G. Hindhead.

[The bees had died from "Isle of Wight" disease.—Ed.]

#### AN EARLY SWARM.

[8162] A splendid swarm of bees came off a section hive at "The Mount," today.

Bees generally came through the winter well. I have heard of no losses in the parish. Supering has been general and they have taken every advantage of the recent fine weather and the exceptional fruit-blossom. Honey is being stored rapidly.—ELVEY E. SMITH, Southfleet, Kent.

#### MEDICATED SYRUP AND DISEASE.

[8163] I would like to express my opinion respecting the "Isle of Wight" disease.

As an experienced bee-keeper there is one thing that is constantly recommended in text books, but against which I have strongly set my face. I refer to the practice of feeding bees on "medicated syrup." Beta-Naphthol is a powerful poison. It is a bactericide of some power, but it seems decidedly absurd to

think that it (or in fact any other poisonous bactericide) can be given to live insects, such as bees, in the hope, let alone the assurance, that, after absorption, digestion and regurgitation, it will, while not strong enough in its original dosage to kill the bee which fed on it, be yet strong enough to kill the bacteria either in that bee's intestine or in the now converted sugar which is stored as honey. More than this is expected of it, for it is presumed that even in the now stored honey it will continue to retain its bactericidal properties and act as such in the interests of any brood which may at any subsequent time be fed on such honey.

We are certain that Beta-Naphthol as such is a poison.

We may be assured that bacteria (germs) are more difficult to kill than bees are.

What proof have we, or what reason have we to expect, that B.-Naphthol is a germ poison and not a bee poison in the doses recommended.

Does B.-Naphthol — as the sugar does — undergo any change in the bee's interior economy? If so, is the new product also a powerful bactericide? What proof have we that this is so?

I strongly advise bee-keepers against feeding bactericides of all kinds to their bees. I aver that even given a non-poisonous one, we are not able to arrive at such a dosage as shall destroy germs and at the same time be altogether harmless to the bees which must ingest the syrup in which it is fed to them.

The process is analogous to the use in our households of "disinfectant soaps." No disinfectant can be put into a soap of such strength as that in use it will act as a disinfectant. Let anyone think of the amount of soap used and the amount of water, think then of the degree of dilution in which the disinfectant must be. In both cases a false feeling of security accrues. This is bad.

I would put it forward now, that "I. of W." disease is due, or directly related to this custom. That in fact the disease is one of poisoning by B. Naphthol, either by cumulative effect or by over-dose. It is no argument against this suggestion to say that some have fed bees in this way for years. Such people can only claim to be more fortunate or more careful. This suggestion explains many of the features of the illness, viz., adult bees affected, stored honey not, as a rule "infective" (when it is said to be so, I take it an extreme dose has been administered, so also when "brood" is said to be infected).

I hope you will find space for this long note in view of the importance of the whole subject and the necessity for look-

ing into all sides of it.—(Dr.) T. DUNCAN NEWBIGGING.

[We do not share the views of our correspondent, for we have the proof in the experience of more than twenty-five years, which goes to show that Naphthol-Beta is not a bee-poison in the doses recommended, and that the danger alluded to does not exist. During that time, besides ourselves, thousands of bee-keepers have used medicated syrup regularly with the best results. Our bees have been perfectly healthy all the time, so that there are no grounds for supposing that medicated syrup is responsible for "Isle of Wight" disease. Had it been a cumulative poison it would surely have manifested itself long before this. Dr. Lortet, who introduced Naphthol Beta, was not only a bacteriologist of repute, but also an advanced bee-keeper, and carried out exhaustive experiments which showed its value. A drug which is not only harmless but beneficial to human beings in doses of 10 grains can hardly cause such mortality in the small doses in which it is administered in bee food. We have moreover, the evidence that many colonies have been lost which have not been fed at all, so that such cases tend to show that the medicated food has nothing to do with the disease. We, however, hope that those who are investigating this disease will give attention to this point and clear up any doubt that may exist.—Ed.]

#### BEE-HIVES AS INCUBATORS.

[8164] I intend "having a shot" at incubating with one of my hives.

I wonder if any of your readers can give a few hints, gathered from actual experience?—K. C. PAYNE, Erdington.

#### CAPPINGS OF COMB.

BY L. S. CRAWSHAW, NORTON, MALTON, YORKS.

*Parthenogenesis in Greenfly* (page 115).—Mr. Desmond's reason for declining discussion is indeed an ignominious ending, and matter for the greatest concern and regret. For it can only mean that the few years yet remaining to him are insufficiently long to formulate effective reply to criticism of his own controversial statement. But really there is no discussion as to the manner of aphidian reproduction, nor can there be unless Mr. Desmond can produce evidence. Otherwise we are obliged, as we have done, to fall back upon the text books. In self justification, however, I would point out that Mr. Desmond rushed in as champion with an assertion in support of D.M.M.'s presumably unguarded wording, and when dealt with, as a new aggressor in the field, he turns and cries, Spare my life!

We must perforce do so as he has laid down his sword, but it is an ignominious ending to a brave crusade. His suggestions as to various definite queries re the "Isle of Wight" disease are valuable, and will I hope be adopted.

*B.B.K. A. Conversazione* (page 116).—As one of those who saw the bioscope pictures, I should like to express appreciation, and a hope that Mr. Mason will be rewarded for his enterprise by many provincial engagements. There is no doubt as to the genuineness of the various operations, as must be apparent to anyone who has removed bees from similar situations. Indeed some of the operators instinctive movements when hard pressed were so natural as to call forth ripples of sympathy (!) from his expert audience. I must admit that I questioned the sex of the caged queen, as her movements seemed unnatural, and her eyes dronelike. Mr. Mason has, however, written me in explanation, and he states that the queen was caged by Mr. Simmins, who should know a queen when he sees one.

*Isle of Wight Disease and Yorkshire* (page 123).—Many bee-keepers in this county would be glad to know upon what data and authority this great area has been blackened as diseased. So far I have been quite unable to discover cases, and others have written me to a like effect. The greatest injustice may easily be done to innocent bee-keepers by the wholesale proclamation of such areas, and we may well demand to know how many cases have been recorded. I am writing to Dr. Malden on the subject.

*Winter Brood Nest* (page 129).—If one must re-arrange the hive interior after autumn feeding, which to my mind is an operation of doubtful value, would not the simplest and most satisfactory method of giving room below the sealed combs, be to raise the brood-nest upon an eke, W.B.C. fashion. Or, where shallow combs are available in good time, and driven bees are only obtainable late in the season, would not a sealed set of these, placed over an empty set, provide the ideal arrangement. Numbers of bee-keepers have no doubt tried this arrangement, and could let us know the objections to it. I myself have tried it upon a limited scale, with entire satisfaction.

*A Brindle Bull Terrier* (advt.)—For a number of weeks some bee-keeper has desired to possess a dog of this kind. Has the specified colour anything to do with immunity from stings, or what is the reason? But does the type exist? I do not remember to have seen specimens in England, although as I write, here in Monaco, there is a beast outside my window, which answers somewhat to the description, with a brindle trunk and a

bay bark. If "W." is otherwise unable to obtain what he wants, and will wire me I will see what can be done, although upon arrival in England, he will be treated very much as if he had "Isle of Wight" disease. So I would suggest to the advertiser, that he be content with one of the usual colour, unless he has very special reasons to the contrary.

## BEE DISEASE IN UTAH.

The following extract from "*Gleanings*" of July, 1904, shows that a mysterious disease caused great losses of bees in the State of Utah in the years 1903-4. It is interesting to compare the description of its ravages, with the accounts published in the "B.B.J." of the present outbreak of the so-called "Isle of Wight" disease.—

"I have received the following communication from a friend in Utah, which speaks for itself. Is this a new and strange bee-disease, or is it a very malignant type of paralysis? Possibly some purely local cause is responsible for the great mortality among the bees of that locality. Who can give us some light?"

"There seems to be great danger in Utah of a total loss of the entire bee industry. I shall give you, as nearly as I can, the conditions, both in the past and at the present time.

"In this valley and in the one fifty miles north of here, called Cache Valley, there have been for many years a great many bees, both in the hands of skilled operators and in the hands of many farmers and small owners. A year ago this spring there were upward of 2000 colonies of bees lost. It was thought a year ago that it was owing to the very cold, winter weather and changeable weather in the spring; but the strange part of it is that in some localities not any warmer, but, if anything, colder, the bees survived all right, with scarcely any loss at all.

"I lost last year 300 colonies of bees, and in some localities in Cache Valley there were upward of 500 colonies that went under; and in this valley (Salt Lake) last year there were fully 800 colonies that perished. It was thought by all those who were interested that it was due to the hard winter and cold spring, and was let go at that; but in Cache Valley a gentleman by the name of Bullock, who has been in the business at least fifteen years and had 500 colonies of bees, came through with his last year with not more than 10 per cent. loss. He took excellent care of them last winter earlier than usual; but he now has but 10 per cent. of his bees alive. Since I heard this I made a visit to where I had my bee-grounds, and will say in explanation, after loss.

of my entire number last year, that I went into Melal Valley, where there had been no loss at any time, and is none at the present time, and purchased 225 colonies of very strong bees, and had them moved into Cache Valley, where I had the loss last year, and expected that I would accomplish a great deal with them; but when I heard of Mr. Bullock's loss in that locality. I at once made an investigation. I was there yesterday, and a large part of the entire 225 colonies are affected with what appears to be paralysis. While there is no trembling, they drop down in the grass in front of the hives, and are unable to fly; they seem to mount the grass and twigs with great difficulty, and in taking them up in my hands they were unable to fly away, and, if thrown into the air, would drop to the ground. They seemed to have no desire even to sting. It appears to be contagious, for it seems to affect a certain part of a row, while another section of the row seems to be strong and swarming. A number of hives have all gone under. The entire yard, of course, is exposed, for the reason that a few, perhaps twenty colonies, from what were left of the lot last year were put with them without any thought of anything being wrong, except that they were weak.

"I am fully satisfied now that the loss last year, which would number at least 2000 colonies in Cache Valley, was due entirely to this condition. I am now anxious for some remedy to overcome this difficulty, and shall appreciate very much instructions and information which will enable me to overcome it.

"I have advised my partner in the business to sprinkle powdered sulphur in the hives at night. He has been using salt and water, but that does not seem to have very much effect.—B. P. CRITCHLOW, Ogden, Utah, 1904."

## Queries and Replies.

[4130] *Spraying Fruit-Trees*.—I shall be glad to know if your reply to Optimist, Somerset (page 179), re spraying with arsenatis, applies to loganberries?

I have heard that it is the intention of a fruit-grower here to spray raspberries and logans with arsenate of lead and treacle during the time they are in bloom. This is to kill the raspberry beetle which enters the open bloom.

Will not spraying be as efficacious if done after the fall of the blossom? but logans are in bloom for weeks.—ENQUIRER, Essex.

REPLY.—No fruit trees should be sprayed while the blossoms are open. Arsenate of lead and treacle would certainly be destructive to bees. There is however no necessity to use treacle at all, as soft soap enters equally as well and would not entice the bees like a sweet substance would. Spraying open bloom is not only bad for bees but also injures the pollen, and consequently affects the production of fruit.

[4131] *Uncapped Larva*.—If you will kindly answer me the following through the journal, I shall be glad. In looking through a hive previous to purchase I saw two (only) open cells in a good-sized patch of brood. The larva was alive, nicely curled up, and a good colour, but judging by their size should have been capped over. Is this a symptom of F.B.? or what is the cause. I may add there has been no disinfectant in the hive, but plenty of natural stores.—I. JONES, North Wales.

REPLY.—You will frequently find this happen, it is only natural. The larvæ are younger than those surrounding them which are capped over.

### TRADE CATALOGUE RECEIVED.

MESSRS. JONES BROS., (*Monks Acre Apiary, Andover*), have sent a very neatly got-up catalogue. There are several original ideas, the whole being well and clearly illustrated—specialities, honey tins, and the Dreadnought extractor. It is sent post free to applicants and well worth applying for.

### WEATHER REPORT.

BARNWOOD. GLOUCESTER.

April, 1911.

Rainfall, 1.01 in.	Coldest night, 11th, 23.5.
Below average, .66 in.	Mean temperature for month, 45.8; 3.7 of a degree below average.
Heaviest fall, .21 in. on 28th.	Relative humidity, or percentage of moisture in the air at 9 a.m. 74.
Total to date, 5.4 in., as compared with 8.7 in. for the corresponding period of last year.	Number of days with sky completely overcast at 9 a.m. 12; do. cloudless, 2.
Mean maximum temperature, 53.4; 3.6 of a degree below the average.	Percentage of cloud 65.
Mean minimum temperature, 38.2; 3.8 deg. below the average.	Percentage of wind force, 33.
Warmest day, 14th, 63.7.	Prevailing direction, N.E. and S.W.

F. H. Fowler (F. R. Met. Soc.).



## Bee Shows to Come.

**June 26 to 30, at Norwich** (Royal Agricultural Society's Show).—Bee and Honey Section under the management of the B.B.K.A. Prizes arranged in groups of counties for Associations affiliated to the B.B.K.A. Schedules from W. Herrod, Secretary, B.B.K.A., 25, Bedford Street, Strand, London, W.C. **Entries close May 31.**

**July 13 and 14, at Brigg, Lincs.**—Lincolnshire B.K.A. Great Show of Honey, Hives, and Appliances, at the Brigg Exhibition of the Lincolnshire Agricultural Society. Valuable prizes offered in Open Classes for Trophy, Extracted, Granulated, and Comb Honey, Observatory Hives, Bee Appliances and Hives. Schedules, &c., from Mr. J. H. Hadfield, Alford, Lincs. **Entries close June 9.**

**August 3, at Weston-super-Mare.**—Annual Show of the Somerset B.K.A., in connection with the important Local Annual Flower Show. Classes for Appliances, Honey, Wax, and Bee Products. Several open and free classes. Liberal prizes. Numerous attractions. Excursions from all parts. For Schedule, &c., apply to T. Jones, Assistant Show Secretary, North View, Milton-road, Weston-super-Mare. **Entries close July 29.**

**August 23, at Radstock, Somerset.**—Honey Show in connection with the Radstock Horticultural and Farmers' Association. Open and gift classes. Write for Honey Schedule. B. M. Clark, Foxhills, Radstock.

## Notices to Correspondents

J. H. (Rugby).—*Wild Bees.*—The bee is *Andrena nigroaenea*, one of the common solitary bees. The burrows noticed have been made by the females for their young. These bees are quite harmless, they will not spoil your lawn, and no more burrows will be made until next spring. (F.W.L.S.).

NOVICE (Eccles).—*Inexpensive Extractor.*—You might use a "Little Wonder" Extractor, which costs about 7s. 6d., and can be obtained from any dealer in bee-appliances. Honey should remain in the ripener about twenty-four hours.

N. M. R. (Windermere).—*Time for Queen-cells.*—It was too early to expect queen-cells, when you made the examination, especially so far north as you are located. The death-rate is only normal.

W. L. W. (Ilford).—*Average Life of Worker-Bee.*—The duration of life of a worker in summer is from six to eight weeks.

R. J. B. (Twickenham).—*Preventing Incubation.*—If you kill the queen as you propose, you will in all probability spoil your honey harvest. It is a much better plan to give room in advance of requirements. Also ventilate well, and if the bees send off a swarm return it to the hive. 2. Supers should only go on when the bees are crowded in brood-chambers, and require more room.

S. H. W. (Felsted).—*Checking Swarming.*—The operation is carried out straight away on the same day that swarm issues. Put the new hive in the same position as old one, placing the excluder and

supers in position before hiving the swarm.

A. B. C. (Salisbury).—*Queen Found Dead.*—The queen is an old one, and the wings are badly torn. Also from each of the right-side legs the foot is missing. The bees have evidently superseded her on this account.

H. A. B. (Rhayader). *Bees Balling Queen.*—The queen appears to be quite normal; it is evidently a case of "balling" through manipulation, which sometimes happens in early spring.

J. W. (Pwllheli).—*Insurance.*—Apply for a form to the Secretary of the B.B.K.A. 23, Bedford Street, W.C., who will also furnish you with the particulars as to joining the Association.

### Honey Samples.

K. C. PAYNE (Birmingham).—The honey is almost as thin as water, being quite unripe. We should say it has been obtained chiefly from the Sycamore.

W. G. A. (Elgin).—Sample is principally from heather, but there is a slight admixture of honey from other sources. We consider it a very good table honey.

G. H. (Bisley).—1. The white colour of your sample is due to granulation. It has of course not become so hard as English honey usually does. 2. Not being acquainted with the flora of Jamaica we cannot say. 3. It is not adulterated so far as we can judge, but appears to be a typical sample of the honey of the country.

### Suspected Disease.

R. E. C. (Tewkesbury).—The comb shows that the stock is suffering from foul brood. It should either be destroyed, or if you are not afraid of the risk of infecting other healthy stocks, treat it as recommended in "Guide-book," on the starvation plan.

G. C. (Great Missenden), and T. B. (Mitcham).—We regret to say that the bees have "Isle of Wight" disease, and should advise your destroying them at once.

B. R. G. (Norton-on-Tees).—The bees are suffering from constipation. They are all one kind, the smaller ones have been reared in old cells, hence their size.

HILBRE (Essex). No. 1 is black brood, and No. 2 odourless foul-brood. For other particulars see "Guide Book." The water from the ditch would cause neither of these diseases.

P. M. (Devon).—It is odourless foul-brood, and can easily be cured with "apiculture."

B. K. A. (Ware).—The comb sent is affected with foul-brood.

A. C. (Kendal).—The brood is chilled only.

**Special Prepaid Advertisements****Two Words One Penny, minimum Sixpence.**

Orders for three or more consecutive insertions entitle advertisers to one insertion in "The Beekeepers' Record" free of charge.

Trade advertisements of Bees, Honey, Queens, and Bee goods are not admissible at above rate, but will be inserted at 1d. per word as "Business" Announcements, immediately under the Private Advertisements. Advertisements of Hive-manufacturers can only be inserted at a minimum charge of 3s. per ½ in., or 5s. per inch.

**PRIVATE ADVERTISEMENTS.****T**WO New Bar-Frame HIVES, with lift and 10 Frames, wired, canvas covered roof, painted, 11s. each. Photo and particulars, HEARD, Orchard Hill, Bideford. h 98**B**EST BEE PLANTS, *Limnanthus Duglassi*, 25 plants 4 stamps, post free.—KERR, English-street, Longtown, Cumberland. j 40**Q**UEEN BEE, Native Black, 1910, 4s.; also pure-bred Wyandottes and Rocks.—Particulars, ALUN JONES, Brynawel, Halkyn, Flintshire. j 37**F**OR SALE, nearly new Claustral Hive with 2 shallow frames, 7 standard combs, 3 full sheets foundation, 4 super combs, 4 sheets foundation, queen excluder, 2 feeders, smoker, wiring-board, £2 or best offer on rail.—BEGGS, Mannville-road, Keighley. j 34**E**XCHANGE for BEES, 4 volt electric accumulator, 2 Osram lamps, 1 switch, Bichromate medical battery, mated pair canaries, breeding cage, or cash.—BOULTON, Stephen's-road, Leicester. j 33**F**OUR GOOD STRONG STOCKS, English, on 8 combs, 25s. each; guaranteed free from any disease.—IVE, Boughton, Newark. j 32**S**TRONG NATURAL SWARMS, guaranteed healthy, 12s. 6d. packed, safe delivery.—CADMAN, Codsall Wood. j 31**T**WO GOOD ITALIAN STOCKS on frames, 30s. each, including hive.—SAUNDERS, Thelma, Stechford, Birmingham. j 30**2** STRONG HEALTHY STOCKS in W.B.C. Hives, 1910 Queens, 30s. each.—RUMNEY, Whitley, Preston Brook, Cheshire. j 28**H**EALTHY STOCK OF BEES with Hive.—O. MORRIS, 31 Claude-road, Cardiff. j 27**F**OR SALE, cheap, splendid Wells Hive, also W.B.C. and other Hives, shallow frame crates, smoker, spirit level; stamp for reply.—WALLACE, Bramhall, Cheshire. j 26**P**RIME NATURAL HEALTHY SWARMS, 15s.—GEORGE BELL, Shoreham, near Sevenoaks, Kent. j 25**F**OR SALE, cheap, 2 Frame Hives, Section Racks, Excluder Zines, dozen new Frames and Foundation, Honey Extractor, Smoker, Veil, price 25s., or separately.—SEATON, 40, Argyle-road, Ilford. j 42**F**OR SALE, 2 STRONG HEALTHY STOCKS, on 10 Frames each, without Hive.; travelling boxes to be returned, price 25s. each.—HENRY SMITHFIELD, Egremont, Cumberland. j 41**1** ONLY, COTTAGE HIVE, 8s.; 2 W.B.C. Hives, 15s. each, all complete, painted and unused; Meadows' Extractor, 13s.—MRS. PRITCHARD, Carterton, Oxon. j 20**E**XCHANGE splendid white or black WYANDOTTES for Bees, Stocks, or Swarms, guaranteed healthy.—DYCIE, Flackwell Heath, Bucks. j 19**Special Prepaid Advertisements.—Continued****T**YPEWRITER, Williams, visible writer, cost £22, splendid condition, 60s., bargain.—WAKEFIELD, Newhall Hill, Birmingham. j 3**W**.B.C. HIVE, with exceedingly strong Stock English Bees, will swarm early. Spare hive, sundries, equal new, the lot, cheap.—DART, West Horsham. j 12**B**EES FOR SALE, 3 strong, healthy Stocks, 1910 queens.—Apply, P. HEATH, Thremhall Priory Cottages, Bishop's Stortford, Herts. h 77**BUSINESS ADVERTISEMENTS.****T**RANSSPARENT "BEE CONTROL" (Gillies) POCKET CLOTHS and 100 re-charges, 1/-.—GAMAGE, London; BURGESS, Exeter; CROSS, Belfast. Wholesale: IREKLING CORPORATION, Dublin. h 79**Y**OUNG FERTILE QUEENS, 4s. 6d.; Virgins, 1s. 9d.; safe arrival guaranteed.—TOLLINGTON, Woodbine Apiary, Hathern. j 39**M**UST SELL, grand little APIARY, 5 Stocks Lanaways 20s., Hives crammed with Bees ready for immediate supering, smoker, all appliances, splendid start for beginner, guaranteed healthy, bargain, £6 15s.—Particulars, HIGGINSON, Egerton, Kent. j 35**P**RIME NATURAL SWARMS now ready, 15s. 6d.; boxes 6d.; Stocks on 10 frames, 30s.; guaranteed healthy.—HIGGINSON, Egerton, Kent. j 36**3000** PURE FERTILE 1911 QUEENS TO BE SOLD DURING SEASON, Swiss Brown Natives, 5s.; Blacks, Italians, Carmiolans, 3s. 6d.—FREDERICK VOGT, 38, Clementina-rd, Leyton, Essex.**L**AST SEASON we dispatched over 100 Swarms. Am booking orders for after June 7th, 2/6, guaranteed; cash with orders given preference.—SOUTHCOTT, Gittisham, Honiton. j 1**60** NATURAL SWARMS, guaranteed healthy, May, 3s.; June 2s. 6d. lb.; packages free.—MASON, expert, Moorend, Stony Stratford. j 6**S**WARMS (surplus), sale on issuing; Pupil-assistant wanted.—BUGDEN, Wye, Kent. j 15**G**UARANTEED HEALTHY SWARMS, 3s. lb., cash with order.—WATSON, Pine View, Mildenhall. j 21**35**TH YEAR.—Nuclei, 3 frames, 12s. 6d.; 4, 14s.; all wired, healthy; empties returned paid.—ALSFORD, expert, Haydon, Sherborne.**T**HE PREPARATION OF HONEY AND WAX for Show Bench, 7d.—TINSLEY, Stone, Staffs. j 24**G**OLDEN PURE CYPRIAN fertile Queens, gentle strain, five yellow banded, 6s. each, post free.—Write to DERVISHIAN BROS., Nicosia, Cyprus. h 71**B**EES, Stocks on Combs, guaranteed healthy, six, eight, and ten frames, 20s., 25s., 30s.; empties returned.—F. A. BEAN, Snaith, Yorkshire. h 89**I**TALIAN FIRST CROSS, best honey gatherers, good tempered, strong 10 frame Stocks, with last season's Queens, guaranteed healthy, this season's work; package free, 25s. each.—O. KNIGHT, Epney, Stonehouse, Glos. j 38**P**RIME NATURAL HEALTHY SWARMS, ENGLISH BEES, May, 12s. to 15s.; June, 12s.; swarm boxes returnable; cash or deposit.—LEWIN, Molesworth, Hunts. j 29**S**WARMS from Bar-framed Hives, guaranteed healthy, May, 15s.; June, 15s.; Stocks, 30s.—J. REAVELEY, Starbeck, Harrogate. j 18

## Editorial, Notices, &c.

### MALIGNANT DYSENTERY.

We have received the report just issued by the Imperial Biological Institute, Dahlem, of the work done during 1910, and in it we find, under the title "Zur Oetiologie und Epidemiologie de Ruhr bei den Bienenvölker," a report by Dr. Maassen of his further investigations respecting dysentery in bees.—In a former report issued in 1910 (see "Bee Journal" page 483, December 8th) Dr. Maassen confirmed the discovery by Dr. Zander of the presence of *Nosema apis* in certain bees and found the parasite very widely distributed. He pointed out that it may be present in small numbers in healthy bees without multiplying or causing any inconvenience, and only be dangerous when the health of the bees becomes impaired through any cause. In this report he confirms his previous observations, but differs from Dr. Zander on some points of importance. He has no doubt about the parasite being present in most colonies, and in Germany he says there are very few apiaries entirely free from it. The colonies in the different apiaries, however, show marked variations in the virulence of the infection. In some apiaries the parasite is plentiful, and the results are evident, but in others it can be found only by careful investigation. The parasites are usually abundant in weak bees, suffering from dysentery, and in these the spores are found in large numbers.

Dr. Maassen states that the discovery of these parasites now is nothing new, for Dönhoff and Leuckart had already mentioned them so far back as the middle of the last century. They found them in the chyle-stomach, as bright oval bodies which they took to be spores of some fungus. They also succeeded in reproducing the disease by feeding bees with these spores. At that time many colonies were lost in Westphalia, Hanover, Baden and Schleswig, and in the apiary of Dr. Dzierzon sixty colonies perished from this disease. It was not surprising that these scientists took these oval bodies for fungoid spores, for at that time bacteriology was not so advanced as it is now, for even the spores of *Nosema bombycis*, the cause of "pebrine" in the silk-worm, were classed amongst fungi, and it is only later that they were put into the class with unicellular protozoa.

Dr. Maassen says *Nosema bombycis* and *Nosema apis* are very similar in their development, but are easily distinguished. He points out, however, that the parasite of the silk-worm is not pathogen to the

bee, nor the parasite of the latter to the silk-worm. He found that badly infected bees sometimes live a long time, and that drones were also liable to be affected. In the autumn of 1909 he wintered thirty colonies, in the bees of which *Nosema* was abundant. Of these, in the spring of 1910, three developed dysentery, two lost a large number of bees, one of which ultimately succumbed for lack of food, and the remaining twenty-four wintered well, and eventually became strong. The dysenteric bees also recovered. He was able to find the parasite in all the colonies, but observed that it did not appear in the young emerging bees, so that brood was free from the disease. The parasite was also found in the queen, although frequently in infected colonies healthy queens were observed.

At intervals during the summer these colonies were examined and *Nosema* was generally found present in the bees, although the colonies behaved like healthy ones. The young bees became affected at a later period after beginning work in the hive. Dr. Maassen considers that the spread of the parasite is due to the fact of keeping weakly colonies, and the interchanging of combs in different hives. The danger exists in the bees discharging their excrements, which abound in spores, in the hives. As an experiment Dr. Maassen placed twelve marked and infected bees into a nucleus containing two combs of healthy bees. In eight days 40 per cent. of the bees became infected and in three weeks every bee contained the parasites. The parent colony from which the nucleus was formed remained healthy. Colonies that through any cause are weakened are the ones to succumb during the spring, this is why the mortality is greatest at this season of the year. Strong colonies may become affected if disturbed during winter, and in consequence consume large quantities of food, principally pollen, or are confined to a badly ventilated hive or one unprotected from cold and wind. Also if the sugar syrup becomes crystallised it becomes detrimental. Dr. Maassen was at the time of writing wintering bees on sugar syrup, conifer honey, and heather honey, and intends to give the results in a future report. In many respects this *Nosema* disease resembles the "Isle of Wight" disease, which is probably only a variety of the former.

### "ISLE OF WIGHT" DISEASE.

The Board of Agriculture and Fisheries have just issued a leaflet (No 253), giving a description of the symptoms of this disease. Although some progress has been made with the study, it is not yet possible to say definitely what is the originating

cause of the disease, but in the meantime bee-keepers are recommended to watch their bees, and on the appearance of the symptoms described, to destroy diseased colonies and disinfect hives and ground. The main points of difference between this and kindred diseases are also mentioned, so that there should be no mistake in diagnosing the complaint correctly. The leaflet may be obtained by applying to the Secretary, Board of Agriculture and Fisheries, Whitehall Place, London, S.W.

#### BRITISH BEE-KEEPERS' ASSOCIATION

The monthly meeting of the Council was held on May 18th, 1911, at 23, Bedford Street, Strand, London, W.C. Mr. C. L. M. Eales presided, and there were also present Miss K. M. Hall, Messrs. J. Smallwood, E. Watson, O. R. Frankenstein, J. B. Lamb, A. Richards, R. T. Andrews, G. W. Judge, J. E. Smiles (Crayford), and W. Herrod (secretary).

Letters expressing regret at inability to attend were received from Miss M. L. Gaylon, Messrs. T. W. Cowan, W. F. Reid, F. Bevan, G. W. Avery, E. Garcke, and Rev. A. D. Downes-Shaw.

The minutes of Council meeting, held April 20th, were read and confirmed.

The following new members were elected: Miss A. R. Francis, 37, Delaware Mansions, Sutherland Avenue, W.; Miss A. Adams, Grove Cottage, Farnham, Blandford; Mr. J. Trendell, Netherton, Harrietsham, Kent; Mr. J. Hawes, 14, Stafford Place, Buckingham Gate, London, S.W.; Mr. J. W. Mason, 27, Arthur Street, Withernsea, East Yorks; Mr. G. Field, The Manse, Throop, Christchurch, Hants; Mr. A. Raymond, 1, St. James Terrace, Holland Park, W.

The following names of delegates were submitted and approved: Mr. J. Waterfield (Leicester), Mr. W. E. Hamlin and Mr. J. Kaehler (Surrey), Mr. J. Cunningham (Cambridge and District).

The report of the Finance Committee was presented by Mr. J. Smallwood, and it was resolved that payments be made amounting to £15 6s. 3d. The receipts for the month of April were £25 15s. 10d. The balance in hand at end of April was £133 14s. 3d.

The resignation of the Buckinghamshire Association from affiliation was accepted with regret.

The Shropshire Association applied for the confirmation of the appointment of Rev. T. J. Evans and Mr. A. Watkins, as judges at their show on August 23rd. The Glamorganshire Association applied for a third class examination to be held at Cardiff on July 26th, with Mr. S. Jordan as examiner.—Both applications were granted.

The form for submitting names of delegates by Association secretaries was presented by Mr. Richards; it was resolved to send same to the Publication Committee for approval.

Mr. Lamb made a short report upon the deputation, consisting of Mr. Reid, Mr. Garcke, and himself, to the Development Commissioners, which showed very hopeful signs of the Association obtaining a grant.

Mr. Eales said they were deeply grateful to the members of the deputation for the enormous amount of trouble and time expended in this work, and if their hopes were realised the result would be mainly due to their exertions.

A vote of condolence to the vice-president, Sir James Whitehead, in his bereavement, by the loss of Lady Whitehead, concluded the business.

Next meeting of the Council, June 15th.

#### REVIEW.

*The Lore of the Honey-Bee*, by Tickner Edwardes (London: Messrs. Methuen, Ltd., price 1s. net). This is a new and popular edition of this interesting work, which first appeared in 1908, and has since met with considerable appreciation. Three editions have already been printed, this being the fourth, although the first at the popular price of one shilling. We have many popular technical treatises on bees and bee-keeping, but this is the only book by a modern English writer that deals with the subject from an antiquarian as well as a literary point of view. As the author is also a bee-keeper his book covers the whole field of ascertained facts in the natural history of the honey-bee as well as the romance of bee-keeping. He also shows that the utility of bees was known in ancient times, for so far back as the Bronze Age it is certain that wax was used in casting ornaments and weapons. All the conditions favourable to insect life must have been present in the world ages before man appeared in it, and insect life undoubtedly existed in a high state of development. It would be as unreasonable, the author thinks, not to infer that the honey-bee was ready on the earth with her stores of sweet food for man as that man did not speedily discover that store and make it the object of his daily search, just as he went forth daily to hunt and kill four-footed game. Thus the first hunter was in all likelihood a bee-hunter. From the earliest days the author draws a picture of the honey-bee passing and working through the ancient civilisations of the world to the present day. He says nature is always wonderful, but not always admirable; and a close study of

the life within the hive brings out this truth more clearly than with any other form of life. Absolute community implies incidental cruelty, and it cannot be denied that bee-polity has its unpleasant and even revolting aspects, as, for instance, the destruction of the queen when her powers of egg-laying fail, and the slaughtering of the drones when their services are no longer needed. The author alludes to ancient writers, and after having studied them he comes to the conclusion that "dipping into these

sent the extremes of bee-manship as still extant in modern times. The book is not illustrated, there being only one picture on the wrapper, showing drone and worker brood, but a perusal of the contents is sure to fascinate every reader, who will find much to interest and delight him.

---



---

#### HELPFUL HINTS FOR NOVICES.

*By W. Herrod.*

*Use of the Dummy Board.* A "dummy" is supplied with every hive sent out, yet



*Photo by J. Russell & Sons.]*

MR. TICKNER EDWARDES.

*Author of "The Love of the Honey-Bee."*

time-worn records of the Middle Ages, with their embrowned, scarce legible type, and their antiquated phraseology, one comes at last to realise how little the old bee-masters actually understood of the true ways of the honey-bee, or, indeed, of any real essential in bee-craft." Further on Mr. Edwardes dwells on the romance of the bee-hive and touches upon the wonderful communal life within it in its varying aspects, and winds up by introducing the reader to a Sussex village where live two bee-keepers who repre-

in ninety-nine cases out of a hundred it either remains at one side of the brood-chamber and is glued fast with propolis until it becomes immovable, or is taken out, laid on one side, and lost. When building up weak stocks it is as necessary to use the "dummy" as the feeder. Upon the first examination the bees should be closed on to just the number of combs they are covering by means of the dummy; in this way, heat, which is so vital for brood-rearing in the spring, is conserved; it is exactly like dealing with a long room

having a fire-place at one end; in such a case, in the winter time, for the use of a few people, a curtain across the room will make the fire-place end snug and warm, instead of the whole room having the chilled feeling there would be if it were not there. Then, again, the food supply is economised, as less is required by the bees for raising and keeping up the temperature, as the heat is generated by the consumption of food, respiration, and by rapid movements of various parts of the body of the bee. Also the use of this appliance releases a larger number of bees to go out foraging. The dummy should not fit close down to the floor-board, a space of about three-eighths of an inch should be allowed, so that bees can pass freely underneath. On the unoccupied side it is advisable to keep a few frames fitted with foundation. These serve a double purpose, they help to keep the quilts snug and straight, and also prevent the bees wasting their energy in building drone comb in the empty cavity, which will happen if they are neglected for a time, and overpopulate the combs on to which they are confined. The bee-space under the dummy will allow them to pass to the fitted frames, and carry out useful work, instead of swarming, or wasting time as stated above. The use of the dummy means a little more labour and careful watching, but this is amply repaid by the rapid building up which results. Not until the occupied combs are well crowded with bees should extra ones be given, and when this is done they can be placed in the centre of the brood-nest, *but on no account should more than one comb be given at a time*, and only at such intervals as are necessary for allowing sufficient increase in the number of bees, so that all the time every comb is crowded, even the outside ones. The same operation applies to swarms which are first hived on to the full number of frames, these being reduced about the second day. This will ensure the building of perfectly straight combs.

*Stimulative Feeding.* In most districts, excepting those where a large amount of fruit is grown, stimulative feeding will still be necessary, and can be carried out in both colonies with plenty of natural stores, and also those where there is a shortage. In the former, it can be done by bruising the cappings on food cells. The idea of stimulative feeding is to give just sufficient food regularly to induce the bees to feed the queen abundantly for the production of eggs. The cappings bruised should be those just on the outside of the brood circle, and only a narrow strip at a time should be uncapped, the thumb nail drawn backwards once round is about the right breadth. This ensures that sufficient

food will be exposed, and when taken by the bees the empty cells will be immediately utilised by the queen for ovipositing as they are next to the brood, which is already growing, and in the natural position for the expansion of the brood nest. If the cappings at the top of the comb are bruised the bees will take the food, but the growth of the brood patch is not nearly so rapid. Where there is no food, thin syrup should be given in a bottle feeder, or a small quantity every few days can be given in a rapid feeder. The food should not be supplied in sufficient quantity to allow of storing, as this would do harm instead of good by blocking up the cells required by the queen for ovipositing. A feeder, which can be filled and regulated, is really the most satisfactory, as it entails less labour and ensures a constant small supply. Thin syrup does away with the necessity for the bees having to carry in a lot of water. The food should also be given "new-milk" warm, so that it will help in a double sense; first, by assisting to keep up the temperature, and, secondly, supplying food. If given cold a lot of energy and food is wasted by the bees in warming it, for the cold syrup will absorb heat until it reaches nearly the same temperature as the brood chamber. One experiment will quickly prove this to the bee-keeper. Place a bottle of cold syrup on a colony in the evening, the next morning, if the hand is placed on it, it will be found quite warm. Swarms in all cases should be fed for about seven days' longer if the weather is bad.

*Showing.*—The product of the novices' bees stands an equal chance with that of the more experienced bee-keeper. The art of preparation is acquired by practice, which should be obtained as soon as possible, and at the best shows. Entries for the Royal Show close on May 31st, and as the crop will be a short one, the novice who obtains honey stands a very good chance of winning a prize at the premier show in Coronation Year. To do this will make the year more eventful still. Enter at once.

---

## Correspondence.

---

*The Editors do not hold themselves responsible for the opinions expressed by correspondents. No notice will be taken of anonymous communications, and correspondents are requested to write on one side of the paper only and give their real names and addresses, not necessarily for publication, but as a guarantee of good faith. Illustrations should be drawn on separate pieces of paper. We do not undertake to return rejected communications.*

---

### NOTES BY THE WAY.

[8165] The month of May has been a merry month for the bees. It has cheered

the hearts of the bee-keepers, enlarged the brood-nests, and increased the population of the hives by leaps and bounds. We have already heard of two or three swarms in the cosy corners of our district, but we in the breezy positions must "bide a wee," and exercise patience for a week or ten days, and then we shall have some swarms worth hiving. These early swarms show that the bees are healthy in the neighbourhood for which, I trust, every bee-keeper is thankful.

Folding sections will now be the order of the day, and a word to our novices on the best way—in my experience—of making the corners tough, so that they will not break in the folding, may not be out of place. Take a clean towel, saturate it with clean water, wring slightly, fold it to a width of 11ins., place it on a brick floor against a wall—a damp one if you have it—now take your sections and place them edgewise on the damp cloth (say fifty sections), fold the cloth back over the top edges, and then place more sections in the same position on top of the first layer and bring the end of the cloth back over them. If you are folding a large number, more cloths can be used—after the sections have been wrapt in the damp cloths for a few hours they will fold with practically no breakage. Then my method of cutting foundation may be of interest, and to a novice, useful. Take a folded section and a side of another section, cut the bevelled edge of the piece square for 1¼ins.—this would fit tight in your folded section—and leave ¾in. of the piece of section, above or rather below the edge of your section, fix with glue or pins; this makes a stop. Lay your strips of extra thin super-foundation, about ten of them at a time, get the ends all true, place your cutting-guide with the stop at the end of the sheets of foundation, warm a table-knife and cut the foundation on the outside of the section, and you will find that the squares of wax are cut exactly the size of the inside of your ¼ sections. With split top or plain top sections these pieces of foundation touch the sides, and one of the first jobs the bees undertake when they take to the supers is to fix the foundation to the sides of the sections. I may add I always order my foundation cut 12in. by 4in., this leaves a little shaving at the end of the third squares to be cut off.

*Enlarging the Brood-Nest.*—If the honey flow in your district does not commence till white clover blooms about 10th of June, give a sheet of *wired foundation* in the centre of brood-nest, and remove the oldest outside comb if you have ten frames already in the hive. One or two sheets of wired foundation, given yearly, and the worst two combs taken away, will ensure the well-doing of the stock, and keep the brood-nest in the pink of condition. Feed-

ing swarms when first hived, if they have come a distance by rail should not be neglected, it helps to start them well in their new home.—W. WOODLEY, Beedon, Newbury.

#### ROSS-SHIRE NOTES.

[8166] Bees have made rapid progress here during the first summer month, and the present condition of stocks leaves little to be desired. Drones were first seen on the 23rd April, and their loud hum is now heard daily. This is very early for the North, and a marked contrast to last year when June was well on the way before the burly fellows appeared.

As our honey flow is not due for a month yet, a temporary enlargement of the brood-nest may be necessary to check swarming. Doubling the brood-chamber by the addition of a shallow or full-depth super is all right with extra prolific queens. Ordinary stocks can be worked to advantage on the dual queen system. When a colony fully covers ten frames, remove half the brood into a spare brood-chamber and fill up both brood-chambers with drawn combs. Place the portion containing her Majesty on the floorboard and the other on top, with excluder between. There must also be a single sheet of newspaper under the excluder, and another above it.

If this division is carried out on a warm morning, by evening the upper portion will be found deserted by all but young bees. These will readily accept a laying queen. The bees soon gnaw their way through the paper, and both lots unite peacefully to work as one at building up a large working force that will pile up a fine surplus when the days come for honey-gathering. This scheme has worked well with me.

*Bee-paralysis.*—My experience of this nightmare has fortunately been confined to one stock, and none of the rest show any signs of the dread trouble. By the way, what are the first signs?

In my case the affected stock, although fairly strong with abundant stores and the queen laying well, gathered no pollen whatever this spring. Not a single load of pollen was seen going into that hive while all the rest were busy that way.

Possibly the bees infected by this strange malady recognise that they are doomed, and make no effort to prolong the existence of the colony. I fear the Bulgarian sour milk treatment is not exactly applicable to this business. The life of a bee during summer is but a few weeks, and the bee-keeper's life, also, is too short to permit of his diagnosing and dosing successive generations of diseased bees. In such cases we must destroy to cure, anticipating and emulating nature, which, while

mindful of the race, is careless of the individual.—J. M. ELLIS, Ussie Valley.

#### YORKSHIRE AND "ISLE OF WIGHT" DISEASE.

[8167] I should be glad if you would allow me to add a word of emphasis to Mr. Crawshaw's protest against the blackening of Yorkshire as a diseased area in the map which appeared in the Journal some weeks ago. A protest seems to me to be the right thing until we are told (1) who drew the map; (2) what are his qualifications; (3) how he has got his information; and (4) how far over this big county that information covers the ground?

To publish such a map, without giving reasons in justification of what it says, is not in accordance with the old considerate tone of the Journal, or the well-known natural justice of its venerated Editor—in my opinion. I have, unfortunately, been too ill all this winter to leave my bed, and I have therefore seen nothing of bees, healthy or unhealthy. But for the last twenty years I have kept, on an average, fifty stocks of bees in perfect health. I have carefully examined bees in some hundreds of Yorkshire villages. I have taken bees, year after year, to the moors, where quantities of stocks are massed together; and with this experience I wish to say that I consider that Yorkshire is, on the whole, very fairly free from disease as to its bees, though, of course, here and there foul brood has a hold.

It must be remembered that we have long and trying winters. This is a blessing in disguise. It kills off weak stocks, and discourages unskilful bee-men. This means strong stocks surviving, and fairly good bee-keeping only; and we have the advantage of plenty of room. As a rule, one village is quite out of bee-flight from the next; and then again, we buy comparatively few bees from outside the county. All these things may be in favour of health among the bees. All I ask for is that reasons should be given before we are publicly placarded as a thoroughly diseased area.

I should also, however, like to suggest that it seems possible that the new disease is not yet so thoroughly diagnosed as to make it certain that all its symptoms, as usually described, belong to it and to nothing else.—SIDNEY SMITH, First Class Expert, late Hon. Secretary, Yorks. B. K. Association.

[We are quite sure that Dr. Malden did not intend to imply that the whole of Yorkshire was infected by disease, but in preparing his map he adopted the usual course of indicating the counties in which the disease had appeared. It will be noticed that there is a distinction made in the shading, showing that the disease exists

only to a small extent in those countries with light shading, in contradistinction to the darker shading of the southern counties, where the disease has been prevalent the longest, and to a greater extent. Of course, only Dr. Malden can answer our correspondent's question, but as he is making the investigations in connection with the inquiries being carried on by the Board of Agriculture, he has, no doubt, had their assistance in the matter and has adopted the usual practice. As the map accompanied the paper read by Dr. Malden, we could not do otherwise than publish it, but we have already explained and made it clear on page 141 of B.B.J. Ed.]

#### "ISLE OF WIGHT" DISEASE.

[8168] I have already lost three lots of bees by the above disease, and a fourth is affected, with which I am experimenting. I have consequently read with great interest the letters that have appeared in your valuable journal in reference to the disease. Some of the writers suggest how it originated.

After duly considering the matter, I am firmly of the opinion that it is caused by a gradual degeneration of the race of bees through repeatedly taking away too much honey, and consequently having to almost entirely feed them on sugar, which, even of the best cane, is not natural food. There may also be something deleterious left in the sugar, after it is manufactured.—P.W., Olton.

#### BEES IN STORNOWAY.

[8169] This has been a marvellous spring for bees in Stornoway. Two of my stocks are working in sections, and one had drones flying a week ago. The honey seems to come mainly from flowering currant, which is very plentiful round here.—JOHN ANDERSON, Stornoway, May 4.

#### AMERICAN AND COLONIAL PAPERS.

##### EXTRACTS AND COMMENTS.

By D. M. Macdonald, Banff

*Carniolans*.—A writer in *Gleanings* hailing from California sings the praises of these bees and he has proved them better than Italians in three ways. They resist disease better, they breed better, and they put less honey in the brood-nest and consequently more in the supers. "The last season proved to many of our valley bee-keepers that the Carniolans would withstand disease better when the Italians in the same apiary were infected and re-infected. With the mammoth colonies they supply, one would be surprised at the amount of honey they will gather



even in a poor season. Then during our honey flow Italians are always crowding the brood-nest with honey. This is not the case with Carnolians." This race has been well spoken of in this country, but has been well nigh discarded on account of their immoderate swarming. Where increase is desired they are the bee, also they are uncommonly sweet tempered, and they are admirable cappers of comb-honey. Of late several Canadian bee-keepers have taken them up again and speak highly of them. For those who "ship" swarms they should prove a paying asset as they are such prolific breeders.

*Florida.*—A good deal of notice has recently been given to this State by Messrs. Root. Another writer specifies fifteen good honey sources, eleven of these being from trees. "Four strictly first-class honeys are orange, saw-palmetto, tupelo, and black mangrove. The state as a whole enjoys a fine warm climate, but that is not always a true test as to success in bee-keeping, as I note one who has tried California and Canada, votes in favour of the latter. In Ontario a crop can be secured nine years out of ten; in California only two good crops can be relied on in the same period."

*Flavour.*—In some tables giving a scale of points the Editor of *Australasian Bee-keeper* allots fifty points to flavour in the candied honey class, forty in extracted, and for comb honey the entry is nil. The last entry struck me so forcibly that I hunted up a few specimens of the scale of points sometimes used in this country, the States, and Canada. Every one I lighted on took note of flavour in some shape or other, and in one prominent example, although it is not specially mentioned in the points, emphasis is laid on tasting every section, and it is advised that the final decision should rest on the flavour. That will be more than ever the determining factor with me in the future.

*The Food of the Bee.*—"This consists normally of pollen, nectar and honey. The first is eaten entirely with the mandibles, while the other two are taken through the proboscis. The pollen is to the diet of the bee what meat is to ours: that is to say, it contains the proteid or nitrogen-containing ingredient of the food, which is necessary to the support of any animal, and also substances comparable to fat called in general *hydrocarbons*. The nectar and honey consist principally of grape sugar, fruit sugar, and cane sugar, which belong to the class of substances known as *carbohydrates*." We may gather from this that both kinds of food are necessary to the well-being of the denizens in any hive. This is a fact that bee-keepers are perhaps too apt to

forget. With active breeding going on the rapid accumulation of portean food is very apparent, as it is an essential to the rapid increase of any colony. But to the adult bee it is no less a necessity. An overplus of it in early spring is, I think, one of the chief generating causes of dysentery in a colony unseasonably housed. Honey is a predigested food, and bees can consume relatively considerable quantities without desiring a cleansing flight. Over indulgence, however, in nitrogenous food quickly necessitates evacuation, and hence we have spring dwindling and attendant ills.

*Gleanings from "Gleanings."*—"A queenless colony is just the one with the most pollen, because for a time the bees continue to carry in pollen for which there is no market." "I got track the other day of a man who is actually getting rich on what other men throw away. He buys up "slumgum" and gets a fine grade of wax from it. A very old brood-comb weighed 36½ oz., a new one that had never been bred in weighed only 11 oz. That might fool a bee-keeper to let his bees store for want of stores." "We know that diseases which infect the human family may lie in old garments for decades, then why not in "old garments" occupied once by baby bees." "It would pay us to look after our winter entrances better than some of us do, because the size of the entrance may make a material difference in the welfare of colonies." "It is interesting to know that it takes 37,333 bee loads of nectar to make a pound of honey. This means more than a million flowers visited to obtain one pound." "A few orchards in Vermont produced heavily, where no bees were kept in the vicinity. This was puzzling until it was discovered that an immense number of bees were wild in the woods near." "If the mothers of our land could be taught to understand the value of honey used instead of sugar, the consumption of honey would be more than doubled in a very short time." "Using flying machines to move bee supplies and honey from our mountain canyons is a dream of a Californian bee-keeper. Hurry up!"

---

## Queries and Replies.

---

[4132] *Obtaining Increase and Surplus*—I am expecting a stock to swarm shortly and have been advised after the swarm issues to move the parent hive to another part of the garden standing the swarm in its place. By doing so, will all the bees from the old hive return to the old

stand and join the swarm. Would you advise me to follow this plan, or shall I put the swarm by themselves, and if a cast issues nine days later, return it to the parent hive? AN ESSEX BEGINNER.

REPLY.—If you wish to increase your stocks, and also get some surplus honey, do as advised, putting the super on the swarm which stands in the old position. The reason for moving the parent colony is so that all the flying bees will join the

of fence. Don't string the wires too tightly, but simply press on the grooved half of top bar firmly, until the shoulders at the top side meet, and every wire is instantly tightened by the friction joint, and the foundation is fixed as firm as a rock. Pass the spur embedder over and the frame is completed—a square and sound job. There is no need to nail the grooved half of top bar after pressing it on; it can then be taken off for any future

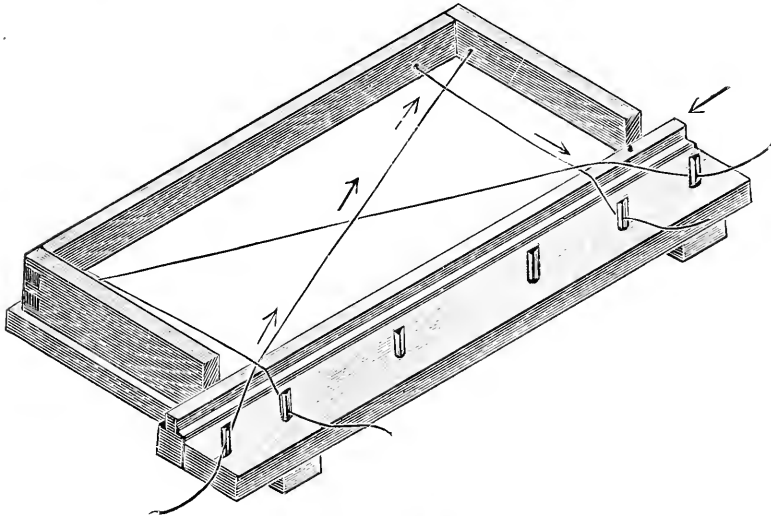

PROCESS OF WIRING.

swarm, thus making it strong enough to yield surplus. There will be sufficient young bees left in the parent colony to carry on the work, as young bees do not fly until they are a fortnight old.

uses. Messrs. James Lee and Son, Ltd., Highbury, London, have the sole right to

NOVELTIES FOR 1911.

NEW "PERFECTION" FRAME AND BLOCK,

Messrs. G. and E. Thorpe send two illustrations of their new invention, the "Perfection Frame", and block for wiring, the advantages of which are described by them in the following notes:

"The fixing of foundation and wire is done at one operation. When wiring the foundation, put the frame together and lay it on the block-board, leaving off the grooved half of the top bar; now lay in the sheet foundation close up to the tongue of the top bar. After cutting the wires to the required lengths, press one end lightly down into the split pin at the end of fence-board, and pass it over the tongue to the pierced holes at the bottom of frame, and up again to the opposite end of fence, as shown by the arrows on the block-board. Proceed likewise with another wire from the other end

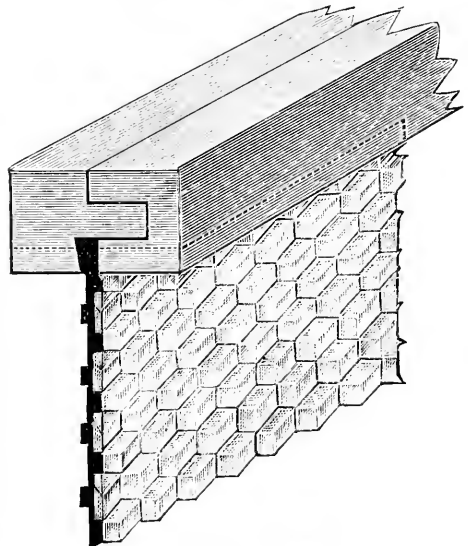

PERFECTION FRAME.

manufacture these frames and blocks in the United Kingdom."

TRADE CATALOGUE RECEIVED.

F. W. L. SLADEN (*Ripple Court Apiary, near Dover*).—This is a catalogue of bees, queen-bees and queen-rearing appliances. Mr. Sladen makes a speciality of "British Golden," a strain which is noted for the good qualities of the bees. He also supplies queens of foreign varieties, and a perusal of his catalogue will show the appliances used in his own queen-rearing establishment, and which will be found useful by other bee-keepers wishing to rear queens. The catalogue is beautifully got up on art paper and should be of interest to all bee-keepers.

Bee Shows to Come.

**June 26 to 30, at Norwich** (Royal Agricultural Society's Show).—Bee and Honey Section under the management of the B.B.K.A. Prizes arranged in groups of counties for Associations affiliated to the B.B.K.A. Schedules from W. Herrod, Secretary, B.B.K.A., 23, Bedford Street, Strand, London, W.C. **Entries close May 31.**

**July 13 and 14, at Brigg, Lincs.**—Lincolnshire B.K.A. Great Show of Honey, Hives, and Appliances, at the Brigg Exhibition of the Lincolnshire Agricultural Society. Valuable prizes offered in Open Classes for Trophy, Extracted, Granulated, and Comb Honey, Observatory Hives, Bee Appliances and Hives. Schedules, &c., from Mr. J. H. Hadfield, Alford, Lincs. **Entries close June 9.**

**July 19 and 20, at Stafford.**—Honey Show in connection with the Staffs. Bee-keepers' Association. Four open classes. Schedules from Joseph Tinsley, 22, Granville Terrace, Stoue, Staffs. **Entries close July 10.**

**July 26 and 27, at Cardiff.**—Annual Show of the Glamorgan B.K.A. in connection with the Cardiff and County Horticultural Show. Separate tent for honey, wax, and appliances. Open classes. Special prizes. Schedules from Hon. Sec. Mr. Wiltshire, Maindy School, Cardiff.

**August 3, at Weston-super-Mare.**—Annual Show of the Somerset B.K.A., in connection with the important Local Annual Flower Show. Classes for Appliances, Honey, Wax, and Bee Products. Several open and free classes. Liberal prizes. Numerous attractions. Excursions from all parts. For Schedule, &c., apply to T. Jones, Assistant Show Secretary, North View, Milton-road, Weston-super-Mare. **Entries close July 29.**

**August 23, at Radstock, Somerset.**—Honey Show in connection with the Radstock Horticultural and Farmers' Association. Open and gift classes. Write for Honey Schedule. B. M. Clark, Foxhills, Radstock.

Notices to Correspondents.

B. B. (Ramsgate).—*Old Foundation*.—The foundation is quite fit for use, the whitish appearance being due to its having been stored for some time. Warm it steadily in front of the fire, when it will resume its normal appearance, and become pliable and soft. The bees will then accept it readily.

M. V. S. (Harperley).—*Best Book on British Wild Bees*.—The Hymenoptera Oeuleata of the British Isles, by E. Saunders, F.R.S., published by Lovell,

Reeve and Co., price 68s. net, with forty-eight plates, or a smaller edition with three plates, at 16s. net.

M. T. (Farnborough).—*Bees Visiting Drains*.—The bees are attracted to the drains by the saline matter contained in the water, and their going there is no evidence of disease. Try adding a little salt to the water you supply them with. The trough should be put in a warm, sunny place, and the bees should be able to reach the water without risk of drowning.

T. C. (Derby).—*Drown Eggs in Worker Cells*.—The queen is either an old, worn-out drone breeder, or one reared this year too early for fertilisation. The eggs are infertile, and only drones can be produced from them. This is the cause of the elongation of the cells.

J. M. (North Lyne).—*Swarms*.—The colony will not swarm until *all* the combs are crowded with bees.

H. G. (Cardiff).—*Queen Cast Out Dead*.—The queen is a young one, and her death was probably caused through fighting with a rival, as from your description the colony had been queenless for some little time and had reared young queens.

H. H. (Dartford).—*Poison in Stings*.—The only research work on the poison in stings is that written by G. Carlet in *Combs Rendus*, 1884. The origin of formic acid in honey was fully discussed in "B.J." 11th June, 1908, page 231. Perhaps this may be of some use.

E. B. (Birmingham), and G. A. (Edinburgh).—*Wild Bees*.—The specimens sent are *Andrena fulva*, one of the most common of our wild bees.

H. R. (Cheadle Hulme).—*Drone Organ*.—This organ, once extruded, cannot be drawn in again.

N. C. (Tatton).—*Hants B.K.A.*—The Hon. Secretary of the Association is Mr. E. H. Bellairs, Bransgore, Christchurch, Hants.

B. W. D. (Sheffield).—*Destroying Wild Bees*.—Your gardener is right. As the nest must be destroyed, pour tar into the hole at night, and block it up so that there is no means of egress.

*Suspected Disease.*

C. F. B. (Cornwall).—Cause of death is foul brood. To burn hives and contents and start afresh would be the best course to take under the circumstances.

BEGINNER (Carmarthenshire).—Comb is affected with foul-brood; as the stock is weak and queenless destroy it without delay, and on no account use the combs for another hive.

W. F. H. (Whitland).—The bees have died of starvation; you can use the combs again.

**Special Prepaid Advertisements****Two Words One Penny, minimum Sixpence.**

Orders for three or more consecutive insertions entitle advertisers to one insertion in "The Beekeepers' Record" free of charge.

Trade advertisements of Bees, Honey, Queens, and Bee goods are not admissible at above rate, but will be inserted at 1d. per word as "Business" Announcements, immediately under the Private Advertisements. Advertisements of Hive-manufacturers can only be inserted at a minimum charge of 3s. per ½ in., or 5s. per inch.

**PRIVATE ADVERTISEMENTS.**

**F**OR SALE, 2 Lee and Son's Frame Hives, one fitted with 6 frames of foundation, almost new, Smoker and Gloves; first reasonable offer accepted.—OWNER, Youlgreave, Croydon. j 59

**2** GOOD STOCKS, in Standard Hives, guaranteed healthy, 45/-, cheap.—SMITH PICKLES, Pecket Well, Hebden Bridge. j 44

**F**OR SALE, several shallow Frame Supers, clean Drone Comb, overstocked, healthy, 4s. each.—ROUSE, Rochford, Tenbury. j 43

**Q**UEEN, Sladen's strain, choice, 1910, prolific and healthy, 5s.; Bees, Sladen's, 8 Frames 1910, Queen, 30s.; cash with order.—BROOKS, Ashingdon Chase, Rochford, Essex. j 45

**T**YPEWRITER, Remington, universal keyboard, perfect condition, very clear writer, will last a lifetime, cost £22, sell 80/-; great bargain.—L. WAKEFIELD, Newhall Hill, Birmingham. j 46

**C**HESHIRE. Strong Stocks, guaranteed healthy Bees for sale, young Queens and good Combs, from 20/-; Swarms, May, 5s.; June, 2s. 6d. per lb.; several empty Hives; seen by appointment.—H. BROOK, Polygon, Bowdon, Cheshire. j 47

**T**WO STANDARD BAR-FRAME HIVES, outer chamber ¾ in. wood, well painted, zinc roofs, almost new, no disease, 10s. 6d. each.—WADDINGTON, Tremerechion, St. Asaph, N. Wales. j 48

**T**OMATO PLANTS, Holmes's Supreme Up-to-Date, Laxton's Open-air, 1s. doz., post free.—F. W. GELDER, Sturton, Lincoln. j 49

**2** STRONG, HEALTHY STOCKS FOR SALE, 30s. each; no hives.—CLARKE, Pollard's Hill, Norbury, S.W. j 51

**W**ANTED, a few Skeps of Bees, with old and tough combs for driving purposes.—HERROD, "Bee Journal" Office.

**S**WARMS of healthy Bees for Sale, May 14s. 6d.; June 12s.—BOWREY, Swallowfield, Berks. j 53

**F**OR SALE, 4 powerful Stocks, guaranteed sound, healthy, working in supers, 25s. each; 12 spare hives, from 4s. each; also 12 volumes "Bee Journal," 1s. each; must sell, leaving district.—TREVOR, Highleadon, Newent, Glos. j 54

**S**TRONG, NATURAL SWARMS FOR SALE, June 11s. each.—COOK, Barton Mills, Mildenhall. j 55

**G**UARANTEED HEALTHY STOCKS, ready for Supers 35s.; Standard Nucleus Hives, unused, 1s. 6d.; Tamlin Incubator, 100-egg, as new, £2 10s.—BEECROFT, Abbots-road, King's Heath. j 56

**£2.** - Five large Hives, several section racks, trunk full of frames, sections; exceedingly cheap.—SMITH, 105 Crown Lane, Horwich, Bolton. j 58

**P**REPARATION FOR SUPERING.—Racks of Sections, fitted starters, ready to put on, 18in. by 21in., 1s. 6d. and 1s. 9d. each.—LITMAN, Castle Cary. j 57

**Special Prepaid Advertisements.—Continued**

**N**ATURAL SWARMS FOR SALE, June 1st to 17th 2s. 3d., after 2s. per lb.—R. ALLEN, Tusmore, Bicester. j 52

**T**WO New Bar-Frame HIVES, with lift and 10 Frames, wired, canvas covered roof, painted, 11s. each. Photo and particulars, HEARD, Orchard Hill, Bideford. h 98

**S**TRONG NATURAL SWARMS, guaranteed healthy, 12s. 6d. packed, safe delivery.—CADMAN, Codsall Wood. j 51

**T**WO GOOD ITALIAN STOCKS on frames, 30s. each, including hive.—SAUNDERS, Thelma, Stechford, Birmingham. j 30

**F**OR SALE, cheap, splendid Wells Hive, also W.B.C., and other Hives, shallow frame crates, smoker, spirit level; stamp for reply.—WALLACE, Bramhall, Cheshire. j 26

**1** ONLY, COTTAGE HIVE, 8s.; 2 W.B.C. Hives, 15s. each, all complete, painted and unused; Meadows' Extractor, 13s.—MRS. PRITCHARD, Carterton, Oxon. j 20

**E**XCHANGE splendid white or black WYANDOTTES for Bees, Stocks, or Swarms, guaranteed healthy.—DYCHE, Flackwell Heath, Bucks. j 19

**W**.B.C. HIVE, with exceedingly strong Stock English Bees, will swarm early. Spare hive, sundries, equal new, the lot, cheap.—DART, West Horsham. j 12

**B**EES FOR SALE, 3 strong, healthy Stocks, 1910 queens.—Apply, P. HEATH, Thremhall Priory Cottages, Bishop's Stortford, Herts. h 77

**BUSINESS ADVERTISEMENTS.**

**I**TALIAN QUEENS, direct from Italy. See complete advertisement in "British Bee Journal" May 18th.—Address, E. PENNA, Bologna, Italy.

**B**EES WANTED, any quantity, Stocks, Swarms, etc.; state lowest price.—BRICE'S APIARIES, Otford, Kent.

**H**EALTHY NATURAL SWARMS, May, 3s.; June, 2s. 6d. lb.—GEO. MASON, expert, Moored, Yardley Gobion. j 50

**T**RANSSPARENT "BEE CONTROL" (Gillies') POCKET CLOTHS and 100 re-charges, 1/-.—GAMAGE, London; BURGESS, Exeter; CROSS, Belfast. Wholesale: IREKLING CORPORATION, Dublin. h 79

**3000** PURE FERTILE 1911 QUEENS TO BE SOLD DURING SEASON, Swiss Brown Natives, 5s.; Blacks, Italians, Carmiolans, 3s. 6d.—FREDERICK VOGT, 38, Clementina-rd, Leyton, Essex.

**L**AST SEASON we dispatched over 100 Swarms. Am booking orders for after June 7th, 2/6, guaranteed; cash with orders given preference.—SOUTHCOTT, Gittisham, Honiton. j 1

**60** NATURAL SWARMS, guaranteed healthy, May, 3s.; June 2s. 6d. lb.; packages free.—MASON, expert, Moored, Stony Stratford. j 6

**S**WARMS (surplus), sale on issuing; Pupil-assistant wanted.—BUGDEN, Wye, Kent. j 15

**G**UARANTEED HEALTHY SWARMS, 3s. lb., cash with order.—WATSON, Pine View, Mildenhall. j 21

**35**TH YEAR.—Nuclei, 3 frames, 12s. 6d.; 4, 14s.; all wired, healthy; empties returned paid.—ALSFORD, expert, Haydon, Sherborne.

**T**HE PREPARATION OF HONEY AND WAX for Show Bench, 7d.—TINSLEY, Stone, Staffs. j 24

## Editorial, Notices, &c.

### REVIEWS.

*Die Biologie der Biene*, by Dr. Hans Stadler (published by H. Stürz and Co., Würzburg, no price given). This book which is purely scientific, treats of the biology of the honey-bee, and gives a general description of its anatomy and physiology. The bee at her work in comb-building is described, and there are thirty-three good illustrations, which aid in understanding the descriptions contained in the eighty-four pages. Only one chapter is given on practical bee-keeping, most of the book being devoted to the biology. The last chapter deals entirely with theoretic and comparative biology, and the author treats in it of the various organs of which at present we know very little, and describes the development from the solitary to the social bees. There is also a table of various measurements, which would be useful to those studying the structure of the combs.

*Gunstige Resultaten verkregen door de Bevruchting van Oofterbloesems door Bijen*, by T. W. Cowan. This is a translation into Dutch by E. W. C. Plancius, of Mr. Cowan's pamphlet on the "Beneficial Results from the Fertilisation of Fruit Blossoms by Bees." It is published by W. A. van Os, Bijenstand "de Bree," Amerongen, Holland.

### SURREY B.K.A.

#### ANNUAL MEETING.

The members of the Surrey Bee-keepers' Association held their annual meeting at the County Hall, Kingston, on Saturday, May 6th. Alderman W. Welch, J.P., of Cranleigh, presided over a fairly well attended meeting.

Mr. F. B. White, the hon. secretary, was unable to be present owing to illness, and, on the motion of the Chairman, it was decided to send him a message of sympathy and sincere wishes for a speedy recovery.

The Chairman, in moving the adoption of the report and financial statement, observed that since 1896, when the old Surrey Bee-keepers' Association was revived in a new form, it had made steady progress until last year. The decrease in membership was, no doubt, due to the present epidemic, and to the recent seasons, which had been the worst known in the country for a great many years. He was glad to say that several new members had joined the association since the annual report was issued.—Mr. Mann seconded the motion, which was carried.

Mr. Seth-Smith moved a hearty vote of thanks to the County Council for the re-

newal of their grant in aid of technical education in bee-keeping.—Mr. Reid seconded, and, speaking of the good use to which the County Council's grant was put, said that though he travelled all over the country, he knew of no county where so much valuable work was done for so little money as in Surrey.—The vote was carried.

Mr. Bond proposed a cordial vote of thanks to the retiring Executive Council, Joint Committee and officers, for the excellent work they had done under great difficulties. It had been his unfortunate experience to lose all his hives this year.—Mr. Overton seconded, and Mr. Hedger replied.

The following gentlemen were elected on the Executive Council: Mr. Archibald Seth-Smith, Lieut.-Col. J. A. C. Younger, Messrs. C. H. J. Evershed, F. S. Fletcher, W. P. Gornall, G. C. Halaban, W. E. Hamlin, A. T. Hedger, John Kaehler: J. W. Lewis, A. H. Miller, W. F. Reid, W. Sole, E. J. Stevenson, E. Walker, A. Watkins, T. H. E. Watts-Silvester, M.A., M.R.C.S., and F. B. White.

Mr. Reid afterwards made some interesting observations on the bee disease, and the steps which were being taken to cope with it by the Board of Agriculture, who were in very close touch with the British Bee-keepers' Association.

A hearty vote of thanks to the Chairman brought the meeting to a close.—F. B. WHITE, Hon. Secretary.

### LECTURE AT BECKENHAM.

An address on the so-called Isle of Wight disease was given at Beckenham on 18th April, by Mr. A. Schofield, who said that as bee-keepers were confronted with the prospect of having their stocks suddenly and mysteriously wiped out by this mysterious disease, they must be deeply interested in the subject. After alluding to the appearance of the disease first in the Isle of Wight, and subsequently spreading to the mainland with such disastrous results, and its resisting all efforts to stop it, he referred to Dr. Malden's recent address before the B.B.K.A., which, although interesting as giving an exhaustive exposition of the subject, afforded no consolation, as no hope of a remedy was held out, from the fact that infection experiments had only given negative results. Mr. Schofield thinks the questions asked by Dr. Malden indicated that scientists can give little help at the present time, and after mentioning his own disastrous experience, he pointed out that the disease appeared before the bees were closed down for the winter; that they are able to resist its effects for a longer period during the winter months; and that it was directly or indirectly caused by

improper food. With regard to the last he stated that dysentery is usually associated with improper food. He next alluded to the importation of Italian bees into this country, the trade in which had so developed that thousands of queens were imported yearly. The Italian drones bred from these queens had cross-bred with neighbouring blacks to such an extent that there were few pure strains of English bees. As man's interference with nature's scheme is usually disastrous, he thought in this case the delicate constitution of the Italian bees, coming as they did from a hot climate, had so impaired the constitution of the English bee as to make it susceptible to disease, which followed cold and wet seasons. Mr. Schofield thought it was more reasonable to have recourse to a strain from a colder climate, if we wished to strengthen and make more hardy our bees, and if it seemed desirable to introduce fresh blood. Hitherto, all efforts for improvements had been concentrated on the Mediterranean bee, totally disregarding the factors of climate and its possible baneful effects, and this in face of the teaching of history which, in the human race, showed numerous instances of the beneficial result following on invasions from the North, which could not be given of similar outbreaks from the south. Mr. Schofield said he believed the hybridisation of the British bee to be indirectly responsible for the Isle of Wight disease, by reason of the racial difference, which, being in the wrong direction, tended to weaken the stamina of the native bee. He suggested that Parliament should be petitioned to withdraw the clause allowing the importation of foreign bees by post, and that queen-breeders should be urged to rear queens from the Old English strain, which is still obtainable in some places. He was convinced that Isle of Wight disease is acute dysentery, and as we had had two exceedingly bad years, bees had perished wholesale from this cause.

## AMONG THE BEES.

### CRITICISMS.

*By D. M. Macdonald, Banff.*

I deal with critics, as a rule, with reluctance, because a wealth of more profitable matter is always waiting treatment, but marginal marks on last volume and the current one, have been accumulating, and have to be wiped out.

1. On page 109, vol. 38, Mr. Crawshaw writes: "Figure what it would mean to count 729,000!" Why, nothing is easier. In these days of mental gymnastics in arithmetic boys before entering their teens can find the value of 9<sup>5</sup>. Pick up the nothings, and there you have it, 729,000!

2. On page 110, I commended an aesthetic editor for adorning his front page with pleasant pictures. I discommended an unaesthetic editor for not "adorning" his hives by painting them. Why should *inverted brains* be necessary to comprehend my meaning. It should be patent even to a blind man.

3. L.S.C., on page 149, gaily imagines me placed in the pitiable plight of being ground by a "Miller," between the upper and the nether millstone; but instead of grounding me to powder, or crushing me to pulp, the genial doctor later on favoured my views, and granted that in like circumstances he would carry them out. I don't feel a bit "crushed!"

4. It was not intended that my words on page 394, regarding the construction of comb, should convey the idea that the whole force of bees some 50,000 could be engaged in comb-building at the same time, as "Cappings" implies, page 460. A multiplicity of other labours would reduce the builders to less than half the force at least. I would not condemn the saw cut, and for most bee-keepers dove-tailed frames serve the purpose best.

5. Honey prices are dealt with on pages 500, and 78 current volume. Note in first my ideal retail price is given as 1s., not 8d., at which low price it was selling to the disadvantage of the up-to-date bee-keeper. I think the cents got transposed, so the conclusion holds good. Butter has nearly doubled in price here during the last quarter-of-a-century; honey has come down in proportion. In regard to colour and choler, I gave my experience. If it does not tally with that of others the result is nothing new.

6. My statement on page 486 in regard to generation is literally correct, inasmuch as no further intercourse takes place. Don't read into it something I never said, please, as is done by a writer on page 187.

7. Dr. Miller joins my friend from Maldon in deprecating my use of the term *nuclei forming*. Will this make it plainer? I did not speak of forming nucleus hives—nuclei there would be manifestly wrong. I wrote of forming nuclei—something that I could form; that I did form. From one nucleus, I proceed to form several nuclei—not the hives, they were supplied by the appliance dealer. How could I be plucked for writing so obviously plain a statement, in the tersest possible form of words, unless the examiner should be the one who so delights to pick holes!

8. Gamaliel I find from my dictionary was one of the most "distinguished (bee) men of his time," his views were "tolerant and large-hearted." This admirably suits Mr. Crawshaw. I am not fitted physically, as he knows, to take the part of Saul No. 1, but I am well

content to adopt the rôle of Saul No. 2, and sit at the feet of any one who can teach me more bee wisdom. At the time too it was absolutely correct. He was a first-class expert. I was not.

9. Mr. Woodley recently unearthed *one* Scotsman opposed to legislation for suppressing bee diseases. He must be a *rara avis*. I know of one apiarist (no he merely keeps bees!) who does not believe in associations, who thinks no other man in his parish should keep bees, who considers he could run the BEE JOURNAL better than any man who ever tried it. Can the two be one?

10. Mr. Samways's contributions would be welcomed more frequently, as they are generally very well worth reading, but on page 378 he seems to have gone in for special pleading, and so produces weak arguments. First let me say I am not one of the duellists on the question of legislation, simply because I never saw an *argument* on the other side worth trying to confute. We have a few stock phrases reproduced with "Blessed reiteration." All I have done is to record from time to time, the views of others, and, parenthetically, add a word or two of my own to elucidate or emphasise. The sixpence fine paid by the Otaki boxhive men is a weak argument, surely. They could scarcely have whined over the amount, but, even if they did, bee-keeping was bettered by the magistrate doing his duty. I am informed the surrounding bee-keepers blessed him for thus aiding them in suppressing disease. In the same way the "poor Irishman struck by the mailed fist," deserves no sympathy. Rather let us bestow what we can spare of that rather scarce commodity on the "ninety and nine" who needed no compulsion in doing their duty. If Mr. Samways saw some of the devastation lately produced by disease, I think he would *pray* for legislation if he is the man I take him to be.

(11) Mr. Bullamore, dear reader, was hit, page 128; Mr. Bullamore hits back, page 187. He marks me down as a "Northern man of prejudice." That is merely "Eccles' Vein!" The critic looks on what he estimates as intelligence in himself as *prejudice* in his opponent. To show my large-heartedness and wide-mindedness, I will meet him this far. I will discard all prejudice and adopt his shaky theory when he gives us even a shadow of proof to show that the acute intelligence of the Italian bee leads it to eschew deleterious trash, which the presumably more obtuse brain of our native bee leads it to indulge in to its undoing—*but not till then!*

Mr. Bullamore seeks to place an extinguisher on me in [8155], but it does not fit, as I see daylight all round. Let me, therefore, deal with his points seriatim. (1) He robs Mr. Gray of the credit of his so-called discovery in 1909 by transferring the claim to Mr. Woodley in 1905, but I do not believe the latter will lodge a claim, asking us to include that as one of the very many benefits he has conferred on Beedom. Personally, I never set up a claim, although I practised it in 1900. I can go back much further for a knowledge of the art, but, *cui bono?* (2) "Kirby and Spence" makes admirable reading, but I don't think I quoted "Entomology" as an authority of weight on honey dew. Critics would greatly oblige by naming page when quoting. (3) As noted above, a meaning is read into my words on generation, which they will not bear. A favourite device of some critics is to set up a bogey to knock down, thinking thus to destroy the original. (4) I never said the McEvoy system included disinfection (another side issue), but I said, and repeat it, that *as practised in New Zealand*, it does. Dr. Miller and Mr. Woodley might also note the words I have italicised. The Bulletin, as I have repeatedly shown, does advise disinfection, so does the Report on Apiculture; and they practise it in the Government apiaries. Recently, Mr. Hopkins wrote me strongly in its favour, and in letters to bee papers the other day he repeated his belief in its efficacy. *The Australasian Bee Manual* (1911), page 139, recommends disinfection, even though "Mr. McEvoy himself contends there is no necessity." This should surely be the last word on this subject, which is being kept up *ad nauseam*. (5) Has my reading of bee literature really been like water running into a sieve? Alas, my poor readers, if this is so! But I think not. And as proof, I may refer to "Fifty Sting Cures," "B.B.J.," page 452, 1908, where salt is given as a cure and accorded an important recommendation; and also to April "Record" of last year, where my article deals with "Salt in the Apiary," wherein I give it as a cure "as valuable as any of the group." Might I respectfully ask critics to read before they write.

Now, please turn to [8114], page 115. Does Mr. Bullamore really mean us to believe his statements in paragraphs two and three? If so, he has knowledge about our honey which we benighted "Northerners" never heard before. In a few sentences he makes six statements, the full truth of which I am not prepared to accept without further evidence. A wide and lengthy experience among the heather compels me to doubt—but that may be only the effect of my *prejudice!*

## NECTAR-PRODUCING PLANTS AND THEIR POLLEN.

By Geo. Hayes, Beeston, Notts.

(Continued from page 163.)

### No. 7. THE BLACKBERRY OR BRAMBLE.

(*Rubus fruticosus*).

NAT. ORDER. *Rosaceæ*.

This plant varies in its growth and peculiarities to a very marked degree, so that it is impossible to give any hard and fast description of it.

It is readily recognised by most people, while to the botanist, perhaps, few plants are less readily identified, owing to an excessive multiplication of supposed species, and the passing of one imperceptibly into another. Certain broad features are apparent, and enable anyone of ordinary intelligence to say that the plant before him is a blackberry, while many minor features become visible on close and attentive study. The one simple Bramble becomes a very Proteus amongst plants, and develops into a large number of species. "The British Flora" (8th ed.) admits six species, but "Babington's Manual" (8th ed.) distinguishes no less than forty-five.

We shall not enter into all these botanical distinctions, but take what may be called the ordinary type—*Rubus fruticosus*—for description.

The root stock is perennial; from this the flowering stems are produced; these latter are ordinarily biennials, and grow woody in substance. Though usually shooting upward, and maintaining the erect position, they will at times be found rather straggling or prostrate. The stem, which is generally five-sided (pentangular), though the angles are not always clearly to be seen, is lavishly furnished with prickly hooks, whose powers are very well known to those who have essayed to "go a blackberrying."

A beautiful and delicate lilac bloom is often found on these stems; at other times

it may be a delicate pink, or pale-greenish-grey.

Where the stem is angular, it will be found that the prickles, abundant as they are, will only be met with on the angles themselves.

The leaves are usually composed of three to five leaflets, the two or four lower ones inserted together at some distance below the terminal one, and not only is the leaf-stalk, but also the mid-rib of the leaves on the lower surface, armed with sharp, strong, hooked prickles; while the general under surface is more or less downy.

The blossoms are either white or varying degrees of pink, in panicles at the ends of the branches. The petals, five in number, are of a delicate satin-like texture; and as they surround a mass of deep yellow anthers in the centre, make a very beautiful flower.

The fruit is almost as black as its name implies, for, when ripe, it is so deep a purple, as to appear almost black.

The Generic name *Rubus* was bestowed by Linnæus, and is supposed to have been suggested by a Celtic word *reub*, to tear. The specific name does not, as some might imagine, mean fruit-bearing. It is a Latin word meaning bush or shrub, and refers to the

bushy nature of the plants.

This is another of the many useful plants for the bees, yielding freely both nectar and pollen.

The colour of the pollen is almost white when dry, and ovoid in form, the flutings in the grain being wide, closely approach the oval form, and from this cause, when viewed in its dry state, it appears in a variety of outline forms. The size varies considerably, some grains being quite double the size of others. The average size, however, is  $\frac{11}{1000}$  in. by  $\frac{3}{1000}$  in. when dry, but when taken from honey or water, are of an almost spherical form, measuring generally  $\frac{1}{1000}$  in. by  $\frac{1}{1000}$  in. When viewed by transmitted light they

#### 1. Dry.

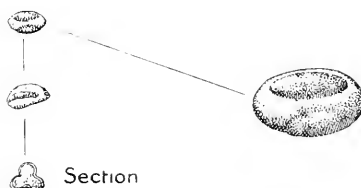

#### 2. In Water.



#### 3. From Honey.

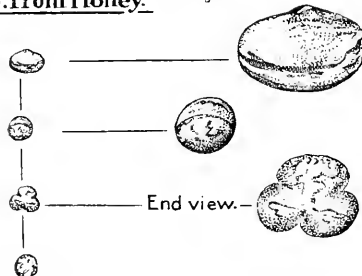

POLLEN OF BLACKBERRY.



are of a pale yellow colour; and almost transparent.

The illustrations in this case explain themselves.

(To be continued.)

## Correspondence.

*The Editors do not hold themselves responsible for the opinions expressed by correspondents. No notice will be taken of anonymous communications, and correspondents are requested to write on one side of the paper only and give their real names and addresses, not necessarily for publication, but as a guarantee of good faith. Illustrations should be drawn on separate pieces of paper. We do not undertake to return rejected communications.*

### FOUL BROOD LEGISLATION IN NEW ZEALAND.

[8170] Allow me, Mr. Editor, to thank you heartily for completing the sentence in my letter to *Gleanings*, only partly quoted by Mr. Herbert Samways (page 86, 2nd March), with the evident design of conveying an entirely wrong impression regarding the working of our Apiaries Act.

It is very interesting, but rather droll, that objections to our Apiaries Act should come from one who is not affected in any way by its provisions, while not a single word against it is heard in the country where it is in force. In fact, I may state without fear of being contradicted, that there is not a bee-keeper from one end of the Dominion to the other, including former box-hive men, who does not look upon the Act as the saviour of commercial bee-keeping in New Zealand.

In quoting the New Zealand Commissioner's words, Mr. Samways has merely said "draught act," why not honestly quote the full sentence, or the paragraph which explains the beneficial effects of the Act?

Then again, Mr. Samways infers that a foul-brood Act was not thought of in 1907, because "in the contents page of Bulletin 18, Bee Culture, dated 1907, foul brood is not even mentioned." Really Mr. Editor it tries one's patience to have to correct such writers, and were it not that I wish to assist those who are honestly endeavouring to improve British bee-keeping I would not take the trouble.

If you, sir, refer to my Bulletin No. 5 (a copy of which I am posting you) dated May, 1905, you will there see (pages 12 to 18 inclusive), what I had then to say on foul brood and the need of legislation. As this bulletin was current when No. 18, which Mr. Samways refers to, was published, there was no need for me to include a chapter on foul brood in that.

Before concluding, I will draw your attention to page 17, Bulletin No. 5,

wherein it supports what Mr. D. M. Macdonald has contended for, viz., that I recommended modification of the McEvoy treatment, and this modification was chiefly in the direction of disinfecting foul broody hives.—L. HOPKINS, Auckland, New Zealand.

[The chapter alluded to by our correspondent in Bulletin No. 5, is on "Foul brood and its treatment," and on page 13 it is stated that "It is absolutely necessary and just that the careful bee-keeper should be protected from his careless neighbour, and the only way this can be done is by State legislation, which shall control and compel the careless man to take steps as will prevent the propagation and spread of disease in and from his apiary." This clearly shows that so far back as 1905, legislation was strongly advocated. After describing the different ways of treating foul brood, Mr. Hopkins says on page 17, "I have full confidence in recommending to our New Zealand bee-keepers the following modification of the McEvoy treatment." He then explains how it is to be done, and concludes by saying "I certainly, in all cases, strongly recommend disinfecting hives, and other implements that have been in contact with diseased colonies." This is sufficient proof that the McEvoy treatment as recommended in New Zealand does include disinfection, and we hope it is conclusive enough to end the controversy over this question.—Ed.]

### WEARDALE NOTES.

[8171] The bee season in this part of Durham, opened with cold, wet weather, which has continued till the last few weeks. Bees are, therefore, generally in a backward condition, for the last week of May.

I have not heard of any local swarms yet, but the present hot weather will bring stocks on rapidly, and there will, no doubt, be an epidemic of the swarming fever during June.

The "May" blossom seems to be very early in bloom as it is now in full flower, which is not generally the case till June, at least this has been so for some years past. Our main flow is from white clover, and it behoves bee-keepers to keep their stocks strong, to take advantage of it when it comes, as the time they can work on it is only short. A good deal of useful work can be done now in preparation for swarming-time.

If increase is desired, all empty hives should have the roofs made water-tight, and the whole hive well painted. Frames should all be fitted with full sheets of foundation, and the hive, or hives, placed on the stand they are to occupy. As

soon as the expected swarms are hived, they must be fed liberally for the first few days, when they will quickly draw out the foundation and build up a strong colony in time for the heather.

If the queen heading the swarm is known to be past her prime, a young one can be run in when hiving it; care must be taken to secure the old queen before doing so.

I am glad to say the "Isle of Wight" disease has not made its appearance in the dales, and foul brood is practically unknown. A few energetic bee-keepers have started an Association for Weardale, and a fair number of members have enrolled. We are hoping that it will prosper, and give new life to bee-keeping in this part of the county.

It is our intention, if possible, to have lectures on the best methods of bee-management, and also practical demonstrations at different members' apiaries.

Those who have a few hives are cordially invited to join, "The Wear Valley and District Bee Association;" this embraces the whole of the Western portion of Durham. Trusting all brother bee-keepers will have a good season during 1911.—W. S. WATSON, Southview, Wolsingham.

#### REMOVING A SWARM FROM A CURIOUS LOCATION.

[S172] It may interest some of your readers to hear how a swarm was removed from a lamp-post by the writer and two other students of the Horticultural College for Women, Swanley. A message came to the College on the evening of May 16th, asking if any student could come and give assistance as a swarm of bees were in the grounds of the Farningham Boys' Homes. No one there knew anything about bees, and they wished to obtain the swarm. It was then too late to do anything, so we promised to go over next morning. We arrived on bicycles with veils, smoker, carbolic cloth, &c., at 8.30 a.m., to find a crowd of excited people gazing up at a tall street lamp-post, the top of which was swathed in muslin. Inside was a small cluster of bees, but the majority had gone down a tiny hole round the gas-jet, right into the standard. We first obtained a ladder, and tied a half-peck basket round the top of the lamp, keeping the light out with coats, &c., and put syrup inside to entice the bees up, but all to no purpose, and as we were in a hurry to return to the College, something had to be done quickly. Pickaxes were procured, and the bottom of the lamp-post was undermined. The bees began to pour out, and we hoped they would continue to run

through into a peck basket we put there; presently they ceased to move, and were not affected by drumming the sides of the standard. A plumber was then fetched to bore a hole in the middle of the shaft for us, a good stream of bees came through it, settling round the top of the lamp, meanwhile we kept a sharp look out for the queen; suddenly one of my fellow-students saw her run out on the ground, and caught her. We put her in a match-box inside the basket at the top of the lamp, and the bees began to collect there. Meanwhile, we loosened the gas-pipe inside the standard, and drew it carefully up. Pieces of comb were already built round it, showing that the bees intended to make this their future home, and hundreds of them were clinging to the side.. Looking down the standard, we saw it was still lined with bees. We got a long rubber tube, and put it up the standard and smoked through it, but this only seemed to stupefy the bees, and not to stir them. There seemed to be no way of moving them, when a brilliant idea occurred to us. We took a long string, which we weighted at one end, and dropped it through the hole at the top of the standard. When it came out at the bottom, we tied a carbolic cloth on to the end, and drew it slowly up. This was most effectual, and in a short time all the bees were up in the basket.

In the meantime, we thought it best to release the queen into the basket. This we did, and sprayed the flying bees with water, which caused them to settle. We next arranged a hive in a suitable corner of the garden; as we could not stay longer it was necessary to hive the bees at once, in spite of its not being a good time to carry out this operation. We shaded the hive with an umbrella, and when all was ready, threw the bees in front, putting some handfuls close to the entrance, and syringing water round to keep them from flying. The rest of the bees began to pour in as fast as they could, until nearly all were in. We then noticed they were very unsettled and excited. On inspecting the last cluster of bees, what was our dismay to find the queen in the centre, half-dead, whether from injury caused by her subjects or by ourselves, we do not know. Our only hope was to put her in as she was and secure the bees with muslin over the entrance of the hive.

We inquired if there were any bee-keepers near, but could not hear of one nearer than four miles. The wagonette was hurriedly got ready, and off we drove. The cottage owner was most willing to help, and allowed us to overhaul his single hive, and take what we liked. The stock was very strong and healthy, so

we took a good frame of eggs. This we wrapped in flannel and drove triumphantly back, and put it in the new hive. We then collected a few more bees which had gathered round the lamp, hived them successfully, put a feeder full of syrup on and left the bees humming contentedly, and already forming chains across the frames and fanning at the entrance. We hope they will rear a new queen, and do well. We were unable to avoid killing a small proportion in digging and driving them out of the lamp. There are, however, enough to make a good stock with proper attention. There is just a chance of there being another queen, for though the one we found was old, there were so many young bees that a cast may have united with the swarm. The bees were marvelously quiet, veils were not worn at all, and amongst the people standing round, and others passing by, we had only three stings caused through our inadvertently squeezing an unobserved bee in working them out of their extraordinary location. The keenness of the owner and all who assisted was most exhilarating, and it promises well for the success of the future apiary.—HILDA HASLUCK TURNER.

[The above shows how the teaching in all branches of the work at this, the first college of its kind (which even now holds premier position), is so thorough that it enables the students to carry out difficult and unique operations at a moments notice in a most satisfactory manner. Swanley College also has the distinction of having supplied the Government apiarists to New Zealand, and the Orange River Colony. Incidentally the action of the cottager-bee-keeper is an instance of the readiness with which the members of the craft help one another. It was indeed an unselfish action to allow a frame of brood to be taken from a colony at this vital time of the year by absolute strangers.—Editor.]

#### A GOOD REPORT FROM EVESHAM.

[8173] Being a touring expert in Worcestershire, I thought it might interest your readers to hear how bees are faring in this part of the country. I have finished my spring tour, and taking all things into consideration, found the bees are in grand condition. Several hives have two racks of shallow frames or sections nearly completed. The bees have had a grand time working on the plum and apple blossom around Evesham, and have built-up very rapidly, especially where the queens were young. I, myself, have taken two racks of sections off containing twenty-one in each, and one rack

of shallow frames. Naturally, round the district, I found many gaps through starvation, in cases where the bee-keepers never troubled to find out whether the bees had enough stores to last through March and April. The first swarm that I heard of came off on May 5th from a skep, of which there are still a great number kept among the villages. I have not found any trace of "Isle of Wight" disease (and don't want to), in this district.—W. J. WOOLLEY, Expert to Worcestershire B.K.A.

#### POSSIBLE CAUSES OF DISEASE.

[8174] With our esteemed Editor's permission, I should like to make a few suggestions, for the consideration of my compatriots in bee-keeping, with regard to the new disease that is now affecting an industry, in which I, with others, have found great pleasure and increasing interest for the last thirty years. Although the new disease has not come my way yet, I have an occasional loss from foul brood, for which I am indebted to some of my careless and negligent neighbours.

I have read all that Dr. Malden has said on the subject of the "Isle of Wight" disease as reported in the "B.B.J.," but what has struck me forcibly is the absence of questions as to the means and methods we, as bee-keepers, are pursuing. Is there anything in our practice that is responsible for this disease?

If a general loses a battle the first thing is to enquire into the weakness that has brought about the disaster, so I would like to place before the readers of the "B.B.J." a few queries, and I have no doubt our Editor would be willing to allow the enquiry to be carried into the region of practical bee-keeping.

First as to feeding: For the past twenty years feeding has been resorted to very much, no doubt, owing to the growth of utilitarian ideas with bees as in other departments of our life. The question about everything is, "Does it pay," and with many bee-keepers' feeding their bees after depriving them of most of their natural store, feeding is a necessity. The question arises: should artificial feeding be resorted to as much as it is, and is it harmful? No doubt, pure sugar is the best substitute, but it is not honey. Then there is the question of the purity of the sugar on the market. In a town near me there are about a dozen grocers, and from only one can I get a sample of cane sugar, and that of very impure quality, so that I have to send to London for a consignment. Grocers will not stock it because it is dearer. The demand for cheapness brings into the market an inferior quality of beet-sugar, which, I fear, many

unwary bee-keepers buy, and when this has the additional chemicals added to it, as per recipes for candy cake or syrup with what no one knows of in the process of manufacture, it must be an unwholesome food for the bees, tending to a weakness of constitution and vigour. A few years ago I entered a shop where there were exhibited eight samples of sugar in a glass case in front of the counter in four different sized granules—four white and four golden yellow. I took one sample of the golden yellow third sized granules, and placing them in a glass of water, found the water puddled and the granules at the bottom white, minus the gloss and colour. None of our articles of food are adulterated so much as our sugar products, which are such important articles of consumption; but what has that to do with the "Isle of Wight" disease, some will say. Much of the sugar used in feeding the bees is questionable, the difference between the two sugars may be small, and may lead some to quibble about it, and think it scarcely worth noticing but we must remember that in the hive we have thousands of infant lives that need wholesome food, and if unsuitable or unwholesome food is given to them, the result must be prejudicial to the health and activity of the bees.—J. Brown, Launceston.

(To be continued).

---



---

## Queries and Replies.

---

[4133] *Using Swarm Catchers.*—I have a "Brice" swarming appliance, and shall be obliged if you will say how I may tell, without taking out the frames, when to fix it to the hive. I put on a super a fortnight ago and although the bees crawl about the bottom of the sections, they have stored nothing in it. A few days ago they opened another entrance into the hive, and now they stand all along the threshold fanning. Does the excluder zinc hinder their progress to any great extent? I suppose it does, as otherwise, the swarm-catcher might be kept in position the whole year round.—E. F. L., Lee.

REPLY.—Like all swarm-catchers the "Brice" does hinder the bees a little. If you keep it on till the bees are working well in the supers, it will be long enough. When taken off give ample ventilation by propping up the lower chamber, so that a current of air passes underneath the hive.

## CAPPINGS OF COMB.

BY L. S. CRAWSHAW, NORTON, MALTON, YORKS.

*Isle of Wight Disease* (page 131).—I am more than pleased to see the stand taken by our Journal in this matter. At the beginning of the trouble, many of us, myself included, thought that the Journal was a little slow to appreciate the importance of the outbreak. But the present appeal to beekeepers to co-operate with all the information in their power is in the nature of an *amende honorable*, and should meet with a loyal response, so that we may be better equipped to face the scourge. I am also glad to note that justice was done by Dr. Malden to Mr. Cooper's efforts in this direction.

*Quilts and Waxmoth* (page 143).—It is doubtful whether Mr. Mason's theory that quilts are responsible for increase of waxmoth will bear investigation. The happy hunting ground of these folk would seem to be the straw skep, which is quiltless (I hope that "Mr. Printer" will not render that "guiltless"). What is probably more true is that our artificial dwellings provide more crevices near the edge of the combs where the larvæ can lurk. And quilts help the matter by covering the top bars of the frames, particularly so in that style of frame with the abominable central sawgate. But quilts, that is to say, good quilts, made of Brussels carpet, are not in themselves favourable haunts. After all, the waxmoth existed before quilts were thought of.

*Bee Lectures* (page 144).—If this statement of the average attendance at lectures in the County of Surrey be correct, and I do not cast doubt upon it, it is a wonderful *average*, and one would like to know how it has been attained. First think of an average of 250 at 33 lectures. Yorkshire and Lincolnshire come next with a few lectures and about a fourth of the average.

*Propolis* (page 151).—This is a new and somewhat startling pronouncement. If true, one would expect to find propolis abundant in the spring when pollen-gathering is rife. This is the case, but it is also collected freely in the autumn, when less pollen is collected. I have noticed, or have thought so, in connexion with moor-going stocks, that propolisation has been considerable when the hives were within flight of pine trees, and that the trouble has been inconsiderable when away from trees. If this be true, does it not weaken the argument. That bees are not confined to pollen for the source of their "propolis" is known, for they have been noticed to attack varnish and similar substances. I have not read the monograph, so am not in a position to criticise, but it should be possible to check or confirm that part of the theory which deals with its introduction into the hive. Again, is the colour of the propolis related to that

of its particular pollen? If so, one would expect to find virgin comb coloured like Joseph's coat, as the pollen source varied. Whereas, with such notable exceptions as that of sainfoin, we do not find this to be the case. Also, districts would seem to vary in the supply of propolis. Dr. Miller of Marengo, Ill., records that his district is exceptionally bad. Yet there is no lack of pollen in other districts. Is it possible that his strain of bees is at fault? What are the explanations?

*Painting Hives* (page 155).—It is possible that W.A.C. refers to graphite paint. This is advertised as having greater flexibility and adhesive property than lead paint. I have not tried it for painting wood, but have used it for ironwork with satisfaction.

*Bees and Smoke* (page 155).—There is no doubt that the bee which investigated the "smudge," thought it had discovered the enemy who recently breathed into its home, and prepared to have its blood whilst the said enemy slumbered.

*Isle of Wight Disease* (page 166).—Perhaps Mr. Stapleton would give further details of what he means by breeding out the disease. For what is possible in Cornwall is also possible in the Isle of Wight. Does he mean that the disease loses its virulence? or that the surviving bees are better able to resist it?

*Early Drones* (page 166).—Will Mr. Ernest tell us whether the queen proved to be a drone layer? Such cases are of more than ordinary interest. It is possible that a wintered virgin might lay eggs in drone comb of set purpose. I have not known such a case, but evidence to the point would be of value.

## Bee Shows to Come.

**June 26 to 30, at Norwich** (Royal Agricultural Society's Show).—Bee and Honey Section under the management of the B.B.K.A. Prizes arranged in groups of counties for Associations affiliated to the B.B.K.A. Schedules from W. Herrod, Secretary, B.B.K.A., 23, Bedford Street, Strand, London, W.C. **Entries closed.**

**July 13 and 14, at Brigg, Lincs.**—Lincolnshire B.K.A. Great Show of Honey, Hives, and Appliances, at the Brigg Exhibition of the Lincolnshire Agricultural Society. Valuable prizes offered in Open Classes for Trophy, Extracted, Granulated, and Comb Honey, Observatory Hives, Bee Appliances and Hives. Schedules, &c., from Mr. J. H. Hadfield, Alford, Lincs. **Entries close June 9.**

**July 19 and 20, at Stafford.**—Honey Show in connection with the Staffs. Bee-keepers' Association. Four open classes. Schedules from Joseph Tinsley, 22, Granville Terrace, Stone, Staffs. **Entries close July 10.**

**July 26 and 27, at Cardiff.**—Annual Show of the Glamorgan B.K.A. in connection with the Cardiff and County Horticultural Show. Separate tent for honey, wax, and appliances. Open classes. Special prizes. Schedules from Hon. Sec. Mr. Wiltshire, Matndy School, Cardiff.

**July 27, 28, and 29, at Rotherham.**—Show of Hives, Honey, &c., in connection with the Royal Yorkshire Agricultural Society. Schedules and Entry Forms from Secretary, Blake-street, York. **Entries close June 17.**

**August 3, at Weston-super-Mare.**—Annual Show of the Somerset B.K.A., in connection with the important Local Annual Flower Show. Classes for Appliances, Honey, Wax, and Bee Products. Several open and free classes. Liberal prizes. Numerous attractions. Excursions from all parts. For Schedule, &c., apply to T. Jones, Assistant Show Secretary, North View, Milton-road, Weston-super-Mare. **Entries close July 29.**

**August 23, at Radstock, Somerset.**—Honey Show in connection with the Radstock Horticultural and Farmers' Association. Open and gift classes. Write for Honey Schedule. B. M. Clark, Foxhills, Radstock.

## Notices to Correspondents.

W. H. (Kent).—*Young bees cast out.*—

We have frequently known cases of brood being cast out of hives short of stores, at a time when nectar from outside was not available, but as in your case the hive was well provided with stores, this cannot be the cause. Sometimes when a stock is troubled with wax-moth the larvæ will burrow under the cappings of the brood, and the bees will then uncapp the brood in the manner you complain of. We shall be glad to have further particulars.

C. C. (Haddington).—*Wild Bees.*—The bees are specimens of *Andrena fulva*, a wild bee common in spring.

ENQUIRER (Suffolk).—*Failing Queen.*—The cause of the failing is either age, or the queen has been injured while fighting with a rival; the latter is probably the true solution as her wings are badly torn.

E. A. H. (Dartford).—*Drone brood cast out of Hive.*—The probability is that during the cold spell experienced on the 20th and 21st inst., the brood was chilled and the bees have simply turned out the dead.

### *Suspected Disease.*

FRANCIS (Torquay). 1. Comb is affected with foul-brood of long standing. 2. It will be quite safe to use the hive if you scorch it thoroughly inside with a painter's spirit lamp.

J. A. (Kirkby Stephen).—The bees are badly constipated, there is also dislocation of the wings, and the other symptoms you mention are suspicious signs of "Isle of Wight" disease.

W. A. C. (Somerset).—The bees are suffering from constipation, and this has no doubt caused their death.

S. F. (Truro).—We are sorry we cannot tell you the cause of death. We have reports of a number of similar cases which we are investigating. (See reply to W. H., Kent).

R. D. (Essex).—The brood is chilled only, there is no sign of any disease.

BEGINNER (Cardigan).—Both combs are affected with odourless foul-brood.

A. S. (Wilts).—Brood has been chilled.

**Special Prepaid Advertisements****Two Words One Penny, minimum Sixpence.**

Orders for three or more consecutive insertions entitle advertisers to one insertion in "The Beekeepers' Record" free of charge.

Trade advertisements of Bees, Honey, Queens, and Bee goods are not admissible at above rate, but will be inserted at 1d. per word as "Business" Announcements, immediately under the Private Advertisements. Advertisements of Hive-manufacturers can only be inserted at a minimum charge of 3s. per ½ in., or 5s. per inch.

**PRIVATE ADVERTISEMENTS.**

**F**OR SALE, 4 dozen 1lb. jars, mostly heather HONEY, from Quantock Hills.—HAWKINS, Aisholt, Bridgwater. j 76

**T**WO February-hatched PULLETS and COCKEREL, white Wyandottes or buff rocks, bred from finest layers obtainable. 8s.; Queen Bee, 1910, 2s. 9d.—ALUN JONES, Brynawel, Halkyu, Flintshire. j 75

**20** NEWLY-PAINTED Standard Bar-frame Hives with 11in. outer case, 9in. lift, brood chamber, floor board, and zinc-covered roof, on rail, 26 the lot; or 6s. 6d. each.—J. P. IRELAND, Vernham, Hungerford, Berks. j 77

**N**ATURAL SWARMS from Bar-framed Hives, guaranteed healthy, 10 June 7th 15s.; after, 12s. 6d.—WILLIAM DENNIS, Brownover, Rugby. j 67

**G**UARANTEED healthy, 4 strong Stocks of Bees for sale, supered, in W.B.C. Hives, 2 lifts, 2 supers, excluder zinc, all complete; overstocked. What offers?—J. RIMMER, 51 Sunny-rd, Southport. j 68

**W**ANTED, Second-hand Nuclei Hive, for Queen rearing, 4 or 5 divisions, good, clean.—REV. BUCHAN, Kilbirnie. j 69

**H**EALTHY SWARMS FOR SALE, May, 3s.; June 2s. 6d.—F. H. BUCK, Wimbish, Saffron Walden. j 70

**W**ANTED, GOOD STOCK, or SWARMS, in exchange for 66 sixpenny parts of Cassell's History of England, 8 volumes unbound.—WHEATLEY JUN., Spa, Huckleley. j 71

**2** SLADEN'S TWIN NUCLEI HIVES, new, complete, folding frames, cover, &c., price 5s. 6d. each, or 10s. the two f.o.r.—SINFIELD, Upper George-st, Luton. j 68

**P**REPARE FOR SUPERING.—Racks of Sections fitted starters, ready to put on, to hold 18s. and 2s., 1s. 6d. and 1s. 9d. each.—LITMAN, Castle Cary. j 72

**W**HAT OFFERS?—6 Cottager Hives, used one season only, each containing floor board with legs, brood chamber with movable porch, 10 frames, dummy, 6in. lift, crate of 21 1lb. sections (unused), Queen excluder, quilt, roof, painted 3 coats; large meadows honey ripener, used once, with strainer, lift and lid; Sladen's double Baby Nuclei Hive, with folding frames, used once.—F. E. MATTHEWS, Coton Apiary, Northfield, Birmingham. j 73

**S**URPLUS COMBS.—A few racks good, clean, healthy, drawn out shallow Combs for sale. 4s. each.—A. GREEN, Tangley Estate, Andover. j 74

**S**TRONG, guaranteed healthy, Swarms, 10s. each, 5lb. upwards, 2s. 6d. lb.; boxes returnable; cash with order.—R. WHITTING, Manca, j 78

**T**WO 4-frame Nuclei, 1911, laying Queens, 15s. each, packed free; also new Hives.—BOWDEN, Broomhill, Witley, Surrey. j 80

**C**LEARING cheap, Frames, Sections Foundations, &c.; list.—65, Raleigh-road, Richmond Surrey. j 81

**F**OR SALE, 2 Stocks Bees, each on 10-frames, splendid condition. 25s. each; 3 hives, large stock of appliances, cheap.—BEATTIE, Ravensneuk, Penicuik, N. B. j 82

**A**LIMITED SUPPLY of BORAGE PLANTS to flower this summer, 20 for 6d., carriage paid.—HEWETT, Carrington-road, Dartford, Kent. j 84

**Special Prepaid Advertisements.—Continued**

**C**LEARANCE SALE.—W.B.C. Crates, Racks and Brood Bodys, 25 for £1, a few with frames; Queen Excluders, Honey Strainer and Ripener, Extractor (Cowau's 2-frame).—RINGER, The Apiary, Tatsfield. j 85

**F**OUR BURGESS "PERFECTION" W.B.C. HIVES, 18s. each; one double Hive, 18s.; glass quilt, brood chambers and shallow frames, &c., &c., to go with lot; the lot, £5.—"METROPOLITAN," 36, St. Martin's Court, London, W.C. j 86

**B**OOKS ON BEES.—Cheshire's "Bees and Bee-Keeping," 2 vols., 50/-; "A.B.C. and X.Y.Z. of Bee Culture," 4s. 6d., all as new.—METROPOLITAN, 36, St. Martin's Court, London, W.C. j 87

**H**EALTHY NATURAL SWARMS, 12s. 6d. and 15s.—GEORGE BELL, Shoreham, near Sevenoaks, Kent. j 88

**M**AY SWARM in new Hives for sale.—MRS. MANSTRUTHER, Woolston Grange, Williton, Somerset. j 89

**N**UCLEI (4-frame with Queen) in W.B.C. and other Hives, 25s. to 30s. each, complete.—W. H. SIMS, Hall Green, Birmingham. j 90

**S**WARMS on Frames, guaranteed from healthy Stocks, 20s.; boxes returned carriage paid.—F. A. BEAN, Snaith, Yorkshire. j 65

**F**OR SALE, motor cycle, 2½ Minerva, sound engine; Palmer tyres, good condition, Eadie fittings, spares, £10.10.—WILCOX, Northwood, Olton. j 64

**H**IVES and Extracting House from healthy Apiary; also Trophy Stand for sale, cheap.—SPECK, 855 Stratford-road, Sparkhill, Birmingham. j 65

**T**YPEWRITER, Remington, universal keyboard, perfect condition, very clear writer, will last a lifetime, cost £22, sell 80/-; great bargain.—L. WAKEFIELD, Newhall Hill, Birmingham. j 46

**W**ANTED, a few Skeps of Bees, with old and tough combs for driving purposes.—HERROD, "Bee Journal" Office.

**N**ATURAL SWARMS FOR SALE, June 1st to 17th 2s, 5d., after 2s. per lb.—R. ALLEN, Tusmore, Bicester. j 52

**T**WO New Bar-Frame HIVES, with lift and 10 Frames, wired, canvas covered roof, painted, 11s. each. Photo and particulars, HEARD, Orchard Hill, Bideford. h 98

**BUSINESS ADVERTISEMENTS.**

**K**ATA-LOG is the best Ad.; send postcard to old firm.—MEADOWS, Syston. j 85

**D**EEP or SHALLOW FRAMES, ¾ by ¾ top-bar grooved, made up and metal ends, 1s. 9d. doz.; wired, 2s. 6d. doz., carriage paid.—APPLIANCE WORKS, North Square, Dorchester. j 62

**P**RIME NATURAL JUNE SWARMS, 12s. 6d.; Virgin Queens, blacks, 1s. 6d., post free; satisfaction guaranteed.—FOLDS, Church-street, Luton. j 79

**D**OOLITTLE STRAIN OF BEES again on the move. Customer writes:—"Took first prize with your Bees in observatory hive; also first for comb honey. They are now my best stock." Now is the time to order Virgins, 1s. 6d. each (ready); fertiles, book now for delivery in turn, 5s. each. There are no better Bees to be had.—D. TAYLOR, Ilminster. j 61

**I**TALIAN QUEENS, direct from Italy. See complete advertisement in "British Bee Journal" May 18th.—Address, E. PENNA, Bologna, Italy.

**Q**UEENS, fertile, in introducing cage; delivery guaranteed, 5s. 6d.—BRICE'S APIARIES, Otford, Kent.

**T**RANSSPARENT "BEE CONTROL" (Gillies') POCKET CLOTHS and 100 re-charges, 1/-.—GAMAGE, London; BURGESS, Exeter; CROSS, Belfast. Wholesale: IREKING CORPORATION, Dublin. h 79

## Editorial, Notices, &c.

### BRITISH BEE-KEEPERS' ASSOCIATION

#### NOTICE.

Prize cards with the silver and bronze medal of the "B.B.K.A." embossed in natural colours may now be obtained from the Secretary free. Will the secretaries of those Associations who intend to have the medals this season kindly apply for them in good time before their show, so that they may have them to place on the winning exhibits.—W. HERROD, Sec., B.B.K.A.

### DISINFECTING FOUL-BROODY HIVES.

#### IS IT NECESSARY?

By *I. Hopkins, Auckland, N.Z.*

To those bee-keepers at all familiar with the strictness with which disinfection is now insisted upon in all cases of germ diseases by bacteriologists and medical authorities, and how scrupulously it is carried out at all our hospitals, the query at the head of this paper will appear absurd. Yet, in spite of the fact that "foul brood" in bees is a germ disease of a very infectious nature and that all the highest authorities, including bacteriologists, who have specially studied this and other bee diseases advise the disinfection of hives wherein diseased bees have been domiciled, there are some bee-keepers—comparatively few, however—without any special knowledge of bacteriology who insist that disinfection is not necessary. It might be asked, "Why take notice of them?" It is not at all likely they will influence experienced bee-keepers in the least, but they may induce beginners, or others who are somewhat careless in such matters, to neglect carrying out a very important part of the treatment of foul brood, and thus endanger themselves and their neighbours.

Foul brood is caused by certain bacteria which attack and destroy the brood. When once they get a footing they increase and spread throughout the hive at an enormous rate, and if not checked the disease rapidly spreads through the apiary and district. It is well known that one of the chief agencies in the distribution of foul brood germs is the bee itself, as in the case of robbing a colony weakened by disease. After passing through the active stage, that is, when all the substance upon which the bacteria exist has been consumed, they develop into spores or seeds, and remain dormant until, by accident or otherwise, they are transported to some suitable medium, such as the living bee-larvæ, when they again become active and carry on their work of destruction

The spores exist in myriads in the dried scale of each destroyed larva attached to the lower walls of the cells, with which the adult bees are constantly in contact. The spores are so microscopically small that multitudes of them may be carried about by the bees; hence, one of the chief causes of the disease spreading so rapidly. Under these circumstances, it will be readily understood that the spores are as likely to be attached to the sides of the interior of the hives in which disease exists as on the combs themselves.

The inconsistency of those who contend that the hives in question may be used again without being disinfected and without risk of contamination is shown by the fact that they quite agree that the combs and frames from a diseased colony should be destroyed. They recognise that both may and will carry disease, yet the hive, which is in close contact with them and over which the bees are constantly travelling, they claim, can be used again without any cleansing. This contention, on the face of it, appears to me devoid of all common-sense.

A person signing himself "A New Zealand Reader" has lately written to the "Canadian Bee Journal" in a very self-conscious manner, as though he was commissioned to represent the whole of our New Zealand bee-keepers on the subject, ridiculing the idea of disinfection and those who advocate it, and incorrectly stating that it is not practised in New Zealand. Had this writer confined himself to an intelligent discussion of the subject and presented his view of it, not the slightest objection could have been taken, but when a person runs counter to and pretends to know more about the matter than the scientific experts, it is proof of unsound reasoning.

Among those who advise disinfection are Doctors White, Maassens, Burri, Zander, and Phillips, and Professor Imms—all bacteriologists who have specially studied bee diseases, and the authors of all the standard works on bee-culture. I, therefore, strongly recommend all bee-keepers who have to treat their bees to run no risks, but to include as part of the treatment the disinfection of hives good enough to keep, and destroy others by fire.

There can be no doubt that the spores of foul brood can stand, without being destroyed, great heat and cold, and also considerable strength of the usual disinfectants. For instance, Dr. G. F. White, Ph.D., expert in bacteriology, says (as I have stated in bulletin No. 18): "The spores of this bacillus (bacillus larvæ) are very resistant to heat and other disinfectants. They resist the boiling-temperature of water for fifteen minutes. In 5 per cent. of carbolic acid

they were not killed in two months' time. Likewise it has been demonstrated that the spores of bacillus larvæ, when taken from the scales of American foul brood, resist the action of mercuric chloride (corrosive sublimate), 1: 1000 aqueous solution, for two months. Having such facts before us, we can better judge the methods for treatment.'

This goes to show that whatever disinfectant may be used the solution should be strong. T. W. Cowan, author, "British Bee-keepers' Guide Book," and editor, "British Bee Journal," advises for washing hives, floor boards, etc., soluble phenyle, two teaspoonfuls to one quart of water, or Calvert's No. 5 carbolic acid one part, water two parts. This is painted on the hive. For disinfecting clothing, hands, etc., Calvert's No. 5 carbolic acid, 1oz., to 12oz. water, is recommended. Singeing the insides of hives by fire is strongly recommended by many; a painter's blowlamp is handy for this purpose. Before using the solutions, the hives should be scraped and the scrapings burned.

---

#### HELPFUL HINTS FOR NOVICES.

*By W. Herrod.*

*Manipulating.*—The glorious weather of the last few weeks has enabled the novice to gain experience in the handling of bees without fear of harming the colony by chilling the brood. Constant meddling with the whole of the stocks possessed will so disorganise their work that the best results cannot be obtained. I would strongly recommend beginners to set aside one stock for this purpose during the first season. It will, in all probability, ruin it, but it is the least expensive way of gaining practice and knowledge, and will also satisfy the keen desire to be handling the bees while it is novel. The second season finds the bee-keeper more experienced and restrained in the desire to be constantly looking inside the hive, for he will, by that time, fully realise the baneful effects of over-enthusiasm. Before commencing work, have everything ready to hand, also have a definite object in view, if it be only to hunt for and find the queen. The smoker should first of all be prepared, the best kind to use being the "Bingham" pattern. The fuel should be dry and may be either paper, fustian, or touchwood. On no account should tobacco-paper be used, or paper prepared with saltpetre to make it burn; either of these if used ever so little to excess, will kill the bees. If ordinary paper is used a thick felty one should be chosen, as the thin variety refuses to burn properly. The paper should not be folded and then rolled, but torn into strips about four inches in width, then rolled fairly tightly

into a round cartridge, so that the draught will pass straight through, or it can be folded zig-zag fashion into a bundle sufficiently large to fill the barrel of the smoker. Light one end and place it in the barrel of the smoker, with the lighted end downwards. It may seem superfluous to give these minute instructions about so simple a matter, but dozens of times have I seen people fill the smoker, then light the top-end and wonder why it will not burn. If the wind is blowing, hold the lighted match just inside the barrel to prevent it being blown out. Get the paper well alight, and then, if the smoker is kept on end when not in use, it will burn until all the fuel is exhausted. Corrugated paper makes very good fuel, but does not last long. Treat all fuels in the same manner. When finished with, the fire can be put out either by putting a cork in the nozzle, or stopping it with earth by plunging it into the ground. Sometimes one sees even an experienced bee-keeper struggling to get the nozzle on. It will fit quite easily if the seam on the nozzle is fitted over the seam in the barrel. A carbolic cloth may be used instead of smoke. In my experience, smoke is the better of the two, especially in the autumn. A veil should always be worn, if not over the face, it should be on the hat, so that it can be pulled down in a moment if the bees turn vicious. All being ready, blow a few puffs of smoke in at the entrance, putting the nozzle of the smoker close up for the purpose; wait about a minute, to give the bees time to gorge themselves with honey. The roof and lifts can now be removed and placed well out of the way. Turn back a corner of the quilt and blow in a little smoke to drive the bees away from the top of the combs, where they have collected to feed upon the honey which is stored there. Use two quilts, one at each side, and as one is rolled back to take out the frames, the other should be rolled forward, so that only just the frame to be removed is exposed. This prevents chilling the brood, and also stops the bees from flying up. In examining the comb it should always be kept over the hive in case the queen drops off. Should she fall on the ground on account of the comb being held clear from the hive, it is almost certain she will be trodden upon before she is noticed. Turn the comb in the proper manner, *i.e.*, in such a way that the frame is always kept edgewise; if turned flat, the honey will drop out, and in hot weather, possibly the comb also. Replace the comb gently, and avoid crushing a single bee. Stand on that side of the hive which affords the best light, but never in front. Difficulty is sometimes experienced in removing frames from a hive that just holds ten; this is easily



accomplished without damage if the first frame is raised slightly, and the next one drawn so that the metal ends rest under those on the first one; the third frame is then drawn back, so that its metal ends are under those of the second. Ample room for manipulation is provided by this method. In replacing the quilt, do not imprison bees between it and the top bars; they can be driven back by smoke, or putting down and lifting up the quilt very quickly two or three times, causes them to run down out of the way. See that the quilt fits down neatly all round to prevent the escape of bees and also to avoid draughts. The top quilts can be fitted more snugly if the lift is put on before they are replaced. See that the roof sits down properly: put it on without wriggling and banging it; this is bad for the bees' temper. Take hold of the roof on each side at the eave, so that the fingers come out just below the fitting edge, put it well forward, and draw it back (letting the fingers run along the edge of lift to keep it in the right position), until the front edge of lift stops it coming further, now put the raised end down gently when it will fit perfectly.

---

## Correspondence.

---

*The Editors do not hold themselves responsible for the opinions expressed by correspondents. No notice will be taken of anonymous communications, and correspondents are requested to write on one side of the paper only and give their real names and addresses, not necessarily for publication, but as a guarantee of good faith. Illustrations should be drawn on separate pieces of paper. We do not undertake to return rejected communications.*

---

### ROSS-SHIRE NOTES.

#### AN EARLY START.

[8175] The honey season here has begun a month ahead of the usual time. Never before did I put on sections in May, or remove completed ones on the second day of June. They were good sections, fully sealed and scaling over a pound each. The continuance of fine warm weather with the abundant bloom on hawthorn and fruit-trees has put our colonies in fine condition for the main honey flow from white clover. The strong stocks, those covering eleven frames, have been supered with two racks apiece, and had their entrances opened full width to discourage swarming and brood-nest storage. The latter evil was already in evidence owing to honey coming in before bees were strong enough to occupy the supers—some colonies crowding out their queen with masses of pollen and sealed honey. In such cases a full sheet of foundation was given, all sealed

stores bruised, and the brood chamber reversed, thus bringing the dripping honey next the entrance, to be promptly shifted into the "bait" sections above.

*Section-nuclei.*—I generally work a few small mating boxes à la Swarthmore, and always with success. In fact I have given up using full-size brood-combs for this purpose, preferring to get the queen fertilised from the baby-hive before insertion in the larger nucleus. This avoids any broodless interval. Management is of the simplest, so are the appliances. Any small box to hold a couple of sections will do if fitted with a lid, and a small entrance cut on one side. When queen cells are hatching, the mating-box is stocked with a pollen comb, and a section of unsealed honey with all adhering taken from a strong colony. The queen is then run in at the entrance, the latter closed, and the little hive kept in a warm place for five days. After confinement few bees will desert the nucleus when set out, and the queen gets mated quickly—sooner than from an ordinary hive.—J. M. ELLIS, Ussie Valley.

---

### BEEES IN SOUTH AFRICA.

[8176] I only recently became a subscriber to your valuable journal, and I find it very helpful, though the conditions under which bee-keeping is carried on in South Africa differ so much from those in Britain.

I write now with the object of asking you whether anything can be done towards inducing bees not to gather quite so much pollen as they sometimes do gather here. It may be the case in South Africa alone, but I have charge of some seventy colonies in various localities, and, in many of the hives, the amount of pollen brought in seems far more than is necessary. Indeed not a quarter of it is ever used, and the surplus so fills up the combs that the queen cannot find sufficient room for her requirements. I should be glad if your advice on this matter if you think it of sufficient interest.

With reference to Mr. J. L. Taylor's remarks in your issue of the 13th ult., I do not suppose it was intended to convey the idea that the season just over had been a failure in South Africa as a whole. It is a large country, and conditions and climate vary in different districts. In some parts I know that the season has been fairly good—especially on the coast belt from the Cape Province. About fifty miles from here there are fifteen colonies in my charge. There were nine when I took them in hand last November. By dividing and also bringing in swarms from the veld, I made the fifteen which were not in good condition, having been

neglected a good deal. I saw them again in January last, when they had improved considerably, but had not yet stored any surplus. Last month—April—I took off seventy-nine frames (American standard) of sealed honey from the fifteen colonies.—GEORGE MATHIE, Caledon, Cape Colony.

[It is difficult to advise you on this matter, but in this country the plan of placing excluder zinc over the entrance is sometimes practised. This will scrape the pollen from the bees' legs as they enter the hive, but at the same time it will hinder them in their work.—Ed.]

#### A SUBURBAN APIARY

[8177] I am not sure that my funny little apiary ought not to be illustrated and given as a "Home of the Honey-bee." I find that people with gardens as small as mine hesitate to try to keep bees, and I admit that the location of my second hive cost me a good deal of thought. I am half a mile from Camberwell Green.

The first hive, which has been there two years, is on a platform just under a first-floor window, from which all the manipulations are done. It is thus about 10ft. from the ground, and I think a good deal more convenient for the bees than if it were upon the ground in our narrow and overhung garden. This stock nearly died of May sickness last year, but managed to get enough honey to take it through the winter. Now, at the eve of the lime blossom, it has nearly 40lb. of honey in the brood nest, and about six in the shallow frames. I wish it was all in the supers, but as one comb downstairs, if not two, are solid with honey, I shall do some extracting from the brood nest. There is certainly brood on ten frames, but it is sadly circumscribed with honey.

The new stock is at the opposite end of the garden, which is 15ft. wide, and 60ft. long. It was a driven lot last autumn and came through the winter on six frames. They have done nearly as well as the old lot, which wintered on eight frames drawn out.

Down the centre of my narrow garden runs a path, along which my folk hang the washing once a week. At the end is a door used weekly for sending out the dustbin, so the space between wall and path and available for bees is only 7½ft. I erected posts and made a canvas screen round a square of 5ft. 6in. The canvas walls are 5ft. 6in. high, and as the brick walls are higher, the bees fly in over the heads of those who hang up washing or trundle the dustbin. The hive stands outside this enclosure, but the alighting board projects into it through the canvas. It is on a stand 2ft. high, so that the bees clearing the canvas near the opposite

corner have to come in at an angle rather steeper than 45 degrees. Ideally, I should think 45 degrees ought to be the limit, but they seem to manage their steep descent fairly well.

This new lot has now got ten frames all drawn out, and all, I think, with brood on, but the brood patch on each is rather woefully small, because so much honey has been gathered. There must be quite 30lb. of honey, and though the shallow-frame super has been on for a long time, without excluder, and with an inch space round three sides of the sheet below, the bees will not go up. I have just taken a frame partly sealed from the other lot and put it in the middle of the super, so I think this will entice them. So far, both colonies have been good enough not to swarm, and as every ounce of honey made (in excess of requirements) last year was at or subsequent to the lime blossoming, there ought to be something to take off this year. The acacia is strongly out now, and the lime is on the point of opening.—G. G. D.

#### EXHIBITING HONEY.

[8178] "The product of the novices' bees stands an equal chance with that of the more experienced bee-keeper" (so writes Mr. Herrod, in "B.B.J.," page 204). It ought to do, but does it? Hear what "Stingproof" in the "Rural World" says:—"There are few prizes won with non-faked honey." There you have it. The faker, not the bee, decides the question. With the connivance of the judges, he has reduced showing to a farce, and his methods and his product are a blot on an otherwise honest craft. Let the Editor and Mr. Herrod, as leading judges, strike a blow at the faker by disqualifying or ignoring his fraudulent exhibit. Honest bee-keepers will then have a look in, and Mr. Herrod's statement will contain a larger measure of truth than can be attached to it at present. Honey shows will also become true to name, and receive the patronage they deserve, instead of being objects of ridicule.

Although conversant with all the tricks of the faker, I have never exhibited, and intend never to do so, so long as the product of the faker is preferred by judges to that of the bee.—W. H. WHITE, Harlington, Beds.

[Our correspondent makes a serious charge against the honesty of our judges, which is certainly not justified. We do not know who "Stingproof" may be or what qualification he may have for judging, but we are surprised that any reputable paper should allow such a grave imputation to appear from an anonymous writer. No doubt he has been a disappointed exhibitor, and has adopted this method of showing his resentment, but to

say there are few prizes won with "non-faked honey" is not true. The rules of the B.B.K.A. guard against dishonesty on the part of the exhibitor, and the judges appointed by the Council are those on whose integrity they can rely, and they do disqualify or ignore fraudulent exhibits. Many of the County Associations' shows are carried out on similar rules. We have so acted in every case unhesitatingly, and we know other judges do the same. We have attended a great many shows, and, in our long experience, must say that we have not seen the wholesale dishonesty alleged by our correspondent. As he is so "conversant with all the tricks of the faker," his obvious duty is to bring any such cases to the notice of the Show Committees or other authorities, and if he can prove dishonesty we have no doubt that proper action would be taken to prevent anything of the sort in future. To say that, "with the connivance of the judges," the faker had "reduced showing to a farce," is a gross libel, and we challenge our correspondent to prove his accusations. Mr. Herrod is quite right in his statement with regard to novices. Many of them have taken prizes. We judged at a large show last summer when a lady, who had only begun bee-keeping the previous year, won first prize in a good section class. There was no faking, but she had simply carefully followed the instructions given in the Guide Book.—Ed.]

#### CAUSE OF BEE DISEASE.

[8179] I started bee-keeping by buying *one diseased stock*, through which I learned expensively to overcome some of the difficulties in bee-keeping. I have now about thirty healthy stocks, fifteen of which are accommodated in a specially constructed house. Your "B.B.J." has been of considerable help at times, and always a source of pleasurable reading. Recently the so-called "Isle of Wight" disease has been very much to the front. I have seen it in this district, and in my opinion there is undoubtedly very little connection between the conditions producing foul brood and "Isle of Wight" disease. The former is in the cell essentially, whilst the latter attacks the young bee soon after it hatches, hence many of the theories which have appeared in the "Journal" are of very little value—not to say amusing. One of your correspondents recently advised "destroying the entire population of an affected colony," and "brimstone the diseased broodless bees." Bees that are destroyed in this way are, in my opinion, slaughtered uselessly. Has it yet been proved that the "Isle of Wight" disease

is infectious? It occurs in various places widely separated, and the sufferers are generally the strongest as far as numbers go. Are we unquestionably correct in fastening the trouble on the bees themselves? What about the manipulators? Are they not vital factors in an apiary? I am strongly of the opinion that the causes of the disease are being looked for in the wrong direction, and hence the cures have not been found. Another of your correspondents strikes the same nail as I am aiming at, for he says: "burning and burying have but little effect, if any." The subject is being well ventilated in your journal, and the ventilation needs to be continued till we have a decided "cause and remedy" from a reliable authority.—W. THOMAS, Cornwall.

#### A HOPEFUL SEASON.

[8180] The bee journals have for some time been so full of lugubrious outpourings as to one disease and another, that I think it will be encouraging to you, and to your readers, to have prompt echo of cheering words, which hopefully point to happier times.

A south countryman, in sending me, as an earnest of better things to come, 2s. 6d. on account of a considerable debt owing for goods purchased some years ago, before the calamitous outbreak of the pestilence christened "Isle of Wight disease," says:—"This is going to be a grand year, and I do not want to lose the benefit of it; as fast as money comes in I am laying it out again on swarms to fill up some of my empty hives, and use some of my empty combs, standard and shallow, which were never even used last year. The season has opened well, some sections are near sealed, and such lovely weather; 'Isle of Wight' disease is dead, or inoperative, driven off by change of atmosphere, and my bees perfectly healthy. Months back I fed needy bees with I.O.W. stored combs, with no ill effect whatever." I know something of my man, and if I mentioned the name he would be well known to you, and to your readers, and his word would have greater weight. Surely, without a tinge of cant or maudlin sentiment, we may *thank God, and take courage*.

Writing about this pestilence, away back in early spring, another letter from the owner of a diseased apiary, in reply to a response from me for any helpful suggestions to pass on to others when they wrote for advice, says what ought never to be said in merely the sense of a forlorn hope, "Providence alone can help. I am inclined to think that Providence is helping. I believe 'Isle of Wight' disease is dead, the dry spring has killed it." That was

not a bad command the great Protector issued to his sturdy followers, "Trust in Providence, but keep your powder dry."—**GEORGE ROSE, Liverpool.**

[S181] I have just been looking at the letter I wrote you last year. I find it was on June 27th, and I complained that the bees, although very strong, had only just taken to the supers.

What a contrast now! I have a hive with two racks on (scaling over 70lb.), and the clover has not yet come into bloom. The hawthorn and chestnut have really provided a wonderful feast. When they were in full bloom, one stock was gaining 3lb. a day. Is not this good for the time of year? [Very good.—Ed.] One is watching and waiting now for the clover to bloom, hoping that the disasters of the last few years may be gloriously retrieved.

May a bountiful honey harvest also help to banish the fell disease which we, in the woodland, know, so far, only by report.—**H. G. MACE, Buckhurst Hill.**

#### POSSIBLE CAUSES OF DISEASE.

(Continued from page 218).

The next query I propose to offer for replies is that of sanitation, and apart from the necessity of clean hives—and dry—the wholesomeness of the air within the hive.

A few days ago I glanced at my "B.B.J." as it lay on the table and my eye caught the following WARNING:—"A cheap and crude naphthaline is now being placed upon the market, the use of which will most probably asphyxiate the brood, &c." What, are we always to be on the "qui vive" for adulteration? Is there nothing to be obtained pure, not even bread? The question suggests itself: is it necessary always to have naphthaline in the hive of a healthy lot of bees.

In the summer we have thousands of people from all parts of the country visiting Bude, Bournemouth, and Tintagel, but they don't bring antiseptics with them—they come to breathe the air that has travelled over 2,000 miles of watery space, charged with ozone. To stand on the cliffs near King Arthur's Castle, on the N. Coast of Cornwall, and fill their lungs with the pure air from the Atlantic, will create a desire that will soon want to be satisfied with something more substantial. Apply the simile to the thousands of infants and adults in our hives—is it necessary to have the inside of the hive like some chemists' shops we may have entered—lavendered or camphored, or something else. It is a small matter, it is true, but it may have something to do with the "Isle of Wight" disease.

The third question is that of breeding. We have, to some extent, become specialists in breeding bees. It is a fascinating art, but it is quite possible to go too far, and I want to point out a possible danger in queen-rearing. Excellent men the queen breeders all are, and bee-keeping owes much to them, and the services they have rendered to the industry. They have made queen-rearing a science. Is it not possible to stress and strain for colour, size, and productiveness at the sacrifice of something else—a loss of vigour, stamina, and energy.

I have been led to write these queries from reading the remarks made by Mr. Bee Mason, at the close of his cinematograph entertainment at the last B.B.K.A. conversazione, and if readers of the "B.B.J." would peruse the report on page 143, it might lead them to a solution of the difficulty with which the industry is beset, or some part of it:—"It occurred to him—bees in their wild state were more or less vicious under natural conditions." "That they were smaller, but more hardy and active."

Charles Kingsley says: "Smallness of size does not interfere with perfect development," and I may add, "whether it is the bacteria of the soil or the elephant roaming in the forest and all between, but still size counts for some purpose, as, for instance, the cart-horse when compared with the racer."

Again, "Nature does nothing for beauty—beauty follows as the inevitable result. Beauty is a conception of the mind." Some readers of Shakespeare may call to mind the following lines "In the Winter's Tale":—

"I have heard it said,

There is an Art which, in their piedness,  
shares

With great creating nature, &c., &c."

We can take a share in great creating Nature by losing vigour, the power to get, to hold, to keep, and in exchange gain size, colour, and, to use a loaded term—beauty. Mr. Bee Mason's bees were vicious; this is natural to them, at least, and often so with human beings. Bees are creatures of an impulse called instinct, and know nothing of laws which the judicious Hooker says are the products of human reason. It is natural for bees to find the root of defend, to be vice-ous, the unwillingness to give up house, home, store, and life when threatened. The human race would long before this have pushed them out of existence were it not for this vice which they show.

In conclusion, I would ask if any of my three queries points to the disease now known as the "Isle of Wight" disease.

1st. Is it not possible that artificial feeding carried on to the extent it now is,

is liable to bring about malnutrition, and the weakening of the constitution, loss of vigour, and less power to resist anything calamitous.

2nd. As to sanitation. I yield to no one in this, as a necessity. When on tour once, I sat down to dine with some friends, and someone remarked: "How you smell of carbolic," and if the bees had the power of speech they would, perhaps, make a similar remark—too much carbolic or naphthaline.

3rd. In the third query I would like to remind readers of two lines from Pope: "And reason raise o'er instinct as you can, In this 'tis God directs, in that 'tis man."

Let us not thrust too much of our art, human activities—upon the bees, and so bring about a weakness—a degeneracy.—J. BROWN, Launceston.

## Queries and Replies.

[4134] *Persistent Swarming.*—Last year I purchased a hive of black bees at a farm sale, and later a hive of first-cross Italians on eight frames, from a dealer. From the former I took twenty sections, and from the latter sixty sections. I gave candy in January to both hives, and syrup in April. This year the black bees have one super of sections nearly capped over, and the Italians two supers on, the top one being nearly all sealed. The Italians swarmed on May 16th, when I was away from home; my man hived them in the only spare hive I had at the time. On the 17th they again swarmed, and this time he left them in the skep. On the 21st they again swarmed, and he put this lot into a box. To-day, the 25th, they swarmed again, quite a strong swarm, and I added this to the first one that came off, having peppered both lots with peaffour. This hive has three frames drawn out, with some honey and pollen stored in the nine days since it was hived. The skep is full of bees, and looks a strong swarm. The one in the box was only a small lot in one corner, about three pints.

I should like to know what I ought to do with those two lots. I have a new empty W.B.C. hive waiting for the "blacks" to swarm, which, I think, they will do in a day or two.—J. D. A., Somerset.

REPLY.—The only thing you can do now is to let the bees remain in the box and skep, and next spring work them down into a frame hive as per instructions in Guide Book. The best plan would have been to return the swarm each time it issued to the parent colony.

[4135] *Preventing Increase.*—I have three hives, and do not wish for

further increase, but to get all the honey I can. In former years I have tried to do this by retarding breeding in the early spring, but the bees have generally swarmed in spite of this about the beginning of July, and as we have to depend mainly on the lime trees here, it has interfered with the honey-gathering.

This year I propose to adopt another method, and would like to know if you approve. (1) I have encouraged breeding to get the bees to swarm as early as possible. When a swarm comes off, I intend to hive it on the parent stand, but in a new body-box with ten fresh frames of foundation. I shall cut out all queen-cells, and place the parent brood-box, with all young bees and brood above the swarm, with a queen excluder between. This should make a strong hive, and as the brood in the top box hatches out it will become available for storage purposes. Of course, any supers that may be on the top of the hive at the time of swarming will go back on the top of the two brood-boxes again. Would this be all right, or can you suggest a better method? I seem quite unable to get a very strong colony and at the same time prevent swarming. (2) One of my hives has a super on which has been nearly filled with a rather dark honey this month; will this be from hawthorn or other trees? Some part of it may be from apple-blossom, but not all, I think.—ELAS. SALE.

REPLY.—(1) Your plan is the right one. (2) Probably from beans and fruit.

[4136] *Completing Unsealed Sections.*—Can you very kindly tell me through the "B.B.J." if I can force bees in any way to cap their honey? My bees have filled about 21 sections with fruit-blossom honey, and have capped over the centre sections, but not the sides. The rack has been in its present condition quite two weeks, and they seem to get no further.

Must the honey be all capped before removal, or will the flavour be as good when eaten if unsealed? The bees swarmed on May 17th, but queen-cells were destroyed and the swarm returned the same day—but they again swarmed on May 24th, and were then given a new hive. A strong stock is left behind with a good queen-cell, and these work up in the sections all day, yet seem to get no further with the capping.—M. A. W., Gravesend.

REPLY.—You should have hived the swarm on the old stand, and put the rack of sections on it, when it would have been completed. It is most improbable that the old stock will complete the work as it has been denuded of the foraging bees; put the incomplete rack on the swarm now. Honey should not be removed until it is sealed or it will ferment.

[4137] *Eke left on Hive.*—Time for manipulating.—I forgot to remove in time the eke from below the body-box in one of my hives. On examining the hive this week, I found that the bees had built out the combs beyond the depth of the brood chamber, so that if I removed the eke the lower parts of the combs would be crushed by the floor of the hive. What ought I to do now? I have left the eke on. The stock is a strong, healthy one, and gave a good supply of honey last year without swarming. Will you kindly tell me also what is the best time of the day to examine stocks? Last year I opened a hive in bright sunshine and got badly stung.—S. E. H., Edinburgh.

REPLY.—(1) Leave the eke alone now, and remove it and the extra comb when the honey harvest is over, and there is no brood in it. (2) Manipulate in the daytime, midday being best, as then most of the bees are away. Avoid manipulating in thundery weather, and be sure to subdue the bees properly before commencing. Neglect of the latter was probably the cause of your being stung, or your stock of bees may be a vicious one.

[4138] *Badly Drawn-out Sections.*—I find that many of my sections are only drawn-out on one side, filled with honey, and capped over. The foundation is quite smooth on the other side, as if the bees had removed the stampings. I have six in this condition in one super. Why is this, and what is the remedy?—T. D. A., Somerset.

REPLY.—The probable cause is that the sides not built out are those nearest the outside of the rack, or the rack is fitted up so that the bees cannot get to that side to work. Draughts will also cause this to happen sometimes.

[4139] *Disinfecting Hives.*—Owing to there being so much foul brood in this neighbourhood, I wish to take every precaution. I find if I disinfect with Calvert's No. 5 carbolic acid, it takes so long before the bees will accept the hives again. Would they take to hives earlier if I used liquid Formaldehyde, forty per cent. solution; and if so, can you tell me about how many weeks should elapse before bees are put into the hive?—FRANCIS, Torquay.

REPLY.—You must use ten per cent. solution of Formaldehyde. When the hive is dry the bees will remain in it quite contentedly, there being no disagreeable odour as in the case of carbolic acid.

[4140] *Keeping Unused Stores.*—Last autumn I fed my bees with syrup, and in the spring of this year had to take away several combs of sealed stores to make room for the queen to lay. (1) Will these

stores do for next winter, or will they be too stale? (2) What is the minimum temperature which you consider safe for manipulating bees and brood, (a) when calm, (b) in a wind?—A. B. C., Kent.

REPLY.—(1) Keep the food in a dark, warm place, and it will be fit for use in the autumn. (2) About 70 degrees Fahr. Do not manipulate at all in a wind.

## Echoes from the Hives.

I started bee-keeping last year (April 1910) with one stock, this wintered splendidly and sent off a large swarm on May 25th last. The swarm settled on a small hawthorn bush in a field at the back of my garden, and clustered on the short, thick main stem. A friend and I sawed through the stem, and carried the bush and cluster over the garden wall to a hive prepared.

My friend, who is expert in these matters, shook the bees in front of the hive, and they at once took possession and seem to be now quite settled.—J. BEAUMONT-SHAW, Wandsworth Common, May 27th.

It has been a glorious month of May in this district, and the bees have been working well. I have heard of several swarms around here, and am expecting to commence extracting early this week. The bees are very busy at present on the red-flowered horse chestnut and the raspberry blossom, which is now commencing to open.—A. R. P., Taunton, May 29th

A hive of bees belonging to Mr. Joseph Kennedy, Overtown, Lanarkshire, sent off a swarm on Wednesday, 24th May, weighing 6lb. Considering the backward seasons experienced in this part of the country in recent years, which were against early swarming, this is said to be an excellent result.—WEMYSHILL.

## WEATHER REPORT

WESTBOURNE, SUSSEX.

May, 1911.

Rainfall, 3.43in.	Minimum temperature 33° on 22nd.
Above average, 1.48in.	Minimum on grass, 30° on 22nd.
Heaviest fall, 1.48in., 25th.	Frosty nights, 0.
Rain fell on 9 days.	Mean Maximum 63.6.
Sunshine, 242.7 hours.	Mean Minimum 45.7.
Above average, 5.2 hours.	Mean temperature, 54.6.
Brightest day, 29th, 14.3 hours.	Above average, 2.8.
Sunless days, 0.	Maximum barometer, 30.291 on 6th.
Maximum temperature, 75° on 29th.	Minimum barometer, 29.614 on 14th.
	L. B. BIRKETT.

## Bee Shows to Come.

**June 26 to 30, at Norwich** (Royal Agricultural Society's Show).—Bee and Honey Section under the management of the B.B.K.A. Prizes arranged in groups of counties for Associations affiliated to the B.B.K.A. Schedules from W. Herrod, Secretary, B.B.K.A., 23, Bedford Street, Strand, London, W.C. **Entries closed.**

**July 13 and 14, at Brigg, Lincs.**—Lincolnshire B.K.A. Great Show of Honey, Hives, and Appliances, at the Brigg Exhibition of the Lincolnshire Agricultural Society. Valuable prizes offered in Open Classes for Trophy, Extracted, Granulated, and Comb Honey, Observatory Hives, Bee Appliances and Hives. Schedules, &c., from Mr. J. H. Hadfield, Alford, Lincs. **Entries close June 9.**

**July 19 and 20, at Stafford.**—Honey Show in connection with the Staffs. Bee-keepers Association. Four open classes. Schedules from Joseph Tinsley, 22, Granville Terrace, Stone, Staffs. **Entries close July 10.**

**July 25, 26, 27, at Gloucester.** Annual Show of the Gloucestershire B.K.A., in connection with the County Agricultural Show. Separate tent for Honey, Wax, and Appliances. Open classes. Special prizes. Schedules from Rev. F. H. Fowler, Barnwood Vicarage, Gloucester. **Entries close July 18.**

**July 26 and 27, at Cardiff.**—Annual Show of the Glamorgan B.K.A. in connection with the Cardiff and County Horticultural Show. Separate tent for honey, wax, and appliances. Open classes. Special prizes. Schedules from Hon. Sec. Mr. Wiltshire Maindy School, Cardiff.

**July 27, 28, and 29, at Rotherham.**—Show of Hives, Honey, &c., in connection with the Royal Yorkshire Agricultural Society. Schedules and Entry Forms from Secretary, Blake-street, York. **Entries close June 17.**

**August 3, at Weston-super-Mare.**—Annual Show of the Somerset B.K.A., in connection with the important Local Annual Flower Show. Classes for Appliances, Honey, Wax, and Bee Products. Several open and free classes. Liberal prizes. Numerous attractions. Excursions from all parts. For Schedule, &c., apply to T. Jones, Assistant Show Secretary, North View, Milton-road, Weston-super-Mare. **Entries close July 29.**

**August 16, at Lancaster.**—Annual Show of Lancashire B.K.A., in connection with the Lancaster Agricultural Show; open local and cottagers' classes. Write for Honey Schedule to Robert Gardner, 13 Sun-street, Lancaster. **Entries close August 2nd.**

**August 23, at Radstock, Somerset.**—Honey Show in connection with the Radstock Horticultural and Farmers' Association. Open and gift classes. Write for Honey Schedule. B. M. Clark, Foxhills, Radstock.

## Notices to Correspondents.

A. R. P. (Taunton).—*Earliest Stages of Foul Brood.*—In the earliest stage of foul brood, the affected larva begins to move unnaturally, and changes its appearance, loses its plumpness, and assumes a flabby aspect. The colour changes to pale yellow, and before this change takes place, the further progress of the disease may be arrested in the way described in Guide Book. If you wait until the larvæ turn brown, spores will be forming which it is difficult to destroy.

W. N. C. (Castle Cary).—*Cells of Wild Bee.*—The cells are those of *Osmia rufo*, one of the mason bees. It has made its cells of mortar composed of

agglutinated earth. One of the cells has the impression on it of the printing from the newspaper to which it was attached. The pollen stored is food for the future larva, but this nest was evidently only in preparation as we could find no eggs present in the pollen you send. The bee has probably found a small hole by which it has gained access to the top of the hive.

J. D. (Lawrencekirk).—*Strengthening Weak Colonies.*—The plan you propose would not be a good one, as the weak colonies would not have sufficient bees to keep the extra brood warm. You had much better unite, making two in all and reserving the queens you wish to keep.

J. B. (Cranbrook).—*Using Apicure.—Experts' Certificates.*—The best plan will be to melt down the suspicious combs. Apicure will not cause the bees to swarm, nor will it flavour the honey in any way. We do not know of an examination to be held near you at present. Certainly the certificate is of value, and recognised in the colonies. You would stand a better chance with it than without. Read the Australasian Bee Manual.

J. W. S. (Wembley).—*Wax-moth in Hive.*—Use either Apicure or naphthaline in the hive.

LANDFIELD (Sussex).—*Artificial Swarming.*—The whole operation is explained in Guide-book, page 93, to which we cannot do better than refer you.

ESSEX.—*Stock Dwindling.*—It is either caused by a failing queen, or disease may be present in the hive. Send us a small piece of comb containing brood (packed in a tin box), and we may be able to advise you.

W. F. WILLIAMS (Hemel Hempstead).—*Honey Sample.*—The honey is not of good quality, being dark in colour, rather thin in consistency, and having a strong, rank flavour. We should not advise you mixing it up with the light honey you may get, as it would spoil the latter.

H. QUINTIN (Co. Sligo).—*Wild Bees.*—The bee is *Andrena pilipes*, not a common species.—(F. W. L. S.)

### *Suspected Disease.*

H. C. (Kent).—The bees have starved to death. There appears to be no disease, but there are traces of wax-moth, which evidently entered the hive after the stock succumbed. You ought to get a swarm in June for about 15s.

TAIMONT (Newton Abbott).—The trouble is caused by foul brood. Destroy the remaining bees, burn combs and all internal fittings of the hive, and disinfect it thoroughly without delay.

J. T. D. (Cardigan).—The stock is affected with foul brood. We should advise you, if the stock is strong, to make a swarm of the bees, putting them into a clean hive filled with full sheets of new foundation. Melt up the used foundation for wax, and destroy the fittings of infected hive, afterwards disinfecting the latter thoroughly. Thank you for kind appreciation of "B.B.J."

W. W. (Troon).—A case of odourless foul brood. Requeen the stock and use Apicure in the hive.

AJAX (N.B.).—Odourless, foul brood. See reply to W. W. (Troon).

### Special Prepaid Advertisements

**Two Words One Penny, minimum Sixpence.**  
Orders for three or more consecutive insertions entitle advertisers to one insertion in "The Beekeepers' Record" free of charge.

Trade advertisements of Bees, Honey, Queens, and Bee goods are not admissible at above rate, but will be inserted at 1d. per word as "Business" Announcements, immediately under the Private Advertisements. Advertisements of Hive-manufacturers can only be inserted at a minimum charge of 3s. per ½ in., or 5s. per inch.

### PRIVATE ADVERTISEMENTS.

**S**TRONG, healthy, NATURAL SWARMS from frame hives for sale.—WAGHORN, Liss, Hants. j 95

**5** HIVES, painted, perfect condition, 4s. each, cost 15s.; 10 Racks, sections fitted foundation and dividers, 2s. 6d.; 2 Smokers, 1s. each; no disease.—WEST, Becroft, Bridgemaury, Fareham. j 97

**11** STOCKS BEES, fine condition, in good frame hives, 25s. each.—BECKENSALL, Ringwood, Hants. j 93

**G**UARANTEED HEALTHY, 3 Strong Stocks of Bees for sale, 23s. each, or nearest offer.—C. GRIGGS, Harlow, Essex. j 100

**Q**UANTITY TAYLOR'S BEE GOODS (new), crates, frames, sections, foundations, metal-ends, glass supers for skeps, queen excluders, &c. 15% discount.—WELLBOURN, Cranswick, Beverley. j 99

**T**YPEWRITER, Remington, universal keyboard, perfect condition, very clear writer, will last a lifetime, cost £22, sell 80s.; great bargain.—L. WAKEFIELD, Newhall Hill, Birmingham. k 2

**N**ATURAL SWARMS from Bar-framed Hives, guaranteed healthy, 12s. 6d.—WILLIAM DENNIS, Brownsover, Rugby. j 67

**1911** CHOICE, vigorous, healthy, fertile Queens, 5s. each.—WOOD, Ash Grove, Ripon. r 5

**F**REEHOLD PLOT OF LAND, well fenced and hedged, planted with choice fruit trees; buildings comprise two pigsties, fowl houses, and one office on wheels; also 100 head of poultry; reasonable price accepted; just right to commence a small apiary. Photo shewing part (3 stamps). Poultry runs and ground adjoining can be rented cheaply.—Apply, RINGER, Tatsfield, Surrey. r 4

**W**.B.C. HIVE, 10s. 6d.; shallow crate, drawn out combs, 3s. 6d.; 56lb. ripener, 4s. 6d.; 2 skeps, smoker, section rack, division boards, 3s. 6d. lot; all as new; brood combs. 4d. each; giving up; healthy.—FERRIDAY, Fouroaks. r 3

**H**EALTHY SWARMS FOR SALE, May, 3s.; June 2s. 6d.—F. H. BUCK, Wimbish, Saffron Walden.

### Special Prepaid Advertisements.—Continued

**2** SLADEN'S TWIN NUCLEI HIVES, new, complete, folding frames, cover, &c., price 5s. 6d. each, or 10s. the two f.o.r.—SINFIELD, Upper George-st., Luton. j 68

**W**HAT OFFERS?—6 Cottager Hives, used one season only, each containing floor board with legs, brood chamber with movable porch, 10 frames, dummy, 6in. lift, crate of 21 lb. sections (unused), Queen excluder, quilt, roof, painted 3 coats; large meadows honey ripener, used once, with strainer, lift and lid; Sladen's double Baby Nuclei Hive, with folding frames, used once.—F. E. MATTHEWS, Cofton Apiary, Northfield, Birmingham. j 73

**S**TRONG, guaranteed healthy, Swarms, 10s. each, 5lb. upwards, 2s. 6d. lb.; boxes returnable; cash with order.—R. WHITTING, Manea. j 78

**A** LIMITED SUPPLY OF BORAGE PLANTS to flower this summer, 20 for 6d., carriage paid.—HEWETT, Carrington-road, Dartford, Kent. j 84

**C**LEARANCE SALE.—W.B.C. Crates, Racks and Brood Bodys, 25 for £1, a few with frames; Queen Excluders, Honey Strainer and Ripener, Extractor (Cowan's 2-frame).—RINGER, The Apiary, Tatsfield. j 83

**N**UCLEI (4-frame with Queen) in W.B.C. and other Hives, 25s. to 30s. each, complete.—W. H. SIMS, Ilall Green, Birmingham. j 90

**S**WARMS on Frames, guaranteed from healthy Stocks, 20s.; boxes returned carriage paid.—F. A. BEAN, Snaith, Yorkshire. j 63

**W**ANTED, a few Skeps of Bees, with old and tough combs for driving purposes.—HERROD, "Bee Journal" Office.

**N**ATURAL SWARMS FOR SALE, June 1st to 17th 2s. 3d., after 2s. per lb.—R. ALLEN, Tusmore, Bicester. j 52

### BUSINESS ADVERTISEMENTS.

**1911** QUEENS.—Golden Italian Queens, 1911, pedigree brood rearers, guaranteed fertile, pure, mated in Italy, healthy, hardy, prolific, price 4s. each; specially selected, 7s. 6d. Terms cash.—J. B. GOODARE, Woden Apiary Wednesfield, Wolverhampton. j 96

**H**EALTHY NATURAL SWARMS for delivery before June 21st, 2s. 6d. per lb.—GEO. MASOM, expert, Moored, Yardley Gobion, Northants. j 92

**Y**OUNG FERTILE QUEENS, 3s. 9d.; Virgins, 1s. 6d.; safe arrival guaranteed.—TOLLINGTON, Woodbine Apiary, Hathern. j 91

**S**TRONG PROLIFIC HYBRID QUEENS; 15 years' experience; Swarthmore system installed; fertiles, 4s.; virgins, 2s.—MOORE, The Avenue, Bedford. j 94

**S**TRONG NATURAL SWARMS, guaranteed healthy, 12s. 6d.; safe delivery; second Swarms, 1911 Queens, 8s. 6d.—CADMAN, Codsall Wood. k 1

**S**WARMS FOR SALE during June, 2s. 6d. lb.—GEO. MASOM, expert, Moored, Yardley Gobion, Northants. j 98

**I**TALIAN QUEENS direct from Italy. See complete advertisement in "B.B.J." May 18th. Special offers till countermanded: 4 fertile Queens, taken in one time, 9s.; 6 Queens, 12s. 6d.; 10 Queens, 20s. Cash with orders; Queens sent post-paid; safe arrival guaranteed.—Address, E. PENNA, Bologna, Italy.

**K**ATA-LOG is the best Ad.; send postcard to old firm.—MEADOWS, Syston. j 85

**Q**UEENS, fertile, in introducing cage; delivery guaranteed, 5s. 6d.—BRICE'S APIARIES, Otford, Kent.



## Editorial, Notices, &c.

### BEES IN PARLIAMENT.

The following answer was given by the Parliamentary Secretary of the Board of Agriculture and Fisheries, in reply to an inquiry by the Member for West Perthshire, which will show that the subject of bee disease is receiving attention:—

Sir E. Strachey informed the Marquis of Tullibardine (U.) that if the investigations now in progress indicated that legislation was required in order to prevent the spread of bee disease in Great Britain, the Board of Agriculture would at once bring in a Bill for that purpose.

### HONEY IMPORTS.

The value of honey imported into the United Kingdom during the month of May, 1911, was £4,542.—From a return furnished to the BRITISH BEE JOURNAL by the Statistical Office, H.M. Customs.

### AMONG THE BEES.

#### BEE TEACHING.

By D. M. Macdonald, Banff.

Our Apicultural Colleges are doing good pioneer work in disseminating a knowledge of bee-keeping on up-to-date lines. One of the Aberdeen Lecturers (Mr. A. Manson), went all the way to Gloucester to secure an expert's certificate, and since then the College has been sending him round some ten counties in the North and East to deliver illustrated bee lectures. Mr. Manson is a practical bee-keeper, having been familiar with bees from his boyhood, and so his instruction is first hand, and therefore most valuable. He is at present finishing off a tour during which he has delivered over thirty lectures. In very few centres has the attendance been small, whereas in general the gatherings have been large and enthusiastic. Everywhere he discovers bee-keepers anxious to learn all the latest and best as to devices, hives, appliances and manipulations. I have no doubt the good seed sown will bring forth good fruit in the future. The college pays all expenses and invites all bee-keepers and even non-bee-keepers to the lectures free. I believe the East of Scotland and West of Scotland Colleges have also lecturers covering at least a part of each district, but the area is wide and the labourers are few. It is, however, in contemplation to appoint a qualified expert in each district who would devote his whole time to lecturing, giving demonstrations and visiting apiaries to give advice, especially in combating bee disease.

*For Legislation.*—I referred in a recent contribution to the likely benefit that might accrue from a communication with our various M.P.'s in regard to legislation to suppress bee diseases. I find that several of our legislators have been approached, and that all have expressed full sympathy with the movement. The Perthshire Bee-keepers' Association has petitioned the three M.P.'s for the county, and requested an interview with the object of securing their active aid in obtaining an Act. The Association unanimously passed a resolution in favour of such legislation, and in Lord Tullibardine bee-keepers have a representative ready to do his utmost to speed the good work. In conversing recently with the Aberdeen Apicultural College lecturer on apiculture he was emphatic on the extensive prevalence, bee pest, and the worst of it is that, as a rule, bee-keepers are entirely ignorant of its existence in their apiaries, not being aware of its symptoms. They know that some of their stocks have died out, that many more are languishing, and that even their best are not paying them as they did some years ago, but as to the why and wherefore of the matter they have no knowledge. One instance was given of a man who had hives in which the bees had died, the combs of which were literally rotten, standing open to tempt his neighbour's swarms to take up their abode there. These hives are a temptation and a snare, and foul brood will exist there, while the iniquity lasts. Would not legislation tell for good here?

*Auction Sales.*—At times bees are to be purchased cheaply at auction sales, but before investing in them it is necessary to examine the hive interior beforehand. Too often this is neglected, with disastrous results. Rarely is any guarantee given when the hives are thus sold, and consequently there is no redress if they die out soon after, or if they are badly affected with disease. This is so common a result that I would strongly counsel beginners against investing in them, even if they appear to be getting a bargain. Disease I know has been brought in close proximity to my own hives by thoughtless purchasers who had no idea that they were doing any harm. I know of instances where from one up to seven hives have been bought at displeasing sales where the bees either died out the first season, or lingered on a year or two, gradually dwindling down until they became extinct, never having brought in to their owners a single farthing. This helps to bring the pursuit into disrepute, and prejudices many against bees. This spring extra good prices were obtained for bees thus exposed at public sales, and a healthy feature was that most of the purchasers were beginners who are starting for the first

time, and who had the discretion to have the colonies examined beforehand. Bee-keeping seems to be in 'the air, and the future of the industry would be assured *if*—a big *if*—only disease were eliminated.

*Winter Protection.*—I am an advocate of ample protection in winter. Bees are bound to come out stronger and healthier in every respect, nine times out of ten, if they are warmly and snugly wrapped up to exclude the outside cold and conserve the inside heat. Plenty of overhead coverings hinders the dissipation of the warmth generated by the cluster of bees, and thereby saves them from consuming an excess of stores to create further warmth. This process, entailing as it does extra labour, must also wear out the bees, and age them before spring arrives. Yet, now and again, one meets with instances where bees overcome every drawback, and survive in spite of the lack of what goes to secure comfort and strength. Several I examined during the spring were strong

or less dependent on insects for fertilisation; some may be said to be entirely dependent. Thus the pollen grains of gooseberry, red and black currant are globular and stick together in such a way as to be immovable from the anther by the wind and necessitating some mechanical means to transfer the pollen from the anthers to the stigmas; nature accomplishes this through the hairy bodies of the bumble bee and hive bee. Experimenters who have covered bushes of these fruits with muslin to see the effect of excluding bees find that the exclusion of the bee renders the bushes fruitless.

In strawberries and raspberries, hive bees are beneficial in pollinating the blooms, though these flowers appear to be able to set fruit without the visit of insects, the movement of the air being able to transfer the pollen to the stigmas of the same flower; bees, however, if they have access do the pollination more perfectly and the fruit is larger. The best weather

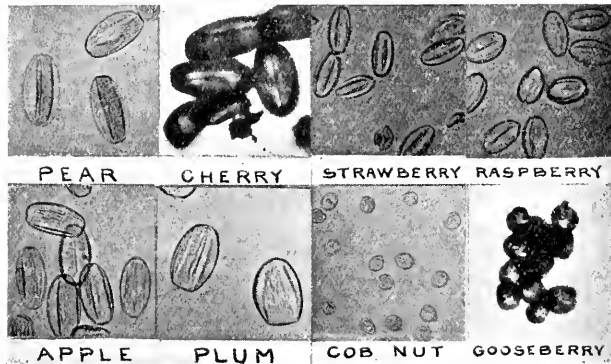

[Photo by F. Edenden, Wye Kent.]

THE POLLENS OF FRUITS (magnified).

and fit, and had started considerable breeding, although they were covered in overhead with only two or three layers of old newspapers loosely put on. As each of them had the partly drawn racks of sections left on from last season, the amount of ventilation overhead appeared to be excessive, yet the bees had overcome all drawbacks and were full of vitality. I note that this leaving on of overhead supers is often practised, but I do not care to indulge in it in my own case. I feel that in cold winters bees are detrimentally affected by this over-large internal space in which they have to keep up a suitable warmth in zero weather.

### THE POLLINATION OF FRUITS.

BY CECIL H. COOPER, M.R.A.C.

With the exception of cob and filbert-nuts and walnuts which are wind pollinated, all our hardy fruits are more

for pollination of fruits would seem to be calm somewhat warm and sunny weather, with an occasional shower, whereas frost and cold, strong winds and long continued rainy weather are detrimental to fruit production.

The berry fruits appear to be all of them able to set fruit with pollen of the same flower, or from pollen of the same or of a different variety, but in the case of apple, pear, plum and cherry, an additional problem in pollination comes in, namely that as all plants of a horticultural variety have arisen from one seed, each bud or graft used for its propagation acts as if part of the original tree; and for cross-pollination purposes the blossoms are sister flowers whether the pollen is from the same flower, from another tree near, or from another tree of the same variety miles away. Many varieties will produce fruit when pollinated with their own pollen, but even with these better fruit is

generally produced when fertilized with pollen from another variety. However a still larger proportion of varieties are found to be "self-sterile," *i.e.* do not set fruit with their own pollen, and from experiments already made it seems probable that *eight* out of *ten* of the varieties of apple grown in Britain are "self sterile," and nearly the same proportion in pears; whilst in plums and cherries it seems probable that one-third to one-half of the varieties are entirely or partly self-sterile. This fact probably accounts for many trees whilst blossoming well not setting fruit. The number of hive and wild bees in the neighbourhood also needs consideration.

In the U.S.A. and Australia observations by fruit-growers and trials at their

be carried far by wind, enough pollen is not produced by one tree to pollinate another tree near or even to pollinate adjoining flowers: it is therefore only by insects that this cross-pollination naturally takes place. Apparently the more hairy the insect the better is it adapted to the transference of pollen. From observation this year at Wye, Kent, of the various fruit-blossom visitors, I estimate the proportion of insects visiting fruit blossoms as follows: 80 per cent. hive bees, 15 per cent. bumble bees of different varieties, 5 per cent. other wild bees, black midge-like flies, tiny beetles, &c. The bumble bees, especially the largest kinds, plentifully visit gooseberries, black currants, plums and apples on dull days as well as sunny, both

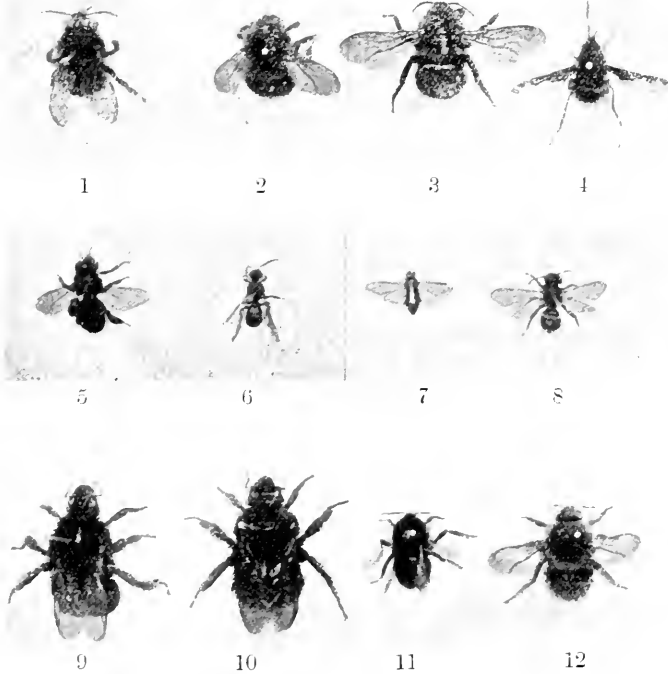

SOME OF THE CHIEF VISITORS TO FRUIT BLOSSOMS.

(Photo by F. Edenden, Wye, Kent.)

1. *Bombus Derhamelius*. 2. *Bombus muscorum*. 3. *Psithyrus barbatellus*. 4. *Bombylius major*. 5. Hive bee (*Apis mellifica*). 6. *Andrena* (sp?). 7. Apple Sawfly (*Hoplocampa testudinea*). 8. *Andrena* (sp?). 9. *Bombus lapidarius*. 10. *Bombus sylvarum*. 11. *Bombus hortorum*.

many experiment stations have already given valuable practical information on the subject; considerable knowledge has also been obtained in America as to which are the best varieties to plant as pollenizers for their best varieties of apple, pear, plum and almond: in England we are beginning to study the problems suggested by our practical fruit growing brothers and cousins across the seas.

As the pollen of neither apple, pear, plum nor cherry is produced in sufficient quantity or is of the right consistency to

at early morn and dewy eve, often in weather too windy for the hive bee to work in; they start work also soon after a shower.

The hive bee is, however, undoubtedly the most important and numerous of the fruit pollenizers, and is the only one under our control to increase or decrease its numbers: the diseases of bees are therefore a very great calamity to fruit-growers, many of whom unfortunately do not value the work of the bee as highly as they should, and get their work done by other people's bees.

It would seem that many trees that blossom without fruiting if healthy and well cultivated might be prevailed on to fruit, either by having a hive of bees placed near them or by planting another variety of the same kind of fruit near, or by grafting some of their boughs with another variety flowering about the same time so as to ensure cross fertilization. The advice from America in planting an orchard is not to plant more than two rows of one variety in one place, but to alternate with another variety, unless a variety is known to be "self fertile." In the future one may see apple orchards planted in the order of blossoming of the several varieties to give the best chance for cross pollination and the greatest convenience in spraying.

I think we may take it that there is much in fruit-growing worth the knowing still to be found out by knocking at Nature's gates.

With regard to the illustration of pollens of fruits—the pollens of apple, pear, plum, cherry, strawberry and raspberry are very similar, under the microscope resembling in shape a date stone or grain of wheat when mounted in Canada balsam: the pollens of gooseberry, red currant and black currant resemble one another, being globular and adhesive, the grains of black currant especially sticking together in large numbers.

As to the photograph of insects, these were caught by Mr. C. F. Vetch and myself, on or near blossoms of apple and other fruits in the orchard of the Wye Agricultural College, and Professor F. V. Theobald kindly named them. This year the large yellow-banded bumble bee has been by far the most numerous visitor next to hive bees.

---

## Correspondence.

---

*The Editors do not hold themselves responsible for the opinions expressed by correspondents. No notice will be taken of anonymous communications, and correspondents are requested to write on one side of the paper only and give their real names and addresses, not necessarily for publication, but as a guarantee of good faith. Illustrations should be drawn on separate pieces of paper. We do not undertake to return rejected communications.*

---

### NOTES BY THE WAY.

[8182] *Scarcity of Swarms.*—June promises to be a grand bee month for early honey-gathering, but the continued honey flow does not conduce to swarming. Every empty cell is used by the workers for storing surplus, thus restricting the brood-nest. I hear of very few swarms, and with my two apiaries I have, as yet, had only four. The unfavour-

able month of April depleted the hives by its cold, chilling winds, then came May—all one could wish for—but there was a big leeway to make up to get stocks into swarming condition. We know it takes about a month to breed bees ready to take to foraging, and when the heat-wave came, bringing the fields of flowers into full bloom a fortnight earlier than usual, the brood combs were used for storing the incoming honey. Hence, whenever possible, the brood-combs, especially the outside ones, are clogged with the best honey of the year, and this has restricted the growth of the colonies in numbers, so that swarms, at least in this part, will be few and late.

In my last notes I advised enlarging brood-nests by inserting full sheets of foundation; this system I have followed for many years, but in some cases I have found that the bees had drawn out the foundation, and filled the comb with honey, restricting the queen to a small patch in the centre, the size of a teacup, for brood-rearing. This does not point to big swarms in the future.

*Wiring Frames.*—In wiring frames of full sheets of foundation, I use two pieces of wire crossed, and one twist in the centre of the sheet. I use tacks to hold the wire taut, bend the end of the wire into a little loop and bring it to the edge of the side-piece, drive the tack in, and pull the wire tight and round the head of the tack in the top bar, cut off and put in the other piece of wire, twisting it round the first wire where they cross each other, fasten the end in the side-piece of frame, and then pull the wire taut and fasten in the edge of the top bar. The wire should be embedded with a spur-wheel heated over a spirit lamp, or, better still, with electricity if you have it; an accumulator, 4 volts., does the job very quickly and well. I cannot see the need of the two upright wires in the drawing (page 208).

No, Mr. D. M. M. (page 213). The *one* Scotsman is not alone. I have heard from many bee-keepers beyond the Tweed who do not want legislation, so the *rara avis* does not apply. Let us get rid of "Isle of Wight" disease before we invoke the aid of paid Government germ carriers who may sweep bee-keepers as clear of bees on the mainland as in the Isle of Wight at the present time.

Keep a sharp outlook for waxmoth among the wraps over supers, and for larva about the end of brood-frames. Do not let one escape if you can possibly help it.—W. WOODLEY, Beedon, Newbury.

---

### WEARDALE NOTES.

[8183] The splendid bee weather still continues, up to the time of writing, and

stocks are rapidly increasing. As expected, there has been a few swarms with the opening days of June, and if the present hot weather continues more will issue during the next few weeks. Those fortunate in having strong stocks will probably, by putting on sections, have got some splendid honey from the hawthorn, raspberry and other blossom, although the severe drought has considerably diminished the amount of nectar secreted by the flowers.

Bee-keepers are advised to lose no time in preparing to take advantage of the clover flow, as the flower is rapidly coming into full bloom.

A good deal of annoyance is often caused to bee-keepers by their bees swarming just as the sections-racks are about ready for sealing over. This, I find, is largely due to insufficient ventilation, stock combs being almost completed, and the presence of an aged queen at the head of the colony. Give plenty of ventilation by opening the entrance wide, and propping up the front of the body-box, and then shading the hive. I have generally found that bees will not swarm till they have nothing to do, that is when the combs are filled with brood and honey, and the queen has no room to lay.

If the combs are nearly full, and no queen cells started, it is a good plan to give a frame or two with just a starting strip of foundation, and place these at the front of the hive. This seems to put a check on their swarming intentions, when they see this large space to be filled up.

If swarms do issue, and there is difficulty in keeping them in the garden, do not resort to the obsolete method of the fire shovel, or tin-can tinkling, which some people claim to charm the bees, and make them alight on the nearest bush.

A good plan to get them down is to throw up a handful of fine sand, or, better still, procure a fine garden syringe, and throw a fine shower of water up amongst them. I have never known this method to fail, as probably the bees think it is coming on to rain, and quickly seek shelter.

If the swarm is hived on a new stand, remove the half-finished sections from the parent stock and place above the swarm to be completed, as it now has most of the foraging bees, whereas the original stock has mostly bees that have not been to the fields, and consequently would not be able to gather nectar to complete them.

I congratulate our friend J. M. Ellis [8175] in taking off sections as early as the 2nd of June. Was it done through his method described in the "B.B.J.," of

November 26th, 1908, and December 31st, 1908?—W. S. W., Wokingham.

#### A CURIOUS INCIDENT.

[8184] I have taken the enclosed cutting from to-day's *Scotsman*:—

Fort-William, N.B.,

May 27, 1911.

SIR,—I was very much struck while walking through the policies of a small estate in this neighbourhood to observe dozens of bees lying dead beneath and around an ordinary green tree. It was only under this particular tree that these, apparently, victims of experiments were to be found. It looked as if they had been poisoned by whatever they had extracted from the blossom, for the tree was in full flower.

I looked carefully under many of the neighbouring trees and shrubs, of which there are a great variety on this particular estate, but in no case could I discover a single corpse. The deadly evil to the bee seemed to be centred in the apparently innocent green tree, for it was under it alone that the dead were to be found.

Being at a loss to account for this, I venture to intrude this letter in your columns in the hope one of your contributors to your delightful "Nature Notes" may be able to throw some light upon the mystery.—I am, &c.

#### MYSTIFIED.

The wild cherry is frequently literally covered with bees in this place, but I have never seen a case such as described by the writer.

It surely has been a "battle royal" from some cause that caused such destruction to life.—A DAVIOT.

[We have seen the wild cherry (green tree) frequently visited by bees, but have never observed them affected by it in any way. We have, however, seen wild bees affected by lime blossoms, and hundreds of them were lying dead under the lime trees last year.—ED.]

#### BEE'S SUPERSEDING QUEEN.

[8185] On going down to see my bees about 9.30 a.m. on June 11th, I noticed an unusual collection of about 150 bees moving across the alighting board of a stock which I had united a month ago. On making a closer examination I found the bees had the queen with them, and that they were pushing her to the edge of the board. Presently they pushed her over the edge. I picked her up and placed her again at the entrance, whereupon the bees immediately surrounded her, and again hustled her off the board. I then put her in a match-box and gave her a

piece of soft candy, which she began to feed on. Having to go off to a meeting, I left the bees until my return in the afternoon, when I overhauled the stock and found brood in all stages and one ripe queen cell sealed, but did not notice any eggs. On examining the queen in the box I found one of her legs broken. I have long felt sure that bees supersede old queens without swarming, and this is, I think, evidently such a case.

I may say I now invariably work with double brood boxes, as in this way alone do I find it possible to get stocks strong enough to yield much surplus, and swarming tendencies are checked. Last season my four stocks yielded 307lb. of surplus, and I had no swarms. So far, the present season has been phenomenally favourable, but the dry weather is lasting too long; pastures have lost their freshness and there is as yet very little clover blossom.

I first began to subscribe to your paper in 1885. I am glad to see one or two of the old names left who were to the fore when I first joined the craft, though alas, many are no longer with us.—W. F. DIXON, Cumberland.

#### A VISIT TO MR. STAPLETON'S APIARY

[S186] After reading the letter in B.B.J., April 27th (p. 165), in which Mr. Stapleton invited any bee-keeper to visit his apiary, I took the opportunity, on a fine sunny day in May to pay him a call. I started early in the morning by train, arriving there about 9 o'clock, with the intention of stopping perhaps a couple of hours, and remained nearly all day. I found Mr. Stapleton and his family, who welcomed me cordially, and after some little talking indoors, I was taken out to see the bees, which are located right in front of the house. The home apiary consists of about sixty stocks, and he has thirty-five at an out-apiary, some ten or twelve miles away. All the bees are in splendid condition, and are guaranteed healthy by their owner, who offered £1 ls. for every cell of foul brood found in his apiary. Mr. Stapleton believes that the Isle of Wight disease is caused by bad ventilation of hives, and I agree with him, for as he says, take as an instance, the bad effect upon human beings in very hot weather if confined in a stuffy room. It is bad for anyone, and the same applies to the bees. He gives his bees plenty of air both at the bottom and top of their hives. When I say top, I mean he uses very light quilts, and in hot weather he turns them back in front 3in. or 4in. He also has a side entrance in the floor-board. Several of the stocks were on two sets of frames. Mr. Stapleton also appears able to control swarming and only had one swarm last year among all his bees. I

was very pleased with my visit, and much struck by the willingness of my host to assist anyone who comes to him for advice, which, I am told, is sought for by bee-keepers for many miles around.

My own bees are doing well this year. I have got shallow frames almost ready to come off. I have visited a good many beekeepers, and examined over forty stocks, several of these I found starved, which was a great surprise and disappointment to the owners, who thought the bees had sufficient food to last them until honey commenced to come in. Trusting 1911 will be a record year for all bee-keepers.—A. F. KNIGHT, Kenwyn, Truro.

## Queries and Replies.

[4141] *Wild Bees in Rockery.*—I send herewith some wild bees, and should feel greatly obliged by your advice as to dealing with them. Thousands of them have taken possession of a large rockery, upon which are many valuable alpine and rock-plants. The bees have drilled small holes, under  $\frac{1}{2}$  inch in diameter, all over the rockery, and through some of the small delicate plants, which appear to be dying off.

I have tried to get to the nests, but find the holes go straight down by the sides of the stones, and then turn under, so to dig out the nests would necessitate moving the whole mass.

I am afraid to paraffin them, as that might injure the plants. Can you suggest anything?—WREKIN, Wellington.

REPLY.—Mr. F. W. L. Sladen, to whom we referred your query, writes as follows:

The name of the wild bee is *Andrena nigroaenea*. The females burrow holes in the ground 8in. to 10in. deep. At the end of the burrow pollen is deposited, and afterwards the eggs from which hatch the larvae, which feed upon the pollen, and eventually develop into perfect bees. Several of the species of *Andrena* have two broods in the year, but this one has only one. The perfect bees emerge from their burrows early in May, and soon after the females commence making their fresh burrows, generally in the same piece of ground. This is often a gregarious species, many burrows being made within a few square yards. In this particular case the burrows have probably already been provisioned, and most of the eggs laid, and it is difficult to see how they could be destroyed without digging them up. But these bees ought not to damage the roots of plants, and after a few days, you will see no more of them until next May, when the new brood emerges.

[4142] *Bee-Keeping in the Italian Riviera.*—I should be glad for your advice on the following subject. I am going to live from the beginning of November to the end of April at San Remo in the Italian Riviera. When I was there this April, there seemed to be singularly few bees about, despite the wealth of flowers and wonderful climate, and I was informed that bees are kept extensively up in the hills but not on the coast. I would therefore ask: (1) Is the locality likely to be suitable? (2) Would the best method be to purchase a swarm in Italy, and, if so, where and when? (3) Can you tell me of any bee-keeper in that part of the world, to whom I could apply for advice? My idea is to get someone to look after the bees during my absence in the summer.—TINY-TOT, Strathpeffer.

REPLY.—Bee-keeping is carried on very successfully in the Riviera, and (1) San Remo is quite suitable; (2) You can purchase swarms or colonies at any time; (3) Signor Oreggia, the senior partner of Oreggia and Minoja, Apicultural Establishment, San Remo, could give you advice.

[4143] *Artificial Increase.*—Will you kindly let me know in the next "B.B.J." if I can make two colonies, in a good, strong condition for winter, from one stock on eight frames, with plenty of brood and bees? I have the last edition of "Guide Book." — HARRY SIEBEL, Cheshire.

REPLY.—You can make the one colony into two by careful management; but, of course, you must not expect to obtain surplus as well. Follow the instructions given in Guide Book.

[4144] *Keeping Honey in Sealed Tins.*—I shall be glad to know if any of your readers can tell me whether there is any risk of honey fermenting in sealed-top tins.—F. M. L., Birmingham.

REPLY.—Provided the honey is properly ripened before extracting, and it is stored in a dry, cool place it will not ferment in air-tight tins.

[4145] *Bee Sounds.*—I heard a curious sound in one of my hives the other day. I have heard the same in another hive about two years ago; it is a continued bur-r-r-r-r, bur-r-r-r-r. It could be distinctly heard sixteen yards away. I have read of the piping of the queen, but never heard it, the sound in question could not have been it, because it was quite unlike piping, more like the distant roll of a drum. I shall be obliged if you can satisfy my curiosity.—T. F. NEWMAN.

REPLY.—There is no doubt it was the piping of the queen which you heard.

[4146] *Utilising Fermented Honey.*—I have some bottled honey that has been quite a year or more in the jars. I now

find it has fermented. Will heating it moderately make it useable.—F. V. H., Sussex.

REPLY.—The only use to which you can put it is as food for bees, and before it is fit even for this it will have to be boiled.

[4147] *Removing Skep from over Frame-hive.*—I shall be obliged if you will kindly give me, through the BEE JOURNAL, a few hints as to how to take a skep off a bar-frame hive. Early in April I put the skep on top of a body-box fitted with nine frames of foundation. The bees worked down, and were very strong, so a few days ago I lifted the skep off, thinking to drive the remaining bees in at the entrance, and put a queen excluder on. I found half the colony on the frames, and the other half in the skep. I placed the latter quickly on a floor-board, and put the lift on the hive. Next morning early I put a section rack on the bar-frames, and set the skep upon it, cutting a large hole in the centre as before.—RICHARD BERRELL.

REPLY. You had better drive the bees from the skep as explained in Guide Book (page 147), in the cool of the evening; an excluder should be placed between the section rack and the brood-frames. Make sure the queen is not in the sections, and hive the bees in the front as you would a swarm. If there is no brood in the skep, it can be taken right away, and the honey drained from the combs. If there is still brood in it, you must replace it above the section rack for three weeks, when the brood will all have hatched out. It can then be taken off and treated as described above.

---



---

#### CAPPINGS OF COMB.

BY L. S. CRAWSHAW, NORTON, MALTON, YORKS.

*Queen Excluder* (page 166).—It ought to be remembered, in connection with his dislike and disuse of excluder-zinc, that D.M.M. is a producer of section honey—and beautiful sections too—as I have had opportunity of observing. But quite a different condition obtains in the production of extracted honey, and a queen excluder is more necessary. Possibly this difference of condition, and perhaps the use, or non-use, of full sheets of foundation, accounts for much of the difference of opinion. Personally I do not place excluder under sections, but I have often had drone brood reared in them. If natural comb building is allowed above a set of all-worker combs, there is always this danger, however minimised by the woodwork.

*Bees under Snow* (page 167).—All the difference in the world whether the snow be wet or dry. If dry, it is pervious to pure air, and the colder the locality the more satisfactory this natural blanket.

*Too much Honey* (page 167).—Is this possible? There may be something to be said on both sides. If this state of things occurred year after year, the bee-keeper might have to do proportionately more work for less return. But it does not. And although a bumper year may depress prices somewhat, more people are induced to eat honey, and the bee-keeper himself gets that much-needed encouragement for which he is always "hoping." This year of grace looks like bringing the long-looked-for "bump" to the scales, for if it continues as it has begun, those whose feeding account has been so heavy in the past, may have the unfamiliar joy of raising supers. I must own to second supers on several hives, a blissful state I have never known before at a like period. My bees seem to have had an uninterrupted run upon fruit bloom, sycamore, hawthorn and other trees, wild flowers and the like, and are still storing heavily, whilst the limes are already in bud, something like a month ahead of due season, and the clover is coming out.

*Legislation in Switzerland* (page 172).—Will the opponents of legislation here read and digest the hard facts contained in this report, particularly those referring to the reduction of disease. Incidentally they might note the conclusion as to the susceptibility of the Italian bee, which is Dr. Kramer's unshakable conviction, and also the evidence of continued co-operation by those members in districts from which the disease has been banished.

*Position of Dummy* (page 173).—Some time ago I made a practice of removing this useful piece of hive furniture at the beginning of an "entire" examination, then replacing the frames close to the hive side, finally inserting the dummy at the opposite side. This process saved a double manipulation of the frames, which would have been necessary owing to my non-use of frame spacers. The dummies were hollow with beeway below, a kind of hermaphrodite affair, which could be used for feeding purposes. By the way, I wonder if D.M.M. means division board, and has fallen a victim to an earlier Biblical character, the old Adam.

*Tea for Bees* (page 175).—This interesting experiment might be tried by every investigating bee-keeper, married or unmarried! If Mr. Reid's theory be true, it may prove a valuable discovery. At the same time it should be borne in mind that the past winter was by no means hard upon the bees, and experimenters might do well to go slowly. My own bees, which were fed upon best sugar, showed no trace of dysentery. It may be that the first "brew" is not essential, and that the leaves from the pot will provide an efficacious liquor. This should avoid the amus-

ing contretemps experienced in the Reid household.

*Isle of Wight Disease and a Good season* (page 185).—We may all profoundly hope that Mr. Bullamore's prophecy will come true, and a good season will dispose of the disease. Events will show. Once more let us hope that this is the season.

*Criticisms* (page 187).—If one may criticize the critic, for whose opinions I have considerable respect, I would point out that he credits Dr. Miller with a new title for his book. In this connection, we may expect with interest a new volume to be entitled "Fifty years among the bees," which should embody the author's most recent practice. We are fortunate in having such men as the genial doctor, who still remain open-minded after so long an experience.

*Propolised Fingers* (page 193).—If one could remember to do so before beginning manipulation, it might be efficacious to smear the fingers with a vaselined cloth. Prevention in this case is worth tons of cure, for more unpleasant and adhesive stuff is hard to find.

*Bee-Hive Incubators* (page 196).—K. C. Payne asks for hints. May I suggest that it is important to use the right kind of eggs, N.B. I have had the best results with those of *Apis mellifica* Query, should that abbreviation be aspirated?

*Folding Sections* (page 205).—An additional hint may be of service. I find that I can do almost as rapid, and perhaps better work, with the fingers as with a folding machine. For it is important that a section should be perfectly square after folding, whereas the two folded joints, which are opposed diagonally to one fold and the dovetail, pull the section into a kind of diamond. To prevent this, depress each end of the section slightly too much before uniting, when the resistance of the two folds will be weakened. Half-an-inch of extra folding is about right.

*Cutting Foundation* (page 205).—Mr. Woodley's method gives a piece which will fit the section exactly. I do not agree with him here, as if the foundation is not inserted exactly true, or if the section is ever so slightly out, the foundation bears hardly against one side, and the further edge is thrown out of the centre line.

---



---

#### PRESS CUTTINGS.

A remarkable bird found in Mexico is the bee-martin, which has a trick of ruffling up the feathers on the top of its head into the exact semblance of a beautiful flower; and when a bee comes along to sip honey from the supposed flower, it is snapped up by the bird.—*Weekly Telegraph*.



## Bee Shows to Come.

A nominal charge of 2s. 6d. is made for notices (not exceeding 7 lines) in this column, 10 lines charged 3s. 6d., up to 15 lines 5s., which covers cost of insertion from order till date of show. Cash should accompany orders for insertion.

**June 26 to 30, at Norwich** (Royal Agricultural Society's Show).—Bee and Honey Section under the management of the B.B.K.A. Prizes arranged in groups of counties for Associations affiliated to the B.B.K.A. **Entries closed.**

**July 13 and 14, at Brigg, Lincs.**—Lincolnshire B.K.A. Great Show of Honey, Hives, and Appliances, at the Brigg Exhibition of the Lincolnshire Agricultural Society. Valuable prizes offered in Open Classes for Trophy, Extracted, Granulated, and Comb Honey, Observatory Hives, Bee Appliances and Hives. Schedules, &c., from Mr. J. H. Hadfield, Alford, Lincs. **Entries closed.**

**July 19 and 20, at Stafford.**—Honey Show in connection with the Staffs. Bee-keepers' Association. Four open classes. Schedules from Joseph Tinsley, 22, Granville Terrace, Stone, Staffs. **Entries close July 10.**

**July 20, at Southwell.**—Annual Show of the Notts B.K.A., in connection with the Horticultural Society's Show. Open class for Single 1-lb. Jar. First prize, 20s. Schedules from Geo. Hayes, Mona Street, Beeston, Notts.

**July 25, 26, 27, at Gloucester.** Annual Show of the Gloucestershire B.K.A., in connection with the County Agricultural Show. Separate tent for Honey, Wax, and Appliances. Open classes. Special prizes. Schedules from Rev. F. H. Fowler, Barnwood Vicarage, Gloucester. **Entries close July 18.**

**July 26 and 27, at Cardiff.**—Annual Show of the Glamorgan B.K.A. in connection with the Cardiff and County Horticultural Show. Separate tent for honey, wax, and appliances. Open classes. Special prizes. Schedules from Hon. Sec. Mr. Wiltshire, Maindy School, Cardiff.

**July 27, 28, and 29, at Rotherham.**—Show of Hives, Honey, &c., in connection with the Royal Yorkshire Agricultural Society. Schedules and Entry Forms from Secretary, Blake-street, York. **Entries close June 17.**

**August 2, at Stoke Park, Guildford.** Annual Exhibition of Bees, Wax, Appliances, &c., will be held by the Surrey B.K.A., in connection with the Guildford and West Surrey Agricultural Association. Nineteen classes (five open to all). Many medals. Schedules from F. B. White, Hon. Secretary, Marden House, Redhill, Surrey. **Entries close July 22.**

**August 3, at Weston-super-Mare.**—Annual Show of the Somerset B.K.A., in connection with the important Local Annual Flower Show. Classes for Appliances, Honey, Wax, and Bee Products. Several open and free classes. Liberal prizes. Numerous attractions. Excursions from all parts. For Schedule, &c., apply to T. Jones, Assistant Show Secretary, North View, Milton-road, Weston-super-Mare. **Entries close July 29.**

**August 7 (Bank Holiday), at Cambridge.** Honey Show in connection with the Cambridge Mammoth Show Society. All Open Classes, four Special Hives to be competed for. This Show also includes dogs, poultry, pigeons, rabbits, cage birds, flowers, fruit, and vegetables; also grand programme of sports and motor racing, &c. Balloon ascent and parachute descent by Captain Spencer. The champion prize band (Irwell Springs) has been specially engaged. Schedules from Hon. Sec., E. F. Dant, Member of B.B.K.A., 52 Bridge Street, Cambridge. **Entries close Thursday, August 3.**

**August 16, at Lancaster.** Lancaster Agricultural Society, in conjunction with the Lancashire B.K.A. 16 Classes for Honey, Bee Produce, and Bee Hives. Numerous specials, including 2 silver challenge cups, 12 silver and bronze medals. Write for Honey Schedule to Robert Gardner, 13, Sun St., Lancaster. **Entries close August 2.**

**August 23, at Radstock, Somerset.**—Honey Show in connection with the Radstock Horticultural and Farmers' Association. Open and gift classes. Write for Honey Schedule. B. M. Clark, Foxhills, Radstock.

## Notices to Correspondents.

Letters or queries asking for addresses of manufacturers or correspondents, or where appliances can be purchased, or replies giving such information, can only be inserted as advertisements. The space devoted to letters, queries, and replies is meant for the general good of bee-keepers, and not for advertisements. We wish our correspondents to bear in mind that, as it is necessary for us to go to press in advance of the date of issue, queries cannot always be replied to in the issue immediately following the receipt of their communications.

T. C. (Lewes).—*Surplus Queens.*—The young queens will be most useful to those requiring them for re-queening or making artificial swarms.

J. W. (Broxy Ferry).—*Reliquifying Granulated Honey in Jars.*—Remove the caps from the jars, and replace the latter in a saucepan with small strips of wood underneath to prevent the jars touching the metal. Set the pan over the fire, and heat until the finger cannot remain in the water with comfort. Keep at this temperature until the honey is melted. Be careful that the water does not boil, or the flavour of the honey will be spoilt.

D. D. (Sheffield).—*Suspected Disease.*—Comb is affected with foul brood, and this will account for the stock dwindling. You probably killed the queen during the previous manipulations.

H. S. V. (Tewkesbury).—*Uniting Bees.*—The bees have evidently died from the effects of the damp and the strong disinfectant. After twenty-four hours it will be safer to flour the bees in both lots before adding more to the weaker.

J. D. D. (Dorris).—*Dead Bees.*—The greater number of the bees are workers, which have died of old age. The remainder are drones, which have been killed by the workers.

E. S. (Royston).—*Using Apicure.*—All depends on the strength of the colony, and the weather. In warm weather it will evaporate in a month or six weeks; in cold it will last about three months.

J. W. S. (Forfarshire).—*Curing Foul Brood.*—It is very wrong of your neighbour to keep a diseased stock so near your bees, as your strong stocks have probably robbed them and so contracted it. In reply to your questions (1) Keep the bees confined for forty-eight hours without food, then give them, when they will be all right. (2) You might try apicure or formaldehyde, as advertised in our pages. (3) It is foul brood of old standing.

**Special Prepaid Advertisements**

**Two Words One Penny, minimum Sixpence.**  
Orders for three or more consecutive insertions entitle advertisers to one insertion in "The Beekeepers' Record" free of charge.

Trade advertisements of Bees, Honey, Queens, and Bee goods are not admissible at above rate, but will be inserted at 1d. per word as "Business" Announcements, immediately under the Private Advertisements. Advertisements of Hive-manufacturers can only be inserted at a minimum charge of 3s. per  $\frac{1}{2}$  in., or 5s. per inch.

**PRIVATE ADVERTISEMENTS.**

**SALE or EXCHANGE for MARCH CHICKENS.**  
Taylor's Centrifugal Honey Extractor, listed 22s. 6d., new condition, and appliances.—**POPE**, Jockey-rd, Sutton Coldfield. k 6

**SURPLUS STOCK**—4 W.B.C. Hives, newly painted, complete with Brood Box, 2 Supers, Queen Excluder, 7s. each; Supers, with 8 drawn out Combs, metal ends, 3s. each; Supers, with 8 Combs, not drawn out, and metal ends, 2s. each; W.B.C. Section Racks, with 7 frames, 1s. 9d. each; Queen Excluders, 4d. each; drawn out Super Combs, 4s. a doz.—**GILBEY**, Bretton, Wakefield. k 18

**REMOVING.**—Guaranteed healthy Stock, with Cowan Hive, 30s.; empty wells hive, 10s.; Standard Nucleus Hives, 1s. 6d.—**BEECROFT**, Abbots-road, King's Heath. k 19

**6 DOZ.**  $\frac{1}{2}$ lb. tie-over **JARS HONEY**, heather blend, 5s. doz., free on rail.—**W. WOODS**, Normandy, Guildford. k 20

**STRONG SWARMS**, guaranteed healthy, 12s. 6d. each, carriage paid, boxes returned paid.—**L. W. MATTHEWS**, Great Rollright, Oxon. k 22

**STRONG STOCK** of Sladen's strain, healthy, in good hive; will exchange for two Swarms Blacks.—**HUGHES**, Goat Llanberis, N. W. k 23

**STOCKS BEES** on Standard 10 frames, in good Hives, 25s. each; Swarms, 12s. 6d., in few days.—**BECKENSALL**, Ringwood, Hants. k 24

**W.B.C. SUPER CRATE**, stock box, 3 shallow-frame Foxes, excluder, zinc uncapping knife, sundries; free disease, clean, 10s. 6d. lot.—**TOWNSHEND**, 82, Linden-road, Bournville. k 25

**FOR SALE, HONEY RIPENER**, unused, cost 12s., hold 1cwt., cheap, 7s.—28, Windsor-street, Wolverton, Bucks. k 7

**FOR SALE**, few Racks good, clean, healthy, drawn out Shallow Frames, 4s.; section racks, 1s. each; dividers, 6d. doz.—**A. GREEN**, Tangley Estate, Andover. k 8

**EXPERTS.**—Brothers, thoroughly competent, seek situation in Apiary or gardens for a few months.—**VARTY**, Diseworth, Derby. k 9

**STRONG**, healthy, 3-frame Nuclei, with 1911 fertile Queens, selected strains, 10s.; 6-frame, 18s. 6d.—**L. HACK**, Holmwood, Surrey. k 10

**HIVE BEES**, and **FEEDER**, free on rail; strong hive, 25s.; makeshift, 20s., 15s.; 3-frame Nuclei, 14s.—**NEWMAN**, 33, Norfolk-road, Erdington. k 11

**HEALTHY SWARMS**, guaranteed June, 11s., or 2s. 6d. lb.; swarm boxes returnable, cash with order.—**LEWIN**, Molesworth, Hants. k 12

**FOUR DOZ.** finest grade White Clover 1911 Sections, 10s. doz.—**NORTH**, Cressing, Braintree, Essex. k 14

**FOR SALE**, first-class Apiary, 40 hives, honey shed and all appliances, situate Marlborough, Wilts; no reasonable offer refused; inspection invited. Apply, **WADEMAN**, 5, Gold-street, Roath, Cardiff. k 26

**5 HIVES**, painted, perfect condition, 4s. each, cost 15s.; 10 Racks, sections fitted foundation and dividers, 2s. 6d.; 2 Smokers 1s. each; no disease.—**WEST**, Beecroft, Bridgemanry, Fareham. j 97

**Special Prepaid Advertisements—Continued**

**WANTED** immediately, Skep with old Combs, for driving.—**BEVAN**, Picton Cottage, Newton, Mumbles, S.O. k 15

**QUANTITY TAYLOR'S BEE GOODS** (new), crates, frames, sections, foundations, metal-ends, glass supers for skeps, queen excluders, &c. 15% discount.—**WELLBOURN**, Cranswick, Beverley. j 99

**TYPEWRITER**, Remington, universal keyboard, perfect condition, very clear writer, will last a lifetime, cost £22, sell 80s.; great bargain.—**L. WAKEFIELD**, Newhall Hill, Birmingham. k 2

**NATURAL SWARMS** from Bar-framed Hives, guaranteed healthy, 12s. 6d.—**WILLIAM DENNIS**, Brownsover, Rugby. j 67

**HEALTHY SWARMS FOR SALE**, May, 3s.; June 2s. 6d.—**F. H. BUCK**, Wimbish, Saffron Walden.

**WHAT OFFERS?**—6 Cottager Hives, used one season only, each containing floor board with legs, brood chamber with movable porch, 10 frames, dummy, 6in. lift, crate of 21 lb. sections (unused), Queen excluder, quilt, roof, painted 3 coats; large meadows honey ripener, used once, with strainer, lift and lid; Sladen's double Baby Nuclei Hive, with folding frames, used once.—**F. E. MATTHEWS**, Cofion Apiary, Northfield, Birmingham. j 73

**STRONG**, guaranteed healthy, Swarms, 10s. each, 5lb. upwards, 2s. 6d. lb.; boxes returnable; cash with order.—**R. WHITTING**, Manea. j 78

**A LIMITED SUPPLY of BORAGE PLANTS** to flower this summer, 20 for 6d., carriage paid.—**HEWETT**, Carrington-road, Dartford, Kent. j 84

**NUCLEI** (4-frame with Queen) in W.B.C. and other Hives, 25s. to 30s. each, complete.—**W. H. SIMS**, Hall Green, Birmingham. j 90

**SWARMS** on Frames, guaranteed from healthy Stocks, 20s.; boxes returned carriage paid.—**F. A. BEAN**, Snaith, Yorkshire. j 63

**WANTED**, a few Skeps of Bees, with old and tough combs for driving purposes.—**HERROD**, "Bee Journal" Office.

**BUSINESS ADVERTISEMENTS.**

**SECTIONS of HONEYCOMB** wanted to purchase for cash.—**T. SMITH** and Co., Cambridge-street, Hyde Park, W. k 13

**SECTIONS**, rew. wanted, by the **HONELADE** Co., 23, Moorfields, E.C. k 16

**QUEENS** from Doolittle stock, virgins, 1s. 6d.; fertiles, 5s.—**D. G. TAYLOR**, Ilminster. k 17

**EXTRACTED HONEY** bought in any quantity; prompt cash; receptacles sent.—Send sample, stating quantity, **SPRING** and Co., Ltd., Brigg, Lincs.

**CHOICE**, fertile, black Queens, 5/- each.—**WILKES**, Lichfield-road, Four Oaks, Birmingham.

**BRICE'S 1911 QUEENS**, Hybrids, 5s. 6d.; blacks, 5/-; in introducing cage; delivery guaranteed.—**BRICE'S APIARIES**, Otford, Kent.

**EVERYTHING** for successful Bee-Keeping, for the amateur and the professional, prime quality, moderate prices. See our new large illustrated catalogue now ready, and sent post free to enquirers. The fullest and most helpful catalogue that is published.—**SEEDS AND BEES**, Ltd. (George Rose), 22, Bolton-street, Liverpool. The British and Irish Bee-Keepers' Prompt Supply Stores.

**NO WAITING**, prompt despatch. Prime, healthy Swarms 1910 Queens, 12s. 6d. and 15s., boxes free.—**HIGGINSON**, Egerton, Kent. k 21

**1911 QUEENS.**—Golden Italian Queens, 1911, pedigree brood rearers, guaranteed fertile, pure, mated in Italy, healthy, hardy, prolific, price 4s. each; specially selected, 7s. 6d. Terms cash.—**J. B. GOODARE**, Woden Apiary, Wednesfield, Wolverhampton. j 96

## Editorial, Notices, &c.

### BRITISH BEE-KEEPERS' ASSOCIATION

The monthly meeting of the Council was held on June 15th, 1911, at 23, Bedford Street, Strand, London, W.C. Mr. W. F. Reid presided, and there were also present, Messrs. J. Smallwood, E. Watson, J. B. Lamb, O. R. Frankenstein, J. Cunningham (Cambridge and District), G. R. Alder (Essex), G. W. Judge and J. E. Smiles (Crayford), and W. Herrod (Secretary).

Letters expressing regret at inability to attend were received from Miss Gayton, Messrs. T. W. Cowan, A. G. Pugh, C. L. M. Eales, T. Bevan, G. Hayes, G. W. Avery, and J. Viears.

The Minutes of Council Meeting held May 18th were read and confirmed.

The following new members were elected: Mrs. C. E. Watson, Morcott Grange, Uppingham; Mr. H. Broughton, 45, King Charles Road, Surbiton Hill; Mr. A. C. Town, Kingston Gardens, Abingdon, Berks; Mr. L. Hardwicke, "Villa Molong," Bellville, Cape Town, S.A.

The Andover and District Beekeepers' Association applied for affiliation and were accepted.

The following names of delegates were submitted and approved: Mrs. Chapman and Mr. T. W. White (Essex), Mr. J. Tinsley (Staffs), Mr. F. H. Taylor and Mr. W. H. Martin (Lancashire).

The report of the Finance Committee was presented by Mr. J. Smallwood, who stated that the income for the month of May was a record, being £89 1s. 0d. The balance in hand at the end of May was £183 2s. 1d., and it was resolved that payments amounting to £48 13s. 6d. be made.

The report on the paper work for First Class Certificates was received, and it was resolved to ask four out of the six candidates to present themselves for the lecture test. It was also unanimously resolved to thank Colonel Walker most heartily for undertaking the onerous work of marking the papers.

Mr. Reid said it gave the Council great pleasure to welcome the new members, Mr. J. Cunningham and Mr. G. R. Alder. The work of the Council was heavy, and he hoped they would be able to attend regularly and help with it, as it was more satisfactory and gratifying that the Affiliated Associations should take an active part in the management of the Association.

Examinations of the Third Class were arranged for at Aberdeen, Luton, Chester, Norwich, Swanley, Bridgend, Carlisle, Boston, and Brigg.

Correspondence was read between Mr. Cowan and the Rev. W. Ellison, Chairman

of the Cambridge and District Association. It was proposed by Mr. Watson and seconded by Mr. Lamb that the Council fully approve and endorse the letters written by Mr. Cowan, and that he be thanked most cordially for the great labour and trouble he had taken in the matter.

Correspondence was read from the Secretary of the Derbyshire Association, and it was resolved that the same lie on the table.

Proofs of letter re delegates were submitted, and it was resolved that the same be printed and sent to Council for the next meeting, after being approved by the Publications Committee.

Next Meeting of Council July 20th.

### THE BRITISH BEE-KEEPERS' GUIDE BOOK.

TWENTIETH EDITION.

The special large edition of 19,000 copies of the above popular work on bees (though only issued in August, 1907) has been completely sold out within four years, and we have pleasure in announcing that Mr. Cowan has prepared a new and revised "Coronation" Edition, which will be on sale in a few days time. While the special characteristics of the book have been carefully preserved it has been brought up-to-date in every way. The chapter on diseases has received the special attention of the author in view of the late mortality among the bees in this country.

An artistic cover, in the appropriate colours of royal red and purple, adds to the attractive appearance of the book, and we confidently expect that the Twentieth Edition will meet with the approval that previous editions have done.

### HELPFUL HINTS FOR NOVICES.

By W. Herrod.

*Fitting up Frames.*—A little trouble and care expended on this work will save the expenditure of useless labour on the part of the bee, and enable the bee-keeper to manipulate the frames easily and comfortably. Also, if done properly, the risk of foundation falling is reduced to a minimum. In the first place the foundation used must be of the best kind and free from the possibility of disease germs lurking in it. Undoubtedly foundation such as that manufactured by the "Weed" process is the best; it is sterilized twice during the time it is being manufactured, so that in reality it is doubly safe. I have a number of times seen disease break out from the use of foundation made by the old dipping method, but I have yet to see the first case of this happening with "Weed" Foundation. Also it is much

tougher than other foundation, owing to the fact that every particle of dirt and pollen is removed so that it will stand any reasonable strain put upon it. To see the difference it is only necessary to take a sheet of the two kinds (i.e., "Weed" and the dipped process) and hold them up to the light, when it will be seen that the "Weed" is transparent, while the other is full of small particles of foreign matter that have not been removed. Having decided upon the foundation, the next item is the frame, and I say without hesitation that the best frame to use is one with a perfectly plain top bar. The split top is an abomination, as it harbours wax-moth, makes the bar weak, so that it often sags in the centre, and also prolongs the work of removing the comb when it is necessary to replace it with foundation. If the plain top is used it compels the bee-keeper to wire the foundation, a very necessary proceeding, as it ensures its being kept in the centre of the frame, reduces the possibility of it falling, and makes the combs much stronger in case they have to travel. For this reason it is almost criminal for those engaged in the sale of bees not to have their combs wired. Again, if in the excitement of something unusual happening during manipulation, should the frame be held flat instead of edgewise, there is not so much danger of the comb breaking out. Lastly, it saves money, as foundation which weighs ten sheets to the pound can be used instead of seven, which is the lightest that should be used unwired. It is just as easy and quick to fasten the foundation to the top bar by means of molten wax as it is to insert it into the saw-cut. When it is necessary to cut out the comb, a sharp knife, heated a little, run along the underside of the top bar removes the comb and leaves a plain surface for fixing foundation again. There are various methods of wiring explained in the "Guide Book." The one I have found most satisfactory is that shown on page 75. Complication of parts in a frame are objectionable; in fact, in any appliance connected with bee-keeping the simplest is the best, providing it is efficient for the work for which it is intended.

Instructions for wiring are so clearly given in the "Guide Book," that I need not detail them here, but will mention a few brief hints which will make the work more satisfactory and easier. Use tinned wire, otherwise it will rust and cause death of larva when it touches the cells. The wire for a brood-frame should be stretched at least four inches before it is put into the frame. If stretching is attempted after the wire is in the frame, it is not enough, and the wire soon becomes slack. With nails the tighter the wire is pulled the faster the

hooks remain. If hooks screwed into the inside of the frame are used they often fall out and they take longer to fix. Before attempting to put foundation into a split-top frame, cut a small piece off the two top corners, this will allow the foundation to go in comfortably. The saw-cut, as a rule, is not carried quite up to the end bar on one side as it is made with a circular saw; therefore, to attempt to force the foundation in will cause it to buckle and result in an imperfect comb. Don't cut off too much or drone comb will be built. Keep the wiring board damped with hot water; this will prevent the foundation sticking and also keep the wax in a more pliable condition. If the board is dry, the embedder will cause the sheet to stick along its route, and when an attempt is made to lift the frame off, the wire cuts right through, so spoiling it. A good embedder can be made by driving a two-inch wire nail into a piece of wood to form a handle, cut off the head, file to a blunt point, cut a nick in this with a small three-cornered file, and you have an embedder that costs nothing and will work quite as well as the wheel pattern sold. Use a spirit lamp to heat the embedder, not a candle; the latter causes carbon to form, and this blackening the bees object to. Don't get the embedder too hot or the wax will be melted right through. When placed in the hive the bees will enlarge these small holes and often build drone comb in them.

---

## NECTAR-PRODUCING PLANTS AND THEIR POLLEN.

By Geo. Hayes, Beeston, Notts.

(Continued from p. 215).

### No. 8. HORSE CHESTNUT (*Æsculus Hippocastanum*).

NAT. ORD., *Sapindaceæ*.

The chestnut is a very beautiful tree: its branches are so arranged that they give it the form of a paraboloid. If we add to this the shape of its large leaves and its pyramids of white flowers, delicately marked with red and yellow, it is not to be wondered that we find this tree in such profusion. It is not a native of Europe, but was introduced into this country about the middle of the 16th century. It does not produce good timber, and is, therefore, grown chiefly as an ornamental tree.

To the bee-keeper it is about the same value as the Sycamore, both as regards nectar and pollen production.

The individual flowers of which the pyramid is made up, are worthy of close examination, when it will be found that they are as lovely as many orchids. The beautiful tints on the petals and the more intense colour of the anthers on the white back-ground give general satisfaction.

The fruit, or nuts, are well known to all, and have something to do with the common name given to this tree. First *Horse* denotes that it is something large and coarse—as Mint, Horse-mint, Radish, Horse-Radish—to distinguish this from the sweet chestnut (*Castania vesca*), which in the southern countries forms the food of the common people. Secondly, it is probably from the fact that horses were fed with its fruit. The Turks are said to grind the nuts and mix them with the horse's food which the latter devoured with avidity. The pollen is of a bright red colour both when on the anthers and the leg of the bee, but its brightness vanishes to some extent after being kept awhile, as some taken from bees working on this flower shows. I may here mention that I have a collection of pollen taken from the legs of bees found working on each particular flower, so that I may know by the colour of the load of pollen brought home approximately the flower which the bee has been visiting. I say approximately because it sometimes happens that more than one species of flower will be yielding the same coloured pollen at the same time, and in such a case we have to refer it to the microscope. Both the Chestnut and the Sycamore are large growing trees, and it would at first no doubt be thought that the pollen grains would be about equal in size, but this is not so, for although the Chestnut has the larger and stronger flower of the two, its pollen is very much smaller. When dry it measures only  $\frac{11}{10000}$  in. by  $\frac{1}{10000}$  in. and when put into honey the width is increased to  $\frac{3}{10000}$  in. and when taken from honey it usually measures  $\frac{11}{10000}$  in. by  $\frac{1}{10000}$  in. When examined in media its colour is a dull yellow, its forms varying as shown in the illustration. It will be noticed how very much it is like Sycamore pollen, the principal difference being the boat-shaped form when dry. The processes are irregular and are not on the granular portions, which corre-

spond with the flutings; and the divisions of the lobes are less acute.

(To be continued.)

## Correspondence.

The Editors do not hold themselves responsible for the opinions expressed by correspondents. No notice will be taken of anonymous communications, and correspondents are requested to write on one side of the paper only and give their real names and addresses, not necessarily for publication, but as a guarantee of good faith. Illustrations should be drawn on separate pieces of paper.

### AN INTERESTING EXPERIMENT.

[8187] The results of an interesting experiment were shown at the meeting, on June 9th, of the Glastonbury and Street Bee-Keepers' Association, held in the garden of one of the members. Six stocks of bees of various strengths were arranged to show that a stock twice the average strength would give three times as much honey as an average stock during the May honey-flow. The smallest nucleus had about 200 bees in it. The largest stock consisted of two colonies united at the end of April and had bees entering the hive on good honey days at the rate of 260 a minute. From the doubled stock 56lb. of honey was taken and extracted during the evening, eleven shallow frames of partly unsealed honey

were left in the hive. The stock of average strength had about 21lb. of honey in the supers, so that there was plenty of margin for the three-times rate. The "extra strong" stock had been on a weighing machine for thirty days and showed an increase of weight during that time of 105lb., the lowest day's work recorded being 1lb. and the highest 7½lb. During the best week, from 24th to 30th, the weight increased 39lb.

I send you herewith a sample of the honey extracted and should be glad to have your opinion on the quality and from what flowers the honey has been obtained? We should be glad if you would also estimate the proportion of apple blossom

#### 1. Dry.



#### 2. In Water.



#### 3. In Honey.

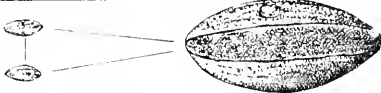

#### 4. From Honey.

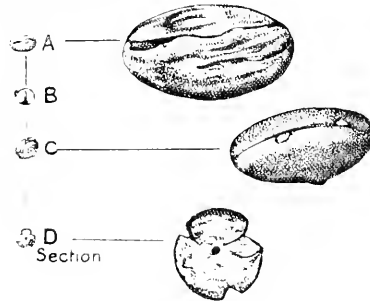

POLLEN OF CHESTNUT.

When taken from honey it usually measures  $\frac{11}{10000}$  in. by  $\frac{1}{10000}$  in. When examined in media its colour is a dull yellow, its forms varying as shown in the illustration. It will be noticed how very much it is like Sycamore pollen, the principal difference being the boat-shaped form when dry. The processes are irregular and are not on the granular portions, which corre-

honey in it? The honey is so thick that there was considerable difficulty in extracting in an extractor without gearing, from 4 to 8 ozs being left in each frame. Is it unusually thick? We are so far free from Isle of Wight disease in our district, but have been much troubled with black brood. In 1909, thirty-two hives were affected out of about 200 in the district. In 1910, when the Association took the disease in hand, thirty-three hives were affected; these have been reduced to eighteen, and we hope in about two years to stamp it out.—E. J. WALKER.

[The honey is from fruit blossom and hawthorn. It is impossible to give the percentage of each.—ED.]

### SWARM CONTROL.

[8188] For many years past I have tried various methods of swarm control, and discovered about five years ago a very simple but reliable method that will work in all stages of condition. It is as follows:—Select the method which suits your purpose best to supply as many queens as are required for the apiary. When they are hatched and removed from their hives, before they have fed if possible, such queens may be run in to any hive that we desire to prevent from swarming; it should be done in the middle of a fine day, when bees are gathering freely; run in the young queen at the entrance. No care need be taken of the old queen, unless she is required for further use. "What about queen-cells?" may be asked. If any are present, the young queen will look after them. I have run in from ten to fifteen a day, until I have re-queened the whole of my apiary without a single failure. Of course, the young queen would not commence to lay as early as she would if the colonies were queenless for a few days, but this difficulty can be overcome by confining a couple of hundred bees or so in a wire screen cage (a one-piece section case will do for this purpose very well, by substituting perforated zinc for the glass). Remove these bees to a dark room, and feed with syrup for thirty hours; they will prepare for supplying the royal jelly which the young queen is in need of after hatching, before she takes her mating flight. I have introduced such a queen to a strong colony having four sets of standard frames, and one of shallows above their brood nest, and found their old queen thrown out within ten minutes. On opening the hive at the end of fourteen days, I have found the ruins of over thirty queen-cells, and the queen commencing to lay. No doubt this method will suit many a novice as well as the practical man. Should it be preferred to buy virgin queens rather than to

raise them, they should be taken indoors and removed from the travelling cage in front of the window, so that if they fly they may be easily caught again. Remove the queen and cage her in a match-box, and keep her without food or bees for at least thirty minutes, then place her on the alighting board of any hive that you desire to keep from swarming.—F. STAPLETON, Gwinear, Hayle.

### A REPORT FROM MICHIGAN.

[8189] I have just moved to this district of Litchfield, Michigan, from Waseca, as I am making a change to give my children better educational advantages. Michigan is also a good bee country. The State of Minnesota has just passed a very good bee law that will enable the real bee-keeper to protect himself against the carelessness of others. I will enclose a copy if I can get hold of one.

Bees here generally wintered well, but the spring has not been a very good one for building up stocks. The long-continued dry weather of last year has very much injured the white clover, but there is a good prospect of a fine honey flow from basswood (linden). Unfortunately this tree is not abundant, and only a few are located within reach of it.

Last week I visited one of the largest bee-keepers in Minnesota. He has some 400 colonies and gets good results. His success is due in a large measure to the use of the best equipment and always keeping ahead of the bees. He keeps the bees—they do not keep him. He is more than a bee-keeper, he is also a honey producer. The bees are located—100 colonies at home and the balance in four outyards, and are worked mostly for extracted honey. The bees are the best three-banded Italians that can be had.

I am sorry to see that the Isle of Wight disease is doing so much damage in England, and hope the cause will soon be discovered—for prevention will be better than cure.—EDWIN EWELL, Minnesota, U.S.A.

### THE SOLAR WAX-EXTRACTOR.

[8190] I have been reading the "Australasian Bee Manual," by Isaac Hopkins, with great interest. Except for the seasons, which, of course, are different from our hemisphere, the manual could be used with us as it is. I was especially interested in reading the chapter regarding the Solar Wax-extractor, which appliance has been my special "protégé" for many long years, and which I have described in the "B.B.J." in the "eighties" of the last century. Many who have wished to try this form of wax-extractor have been disappointed, as very few appear able to make it in the proper size, according to

the climate, where it is to be used. The main points for a successful apparatus are that the size corresponds, that there are two glasses, and that the receptacle (the conic basin in which the melted wax runs) is inside the same, so that the impurities which run in the basin together with the melted wax have time to sink to the bottom before the wax gets stiff. The wax-extractor of Mr. Hopkins has changed face, but is on the same principle as my protégé, and I would not hesitate to recommend it, equally with the one I use, which has an advantage over its Australasian brother in the reflector which, when the apparatus is out of use, serves as the cover of the glasses, whilst, when in use, adding to the power of the sun rays. I enclose a photo of my old

the combs. On Wednesday (17th) I smoked it in the morning and killed twenty, and in the evening and killed ten, but I found that the tobacco was too damp to burn, and little, if any, tobacco smoke had been used. So I soaked a few leaves in a saturated solution of salt-petre, dried that fairly, rolled it and brown paper up together to nearly the thickness of my little finger, and used about 1½ to 2 inches in the smoker. This stupefied the bees and about 2,000 were left on the floorboard. Now on these bees, I found no fewer than seven of the brown lice, as active as ever, proving that what stupefies the bees has but little effect on the parasites. After I had caught the seven with forceps, I found another nine, making fifty-five to that point. Seeing that the stupefying

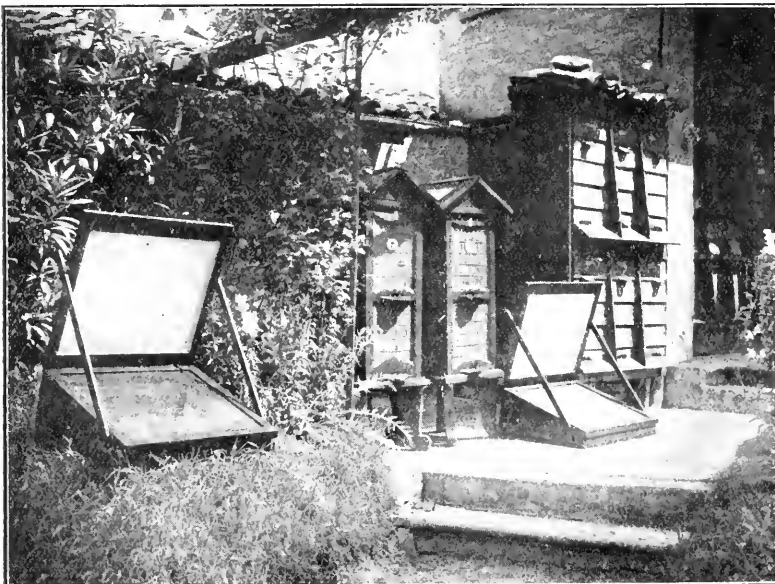

MR. SCHRÖDER'S SOLAR WAX-EXTRACTORS IN USE.

extractors in use.—ALEX. SCHRÖDER, Trieste, Austria.

**BRAULA COECA OR BLIND LOUSE.**

[8191] Little information about these pests seems available, so a few notes may be interesting.

I fed my bees on warm syrup in the open during the early spring, the heat being maintained by one single strand of wick in methylated spirit at a cost of about a half-penny per day. Twice or thrice I saw a braula on a bee, and on my first inspection, on May 9th, I located them. On Monday, May 15th, I smoked the hive with brown paper and tobacco-leaf and killed nine; first blowing in smoke at the entrance, and then between

process gave the braula such excellent opportunities to escape on the reviving bees—for none of them died—I decreased the dose; every day on examining the hive I found the parasites, some old, some young, in varying numbers, which gradually decreased until the end of May. Thereafter I found none till Thursday, June 15th, when I removed the floor-board without any smoke and found, alas! one lively young louse.

The stock is strong, working well in two supers, but the bees have had at least 111 of these parasites among them. The treatment has made them cross and ready to sting, so that my last operation was not performed without the self-sacrifice of eight or ten bees at least.

The young lice have not the beautiful comb which is seen on the feet of adults, and which, doubtless, helps them to cling to the bees, and gives their feet a strange, broad appearance. Beyond the comb they have a beautiful, transparent cushion. The young are pinkish, the adults brown.

I think they must be viviparous, for although I examined the floor-boards latterly with a lens magnifying sixteen diameters, I never saw an egg.

Some further description of these little pests by the Editor would be exceedingly interesting.—JOHN W. MOIR, Edinburgh.

#### A NEW CURE FOR BEE-STINGS.

[8192] In describing this cure as *new* I confess to some trepidation, for it so often happens that what one fondly imagines to be an original observation has been already placed on record by some earlier experimenter. Indeed it would not surprise me if the writer of "Cappings" were even to quote Aristotle or some other ancient classic as an early authority on the subject. However, during the many years that I have regularly perused the BEE JOURNAL, I believe I am safe in saying that it has not appeared in its pages, and therefore may be as new to many other bee-keepers as it is to me. The material in question is a preparation sold by most chemists, known as *Hazeline*. I first applied it to a sting on my hand within a minute or two of receiving the sting: no swelling resulted, and I felt no effect whatever from the sting. With me a bee sting takes what I suppose is a fairly normal course. Almost at once a little raised spot about the diameter of a three-penny piece makes its appearance immediately round the puncture, the spot being rather whiter than the surrounding flesh. Then gradually the flesh becomes red and inflamed over an area of two or three inches or more, and at the same time swells up, becoming "puffy," and rather tender to the touch. Except when the sting happens to be near the eye (a favourite point of attack) in which case it sometimes causes slight headache, I experience no pain or other inconvenience beyond the swelling which usually entirely subsides in about twelve hours. After the first experiment I decided to put the *Hazeline* to a much severer test, and an opportunity lately occurred for doing so. I was cutting out some queen cells from a recently swarmed hive, and during the operation received five stings on my left hand and wrist. I allowed the stings to remain until I had finished operations (certainly not less than five or

six minutes). I then removed the stings and waited another three minutes before applying the *Hazeline*, just dabbing a drop on each of the five stings. The application therefore was not made until at the very least six or seven minutes after receiving the first of the stings. There was no inflammation or swelling whatever, and after the lapse of a few minutes I could not have told that I had been stung at all. Since then I have several times used this cure and each time with the same complete success. I have not however had an opportunity of trying its use on anyone but myself, but I hope other bee-keepers will try it and find it as successful with them as it is with me. A single bottle of *Hazeline* would last a bee-keeper a natural lifetime, even if his bees were crossed Italians and British Blacks.—G. S. N., Godstone.

## Queries and Replies.

[1418] *Parasite in Bees*.—I send herewith a piece of comb taken from one of my hives. You will see that on the top face of it there are many brood cells not fully capped over and the brood appears to be mostly dead. I found some like this in one of my hives several years ago, and it seems to be some very contagious brood disease, for in spite of the utmost care on my part it has considerably spread. The hives that contain it do not prosper and naphthaline seems to have no effect upon it. I thought at first it might be caused by an overdose of naphthaline, but am persuaded such is not the case, as it is found where none is used. Some combs will contain but a few cells of it, while in others half the cells are affected. Can you tell me what it is please, and suggest any method of treatment? I have almost made up my mind to treat the colonies affected on the brushing off and starvation plan as done with foul brood (*Bacillus alvei*), but should prefer something less drastic if possible.—W. H. (Berks).

REPLY.—We have examined the comb sent, and found several cells not com-



pletely capped, with nearly fully-developed bees in them. These were dead, but live bees were emerging in the cells surround-



ing them. Examined under the microscope, the juices appeared normal, but there were occasionally found hair-like worms which twist and coil in all directions. The illustration shows four of those found. These appear to be a genus of entozoa, probably a species of *Meris*, which is sometimes found in the intestines of insects, and was probably introduced with the food by worker bees, who had acquired them with the water they had carried into the hive. The worm deposits its eggs in watery places, and bees carry them in this condition into the hive. The emerging brood was quite normal. We know of no remedy except removing the brood combs containing such cells. Frequently dead brood is due to constitutional weakness, and in such a case, the only remedy is the removal of the brood, renewal of the queen, with the addition of emerging brood or young bees from a healthy colony.

---



---

#### AMERICAN AND COLONIAL PAPERS.

##### EXTRACTS AND COMMENTS.

By D. M. Macdonald, Banff.

*An Avocation for Women.*—Miss Hoffman, a daughter of the inventor of the Hoffman frame, so popular in America, contributes a delightful article on bee-keeping for women in the page conducted by Miss Wilson in the *Canadian B.J.* Remunerative compared with other occupations, she still admits it has its advantages and disadvantages. In a good season the pursuit will yield a better income than that derived from her sister's teaching. Then the season for the honey-flow is short, whereas the other works all the year round. The woman who keeps bees lives and works at home, and can attend to other family and household duties. While a woman cannot farm alone, she can do all the work of her apiary without help from men. She owns that it is not a "get rich quick" business, but, all the same, it will provide a comfortable income for the right man or woman. She manages 200 colonies, and last season, from 170, had a surplus of 14,000 pounds. That is very creditable indeed. Judging by the very handsome face and figure in the photograph illustrating the article, bee-keeping agrees well with Miss Hoffman, as she looks the picture of good health. Can any of our lady bee-keepers give us figures in any way matching the foregoing to show how they make the pursuit pay?

*Swarm Prevention.*—This is the most engrossing subject in the bee-keepers' minds at present. *Gleanings* outlines the following well-known plan as the best out of many. "Two full depth borders were given and the queen allowed the full range of all frames up to the honey flow, when the upper story was removed and the best combs of brood given to the lower. The rest of the brood was given to nuclei, or to two-storey colonies not yet up to full strength. Then a half-depth body was put on temporarily, and when the bees were nicely started it was removed and a comb honey super put on instead. The idea of using the extracting super at first was to get the bees into the habit of going above. The secret of swarm control here outlined is in having a large brood nest up to the beginning of the honey harvest. In other words, there should be so much room that the colony will have no thought of swarming. Subsequent conditions should be such as to encourage work, WORK, WORK, not loaf, loaf, loaf, until swarming preparations are made. A colony that begins to feel cramped just at the beginning of the harvest is liable to get into the swarming notion." This plan is practised to a considerable extent in this country, and a splendid array of bees should be ready to profit fully by a late flow like the heather. It is indeed one of three plans I gave many years ago whereby a very strong force can be secured for super work in August.

*Jottings.*—Mr. Doolittle says that his experience, based on many carefully conducted experiments, satisfies him that the claim that tin separators have a tendency to cause less work in sections and a decrease in yield is more theory than fact. Mr. E. D. Townsend considers that some of the volatile oils evaporate when extracted honey is left exposed, and so some of the beautiful aroma is lost, thus placing honey nearer the level of the cheaper sweets. He contends that canning should be done as soon as possible after the honey is removed from the comb. Mr. J. L. Byer maintains that if the top of the hive is sealed down, the least trace of foul brood can be detected at the hive entrance by anybody acquainted with the characteristic odour. At times he has spotted a colony which, when examined, contained only a dozen diseased cells. Mr. Root pleads for more apiaries and fewer bees in each apiary. Where there is one yard that will support 200 colonies there are ten that will not support more than fifty. His conclusion is the result of ripe experience. The much belauded Italian has its faults, it seems! They breed up well for a full flow and then stop breeding altogether. Even stimulative feeding fails to induce them to resume and work up

for a second flow. Many are going in for a cross between them and Carniolans. These bees do not "ward" themselves on the first preliminary honey flow.

*Colour and Temper.*—Mr. J. E. Crane does not go the "whole hog" in maintaining that black clothes lead to stinging. He says: "My only contention has been that they will sting something or some person they are accustomed to less than one they have rarely or never seen before." Two hundred years ago an ancient writer advised the bee-keeper to get "familiar" with his bees, and so get them to love him in return!

*Moving Pictures*—A series of these have been appearing in *Gleanings* for some time. Mr. Holterman was shown lifting hives and carrying them about as if they were featherweights, because he had the knack of placing the weight where it could be best resisted. Mr. Townsend has appeared as the guide, philosopher and friend to the beginner, who is being shown how various manipulations should be carried out. Mr. Metcalfe is shown opening a hive, brushing bees off the combs, transferring the beelless combs to the wheel-barrow, then when consigning them to the extractor dealing with them there, and later returning them to the hives, the illustrations showing plainly how time may be saved. There is certainly a great deal to be learned from first-class models shown just as they do the various "stunts" in their own home apiaries. Those who work for comb honey are promised a treat in future issues when Mr. House, a New York Stater, will appear in a series of moving pictures illustrating his methods of comb honey production.

## WEATHER REPORT.

### BARNWOOD. GLOUCESTER.

May, 1911.

Rainfall, .82 in.	Mean temperature
Below average.	for month, 55.2; .7
Heaviest fall, .38 in.	of a degree above
on 3rd.	average.
Total to date, 6.22 in.,	Relative humidity,
as compared with	or percentage of
10.21 in. for the cor-	moisture in the air
responding period	at 9 a.m. 70.
of last year.	Number of days with
Mean maximum tem-	sky completely
perature, 65.7; 2.7	overcast at 9 a.m.
above average.	7; do. cloudless,
Mean minimum tem-	3.
perature, 44.7; 1.3	Percentage of cloud
deg. below the	53.
average.	Percentage of wind
Warmest day, 29th,	force, 16.
.76,	Prevailing direction,
Coldest night, 20th,	N.E.
3.35.	

F. H. Fowler (F. R. Met. Soc.).

## Bee Shows to Come.

*A nominal charge of 2s. 6d. is made for notices (not exceeding 7 lines) in this column, 10 lines charged 3s. 6d., up to 15 lines 5s., which covers cost of insertion from order till date of show. Cash should accompany orders for insertion.*

**June 26 to 30, at Norwich** (Royal Agricultural Society's Show).—Bee and Honey Section under the management of the B.B.K.A.

**July 13 and 14, at Brigg, Lincs.**—Lincolnshire B.K.A. Great Show of Honey, Hives, and Appliances, at the Brigg Exhibition of the Lincolnshire Agricultural Society.

**July 19 and 20, at Stafford.**—Honey Show in connection with the Staffs. Bee-keepers' Association. Four open classes. Schedules from Joseph Tinsley, 22, Granville Terrace, Stone, Staffs. **Entries close July 10.**

**July 20, at Southwell.**—Annual Show of the Notts B.K.A., in connection with the Horticultural Society's Show. Open class for Single 1-lb. Jar. First prize, 20s. Schedules from Geo. Hayes, Mona Street, Beeston, Notts.

**July 25, 26, 27, at Gloucester.** Annual Show of the Gloucestershire B.K.A., in connection with the County Agricultural Show. Separate tent for Honey, Wax, and Appliances. Open classes. Special prizes. Schedules from Rev. F. H. Fowler, Barnwood Vicarage, Gloucester. **Entries close July 18.**

**July 26 and 27, at Cardiff.**—Annual Show of the Glamorgan B.K.A. in connection with the Cardiff and County Horticultural Show. Separate tent for honey, wax, and appliances. Open classes. Special prizes. Schedules from Hon. Sec. Mr. Wiltshire, Mandy School, Cardiff.

**July 27, 28, and 29, at Rotherham.**—Show of Hives, Honey, &c., in connection with the Royal Yorkshire Agricultural Society. Schedules and Entry Forms from Secretary, Blake-street, York. **Entries closed.**

**August 2, at Stoke Park, Guildford.** Annual Exhibition of Bees, Wax, Appliances, &c., will be held by the Surrey B.K.A., in connection with the Guildford and West Surrey Agricultural Association. Nineteen classes (five open to all). Many medals. Schedules from F. B. White, Hon. Secretary, Marden House, Redhill, Surrey. **Entries close July 22.**

**August 3, at Weston-super-Mare.**—Annual Show of the Somerset B.K.A., in connection with the important Local Annual Flower Show. Classes for Appliances, Honey, Wax, and Bee Products. Several open and free classes. Liberal prizes. Numerous attractions. Excursions from all parts. For Schedule, &c., apply to T. Jones, Assistant Show Secretary, North View, Milton-road, Weston-super-Mare. **Entries close July 29.**

**August 7 (Bank Holiday), at Cambridge.** Honey Show in connection with the Cambridge Mammoth Show Society. All Open Classes, four Special Hives to be competed for. This Show also includes dogs, poultry, pigeons, rabbits, cage birds, flowers, fruit, and vegetables; also grand programme of sports and motor racing, &c. Balloon ascent and parachute descent by Captain Spencer. The champion prize band (Irwell Springs) has been specially engaged. Schedules from Hon. Sec., E. F. Dant, Member of B.B.K.A., 52 Bridge Street, Cambridge. **Entries close Thursday, August 3.**

**August 16, at Lancaster.** Lancaster Agricultural Society, in conjunction with the Lancashire B.K.A. 16 Classes for Honey, Bee Produce, and Bee Hives. Numerous specials, including 2 silver challenge cups, 12 silver and bronze medals. Write for Honey Schedule to Robert Gardner, 13, Sun St., Lancaster. **Entries close August 2.**

**August 23, at Radstock, Somerset.**—Honey Show in connection with the Radstock Horticultural and Farmers' Association. Open and gift classes. Write for Honey Schedule. B. M. Clark, Foxhills, Radstock.

August 23 and 24, at Shrewsbury. Show in connection with the Shropshire Horticultural Society's Great Fête. Eight Open Classes for Honey. Free entry for single bottle and single section. Schedules from S. Cartwright, Hon. Sec., Shawbury, Shrewsbury. Entries close August 11.

## Notices to Correspondents.

Letters or queries asking for addresses of manufacturers or correspondents, or where appliances can be purchased, or replies giving such information, can only be inserted as advertisements. The space devoted to letters, queries, and replies is meant for the general good of bee-keepers, and not for advertisements. We wish our correspondents to bear in mind that, as it is necessary for us to go to press in advance of the date of issue, queries cannot always be replied to in the issue immediately following the receipt of their communications.

- A. F. (Lancs.).—*Queen Cast Out*.—The queen is an old one, and also appears to have been injured in some way.
- J. C. B. (Bidston).—*Bee Plant*.—The plant is too dry and shrivelled to be recognised, but appears to be one of the labiates, which are all more or less visited by bees. We do not think it would be worth sowing as it flowers at a time when pasturage is plentiful. To be of any value plants should be selected which flower when ordinary pasturage is scarce.
- J. E. S. (North Finchley).—*Brood Cells not Capped*.—The non-capping of some of the cells is sometimes due to wax-moth passing over and through the combs. At other times, for some reason or another some of the cells are left uncapped, but this does not prevent the bees from maturing. In some cases the nearly full-grown bee dies in such cells, and we have found a hair-like parasite in the bee which no doubt caused its death. This parasite is probably obtained from the water collected by the bees.
- J. H. S. (Leicester).—*Bee-Keeping in Queensland*.—(1) With the great diversity of climate, ranging from temperate to torrid, this State is able to produce almost all the fruits of the known world. The apples and pears, plums, strawberries, gooseberries, cherries, and other fruits of Europe, the mangoes of India and fruits of Java, Japan, and China, the grapes, oranges, guavas, pomegranates, &c., of temperate climes, the walnuts, filberts, chestnuts of cold countries, the pine-apples of the West Indies are all grown there to perfection, and most of them, especially oranges, lemons, pine-apples, peaches, &c., on a commercial scale. You would therefore have no difficulty in keeping bees on a moderately large scale if you made suitable selections of localities. Of course
- it would be better for you to select the places when you arrive in the country, after you have made yourself acquainted with the surroundings so as to be near the best pasturage. (2) A British expert certificate would be useful if you were seeking Government or other employment, but is not needed if you are going to start bee-keeping on your own account. (3) To obtain a third-class certificate you would have to pass an examination in practical work during the summer. The examination for second class is held in November, and for first-class the following May.
- E. F. N. (Shrinagar).—*Kashmir Queen*.—(1) This queen differs from the English black bee in being slightly larger, the legs are covered with lighter brown hairs, those on the thorax also being of a lighter rufous colour. The abdomen is distinctly marked. The first segment, that next to the petiole or waist, is densely covered with brown hairs. The second segment has a plain shining black band with a fringe of hairs, below which there is a dull black band. The fourth and fifth segments are similar except that they have brighter brown bands. The sixth segment is tipped with hairs. (2) She was a young queen not fertilised.
- W. H. U. (Haydon Bridge).—*Queen and Worker*.—One is an old queen, the other merely an ordinary worker bee.
- J. N. (Old Cummock).—*Increasing the Density of Honey*.—If you mean that you wish the honey to granulate you can advance this by exposing it to light and cold. Honey varies in density when in a liquid state, according to the flowers from which it is gathered, and the district. Let it remain on the hive as long as possible, when it will ripen and become thicker.
- RAILWAYMAN (Basildon).—*Virgin Queen Cast Out*.—The queen is a young one. Probably the old queen died, and the bees had reared others, and the one you send has been one of those cast out. The excitement was evidently caused by the virgin taking her mating flight.
- Suspected Disease.*
- EKAL (Essex).—A case of sour brood. Requeen the stock, and use "Apicure."
- T. R. E. (Essex).—We regret to say that the comb is affected with foul brood. The remedies you are using will no doubt be sufficient to effect a cure.
- C. W. (Hale).—The piece of comb shows that odourless foul brood is affecting the stock. This is less virulent than the ordinary type, and more easily cured. Full instructions as to treatment are given in Guide-Book.

**Special Prepaid Advertisements**

**Two Words One Penny**, minimum **Sixpence**. Orders for three or more consecutive insertions entitle advertisers to one insertion in "The Bee-keepers' Record" free of charge.

**Trade advertisements of Bees, Honey, Queens, and Bee goods are not admissible at above rate, but will be inserted at 1d. per word as "Business" Announcements, immediately under the Private Advertisements. Advertisements of Hive-manufacturers can only be inserted at a minimum charge of 3s. per ½ in., or 5s. per inch.**

**PRIVATE ADVERTISEMENTS.**

**TWO NEARLY NEW W.B.C. HIVES**, complete, with Frames, shallow frames, and sections, 12s. 6d. each.—**KINGSTON**, P.O., Skelton-in-Cleveland. k 28

**HALF-TON** of finest English Honey for sale, with gross of sections, more or less, part delivery in July, remainder in August. Apply G. W., B.B.J. Office, 23, Bedford-street, Strand, W.C. k 38

**HEALTHY** Drawn Shallow Combs, racks of 8, 4s. each. Bugden, Wye, Kent. k 39

**GOOD** Stocks on 8-frames 1911 Queens, 20s., 10 frames 25s., 3 frames nuclei 12s. 6d., 4 ditto 15s. Barlow, Stanley-terrace, Newcastle, Staffs. k 41

**FOR SALE, COTTAGE** with 3 acres of land, fruit, poultry, 40 hives bees, and good connection for sale of honey.—9, "B.B.J." Office, 23, Bedford-street, Strand, W.C. k 45

**STANDARD COMBS**, healthy, 10s. per dozen.—**DAVID HUNTER**, Abington, Scotland. k 44

**WANTED**, first grade Sections and Extracted Honey (English).—Apply, stating price, to R. S., care of "B.B.J.," 23, Bedford-street, Strand, W.C. k 27

**FOR SALE**, 4 double-walled Hives, good as new, take 3 crates, 7s. 6d. each, including 2 section racks.—**CRUICKSHANK**, Spey Bridge, Grantown-on-Spey. k 32

**OWING REMOVAL**, must sell 2 healthy Stocks Bees in bar-frame, non-swarmer, new hives, also appliances. Offers, free on rail.—**JONES**, Emlyn House, Llanguennech. k 33

**FOUR DOZEN** finest grade white clover Sections, 10s. dozen.—**NORTH**, Cressing, Baintree, Essex. k 31

**WOULD EXCHANGE GOOD GOAT**, in milk, for Frame Hives, must be free from disease.—**F. BATES**, Breach Cottage, Cholsey, Bucks. k 29

**FOR SALE**, first-class Apiary, 40 hives, honey shed and all appliances, situate Marlborough, Wilts, no reasonable offer refused; inspection invited.—Apply, **WADEMAN**, 5, Gold-street, Roath, Cardiff. k 26

**5 HIVES**, painted, perfect condition, 4s. each, cost 15s.; 10 Racks, sections fitted foundation and dividers, 2s. 6d.; 2 Smokers, 1s. each; no disease.—**WEST**, Becroft, Bridgemary, Fareham. j 97

**QUANTITY TAYLOR'S BEE GOODS** (new), crates, frames, sections, foundations, metal-ends, glass supers for skeps, queen excluders, &c. 15% discount.—**WELLBOURN**, Cranswick, Beverley. j 99

**WANTED**, a few Skeps of Bees, with old and tough combs for driving purposes.—**HERROD**, "Bee Journal" Office.

**Special Prepaid Advertisements.—Continued****BUSINESS ADVERTISEMENTS.**

**SECTIONS**, new, wanted by the Honiade Co., 20, Moorfields, E.C. k 30

**PRIME HEALTHY SWARMS**, 12s. 6d. to 15s. 6d., boxes free; Skeps, 15s. 6d.; Frame Hives, 30s. Prompt attention and satisfaction assured.—**Higginson**, Egerton, Kent. k 40

**SECTION GLAZING**.—Best quality Lace Paper, made especially for Bee-keepers' use, not common box edging, white, 100 6d., 500 1s. 4d., 500 2s. 3d., 1,000 3s. 9d., post free; blue, green, or pink, 100 7d., 300 1s. 6d., 500 2s. 6d.; Lace Bands, 2½ in., 3in., and 5½ in. wide, white, 100 1s. 2d., 200 2s. 3d., 500 4s.; a few in pink and blue, 100 1s. 4d., 200 2s. 6d.—**W. WOODLEY**, Beedon, Newbury.

**HONEY**, First-Class, 56s. per cwt., tins returnable; sample, 2 stamps. **F. Crick**, Firwood Cottage, Halstead, Essex. k 36

**APIARY** of 6 Hives for sale, boiling over with Bees, 10 spare Hives, Honey Extractor, 10 Crates Sections, 8 Racks, Shallow Frames, 30 Brood-combs, cheap. Particulars, **Watts**, Chickereil, Weymouth. k 37

**HIVES FOR SALE**. Stand, floor board (with specially designed feeder saving time and giving great efficiency), 2 12-framed bodies and zinc-covered, telescopic roof, guaranteed healthy and good condition, 6s. each. **Hillman**, Stonehouse, Glos. k 42

**NUCLEI FORMING BOX**. Virgins introduced with little trouble and certainty of success, box and instructions complete, 2s. each. **Hillman**, Stonehouse, Glos. k 43

**SWARMS**, guaranteed healthy, 10s.; Queens, 3s. 6d.; 3 tractor Nuclei, 8s. 6d.; Wanted, Solar Wax-Extractor.—**WILSON**, Burry-road, St. Leonard's-on-Sea. k 35

**SPRING BEE ESCAPES**, 4d. each; Super Clearer Boards with above, 1s. 6d. each; Metal Ends, 1s. 6d. gross; all post paid.—**H. CRESSY**, Friary Mill Apiary, Dorchester. k 34

**SECTIONS** of HONEYCOMB wanted to purchase for cash.—**T. SMITH** and Co., Cambridge-street, Hyde Park, W. k 13

**QUEENS** from Doolittle stock, virgins, 1s. 6d.; Terjiles, 5s.—**D. G. TAYLOR**, Hminster. k 17

**EXTRACTED HONEY** bought in any quantity; prompt cash; receptacles sent.—Send sample, stating quantity, **SPRING** and Co., Ltd., Brigg, Lincs.

**CHOICE**, fertile, black Queens, 5/- each.—**WILKES**, Lichfield-road, Four Oaks, Birmingham.

**BRICE'S 1911 QUEENS**, Hybrids, 5s. 6d.; blacks, 5/-; in introducing cage; delivery guaranteed.—**BRICE'S APIARIES**, Offord, Kent.

**EVERYTHING** for successful Bee-Keeping, for the amateur and the professional, prime quality, moderate prices. See our new large illustrated catalogue now ready, and sent post free to enquirers. The fullest and most helpful catalogue that is published.—**SEEDS AND BEES**, Ltd. (George Rose), 22, Bolton-street, Liverpool. The British and Irish Bee-keepers' Prompt Supply Stores.

**1911 QUEENS**.—Golden Italian Queens, 1911, pedigree brood rearers, guaranteed fertile, pure, mated in Italy, healthy, hardy, prolific, price 4s. each; specially selected, 7s. 6d. Terms cash.—**J. B. GOODARE**, Woden Apiary, Wednesfield, Wolverhampton. j 96

## Editorial, Notices, &c.

### OBITUARY.

MR. W. Z. HUTCHINSON.

It is with sincere regret that we have received the news of the death of Mr. Hutchinson, of Flint, Michigan, the able editor of the *Bee-keepers' Review*, which took place on 30th May last, after a long illness.

Mr. Hutchinson was born in Orleans, Co. N.Y., on 17th February, 1851, and

keepers to gather more information. Mr. Hutchinson began bee-keeping in 1877 with four colonies and a good theoretical knowledge of the business. He had by diligence and perseverance been able to make a comfortable living by the sale of comb-honey which he obtained by hiving swarms on frames without foundation. His methods were explained in *Gleanings* about twenty-five years ago, and aroused much interest at the time, so that he was prevailed upon to write a booklet describing his system. This appeared in 1887 under the title of "The Production of Comb Honey." In 1888 he started the

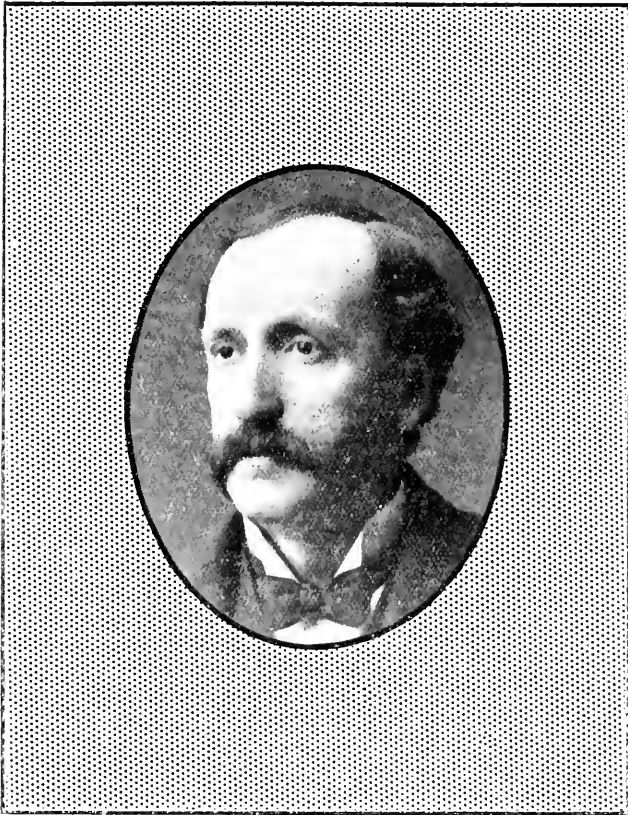

THE LATE MR. W. Z. HUTCHINSON.

was therefore sixty years of age when he died. He migrated with his family to Michigan. At eighteen years of age he began teaching in school in winter, and while doing so came across King's "Text Book" which opened his eyes respecting bee-keeping. Mr. Hutchinson asked the owner of the book, who had fifty colonies, to let him see them, and he thus became acquainted with moveable comb-hives which made him interested in bees. He read all about them and visited bee-

*Bee-keepers' Review*, which he edited with great ability, and which filled a place not previously occupied. The distinctive features were those of reviewing current apicultural literature, and gathering together from every source the best that was known upon any given apicultural subject. In 1891 he brought out "Advanced Bee Culture," which has passed through several editions, the last one which appeared in 1905, printed on the finest enamelled book paper, and

beautifully illustrated, was enlarged to 230 pages. This edition was exhausted some months ago, and Mr. E. T. Root wrote to Mr. Hutchinson to ask him to get out a new edition. Unfortunately at that time he was in the hospital, where he had been for some months. As there seemed no prospect of immediate recovery it was arranged that Mr. Root should revise the book. This has been done and Mr. Hutchinson had expressed his entire satisfaction with the manner in which new matter had been joined to old, and that there had been made just such changes as he would himself have made had he possessed the health and strength to do it. The book will have a melancholy interest, in the knowledge that its author only just lived long enough to see the revision completed.

As a writer on bees, Mr. Hutchinson had few equals. He was clear and concise, and his love of the pursuit was shown on every page. We had known him since 1887, and our intercourse had always been of the friendliest, as can be gathered from the letter of his on page 34 of "B.B.J." for 1910. His loss will be severely felt by bee-keepers, and we extend the sympathy of ourselves and British bee-keepers to his sorrowing widow and family.

## THE "ROYAL" SHOW AT NORWICH.

The seventy-second annual show of the Royal Agricultural Society of England, held this week at Norwich, has, we hear, been a very successful one so far as entries are concerned.

We give the prize-list in the bee and honey section, but will reserve until next issue our comments on the exhibits. The judges were Messrs. W. F. Reid (Surrey), C. L. M. Eales (Devon), A. G. Pugh (Notts), and the Rev. A. D. Downes-Shaw (Norfolk), their awards being as follows:—

### HIVES AND APPLIANCES

*Class 506.—Collection of Hives and Appliances including Suitable Outfit for a Beginner in Bee-keeping.*—1st, Jas. Lee and Son, 4, Martineau Road, Highbury, London; 2nd, W. P. Meadows, Syston, Leicester; 3rd, E. H. Taylor, Welwyn, Herts.

*Class 507.—Complete Frame-hive for General Use.*—1st, Abbott Brothers, Southall, London; 2nd, H. G. Tunstall, Rainhill, Lancs.; 3rd, Jas. Lee and Son; h.c., W. P. Meadows and E. H. Taylor.

*Class 508.—Complete Frame-hive for Cottage's Use, price not to exceed 10s. 6d.*—1st, E. H. Taylor; 2nd, Jas. Lee and Son; 3rd, Goodburn Brothers, Millfield, Peterborough; h.c., W. P. Meadows.

*Class 509.—Honey-extractor.*—1st, W. P. Meadows.

*Class 510.—Observatory-hive with Bees and Queen.*—1st, Goodburn Brothers; 2nd, Jas. Lee and Son.

*Class 511.—Any Appliance connected with Bee-keeping.*—1st, E. H. Taylor.

### HONEY.

Classes 512 to 515 confined to members of the North Norfolk Bee-keepers' Association.

*Class 512.—Four 1-lb. Sections.*—1st, H. W. Saunders, Thetford; 2nd, W. Norman, Harply Mills, King's Lynn; 3rd, H. Theobald, Brundall, Norfolk; 4th, F. Chapman, Edgefield, Melton Constable; v.h.c., W. M. Gaze, Aldeby Grange, Beccles.

*Class 513.—Four 1-lb. Jars of Extracted Light-coloured Honey.*—1st, R. W. Lloyd, Norwich Road, Thetford; 2nd, H. W. Saunders; 3rd, W. J. Norman; h.c., A. E. Jackson, Chalk Hall, Elvedon.

*Class 514.—Bees-wax.*—1st, H. W. Saunders; 2nd, J. Mayer, Hemblington, Norwich.

*Class 515.—Collective Exhibit of Honey in Sections, Extracted Honey, and Bees-wax.*—1st, W. F. Fake, Great Massingham, King's Lynn; 2nd, S. J. Mayer, Hemblington, Norwich; 3rd, J. Platten Briston, Melton Constable.

Entries in Classes 516 to 519 can only be made by residents in Cheshire, Cumberland, Derbyshire, Durham, Herefordshire, Lancashire, Leicestershire, Lincolnshire, Monmouthshire, Northumberland, Nottinghamshire, Rutland, Shropshire, Staffordshire, Warwickshire, Westmorland, Worcestershire, Yorkshire, the Isle of Man, Ireland, Scotland, or Wales.

*Class 516.—Twelve 1-lb. Sections.*—1st, R. Robson, Cheviot Street, Wooler, Northumberland; no 2nd prize awarded; 3rd, W. J. Woolley, Bridge Street, Evesham.

*Class 517.—Twelve 1-lb. Jars of Extracted Light-coloured Honey.*—1st, R. Morgan, Cowbridge, Glamorgan; 2nd, Dr. T. S. Elliott, Southwell, Notts; 3rd, J. H. Hadfield, Hamilton Place, Alford, Lincs.; h.c., J. Boyes, Queen's Head Hotel, Cardiff; J. Pearman, Penny Long Lane, Derby; and H. W. Seymour, Alford, Lincs.

*Class 518.—Twelve 1-lb. Jars of Extracted Medium or Dark-coloured Honey.*—No 1st awarded; 2nd, J. Pearman; 3rd, A. S. Dell, Leigh, Lancs.

*Class 519.—Twelve 1-lb. Jars of Granulated Honey.*—1st, J. Boyes; 2nd, A. W. Weatherhogg, Willoughton, Lincs.; 3rd, J. Woods, Nettleworth Manor, near Mansfield, Notts.

Entries in Classes 520 to 523 can only be made by residents in Bedfordshire,

Berkshire, Bucks, Cambridgeshire, Cornwall, Devon, Dorset, Essex, Gloucestershire, Hampshire, Herts, Hunts, Isle of Wight, Kent, Middlesex, Norfolk, Northamptonshire, Oxfordshire, Somerset, Suffolk, Surrey, Sussex, or Wiltshire.

*Class 520.—Twelve 1-lb Sections.*—1st, R. Brown and Son, Somersham, Hunts.; 2nd, R. H. Baynes; 3rd, H. Theobald.

*Class 521.—Twelve 1-lb. Jars of Extracted Light-coloured Honey.*—1st, R. H. Baynes; 2nd, R. Brown and Son; 3rd, R. W. Lloyd; h.c., L. W. Matthews, Great Rollwright, Chipping Norton.

*Class 522.—Twelve 1-lb. Jars of Extracted Medium or Dark-coloured Honey.*—1st, C. E. Billson, Cranford, Kettering; 2nd, A. D. Boulden, Broughton Monshalsea, Maidstone; 3rd, E. E. Gooding, Nacton Road, Ipswich; h.c., R. H. Baynes.

*Class 523.—Twelve 1-lb Jars of Granulated Honey.*—1st, A. S. Hoare, Trevollard, Saltash, Cornwall; 2nd, Miss F. E. Barker, Barnston, Dunmow; 3rd, Goodburn Bros.

*Class 524.—Three Shallow-frames of Comb Honey for Extracting.*—1st, E. C. R. White, Newton Toney, Salisbury; 2nd, R. Brown and Son; 3rd, W. M. Gaze.

*Class 525.—Six 1-lb. Jars of Heather Honey.*—1st J. Berry, Llanrwst, N. Wales; 2nd, A. White, 25, Glaisnock Street, Old Cumnock, Ayrshire; 3rd, A. F. Borland, The Knowe, Cumnock; h.c., M. T. Lamboll, Chiddingfold, Surrey, and T. Sleight, Danesmoor, Chesterfield.

*Class 526.—Six Jars of Heather-mixture Extracted Honey.*—1st, W. Dixon, 27, Central Road, Kirkgate, Leeds; 2nd, J. Woods; 3rd, J. Pearman; h.c., W. E. Brooking, Marlborough, Kingsbridge, Devon.

*Class 527.—Honey Trophy.*—1st R. Brown and Son; 2nd, W. Dixon; 3rd, J. Pearman; h.c., A. S. Dell.

#### MISCELLANEOUS.

*Class 528.—Bees-wax (not less than 2lb.).*—1st, R. H. Baynes; 2nd, E. C. R. White; 3rd, J. Pearman; h.c., J. Rowlands, Maes Apiaries, Pwllheli, and A. S. Hoare.

*Class 529.—Bees-wax (not less than 2-lb. in Shape, Quality and Package suitable for the Retail Trade).*—1st, J. Berry; 2nd, J. Pearman; 3rd, Goodburn Brothers; h.c., E. C. R. White.

*Class 530.—Honey Vinegar (1 quart).*—1st, R. Brown and Son; 2nd, G. W. Kirby, Priory Road, Knowle, Bristol; 3rd, J. Pearman.

*Class 531.—Mead (1 quart).*—1st, Jones Brothers, Monks Acre Apiary, Andover, Hants; 2nd, R. Brown and Sons; 3rd, R. Allen, Tusmore, Bicester.

*Class 532.—Exhibit of a Practical or Interesting Nature Connected with Bee-culture.*—1st, A. S. Dell; Certificate of Merit, W. Dixon.

#### HELPFUL HINTS FOR NOVICES.

By W. Herrod.

*Foundation.*—The condition of foundation after it has been kept on hand for some time often troubles the novice, who notices that instead of being clear and bright it has assumed a dull, whitish appearance and lost all its aroma. If used either in frames or sections in this condition, the bees are a long time before they accept it, and occasionally refuse altogether to work upon it. If they do accept it, more labour than usual is necessary, as the surface of the wax has become hard. It can be brought back to its normal condition by warming in the sun or in front of a fire. Where the foundation is wired, this warming is absolutely necessary, as the wax must be in a plastic condition, for if brittle, which it always is if not fresh, the embedder when run along the wires will break the wax.

*Hiving Swarms into Frame Hive.*—The novice usually undertakes this first operation in fear and trembling, and very often does the wrong thing in his anxiety to do right. We will suppose the swarm has been purchased, and has travelled some distance by rail. If bought by weight, the first thing to do when it arrives is to weigh it—travelling receptacle and all. When empty the latter is again weighed, and that amount deducted from the gross weight, when we have the net weight of the bees. Remember that bees lose weight in travelling on account of the food they have consumed before issuing being utilised. For instance a five pound swarm will lose from half to one pound in weight, and the price is based upon the weight immediately they are hived. After weighing, do not be in a hurry to liberate the bees, and be careful that they are put in a cool place. If in a skep, they should be taken into a cellar or cool dark room, and allowed to remain with the scrim covering the mouth of the skep upwards until the evening. Towards the middle of the afternoon give food by inverting a bottle feeder (covered with a double thickness of muslin instead of the usual metal-cap) over the scrim cloth. This prevents all possible chance of the bees being hungry and consequently angry when liberated. About an hour before hiving, hang the skep the right way up; (don't place it on the ground or the bees will be suffocated); the bees will all cluster at the top of the skep so that the covering can be removed when the time comes without a lot of bees adhering to it.

If in a proper travelling box the same procedure should be followed except that the box should be placed with the lid downwards so that it can be removed without bees adhering to it when the time comes.

The best time to hive a swarm is about six or seven o'clock in the evening. If attempted too early, especially when the sun is shining fiercely, heat and excitement will sometimes cause the bees to rise and abscond. If attempted too late, the bees do not run freely; they hang round, and if they settle upon the person they creep in amongst the clothes in search of warmth, instead of flying off as they will do earlier. The consequent application of pressure by the clothes is not conducive to the comfort of the bee-keeper, especially if it happens quite unexpectedly some hours later, which is more often the case than not. The hive is placed in position full of frames fitted with full sheets of wired foundation, a calico quilt only on top, with a bottle of food in position. The entrance to the hive should be propped up about an inch, and a board sloping from the alighting board to the ground over which a cloth is thrown to make a



**Bombus terrestris.**



**Bombus hortorum.**

plain even surface for the bees to travel up. The roof should be turned cornerwise to give ventilation.

Remove the covering from the skep or the lid from the box; do not break the latter in your excitement but search for the screws instead of prizing off the bottom with a screw-driver, which I have seen done repeatedly. The screws are sometimes at the side instead of the top. Bump the skep or box, mouth upwards, on the ground to make all the bees lose their hold, then shoot them down on the cloth. They will almost at once exercise their natural propensity of creeping uphill and march into the hive. Watch for the queen and see her safely indoors. At night lower the front of the hive to its normal position, and put the roof on properly. Feeding should be continued for at least a week, unless the weather is exceptionally fine and forage abundant, in which case the one bottle of food will suffice. If it is possible to obtain a frame of brood to place in the hive it will reduce the possibility of the swarm absconding to a minimum. Bees rarely forsake brood.

## Correspondence.

*The Editors do not hold themselves responsible for the opinions expressed by correspondents. No notice will be taken of anonymous communications, and correspondents are requested to write on one side of the paper only and give their real names and addresses, not necessarily for publication, but as a guarantee of good faith. Illustrations should be drawn on separate pieces of paper.*

### BUMBLE-BEES.

[8193] The frequent occasions on which bumble-bees are mentioned by correspondents in the "B.B.J." show that many of its readers are interested in them, and this is not surprising, for the bumble-bee is the only bee besides the honey-bee that lives in colonies containing workers and stores honey in its comb. The largest colonies are made by *Bombus terrestris* and *B. lapidarius*, and contain up to 300 workers. The habits of the bumble-bee are most interesting, and each species has peculiarities of its own. The queen bumble-bee is

an exceedingly intelligent insect and, when she is establishing her colony, tends her brood with as much devotion and care as a bird or quadruped, while she works in all weathers from dawn to dusk, discharging the nectar she collects into a large waxen pot or cell which she has constructed to receive it, and the pollen in niches beside her brood. As the bumble-bees hum busily from flower to flower in our gardens their large size and their handsome, gaily-coloured velvet coats make them objects of interest and pleasure even to the most casual observer. They perform a useful service in fertilising long-tubed flowers such as red-clover, horehound and honeysuckle, which are seldom if ever visited by honey-bees, because their tongues are not long enough to reach the nectar.

I am at present studying the distribution of the British species for my new book on them, and should be most grateful to any readers of the "B.B.J." who might like to help by sending me any unfamiliar-looking specimens for identification. I should be very pleased to return, correctly named, any pinned specimens sent,



provided they are in fairly good condition and stamps for postage are enclosed. Also may I ask to be excused from writing letters at this busy season unless something interesting turns up? Twenty species and three sub-species, comprising the genera *Bombus* and *Psithyrus*, are at present known to inhabit Britain. Most of these are common everywhere, but some are local or rare, and it is about these that more information is needed.

One of the most beautiful of the local species, *B. lapponicus*, is found only in mountain districts. Its coat is long; the thorax is black with narrow yellow bands in front and behind, and almost the whole of the abdomen—not merely the tip—is bright red. It has been taken in Perthshire, also at Huddersfield and in Wales.

Another fine local species is *B. distinguendus*. This is one of our largest species, and is entirely of a pale greenish-yellow colour with the exception of a black band across the thorax between the wings. It is a northern species said to be common in Yorkshire, and found sparingly in Scotland and even in Shetland.

*B. jonellus* is another northern species fairly common in many parts of Scotland and Ireland, but hardly ever seen in Kent. It has three yellow bands and a white tail, and is known from the universal *B. hortorum*—which is coloured very like it—by its short face, which is no longer than wide.

If we exclude *B. pomorum*, a doubtful native, the rarest British species is *B. cullumanus*, males of which have been taken in Suffolk, also at Southend, Brighton and Bristol, but not within the last thirty years. This bee is also rare on the Continent, and nothing is known of its habits.—F. W. L. SLADEN, The Firs, Ripple, Dover.

#### NOTES BY THE WAY.

[8194] Midsummer day has passed, but has not brought us *midsummer* weather. We have had for nearly a fortnight in this part a wet, cold, and sunless period; and as to the bees, alas! I have no good report to make of progress in the apiary. No sun means no work for the inmates of the hives, and no honey or swarms for their owners. I do not remember a more curious season, although I have been connected, more or less, with bees and bee-keeping all my life. It was in June, 1856—fifty-five years ago now—that I hived my first swarm, for a neighbour, whose bees were near our own, which I was set to watch. The present honey season opened well with a spell of gloriously fine, warm weather, and with every prospect of a good crowning year to compensate in some measure for the past sea-

sons, in which bees have done so badly; but the continued heat brought forward the grass crops so rapidly that the farmers cut all our principal bee forage much earlier than usual. The heat also scorched up the young aftermath, and now, since the rain has come, we get little sunshine and a low temperature. Given a week or two of warm weather, I am hoping to get super work completed, but so far, comparing this year with last, in regard to sections, I had more last year than this. If I had not carefully saved the combed sections I should have had but a very small number of finished ones this season. As to swarms, I am not getting any (four only) from either of my apiaries, and no present prospect of any more.

The only point in favour of this year—and I grant it is a good one—is that the hives are stocked with food of finest quality; the honey has been put into the brood-combs instead of the bees working the foundation in the sections for its reception. Where drawn-out combs were in the racks every one is filled, but the foundation is not started yet. Having many orders for swarms booked, I did not super many of my stocks till I found there was no preparation for sending off swarms. I have had a few letters from bee-keepers in other parts of England; some have done fairly well, others indifferently.

*Honey Prices.*—The price of section-honey is an important item just now. One gentleman writes he is making 12s. per dozen of his well-filled sections, whole-sale (glazed, I believe, as he ordered lace paper). I quite expect there will be a great scarcity of comb-honey, one reason being the great loss of bees during the winter and spring, and now the short period of honey-flow, owing to the early cutting of crops from which our bees gather the bulk of the surplus, coupled with this spell of broken, unsettled weather. Our Editor may be able to give those fortunate bee-keepers who have a good take a hint as to the price they should be able to get for really good quality, well-filled and sealed sections, glazed or boxed in glass-lid boxes.

*Wasps.*—We are very little troubled with wasps here, although our soil is sandy. I have killed a few during the past two months, but not nearly so many as in previous years. We have wax moth in this part rather badly; they are ever alert to perpetuate their species in any weak colony.—W. WOODLEY, Beeton, Newbury.

#### SWARM CONTROL.

[8195] Mr. Stapleton's letter in "B.B.J.," of 22nd June is most interesting, and indeed startling, as it disposes of some old-established theories of queen introduction. If the method proves successful in other hands than his, it will be

a boon to many small bee-keepers like myself, to whom swarming is nothing but a nuisance; and this nuisance nearly always arrives while the bee-keeper is away! If a sure preventive of a swarm can be obtained at a cost of say 2s. 6d. for a virgin queen, it will be money well spent. I should like to ask Mr. Stapleton one or two questions for the benefit of any who may intend to try his method as well as myself. (1) What is the minimum age of the old queen of the stock to which the young queen may be safely introduced? (2) Does it matter whether the stock be strong or weak? (3) Does the season of the year affect it, *i.e.* spring, summer or autumn? (4) How soon after hatching may and must the young queen be introduced to the established stock? (5) Can the race or strain be changed in this manner with no precautions? Mr. Stapleton's kind answers on these points will be much appreciated. If it is a fact that queens can be renewed without examination of frames and the usual hunt for the old queen, it promises easier bee-keeping.—**CAMPBELL R. PINKNEY, Sleights, R.S.O., Yorks.**

#### BEE-STING CURES.

[8196] I was much interested in the letter in "B.B.J.," June 22 (page 246) relating to bee stings and Hazeline, as this morning I have had an opportunity of putting it to the test. While helping me with my bees a friend got stung on the leg and wrist; at once we applied Hazeline, but so far it has had little effect. The strange thing is that my friend was stung more than a month ago, in the head, and last week, and again to-day, when stung in other places, her face was all swollen up, just where the old sting was in her head. Can you account for this? I am wondering if some bees sting more deeply than others, as I was stung in the hand some time ago, and it swelled up so badly that I had to have it in a sling, and felt the pain for nearly three weeks. I find the old blue-bag cure, and keeping the wound covered from the air, about as good as anything.—**L. A. SNOW, Broadway Vicarage, Worcs.**

#### PREVENTING INCREASE.

[8197] In the "Queries and Replies" column in "B.B.J." of 8th June (page 227, No. 4135), I was interested to see a query on preventing increase. The problem of swarming is a difficult one when one is working entirely for surplus. I intended adopting a method this year which I hoped would meet the difficulty. Unfortunately, through winter losses, I am unable to experiment, as I hoped, but if you think the plan detailed here of

any value to your readers, I hope you will make use of it. My idea is as follows:—When the body box, or brood chamber, is becoming crowded with bees, and the possibility of swarming will soon have to be faced, I propose to place a rack of shallow frames, fitted with foundation, under the brood-chamber, with a wire queen excluder between (I say wire-excluder for the reason that it would not check the carrying up of pollen as one of zinc is likely to do). Of course this could only be adopted with the movable brood chamber, as in the W.B.C. hive. This would give a good air space under the brood-chamber, or the rack could be utilised by the bees if cramped for room above, also the drones would be imprisoned as well as the queen, but I do not think many would be reared, if they had no egress, and there was no use for their services. Queen-rearers would, by this method, be able to control the selection of drones for the fertilisation of their queens.—**J. EVANS, Sutton Coldfield.**

[This method was tried some years ago, but was not a success in practice.—Ed.]

## Queries and Replies.

[4149] *Bees Storing in Brood-Chamber.*—I put on a super containing the full complement of sections about a month ago and looked to-day (19th June) to see if the bees had started to fill them. I found, however, that no such attempt had been made, but that the brood-nest seemed full of honey, thus restricting the brood-rearing space. Shall I take the full frames of honey out and replace with empty ones, or leave the hive alone until for want of space the bees are bound to work in the super? Your advice will oblige.—**J. H. H., Twickenham.**

REPLY.—You might take out a couple of combs from brood-nest, and extract them to give the queen room to lay. If you have an excluder on, remove it for a short period. A section with a little honey in as a bait might attract the bees and start them going up.

[4150] *Swarms Returning to Parent Hive.*—I should be glad if you will kindly enlighten me on the following subject through the "B.B.J." Why do swarms so frequently return to their hives this season? I have had over a dozen swarms do this several coming out and returning three or four times, and other bee-keepers round here are having the same trouble. I have known swarms do this before but never to the same extent as this year. If you can enlighten me I shall be much obliged.—**G. H., Kent.**

REPLY.—It is simply because the queen does not come out with the swarm.

[4151] *Shading Hives*.—I notice in the Guide Book, that hives should be well shaded in hot weather when working for section honey. All my hives face south, and have no shade except the ordinary porch over entrance. Would you please inform me of the best means of providing a temporary shade, and oblige.—ALEXANDER BLUE, Ardriahaig, N.B.

REPLY.—Drive in four stakes, and stretch raffia matting or canvas over them above the hive.

[4152] *A Beginner's Queries*. — Will you kindly give me your opinion on the following:—(1) Which is the best honey-extractor? (2) The best hive? (3) The best uncapping knife? (4) Address of a good firm from whom I can buy the above goods. (5) With my hive was sent a wedge-shaped piece of wood. Please let me know what is its use? (6) Which is the best brood—"Weed" foundation, 8 sheets or 9 to 10 sheets to the lb. (7) Proper quantity of thin syrup to give daily in spring. I should like very much to thank Mr. Herrod for his helpful hints for novices.—NEW READER.

REPLY.—(1) The Cowan is the best honey-extractor. (2) The W.B.C. hive. (3) We prefer the W.B.C. uncapping knife. (4) We must refer you to our advertisement columns. (5) The piece of wood is one of the entrance slides. There should be two of this shape for regulating the width of the entrance. (6) If you wire your frames, use 10 sheets to the lb.; if not, 7 sheets. (7) It is best to use a bottle feeder. Keep it constantly filled, and allow the bees access to two holes only. We are pleased to hear you appreciate helpful hints. The writer is always glad to be of use to fellow-craftsmen.

### CAPPINGS OF COMB.

BY L. S. CRAWSHAW, NORTON, MALTON, YORKS.

*Isle of Wight Disease* (page 206).—The theory enunciated by P.W. is interesting, but perhaps insufficiently worked out. It is difficult to see why, if sugar feeding be the cause, the disease should be at first confined to a small area, and afterwards spread like an infectious disease. Other diseases too should show activity corresponding to the supposed degeneration. Again if such degeneration were due to the feeding, one would expect the bees to be most degenerate where feeding was most practised. Of course this might apply to the "Isle of Wight." For a good honey district often finds the brood combs

full of brood at the close of the season, whilst in a poorer district breeding may be more restricted, and bees be in better condition for winter, upon the removal of the supers. It is also difficult to see just wherein sugar is not a natural food. Chemically there may be slight differences, but the invert syrup which is fed to the bees would seem to be so like their own stores as to be quite as good. Wintering reports too show that mortality may be less with sugar than with some honeys. At the same time it is my belief that sugar, as purchased, does contain deleterious matter. For instance, blue appears to be used to bleach it, and quantities of this dirty scum may be, and should be, removed when boiling the sugar.

*Criticisms* (page 212).—D.M.M.'s replies are so many and so formidable that I am willing to "give him best." For if I were to come up for another tilt, an extension of the lists would be necessary. Indeed the pages of the "B.B.J." itself might not, probably would not, contain all that might be written. I shall beware how I again attack that man of valour, and perhaps for the sake of peace and quietness Saul will be careful how he ventures among the Philistines.

*Removing a Swarm* (page 216).—Capital! It does one good to read of such operations. I have often thought that this method is by far the best to get a newly settled swarm out of a chimney, but have never had the opportunity of trying it.

*Lighting a Smoker* (page 222).—Yes, it is curious how ineptly many bee-keepers, even candidates for examination, go about this simple operation. Mr. Herrod's "Hints for Novices" may well be read even by those who have passed the stage, for there seem to be heaps of good things in them which should satisfy those who always want supplementary instruction. I use rotten wood when I can get it, and find it reliable and long burning. It has faults, of course, but so has every fuel; at least it does not produce that evil creosote stuff which drops where it listeth, usually in the wrong place, such as the super. After filling and lighting, I press in a loose bunch of grass. This prevents sparks and bits from issuing, and the dried hay which results is useful for lighting

the next charge. Also if the nozzle fits too loosely, allow the grass to hang out a bit, when the nozzle will wedge so that it will not drop off at some awful moment.

*Putting on a Roof* (page 223).—I have found that the quickest method, and one which ensures the roof settling into place, is to grasp the diagonal corners just where the roof fits the lift. Then the fingers steer the roof into place without jar, and with great control, and no after-look is necessary to see that the roof is quite down. Try the method, and see if you do not like it.

*The Season—a Warning* (page 234).—In my last notes I referred retrospectively to the season, and considered the possibility of a continuance of the favourable conditions. Since then I have had the opportunity of inspecting the clover pastures, and I feel that I must utter a word of warning to those beginners who do not yet anticipate conditions. One kindly correspondent (Humble Bee, Bridge of Allan) writes me—"as to white clover, why, you have to look for it, whereas last year it was like a snowfall in the fields." Aye, if we could only put the body of one horse on to the legs of another we might do wonders. In this neighbourhood, at least, the clover is not likely to make much showing, and it would be well for all optimistic bee-keepers to go slowly, and to refrain from giving the bees much more super room until they are convinced that it will be occupied. Otherwise they are likely to have a good many unfinished sections upon their hands, in place of more saleable product. Those who read Mr. Woodley's notes in B.J. of June 15 cannot fail to be struck by the truth of his diagnosis, and if they will couple his estimate of brood nest conditions, with the possibility of a short flow from fresh sources, they will realise perhaps that it will be well to make sure of the bird in the hand. This seems to be one of those seasons which point to the advantages of shallower frames than the standard, but users of the ordinary frame will have at least the consolation of putting their bees into winter quarters without the labour and anxiety of autumn feeding.

Since the foregoing was written, nearly two weeks ago, such a change has taken place that it is almost unnecessary, the

best place for honey being perhaps anywhere but on the hives! I am removing sections as the outside row of cells get nicely emptied and cleaned up.

## Bee Shows to Come.

*A nominal charge of 2s. 6d. is made for notices (not exceeding 7 lines) in this column, 10 lines charged 3s. 6d., up to 15 lines 5s., which covers cost of insertion from order till date of show. Cash should accompany orders for insertion.*

**June 26 to 30, at Norwich** (Royal Agricultural Society's Show).—Bee and Honey Section under the management of the B.B.K.A.

**July 13 and 14, at Brigg, Lincs.**—Lincolnshire B.K.A. Great Show of Honey, Hives, and Appliances, at the Brigg Exhibition of the Lincolnshire Agricultural Society.

**July 19 and 20, at Stafford.**—Honey Show in connection with the Staffs. Bee-keepers' Association. Four open classes. Schedules from Joseph Tinsley, 22, Granville Terrace, Stone, Staffs. **Entries close July 10.**

**July 20, at Southwell.**—Annual Show of the Notts B.K.A., in connection with the Horticultural Society's Show. Open class for Single 1-lb. Jar. First prize, 20s. Schedules from Geo. Hayes, Mona Street, Beeston, Notts.

**July 25, 26, 27, at Gloucester.** Annual Show of the Gloucestershire B.K.A., in connection with the County Agricultural Show. Separate tent for Honey, Wax, and Appliances. Open classes. Special prizes. Schedules from Rev. F. H. Fowler, Barnwood Vicarage, Gloucester. **Entries close July 18.**

**July 25 to 29, at St. Albans.**—Honey Show of the St. Albans and District Bee-keepers' Association. Three Open Classes. Schedules, &c., of Mr. E. Watson, Holywell Hill, St. Albans.

**July 26 and 27, at Cardiff.**—Annual Show of the Glamorgan B.K.A. in connection with the Cardiff and County Horticultural Show. Separate tent for honey, wax, and appliances. Open classes. Special prizes. Schedules from Hon. Sec. Mr. Wiltshire, Mairdy School, Cardiff.

**July 27, 28, and 29, at Rotherham.**—Show of Hives, Honey, &c., in connection with the Royal Yorkshire Agricultural Society. Schedules and Entry Forms from Secretary, Blake-street, York. **Entries closed.**

**August 2, at Stoke Park, Guildford.** Annual Exhibition of Bees, Wax, Appliances, &c., will be held by the Surrey B.K.A., in connection with the Guildford and West Surrey Agricultural Association. Nineteen classes (five open to all). Many medals. Schedules from F. B. White, Hon. Secretary, Marden House, Redhill, Surrey. **Entries close July 22.**

**August 3, at Weston-super-Mare.**—Annual Show of the Somerset B.K.A., in connection with the important Local Annual Flower Show. Classes for Appliances, Honey, Wax, and Bee Products. Several open and free classes. Liberal prizes. Numerous attractions. Excursions from all parts. For Schedule, &c., apply to T. Jones, Assistant Show Secretary, North View, Milton-road, Weston-super-Mare. **Entries close July 29.**

**August 7 (Bank Holiday), at Cambridge.** Honey Show in connection with the Cambridge Mammoth Show Society. All Open Classes, four Special Hives to be competed for. This Show also includes dogs, poultry, pigeons, rabbits, cage birds, flowers, fruit, and vegetables; also grand programme of sports and motor racing, &c. Balloon ascent and parachute descent by Captain Spencer.

**Sept. 27 at Altrincham.** Honey Show in connection with the Altrincham Agricultural Show. Twelve Honey Classes. Schedules from J. Herbert Hall, 1, Market Street, Altrincham. **Entries close Sept. 9.**

The champion prize band (Irwell Springs) has been specially engaged. Schedules from Hon. Sec., E. F. Dant, Member of B.B.K.A., 52 Bridge Street, Cambridge. **Entries close Thursday, August 3.**

**August 9, at Wye, Kent.**—Kent Honey Show. Four Open Classes. Fourteen open to Kent. Trophy Cup value 3 guineas. Open to Kent, Surrey, and Sussex. Two Challenge Cups value 5 guineas each. Many other special and money prizes. Special classes for Cottagers, also class for members of Ashford and District Bee-keepers' Association. Schedules ready early in July, from H. C. Chapelow, Hon. Sec., Wye, Kent. **Entries close August 2nd.**

**August 16, at Lancaster.** Lancaster Agricultural Society, in conjunction with the Lancashire B.K.A. 16 Classes for Honey, Bee Produce, and Bee Hives. Numerous specials, including 2 silver challenge cups, 12 silver and bronze medals. Write for Honey Schedule to Robert Gardner, 13, Sun St., Lancaster. **Entries close August 2.**

**August 23, at Radstock, Somerset.**—Honey Show in connection with the Radstock Horticultural and Farmers' Association. Open and gift classes. Write for Honey Schedule. B. M. Clark, Foxhills, Radstock.

**August 23 and 24, at Shrewsbury.** Annual Show of the Shropshire Bee-keepers' Association, in connection with the Shropshire Horticultural Society's Great Floral Fête. Eight Open Classes for Honey. Free entry for single bottle and single section. Schedules from S. Cartwright, Hon. Sec., Shawbury, Shrewsbury. **Entries close August 11.**

## Notices to Correspondents.

*Letters or queries asking for addresses of manufacturers or correspondents, or where appliances can be purchased, or replies giving such information, can only be inserted as advertisements. The space devoted to letters, queries, and replies is meant for the general good of bee-keepers, and not for advertisements. We wish our correspondents to bear in mind that, as it is necessary for us to go to press in advance of the date of issue, queries cannot always be replied to in the issue immediately following the receipt of their communications.*

**HEATHER (Mumbles).**—*Moving Hives to Heather.*—They should be moved a distance of two miles or more if you do not wish to lose a great many bees.

**D. T. (Ballymote).**—*Dividing Colony.*—(1) Brood that becomes chilled is usually thrown out by the workers. (2) To make two colonies from one, take a comb of brood and bees on which the queen is found, and put it into a hive, which you fill with frames of foundation. Place it on the stand where the colony stood and remove this to a new location. Close the hive and all flying bees will return to the old stand, join the queen and form the swarm. The old stock should have the frames brought close together, and an empty comb put at the side to replace the one taken out. This hive should have a laying queen introduced or a ripe queen-cell may be given it on the second day after the operation. The colony which it is proposed

to divide should be a strong one. Of course you will have to remove the super with sealed honey.

**Puzzled Bee-keeper (Kilgerfan).**—*Bees Attacked by Disease.*—The bees you describe are affected by the microbe which Mr. Cheshire named *Brevillus Gayfoni*. The affection is constitutional in the queen, and it has been found that if the queen be removed and a healthy one substituted, the colony resumes a normal condition.

**A. G. C. (Torquay).**—*Bees Swarming During Manipulation.*—Both queens are virgins; you had best examine each lot at intervals of about ten days, if, on the second examination you do not find eggs you may conclude that they are queenless, and purchase a queen. Drones usually accompany a swarm. It is not unusual for bees to swarm while being manipulated.

**L. I. (Brentwood).**—*Queenless Bees Carrying Pollen.*—(1) Pollen is used as food by the adult bees, therefore it is not unusual to see bees carrying pollen into the hive even though they may be queenless. (2) We have seen casts weighing up to three pounds from a frame hive.

**ESPERANTO, (Clitheroe).**—*Double Brood-Boxes.*—(1) If you refer to page 61 of the Guide Book, the method of using these is explained. (2) No.

**W. F. (Eckington).**—*Transferring Bees from Box to Frame-Hive.*—It is doubtful whether you can manage to get the bees down into the frame-hive this season, but you might follow the plan detailed in Guide Book, page 149. If they do not go down leave them till next year, and then try again, following the instructions given in Guide Book as closely as you can.

**H. W. B. (Thetford).**—*Market Prices of Honey.* We regret that what you propose is impossible. The price is ruled by quality as well as supply and demand, which fluctuates. The honey quoted in the paper you mention is foreign honey.

**J. A. (Nottingham).**—*"Wells" System.*—It is not worth while giving particulars as it has been tried and found to be a failure.

### *Honey Samples.*

**M. P. (Cannock).**—The light honey is from charlock, the darker one a heather blend. Both are good in flavour, but are granulated, and should be carefully reliquefied before showing, and they would of course have to be entered in different classes.

**L. P. (Nelson).**—The bottle was smashed in the post and all the honey ran out.

*Suspected Disease.*

S. E. H. (Edinburgh). — The comb is affected with sour brood.

MAXON (Festiniog). — The brood is chilled only.

J. T. (Tomintoul). — The comb is affected with foul-brood. Full description of the disease and its treatment are given in the Guide Book, but if you do not possess a copy send a stamped envelope to this office for the Board of Agriculture leaflet on foul-brood.

**Special Prepaid Advertisements**

**Two Words One Penny, minimum Sixpence.**

*Orders for three or more consecutive insertions entitle advertisers to one insertion in "The Bee-keepers' Record" free of charge.*

*Trade advertisements of Bees, Honey, Queens, and Bee goods are not admissible at above rate, but will be inserted at 1d. per word as "Business" Announcements, immediately under the Private Advertisements. Advertisements of Hive-manufacturers can only be inserted at a minimum charge of 3s. per ½ in., or 5s. per inch.*

**PRIVATE ADVERTISEMENTS.**

**T**WO Secondhand Screw-cutting Lathes, foot power, 20in., catalogued £27 15s.; 30in. catalogued £28 15s.; will accept £3 for 20in., £3 10s. for the 30in., or exchange for Bees.—PRIOR, Breachwood Green.

**S**TRONG STOCKS on Standard 10 Frames, in good Hives, 25s. each; ready for Supers.—BECKENSALL, Ringwood, Hants. k 49

**F**ERTILE QUEEN in introducing Cage, with directions, post free—2s. 6d.—ROLLINS, Stourbridge. k 53

**F**OR SALE, cheap to clear.—Having sold my Bees, I have a quantity of worked out shallow frames (just the thing for the heather), geared Extractor, 3 Honey Ripeners with taps and Strainers, Uncapping Tray, Knives, &c.; sell together or separately.—For particulars apply G. C. LYON, 9, College-road, Hextable, Kent. k 51

**B**EE FARM.—Owing to ill-health, lady must sell her Bees and Appliances; modern convenient House with garden and meadow might be taken over, near station, 40 miles from London, excellent honey country, good trade connection.—LYNDHURST, Southminster, Essex. k 50

**S**URPLUS STOCK.—4 W.B.C. Hives, newly painted, complete with Brood Box, 2 Supers, Queen Excluder, 7s. each; Supers, with 8 drawn out Combs, metal ends, 3s. each; Supers, with 8 Combs, not drawn out, and metal ends, 2s. each; W.B.C. Section Racks, with 7 frames, 1s. 9d. each; Queen Excluders, 4d. each; drawn out Super Combs, 8s. a doz. What offers?—GILBEY, Bretton, Wakefield. k 18

**N**EW FOUNDATION, 10lb. brood, 16s.; 11lb. ditto weed, 18s. 6d.; 2lb. shallow frames, 3s. 6d.; 10oz. thin Super, 1s. 3d.; 6lb. weed brood to fit 16in. by 10in. frames, 9s. 6d.—F. E. MATTHEWS, Cotton Apiary, Northfield, Birmingham. k 47

**B**ELL GLASSES, 1 to contain 20lb., 1 10lb., 5 each 2lb., 10s. the lot; 34 lb. tall tie-over glass show jars, 3s. 6d. per doz., or 9s. the lot; 250 new split top Sections in flat, 5s. 5d.; 4 doz. new metal Dividers, 3s. 6d.; half gross cardboard section Show Cases, glass each side, new, 6/5; 6 wooden show Cases for shallow frames, with glass each side, 9s.; going abroad, F. E. MATTHEWS, Cotton Apiary, Northfield, Birmingham. k 46

**Special Prepaid Advertisements.—Continued**

**W**ANTED, Extractor, Appliances, and Ripener, good condition; state lowest price, makes, &c.—ALDERSEY, 31, Budge Row, E.C. k 56

**I**MMEDIATE DISPOSAL.—8in. Irish, ditto Lee's Hives, little used, lifts, floor ventilators, 8 combs, and section crate each, 10s. 6d. on rail; absolute guarantee.—Address, M., 5 Park Row, Hornsea. k 52

**W**ANTED, first grade Sections and Extracted Honey (English).—Apply, stating price, to R. S., care of "B.B.J.," 23, Bedford-street, Strand, W.C. k 27

**Q**UANTITY TAYLOR'S BEE GOODS (new), crates, frames, sections, foundations, metal-ends, glass supers for skeps, queen excluders, &c. 15% discount.—WELLBOURN, Cranswick, Beverley. j 99

**W**ANTED, a few Skeps of Bees, with old and tough combs for driving purposes.—HERROD, "Bee Journal" Office.

**BUSINESS ADVERTISEMENTS.**

**W**ANTED, Sections, first quality, prompt cash any quantity.—W. CHILTON, Southdown Apiaries, Polegate, Sussex.

**S**ECTION GLAZING.—Best quality Lace Paper, made especially for Bee-keepers' use, not common box edging, white, 100 6d., 300 1s. 4d., 500 2s. 3d., 1,000 5s. 9d., post free; blue, green, or pink, 100 7d., 300 1s. 6d., 500 2s. 6d.; Lace Bands, 2½ in., 3in., and 3½ in. wide, white, 100 1s. 2d., 200 2s. 3d., 500 4s.; a few in pink and blue, 100 1s. 4d., 200 2s. 6d.—W. WOODLEY, Beedon, Newbury.

**A**PIARY of 6 Hives for sale, boiling over with 4 Bees, 10 spare Hives, Honey Extractor, 10 Crates Sections, 8 Racks, Shallow Frames, 30 Brood-combs, cheap. Particulars, Watts, Chickereil, Weymouth. k 37

**Q**UEENS from Doolittle stock, virgins, 1s. 6d.; fertiles, 5s.—D. G. TAYLOR, Ilminster. k 17

**1911** QUEENS.—Golden Italian fertile Queens, guaranteed healthy, pure-mated, vigorous, prolific, 4s. each; specially selected, 7s. 6d. each; prompt delivery.—J. B. GOODARE, Woden Apiary, Wednesfield, Wolverhampton. k 54

**3000** PURE FERTILE 1911 QUEENS TO BE SOLD DURING SEASON, Swiss Brown Natives, 5s.; Blacks, Italians, Carniolans, 3s. 5d.—FREDERICK VOGT, 38, Clementina-rd, Leyton, Essex.

**T**HE PREPARATION OF HONEY and Wax for Show Beach, 7d.—TINSLEY, 22, Granville-terrace, Stone, Staffs. h 5

**1911** QUEENS, 3s. 9d.; Virgins, 1s. 6d.; safe arrival guaranteed.—TOLLINGTON, Woodbine Apiary, Hathern. k 55

**E**XTRACTED HONEY bought in any quantity; prompt cash; receptacles sent.—Send sample, stating quantity, SPRING and Co., Ltd., Brigg, Lincs.

**C**HOICE, fertile, black Queens, 5/- each.—WILKES, Lichfield-road, Four Oaks, Birmingham.

**E**VERYTHING for successful Bee-Keeping, for the amateur and the professional, prime quality, moderate prices. See our new large illustrated catalogue now ready, and sent post free to enquirers. The fullest and most helpful catalogue that is published.—SEEDS AND BEES, Ltd. (George Rose), 22, Bolton-street, Liverpool. The British and Irish Bee-keepers' Prompt Supply Stores.

## Editorial, Notices, &c.

### ROYAL SHOW AT NORWICH.

(Continued from page 253).

The limited time at our disposal last week prevented us from giving more than a list of the awards, but later we had an opportunity of observing the many interesting features of this "Coronation Year" Royal Show. In the first place it is questionable if the show has ever been held in more picturesque surroundings than in the beautiful park belonging to R. J. Coltman Esq., at Crown Point, Norwich. The splendid avenues of chestnuts together with the large copses were not only a beautiful sight, but afforded a welcome shade when the heat and glare became oppressive, and it was quite easy to get right away from the rush and noise, if one desired, to rest and spend a quiet half hour.

The show ground is some distance from the city, but admirable arrangements had been made so that access was facilitated from the nearest points, one popular means of conveyance being the steamers on the river Yare, by which it was possible to travel from the very doors of Thorpe Station to within a few hundred yards of the main entrance to the show. The city itself is very old and quaint, and abounds in ancient and historic buildings and landmarks, including the Cathedral, a splendid specimen of Norman architecture. These lions of the place received their full measure of support as well as the show.

The weather throughout was fine, though the week-end previous had been very wet, which made it most uncomfortable for the exhibitors and others who had to be present. During Friday night especially there was a continuous downpour. Fortunately, though so much rain fell, the ground on Monday morning was quite dry, the soil being a very light one.

Wednesday was "King's" day, when His Majesty paid an official visit, and spent some hours in examining the various exhibits. It was hoped that the honey department would be honoured, but time did not permit. Large crowds visited the show on this as well as the following day.

So far as the British Bee-keepers' Association was concerned, the exhibition was a record one; never before has such a large display of honey and appliances been seen at "The Royal." The position of the bee and honey section was also a great improvement on previous years, being amongst the educational exhibits, and near the main entrance, instead of, as hitherto, right away at the furthestmost part of the ground, beyond the cattle. That this change is an improvement was

shown by the large numbers of visitors continually in the department during the whole of the show. The building had also been enlarged, and extended to a length of 170ft. instead of 120ft., the largest space attained before. In conversation with one of the leading officials, I was told that the hives and honey department had now asserted itself, and formed one of the features of the show, and that in the future it would receive more attention from the Royal Agricultural Society to still further improve it. The demonstration tent was located right in front of the honey tent, the lectures by the Association expert being crowded each time, many of the audience standing on boxes and chairs at the outermost edge in order to see and hear.

Three collections of appliances were staged, all being admirably arranged, while the workmanship of the goods was above the average. All were adjudged a worthy of awards, Jas. Lee and Son taking first prize, W. P. Meadows second, and E. H. Taylor third. The class for best hive produced twelve entries, Abbott Bros. coming first with one of their well-known W.B.C. hives, H. Tunstall second, and Jas. Lee and Son third.

In the cottagers' hive class four exhibits were staged, with E. H. Taylor first; Jas. Lee and Son second; and Godburn Bros. third. In both these classes the workmanship was of a very high order, and gave the judges a considerable amount of trouble in awarding the prizes. In extractors there was no competition, Mr. Meadows putting in the only two exhibits shown. Observatory hives were also badly represented, only two being staged. This is a class which deserves more support for its educational value. The new appliance prize was won by E. H. Taylor with the "Wilkes" new feeders made of aluminium. The honey classes were remarkably good, there being practically not a faulty sample, so far as quality was concerned, but a number of sections were disqualified on account of overlacing. This is obviously the fault of the exhibitor. The rules are perfectly plain, and there is nothing to prevent a larger surface than three-and-a-half inches being shown. It is most absurd for the owners of such splendid sections as were thrown out at this show to venture so near the limit that they often exceed it, when really it would be more to their advantage to expose more of the comb. Probably in time they will learn their lesson, and show a surface of  $3\frac{1}{2}$  or even  $3\frac{3}{4}$  inches instead of trying to come exactly to the margin allowed.

The North Norfolk Bee-keepers' Association are to be congratulated on the fine display they made in the local classes, both numerically and as regards quality.

The trophy class was well filled, seven trophies being staged, representing the north, midland, and eastern parts of the country, the first prize exhibit shown by R. Brown and Son being a fine example of 1911 honey which attracted a great deal of attention.

#### MR. AND MRS. S. W. ABBOTT.

##### SILVER WEDDING.

On Monday the 19th June last, Mr. and Mrs. Stephen W. Abbott celebrated their silver wedding at The Chestnuts, Southall, when they received the congratulations of their numerous friends, together with many presents, including a handsome silver cake basket from the employees of the firm of Abbott Bros.

The name of this old-established firm is a household word in the bee-world, and bee-keepers will join us in adding our good wishes to those already expressed. We hope Mr. and Mrs. Abbott have many more happy years yet in store.

#### AMONG THE BEES.

##### A FLOW OF NECTAR.

*By D. M. Macdonald, Banff.*

What are the chief factors in securing a flow of nectar? I think the subject is imperfectly understood. Possibly nine out of every ten beemen would say bright sunshine, plenty of bloom, and warm weather, each in itself, or all combined, would ensure a flow of nectar, and given the bees, make a certainty of a heavy income to the hives near any staple source of honey yielding plants. Primarily these factors go to secure a fair to full flow of nectarious juices to the glands of certain flowers, but there are undoubtedly certain climatic influences at work aiding and abetting, or, alternatively, checking a flow.

We all know that a cold chill atmosphere, with a low temperature, effectually prevents nectar secretion even when flowers bloom profusely; therefore we deduce that a certain degree of heat is essential to produce a flow. That a high temperature alone will not effect this, however, is shown by the effect of a prolonged heat wave in almost wholly drying up the source of honey production. Too long a period of bright sunshine has this blighting result even when the flowers continue blossoming profusely. Again, have we not all experienced long spells of sunny weather, with everything apparently favourable but the wind. Old Sol shone gloriously all day long, flowers were plentiful, and for outdoor games or pastimes circumstances were almost ideal, but a steady east wind most effectively checked

all secretion in the nectar glands, and bees, perhaps after an extensive prospecting all round, realised that their labour was in vain, so therefore they stayed indoors. A strong wind from south or west may confine them for days, but it only requires a simply perceptible gentle zephyr from either north or east to hold them prisoners for days, and yet (occasionally) we may find a flow with an east wind prevailing, strange as it may appear!

Rain, incessant and prolonged, will most thoroughly wash out nectar from the flowers, and in general it will also tarnish or destroy the blossoms to such an extent that a new growth must spring up before the bees can expect any chance of loading up even after a prolonged flight, and a patient sucking of many flowers. At times a short sharp shower has much the same effect. Even when it has not this full effect in general it makes the secretion a poor or partial one, and it further seems to supply a diluted form of nectar, requiring a large amount of labour on the part of the bees to evaporate the excess of moisture. Such honey, if hurriedly matured and sealed over, has a tendency to sour, and in course of time the sections filled with it will begin to "weep," owing to the super-abundance of moisture in the honey.

A sharp, kindly soil not only yields an abundant flow of nectar as a rule, but it supplies a better quality of honey, requiring less maturing and evaporating. A heavy, damp, retentive soil, on the contrary, produces honey of a poorer type, less of it, and that gathered is in a more diluted form even under favourable climatic influences. A soil heavily manured, bearing crops cultivated on the intensive principle, when the plants are of a nectar bearing kind, supply a low grade honey, or fail to secrete honey in any form. I have known heavily dressed fields of white clover supplying honey as dark as that ordinarily obtained from limes and the flavour was insipid, while the aroma was only slightly perceptible.

Exposure has an undoubted effect in adding to or lessening a flow of nectar. When carrying hives to the heather, I would always like the stretch of moorland or hillside to be on the sunny side. A southerly exposure is always best. Here, too, soil should be considered, because that of a light, porous, sandy nature is much to be preferred to soft, boggy, or mossy stretches. In the first case the contents of the honey sac may be transferred to the cells in fine weather direct from the hillside, whereas from the ranker growth it takes a considerable amount of "cooking" on the part of the bees before it becomes true honey, and even then it is of poorer flavour, and I am inclined to think it granulates more readily.



Thunder in the air has at times a peculiar influence on nectar secretion, and also on the workers' temper. The bees frequently cultivate a very cross and "stingy" disposition. Confinement and hindrance from labour may aid the irascible inclination, but I think the ill-nature is generated more by the climatic influences. Even when little rain falls, nectar secretion is checked for a time, and even when the storm centre is miles away its effects may be experienced. When the thunder bursts in our own immediate neighbourhood accompanied by a deluge of rain it may be days or weeks before the bees discover nectar in any quantity, when heather should yield its best. At times an indefinable "something" in the atmosphere seems to teach the bees that to fly abroad would be labour lost, and they stay at home. Bees indeed are at times an excellent substitute for a barometer, and their action is a good weather forecast. By studying them carefully one can make a fairly just estimate of the coming weather. Their actions appear to foretell a wet day pretty accurately, but even with fine days they often stay indoors, when a non-beekeeper would expect them to be much abroad. With the very finest weather for some days after a heavy flood they never fly to the fields, instinctively understanding apparently that their old haunts are nectar-less. They are creatures finely attuned to respond to atmospheric influences. The subject is one fraught with material for an interesting study, and I have but touched its fringe.

---

## Correspondence.

---

*The Editors do not hold themselves responsible for the opinions expressed by correspondents. No notice will be taken of anonymous communications, and correspondents are requested to write on one side of the paper only and give their real names and addresses, not necessarily for publication, but as a guarantee of good faith. Illustrations should be drawn on separate pieces of paper.*

---

### ROSS-SHIRE NOTES.

[8198] While the columns of the "B.B.J." hint at a disappointing season, we in the north have no reason to complain. There is much more honey in the hives than at the corresponding period last year, though many bee-keepers report neglected supers and heavily-stored brood-combs. Of course this abnormal season has put a premium on brood-nest storage, but where supers were "baited" and warmly wrapped up bees took to them all right. Some of my colonies have reached

the length of occupying three racks, while others are storing in two, the first put on being filled and almost half sealed. Those who put the empty super on top always, are doing the correct thing in an unsettled season such as this. If the clover crop is to be short, better have it all in one rack or two, and the upper supers merely drawn out for the heather. The latter is already coming into bloom and may possibly begin to yield nectar this month, as in 1901.

At the moment our hopes are centred on the crop within reach. White clover, untouched by the mower, may yield heavily when the weather improves. I have maintained last year's prices on sales of new honey—12s. per dozen wholesale for sections just as they come from the hive. My first take was from a hive with a rack of sections left on over winter. In this case the early honey all went above where it was wanted.

*Swarming.*—I note Mr. Woodley is not having any swarms probably because he wants them. I don't want them at any time, and last year had but one. It came from a May swarm from England, and saw fit to swarm again here two months later. This same hive swarmed yesterday, while another, also from England, swarmed a week ago. Seemingly the swarming instinct is hereditary and unquenchable in bees of the skeppist régime.

*Queen Introduction.*—The confined nucleus system is one I have never known to fail under any circumstances. Two broodless combs with adhering bees are taken from a hive, and confined indoors. The bees soon realise that they have no queen or the means of rearing one and set up a lamentable uproar. Then a sudden bump throws them to the floor-board, the queen is dropped among them and the nucleus closed with the assurance that her majesty will be found laying next day.—J. M. ELLIS, Ussie Valley.

---

### SWARM CONTROL.

[8199] I was much interested in Mr. Stapleton's letter on the above, because the same idea occurred to me many years ago and I tried it at that time, but it failed because the newly-hatched queens never managed to gain admittance to the hives I wished to requeen. To requeen was my primary object, but I concluded it would prevent swarming as well. Having got a newly-hatched queen from a neighbour on Monday evening last, June 26th, I decided to try Mr. Stapleton's plan again, and I introduced this young queen to a very stong stock, working in their third super, on Tuesday at mid-day, when bees were flying strong. Twice the queen was run off the alighting

board by the guards: but the third time I set her down I blew in a little tobacco smoke which cleared away the guards and she gained admission so far as I could follow her. I watched carefully to see if a queen was thrown out, but never saw one. To-day, July 3rd, when removing sections I decided to examine the frames to see what the result was, and I was agreeably surprised to find the old queen gone, and every queen cell but one torn down. Preparation had evidently been made to swarm, and I had just been in time to prevent it, for the time being at any rate. The cell remaining was a very small one on an outside comb, and I regret to say I destroyed it, it being on the first frame I lifted out. I thought the experiment had failed. There were no eggs, and the youngest larvæ were about two days old. Of course this does not prove Mr. Stapleton's plan to be a complete success, but I am disposed to think it would have been so, had I not thoughtlessly destroyed the remaining queen cell. J. H. MARRS, Lochmaben, N.B.

#### INDUCING BEES TO GO INTO SUPERS.

[8200] I observe a fellow bee-keeper, signing himself J. H. H., Twickenham, writes to the "B.B.J." of June 29th. Would this gentleman care to let me have his address, as we must be fairly near to one another, and for my part I should be glad to know another bee-keeper in this district, and should he be a novice I might be able to help him.

I have five hives supered, three with shallow-frame racks, one with sections, and one with both shallow-frame and section racks. All are doing well, especially now, when the limes, our chief flow here, are in bloom.

By packing up my supers well, nailing strips of felt round the bottom of each rack on to the top of each brood box, I have no trouble owing to the bees not going into them. I always cover thoroughly with quilts, for being near the River Thames, the cooling down at night is very marked and, I think, causes the unwillingness to go into the supers, which I have sometimes experienced. In other words when the bees will not take to a rack, I first pass all the foundation before the heat of the kitchen fire and then replace in the super, and wrap up more carefully and more warmly. This remedy, with a little honey smeared on the combs or syrup sprayed on to foundation if necessary, has only failed me once, and that was last year.

I note there has been some correspondence about stings. My people at home use Lysol as a cure, though I myself never trouble about them, as a few stings, even on ear or temple, do not worry me. According to hearsay, I was first stung by my

father's bees when I was two years of age and I suppose it is a question of adaptation to local surroundings in the Darwinian sense. However, I prefer using a net veil as a certain number of bees are prevented from stinging, who would otherwise lose their lives unnecessarily. When examining other people's bees, I think this is always advisable. Many years ago, an expert whose name I do not know (I was too young), came to see my father's bees, and in spite of warnings as to the temper of one particular hive he had started to examine it, refusing the loan of a veil. My father had to cover up that hive when he came home from the City as the expert had fled hurriedly.—WALTER ED. ZEHETMAVR, Bellevue, Ailsa Road, St. Margaret-on-Thames.

#### "ISLE OF WIGHT" DISEASE.

[8201] In the hope that it may assist in the discovery of the cause of what is now called the "Isle of Wight" disease, I beg to say exactly the same complaint was among my own bees in Warwickshire as long ago as 1891. I found a number fluttering along the ground exactly as described in reports of cases last year. At that time I was living about two miles from the late John Walton, a name very well known among bee-keepers, and I went to him, as I always did in a difficulty, to ask what it was and what to do. I found he also had some bees "fluttering" on the ground and like mine always going from the hives. He said it was new to him—he did not trouble much about it—and jokingly called it bee influenza, as it appeared at the same time as the outbreak of that disease. In a short time, about a week I think, it ceased, and I saw no more crawling bees and heard nothing from Mr. Walton. The chief point is that I am convinced it was not infectious, and I do not see how it could be. I had about a dozen hives, and I was never quite sure to which hive the affected bees belonged. I felt certain they all came from one stock—there was no great number of crawling bees—and no hive dwindled appreciably. Mr. Walton had about fifty hives in a very small space, so that infection was certain if there was infection. The bees acted exactly as described in the Isle of Wight, and I noticed they were always going away from the hives in both apiaries as if trying to fly to work; I even put up boards to keep them near the hives. My belief was, and is still, that the bees from some reason, costiveness or inability to discharge their load of honey, were simply too heavy to fly.—A. W. WISE, Leamington.

(Correspondence continued on page 266.)

## HOMES OF THE HONEY BEE.

## APIARIES OF OUR READERS.

The bee garden picture which we present this week illustrates the apiary of Mr. E. Wheatley, who confesses to being only a beginner in the craft. His attractive little apiary certainly shows that he is the right man in the right place. It is nicely arranged, with well-made hives of uniform pattern, and it is kept in a neat and tidy condition which would do credit to a veteran bee-keeper. Mr. Wheatley has also found time to interest others in the bees, and since he accepted the office of district secretary to the Leicestershire B.K.A., he has introduced several new members to the association. We hope his interest in his apiary will continue; and that success will reward his efforts to help the association and his fellow bee-keepers. His notes are as follows:—

stocks in hives, and I also made two hives from specifications I got from "Hobbies," but I found it a disadvantage to have so many patters, and I now have W. B. C. pattern hives only, which are all interchangeable. At the end of last season I had five good strong stocks obtained by natural and artificial swarming. When I started I took in the "Record" and "Bee Journal," and I have found them a great help. The "Guide Book" and "The Honey Bee" have been my daily companions and I advise all bee-keepers to study them. I joined the Leicestershire Association, and became the district secretary and succeeded in getting eight new members to join. I am pleased to say we have no foul brood or Isle of Wight disease in our district and bees generally wintered well, and came out strong in spring. I purchased a stock in



MR. E. WHEATLEY'S APIARY, SPA ROAD, HINCKLEY.

The enclosed photograph was taken on Saturday, May 6th inst., on my first anniversary as a bee-keeper. On that date twelve months ago, I bought a stock of bees in a good hive from a neighbouring village and so launched out into the most fascinating hobby I have ever taken up. My attention was first drawn to bee-keeping through a conversation I had with a friend of mine who has kept a few hives for about four years, and he became interested while casually strolling round a bee tent at an Horticultural Exhibition in a neighbouring town, so I think that is a good proof that the lectures and work done by our experts does lead people to become bee-keepers and take an interest in the pursuit. I soon purchased two more

a very good hive for 7s. 6d. in April and found them fairly strong, but without stores, excepting a piece of hard candy, which I learnt had been on for two years. The combs were on small bars with brace combs in between, but I transferred the bees to a new hive with standard combs, putting a queen excluding dummy between them and the old combs, and they have built up very quickly. The man I purchased them from is a big fruit grower but is afraid of bees and wanted them out of the way. I mention this to show what ignorance one meets with regarding the value of the honey bee. The weather here now is ideal and the bees are very busy. Let us hope that the tide will turn and the season will be a record one. I wish you and all bee-keepers every success.

(Correspondence continued from page 264.)

### PREVENTING INCREASE.

[8202] Regarding Mr. Evans's letter (8197) in "B.B.J." of June 29th, perhaps my experience would be of use to him as I practised his method this year with success. I gave a section rack to my strongest stock in April. About the middle of May I put a shallow frame rack fitted with thin super worker foundation under the brood-box, not disturbing the sections. On the first of June I added another rack of sections immediately below the first, and ten days later removed the first, which weighed 21lb.; at the same time I looked very carefully for queen cells, but found none. The bees are now further on with their second rack of sections than any of the rest of my eight stocks are with their first, and show no signs of swarming so far. I tried the same plan with another stock but was too late in giving the shallow frame super; they swarmed a week later after only drawing out two of the frames. I have had five swarms, yet none of the stocks has ever been as strong as the first-mentioned. I did not use a queen excluder, as Mr. Evans suggests is desirable; my belief is that swarming is more caused by lack of brood-rearing space than by lack of air space. The only use I have for queen-excluders is when a section rack is changed from the old stock to the swarm from it, and the swarm has not got the combs drawn out for the queen to lay in. Without an excluder in this case, the chances are the queen will lay in the sections because the drawn out combs are ready to hand.—CAMPBELL R. PINKNEY, Sleights, R.S.O., Yorks.

### TWIN QUEENS IN ONE QUEEN-CELL.

[8203] I send herewith a queen-cell which I have to-day removed from a nucleus hive. As the time for the young queen to have hatched was several days overdue, and thinking something was wrong, I cut out the cell, and on opening it found two young queens, dead, in the cell. I send it to you intact. I have never seen such a case as this mentioned in the JOURNAL. Is it very abnormal?—G. S. N., Godstone.

[Such instances have been noticed before although rare. The two queens are very diminutive specimens, as one would expect to find in so confined a space. Nor are they fully developed, their legs, wings, and antennae being deformed. In some of these parts they resemble workers.—Ed.]

### BEE-STING CURES.

[8204] While working near a hive a week ago, I was stung by a bee, just

over the left eyebrow. The pain was intense. As soon as I could get indoors, and had extracted the sting, I applied a little boracic acid lotion, and the pain almost instantly ceased; but the eyelid subsequently became much swollen, almost closing the eye. The swelling was all gone in a couple of days, and I suffered no further inconvenience. I only applied the lotion once—just dabbing it on the part stung. I always keep this lotion by me, as insect stings are very irritating, and boracic acid is a remedy that suits me, allaying the irritation, and soothing the parts stung. One remedy may not suit everyone; but where several fail, perhaps this one might agree.—T. HARDY, Harrow Place, Leaven-  
beath.

## Queries and Replies.

[4153] *Artificial Increase.*—Will you kindly let me have your opinion upon the following:—Suppose an eight-frame hive swarms; I place the swarm on the old stand after, of course, removing the parent stock. I break up this stock into four nucleus hives, which would have two frames each, well protected with two division boards and fed, these four nuclei being placed far apart and away from their former stand. There will, of course, not be many bees to cover the brood on the two frames, and most of it would be sealed brood. Do you think this would be successful, and may be tried? No doubt its success would in a measure depend on the weather. You will probably think it risky to make so many nuclei out of only eight frames, but I do not want to disturb other hives to take bees from them.—X. Y. Z., Bungay.

REPLY.—We have carried out your method a number of times with success. As you say, a great deal depends on the weather, but by careful and constant attention to food and warmth all should go well.

[8154] *Bees Not Taking to Supers.*—I have six stocks of bees, and have had no swarms this year. In three of the hives the bees have only quite recently gone up into the sections, and that very sparsely. Early in the year they were just boiling over and supered up. At present there is plenty of brood, and the frames are well-packed with newly-sealed stores. The bees were fed in early spring with candy, and later with syrup. (1) Can you account for the bees not taking to the sections? (2) Would you advise the destruction of queens a little later on, and

allow the bees to raise new queens? All three stocks were 1909 swarms. Also all division boards are short to allow bees room to congregate at night, and they appear to have enjoyed that privilege to the full. (3) The supers are well packed down, except at the back. It just occurs to me now, can that be the fault? At any rate, I shall pack down all round at once. Permit me to say I think the usefulness of the "B.B.J." to novices would be increased if you could allow more room to print questions as well as answers.—W. R. H., Oxford.

REPLY.—(1) This has probably been caused by the bees not being strong enough in numbers, and the cold weather of the last couple of weeks will have checked them. (2) It would be better to purchase young queens of a good working strain to introduce fresh blood. (3) Most certainly you should pack down well, as a draught will prevent the bees going up. (4) We should be pleased to adopt your suggestion, but you must remember our space is limited. Others suggest we should cut these down more, so you see it is difficult to please all, though we try our best to do so.

[8155] *Transferring from Skep to Frame-hive.*—I am a beginner in bee-keeping, and bought a skep of bees in the latter part of April. Five weeks afterwards they swarmed. On the same evening, to prevent a second swarm, and before the new queen was hatched out, I put the skep over ten frames in a new hive, expecting to be able to remove it after a few weeks. On attempting to remove the skep I found it propolised to the American cloth quilt, and it felt twice as heavy as when first put on. As the bees assumed a threatening attitude, I ceased from my attempts at removal, and decided to seek your advice. I am following the instructions given in the "Guide Book," but there the skep is supposed to be placed over the frames at the start in the spring, and I put mine on after a swarm. The "Guide Book" is so clear and explicit, that I anticipated no difficulties excepting those born of ignorance, but I find myself faltering at the start. Will you be good enough to tell me what I had best do?—T. H., Nayland.

REPLY.—Subdue the bees properly, and pass a fine wire between skep and frames to loosen it. It can then be removed without jarring. If the queen is below, proceed as advised in Guide Book.

[8156] *Manipulating a Supered Stock.*—I should greatly esteem a reply to the following questions through the "B.B.J." which I take regularly and appreciate. (1) What objection is there to working a hive on the combination plan—say ten brood frames, and at the back of these a

queen excluder and about five section holders. In an old "Guide Book" it advocates this system, but I do not think it is mentioned in the later editions. It appeals to me because it would be easy to examine the stock after the sections are put in—sometimes a difficult operation when supers are put on top and securely glued down by the bees. I have just had to go through a stock with supers on top to cut out eight queen-cells made since the supers were put on, as the stock appeared to be on the point of swarming. (2) I put on supers *without* queen excluder, and noticed a few middle sections contain drone brood. If I leave them until brood hatches will the sections be fit to use, should the bees afterwards complete them? (3) Would a stock swarm if the queen was kept in by excluder? (4) To try to prevent swarming last year I divided a stock, but in spite of this I had a swarm a few days later. The stock increased rapidly, so that I again divided it, thus getting one natural swarm and two artificial ones. This year the same parent stock is covering about thirteen frames, and the two supers are full of bees.—W. BEE, Yorks.

REPLY.—(1) If you examine the brood-nest you will see that bees always store the food *above* the brood nest: for this reason it is best to put on supers instead of following the method you suggest. (2) No: the sections will be soiled, and not fit for sale. (3) The stock would not swarm, but you would hinder the work of the bees considerably. Why not use a Brice swarm-catcher? (4) You ought to breed from such a splendid queen.

[8157] *Storing Fitted Frames.*—I shall be glad if you can tell me the best way of storing brood frames with foundation fixed in ready for use, and also the best way of storing the six inch frames after the honey is extracted, so as to keep them free from wax-moth.—N. H. R., Windermere.

REPLY.—Frames of foundation and of comb should be stored by being hung in a box which has a lid, the combs should not touch each other. In the case of shallow combs they can be stored in the racks by packing the latter one above another. On the top of each third rack put a piece of paper about eight inches square, upon which place naphthaline or Apicure, the latter for preference. The top one must be covered entirely with paper.

[8158] *Making a Carbolic Cloth, etc.*—(1) I shall be glad to know through your journal if one to ten parts of Calvert's No. 5 carbolic acid is injurious in subduing bees, and for how long does its effect continue upon them. (2) What are the first signs of foul brood, and how is it detected? (3) What are the conditions necessary to obtain a third class expert's certificate, and where

is the nearest spot to this locality where an examination will be held this year, and the date of same?—A. J. G., Trim-saran.

REPLY.—(1) To make a carbohc cloth for subduing bees, put 1oz. Calvert's No. 5 carbohc acid into about a table-spoonful of glycerine, then add 2oz. water, and damp the cloth with this. Lay it over the frames, and the bees will go down and gorge themselves. Carry out the manipulation by rolling the cloth back. If the bees boil up put it over again for a few seconds. It is not injurious to them in any way. (2) You will find particulars of above in Guide Book where all the symptoms of foul brood are described. (3) We are having particulars of examination forwarded to you.

[8159] *Springing Fruit Trees*.—I enclose for your perusal a cutting from one of our local papers under the heading of Garden Gossip. (It runs as follows):—  
"Insects. All wall trees should be carefully inspected, and if they are infested with insects, syringe with a mixture prepared for the purpose consisting of soft soap and tobacco water, one ounce of the former and a table-spoonful of the latter to one gallon of water; a dash of flowers of sulphur added is a preventive of mildew. This washing will clean the fruit from any decaying matter, and give the trees a fresh, healthy appearance." I should be glad if you would kindly inform me (through the medium of the B.B.J.), whether the mixture prescribed would not have poisonous effects upon the bees of this district, and if anything could be done to stop the spread of the publication of so dangerous a prescription in the Press.  
F. R., Staffs.

REPLY.—The wash would be quite harmless to bees.

[8160] *Transferring Bees to New Hive*.  
I have a stock of blacks on nine frames, that had been neglected before I purchased them. The combs are badly built so that the frames cannot be taken out singly, but in threes. I want to get the bees to draw out foundation in new frames and then drive them out so as to get the queen on to the new combs, and take down the honey from the old ones. How can I best do this and when?—J. D. A., Somerset.

REPLY.—You can commence at once by removing the floor-board of the hive containing the bees, and placing the stock on top of a proper brood-chamber or makeshift box containing frames filled with full sheets of foundation for them to work down on to. When the queen is down on these newly-drawn combs put a Porter escape on to clear the bees from the misshapen combs.

## ROYAL LANCASHIRE AGRICULTURAL SHOW AT BURY.

We are invited to draw the attention of bee-keepers to the above show which is to be held from August 3rd to 7th at Bury, Lancs. Exceptionally liberal prizes are being given for honey, beeswax, and bee appliances. The entries finally close on the 10th inst., and any bee-keeper having good honey on hand will be well advised to enter it in view of the importance of the show and the extensive prize list. Though some of the classes are reserved for those residing in the county of Lancashire, there are several open to the United Kingdom.

## Bee Shows to Come.

*A nominal charge of 2s. 6d. is made for notices (not exceeding 7 lines) in this column, 10 lines charged 3s. 6d., up to 15 lines 5s., which covers cost of insertion from order till date of show. Cash should accompany orders for insertion.*

**July 13 and 14, at Brigg, Lincs.**—Lincolnshire B.K.A. Great Show of Honey, Hives, and Appliances, at the Brigg Exhibition of the Lincolnshire Agricultural Society.

**July 19 and 20, at Stafford.**—Honey Show in connection with the Staffs. Bee-keepers' Association. Four open classes. Schedules from Joseph Tinsley, 22, Granville Terrace, Stone, Staffs. **Entries close July 10.**

**July 20, at Southwell.**—Annual Show of the Notts B.K.A., in connection with the Horticultural Society's Show. Open class for Single 1-lb. Jar. First prize, 20s. Schedules from Geo. Hayes, Mona Street, Beeston, Notts.

**July 25, 26, 27, at Gloucester.** Annual Show of the Gloucestershire B.K.A., in connection with the County Agricultural Show. Separate tent for Honey, Wax, and Appliances. Open classes. Special prizes. Schedules from Rev. F. H. Fowler, Barnwood Vicarage, Gloucester. **Entries close July 18.**

**July 25 to 29, at St. Albans.**—Honey Show of the St. Albans and District Bee-keepers' Association. Three Open Classes. Schedules, &c., of Mr. E. Watson, Holywell Hill, St. Albans.

**July 26 and 27, at Cardiff.**—Annual Show of the Glamorgan B.K.A. in connection with the Cardiff and County Horticultural Show. Separate tent for honey, wax, and appliances. Open classes. Special prizes. Schedules from Hon. Sec. Mr. Wiltshire, Maundy School, Cardiff. **Entries close July 20.**

**July 27, 28, and 29, at Rotherham.**—Show of Hives, Honey, &c., in connection with the Royal Yorkshire Agricultural Society. **Entries closed.**

**August 2, at Stoke Park, Guildford.** Annual Exhibition of Bees, Wax, Appliances, &c., will be held by the Surrey B.K.A., in connection with the Guildford and West Surrey Agricultural Association. Nineteen classes (five open to all). Many medals. Schedules from F. B. White, Hon. Secretary, Marden House, Redhill, Surrey. **Entries close July 22.**

**August 3 to 7, at Bury, Lancs.** Honey Show in connection with the Royal Lancashire Agricultural Society's Exhibition. £35 in prizes (together with special prizes) for Honey, Wax, and Appliances. Schedule from E. Bohane (Sec.), Derby House, Preston. **Entries close July 10.**

**August 3, at Weston-super-Mare.**—Annual Show of the Somerset B.K.A., in connection with the important Local Annual Flower Show. Classes for Appliances, Honey, Wax, and Bee Products. Several open and free classes. Liberal prizes.

Numerous attractions. Excursions from all parts. For Schedule, &c., apply to T. Jones, Assistant Show Secretary, North View, Milton-road, Weston-super-Mare. **Entries close July 29.**

**August 7 (Bank Holiday), at Cambridge.** Honey Show in connection with the Cambridge Mammoth Show Society. All Open Classes, four Special Hives to be competed for. This Show also includes dogs, poultry, pigeons, rabbits, cage birds, flowers, fruit, and vegetables; also grand programme of sports and motor racing, &c. Balloon ascent and parachute descent by Captain Spencer. The champion prize band (Irwell Springs) has been specially engaged. Schedules from Hon. Sec., E. F. Dant, Member of B.B.K.A., 52 Bridge Street, Cambridge. **Entries close Thursday, August 3.**

**August 7, at Epworth.** In connection with the Epworth Agricultural Show of Horses, Beasts, Pigs, Poultry, Pigeons, Rabbits, Cage-Birds, Honey, Dairy Produce, &c. Lines, B.K.A. in charge of Honey Section. Schedules from W. E. Burrows, Secretary, Epworth, Doncaster.

**August 9, at Wye, Kent.**—Kent Honey Show. Four Open Classes. Fourteen open to Kent. Trophy Cup value 3 guineas. Open to Kent, Surrey, and Sussex. Two Challenge Cups value 6 guineas each. Many other special and money prizes. Special classes for Cottagers, also class for members of Ashford and District Bee-keepers' Association. Schedules ready early in July, from H. C. Chapelow, Hon. Sec., Wye, Kent. **Entries close August 2nd.**

**August 10, at Madresfield, Malvern.** Annual Show of the Worcestershire B.K.A. Open Class for collection of Bee Products. Prizes, 20s., 10s. Schedules from George Richings, 2, Shrubbery Terrace, Worcester. **Entries close August 5.**

**August 16, at Lancaster.** Lancaster Agricultural Society, in conjunction with the Lancashire B.K.A. 16 Classes for Honey, Bee Produce, and Bee Hives. Numerous specials, including 2 silver challenge cups, 12 silver and bronze medals. Write for Honey Schedule to Robert Gardner, 13, Sun St., Lancaster. **Entries close August 2.**

**August 23, at Radstock, Somerset.**—Honey Show in connection with the Radstock Horticultural and Farmers' Association. Open and gift classes. Write for Honey Schedule. B. M. Clark, Foxhills, Radstock.

**August 23 and 24, at Shrewsbury.** Annual Show of the Shropshire Bee-keepers' Association, in connection with the Shropshire Horticultural Society's Great Floral Fête. Eight Open Classes for Honey. Free entry for single bottle and single section. Schedules from S. Cartwright, Hon. Sec., Shawbury, Shrewsbury. **Entries close August 11.**

**August 30, at Chester.** Annual Show of the Cheshire B.K.A. in connection with the County Agricultural Show. Several Open Classes. Good prizes. Schedules, &c., from Hon. Sec., E. W. Franklin, Mouldsworth, near Chester.

**September 13th, at Conway, N. Wales.** Great Annual Honey Show in connection with the Conway Honey Fair. Open and local Classes. Schedules from J. Hughes, Town Hall, Conway. **Entries close September 6th.**

**Sept. 27 at Altrincham.** Honey Show in connection with the Altrincham Agricultural Show. Twelve Honey Classes. Schedules from J. Herbert Hall, 1, Market Street, Altrincham. **Entries close Sept. 9.**

## Notices to Correspondents.

*Letters or queries asking for addresses of manufacturers or correspondents, or where appliances can be purchased, or replies giving such information, can only be inserted as advertisements. The space devoted to letters, queries, and replies is meant for the general good of bee-keepers, and not for advertisements. We wish our correspondents to bear in mind that, as it is necessary for us to go to press in advance of the date of issue, queries cannot always be replied to in the issue immediately following the receipt of their communications.*

**ANXIOUS to KNOW (Forfar).**—*Material for Quilts.*—No, it is not advisable to use

American cloth on top of frames, as it is not porous. Unbleached calico or ticking are both good; they are porous, cheap, and can easily be renewed when dirty.

**TINY TOR (Strathpeffer).**—*Time to put on Supers.*—You must wait until all the combs are drawn out and filled with brood before putting on supers. As a rule swarms do not give surplus. When the hive is crowded with bees, and you notice that the first row of cells next to the top-bars are elongated and sealed with white cappings, you will know that the time has come to put on the section racks.

**W. J. M. (Herts).**—*Library of Bee-Books.*—Most of the county bee associations already possess libraries for the use of members, and the British B.K.A. also has a circulating library from which members can obtain both new and old bee literature.

**W. H. (Cams).**—*Overlacing Sections.*—You have evidently been mistaken. We were present at the show in question, and the cases disqualified are not listed as show cases, but for ordinary commercial use only.

**NOVICE (Gloucestershire).**—*Beginners Queries.*—(1) The correct spacing between brood frames is one  $\frac{2}{32}$  of an inch, the W.B.C. ends should butt up to each other. Narrow ends should be used, and not the wide ones (see page 40, British Bee-Keeper's Guide Book). (2) Use either naphthaline or Apicure. (3) Do not hybridize at all; it is best to stick to the native bee. If you must cross, then Ligurian queen and English drone are the best to choose. To introduce a queen you must use a cage (see pages 131, 135, and 138 of Guide Book).

**W. A. F. (Settle).**—*Name of Plant.*—The plant is the common snow berry (*Symphoricarpos racemosus*), and is very much visited by bees.

**J. W. G. (Huddersfield).**—*Immature Bees Cast Out.*—The immature bees appear normal, and there is nothing to indicate disease. The adverse weather has no doubt been the cause of their being cast out of the hive. This is not an unusual occurrence.

**F. F. (Cornwall).**—*Drone-Brood in Sections.*—This occasionally happens through the queen being small, and able to get through the excluder. In your case the bees may have carried up the eggs.

### Suspected Disease

**J. L. B. (Worcester).**—It is certainly not foul-brood, and that in the sample appears to be merely chilled brood.

**FLORIST (Milford).**—There is no fresh brood in the comb, and nothing to indicate disease.

**HERTS.**—In "Isle of Wight" disease the queen is not affected, so we do not think this can be the cause of death. Send a few of the bees (alive if possible) to Dr. Malden, Pathological Laboratories, Cambridge; he will be able to tell you.

**A. N. (Galashiels).**—(1) From description it appears to be "Isle of Wight" disease, but we are sending you leaflet which will enable you to decide. (2) It is possible that the disease may have been contracted by the introduction of the queen and frames of comb you mention, although it is not yet certain to what extent the disease is contagious. (3) There is no need to send comb for examination as the disease is one affecting adult bees, and dead bees are useless for the purpose. (4) The leaflet will give all information as to treatment and disinfection.

### Special Prepaid Advertisements

Two Words One Penny, minimum Sixpence.

Orders for three or more consecutive insertions entitle advertisers to one insertion in "The Beekeepers' Record" free of charge.

Trade advertisements of Bees, Honey, Queens, and Bee goods are not admissible at above rate, but will be inserted at 1d. per word as "Business" Announcements, immediately under the Private Advertisements. Advertisements of Hive-manufacturers can only be inserted at a minimum charge of 3s. per  $\frac{1}{2}$  in., or 5s. per inch.

### PRIVATE ADVERTISEMENTS.

**FAWN-COLOURED** young hornless Nanny, in full milk, used to children, and broken to harness; exchange for Bees, or sell £1.—**WOOD,** The Crags, Maltby, Rotherham. k 62

**WANTED,** Extractor, Cowan's, with reversible cages preferred, in perfect order.—**PATCH,** Ilstington, Devon. k 63

**FOR SALE,** 1 frame hive, 3 section racks, 1 excluder, 4 feeders, 1 super clearer; all in sound condition, 18s.; free on rail.—**F. C.,** 2 Bellevue-road, Southbourne, Hants. k 59

**WANTED,** geared extractor, good condition. must be cheap. Deposit; approval.—**Particulars,** HAIGH, Twiston, Clitheroe.

**HONEY RIPENER** and Strainer, new; exchange for strong March hatched Chickens (pullets).—**MULLEY,** Filey. k 68

**FOR SALE,** Yorkshire Terrier, good yard dog at night, gentle and affectionate with children, price £1, suit poultry farmer, &c.—**COLIN HINGE,** Northolt, Southall. k 66

**FOR SALE,** cottage with 3 acres of land, fruit, poultry, 40 hives Bees, and good connection for sale of honey.—9, "B.B.J." Office, 23, Bedford-street, Strand, W.C. k 45

**1** TON pure Cambridgeshire fine light-coloured  
**2** HONEY, 1911, chiefly sainfoin, white clover, in 1cwt. and 28lb. tins, for 70s. per cwt.; sample 2d.—**JOHN CUNNINGHAM,** Stetchworth, near Newmarket, Cambs. k 63

**HONEY EXTRACTOR,** must sell for first reasonable offer, cost me 25s., used once, will last a lifetime.—**C. WEST,** 65, Hemingford-rd, Cambridge. k 64

**BEEES.**—A few guaranteed healthy Stocks in W.B.C. hives, for disposal, all in perfect condition, a really first-class lot.—**Apply,** S. care of "B.B.J." Office, 23, Bedford-street, Strand. k 69

**BEE FARM.**—Owing to ill-health, lady must sell her Bees and Appliances; modern convenient House with garden and meadow might be taken over, near station, 40 miles from London, excellent honey country, good trade connection.—**LYNDHURST,** Southminster, Essex. k 50

**IMMEDIATE DISPOSAL.**—Six Irish, ditto Lee's Hives, little used, lifts, floor ventilators, 8 combs, and section crate each, 10s. 6d. on rail; absolute guarantee.—**Address,** M., 5 Park Row, Hornsea. k 52

**WANTED,** first grade Sections and Extracted Honey (English).—**Apply,** stating price, to R. S., care of "B.B.J.," 23, Bedford-street, Strand, W.C. k 27

### BUSINESS ADVERTISEMENTS.

**SECTIONS OF HONEYCOMB** wanted to purchase for cash.—**T. SMITH** and Co., Cambridge-street, Hyde Park, W. k 13

**PRIME HEALTHY NATURAL SWARMS,** 10s. 6d., boxes free, prompt attention, live delivery, and satisfaction.—**HIGGINSON,** Egerton, Kent. k 65

**DEEP OR SHALLOW FRAMES** made up complete, metal ends and wired, 3s. 6d. doz., carriage paid; furniture fixed at 2s. 6d. per lb.—**H. CRESSY,** Friary Mill, Dorchester. k 67

**PROLIFIC HYBRID QUEENS,** 15 years' experience, fertiles 4s., virgins 2s.—**MOORE,** 10 The Avenue, Bedford. k 60

**SECTIONS,** new, wanted by the **HONIELADE** Co., 23, Moorfields, E.C.

**ITALIAN QUEENS** direct from Italy.—See complete advertisement in "B.B.J." May 18th. Special offers are countermanded till further advice.—**Address,** E. PENNA, Bologna, Italy.

**QUEENS,** 1911, tested, delivery guaranteed, in introducing cage, Hybrids 5s., blacks 4s. 6d.—**BRICE'S APIARIES,** Otford, Kent.

**DRIVEN BEES WANTED,** 1s. 6d. lb. cash, boxes returned carriage paid.—**A. W. GAMAGE, Ltd.,** The Holborn Apiary, Church End, Finchley, N.

**WANTED,** Sections, first quality, prompt cash any quantity.—**W. CHILTON,** Southdown Apiaries, Polegate, Sussex.

**SECTION GLAZING.**—Best quality Lace Paper, made especially for Bee-keepers' use, not common box edging, white, 100 6d., 300 1s. 4d., 500 2s. 3d., 1,000 3s. 9d., post free; blue, green, or pink, 100 7d., 300 1s. 6d., 500 2s. 6d.; Lace Bands, 2 $\frac{1}{2}$  in., 3in., and 3 $\frac{1}{2}$  in. wide, white, 100 1s. 2d., 200 2s. 3d., 500 4s.; a few in pink and blue, 100 1s. 4d., 200 2s. 6d.—**W. WOOLEY,** Beedon, Newbury.

**APIARY** of 6 Hives for sale, boiling over with Bees, 10 spare Hives, Honey Extractor, 10 Crates Sections, 8 Racks, Shallow Frames, 30 Brood-combs, cheap. Particulars, Watts, Chickereh, Weymouth. k 37



## Editorial, Notices, &c.

### CRAYFORD AND DISTRICT B.K.A.

#### LECTURE AT DARTFORD.

The second of a series of outdoor demonstrations, held by the above association, was a departure from the usual, inasmuch as this was held at "The Dene," Darent Road, Dartford, by kind permission of Mr. and Mrs. Keyes, under whose generous hospitality a large gathering of members and friends spent a pleasant, interesting and educational afternoon on Saturday last, July 8th. The alteration of the usual procedure of holding the demonstration at Crayford was made with the object of extending its sphere of influence by the Association and the knowledge of apiculture generally, and it is very satisfactory that the innovation was responsible for the appearance of quite a number of newcomers, whom it is hoped will join, and so strengthen the hands of this progressive association with its nominal subscription of 1s. per annum.

The lecturer (Mr. W. Herrod), having just returned from the Royal Show at Norwich, gave some very interesting particulars in connection with the apicultural exhibits there. From his description of yields and the quality of the honey, this season appears to have been a distinctly good one; but owing to the succession of bad years, generally speaking, the bees have not been in the condition to make the best of their opportunities. The information that the favourable weather has done much to get rid of disease was most agreeable news. Mr. Herrod dealt at some length with many points of interest, both to novices and veteran beekeepers, in his usual clear and concise style. Practical demonstration was given in driving a skep, securing the queen and rehousing the swarm. A supered frame hive was also examined; the reasons and uses of each operation being explained as the work proceeded. The lecturer then answered publicly and privately a number of questions, such as the members always reserve until the much-looked-for demonstration comes round. Mr. G. Judge provided three stocks for manipulating, and also on behalf of the association made the local arrangements for this very successful meeting. The next demonstration of the society will be held at Orchard House, Crayford, in the grounds of the president, E. R. Stoneham, Esq., on August 5th. On September 2nd the annual honey show will take place, and the usual good attendance of members and friends is anticipated at both meetings.

In conclusion a most hearty vote of thanks was accorded Mr. and Mrs. Keyes, and also Miss Powell, for their kindness, which was greatly appreciated by all.—*Communicated.*

#### HONEY IMPORTS.

The value of honey imported into the United Kingdom during the month of June, 1911, was £6,897.—From a return furnished to the BRITISH BEE JOURNAL by the Statistical Office, H.M. Customs.

#### HELPFUL HINTS FOR NOVICES.

##### TREATMENT OF SWARMS.

By W. Herrod.

The novice generally commences bee-keeping with a swarm which he purchases, but very often we find that through accidentally obtaining a stray swarm people who had no idea of keeping bees have been initiated into the craft. A prominent case is that of A. J. Root, of America; from a vagrant swarm which he found has grown one of the largest apiaries and manufacturing plants in that country.

Just as the first few years of life are to the human being the most vital for the health and strength in after years, so it is with the bees. Treatment of the swarm for the first few weeks will either mar or make the stock. Instinct teaches wild creatures their work right from the moment they are born, but in the case of man he has to rely upon his intelligence, and the knowledge obtained by those who have lived before him in dealing with dumb creatures. We have unique opportunities of seeing how ignorant the beginner oftentimes is with regard to the habits and treatment of bees, and it is remarkable how very few seem to realise the necessity of buying a good text-book dealing with the calling they are taking up. This applies equally well to the upper- as to the working-class, and I must confess that when dealing with queries of such a simple and rudimentary nature that a few minutes' perusal of a text-book would enable the enquirers to see exactly what to do, instead of spending twopence in postage, and very often sixpence for a wire, I feel inclined in reply to have printed in large red letters, "Buy the British Bee-Keepers' Guide Book and read it." Readers must not infer from this that editors do not like answering queries; quite the opposite is the case, from the fact that one feels the satisfaction of giving in a few concise words exactly the help the inquirer probably needs at the moment, and not what may be wanted later on. In the last hints I dealt with the orthodox method of hiving a swarm, and this should always be followed if possible. There are occasions when it is im-

possible to do this; for instance, if, after travelling a long distance the swarm arrives on a damp or cold day, it would be foolish to try to run the bees in at the front; they would simply hang together in clusters, and refuse to move. Under such circumstances, take them into a warm room and feed as described previously. When ready for hiving, remove five of the frames from the hive and space the remaining five as far apart as possible: have ready a sheet larger than the top of the hive, "dump" the bees straight in and cover quickly with the cloth. The next day the remaining frames can be put in and the feeder given. On about the second day after hiving, the bees should be confined to the number of frames they can cover thickly; when the combs are fully built out in these, then add the other frames one at a time. In this way, perfectly straight combs will be obtained. If spare combs are on hand it is well to utilise these, and interspace them with full sheets of foundation, so providing the queen with cells to lay in straight away. If a swarm is hived on all drawn-out combs, then a super should be put on at the same time; this will give them comb-building work to do, which, by nature, they are well fitted for, as in a natural state they make their home in a combless and foodless hollow. Frequently, when drawn-out comb is given surplus is obtained.

Swarms of the previous year very often are weakest in the spring. This can be accounted for by the fact that it is the old queen which accompanies the swarm. Therefore, if a record has been kept and the queen is an old one, she should be replaced about three weeks after hiving by a young, vigorous queen.

Where the bee-keeper does not pay attention to the recording of the age of queens, or carry on queen-rearing, and he has an idea the queen is an old one, she can easily be replaced by uniting a cast after first killing the old queen.

*Returning Swarms.*—This prevents increase and ensures surplus, all other conditions being equal. After the swarm has issued, go through the parent stock and destroy all queen cells (to do this effectively it is necessary to shake the bees from the combs), put on an extra super, and give bottom ventilation, and return the swarm in the evening.

*Definition of a Swarm.*—People frequently use this term erroneously. At Christmas they tell me they have six swarms (?) in the garden. A swarm is a cluster of bees with a queen, but without combs or brood. A colony or stock consists of bees, combs, brood, and food, established in a home.

## NECTAR-PRODUCING PLANTS AND THEIR POLLEN.

By Geo. Hayes, Beeston, Notts.

(Continued from p. 243).

No. 9. THE LIME (*Tilia Europaea*).

NAT. ORD. *Tiliaceæ*.

Of the Lime or Linden there are no fewer than ten species, six of which are natives of Europe, the others being American. For Britain it is limited to a single species.

The one most useful to bee-keepers, and commonly met with, is *T. communis*, although there is a second one, *T. pectolaris*, flowering a fortnight or three weeks later, and which yields a fair amount of nectar. The different species are often known amongst nurserymen as green twig, red twig, black twig, &c., from the colour of the bark on the young wood.

It is an exceedingly beautiful tree, grows fast, and attains a great size. In Switzerland and Germany there are lime trees of an enormous size. Sir Thos. Brown mentions one in Norfolk as being 90ft. high, with a trunk 48ft. in circumference at 1½ft. from the ground.

The lime bears the smoke of cities better than other tall-growing forest trees, and for this reason in the cities on the Continent, more especially in Germany, avenues are planted with it, and it would be an advantage, to bee-keepers in particular, if more were planted in the cities and parks of Britain. It has other advantages; the trunk is smooth, and is not so liable to get unsightly from wounds and decayed branches, as other trees. The leaves are of a beautiful delicate green, its flowers hang gracefully, and throw out a most agreeable fragrance.

Although a soft and weak timber, it is valuable for many purposes. It is delicately white and of a uniform colour throughout, and because of this, more than anything else, it is used for making our one-piece sections, as well as many other appliances used in bee-keeping.

Tons of it are imported into this country under the name of American white wood, as it is extensively employed in joinery, cabinet-making, musical instruments, model-making, and wood-carving.

In America, the lime is known as bass-wood, and it furnishes in many districts the chief supply of nectar, and bee-keepers value it, as we do clover or heather.

The flowers are peduncles hanging amongst the leaves, bordered or winged half-way up by the long, narrow, leaf-like tract. They are light yellow colour, or a

pale whitish-green, and both the buds and seeds are bunches of little balls. The nectaries in this flower are on the inner side of the thick, fleshy sepals, and when it is being secreted profusely it sparkles like dewdrops where the sunlight falls on its blossoms. The honey is of a greenish hue, and at first somewhat pungent, but mellows with age.

The pollen is of a dark-green colour when freshly gathered, of spherical form, marked with flutings, laps and processes, and measuring  $\frac{11}{1000}$  in. When viewed in the dry state, owing to these overlayings and flutings the outline forms appear strange and diverse, owing most probably to its opaqueness. These will be seen I A.

Notwithstanding the foregoing statement, the pollen of the lime preserves the most constant form of all that I have examined, for whether dry or in some medium—with the exception of an alteration in the process—its general form and markings are much the same, so that when once thoroughly realized, it is easy to remember.

When it is viewed partly by transmitted and reflected light, it is as seen at I B and C.

In moisture, the flutings fill up and processes grow; and when in formalin it is as shown at 2.

When taken from honey the swellings of the processes are not so well marked as in formalin, and sometimes appear as at 3 A, or as at 3 C, which represent two different faces of the grain. Moreover, it will be noticed that the processes appear to have filaments protruding, which, I think, may be caused by the rupture of the process; although there does not appear to be any escape of the fovilla or protoplasm of the Pollen grain.

The size of this grain is but very slightly increased in any kind of medium.

(To be continued).

## Correspondence.

*The Editors do not hold themselves responsible for the opinions expressed by correspondents. No notice will be taken of anonymous communications, and correspondents are requested to write on one side of the paper only and give their real names and addresses, not necessarily for publication, but as a guarantee of good faith. Illustrations should be drawn on separate pieces of paper.*

### NOTES BY THE WAY.

[8205] The month of July is sustaining its character for "July heat," which has caused the bees to cluster in the shady porches of the hives as they do in early June. The limes are in full bloom, and bee work begins early and closes with daylight in the evening, so that we are hoping to get our share of surplus from the limes this season. This honey, when mixed with that from white clover, makes a good marketable blend, though not equal in flavour to white clover and sainfoin honey.

The continued heat has not started swarming, so that I expect the season for this is now over for 1911. Particular wants and requirements affect one's management considerably; most bee-keepers, when they purchase a swarm or stock, do not want their bees to swarm, whereas the man with large apiaries, who has a demand for swarms, eagerly watches and hopes day after day for swarms to issue, so that he may fill his orders or replenish his empty hives; and the contrariety of things mundane will often give the small apiarist swarms galore, coupled with empty supers, and the large apiarist only a small percentage of swarms.

*Bee Sting Cures.*—My bee man says he has tried many remedies, but that used by his grandfather, viz., spirit of turpentine, is the best; it may relieve the pain, but it does not prevent the swelling. I myself

### 1. Dry.

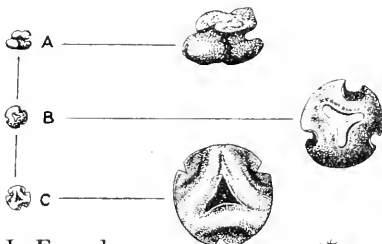

### 2. In Formalin.



### 3. From Honey.

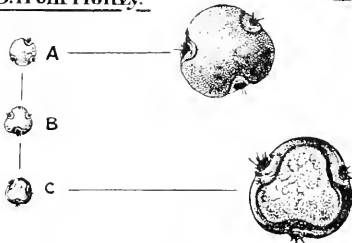

POLLEN OF LIME.

am so inoculated with bee-sting poison that I do not trouble to apply any remedy; I simply go on with the bee-work, extracting the sting with the finger-nail. If it is near the eye I press out the poison whenever possible by pressing the spot between two fingers, as this is the only part which swells. When stung on my hands and arms—and I generally work among the bees with sleeves rolled up—I cannot tell where the sting was injected.

*Queen Rearing.*—July is a good month for queen-rearing, and a read up of the chapters on the subject in "The Guide Book" will refresh the memory of the older bee-keeper and enlighten the mind of the novice in the work. If the plain instructions given by Mr. Cowan therein are carefully followed, queens as good as money can buy may be raised, providing one has a good strain of bees. Always start the queen-cells from eggs from the best queen in the apiary, and see that they are raised from the egg stage, and not from larva. The stocks in which you intend to supersede the queens can be de-queened four or five days after you have started the queen-cells, the bees will not worry the drones to death, but will allow them to remain, as these stocks will begin cell-building on their own account. These cells must be removed later, and a fine cell from your best stock put in place and allowed to hatch out and become fertile in the hive the queen is intended to head. You will thus have no risks on introduction, often a ticklish job with the amateur bee-keeper.—W. WOOLLEY, Beedon, Newbury.

#### NOTES FROM CORNWALL.

[8206] Though no longer engaged to a large extent in bee-keeping, I feel I should like to send a few notes, just to keep in touch with the bee world, though my time is so fully occupied in other ways that at present I cannot give such a large slice of it to correspondence as I used to do. I observe that Mr. Stapleton, of Gwinear, has contributed some very useful notes, and so far as practical bee work is concerned, I do not know of a more capable bee-keeper, and his experience with the "Isle of Wight" disease is very interesting. This disease, of which, personally, I have no experience, does not seem to be quite of the nature of an epidemic, but to result mainly from unfavourable seasons, which seriously impair the stamina of the bees.

I also note that some would compel the abolition of the straw skep as a home for bees, believing that it facilitates the perpetuation of foul brood. In my opinion, there never has been a more hygienic home devised for bees than the straw skep; it is

ideal in its porosity, without loss of heat, and for wintering weak lots it is absolutely essential. I find that it is very difficult to bring small late swarms through our winter, even in a very contracted brood nest in a frame hive, whereas they thrive splendidly in a dome-shaped straw skep.

The skep has its uses and will always be of value for special purposes, and to legislate it out of existence is not to be thought of.

As regards legislation generally, we must bear in mind that government control means "control," and that we should desire it only as a last resource. The great difficulty is to get really capable men as inspectors, who would be tactful and conscientious, and not themselves engaged chiefly in business as large bee-keepers; at any rate, they should not be "out for business" on their own account, selling bees, swarms or appliances. A great mistake has been made in the past in trying to increase the number of bee-keepers regardless of special fitness for the pursuit—a careless man has no business to keep bees at all. It is desirable that more British honey should be produced by the right kind of people, and the price is never likely to go lower than at present, which is on the whole a paying price.

I lately sampled some honey from Jamaica, but it was vile stuff, and would be dear at one penny per pound; we need not fear the competition of such honey as this. I fear that the present year is not likely to be noted for a large honey yield.—W. J. FARMER, Cornwall.

#### BEE-STINGS AND REMEDIES.

[8207] Many of the recorded remedies for bee-stings probably owe their value to the mechanical removal of the unabsorbed poison, thus enabling the system to deal with what has already entered the tissues. Hazeline has astringent properties as well as pain-allaying power, and I do not doubt its efficacy in some cases. Theoretically, a remedy should be a chemical antidote to the venom, but it is improbable that external application will cause the remedy to penetrate the wound and combine with the poison already in the tissues. The blue-bag probably modifies the toxicity of the venom, but the amount of blue that is absorbed by rubbing it on the skin is hardly worth troubling about.

Readers of the BEE JOURNAL should avoid the use of damp earth as a remedy, although it has been put forward on one or two occasions by a well-known contributor to the JOURNAL. The death of a shepherd from lockjaw indirectly caused by bee-stings renders this warning advisable.

The bacillus of lockjaw is present in practically every sample of garden earth, but owing to the fact that it requires special conditions to enable it to become active as a disease producer, it is frequently present on the skin and possibly in the tissues without ill-effect. I have had some thousands of stings, and only in one case was a sting followed by after effects due to the entrance of a bacillus. Nevertheless, I do not advise bee-keepers to increase their chances of trouble by using a remedy which could be used successfully for the experimental production of lockjaw.

From personal experience, I am quite satisfied that bees not only vary in the desire to use their stings, but also that in the poison injected there is considerable difference. The virulence may vary also according to nutritional factors. The subject is one, however, which presents considerable difficulty to exact investigation.

The experience of the lady friend of Mr. Snow (p. 256) is of interest in the study of immunity, and I am glad that he recorded it.—G. W. BULLAMORE, Albury, Herts.

[8208] I am not much affected by bee-stings fortunately, as I get a good number of them during the year, but my wife on the contrary, is very sensitive, and one single sting will cause swelling which lasts a week. We have tried a number of remedies, but only pure alcohol, put on the part stung, relieves her from the pain and prevents the swelling of the wound. About two or three years ago the sons of my gardener were playing underneath a tree where a big swarm was hanging. The branch on which the swarm had clustered broke off, and the swarm fell down upon the boys, whose yells were heard in all the neighbourhood. My wife rushed to the rescue, and rubbed the boys with pure alcohol, after having extracted uncounted numbers of stings, and the two boys played a few hours later as if nothing had happened. I don't believe there exists any universal remedy, as there are no two persons in the world who are perfectly alike! The best remedy, at least for bee-keepers, is to become immune, if they can!—ALEX. SCHRÖDER, Trieste.

#### QUEEN SURVIVING DISEASE.

[8209] A neighbour of mine asked me to destroy a stock of his which had foul brood. I accordingly went, and on examining the hive found that the disease was of old standing, and that not a single hive bee remained in the hive with the exception of the queen (which I enclose for your

inspection): she was crawling about on the middle frames. Is it not an exceptional thing for the queen to be the last survivor? There was about a score of dead bees on the floor-board, and a few more outside the hive.—B. E. BRIGHTON, Lincoln.

[Not exceptional, though a somewhat rare occurrence.—Ed.]

#### LEGISLATION FOR BEE DISEASES.

[8210] The Committee of the Cheshire Bee-keepers' Association have passed the following resolution, which they are sending to all the county's representatives in the House of Commons: "That all the Cheshire Members of Parliament be urged to support any legislation that may be introduced to enforce the compulsory examination of hives, by a duly appointed expert, for bee disease, and where found to have the power to deal with it. We are convinced that such a measure is absolutely necessary to suppress foul brood or bee pest."

If other County Associations would do the same and bring as much pressure as possible to bear upon the Board of Agriculture, at the present time, to introduce a Bill we should stand a very good chance of seeing such a measure passed. Will you kindly insert this letter in the JOURNAL, and oblige?—E. W. FRANKLIN, Hon. Secretary, Cheshire Bee-keepers' Association, Mouldsworth, near Chester.

#### SWARM CONTROL.

[8211] In reply to your correspondent, Mr. Pinkney (BEE JOURNAL, June 29th, page 255), who asks whether or not a queen may be safely introduced at any time of the year, let me say that while it is safe for the virgin, I do not recommend it at any other time than that at which a swarm may be expected. If I had a failing queen in spring I would remove her, and run a virgin in at the entrance at the end of four days without opening the hive to which she is to go. It matters not how old the laying queen is, the virgin is best as soon as she has emerged from the cell, before she has been fed, if possible. I prefer a change of queens by running an Italian queen into a hive headed by a dark queen. Any race may be exchanged; but the young queen should not be more than four days old. I would remove the old queen in autumn as in spring, or divide the stock and give the young queen to the queenless part at the end of four to six days, uniting after the young queen commences to lay by interspersing the combs after each has had the quilts removed for five minutes, allowing the airing to continue for about three

minutes longer before finally wrapping down. Use as little smoke as possible, apply no flour or scent whatever, and remove the old queen. No smoke is required when running in a virgin.—T. STAPLETON, Gwinear, Cornwall.

### BEEES AND BEE-KEEPING IN OXFORDSHIRE.

[8212] For the working out of Nature's great scheme, it is needful that men, in tastes, should differ. *Tot homenes quot sententia* was the proverb in ancient Rome. "So many men, so many minds." For a wise purpose therefore it is ordained that to some the delight of town life, the turmoil, the gaiety, the eternal come and go, are the charm of life's existence. But there are others, and I confess I am one, to whom the note of the wild bird, the scent of the new mown hay, the continued unfolding of the ever-varying pictures of the passing seasons, in a word the "simple life," surpassingly excel any artificial creation.

In Christ Church meadows, in the old city of Oxford, on a Sunday morning early in the month of June, Char, softly flowing to meet the sister river, ripples with the motion of the varied crafts. Beauty, luxurious, reposes on cushions whose hues outvie the rainbow, while athletes, whose graceful movements could tempt a sculptor's study, urge ever onwards. Mingling in the green overhead are hawthorn, white and pink, copper beach, and laburnum yellow. Golden with the bright sheen of buttercups o'er which the light breezes wantonly play, are the glades between the trees, from whence sounds the cuckoo's single note, or, when falls the evening, the sonorous "jug-jug" of the nightingale. Everywhere there are flowers. The old "quads" repose in a grey only to be achieved by the wind and rain of centuries, but they are garlanded and festooned, thrice or more, to every ancient wall, where long rows of windows hide themselves mid banks of red, white and blue, and yellow. In the "High," in the "Broad," in the "Carfax," boxes of flowers fill every sill; aye, even on Magdalen's hoary tower and castellated walls, wild herbage, clinging to every cranny, blossoms and blooms, and harmoniously tints and softens.

Humming always the same old melody, singing ever the music of which we never tire, with coat of velvet brown and quivering wings—here comes the bee. Flower and honey-honey gatherer and flower—always inseparable. Yet what chance brings her from crowding hives into this straitened city? Practical Sir John Lubbock points to the colours gay as the tempting attraction, but romantic

Maeterlinck would wish us to believe that it is the "Masked and sovereignly sage spirit of the hive," compelling her to seek fresh pastures and dwellings new mid college towers and hollow trees. Is there, then, dearth of food at home? Nay, for look around. In early spring, flower-laden branches, waving on a thousand trees, scent the air; where nestle in their woods Wroxton and princely Blenheim, Tusmore, Sherborne, Middleton and Heythrop, these—

"—stately homes of England;  
How beautiful they stand  
Amid their tall, ancestral trees  
O'er all the pleasant land."

Where Thames and Isis glide, a myriad honey-bearing plants carpet the even pastures. How delicious in their exquisite sweetness are the bean-fields, following in season's course, where the furrowing plough has turned the loamy soil. The harvest on every side is great, but the labourers, they who garner it, are as everywhere else, in numbers, insufficient. And why? This is a lotus-eating land, a place where time stands still. Many there are who profit by recorded wisdom and experience, but these are very many more who cling to those abominations of their forefathers, the skep and the sulphur pit. Blind to facts and deaf to reason, it is useless using persuasion with such as these. Let us hope that when, in a coming generation apiculture shall have equal advantages with other cultures which are aided by the State, this barbarous and most expensive legacy of our predecessors' want of knowledge may be educated off the face of the earth.

"The cottage homes of England,  
By thousands in the plains;

\* \* \* \* \*  
Through glowing orchards forth they peep  
Each in its nook of leaves."

To Mrs. Hemans's word painting, add thatched cottages which might have moved from out of Constable's pictures, with the interiors such as George Morland so loved to limn, with hedges of yew, square-cut as walls, save where in frolicsome mood they have been trimmed to simulate the broad tailed peacock or the nimble squirrel, and you will know what Oxfordshire villages are like, an old world air about them. You might almost expect to meet Haupten (he fell hard by, on Shalgrove field) in broad-brimmed hat and buckled shoes, but the shrieking motor rushing by recalls us from our reveries. Your modern bee-keepers would prefer to see those "glowing orchards" dotted with many rows of beehives. Will the time ever come when it will be known that, given as much interest in his bees as in his cabbages, poultry, or pigs, the cottager may earn money; and, also, shall I ask, when will those who control national technical education appreciate the very practical results of improved bee-keeping.

the knowledge of which may best be imparted to the rank and file by well-instructed teachers, who are able to give a reason for the faith that is in them? When will they learn the oft-told truth that agriculture has been increased in its products by apiculture? They are twin sisters marching together with linked hands. He who increases the resources of the country, increases its income, is a public benefactor, and deserves well of the nation.—J. SMALLWOOD, Hendon.

#### SUGAR AND ISLE OF WIGHT DISEASE

[8213] In reply to a query recently appearing in a science journal, I read that sugar is refined by tungstate of lime, hence the blue tint too often noticed by bee-keepers when boiling sugar for bee-feeding. I read: "Many samples of sugar showed this blue oxide of tungstate, a nauseous sulphury taste and smell."

Have any or our scientists when searching for the cause of "Isle of Wight" disease tried the effect of oxide-of-tungstate-refined-sugar on a healthy stock of bees? If not, why not?—S. C., CAMBS.

#### CAPPINGS OF COMB.

BY L. S. CRAWSHAW, NORTON, MALTON, YORKS.

*Scarcity of Swarms* (page 234).—Mr. Woodley's experience has been my own, only "more so," for I have not had a single swarm this year. I have waited for them open-mouthed, that is to say with hives all prepared, but to no purpose. In some instances, the conditions which Mr. Woodley outlines may have influenced, but generally my hive conditions have been good. Bees have been well up in the supers, with a fair-sized brood-nest below, so that I am led to think that the season itself, with its continuous honey flow, has not suggested swarming. Then the cold spell put it quite in the background, and now it would seem a little late for swarming to begin. But honey is once more coming in, and remembering Mrs. Tupper's classic phrase, it would not surprise me at all if the bees were to ignore dates, and suddenly to make up their mind to the annual excursion, for drone breeding has been steadily maintained in all the confidence of a full cupboard, and is now proceeding in every available corner, so that the Spirit of the Hive clearly contemplates the possibility of their need.

*Key and Kettle* (page 235).—W.S.W. refers to the tinkling of these symbols as an obsolete rite. Yet it is curious how firmly fixed in the countryside is that faith. Personally I am not ashamed to confess I have still an open mind on the subject. Quite recently I was talking with a well-

known local bee-keeper, Mr. Jesse Fry, of Ilkley, for whose opinions I have a certain respect. He it was, by the way, who instructed me in my initial attempt at swarm-taking. But to return to our pots and kettles. The other day a swarm came off in his absence, and proceeded on its travels. His small son, who has the makings of a bee-keeper, and who was on the watch, hastily grabbed some of the aforesaid musical instruments, and gave chase, playing vigorously, with the result, or at any rate the coincidence, that the quarry wavered, halted, and settled. It would take more argument than I can offer to convince Mr. Fry that the noise did not interfere with the voice of the queen, to which the ear of the swarming swarm was attentively keyed. Certain it is that even we can detect the note at times. And if there be truth in the theory, it may be, reasoning from the probability that the notes would be discordant, that confusion is the cause; further, that cases of failure may be explained by accidental sympathy of note, and that a fresh frying-pan would ensure success! I am supposing that queens emit a uniform note, as worker bees appear to do. This morning I was watching honey bees and several species of wild bees, all at work upon what is locally called "Lamb's lug," (ear), and the various notes were easily recognisable.

*Wiring Frames* (page 242).—For some time I invariably used thin Weed brood foundation, but I found difficulty in obtaining flat combs. Each portion, between wire and wire, would expand and bulge. The solution I found was to thoroughly warm each sheet before imbedding, so as to encourage expansion. Needless to say, my frames have plain top bars, and the foundation is waxed to them. Last week I came across an old bee-keeper who had hived a swarm upon unwired sheets, intending later to send the stock to the moor! When I examined the stock, several of the sheets had parted along the top line, and the result may be imagined. In this case, the hot weather had no doubt caused the swarm to expand itself fully, and the highest cells were unworked, resulting in some terribly weak combs. By the way, it is good to see that Mr. Herrod is opposed to the split top bar. Now perhaps we shall make some more progress with the campaign. "Abomination" is a fine word, and fully expresses itself.

*Strong Stocks* (page 243).—This demonstration might be profitably carried out every year, and all the local bee-keepers might be made to learn its lesson. My best stocks this year were those wintered with two queens. I shall certainly extend the principle this autumn. The hive is

divided tightly and centrally, and entrance given at the extreme ends of the alighting board. Two weak stocks wintered well in this way, and a strong stock split up with the queenless half requeened, did equally well. Winters may vary of course, but I recommend that the system be tried on a small scale.

*Cure for Bee-Stings* (page 246).—I must confess to G.S.N., that I do not know what the ancients used to alleviate bee-stings. I suspect they grinded and bore, or applied a fomentation of herbs. But I know that witch hazel (Pond's Extract) is useful, and I believe I am right in supposing that witch hazel is contained in the preparation he recommends. It might be helpful if he would compare in his person the effect of each, to see whether relief is entirely due to this plant.

*W. Z. Hutchinson* (page 251).—As a reader of the Bee-keeper's Review, may I express my sorrow at the loss of "W. Z.," whose personality had endeared him to many who never saw him, and whose abilities had elevated him to a distinguished place amongst the fraternity, not only of his own country, but on this side of the water also. Quite recently, when renewing my subscription for several years in advance, I wrote him to the effect that if several bee journals arrived by the same post, the *Review* invariably claimed precedence. This journal, upon which he has impressed his individuality and his love of the beautiful and perfect, has stood out for years as the organ of the specialist. I cannot but acknowledge the stimulus which I have often experienced at his hands. His text was continually one of progress and hope, and it is not easy to see how his place can be adequately filled, and the bee-keeping world repair its loss.

## Queries and Replies.

[1861] *Beginner's Queries*.—Will you kindly answer questions I ask below? (1) How long would a swarm cluster before dispersing? (Bees sometimes swarm when one is on holiday, and there is no one to attend to them). (2) What would happen to a swarm if it was not discovered, and was not lived? (3) In hiving a swarm, would excluder-zinc over the opening of the hive enable one to discover the queen? (I have never seen a queen yet). (4) I do not want more than the two hives I now have. In the future, failing a private purchaser, is there any firm who would purchase the swarm? BEGINNER.

REPLY.—(1) Uncertain. A great deal depends upon the weather. We have known them hang for three days, and at

other times only a few minutes. Also at times swarms will remain and build combs where they cluster. (2) It would find a home somewhere by sending out scouts. (3) Yes. (4) You can always sell through our advertisement columns. With reference to the other part of your letter, the proper way to work was to hive the swarm on the old stand and put the super on it. It is doubtful if you will get surplus from either now.

[1862] *Stray Swarm Entering Hive*.—In one of my stocks of bees I have just noticed some yellow banded bees, and I cannot account for their presence. Could you suggest a reason, as the stock originally consisted of ordinary brown bees. Do you think it likely the queen is partly Italian, or has a stray swarm come along and entered the hive. I noticed a week ago several dead bees on the alighting board and fighting going on.—B. W. G., Gloucester.

REPLY.—The bees are Ligurian Hybrids, and in all probability a stray swarm of these has entered the hive.

## Bee Shows to Come.

**July 19 and 20, at Stafford.**—Honey Show in connection with the Staffs. Bee-keepers' Association.

**July 20, at Southwell.**—Annual Show of the Notts B.K.A., in connection with the Horticultural Society's Show. Open class for Single 1-lb. Jar. First prize, 20s. Schedules from Geo. Hayes, Mona Street, Beeston, Notts.

**July 25, at Kidwelly, S. Wales** (Agricultural and Horticultural Show). Open Class for Honey. 1lb. glass jar of present season honey, 1st prize, 10s.; 2nd, 5s.; 3rd, 2s. 6d. Entrance free. Honey to become the property of the Committee. Sec., J. Morgan, Kidwelly. **Entries close July 22.**

**July 26, at Nether Wallop.**—Annual Honey Show of the Wallow Horticultural Society. Open Classes for Honey. Best 1lb. jar extracted, best 1lb. section. Entry free. Schedules from Pryce E. Roberts, School House, Nether Wallop, Stockbridge. **Entries close July 19.**

**July 25, 26, 27, at Gloucester.** Annual Show of the Gloucestershire B.K.A., in connection with the County Agricultural Show. Separate tent for Honey, Wax, and Appliances. Open classes. Special prizes. Schedules from Rev. F. H. Fowler, Barnwood Vicarage, Gloucester. **Entries close July 18.**

**July 25 to 29, at St. Albans.**—Honey Show of the St. Albans and District Bee-keepers' Association. Three Open Classes. Schedules, &c., of Mr. E. Watson, Holywell Hill, St. Albans.

**July 26 and 27, at Cardiff.**—Annual Show of the Glamorgan B.K.A. in connection with the Cardiff and County Horticultural Show. Separate tent for honey, wax, and appliances. Open classes. Special prizes. Schedules from Hon. Sec. Mr. Wiltshire, Maindy School, Cardiff. **Entries close July 20.**

**July 27, 28, and 29, at Rotherham.**—Show of Hives, Honey, &c., in connection with the Royal Yorkshire Agricultural Society. **Entries closed.**

**August 2, at Stoke Park, Guildford.** Annual Exhibition of Bees, Wax, Appliances, &c., will be held by the Surrey B.K.A., in connection with the Guildford and West Surrey Agricultural Association. Nineteen classes (five open to all). Many medals. Schedules from F. B. White, Hon. Secretary, Marden House, Redhill, Surrey. **Entries close July 22.**

**August 3 to 7, at Bury, Lancs.** Honey Show in connection with the Royal Lancashire Agricultural Society's Exhibition. **Entries closed.**



**August 3, at Weston-super-Mare.**—Annual Show of the Somerset B.K.A., in connection with the important Local Annual Flower Show. Classes for Appliances, Honey, Wax, and Bee Products. Several open and free classes. Liberal prizes. Numerous attractions. Excursions from all parts. For Schedule, &c., apply to T. Jones, Assistant Show Secretary, North View, Milton-road, Weston-super-Mare. **Entries close July 29.**

**August 7 (Bank Holiday), at Cambridge.** Honey Show in connection with the Cambridge Mammoth Show Society. All Open Classes, four Special Hives to be competed for. This Show also includes dogs, poultry, pigeons, rabbits, cage birds, flowers, fruit, and vegetables; also grand programme of sports and motor racing, &c. Balloon ascent and parachute descent by Captain Spencer. The champion prize band (Irwell Springs) has been specially engaged. Schedules from Hon. Sec., E. F. Dant, Member of B.B.K.A., 52 Bridge Street, Cambridge. **Entries close Thursday, August 3.**

**August 7, at Epworth.** In connection with the Epworth Agricultural Show of Horses, Beasts, Pigs, Poultry, Pigeons, Rabbits, Cage-Birds, Honey, Dairy Produce, &c. Lines. B.K.A. in charge of Honey Section. Schedules from W. E. Burrows, Secretary, Epworth, Doncaster.

**August 7, at Melton Constable.** The Annual Honey Show of the North Norfolk B.K.A. will be held at Melton Constable Park on above date. Several Open Classes. Schedules from Secretary, North Norfolk B.K.A., The Pightly, Letheringsett, Holt, Norfolk.

**August 9, at Wye, Kent.**—Kent Honey Show. Four Open Classes. Fourteen open to Kent. Trophy Cup value 3 guineas. Open to Kent, Surrey, and Sussex. Two Challenge Cups value 6 guineas each. Many other special and money prizes. Special classes for Cottagers, also class for members of Ashford and District Bee-keepers' Association. Schedules ready early in July, from H. C. Chapelow, Hon. Sec., Wye, Kent. **Entries close August 2nd.**

**August 10, at Madresfield, Malvern.** Annual Show of the Worcestershire B.K.A. Open Class for collection of Bee Products. Prizes, 20s., 10s. Schedules from George Richings, 2, Shrubbery Terrace, Worcester. **Entries close August 5.**

**August 16, at Lancaster.** Lancaster Agricultural Society, in conjunction with the Lancashire B.K.A. 16 Classes for Honey, Bee Produce, and Bee Hives. Numerous specials, including 2 silver challenge cups, 12 silver and bronze medals. Write for Honey Schedule to Robert Gardner, 15, Sun St., Lancaster. **Entries close August 2.**

**August 23, at Radstock, Somerset.**—Honey Show in connection with the Radstock Horticultural and Farmers' Association. Open and gift classes. Write for Honey Schedule. B. M. Clark, Foxhills, Radstock.

**August 23 and 24, at Shrewsbury.** Annual Show of the Shropshire Bee-keepers' Association, in connection with the Shropshire Horticultural Society's Great Floral Fête. Eight Open Classes for Honey. Free entry for single bottle and single section. Schedules from S. Cartwright, Hon. Sec., Shawbury, Shrewsbury. **Entries close August 11.**

**August 30, at Chester.** Annual Show of the Cheshire B.K.A. in connection with the County Agricultural Show. Several Open Classes. Good prizes. Schedules, &c., from Hon. Sec., E. W. Franklin, Mouldsworth, near Chester.

**August 30 and 31, at Coventry.**—Annual Show of the Warwickshire B.K.A., in connection with the Warwickshire Agricultural Society. Separate tent for Honey, Wax, and Appliances. Open Classes. Schedules, &c., from J. N. Bower, Knowle, Warwickshire.

**September 13 and 14, at Cambridge.** Honey Show in connection with the Cambridge and District Red Cross Horticultural Society. Four Classes, open to all. To be held in the Corn Exchange, Cambridge. Schedules and particulars of Hon. Sec., E. F. Dant, Member of B.B.K.A., 52, Bridge Street, Cambridge. **Entries close Saturday, September 9.**

**September 13, at Conway, N. Wales.** Great Annual Honey Show in connection with the Conway Honey Fair. Open and local Classes. Schedules from J. Hughes, Town Hall, Conway. **Entries close September 6th.**

**Sept. 27 at Altrincham.** Honey Show in connection with the Altrincham Agricultural Show. Twelve Honey Classes. Schedules from J. Herbert Hall, 1, Market Street, Altrincham. **Entries close Sept. 9.**

## Notices to Correspondents.

J. S. H. (Hampstead).—*See of Bee.*—The bee is an ordinary drone. It has been injured by the workers in their attempt to cast it out of the hive.

WORKER BEE (Huddersfield).—*Difference between Honey and Brood Cappings.*

(1) Honey is sealed over with pure wax, which is usually white in appearance. Brood is capped with a mixture of pollen and wax, and varies in colour from a light to a dark brown. (2) If sent by passenger train the carriage would be about the sun you mention.

BEE-KEEPER (Montgomery).—*Queen Cast Out of Hive.*—The queen appears to be about four years old, and has evidently been superseded.

T. E. (Bridgnorth).—*Hybridising Bees.*—Your friends are right. Stick to the British bee, it is best for this country.

HEATHER (Aberdeen).—*A Veteran Bee-keeper's Queries.*—The drones have been killed off in the usual way; the workers are worn-out ones; there is no indication of any disease. We are very pleased to hear from such an old subscriber as yourself, and hope you may live as long again to read our pages and keep bees.

### *Honey Samples.*

H. J. (Hexham).—The sample is from mixed sources, and is a medium table honey.

G. H. (Kent). Not English honey, and it has certainly not been gathered from clover. We should call it a sample of inferior foreign honey.

ELAS (Sale).—The honey is mainly from sycamore. It has been spoilt as far as colour is concerned by a small quantity of honey-dew, which it contains. We should not mind using it as a table honey, as in every other respect it is very good.

R. H. E. (Wellington).—No. 1 is a light clover honey, good in every respect except density, which would greatly reduce its chances of winning on the show bench. No. 2 is a medium honey to which the above remarks also apply.

A. A. K. (St. Leonards).—The honey mixed with comb has been gathered principally from hawthorn. The other sample is from mixed sources.

Cymro (Ty-Crois).—A very palatable clover honey, good on all points but density, which is poor.

M. B. J. (Bristol).—All three samples are from clover. It is difficult to give an opinion as to the suitability of sections for show-purposes without seeing them. The honey is of good quality, though it lacks density.

*Suspected Disease.*

L. L. (Berks).—You did quite right to destroy them, as the bees are suffering from "Isle of Wight" disease.

A. S. (West Bromwich).—We cannot trace signs of disease in bees sent.

G. F. (Hants).—There is one cell only of sour brood in the comb sent.

T. D. N. (Abington).—A case of foul brood in the early stage of the disease.

H. D. (Suffolk).—There is foul brood of the odourless variety in comb sent.

Dodo and C. W. (Kent).—The bees show external signs of "Isle of Wight" disease. We should advise you to send some to Dr. Malden, Cambridge.

J. G. (Cranbrook).—There is no disease; the queen is a drone breeder, that is all.

A. C. (Sussex).—We regret to say that the workers are affected with "Isle of Wight" disease. The drones show no signs of it.

### Special Prepaid Advertisements

Two Words One Penny, minimum Sixpence.

Orders for three or more consecutive insertions entitle advertisers to one insertion in "The Beekeepers' Record" free of charge.

Trade advertisements of Bees, Honey, Queens, and Bee goods are not admissible at above rate, but will be inserted at 1d. per word as "Business" Announcements, immediately under the Private Advertisements. Advertisements of Hive-manufacturers can only be inserted at a minimum charge of 3s. per  $\frac{1}{2}$  in., or 5s. per inch.

### PRIVATE ADVERTISEMENTS.

FOR SALE, Pale Honey. 60s. cwt., 29lb. tins.—COOK, Barton Mills, Mildenhall. k 80

HONEY, first quality, sections 9s. 6d. doz., three doz. 27s., cash with order.—R. COUSINS, The Rosary, Misterton, Gainsborough. k 71

7 STOCKS of BEES in Hives and surplus honey, six empty Hives, no disease, Extractor and Sundries, £10 the lot, reason for selling, leaving.—WARD, Gould's Grove, Wallingford. k 83

EXCHANGE Seven Homing Pigeons for Swarm.—Particulars, PEAR'S, 51, Pugin Street, Carlisle. k 70

FINEST ENGLISH HONEY, 17s. 6d. per 29lb. tin, sample 2d.—DUTTON, Terling, Essex. k 72

HONEY (run), 56s. cwt., on rail at March, empties returnable, sample 2d.—PEPPER, Guide Post, March. k 82

WANTED, good Extracted Honey, light colour.—R. HUMPHRIES, 92, Amphilil Road, Bedford. k 74

6 RACKS SHALLOW FRAMES FOR SALE, drawn combs, just fit for heather work, guaranteed clean and healthy.—KEW, 5, Grosvenor Terrace, Wantage, Berks. k 75

### Special Prepaid Advertisements.—Continued

FINEST grade Sainfoin Clover Sections, 10s. doz., second grade, 14oz., 8s. 6d. doz.—NORTH, Cressing, Braintree, Essex. k 77

EXCHANGE for Pure Honey, extracted, 1911 grand Pen of Buff Orpingtons or Black Wyandottes, laying, perfectly healthy.—EDGELL, poultry breeder, Fanington, Bristol. k 81

SECTIONS wanted for cash, send price, any quantity.—F. W. WEIZEL, 45, Kempe Road, Kensal Rise, N.W. k 76

DRIVEN BEES wanted, in 5lb. lots, healthy, young Queens, guaranteed, 1s. 9d. lb.—82, Main Street, Cockermouth. k 79

HAVING sold a number of my stocks, have good, clean, healthy racks drawn out shallow Frames, 4s. each on rail.—A. GREEN, Tangley, Andover. k 73

FERTILE QUEENS, Native, post free, 2s. 9d. each.—J. C. MELLORS, Norton Cuckney, Mansfield. k 68

FOR SALE, 1 frame hive, 3 section racks, 1 excluder, 4 feeders, 1 super clearer; all in sound condition, 18s.; free on rail.—F. C., 2 Bellevue-road, Southbourne, Hants. k 59

WANTED, geared extractor, good condition, must be cheap. Deposit; approval.—Particulars, HAIGH, Twiston, Citheroe.

BEES.—A few guaranteed healthy Stocks in W.B.C. hives, for disposal, all in perfect condition, a really first-class lot.—Appy, S., care of "B.B.J." Office, 23, Bedford-street, Strand, E.C. 9

BEE FARM.—Owing to ill-health, lady must sell her Bees and Appliances; modern convenient House with garden and meadow might be taken over, near station, 40 miles from London, excellent honey country, good trade connection.—LYNDHURST, Southminster, Essex. k 50

### BUSINESS ADVERTISEMENTS.

HEALTHY DRIVEN BEES, 6s. lot, August delivery, orders rotation.—BRADFORD, expert, Worcester. k 78

WANTED, young Woman to sell Honey during the summer months at seaside exhibition on Welsh coast, one with knowledge of bee-keeping preferred.—Apply, with full particulars, and state wages required to "BEES," "B.B.J." Office, 23, Bedford Street, Strand, London, W.C.

BRITTANY Fresh Butter, Eggs, Poultry, Potatoes, Fruit, Mistletoe, Cider, Honey and Wax forwarded at best terms. Established 1827.—LIMEUL, General Merchant, bee-keeper, Dol de Bretagne, France. k 84

GILLIES' Shilling Control Outfit, refuse substitutes.—Wholesale, IREKLING CORPORATION, Dublin. k 85

SECTIONS of HONEYCOMB wanted to purchase for cash.—T. SMITH and Co., Cambridge-street, Hyde Park, W. k 13

DEEP OR SHALLOW FRAMES made up complete, metal ends and wired, 3s. 6d. doz., carriage paid; foundation fixed at 2s. 6d. per lb.—H. CRESSY, Friary Mill, Dorchester. k 67

PROLIFIC HYBRID QUEENS, 15 years' experience, fertiles 4s., virgins 2s.—MOORE, 10 The Avenue, Bedford. k 60

SECTIONS, new, wanted by the HONIELADE Co., 23, Moorfields, E.C.

ITALIAN QUEENS direct from Italy.—See complete advertisement in "B.B.J." May 18th. Special offers are countermanded till further advice.—Address, E. PENNA, Bologna, Italy.

## Editorial, Notices, &c.

### NORTHUMBERLAND AND DURHAM B.K.A.

The members of the Northumberland and Durham Bee-keepers' Association held their annual excursion on Saturday, July 8, the place visited being the apiary of Mr. J. N. Kidd, of Well Close, Stockfield. There was a large attendance, notwithstanding the fact that the weather conditions at mid-day were bad.

The party having inspected the apiary, were shown a collection of baby nuclei. Mr. Kidd explained that baby nuclei were not considered a success in England, on account of the variable climate, but his experience was that the necessary warmth was obtained by having a good cluster of bees. While he could not recommend the nuclei, he thought they were worth experimenting with, and were certainly useful for keeping on hand young virgin queens for introduction into working colonies.

The lecturer gave an interesting demonstration of the formation of a nuclei hive by taking away from a ten frame standard hive the two outside combs containing honey and pollen and a brood comb of hatching brood, thus forming a small colony which would afterwards be provided with a young queen from the nuclei.

A conversazione was held in the evening, and members exchanged experiences. It was suggested that a queen club should be formed by the members of the association in order to investigate the claims of the English black bee, which is thought to be superior to the foreign bees which are being introduced. The objects of the club would be to ascertain where the best specimens of the English bees could be obtained, and then to endeavour to improve the strains.—*Communicated.*

### AMONG THE BEES.

*By D. M. Macdonald, Banff.*

*An Overplus of Pollen.*—In my locality I never suffer from this, but in many parts, where certain trees or flowers exist yielding in over-abundance, combs get clogged readily. Two plans may be given for getting it cleared out. Dr. Miller advises spraying the combs with diluted honey, when the bees will empty it. An Ayrshire correspondent some years ago gave a plan by which he cleared the combs by repeated syringing. A question asked by an African correspondent, however, applies rather as to how pollen may be kept out of the combs. I would like to give a few

plans, just for what they are worth, in the full belief that each may contain some useful hint on the subject. A queen not over prolific is an inciting cause. She does not quite keep pace with the desires of the workers, with the consequence that these knowing dames consign over much of the gathered nectar in the brood body. They are at the same time anxious to stimulate her to increased ovipositing, and carry in too much of the bee bread they know is a necessity to heavy brood raising. The brood area, from the incursion of these two substances, becomes still further lessened, adding to the trouble. The cure here is obvious; re-queen with a more prolific mother and she will force the pace and thus reduce the pollen area. Therefore a very heavy oviposit brings about a cure; conversely a poor layer intensifies it, and brings about heavily clogged combs. Secondly, a hive beyond the capacity of the colony in spring and early summer tends to the same result. Bees will store honey below, and in half idle times, with a plentiful supply at hand, will store pollen unduly. The remedy here would be temporarily to reduce the comb area, which would then become manageable by the force of bees, with the result that brood eggs, honey, and pollen would be under the control of the workers. They would "stoke" the queen in these circumstances much more heavily, and thus compel the nurses to utilise larger quantities of the indispensable bee-bread. Thirdly, the withdrawal of one or two combs and the substitution of empty frames with full sheets of foundation will induce comb building and so set the workers' minds inclined in a new direction. They will more industriously feed the queen who will then lay better, and the feeders will use up more nectar and pollen. These new combs are at once utilised by the queen and this accelerates the breeding. I observed lately a writer advised contraction of the brood area by placing several dummies where the combs withdrawn had been, and this forced a large contingent of bees into the supers when they stored. Less attention to breeding went on for a time, and workers desisted from pollen gathering—at least temporarily. Then the hive was restored to its normal condition with good results.

*Parcelling Sections.*—Any bee-keeper who has a retail home trade should make special provision for parcelling up the sections—from one perhaps to a dozen—which he may sell to chance customers, summer tourists or others who may happen to come his way. Parcelling them up loosely in a rough packet covered with used newspapers is a slovenly way of parting with them, and does not tend to encourage future sales. Even using white clean paper for wrapping each section, and clean

brown paper for making up the parcel, is only a shade better. Single sections or a small number should be cased in cardboard cartons, corrugated paper boxes, or, better still, glazed card cases. Some of the latter are to be had with a carrier, a piece of tape fixed on to the top to serve as a handle. Two very cheap and ever ready modes of fixing up parcels of any number are easily available. Your appliance dealer will supply you with thin boards  $4\frac{1}{4}$  in. broad by any length to suit two up to six sections. One of these placed under, and another over the sections, if they are two bee way, will make a close neat case, whereby the parcel can be carried any distance safely, and they are dust proof. They may be better when wrapped in brown paper. The second plan I would recommend is the use of the section *lid*, listed by some appliance dealers. These are cut  $4\frac{1}{4}$  in. exact, and then grooved all round to fit the inner part of the section. One fitted on each end of the parcel makes a neat box. Fasten this lengthwise with twine, and you have a neat parcel ready for carrying.

*A Drone Breeder.*—I made an interesting study of a drone breeding queen last summer. She headed a Southern swarm, and was said to have been an uncommonly prolific mother earlier in her career, but apparently she had received some injury about the abdomen, and looked long and lanky. The swarm was hived on all worker comb, and when I had the first peep at the interior the whole scene presented a picture the opposite of my expectations. I sacrificed the swarm to keep her and her works under observation. After a first fairly large amount of ovipositing, she later laid only by fits and starts. Here and there would appear a good large regularly arranged cluster of cells with mature larvæ all sealed at the same time with the prominent raised cap-pings distinctive of drone brood in worker cells. Then on another comb, and at some distance away, after nearly a week's cessation from egg-laying there would appear a small patch of larvæ, and then with another interval a few eggs deposited haphazard. The bees from my first observation seemed to have been discontented with her, as embryo queen-cells were started repeatedly, but for some time none of these were sealed. Towards the end of July one cell was approaching the capping stage, when something untoward happened to the drone tenant and the bees proceeded no further. Another one was sealed later, but I never saw any signs of the exit of its inmate. This cell was perfectly smooth on its outer surface. Early in August I gave them a frame with eggs and larvæ, but although they tended the grubs they made no attempt to rear queen cells. Strangely, too, they actually fol-

lowed their original queen to the other side of the hive, deserting the brood comb. By mid August, the colony had greatly dwindled, when, on leaving home, I gave them another frame of brood, committing regicide this time: but they refused to re-queen, and when I saw them again in September I judged all the original bees had died out.

---

## Correspondence.

---

*The Editors do not hold themselves responsible for the opinions expressed by correspondents. No notice will be taken of anonymous communications, and correspondents are requested to write on one side of the paper only and give their real names and addresses, not necessarily for publication, but as a guarantee of good faith. Illustrations should be drawn on separate pieces of paper.*

---

### ROSS-SHIRE NOTES.

[8214] Bees are doing remarkably well in the North, and, given favourable weather at the moors, should pile up something more than an average surplus. Unlike Mr. Woodley and others, we have had an excessive swarming season. In some apiaries every hive swarmed, while there has been quite a plethora of runaways.

Personally, I found the usual methods of abundant ventilation and ample super room quite ineffective to prevent swarming. About half my stocks swarmed, usually when I was from home, hung clustered for some time, and then flew away—back to their hives. I had taken the simple precaution of clipping every queen and lost not a single swarm, while others suffered severely. Further swarming was checked by cutting out all queen cells, extending supers, and alternating combs of unsealed honey with the brood.

Several colonies have reached the length of occupying a hundred sections each, while the strongest had to be divided, as no ordinary hive would hold them. For instance I have a twelve-frame stock wintered over with two queens now storing in over a hundred sections, while the increase from same is occupying two supers.

A single Italian colony wintered with a shallow super above has a like number to its credit, and its increase has a filled super as well. A "White Star" colony is even more promising. Wintered with one queen in a double storey hive it was twice divided, just at the end of May, then in early June. The parent stock now occupies three supers, while the new colonies are storing in two and four racks

respectively, every section in the nine racks being drawn, and more or less filled. In fact, I should have ten supers on, as the one with only two is badly cramped. The empty racks were in every case put above, in advance of requirements, and taken to by the bees when needed. Good sections are making 10s. the dozen, and shouldn't be allowed to come lower. What with abnormal brood-nest storage, and absconding swarms, many bee-keepers will have no great surplus for disposal.—J. M. ELLIS, Ussie Valley.

#### LEGISLATION FOR BEE DISEASES.

[8215] On this subject several "healthy and useful suggestions have recently been made in the "B.B.J." Some of those of last week, viz., Mr. W. J. Farmer's (8206) and Mr. E. W. Franklin's (8210) are certainly along the right lines, but the broad resolution of the Cheshire Bee-Keepers' Association is a very large order.

Would it not be wiser for the Board of Agriculture to invite suggested legislation from the central British Bee-Keepers' Association, say the chairman and secretary for the time being.

If the Board legislate and control, to the extent of ordering destruction of colonies, or even apiaries, should not the Board be asked to compensate, say, to the extent of two-thirds of the value of the property thus destroyed? This course would avoid friction; it would encourage the public-spirited bee-keeper to report any suspected troubles, and thus help to stamp them out.

Fear of personal loss would be to many poor men, on the other hand, an encouragement to hide their troubles, and thus spread them in a district.

Inspectors should be competent, and above suspicion. Mr. Farmer's suggestion forbidding inspectors becoming agents for appliances or dealers is excellent.—G. FIELD, Throop, Hants.

#### BEE STINGS AND REMEDIES.

[8216] My experience of bee-stings will possibly equal that of any of your correspondents, and as the subject is attracting some attention just now, it may be of interest. Last year, I proceeded to take my first honey (having only started bee-keeping two months before); the bee-escape had been on for twenty-four hours, and all the bees were below, but in lifting the section-rack, I had evidently not loosened it all round from propolis, and it came up with a sudden jerk, bee-escape and rack; thus exposing the large stock of infuriated bees. I had 21lb. of honey in my hands; my veil became loose, and I

was instantly covered, head, face, and neck, with angry bees. I can only describe the sensation as being probably what one would experience if a kettle full of boiling water was poured over one. Having got rid of the bees, a most difficult process, dozens of stings were extracted, and then applied with a soft brush my head was soaked with cloudy ammonia; this was most soothing for the time, and after suffering severely for ten hours, I slept through the night, and woke quite well, without a mark of battle! In a week, however, I experienced terrible irritation where the bees had stung, and this was only allayed by constant applications of a weak solution of Coult's acetic acid. This is the very best remedy for all stings, and had I used it at first, instead of the ammonia, which so quickly evaporates, I believe I should have had no trouble. But it should be Coult's, which can be applied with a sponge, or, if the irritation is very severe, rags well soaked in the solution must be kept on, and constantly renewed. But one thing is, I think, certain. People suffer proportionately from bee-stings as from other poisons, according to their state of health at the time.—M. W. BYLES, Redenham, Andover.

[8217] Personally, in my own case, when stung, I merely pick out the barbs. In other cases I find massaging with repeated applications of pure water gives maximum relief. Mechanically removing the venom is the principle of this antidote.—J. M. GILLIES, Apicultural Lecturer, Department of Agriculture and Technical Instructor, Ireland.

#### FIGHTING FOUL BROOD.

[8218] Your kind reply to my query set at rest any lingering doubts I had about the presence of disease. Before receiving it I had already shaken the bees off the combs, treating them as prescribed by the "Guide Book." I examined them to-day (July 7th), and found large slabs of perfectly healthy brood. I have been engaged in the pursuit for the last four years, and have nine stocks, which I have cherished as the apple of my eye. Cleanliness and comfort have been my mottoes. New hives, clean quilts, fresh combs, food in abundance—nothing has been lacking. They have responded to the treatment; and, so far, have repaid my interest by the pleasure they afforded, and also by a satisfactory surplus. I am content to write down bee-keeping as the most enjoyable hobby one can take up in the country.

But, alas! the demon of foul brood has now made its appearance. An old skep—

the wonder and awe of its owner—stood in the corner of a garden a short distance away. The bees died (a consumption to be devoutly thankful for). The idol, at whose shrine ignorance and incompetency had so long and so religiously worshipped, is detached from its throne and broken in pieces. The fragments are pitched over the hedge, and there exposed in all their shameful and wicked deformity. There they lay until a friend of mine had them covered up. He also has an apiary. "What a shame," he said. "These combs were a mass of disease, and all the bees in the countryside were swarming over them." Were mine amongst them? Who can say? Yet my stocks were examined by myself and an expert—a master hand—five weeks ago; and stronger and more healthy stocks one could not have met with in a day's journey.

Since writing you last, my best stock, supered and ready for the harvest, myself reckoning up the drops of liquid gold that each day such a going concern should bring in, has had to be dismantled, everything about them burned, and the poor, harmless insects (they develop an unusual temper at times) transferred to new hive. More foul brood; and where will it stop? Aye, there's the rub.

This is my tale of woe. May I point the moral? It is, to say the least, cruelty to animals (or people to be allowed to keep them who do not know the first rudiments of treating them properly). Yet how often do we see bees dragging out a miserable existence under every condition inimical to their well being, a misery to themselves, and a menace to others, entirely through the fault of their owners, who seem neither to know enough, care enough, nor trouble enough to take the slightest intelligent interest in them. These owners do no good themselves, and they are a nuisance to others.

Let us have a little legislation on the subject, a little public instruction, and a little examination of an owner's capabilities. Let us have a little compulsory inspection of his stocks, and finally, condemnation and prohibition in case of incompetency. Then may we hope that having expelled from our ranks the unworthy and the unfit, those of us who really have a genuine fondness for these industrious insects, or, may I say those of us who really and truly "have a bee in our bonnet," may have our most ambitious dreams realised—good seasons, good stocks, no disease, and surplus in abundance. J. T., Tomintoul.

#### AT THE ROYAL.

[8219] I had a very severe attack of that malady which affects so many of us

at this season. Its symptoms are a general disinclination for work, a dreamy wandering of the mind to other scenes, rural or maritime, and a tender interest in the display of light clothing and straw hats in the shop windows. As the force of the disease increases, frequent references are made to railway and tourist guides. And generally the final development is packing of portmanteaux and the bundling together of fishing rods, tennis bats, and such impedimenta, and early departure some morning by train. But why diagnose the holiday-fever? Who does not suffer from it and know it? Unfortunately, I could at the moment spare only one day, so I decided I would go to Norwich to the "Royal." I will not take a note-book, I will have a real day "off" and enjoy myself, I thought.

But the unexpected always will happen. Scarcely had I got on to the show ground when a well-known personage in matters apicultural, meeting me, greeted me with "Good morning, of course you have come to write an article on the show."

Now here was a fix. The "of course" meant that there was something expected of me. Should I say "No," it was at once obvious that I had been weak enough to give way to "holiday fever," and a consequent day's idleness. My *amour propre* shrank from this. On the other hand if I said "Yes," well I was not "telling the truth, the whole truth, and nothing but the truth," so like "Brer Rabbit," I looked wise and said "muffin." It then occurred to me that perhaps I might find some "copy," something which might serve to give variety to the weekly "menu." Mr. Editor, this is my excuse for troubling you.

Needless to say I was at once made free of the "Exhibition," and the mess, by our secretary. The quantity and quality of the real hard work done to make the show a success is self evident, and three or four lectures to give each day in addition! Well, I really don't envy you your work, Mr. Herrod, but there is one thing I do envy you, and that is the life in the open-air, à la Bohême, for a week, with pleasant companions and aides-de-camp. Your chef, for instance, Mr. Brown, knows how to cook a steak quite as well as how to raise honey.

But I have no intention of entering into the merits or demerits of the exhibition, that has already been done by practical pens. Having decided in order to quieten conscience, that it was necessary to find something to write about I mixed with the crowd gathered around the bee tent. I became

"A chiel amang ye takin' notes,  
And faith, he'll prent em."

Now Mr. Herrod was holding the atten-

tion of the crowd with his accustomed theme, and a near neighbour to me was a very well developed example of the gentler sex. Her voice was not exactly dulcet; it would have been no libel to call it gruff. Her accent betrayed the Lancashire lass. The lecturer was describing the massacre of drones at the end of the season, and chanced to speak of them as males. "Sarve 'em reet," quoth my neighbour. "Happen we'll ha votes for women." I have hitherto had rather an open mind on this question. Now I begin to wonder if "mere man" is sufficiently protected.

I watched two men with particular regard, they seemed so interested. Just as the lecturer was concluding, one turned to the other. "Mate," said he, "there are some queer wheezes nowadays, what with teddy-bears, monkeys, and toy pups, but to make pets of bees is the rummest go I have ever seen." From London these, Southend or Margate had evidently been the limit of their travels hitherto.

But there were others standing around who came for instruction, and I was asked why could not similar lectures be given at other shows besides the "Royal." I repeated to myself the question "Why not?" Surely in every county there is ability running to waste; there must be some who with a little practice could give an interesting lecture to last, say, three parts of an hour. I have been to county shows where there were so-called honey shows and bee tents, and have felt so disgusted with the whole fiasco that I could have welcomed with joy a tropical thunder-storm to sweep away the lot. A few bottles of second rate honey, and a dozen or two of indifferently filled sections constituted the exhibits. As for the lecturer, often utterly incapable of expressing simple sentences in every day King's English, needless to say few of the passers-by are attracted. What is required, and everybody's commonsense must see the truth, is a little more "thoroughness." If it is worth while having a show at all, do it well. In the case of county shows, the outlay for a bee tent, and the skeps to drive is relatively small, and is amply repaid by increased subscriptions, but you must put a man in command who knows his work and has some little fluency of tongue, able to answer the questions thrown at him in a tactful, attractive way. So very many of the crowd know but little about bees and bee-keeping—they have heard the bee has a tongue at one end of its anatomy, and possibly have experienced that it has a sting at the other—that when they are shown, as an object lesson, how submissive bees are with proper handling, they get interested, and would like to learn how the sweets may be gathered, with as few as possible of the asperities.—J. SMALLWOOD.

#### SUGAR AND ISLE OF WIGHT DISEASE.

[8220] Either through my writing in haste or printer's error (page 277) blue "oxide of tungstate" and "tungstate of lime" were both mis-spelt "tunsgate." Sorry the error was made.—S.C., Camb.

## Queries and Replies.

[8163] *Dividing for Increase*—I have not had any swarms this season, and have plenty of drawn-out combs. Would you advise me to increase by dividing my stocks, or is it too late for them to build up strong enough before winter. What is the best method of doing so. Should I remove the old stock after dividing, or leave it on the original stand. Bees have done fairly well about here during the hot weather, strong stocks stored about 60lb. surplus. Should the weather improve now there is plenty of white clover in the fields, from which honey may be gathered.—B. W. G., Gloucester.

REPLY.—It will be best to work for surplus instead of dividing the stocks. There is plenty of white clover still in bloom, and with warm weather you will get more honey.

[8164] *Bees Visiting Mineral-Water Factory*.—I should be pleased to receive any information you can give me with respect to the following: I am a bee-keeper, and was troubled last year after taking the supers off with the bees going to a mineral water works close at hand, and taking possession of the syrup room. As the owner of the works was a near friend, I did all that was possible to check this, viz., smoking them and burning carbolic in the syrup-room. This did check them for a time, but the next day there were just as many. Since then the mineral works has changed hands, and to be on the safe side, I should like to know, if they go again, who will be responsible. I must point out to you that there is every chance for the bees to get at the syrup, the windows in the room being broken; in fact, the place is in a very bad condition. Legally, should the owner of this place put it in such a condition that the bees cannot get at the syrup when filtering? The filters are in square frames, and it would be very little expense to put gauze round them, which would exclude both bees and wasps.—M. J. W.

REPLY.—We know of no law to compel the owner of the factory to put it into such a condition as to prevent bees from getting access to the syrup, but we should think that it must be obvious to him that

it would be to his advantage to put wire-gauze screens to the windows and doors, or in the way you suggest, to prevent not only bees, but wasps and flies from getting at the syrup. This is usually done in jam factories, and should also be done in such a case as you mention. Although your bees must not be a nuisance to anyone, in your case you could show contributory negligence on the part of your neighbour, who had enticed the bees on to his premises.

[8165] *Dealing with Swarmed Stocks.*—I bought two small stocks of bees in October last. I put a super in hive No. 1 on May 13th, and one in No. 2 on May 20th, and as there were signs of swarming, I put a second super in hive No. 1 on May 30th. Both hives, however, sent off a swarm, which were successfully hived. Later, hive No. 2 sent off a cast, which was hived in another hive. Both the first swarms were large, and cover eight and seven frames respectively. The cast covers four frames. There is, of course, very little surplus honey being gathered, as the stocks have been thus attenuated. I would like to know how I can ascertain if there is a fertilised queen in each of hives 1, 2, and 5. Can I remove the supers without detriment to the bees? I have been feeding the cast as the weather has been unpropitious for foraging. Ought I to reduce the stocks to three or four for the winter? If so, which colonies should be united, and which queens destroyed? I have no means of knowing the exact age of the original queens, but they have evidently both been prolific this year. I have not thought it necessary to feed the swarms; ought I to have done so?—W. H. C., Cookham Dene.

REPLY.—You must use your judgment and unite the weakest colonies, destroying the queens, which came out with the swarms, as these will be the oldest. The cast will have a young queen. If the colonies have about eight frames of bees it will not be necessary to unite, as they will stand the winter alone. It is always best to feed swarms for at least a week after hiving. You can ascertain if the queens are fertile by removing the supers and searching for eggs. Their removal will not harm the bees.

[8166] *Drone Brood in Super.*—I shall be glad if you will give me advice on the following:—In one of my hives I did not put on the queen-excluder, as the bees were disinclined to go into the supers, but as soon as they had started work I put it on. Unfortunately, the queen was in the super, and I have only just discovered this: of four supers, two have a large amount of brood. I have now secured the queen, and placed her in the brood-

chamber. One of the supers has drone base foundation, and every cell has a drone larva in it. The queen-excluder will naturally prevent the drones going down into the brood-chamber, so they will naturally be imprisoned above. I do not wish to destroy the combs, as I am short of drawn-out comb, and I suppose I can hardly destroy the larvæ without doing some harm to the comb. If I put them below the queen-excluder I am afraid the queen will again use the comb for laying, especially as the brood-chamber has probably very little room by this time for brood. I have not looked into it, but I gather this from the fact that the queen has been in the supers for more than six weeks.—H. S. C., N. Devon.

REPLY.—The best plan would be to melt the combs down, and give fresh sheets of foundation for the bees to draw-out. Failing this, your only remedy is to let the drones hatch out. You can liberate them from the super by lifting off the quilt occasionally, and thus giving them an opportunity to escape, or when all have emerged you could clear out the workers by using a Porter bee-escape. Any drones left could then be shaken off the combs.

[8167] *Storing Extracted Honey, and other Queries.*—Will you kindly answer the following questions in the BRITISH BEE JOURNAL:—(1) What is the best receptacle to keep extracted honey in till one can sell it, and where should it be kept? Can it remain in the ripener? (2) How many standard frames of honey should one leave the bees for the winter? I think there is a good deal of honey stored in the brood chambers of my hives. (3) How can one keep shallow frame-combs, from which honey has been extracted, for use next year? Will they be all right in the supers wrapped in newspapers and stored in a dry place? (4) When given to the bees to clean after extracting, how long must they remain in the hive? (5) One of my colonies sent out a swarm on Whit Monday. I did not see it issue, but concluded it came from a hive which was supered with a rack of sections. These bees have done nothing since, the parent colony I mean, not the swarm; they refused to work in the sections, which had starters in them, so I put on a super of shallow frames, with full sheets of foundation, and one frame nearly full of honey from another hive, but all to no purpose. What can be the reason? Two colonies close by have been working well.—"RADNORIAN," Presteigne.

REPLY. (1) Honey can remain in the ripener, or you could keep it in 2SB, lever-top tins. It should be kept in a dry, cool place. (2) Eight well-filled frames would be sufficient for their needs. (3) Get the extracted combs cleaned up by the



bees first, then wrap them up as suggested, and place a couple of balls of naphthaline in each parcel. (4) Until they are quite free from all stickiness. (5) It is unusual for a colony to give surplus after swarming.

[8168] *Swarm Building Combs in Hive-Roof*—I shall be glad if you have room to answer the following in the queries and replies column of "B.B.J." I have had an empty hive standing in my apiary as a decoy for swarms. I was away from the apiary from July 9th to 12th, and on going there on the latter date, I saw bees going in and out of the "decoy" hive. On removing the roof I found a large swarm. Most of the bees were in the roof where they had built some combs, these containing honey and eggs. In the brood-chamber I had left four frames of drawn out foundation: there were some bees on these, not many. I suppose that not finding room enough on the frames, the bees had gone up into the roof, nearly all of them being clustered there. I filled up the brood-chamber with frames of drawn out foundation. It seemed a pity to destroy the combs in the roof, so I intend leaving them, catching the queen and putting her down into the brood chamber with an excluder on top. I shall be very glad to know if this is the proper treatment of the case.—M. G. F., Hawkhurst.

REPLY.—Yes, you have done right, but before pulling the queen below you must wait until the combs in brood-chamber are built out, or you could give the bees drawn-out combs from other hives.

[8169] *A Bundle of Queries*.—Replies to questions as below would be greatly appreciated. (1) Would shavings from a planing machine, sprinkled with a few drops of Sanitas disinfectant, be detrimental to bees if used in packing up for the winter? (2) Is boiled linseed oil as good as vaseline to put on frame-ends, and bottom and top of racks? (3) If hybrids were hatched out in a hive of blacks, would it induce fighting? (4) Would drawn-out combs and foundation after being soiled by bees with dysentery last summer be injurious if used this season? (5) Is the specimen of heather I enclose of the variety that produces the best honey? (6) I should like to know of what strain my bees are. They have been in the family over 60 years, good workers and breeders. Would you kindly let me know if bees ought to be sent dead or alive for your examination and what would be your fee? It is only during the last two years that I became really interested in bees, after purchasing a copy of the Guide Book at Cardiff Flower Show. I have also been a regular reader of the "B.B.J." since. Long may it live!—SEEKER, Morthyr Tydvil.

REPLY. (1) Not in the slightest. (2) No. (3) It is not likely to do so. (4) It is not advisable to use the soiled combs, and they are best melted down for wax. (5) Destroyed in the post, so cannot say. (6) No fee is charged for examining bees. A few dead ones will suffice to tell what variety they belong to. Thanks for your good wishes.

### WEATHER REPORT.

BARNWOOD, GLOUCESTER.

June, 1911.

Rainfall, 2.07 in.	Mean temperature
Below average, .16 in.	for month, 58.9; 11.
Heaviest fall, .47 in.	below average.
on 24th.	Relative humidity,
Total to date, 8.29 in.,	or percentage of
as compared with	moisture in the air
12.89 in. for the cor-	at 9 a.m., 64.
responding period	Number of days with
of last year.	sky completely
Mean maximum tem-	overcast at 9 a.m.
perature, 68.4; .6	4; do. cloudless,
of a degree below	7.
average.	Percentage of cloud
Mean minimum tem-	43.
perature, 49.5; 1.5	Percentage of wind
below average.	force, 21.
Warmest day, 8th,	Prevailing direction,
80.5.	N.E. & S.W.
Coldest night, 13th,	
33.2.	

F. H. Fowler (F. R. Met. Soc.).

### WEATHER REPORT

WESTBOURNE, SUSSEX.

June, 1911.

Rainfall, 1.99 in.	Minimum tempera-
Below average, .14 in.	ture, 37° on 11th.
Heaviest fall, .59 in.,	Minimum on grass,
16th.	32° on 11th.
Rain fell on 10 days.	Frosty nights 0.
Sunshine, 259.9	Mean Maximum 66.5,
hours.	Mean Minimum 50.2.
Above average, 26.1	Mean temperature,
hours.	58.3.
Brightest day, 8th,	Above average, 1.1.
15.3 hours.	Maximum barometer.
Sunless days, 2.	30.438 on 7th.
Minimum tempera-	Minimum barometer,
ture, 79° on 6th.	29.597 on 24th.
	L. B. BIRKETT.

## Bee Shows to Come.

July 20, at Southwell.—Annual Show of the Notts B.K.A., in connection with the Horticultural Society's Show. Open class for Single 1-lb. Jar. First prize, 20s. Schedules from Geo. Hayes, Mona Street, Beeston, Notts.

July 25, at Kidwelly, S. Wales (Agricultural and Horticultural Show). Open Class for Honey.

1lb. glass jar of present season honey, 1st prize, 10s.; 2nd, 5s.; 3rd, 2s. 6d. Entrance free. Honey to become the property of the Committee. Sec., J. Morgan, Kidwelly. **Entries close July 22.**

**July 26, at Nether Wallop.**—Annual Honey Show of the Wallop Horticultural Society. Open Classes for Honey. Best 1lb. jar extracted, best 1lb. section. Entry free. **Entries closed.**

**July 25, 26, 27, at Gloucester.** Annual Show of the Gloucestershire B.K.A., in connection with the County Agricultural Show. Separate tent for Honey, Wax, and Appliances. Open classes. Special prizes. **Entries closed.**

**July 25 to 29, at St. Albans.**—Honey Show of the St. Albans and District Bee-keepers' Association. Three Open Classes. Schedules, &c., of Mr. E. Watson, Holywell Hill, St. Albans.

**July 26 and 27, at Cardiff.**—Annual Show of the Glamorgan B.K.A. in connection with the Cardiff and County Horticultural Show. Separate tent for honey, wax, and appliances. Open classes. Special prizes. Schedules from Hon. Sec. Mr. Wiltshire, Maindy School, Cardiff. **Entries close July 20.**

**July 27, 28, and 29, at Rotherham.**—Show of Hives, Honey, &c., in connection with the Royal Yorkshire Agricultural Society. **Entries closed.**

**August 2, at Stoke Park, Guildford.** Annual Exhibition of Bees, Wax, Appliances, &c., will be held by the Surrey B.K.A., in connection with the Guildford and West Surrey Agricultural Association. Nineteen classes (five open to all). Many medals. Schedules from F. B. White, Hon. Secretary, Marden House, Redhill, Surrey. **Entries close July 22.**

**August 3 to 7, at Bury, Lancs.** Honey Show in connection with the Royal Lancashire Agricultural Society's Exhibition. **Entries closed.**

**August 3, at Weston-super-Mare.**—Annual Show of the Somerset B.K.A., in connection with the important Local Annual Flower Show. Classes for Appliances, Honey, Wax, and Bee Products. Several open and free classes. Liberal prizes. "Small-holder" clock for second highest number of points. Numerous attractions. Excursions from all parts. For Schedule, &c., apply to T. Jones, Assistant Show Secretary, North View, Milton-road, Weston-super-Mare. **Entries close July 29.**

**August 7 (Bank Holiday), at Cambridge.** Honey Show in connection with the Cambridge Mammoth Show Society. All Open Classes, four Special Hives to be competed for. This Show also includes dogs, poultry, pigeons, rabbits, cage birds, flowers, fruit, and vegetables; also grand programme of sports and motor racing, &c. Balloon ascent and parachute descent by Captain Spencer. The champion prize band (Irwell Springs) has been specially engaged. Schedules from Hon. Sec., E. F. Dant, Member of B.B.K.A., 52 Bridge Street, Cambridge. **Entries close Thursday, August 3.**

**August 7, at Epworth.** In connection with the Epworth Agricultural Show of Horses, Beasts, Pigs, Poultry, Pigeons, Rabbits, Cage-Birds, Honey, Dairy Produce, &c. Lincs. B.K.A. in charge of Honey Section. Schedules from W. E. Burrows, Secretary, Epworth, Doncaster.

**August 7, at Melton Constable.** The Annual Honey Show of the North Norfolk B.K.A. will be held at Melton Constable Park on above date. Several Open Classes. Schedules from Secretary, North Norfolk B.K.A., The Pightly, Letheringsett, Holt, Norfolk.

**August 9, at Wye, Kent.**—Kent Honey Show. Four Open Classes. Fourteen open to Kent. Trophy Cup value 5 guineas. Open to Kent, Surrey, and Sussex. Two Challenge Cups value 6 guineas each. Many other special and money prizes. Special classes for Cottagers, also class for members of Ashford and District Bee-keepers' Association. Schedules ready early in July, from H. C. Chapelow, Hon. Sec., Wye, Kent. **Entries close August 2nd.**

**August 10, at Madresfield, Malvern.** Annual Show of the Worcestershire B.K.A. Open Class for collection of Bee Products. Prizes, 20s., 10s. Schedules from George Richings, 2, Shrubbery Terrace, Worcester. **Entries close August 5.**

**August 16, at Lancaster.** Lancaster Agricultural Society, in conjunction with the Lancashire B.K.A. 16 Classes for Honey, Bee Produce, and

Bee Hives. Numerous specials, including 2 silver challenge cups, 12 silver and bronze medals. Write for Honey Schedule to Robert Gardner, 13, Sun St., Lancaster. **Entries close August 2.**

**August 17, at Kenilworth Castle.** Show of Kenilworth Horticultural Society. Open Honey Classes. Prizes, 10s., 5s., 2s. 6d. Judge, Mr. G. Franklin. Very popular, and an old established exhibition. Schedules from E. H. Thornett, Secretary, Kenilworth.

**August 17, at Abington Park, Northampton.** Northants B.K.A. Annual Honey Show. Special Prizes for Open Classes, including one for single 1lb. jar of Honey. Entry free. Judge, Mr. W. Herrod. Prizes, 20s., 10s., 5s., 2s. 6d., and 1s. 6d. Schedules from R. Hefford, Kingsthorpe, Northants. **Entries close August 12.**

**August 23, at Radstock, Somerset.**—Honey Show in connection with the Radstock Horticultural and Farmers' Association. Open and gift classes. Write for Honey Schedule. B. M. Clark, Foxhills, Radstock.

**August 23 and 24, at Shrewsbury.** Annual Show of the Shropshire Bee-keepers' Association, in connection with the Shropshire Horticultural Society's Great Floral Fête. Eight Open Classes for Honey. Free entry for single bottle and single section. Schedules from S. Cartwright, Hon. Sec., Shawbury, Shrewsbury. **Entries close August 11.**

**August 30, at Chester.** Annual Show of the Cheshire B.K.A. in connection with the County Agricultural Show. Several Open Classes. Good prizes. Schedules, &c., from Hon. Sec., E. W. Franklin, Mouldsworth, near Chester.

**August 30 and 31, at Coventry.**—Annual Show of the Warwickshire B.K.A., in connection with the Warwickshire Agricultural Society. Separate tent for Honey, Wax, and Appliances. Open Classes. Schedules, &c., from J. N. Bower, Knowle, Warwickshire.

**September 6, at Deddington, Oxon.** Show of the Deddington Horticultural Society. Open Class for Honey. Prizes, 10s., 5s., 3s., 2s. No entry fee. Schedules from Messrs. H. J. Harmsworth or A. A. Busby, Deddington. **Entries close September 1.**

**September 7, at Peterborough.** In connection with Horticultural Society, County Association Class and four Open Classes. Schedules from G. T. Dunham, Albion Terrace, 32, Oundle Road, Peterborough. **Entries close September 1.**

**September 13 and 14, at Cambridge.** Honey Show in connection with the Cambridge and District Red Cross Horticultural Society. Four Classes, open to all. To be held in the Corn Exchange, Cambridge. Schedules and particulars of Hon. Sec., E. F. Dant, Member of B.B.K.A., 52, Bridge Street, Cambridge. **Entries close Saturday, September 9.**

**September 13, at Conway, N. Wales.** Great Annual Honey Show in connection with the Conway Honey Fair. Open and local Classes. Schedules from J. Hughes, Town Hall, Conway. **Entries close September 6th.**

**September 27, at Altrincham.**—Honey Show, in connection with the Altrincham Agricultural Show, the largest one-day show in the Kingdom. Classes open to United Kingdom. Classes for Trophy of Honey, for Best Hive, Observatory Hive with Bees and Queen, twelve Jars of Extracted Honey. Classes open to County of Chester, for Run and Section Honey, Wax, &c. Special Classes for Cottagers, and Special Classes for Society's District. Several Special Jubilee prizes. Schedules from Mr. J. Herbert Hall, 2, Dunham Road, Altrincham. **Entries close September 9, and at extra fees September 13.**

## Notices to Correspondents.

H. C. (Old Charlton).—*Advice in Bee-Keeping.*—Write to H. Brice, Otford, Kent.

E. G. (Leeds).—*Artificial Increase*.—(1)

It would be best to make an artificial swarm as described on page ninety-three of "Guide Book." It would not do to divide even a very strong stock into three as you suggest, as it is too late in the year for this. (2) Should you decide to increase in this way, you had better purchase a good queen for each lot, and not trust to queen-cells.

EDINBURGH (Stirling).—*Sections from Diseased Hive*. The drawn-out sections should not be used for healthy bees; they are not worth troubling about. You had best destroy them and disinfect the rack.

HOPEFUL (Worcester).—*Preventing Foul Brood*.—Renew the Formaldehyde at intervals of about a fortnight. Naphthaline should also be used in the hive.

W. H. W. (Harlington).—*Exhibiting Honey*. You made a serious charge against the honesty of our judges, and although we challenged you to prove your accusations you adduce nothing to show that "with the connivance of the judges," the faker had "reduced showing to a farce." "Although conversant with all the tricks of the faker," you are not able to bring forward a single proof, and fall back on finding fault with some clover honey which you saw at some show, and you say it "was so dense that it would hardly leave the bottle when inverted. Any duffer knows it was not taken from the hive in that condition. It was not honey, it was the product of the faker. It was a fraudulent exhibit from my point of view." It is evident that you are misapplying the word "fake," which means "to tamper with, for the purpose of deception," but there is no deception in well ripened honey, and this is exactly where the skill of the bee-keeper comes in, and not the faker. Well ripened honey is not "fraudulent exhibit," and the ripening is not done for deception, therefore we cannot look at it from your point of view. We certainly should not disqualify honey for its consistency, if it were good in other respects. We have, however, passed over such dense samples if they were deficient in flavour. In judging, flavour always has the highest number of points, consistency and colour coming next. It is for this reason that it is recommended to ripen honey or allow it to remain on the hive to acquire density. We have taken honey off our hives so dense that it has been hardly possible to extract it, but this could not be called faked honey. Secretaries at shows are usually pleased to show exhibits in which anyone is interested, but it certainly would not conduce to order if everyone were

allowed to handle exhibits indiscriminately.

EXCITER (Basingstoke).—*Points in Judging*. (1) Sections: Colour, 8; finish, 8; uniformity, 8; weight, 3; get up, 3; total, 30. (2) Extracted: Flavour, 8; colour, 6; consistency, 6; uniformity, 3; condition, 3; aroma, 2; get up, 2; total, 30. (3) Beeswax: Colour, 6; purity or rendering, 3; cleanness in moulding, 3; texture, 2; plasticity, 2; aroma, 2; uniformity, 2; total, 21. (4) The chief characteristics of good beeswax are that it breaks with a fine-grained, clear conchoidal fracture, has more or less aroma, is plastic, tenacious, and can be kneaded without its sticking to the fingers. Placed in the mouth it is nearly tasteless, and when chewed does not adhere to the teeth. The colour varies, and extremes should be avoided, preference being given to that of a pale clear yellow, lemon or primrose colour. Bleached wax loses its aroma. The most likely faults are spoiling in rendering by overheating or melting without water, lack of aroma, insufficient cleaning, leaving grit and dirt in the wax, and sometimes adulteration. You would find "Waxcraft" useful for your purpose.

#### *Honey Samples.*

A. B. The honey is from limes. Lime honey is not considered so good as that from white clover, as the flavour is not so delicate.

G. M. (Playford).—The honey is a good sample from white clover. If it is ripe, *i.e.*, sealed over, you can remove it from the hives at any time. It certainly will not "break the heart of the bees," but will keep them busy instead of loafing.

T. S. (Stockbridge).—Both samples are very good, but No. 2 is slightly better than No. 1, which though thick and of a good colour is somewhat flavourless. From white clover.

R. S. W. (Ware). A very good honey mainly from clover, too light for any but light-honey class. It is quite good enough for show purposes, and should fetch the market price of a first class honey.

A. B. C. (Llandudno).—An excellent honey from sainfoin, too light for any but light-honey class. You should get about 11d. or 1s. per lb. retail; about 8s. 6d. per dozen bottles, wholesale; if sold in bulk 7d to 8d. per lb.

G. S. (Foots Cray).—A good sample of honey mainly from sainfoin. Its only imperfections are a lack of density and the presence of particles of wax, which must be strained out before it is in proper condition for sale or the show-bench.

*Suspected Combs.*

J. H. H. (Rochester).—It is a case of sour brood.

J. B. R. (Haydon Bridge).—The comb shows odourless foul brood; the outbreaks has occurred this year.

J. R. J. (Moffat).—There is no disease in the comb, but it is all drone-brood. Evidently you used starters in the frames, instead of full sheets of worker-base foundation, which ought to have been used.

**Special Prepaid Advertisements**

**Two Words One Penny, minimum Sixpence.**

*Orders for three or more consecutive insertions entitle advertisers to one insertion in "The Beekeepers' Record" free of charge.*

*Trade advertisements of Bees, Honey, Queens, and Bee goods are not admissible at above rate, but will be inserted at 1d. per word as "Business" Announcements, immediately under the Private Advertisements. Advertisements of Hive-manufacturers can only be inserted at a minimum charge of 3s. per ½ in., or 5s. per inch.*

**PRIVATE ADVERTISEMENTS.**

**L**ADY'S BICYCLE, free wheel, back pedalling brake; exchange light honey in bulk. Owners. "CYCLIST," "B.B.J." Office, 25, Bedford-street, Strand, W.C. k 86

**E**XCHANGE new Hives for Bees; Bee-driving required for Bees. WILLET, New Malden, Surrey. k 87

**F**OR SALE, owing to removal.—Guaranteed healthy, 1 Hive with lift; 2 W.B.C. section racks with frames; 2 queen excluders, new; rack of sections and dividers; 120 grooved and split sections, dozen shallow, dozen brood frames; 100 metal ends; 1lb. Brit. Weed (super foundation); few sheets shallow frame; porter escape; unused skep; super clearer; bottle feeder; 3-section racks, &c., the lot, 30s.; also 2 hives bees, 19.0 queens, 4s. each; racks newly drawn out, shallow frames, 4s.; few back unbound volumes of "B.B.J." and "Record," 1s. each.—BORDESSA, Helsoy, via Warrington. k 86

**E**XTRACTOR, never used, will exchange honey press; several new hives for sale.—APIARY, Scalby, Scarborough. k 85

**H**EALTHY DRIVEN BEES, with queen, commencing August 1st, 4s. 6d. per lot; boxes to be returned; orders rotation; cash with order.—T. PULLEN Ramsbury, Hungerford. k 83

**F**INEST LIGHT HONEY in 28lb. tins, 8d. lb. WAIN, Thorpe Bank, Wainfleet. k 82

**34**TH CONSECUTIVE YEAR advertiser in "B.B.J."—ENOCH WOODHAM, Clavering, Newport, Essex, has Swarms, Nuclei and imported Italian Queens, 6s. each; also home-raised Rhode Island Red fowls and Aylesbury ducks of best blood.—Particulars on application. k 81

**G**UARANTEED healthy secondhand Hives, fitted with frames, drawn out combs, cheap.—BARBER, expert, Mere Farm Apiary, Chedford. k 80

**F**EW 6-frame lots of Bees for sale, 17s., wired; swarms, 12s., from healthy stock, cash with order.—F. SOFTLY, Thriplow, Cambs. k 78

**B**EES FOR SALE, 10 strong stocks, in bar frame hives, and 2 in skeps, all with supers in; also extra shallow frame boxes with comb.—PENNINGTON, Croft Cottage, Moberley, Cheshire. k 79

**Special Prepaid Advertisements.—Continued**

**W**ANTED, Cowan's extractor, reversible, perfect condition.—W. I. JOLLY, Toller-lane, Bradford. k 77

**B**EST SCOTCH SECTIONS, 10s. 6d. per dozen.—C. GAKFITT, Comar Angus, Perthshire. k 76

**A** FEW DOZEN specially fine snow-white Sections for sale, fit for the keenest "Display" competition, neatly glazed, at 12s. dozen.—SOAL, Rochford. k 75

**1911** QUEENS, black, 3s. 6d. each, guaranteed safe delivery.—L. NORTON, Fernlyffe, Cleeve Hill.

**F**LOWER HONEY in Sections or Extracted in Bulk. What offers?—WILLIAM WILSON, 25, Forfar-road, Kirriemuir. k 72

**W**ANTED, good lot of Driven Bees or Swarm, at once.—TILLING, 12, Green-road, Southsea. k 71

**W**ANTED, Extractor, must be cheap.—Particulars to S. G. P., 69, Yerbury-road, London, N. k 70

**P**ROLIFIC CARNIOLANS, 3-frame Nucleus, 1911 Queens, 12s. 6d.—FROST, Hartshill-road, Stoke-on-Trent. k 69

**S**ECTIONS wanted for cash, send price, any quantity.—F. W. WEIZEL, 45, Kempe Road, Kensal Rise, N.W. k 76

**F**OR SALE, 1 frame hive, 3 section racks, 1 excluder, 4 feeders, 1 super clearer; all in sound condition, 18s.; free on rail.—F. C., 2 Bellevue-road, Southbourne, Hants. k 59

**B**EES.—A few guaranteed healthy Stocks in W.B.C. hives, for disposal, all in perfect condition, a really first-class lot.—Appy, S., care of "B.B.J." Office, 25, Bedford-street, Strand, k 69

**BUSINESS ADVERTISEMENTS.**

**1911** CARNIOLAN QUEENS, mated in Carniola, Austria, 4s.; Swiss, 5s.; Italians, 3s.; delivery in one week.—F. VOGT, 32, Selwyn Avenue, Higham's Park, Essex.

**S**PRING BEE ESCAPES, 4d. each; Super Clearer Beards, with above fitted, 1s. 6d. each, carriage paid.—H. CRESSY, Friary Mill Apiary, Dorchester. k 74

**1911** QUEENS, 3s. 9d.; Virgins, 1s. 6d.; safe arrival guaranteed.—TOLLINGTON, Woodbine Apiary, Hathern. k 84

**H**EALTHY DRIVEN BEES, 6s. lot, August delivery, orders rotation.—BRADFORD, expert, Worcester. k 78

**B**RITTANY Fresh Butter, Eggs, Poultry, Potatoes, Fruit, Mistletoe, Cider, Honey and Wax forwarded at best terms. Established 1827.—LIMEUL, General Merchant, bee-keeper, Dol de Bretagne, France. k 84

**G**ILLIES' Shilling Control Outfit, refuse substitutes.—Wholesale, TREKLING CORPORATION, Dublin. k 85

**P**ROLIFIC HYBRID QUEENS, 15 years' experience, fertiles 4s., virgins 2s.—MOORE, 10 The Avenue, Bedford. k 60

**I**TALIAN QUEENS direct from Italy.—See complete advertisement in "B.B.J." May 18th. Special offers are countermanded till further advice.—Address, E. PENNA, Bologna, Italy.

**1911** QUEENS.—Golden Italian fertile Queens, guaranteed healthy, pure-mated, vigorous, prolific, 4s. each; specially selected, 7s. 6d. each; prompt delivery.—J. B. GOODARE, Woden Apiary, Wednesfield, Wolverhampton. k 54

## Editorial, Notices, &c.

### BRITISH BEE-KEEPERS' ASSOCIATION

The monthly meeting of the Council was held on Thursday, July 20th, 1911, at 23, Bedford Street, Strand, London, W.C., when Mr. W. F. Reid presided. There were also present Miss K. M. Hall, Messrs. T. Bevan, C. L. M. Eales, O. R. Frankenstein, J. Smallwood, J. B. Lamb, E. Watson, G. W. Judge and J. E. Smiles (Crayford), T. W. White and G. R. Alder (Essex), A. Wilmott (Hertford and District), and W. Herrod (Secretary).

Letters expressing regret at inability to attend were read from Miss Gayton, Messrs. T. W. Cowan, E. Walker, A. G. Pugh, R. T. Andrews, J. P. Phillips and General Sir Stanley Edwardes.

The Minutes of Council meeting held June 15th were read and confirmed.

The Spey Valley Bee-keepers' Association and the Hitchin and District Bee-keepers' Association applied for affiliation, and both were accepted.

The following new members were elected: Mr. A. H. E. Wood, Browhead, Windermere (Life member); Miss H. Bessir Sampson, The Cedars, Tibshelf, Derbyshire; Mr. C. H. Rivers, Mount House, Downs Road, Southfleet; Mr. C. R. Forse, Trentham, Stoke-on-Trent; Mr. J. H. Stephens, 35, West Street, Northsham; Messrs. Goodburn Bros., Rock Road, Millfield, Peterborough; Mr. P. G. Russell, Bearton Avenue, Hitchin; Mr. W. J. Cornall, Minster, near Ramsgate; Colonel G. E. Beale-Browne, Dowdeswell House, Andoverford, Gloucestershire; Mr. W. E. Batt, Mount Pleasant, Chifton, Manchester; Mr. J. Allbon, The Willows, Hitchin; and Mr. H. Cressy, North Square, Dorchester.

The following names of delegates were submitted and approved: Miss H. F. Leaver and Mr. Basil Cozens Hardy, (Norfolk), Rev. H. Morgan and Mr. G. Kirkhouse Jenkins (Glamorgan), and Dr. Sellas (Aberdeen).

The Report of the Finance Committee was presented by Mr. J. Smallwood. The balance in hand at the end of June was £179 14s., and it was resolved that payments amounting to £52 10s. 9d. be made.

The judges' report on the Royal Show was presented by Mr. C. L. M. Eales, who stated that taken altogether the honey department was better supported than ever before in the history of the Association and it necessitated the enlargement of the accommodation by fifty feet. The exhibits were not only numerous but excellent in quality.

Reports on third class examinations held at Brigg, Carlisle, Aberdeen, Wit-

watersrand, South Africa, and Norwich, were submitted, and it was resolved to grant certificates to the following: Miss S. A. Gibson, Messrs. J. Baldry, C. H. Marshall, W. J. Brooke, J. W. Priestman, R. Bain, J. Beverley, J. Brown, P. Catto, J. Hall, W. Kennedy, A. Low, L. W. Hardwicke, A. F. Hind, W. C. Mitchell, G. S. Oettle, M. Paatz, H. E. H. Schwultz, G. Bryden, C. H. Rivers, J. C. Dalzell, J. E. Lockwood, C. Bocoč, H. Gonde, O. C. Jones, W. G. Goddard, J. E. Smith, W. Nicholson, and G. H. Barnes.

Rev. G. H. Pratt presented himself, and passed the lecture test for the first class certificate.

The Chairman read a letter from the Treasury, dater 26th June, 1911, stating that the Lords Commissioners of His Majesty's Treasury had received a recommendation from the Development Commissioners that a grant of a sum not exceeding £850 be made to the British Bee-keepers' Association under Part I. of the Development and Road Improvement Funds Act, 1909, to be expended as follows: (a) A sum of £350 for an experimental apiary in some central situation, to be fitted with all modern appliances, and to be used for demonstration purposes, and in connection with the training and examination of lecturers; and (b) A sum equal to the income of the Association for the present year, but in no case to exceed £500, for general organisation, including the training and examination of lecturers; the promotion of County Associations; and the organisation of pioneer lectures and demonstrations, the lectures to be of an elementary and introductory type designed to interest country audiences in the business of bee-keeping. The letter further stated that the Lords Commissioners were ready to accept these recommendations, and to make a grant, as proposed, and they wished to be informed whether the British Bee-keepers' Association were prepared to agree to the conditions suggested.

The Council having deliberated on the matter, it was moved by Mr. J. B. Lamb, seconded by Mr. C. L. M. Eales, and resolved unanimously: That the Council of the British Bee-keepers' Association accept with their cordial thanks the offer of £850 from the Lords Commissioners of His Majesty's Treasury, which has been made on the recommendation of the Development Commissioners, and agree to the terms contained in the letter from the Hon. Sir G. H. Murray, G.C.B., dated 26th June, 1911.

On the motion of Mr. Watson, it was resolved unanimously: That Messrs. W. F. Reid, C. L. M. Eales, J. B. Lamb, E. Gareke and the Secretary be appointed a committee to make immediate inquiries with the view of obtaining a site for a

experimental apiary, and to prepare a scheme for the expenditure of the sum voted by the Treasury on the recommendation of the Development Commissioners, the report of this committee to be laid before the Council in due course.

The draft form for the nomination of delegates by affiliated associations was presented and passed for printing.

Rev. G. H. Pratt, delegate from the Shropshire Association, was introduced by the Chairman, and welcomed by the Council.

Examinations and examiners for third class certificates were sanctioned at Gloucester, Craigellachie, Northampton, Lancaster, Worcester, Bridgwater, and Melton Constable.

Judges were approved for Gloucester, Melton Constable, Shrewsbury, Madresfield, and Northampton.

The resignation of the Cambridge and District Association from affiliation was received and accepted.

A letter was read from the Gloucestershire Association enclosing a donation of one guinea towards a fund for prosecuting research in the "Isle of Wight" disease. The Council appreciated most deeply the good feeling which prompted the generous act on the part of this Association. As at present the Government are doing all in their power to find out the cause through their own bacteriologists, they could not see how the money could be expended. The Secretary was therefore instructed to return the money with the Council's heartiest thanks.

Next Meeting of Council will be held on September 21st.

---

#### REVIEWS OF FOREIGN BEE JOURNALS.

By "Nemo."

*The Care of Extracted Honey.*—M. J. L. Levieux gives some practical advice in the *Rucher Belge* on the care of extracted honey. He says when it is liquid and warm it passes through the strainer very rapidly, but when it becomes cold and thick it is much more difficult to strain, and sometimes even impossible. He has had honey that would even granulate rather than go through the strainer. Supposing that the honey is in the right condition for straining easily, it leaves in the strainer the greater part of the wax particles which accompanied it during extraction. This strained honey may appear purified, but it is not sufficiently so. Let it stand in a warm room for a few days and gradually the surface will become covered with a scum, white as flour. This must be removed together with the minute particles of wax and pollen still remaining in suspension in the liquid

honey. The scum is produced by the air which adheres to the minute drops of honey driven out by the centrifugal force, and which, in course of time, rise to the surface, with the fine particles of wax and pollen which had passed through the strainer. When the scum is removed the vessel should be covered with the strainer and left for a few days to be skimmed again, and the honey can finally be put into receptacles when no more scum is observed. M. Levieux also says that the cans containing extracted honey should be kept in a dry place, where it is possible to have a current of air, in order to allow the excess of water in the honey to evaporate. Liquid honey may contain as much as 45 per cent. of water. In this form it is nectar, gathered and converted by the bees, which by ventilation has already lost a certain percentage of the water. When honey is extracted from the combs after these have been sealed, there still remains about 33 per cent. of water. Under such conditions the honey does not granulate. This is why it is advisable to assist the evaporation by stirring the honey contained in large vessels with a clean stick. When, by evaporation, the water has been reduced to 20 per cent., the honey granulates and retains this water permanently. Some bee-keepers put their honey at once into jars after extraction, but this is only advisable if the honey is just in the right condition when extracted, a point not always possible to judge, so that it is advisable to ripen the honey as recommended.

*Safe Capping for Honey Jars.*—Beeswax and resin, melted together, we are told in the *Badische Biene*, are the best for preventing leakage in honey jars. Parchment paper (not of the thickest) is laid on the mouth of the jar, and the cover pressed on it, and with a sharp pointed knife the circle is cut out. The molten mixture is then laid on the edge with a small brush, and the parchment pressed on it. The cover can then be screwed on, and the bee-keeper will have the satisfaction of knowing that there will be no leakage of honey.

---

#### HELPFUL HINTS FOR NOVICES.

By W. Herrod.

*Preventing Casts.*—With the passing of the skep the idea of obtaining as much increase by natural methods as possible is being eliminated from the mind of even the most conservative of bee-keepers. The draining of the population of the colony by numerous casts very often means total extinction of the parent stock. Not only so, but if carried to excess it means that the casts are so weak in numbers that

eventually they perish before their owner obtains any return for the trouble expended upon them. If increase by natural methods is desired, then the first swarm only should be allowed to issue. This should be hived in the new hive which is placed on the stand occupied by the colony from which it issued. In this way all the old flying bees are obtained from the parent colony, as bees locate the position and not the hive; when they leave the old home the next morning to forage, they return, not to the original home, which is now standing in a fresh position, but to the old location. This prevents all possible chance of a cast or second swarm issuing. Have no fear for the parent colony, as it will be entirely populated by young bees not more than a fortnight old, for they do not fly until they are that age. When these young bees do leave the hive for their first flight, they return to the same position, for they have known no other. Further, the continual emerging of the brood which was sealed over at the time the swarm issued will bring up the numbers, so they will have ample opportunity of working up strong enough for wintering after the young queen has been fertilised and commenced her maternal duties. The entrance to the old home will show no signs of life for a few days after the change of position. This does not point to anything being wrong, but is accounted for, as stated above, by the fact that for several days there will not be bees old enough to fly. By following this method not only is increase secured, but very often surplus as well. I know of one novice who has obtained this year 90lb. of honey from a swarm by adopting this method. Another danger which often arises is that casts are lost owing to the agility and restlessness of the virgin queen. Casts usually issue about nine days after the first swarm, and if the queen is heard piping it is almost a sure indication that a cast will issue. If, through neglect on the part of the bee-keeper or by an oversight, casts come out, they should be returned to the hive, or at any rate two or three should be united. This year those colonies which have swarmed will require attention, owing to the superabundance of nectar. I find in many cases the combs in the brood-chamber are choked with honey; this will prevent the young queen from laying when fertilised, therefore the extractor should be brought into use, and two or three of the combs extracted and put back in the hive on the same evening. From this cause swarmed stocks are sometimes suspected of being queenless, but the provision of room by extracting quickly proves this to be wrong. The cause of casts issuing is but imperfectly understood by many bee-keepers. When we consider

that swarming usually takes place between the hours of ten and one—also very often prematurely through intense outside heat raising the internal temperature unexpectedly to an abnormal degree, making the hive unbearable for its immense population—it will readily be seen that a large number of the old bees are out foraging at the time the swarm issues. When they all return the hive is still overcrowded, and, the swarming fever being upon the bees, a cast is the natural result. Another annoying feature about casts is that they issue at any time. I have known them come out as early as six a.m., and as late as eight p.m. They also take not the slightest notice of climatic conditions, leaving the hive just as readily on dull days as upon bright ones, and I have also known them come out when fine rain was falling. Therefore, all things considered, casts should be looked upon as a drawback, and not as an advantage in the apiary.

---

## Correspondence.

---

*The Editors do not hold themselves responsible for the opinions expressed by correspondents. No notice will be taken of anonymous communications, and correspondents are requested to write on one side of the paper only and give their real names and addresses, not necessarily for publication, but as a guarantee of good faith. Illustrations should be drawn on separate pieces of paper.*

---

### RECORD SEASON IN N. NORFOLK.

[8221] The season in North West Norfolk has been a complete success for bee-keepers. Swarms have been few and scarce, but the amount of honey stored has been remarkable. In my own apiary I started the season with five stocks in frame hives, three Italian and two English. From these I have taken 592lb. of honey, and have had six swarms. Two of the Italian stocks after having given about 75lb. to 80lb. surplus each, sent off some very big swarms. The other three hives have not swarmed and from one "White Star," Italian stock, I have taken 197lb. of extracted honey and have made an artificial swarm of four frames. Besides the above, they have three more shallow frame supers sealed and ready to come off. From the two English stocks I have taken 150lb. and 125lb. each respectively. These also have several racks still on, some being ready to come off. I have also reared fifty queens, and these were all successfully mated and are laying well. If the weather keeps fine during August I believe I shall get as much again as I have already taken.

There is so much honey about that it literally seems to pour into the hives. I found that ten frames in the brood-nest was not nearly enough for the Italian queens. The stock that I took 197lb. from had one brood-chamber of eleven frames and two shallow chambers of ten frames, each packed from end to end with brood. Above these were placed four shallow frame supers, but still the bees clustered thickly under the porch and alighting board. I use only W.B.C. hives. In my opinion, a queen can be worn out in one season when working heavily for surplus. My motto is "Requeen every year." This plan I have followed up and always get good returns from my bees. I hope to be able to get 300lb. from this Italian hive and shall have pleasure after the season is over of sending in a full account of the honey yield. Too little attention is paid to having a prolific young queen to head one's colonies. One young queen is worth five old ones, and a good crop of honey is almost certain if in a suitable locality. Honey seems to be abundant everywhere and I was surprised to see such a large quantity at the Royal Show. The bee department at the Royal was splendidly arranged and it reflects great credit on those in charge of this department, who evidently spared no effort to make the show a success. In closing, I wish to say that I hope bee-keepers all over the country are having a good harvest which will amply repay them for the past three bad years, now happily over.—JULIAN E. LOCKWOOD, Hunstanton North.

#### OBTAINING SURPLUS FROM BROOD CHAMBER.

[8222] A correspondent (No. 8156, p. 267), having asked you about taking surplus from a brood box of more than ten frames, you stated it to be a bad plan. I cannot help thinking it a good one, especially for securing early honey from apple and hawthorn, &c. The frames should run across the entrance and then the bees are very likely to store virgin combs at the back. This year in one of my hives the queen has been breeding well on ten frames, and from behind these I have taken a very heavy frame of honey and a frame holding six sections. The sections were spoilt owing to wrong spacing, the bees having actually filled each with two combs without touching the foundation. That, however, was my fault. I have been waiting for shallow frame supers on this and another hive, but have not got the rack complete yet. There can be no doubt that my bees have been far readier to store at the back of the brood-nest than on top. Last year I took a beautiful virgin comb from the same place when the

bees were far too weak to go into supers.—G. G. DESMOND, Camberwell, S.E.

[Of course, our correspondent is entitled to hold a different opinion from ours, but when we are asked for advice we give the best we can, derived from a very long experience of successful honey production. More than twenty-five years ago such frames of sections were worked in the brood box, and in the "Guide Book," at that time it was stated that they "enabled us to get comb-honey from even a weak colony, during a honey flow." A great many bee-keepers, both in this country and America, advocated the plan at that time, but the fact that it has been entirely given up in favour of supers is sufficient evidence that it is not considered a good plan by honey producers. If one is satisfied to get a small number of inferior sections no doubt the plan will do well enough, but there is no question about the superiority of supers, both as regards quality and quantity of honey, due to the natural instinct of bees to store above the brood nest. This year the flow of nectar has been so abundant that bees have stored honey in every available place, and even weak colonies have done something. It is quite evident that our correspondent's colonies were not strong enough or he would not have had to wait to get his supers filled. Our hives have already completed two shallow frame supers, and they all have two more on now, quite filled and ready for extraction. If colonies are properly treated and strong at the right time, there is no difficulty in getting the bees to store in supers when there is a flow of nectar.—ED.]

#### MY INTRODUCTION TO BEE-KEEPING.

[8223] My only excuse for writing this letter is the fact that I have just gathered my first honey harvest. One hot day in July last year, my wife and I were sitting at breakfast when we both exclaimed almost in the same breath: "Oh dear! I could eat some honey." From wishing for honey our conversation drifted to bees and to wondering whether it would be possible for us to keep them. Up to that time I had never to my knowledge seen a honey-bee, and rather fancied that the big wild bees were responsible for the honey seen in shops, so it was decided that before doing anything I should get some book on the subject or have a talk with someone who kept bees.

Now, Mr. Editor, was it a coincidence or mental telepathy which caused my foreman to come running to me that very afternoon to say that a *bundle of wasps* were occupying the workshop, which I may say is in the centre of the town in a very busy thoroughfare. The only person



I could think of who knew anything about the subject of bees was a doctor living about a mile away to whom I sped with all haste only to be told that he was out. Would the housekeeper kindly allow me to see the doctor's bees? She agreed, so away we went down the garden to the hives, when to my astonishment the bees were even more like wasps than mine, being as I afterwards learned, Italians.

The inmates of another of the hives however were very much darker and looked exactly like my swarm, so I decided that after all my wasps must be honey bees. The next question was how to catch the swarm. Never having seen one taken the first thing I did was to get a soap box about eighteen inches square, and smear the inside with syrup, invert this and place it as near the cluster as I dared to go.

After waiting a couple of hours without a single bee going inside a happy thought occurred to someone that if we could only entice the queen to enter the box, the others might follow—but—puzzle find the queen. Nobody volunteered to find her, and as I was the only one who wanted the bees I determined to put as many as I could in, and trust to the queen being amongst them. This I did, and consider that it was the bravest act I ever accomplished, for I cannot think of anything so disconcerting for a novice as to put his hand into a large swarm and try to scrape the bees into a box held in the other hand while thousands of seemingly infuriated demons buzz round his head with a noise which seems to him like an approaching surf wave. Strange to relate I never got a sting, but the suspense, while it lasted, was nerve racking. The next day, having in the meantime had a few hints from the doctor bee-keeper, I bought a hive, put the bees in their permanent quarters and started to feed up. Thanks to the "Guide Book," and the "B.B.J." the bees came through the winter very strong, and to-day I have had the pleasure of taking off forty well filled sections, with more to follow, and I hope that in the future we shall never again have to long for honey at breakfast time without having the wish fulfilled. With all good wishes for a prosperous year.—C. G. NEVATT, Chester.

#### A GOOD RESULT.

[8224] Last year I commenced bee-keeping by purchasing a hive with bees on ten frames; from these I had a swarm and cast, but not a pound of honey did I get. In the winter I lost the parent stock, as the two swarms coming out had so weakened it. This year a swarm issued from the first lot on May 16th, and went

right away, yet from this hive I have already taken off eighty completed sections. From the second lot (the cast), I had a swarm on June 1st, which I put on ten frames, and a super of ten shallow frames which they have nearly filled, and have forty sections completed on the parent stock from which it issued. I have been getting 12s. per dozen retail, and 10s. wholesale for sections unglazed.—S. W. B., Sussex.

#### NOTES FROM CORNWALL.

[8225] *Honey Extractors*—Bee-keepers will soon be busily engaged in extracting honey; a two-frame extractor is generally used, but from my own experience I can assure others that a four-frame "Cowan" is just as easy to turn, and of course much more expeditious than the former, and just about right for a small apiary. The saving of time is very great as compared with the two-frame. The "Cowan" reversible is about the only type of extractor that I personally would care to use. I have tried cheaper patterns, but they all proved unsatisfactory, especially those that necessitate the removal of the comb from the cage in order to turn it. If a large number of combs are uncapped ready for extracting, they can be emptied in a very short time with the aid of a four- or six-frame machine.

*A Good Bee Plant.*—The best bee plant I have yet seen for garden purposes is called "Touch-me-not" (*Impatiens-Noli-me-tangere*). The plant is an annual and grows to a large size, about three feet or more in height and diameter, and bears pink flowers which bloom in the autumn when most needed; the bees simply revel in it. When the seed pods are ripe they burst with a loud report if touched, which no doubt accounts for its English name. The plant is very ornamental, and most desirable apart from its great value as bee forage. I first saw it in Mr. Stapleton's apiary at Gwinear, and he kindly gave me a couple of plants.—W. J. FARMER, Cornwall.

#### AMERICAN AND COLONIAL PAPERS.

##### EXTRACTS AND COMMENTS.

By D. M. Macdonald, Banff.

*Hives in Pairs.*—*Gleanings*, in an editorial, strongly recommends this arrangement. "It is highly desirable to locate the hives in pairs. If one colony is a little weak, its brood can be given to the next hive, which can be removed, thus throwing its little strength over to the other colony. Select the best queen, caging her at the time of uniting, then allow her to eat her way out through a

plug of candy. It is in the fall of the year or early spring that the scheme of having hives in pairs offers particular advantages, for then it is so easy to unite; and it is infinitely better to have one good strong colony than two half-way affairs."

*Interesting Nomenclature.*—Two dozen post offices in the United States are named after the bee. Nine are named Bee, two Beecreek, two Beehive, and one each Beebranch, Beecamp, Beecaves, Beegum, Beehouse, Beelick, Beelog, Beespring, Beesvill, Beetown, and Beeville.

*Smoke at Entrance.*—Dr. Miller believes in doing this, and quotes Mr. Townsend as supporting him. The editor of *Gleanings* thinks the practice is all right, but considers "it is not common on this side of the line." Mr. Townsend I think was writing for beginners. One of our editors does not practise it, but in writing lately for novices he recommended it. All I contend for is that in nine cases out of ten it does no good. At times I think it may do some harm, but my opinions are not very pronounced. Guards might have their vigilance relaxed in a time of robbing thus giving the caterans an advantage (?).

*Foul Brood Inspection.*—From the *Canadian Bee Journal* I quote the following: The question of old with bee-keepers who had disease in their yards was "How can I elude the inspection?" the question now is "How can I get the inspector here soon enough?" In short, inspection is courted where once it was dreaded. I would, without comment, ask antagonists to read, mark, and inwardly digest the quotation.

*A Sign of the Times.*—I make two further short extracts from the same paper—again presenting them without comment. A clause in the newest Canadian Foul Brood Act contains these instructions, "Hives or appurtenances that cannot be disinfected shall be immediately destroyed by fire—and any appurtenances or appliances capable of being disinfected shall be thoroughly disinfected." Even in Canada there are doubters who question whether the McEvoy system of curing foul brood is a full success, among them being such prominent bee-keepers as Messrs. Sibbald and Alpaugh.

*Bee-Keepers' Review.*—An interesting personality has gone from our midst, and beedom is all the poorer for the death of Mr. Hutchinson, the editor and proprietor of this well-known monthly bee paper. As he was to a great extent the life and soul of the *Review*, it may be difficult to replace him. A model bee-keeper, with all his heart in his work, he was one of the most genial of men. It was always a treat to read his editorials, and perhaps no other bee newspaper turned out such ex-

cellent specimens of the photographic art. After life's fitful fever he sleeps well! Latest advices inform us that the *Review* is to be carried on by Mr. E. B. Tyrrel, Secretary of "National," an able bee-man.

*Anatomical Drawings.*—Mr. Snodgrass in a recent issue of *Gleanings* falls foul of several drawings on which many of us have been for long depending as true to life, and he describes several as "the grossest kind of anatomical misrepresentation," "Samuelson and Hicks represent the mandible of the worker as having a row of seven teeth on its cutting edge." Girard's drawings are the crudest ever some of the worst absurdities. Some of Girard's drawings are the crudest ever published in insect anatomy. The heart and sting are given as two instances of "absurdities." "Cheshire made little effort to reproduce faithfully the exact shapes of the organs, and their parts." "Anyone who has ever looked into a bee knows that the air sacs and trachea are altogether different from Witzgall's drawings." The dorsal vessel, the heart proper, the sting and poison glands, the male reproductive organs and many other parts are represented as they are "not seen in the natural position." This is pretty severe, and I on reading on began to wonder if Mr. Snodgrass claimed to have a monopoly of anatomical knowledge of the bee, but I was glad in spite of the above, and many other points I might name, that he confesses "many excellent contributions to the subject have been made by scientific workers." The article set me thinking, and I owe to it a most delightful evening or two hunting up the despised drawings of "old and new masters," with the result that I set a higher value on the condemned ones than on the others.

*Tit-bits.*—Experience has shown that queens do not like to lay eggs next to the outside walls of hives. To get pollen out of combs spray with diluted honey, and the bees will empty it. If the present rate of gain is maintained, the eight frame hive will soon be classed as among the odd sizes. One cannot know too much about the brothers, sisters, cousins, and second cousins of the honey-bee. Smoke used too liberally spoils the flavour of comb honey, and for this reason only use what is necessary to handle bees. The N.S. Appropriation Bill set aside \$15,000 to carry on investigations in bee culture: the increase is to put down disease. Provided they are not too large, I like to have sheep in my bee-yards to keep down the grass. Of all things don't extract "green" honey. To be sure it can be evaporated outside the hive, but evaporation and ripening are two distinct processes, with different results. The adult

queens and the drones receive a certain amount of prepared food throughout their lives, and if this is neglected they become weak and unfit for their duties. In a recent Convention meeting during a discussion on red clover queens, it was easy to see that there was a "big question mark," in the minds of many. I have often freed a balled queen by throwing the ball into a tumbler of water; now we are advised to throw the ball into an empty cold tumbler.

---

## Queries and Replies.

---

[8170] *Clover Pasture and Bees.* I shall be greatly obliged, if you will kindly give your opinion as to whether hive-bees lessen the value of the clover pasture to farmers. In this district, there is an abundance of white clover, most of the farms being dairy farms, with from twenty to thirty cows on each. A number of the farmers, however, consider that their cows give less milk when the clover is in flower, because the nectar is removed by the bees, and the cows are only feeding on the dry bloom. It is not a question here of fertilisation of the clover seed, nor even of fruit, for the fruit in the gardens consists mostly of gooseberries, raspberries, and red and black currants, and the clover is not growing for seed. It is entirely a question as to whether the bees by removing nectar from the white clover lessen the value of the pasturage to the farmer. Your reply will be much appreciated.—J. A. C., Thankerton.

REPLY.—It is a fact that cows fed on clover in bloom yield less milk than when fed on it before the blossom comes, but it is not because the bees remove the nectar. It has been computed that bees visit 3,750,000 clover florets to produce 1 kilo (2½ lbs.) of nectar, it is therefore obvious that this small quantity does not enter into the calculation of the food value. The latter depends on the albuminoids contained in the plant, and it has been found that when clover was cut young it contained 21.9 per cent. of albuminoids, but when the plants were old or in bloom they only gave 9.5 per cent. In the feeding of cows, the albuminoids of the food are dissolved by the gastric juice of the stomach, and ultimately pass into the blood, where they form blood albumen and blood fibrine. As the blood nourishes the muscles, they are modified into flesh fibrine, or, entering the lacteal system, are converted into caseine, while in the appropriate part of the circulation they are formed into the albumen of the egg, or embryo. Nectar is produced in the

flowers only so long as fertilisation has not taken place, and as soon as this has been accomplished the flow of nectar ceases. It has no appreciable food value as by the time the flower is produced the plant has already lost, as we have seen more than half its albuminoids, which determine the yield of milk.

[8171] *Queen-Cell in Section Rack.*—In removing two racks of sections from one of my father's hives, I found four queen-cells on a mis-shaped section, two of them containing a grub each. Do you think the queen deposited the eggs there herself, or did the bees carry the eggs there? The queen excluder was not used, but I found no other brood or pollen whatever in the sections.—C. H. B. (Bury St. Edmunds).

REPLY.—Either of your suppositions may be the correct solution.

[8172] *The Brice Swarm-Catcher.*—In the next Bee Journal would you please explain the following points in working the Brice swarm-catcher. (1) If the old queen cannot leave the hive, how is it possible for the young queen to proceed for mating? (2) Does the swarm-catcher make the bees angry and prevent them working? (3) When the swarm is caught is it possible to hook the appliance off, so that the swarm may be hived.—M. B. J. (Bristol).

REPLY.—The Brice swarm-catcher is clearly illustrated on pages 22 and 23 of the "Guide Book." (1) The old queen does leave the hive, but is trapped in the catcher which is removed with the swarm, so that it is quite easy for the young queen to get out for her mating flight. (2) It does not make them angry, but certainly hinders them in their work. (3) Yes. With regard to the latter part of your letter, no doubt there was clover in bloom which you were not aware of.

---

## Bee Shows to Come.

---

**July 25 to 29, at St. Albans.**—Honey Show of the St. Albans and District Bee-keepers' Association.

**July 26 and 27, at Cardiff.**—Annual Show of the Glamorgan B.K.A. in connection with the Cardiff and County Horticultural Show. Separate tent for honey, wax, and appliances. **Entries closed.**

**July 27, 28, and 29, at Rotherham.**—Show of Hives, Honey, &c., in connection with the Royal Yorkshire Agricultural Society. **Entries closed.**

**August 2, at Stoke Park, Guildford.** Annual Exhibition of Bees, Wax, Appliances, &c., will be held by the Surrey B.K.A., in connection with the Guildford and West Surrey Agricultural Association. **Entries closed.**

**August 3 to 7, at Bury, Lancs.** Honey Show in connection with the Royal Lancashire Agricultural Society's Exhibition. **Entries closed.**

**August 3, at Weston-super-Mare.**—Annual Show of the Somerset B.K.A., in connection with the important Local Annual Flower Show. Classes for Appliances, Honey, Wax, and Bee Products.

Several open and free classes. Liberal prizes. "Small-holder" clock for second highest number of points. Numerous attractions. excursions from all parts. For Schedule, &c., apply to T. Jones, Assistant Show Secretary, North View, Milton-road, Weston-super-Mare. **Entries close July 29.**

**August 7 (Bank Holiday), at Cambridge.** Honey Show in connection with the Cambridge Mammoth Show Society. All Open Classes, four Special Hives to be competed for. This Show also includes dogs, poultry, pigeons, rabbits, cage birds, flowers, fruit, and vegetables; also grand programme of sports and motor racing, &c. Balloon ascent and parachute descent by Captain Spencer. The champion prize band (Irwell Springs) has been specially engaged. Schedules from Hon. Sec., E. F. Dant, Member of B.B.K.A., 52 Bridge Street, Cambridge. **Entries close Thursday, August 3.**

**August 7, at Epworth.** In connection with the Epworth Agricultural Show of Horses, Beasts, Pigs, Poultry, Pigeons, Rabbits, Cage-Birds, Honey, Dairy Produce, &c. Lincs. B.K.A. in charge of Honey Section. Schedules from W. E. Burrows, Secretary, Epworth, Doncaster.

**August 7, at Melton Constable.** The Annual Honey Show of the North Norfolk B.K.A. will be held at Melton Constable Park on above date. Several Open Classes. Schedules from Secretary, North Norfolk B.K.A., The Pightly, Letheringsett, Holt, Norfolk.

**August 9, at Wye, Kent.**—Kent Honey Show. Four Open Classes. Fourteen open to Kent. Trophy Cup value 3 guineas. Open to Kent, Surrey, and Sussex. Two Challenge Cups value 6 guineas each. Many other special and money prizes. Special classes for Cottagers, also class for members of Ashford and District Bee-keepers' Association. Schedules ready early in July, from H. C. Chapelow, Hon. Sec., Wye, Kent. **Entries close August 2nd.**

**August 10, at Madresfield, Malvern.** Annual Show of the Worcestershire B.K.A. Open Class for collection of Bee Products. Prizes, 20s., 10s. Schedules from George Richings, 2, Shrubbery Terrace, Worcester. **Entries close August 5.**

**August 16, at Lancaster.** Lancaster Agricultural Society, in conjunction with the Lancashire B.K.A. 16 Classes for Honey, Bee Produce, and Bee Hives. Numerous specials, including 2 silver challenge cups, 12 silver and bronze medals. Write for Honey Schedule to Robert Gardner, 13, Sun St., Lancaster. **Entries close August 2.**

**August 17, at Kenilworth Castle.** Show of Kenilworth Horticultural Society. Open Honey Classes. Prizes, 10s., 5s., 2s. 6d. Judge, Mr. G. Franklin. Very popular, and an old established exhibition. Schedules from E. H. Thornett, Secretary, Kenilworth.

**August 17, at Abington Park, Northampton.** Northants B.K.A. Annual Honey Show. Special Prizes for Open Classes, including one for single 1lb. jar of Honey. Entry free. Judge, Mr. W. Herrod. Prizes, 20s., 10s., 5s., 2s. 6d., and 1s. 6d. Schedules from R. Hefford, Kingsthorpe, Northants. **Entries close August 12.**

**August 23, at Radstock, Somerset.**—Honey Show in connection with the Radstock Horticultural and Farmers' Association. Open and gift classes. Write for Honey Schedule. B. M. Clark, Foxhills, Radstock.

**August 23 and 24, at Shrewsbury.** Annual Show of the Shropshire Bee-keepers' Association, in connection with the Shropshire Horticultural Society's Great Floral Fête. Eight Open Classes for Honey. Free entry for single bottle and single section. Schedules from S. Cartwright, Hon. Sec., Shawbury, Shrewsbury. **Entries close August 11.**

**August 30, at Chester.** Annual Show of the Cheshire B.K.A. in connection with the County Agricultural Show. Several Open Classes. Good prizes. Schedules, &c., from Hon. Sec., E. W. Franklin, Mouldsworth, near Chester.

**August 30 and 31, at Coventry.**—Annual Show of the Warwickshire B.K.A., in connection with the Warwickshire Agricultural Society. Separate tent for Honey, Wax, and Appliances. Open Classes. Schedules, &c., from J. N. Bower, Knowle, Warwickshire.

**September 6, at Deddington, Oxon.** Show of the Deddington Horticultural Society. Open Class for Honey. Prizes, 10s., 5s., 3s., 2s. No entry fee. Schedules from Messrs. H. J. Harms-

worth or A. A. Busby, Deddington. **Entries close September 1.**

**September 7, at Peterborough.** In connection with Horticultural Society, County Association Class and four Open Classes. Schedules from G. T. Dunham, Albion Terrace, 32, Oundle Road, Peterborough. **Entries close September 1.**

**September 13, at Conway, N. Wales.** Great Annual Honey Show in connection with the Conway Honey Fair. Open and local Classes. Schedules from J. Hughes, Town Hall, Conway. **Entries close September 6th.**

**September 13 and 14, at Cambridge.** Honey Show in connection with the Cambridge and District Red Cross Horticultural Society. Four Classes, open to all. To be held in the Corn Exchange, Cambridge. Schedules and particulars of Hon. Sec., E. F. Dant, Member of B.B.K.A., 52, Bridge Street, Cambridge. **Entries close Saturday, September 9.**

**September 14, at Castle-Douglas.**—Annual Show of South of Scotland Bee-keepers' Association. Five open classes; Three 1-lb. jars extracted, 20s., 10s., and 5s.; three sections, ditto (Entry 2s.). 1lb. jar, also one section, 5s., 3s., and 2s. (Entry free, and exhibits retained unless otherwise agreed upon). Beeswax, 5s., 3s., and 2s. (Entry 6d.). Fourteen classes for members. Schedules from O. Aird, Hardgate, Dalbeattie, N.B. **Entries close September 2.**

**September 26, at Horniman Hall, North End, Croydon.** Exclusive Show of Honey, Wax, Hives, Bees, &c. Increased prizes. Six Open Classes. Judge, Mr. W. Herrod, F.E.S. Schedules from A. Wakerell, 21, Mansfield-road, Croydon. **Entries close September 16.**

**September 27, at Altrincham.**—Honey Show, in connection with the Altrincham Agricultural Show, the largest one-day show in the Kingdom. Classes open to United Kingdom. Classes for Trophy of Honey, for Best Hive, Observatory Hive with Bees and Queen, twelve Jars of Extracted Honey. Classes open to County of Chester, for Run and Section Honey, Wax, &c. Special Classes for Cottagers, and Special Classes for Society's District. Several Special Jubilee prizes. Schedules from Mr. J. Herbert Hall, 2, Dunham Road, Altrincham. **Entries close September 9, and at extra fees September 13.**

## Notices to Correspondents.

R. A. W. (Wooler).—*Uniting Stocks.*—

When uniting with flour it is not necessary to cage the queen, and it is quite sufficient if the inferior one be removed as recommended in the "Guide Book." If the bees are well dusted there is little fear of their attacking the queen. However, if we had a very valuable one, we would take the additional precaution of caging her, although in all cases of uniting with flour in our own experience, we have never yet lost a queen.

NORRIS (Kent).—*Quality of Bees-wax.*—

The wax is not worth more than 1s. per lb., and in no case should you attempt to use it in the hive.

ELTHAM (Kent).—*Making Artificial Increase.*—

There is no doubt that both queen cells have been occupied; had you examined them at the time you would have found a residue of food. Examine the stock again in a few days, the presence of eggs will determine whether a fertilised queen is there. If you are experienced enough, you can of course find the queen by examining the stock.

BOB (Andover).—*Price of Foreign Honey.*

—We have not heard of it, but we know it is sold retail at 6d. per lb. jar.

S. H. T. (Hathern).—*Abnormal Bee.*—The bees was what is called a hermaphrodite, or one having the attributes of both male and female sex. We have had specimens sent to us before of this curious anomaly.

FORMIC ACID (Cheshire).—*Legislation and Bee-Disease.*—Your knowledge of the scourge of foul brood must be very limited or you would not write as you do. We are a long way from being Socialists, but from an experience extending over a quarter of a century during which time we have visited bee-keepers in all parts of the country, we can assure you that a foul brood act would be a blessing to the bee-keeping industry in this country, as it has been to our colonies and other countries. You must be charitable and give other people credit for having a little commonsense and discretion. Your side of the case has been well ventilated in our columns and it will serve no good purpose to keep on repeating the same baseless suppositions.

AXOX.—*Brood Chamber Filled with Honey.*—You should extract a couple of the brood-frames to provide room for the queen to lay. This should be done in the evening to avoid exciting the bees too much.

LOUDON HILL (Galaston).—*Dead Bees Cast Out.*—The bees are robbers, which have been killed by the inmates of the hive where they were found.

W. J. B. (Leicester).—*Brood not Hatching.*—The queen has not been fertilised. We cannot account for the eggs not hatching, unless they have been chilled.

E. RHERS.—*Variety of Bees.*—The bees arrived in a very sticky condition; so far as we can see they are merely ordinary British bees.

BEGINNER (Coventry).—*Bees Under Bedroom Floor.*—It is impossible to tell you unless we could see the position of the bees. Write to the Hon. Secretary of the County Bee Association, Mr. J. Noble-Bower, Knowle, Warwickshire; he may know of a neighbouring bee-keeper who would assist you.

*Suspected Disease.*

C. B. (Fenby).—The comb is affected with foul brood in the advanced stage.

NORTHUMBRIA (Haydon Bridge).—We can find nothing worse than sour brood in the comb sent.

H. L. (Chislehurst).—Send us a few of the bees, and we may be able to tell you what is wrong with them.

M. R. (Kent).—The comb shows foul-brood in first stage of the disease. Destroy the combs also.

*Honey Samples.*

Box (Minchinhampton). Both samples are good in colour, aroma, and flavour, though slightly lacking density. No. 1 is the better of the two in colour and flavour.

P. S. (Bucks). Honey has been gathered principally from clover. It is good enough for even a county show, being superior to the usual samples shown at local competitions.

E. LOXLEY.—A very good heather blend. If the heather flavour was more pronounced it would improve it.

K. C. P. (Birmingham).—The honey is good in flavour and colour, and quite suitable for table use. It should be kept in a warm room for a time, in an open vessel covered with muslin, to increase the density, which is very poor.

E. C. G. (Nantwich).—As a rule, sealed honey does not require any further ripening. Your sample is from mixed sources, medium in colour, but rather dull. Would probably fetch about 50s. per cwt.

P. G. (Northants).—There is no honey-dew in sample; it is from fruit and beans, good in all respects.

O. K. W. (Basford).—No honey-dew in sample sent; it is a good sample of Notts honey (which we know so well) from mixed sources.

KÜTTA.—There is nothing wrong with the honey; it is only following the natural course of granulation.

H. Q. (Sligo).—The honey is a very good sample worth 10d. per lb. retail, and 7½d. wholesale.

F. B. (Wolverhampton).—The sample is not a first class one, because it lacks density and aroma. The flavour is also poor and the honey is rather dull in appearance.

R. D. (Terling).—The sample is an excellent one from sainfoin—good in all points.

FORESTER (Glos.).—The granulated sample is from charlock, and the other from clover. The difference is caused by their being obtained from these different sources.

J. R. (Gloucester).—The light honey is very thin and entirely without flavour. We therefore cannot tell its source. The dark sample is a much better honey of good consistency, and fairly good flavour, it is from white clover, with a little ragwort in it.

NOVICE (Northants).—Honey is quite good enough to show in the medium class.

CYMR0 (Anglesey).—Nos. 1 and 2 are honeys good in colour, aroma and flavour, but lacking density. No. 3 is good in all points, and the best one for show purposes.

F. G. E. (Ludlow).—Sample is from mixed sources, good in all respects.

J. P. (Blackburn).—No. 1 is from mixed sources, no. 2 from sycamore principally. Both are too thin for showing.

### Special Prepaid Advertisements

#### Two Words One Penny, minimum Sixpence.

Orders for three or more consecutive insertions entitle advertisers to one insertion in "The Beekeepers' Record" free of charge.

Trade advertisements of Bees, Honey, Queens, and Bee goods are not admissible at above rate, but will be inserted at 1d. per word as "Business" Announcements, immediately under the Private Advertisements. Advertisements of Hive-manufacturers can only be inserted at a minimum charge of 3s. per  $\frac{1}{2}$  in., or 5s. per inch.

### PRIVATE ADVERTISEMENTS.

**WANTED, PRIME SECTION HONEY,** clean, free from granulation.—Price delivered to W. T. JOYCE, Farnborough, Hants. 1 10

**TWO** strong, healthy four-frame Nuclei for sale, 8s. each; Hives 2s. 6d. or return.—G. M. DARRINGTON, Holm Lea Apiary, Wendon, Saffron Walden, Essex. k 91

**EXTRACTOR and RIPENER WANTED,** must be cheap; full particulars.—R. THOMAS, Llanged, Beaumaris. k 89

**WANTED,** a few dozen drawn out Standard Brood frames, must be guaranteed healthy.—B. CASTELOW, 72, Nicholson-street, Portrach-lane, Stockton-on-Tees, Durham. k 88

**FOR SALE,** half plate stand Camera, Beck lens, shutter, cost £4.10, will exchange for Bees and Honey.—W. GRIFFITHS, Waiton, Stafford. k 98

**SECTIONS, lime and clover blend,** 8s. 6d. doz., clean, up to weight.—NORTH, Cressing, Braintree, Essex. k 99

**CHESHIRE BEES** for sale, guaranteed healthy, strong stocks for heather, on ten wired frames, 22s. 6d.; empty hives, 7s. 6d. and 10s.—T. F. BROOK, South road, Bowdon, Cheshire. k 103

**FOUR-FRAME NUCLEUS,** with 1911 Queens, in new W.B.C. Hives, £1; Bee driving required. WILLETT, New Malden, Surrey. 1 1

**S. P. SOAL,** Rochford, Essex, has a large quantity of very fine Clover Sections, 10s. dozen; also a few dozen specially fine Snow-white, which, for a "display" at Grocer's, leave nothing to be desired, 12s. dozen, glazed and packed to perfection. k 97

**OVERSTOCKED,—6 Stocks Bees** in W.B.C. Hives, guaranteed healthy; 1910 Queens, good form for heather, natives, excellent comb builders; deposit.—H., 23, Bedford-street, Strand, W.C. k 95

**FINEST QUALITY HONEY,** 60s. per cwt., on rail, in 56lb., 28lb., 14lb. tins.—J. IRELAND, Verulam, Hungerford, Berks. k 94

**I HAVE** still some drawn out Shallow Frames unsold, clearing at a cheap rate.—Particulars, &c., from G. C. LYON, Huxtable, Kent. k 93

**TWO BEEHIVES** with ten Standard Frames, foundation, ready for driven Bees, 12s. 6d. each.—SAUNDERS, Thelma Stetchford, Birmingham. k 92

**PURE** Cambridgeshire, light coloured and medium HONEY, 1911, chiefly sainfoin and white clover, in 1cwt. and 28lb. tins, 50s. cwt. on rail; tins returnable. Sample 3d.—JOHN CUNNINGHAM, Stetchworth, near Newmarket, Cambs. 1 6

**WANTED,** Geared Extractor, reversible cages. Particulars and price to J. TONNER, Kirkcowan, Wigtownshire. 1 7

### Special Prepaid Advertisements.—Continued

**GRAND STOCK** of BEES covering 11 frames, well off for stores, 1911 Queen, complete in Hive, with section rack and queen excluder, 37s. 6d.—WOOD, The Crags, Maltby, Rotherham. 1 5

**WHAT OFFERS** in cash for 8 Frame Hives, Taylor's No. 4 pattern, 23 racks, smoker, &c., new last season?—MAYOR, Poulner, Ringwood, Hants. 1 4

**FINEST SCOTCH CLOVER HONEY,** £3 cwt. Sample 3d.—T. R. CLE, Summervale, Annar, Dumfriesshire. 1 8

**HONEY,** first quality sections, 9s. 6d. dozen, 5 dozen 27s., cash with order.—R. COUSINS, The Rosary, Misterton, Gainsborough. 1 9

**NEW SEASON'S EXTRACTED HONEY,** fine sample, in bulk 50s. per cwt., tins included; 1lb. screw cap glass jars, 8s. per dozen.—AVERY, Deverill, Warmminster. 1 2

**34TH CONSECUTIVE YEAR** advertiser in "B.B.J."—ENOCH WOODHAM, Clavering, Newport, Essex, has Swarms, Nuclei and imported Italian Queens, 6s. each; also home-raised Rhode Island Red fowls and Aylesbury ducks of best blood.—Particulars on application. k 81

**GUARANTEED** healthy secondhand Hives, fitted with frames, drawn out combs, cheap.—BARBER, expert, Mere Farm Apiary, Chelford. k 80

**1911 QUEENS,** black, 3s. 6d. each, guaranteed safe delivery.—L. NORTON, Fernlyffe, Cleeve Hill.

**BEES.—A** few guaranteed healthy Stocks in W.B.C. hives, for disposal, all in perfect condition, a really first-class lot.—Apply S., care of "B.B.J." Office, 23, Bedford-street, Strand. k 69

### BUSINESS ADVERTISEMENTS.

**DRIVEN BEES WANTED,** 1s. 6d. lb. cash, boxes returned carriage paid.—A. W. GAMAGE, Ltd., The Holborn Apiary, Church End, Finchley, N.

**SECTIONS, NEW, WANTED** by the HONIE LADE Co., 23, Moorfields, E.C. k 96

**NEWPORT,** Isle-of-Wight, June 20th, 1911. To Mr. J. B. Goodare, Wednesfield.—"Dear Sir,—The 2 Queens you supplied me with last year have done splendidly; I had two strong swarms from both. Please forward me another, and oblige." The above speaks for itself.

**100 LOTS OF DRIVEN BEES,** commencing August 7th, 1s. 6d. per lb.; September, 1s. 2d.—SOUTHCOFF, Gittisham, Honiton.

**HEALTHY DRIVEN BEES,** with queen, commencing August 1st, 4s. 6d. per lot; boxes to be returned; orders rotation; cash with order.—T. PULLEN Ramsbury, Hungerford. k 83

**1911 CARNIOLAN QUEENS,** mated in Carniola, Austria, 4s.; Swiss, 5s.; Italians, 3s.; delivery in one week.—F. VOGT, 32, Selwyn Avenue, Higham's Park, Essex.

**SPRING BEE ESCAPES,** 4d. each; Super Clearer Boards, with above fitted, 1s. 6d. each, carriage paid.—H. CRESSY, Friary Mill Apiary, Dorchester. k 74

**HEALTHY DRIVEN BEES,** 6s. lot, August delivery, orders rotation.—BRADFORD, expert, Worcester. k 78

**GILLIES' Shilling Control Outfit,** refuse substitutes.—Wholesale, IREKLING CORPORATION, Dublin. k 85

**PROLIFIC HYBRID QUEENS,** 15 years' experience, fertile 4s., virgins 2s.—MOORE, 10 The Avenue, Bedford. k 60

## Editorial, Notices, &c.

### REVIEWS.

*The Bee-keeper's Companion*, by S. S. Abbott (London: Mills and Boon, Ltd., 49, Rupert Street, W., price 1s. and 1s. 6d.). In this little book of 120 pages the author tells us that he wants to show what a fascinating, delightful hobby bee-keeping is, how easy and how simple, and how well fitted to the uses of men and women, who have not much time to give to any hobby they take up. He thinks a great many people could keep bees for pleasure around London, and it is therefore to such people in particular that he addresses himself, and endeavours to point out to them how easily bees may be kept in their garden without harm to their children or danger to anyone. There are three chapters on "The Hive," "The Bees in the Hive," and the "Management of the Hive," written in simple language, and the book being quite elementary is only intended as an introduction to bee-keeping, and the author cautions his reader not to think that when he has read this book that he will be a proficient bee-keeper, but although he will not know a hundredth part of what there is to know, he would have his foot on the first rung of the ladder and his enthusiasm stirred.

*Warum stehen auf den Dörfern so viele Bienenhütten leer?* by Reinhold Michaelis (Leipzig: A. Michaelis, publisher, price 60 pfennigs, or 7½d.). The author asks why are there so many empty bee-hives in the villages, and in the following pages gives the explanation. The agriculturist does not take a sufficient interest in the bees to which he owes so much, and the villager does not make himself acquainted with the knowledge necessary for modern methods of bee-keeping, and thinks it unnecessary to study a good bee-book or to give time to reading a bee-paper. Bee-keeping in the country also suffers from the class of person who, the author states, if asked why his hives are not peopled, replies, "I have no luck with bees." The book before us is intended to show that this "no luck" is due to a want of proper knowledge and consequent neglect in doing that which is necessary. It is full of useful advice, and explains the difficulties which those engaged in instruction have to contend with, and how they may be overcome, and bee-keeping made to produce all the honey that is now imported from abroad.

### AMONG THE BEES.

#### GLEANINGS FROM ANCIENT APICULTURE.

By D. M. Macdonald, Banff.

Cotton's "My Bee Book" is made up largely of scraps, gleaned from here, there, and everywhere; it is, indeed, a species of "extracts and comments." As an appendix, he gives us a list of over 120 books on bees which he had collected in 1842. De Montford, however, who drew the "portrait of the honey fly," in 1645, enumerates the authors up to his time as nearly 600, although we must look on several as rather apocryphal. Earlier still—indeed, more than 1900 years ago—one Hyginus was so enthusiastic that he compiled a species of "My Bee Book," made up of passages which he found scattered over the pages of earlier antiquity, showing that thus early the Bibliography of the Bee was no small matter. Chief amongst these earlier writers on apiculture were the sweet-tongued Virgil, so often quoted with approbation, because of his loving treatment of the bee in his Fourth Georgic, and the encyclopædic Aristotle, who wrote so much "at large" on this fascinating topic. There is poetry and charity in Virgil's treatment of the complicated government and wonderful economy of the hive interior, and he believed, with others before him, that "Bees have portions of ethereal thought." He studied them lovingly, I doubt not, in some veteran cottagers' gardens, and in an apiary of his own in sweet Parthenope. Leaving Aristotle in better hands, I proceed to make a few gleanings from other writers of Ancient Beedom.

One story goes that the Curetes, wishing to hide the birth of Jupiter from his father Saturn, set up a clashing of cymbals to drown the noise of his infant cries (Lucret. ii 635). The noise attracted a swarm of bees to the cave where the child was hid, and their honey nourished him. This is claimed as the origin of ringing, or "tanging" the bees. We have the story in Varro, and in Virgil, where the "cymbal" is sounded to attract the bees. Some asserted it affected them through pleasure, others thought through fear.

Some may be familiar with Hyll's story of the bees hatching their young: "They lay eggs and sit upon them, as the hens do on their eggs, and then do they hatch their young ones, which come forth at first like to white worms." But the story is older than 1690. "By this time do your bees sit," says Evelyn in his Calendar for March. In a more ancient Arabic book (1405) we read: "When it has deposited the eggs it sits on them as a bird, and cherishes them, the eggs become maggots, and afterwards the maggot

flies." In *Georgic iv.* 56, Virgil says: "*Progenium nidisque fovent.*" Every schoolboy who has read Xenophon will remember the account, *Anabasis iv.* 8, of the poisoning of soldiers by honey from the *Rhododendron Ponticum*, or the *Kalmia latifolia*, so I need not reproduce it. The same effect is also mentioned by Diodorus, Dioscorides, Pliny, Strabo, Aelian, and Procopius. Anciently Hymettus honey was famed for its superior qualities. Without using any scale of points they were capable judges of good honey in ancient times to judge by the following excellent estimate: "In all countries the light is better estimated than the dark, but the best is that which is very clear, of a light golden colour, of a most pleasant and sweet taste cleaving somewhat to the fingers in handling, and but little waxing together."

Akin to honey is Mead, or Metheglin—*μέθυσ ἀργήην*. It was the drink of the ancient Britons and Norsemen, and was used at the Feast of Skulls. In ancient times our kings had reported to them, first, every new song; second every cask of mead. The Romans softened their wine sometimes with honey (Virgil), and sometimes with mead, *mulso* (Horace).

Virgil and many ancients are particular about the placing of a hive, but readers can discover for themselves the various points enumerated by the former, either in the original or in translations. Old Tusser, however, whose saws deserve to be republished in a cheap form by the Royal Agricultural Society, wrote, among his "Five Hundred Points of Good Husbandry," the following:—

"Set hive on a plank not too low on the ground,  
Where herbs with the flowers may compass it round;  
And boards to defend it from north and north-east,  
From showers and rubbish, from vermin and beast."

The favourite bee plants would form an interesting study. Pliny bids us plant thyme and apiaster, violets, roses, and lilies, one only of which we would regard as a first-class bee plant. Columella advises ceptus and rosemary. A by no means favourite food for bees or their owners will be detected in Virgil's "*Erica mellis celestia dona.*"

The sex of the inhabitants of the hive of old gave room for much discussion. We know, therefore I need not say more, but I cannot refrain from quoting the following titbit, which our lady bee-keepers may find interesting:—"The tenth and last specimen of women were made out of a bee; and happy is the man who gets such a one for his wife. She is altogether faultless, and unblameable.

Her family flourishes and improves by her good management. She loves her husband, and is beloved by him. She brings him a race of beautiful and virtuous children. She distinguishes herself among her sex. She is surrounded with graces. She never sits among the loose tribe of women, nor passes away her time with them in wanton discourses. She is full of virtue and prudence, and is the best wife that Jupiter can bestow on any man."

What better can be wished for every bee-keeper about to marry than that he may be blessed with just such a wife!!

## NECTAR-PRODUCING PLANTS AND THEIR POLLEN.

By Geo. Hayes, Beeston, Notts.

(Continued from p. 273).

No. 10. HEATHER (*Erica Tetralix*, *Erica cinerea*, and *Calluna Vulgaris*).

NATURAL ORDER *Ericaceæ*.

*Erica Tetralix*.—When speaking or writing of heather, it must be remembered that we have three species that are common. Of the one under consideration we need not say much, for although it is common in the West, it is not in other parts found in any considerable quantity, and for this reason it is not considered of much value as a nectar-producing plant. It is, however, interesting to know of its existence, and to look it out for ourselves when on the heaths. This plant, like the others of its kind, is a perennial, and should be looked for during July and August by those who would admire its wax-like bells, generally of a pale red colour, though sometimes pure white, which are always borne at the top of the branches, forming little clusters of close umbels, all turning in one direction. The leaves grow in fours on the stems at each joint, this fact being set forth in its title "*tetralix*," meaning four-leaved. It is also called the cross-leaved heather; for when viewed from above, these four leaves assume the form of a cross.

This heath is the badge of the Clan MacDonald (I wonder whether our friend, D. M. M., belongs to this line; he is certainly worthy of it), as *E. cinerea* is of the MacAlisters, and ling of the MacDonnells.

*Erica cinerea*, or *Bell Heather*.—"Erica" implies that this plant is of a branching habit and difficult to break; whilst "*cinerea*" denotes that its stalks are ashy-grey in colour. Vast tracts of country in the United Kingdom are covered by this heath, and we meet it constantly in the uplands of the North and West. It is generally found in



company with the cross-leaved heath and the ling. In colour, its flowers are the richest, and are also the largest of the three; although in grace of form and delicacy of tint *E. tetralix* is a very close rival. Like the other two species, it flowers from July to September. A fortnight will make a great difference in the appearance of a common, as almost all the plants flower at about the same time. If it is visited too early a mass of russet-green is all that meets the eye; and if too late, the purple splendour has given place to the uninviting brown hue of decay. The plant is of a bushy nature, the branches mostly springing separately from the base and growing to a height of from 6in. to 12in., depending upon the nature of the soil.

Its leaves are sharply pointed, and they grow in whorls or rings round the stem. The flowers are of a reddish purple, produced in dense terminal racemes one above another, and are shaped like a bell, being nearly closed at the mouth, and just leaving a small opening through which the style protrudes. The anthers are fixed inside the bell all round the style, and are attached to filamentous springs, which are operated on by the tongue of the bee when she thrusts it into the corolla to reach the nectary situated in the upper part of the bell. Thus a shower of pollen is made to fall on the face of the bee whence it is carried to another flower to fertilise a protruding stigma, which comes in contact with her face as she rifles the flower. This and a similar arrangement in the ling is the

cause of so much pollen being found in heather honey.

This heather is generally considered to yield nectar indifferently, and to be of very little use to the bee-keeper, but like other flowers, it has its prolific and unproductive seasons. I have had bees gather it abundantly, practically pure, and it has been of a lovely crimson-red colour, and although thin, of very fair flavour.

*Ling or Calluna Vulgaris*.—Not perhaps so attractive to the general observer as *E. cinerea*, this species is even more abundant, and is the one that best claims the attention of the bee-keeper; for to him it is the heath from which the world-renowned heather honey is produced.

It forms a low, straggling shrub. Its branches are tough, and more woody than in the other two species. Its leaves borne in close masses on the side shoots are very small and placed in rows. They are also covered with knobby hairs.

The flowers, too, are very small, and of a pinkish tint, but occasionally they may be found pure white. What at first glance we might suppose to be the corolla, is in reality the calyx (as in the fuchsia), and the true corolla, having its petals much shorter and smaller than the

enclosing sepals, may be seen within on a closer examination. Outside and beneath the true calyx may be seen four small bracts resembling a secondary calyx. The calyx is deeply cut into four lobes, whilst the petals and bracts have each four parts, and the stamens are eight in number.

The beauty of the heath and its effect in landscape are often referred to by the poets. Of its utility one says:—

Dry

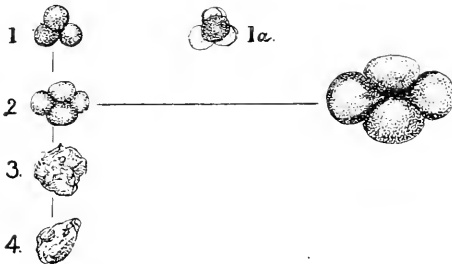

In Formalin



From Honey

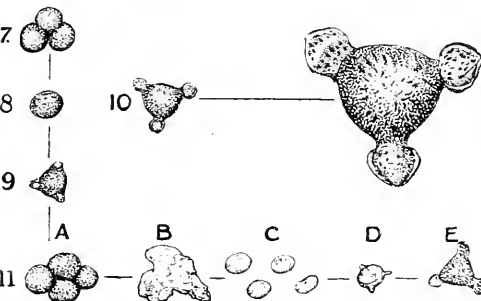

POLLEN OF HEATHER.

"Of this, Old Scotia's hardy mountaineers,  
Their rustic couches form, and there enjoy  
Sleep: which beneath his velvet canopy  
Luxurious idleness implores in vain."

In addition to its service for the roofing of houses, it is used in some parts for fuel, for fencing, and for heating ovens; as well as for making brooms, or, as they are called in some districts, "Besoms." I well remember some thirty to forty years ago a man who resided on the "Forest," as the heath was called hereabouts in Notts, who made his living by collecting ling and making it into besoms, and was known by the appellation of "Besom Jack." It is also food for sheep, and the very young shoots are eaten with avidity by grouse, and the caterpillar of our beautiful Emperor Moth. A good yellow and an orange dye is obtained from its branches, and if oak is added to it we get a lovely brown.

We have a few bee-keepers in this county whom I rather envy, because they have in their immediate neighbourhood three of our best sources of honey, viz., white clover, limes, and heather; and I say, "Happy is the bee-keeper who is in such a case."

The pollen from these three heathers is very similar, and for this reason we may treat them as from one. These grains are different from any we have considered before, inasmuch as they are of what is known as the tetrad form, though they do not stand alone in this respect, as we shall see later. The peculiarity of this form is that they leave the anther in what is termed the mother cell. All pollen grains are produced in these cells within the anther, but in the majority of cases the grains leave them singly. In the heather, each mother cell contains four spherical pollen grains, and when examined dry, or without friction, they appear as seen at 2, 7, and 11a, though oftener than not they seem to be only triad, or having only three spheres. This is owing to the position in which they lie, and to the arrangement of the spheres, which is shown perhaps more clearly at 1a—or, to give an illustration, like three marbles placed close together, and a fourth placed on top in the centre of them, with a covering encircling them tightly. This is plainly seen under the microscope, when the grains are placed in water and rolled about with a stiff hair.

This was the form I at first expected always to find, as it is maintained mostly in moisture, but later, having placed some on a slide after being in medium for a time, and using a little friction with the cover glass, I found some of the mother cells had burst, and three pollen grains were free. These I photographed at the time for a record.

In honey these spherical grains swell after being liberated, and I believe they often do so before being set free, and so burst their covering, though many will be set free by mechanical force in dealing with the honey. After being liberated by one of these means the spheres grow three processes, and for a time are as seen at 9 and 11d, which grow or swell until they reach their final form as seen at 10 and 11e, No. 11a to e shows the whole metamorphoses, 11b being the pellicle or mother-cell.

Nos. 3 and 4 are diseased pollen grains, which appear darker than healthy ones, and lose most of their original form.

The colour of the pollen by reflected light is white, but by transmitted light of a golden yellow. The reason of this is that the mother-cell is a white covering to the coloured pollen grains beneath it. The after form, of course, is golden-yellow, both by reflected and transmitted light.

The approximate measurements are as follows: No. 1  $\frac{1\frac{1}{2} \times 1}{10,000}$ , No. 2  $\frac{1\frac{1}{2}}{10,000}$ , Nos. 6, 7, 8, and 9 a slight increase on last measurement, No. 10  $\frac{1\frac{1}{2}}{10,000}$  from angle to angle.

(To be continued.)

---



---

## Correspondence.

---

*The Editors do not hold themselves responsible for the opinions expressed by correspondents. No notice will be taken of anonymous communications, and correspondents are requested to write on one side of the paper only and give their real names and addresses, not necessarily for publication, but as a guarantee of good faith. Illustrations should be drawn on separate pieces of paper.*

---

### ROSS-SHIRE NOTES.

#### PLANS FOR THE HEATHER SEASON.

[8226] With white clover, an excellent crop, practically finished, the coming heather harvest claims our best attention. Bees are in ideal condition, and given favourable weather during August, a heavy crop is certain—but it must be put in the right place. Too often in a good heather season the brood-chamber is blocked with honey that should have gone into the supers. In the North, we find abundant super room during the clover flow puts our stocks into good shape for the heather. A colony occupying five racks in July will store practically all its surplus above, leaving the brood-combs open for the queen. As the clover harvest ends, all finished sections are removed, and the remainder left for completion at the heather. This works all right when one crop closely follows the other, but in

some seasons there is a period of several weeks between, during which brood-rearing declines and the population lessens. Then, when the heather honey comes, it all goes into the brood-combs.

With such a contingency in view, I am giving a trial to several forms of the plural queen method this season. In one hive I have two ten-frame brood-boxes, each with a laying queen; in another, three full-depth chambers tiered up and three laying queens, separated by excluders, with the bees all working from one entrance. The other day I artificially swarmed a strong stock on to a shallow super half filled with honey. Their unfinished sections and an extra rack with foundation were replaced, and above all, with a board between, was placed the removed chamber, containing eleven frames of brood. A young laying queen was run in, and the new colony allowed to work through an entrance cut in the lift. When the heather flow comes, it will be a simple matter to temporarily cage the queen and shake down her bees in front of the main entrance. I hope to try another colony on this plan, which, theoretically, seems feasible enough. Artificial swarming on to empty combs at the moors would simply invite brood-nest storage, but the other method anticipates this tendency, and compels the bees to carry the precious nectar into the sections. For those who prefer it, a simpler way would be to wait until the heather flow has begun, then swarm on to a stored shallow super, with one on frames of brood to occupy the queen. On this place an excluder, then the racks of combed sections covered with enamel cloth, and on top the removed brood and nurse bees. A small hole cut in the quilt behind the dummy will allow the young bees to find their way down below as they hatch. Of course, all this means some trouble, but I do not mind that in the least if the result is an increased crop of the much-wanted heather sections.—J. M. ELLIS, Ussie Valley.

#### OBSERVATORY HIVES.

[8227] Mr. F. de Silva on page 194 gives an extract from Pepy's diary dated 5th May, 1665, referring to an observatory hive, and asks if this is the earliest mention of such a hive. If he turns to Evelyn's diary he will find under entry 13th July, 1654 (eleven years earlier), the following passage.

"We all dined at that most obliging and universally-curious Dr. Wilkins's, at Wadham College. He was the first who showed me the transparent apiaries, which he had built like castles and palaces, and

so ordered them one upon another as to take the honey without destroying the bees. These were adorned with a variety of dials, little statues, vanes, &c., and he was so abundantly civil, as finding me pleased with them, to present me with one of the hives which he had empty, and which I afterwards had in my garden at Sayes Court, where it remained many years, and which his Majesty came on purpose to see and contemplate with much satisfaction."

In another part of the diary it is stated that Dr. Wilkins was the brother-in-law of the protector, Oliver Cromwell.—G. W. BULLAMORE, Albury, Herts.

#### BEE DISEASES AND FEEDING.

[8228] Is it not just possible that the amount of bee-disease now afflicting the British bee industry, may be in some degree attributable to the habit of forcing bees to live on artificial foods during the winter, a season when their enforced inactivity renders them doubly sensitive to any strain on their delicate internal organs, thus affecting their disease-resisting powers and entire constitution? It should not be forgotten that honey is a pre-digested and highly-specialised bee-food, accurately elaborated by bees for bees, and presumably indispensable for their well-being: whereas sugar-syrups, candies, &c., are merely substitutes, no doubt inadequate, on which bees can *exist* (for a time), but not *prosper*.

It is hardly likely that such an immemorial adaptation as that of honey to bees, or bees to honey, can be artificially set at naught with impunity. And who shall say what injurious effects all this artificial feeding may have on queens and their progeny, especially when it is considered that in place of their own highly-concentrated, aromatic, directly assimilable food, they are expected to put up with an insipid, watery, unpalatable, indigestible mess like sugar-syrup?

Here in Italy, where, owing to the ruinous price of sugar, bees are allowed to live almost entirely on their own honey, disease of any kind is quite an exceptional condition, though now and then one hears of cases of foul brood.

For my part nothing would induce me to feed my bees on anything but their own honey, *i.e.*, that of the Roman Campagna, which, I may incidentally remark, is the most perfect honey I ever tasted.—A ROMAN BEE-KEEPER, Anzio, July 20th.

[There is no doubt that sugar-syrup is not a complete food for bees, nor is it recommended as such, but only as a substitute in special cases—that is, when bees

have not a sufficient supply of natural stores. It is very rarely that we personally have to resort to artificial feeding, as our bees generally store sufficient honey to last them until a fresh supply comes in spring. Should feeding be necessary, we give them the thin honey extracted from combs left unsealed in our supers at the end of the season. No bee-keeper now removes the honey from the brood-chamber, it is usually left for winter food, and it is only recommended to supplement this with syrup if there is insufficient for the requirements of the bees. No doubt some of the diseases, more particularly dysentery, can be attributed to using beet sugar instead of cane.—ED.]

#### BEE NOTES FROM SUSSEX.

[8229] Disaster overtook the stocks belonging to my sons and myself last winter, for out of twenty-four stocks only one survived, and we had nearly lost all heart, but when we were offered good swarms at 15s. each, we thought we would make a fresh start, and purchased five this spring.

The first swarm, consisting of some two gallons of bees, was hived on May 28th; we gave them ten frames, some of which contained honey, which we uncapped for them. A rack of sections with one section drawn out was added, and within a week the whole of the brood-chamber was a mass of honey, and the sections were nearly a third full. I took some of the honey away, and gave more empty comb to allow the queen to lay, and this she did at once.

I have to-day (July 22nd) placed on the fifth rack of sections, as there are only three sections unfinished out of the other four racks. All the other swarms have done nearly as well; the honey is very choice and light. I am getting 15s. a dozen easily for my sections, as I sell retail only.

I am very much afraid our stocks were carried off by bee paralysis or Isle of Wight disease, but I have now thoroughly disinfected every hive, burnt doubtful comb and frames, besides which, I have locked up my apiary to prevent any expert coming whilst I am away, and perhaps carrying infection to other apiaries.

I was astonished to see that my present bees began work at four o'clock this morning, for that was the hour I found them pouring out of the hives, which are located in an orchard, and face east.—E. WATTS, Partridge Green, July 25th.

#### LEGISLATION FOR BEE DISEASES.

[8230] In the "B.B.J." of July 20th (page 283) Mr. G. Field calls the resolution passed by the Cheshire Bee-keepers' Association, for the suppression of bee diseases, "A very large order." All that we require is a similar Act to the one in force in Ireland, with this exception, that it includes "Isle of Wight" disease, which the Irish Act does not. Mr. Field asks:—"Would it not be wiser for the Board of Agriculture to invite suggested legislation from the Central British Bee-keepers' Association?" I say: Let them by all means; but if bee-keepers, as a body, do not use pressure to make the Board do something, we shall find that nothing is done. That is why I suggest that other County Associations should do as Cheshire has done—pass a resolution and send it to the Board of Agriculture, and get their Members of Parliament to support it. As to the question of compensation, if an Act is passed and we have power to destroy bees, &c., I should say that if it facilitates the passing of legislation, give it, as is done in Ireland, but personally I cannot see where the value of the property comes in. If a stock is so badly diseased that the bees and frames have to be destroyed, surely there is no value attached to them. Mr. Field says: "Fear of personal loss would be to many poor men an encouragement to hide their troubles, and thus spread them in a district." Does he mean to imply that badly diseased bees are remunerative to anyone. I should say that the poor man would lose less by having his bees examined, and if disease is found in its incipient stage, having them treated for it, before it reaches the condition when nothing can be done but destroy. I consider that giving compensation would be offering a premium for the careless management of bees. To show how necessary legislation is, one has only to read of the experiences of "J. T." Tomintoul (page 283), in the last number of the "B.B.J.," and there are scores of the bee-keepers in every county of Great Britain who have had a similar experience. How long are bee-keepers going to allow this to go on? Let us all unite and make ourselves heard, and so get the Government to bring in a Bill dealing with the subject once and for all. E. W. FRANKLIN, Hon. Sec., Cheshire B.K.A.

[We do not think such resolutions have much effect on the Board of Agriculture, who have been kept informed by the British Bee-keepers' Association of the desire of the affiliated associations for legislation. The question of a proposed bill has also been considered and discussed, and when introduced, would certainly

include all diseases of bees, and not only foul brood. If the County Associations really desire legislation, they should help the committee appointed by the British Bee-Keepers' Association to get the opinion of bee-keepers, for that is the only thing standing in the way of legislation at the present moment. In the interview the chairman of the British Bee-Keepers' Association had with the President of the Board of Agriculture, Lord Carrington, the latter stated that if the Central Association could show that the majority of bee-keepers were in favour of legislation, and if they could produce such a consensus of opinion as that which the chairman showed from Cumberland, they would consider the advisability of asking the Government to pass a Bill. It remains now for the affiliated associations to get the necessary evidence, and only when this is obtained is the Board of Agriculture likely to move in the matter. The time for resolutions has passed, and now action is required, and we would therefore urge those who wish for legislation to supply the required information to the hon. secretary, Mr. L. S. Crawshaw, Norton, Malton, Yorks. We would add that the committee in charge of the question of legislation have amended the Bill, so as to get over the objections raised to some of the clauses. The committee is to meet again on September 21st, to consider the remaining clauses of the Bill, and it is hoped that the information required will be forthcoming by that time. Resolutions, even supported by members of Parliament have little effect when the information required is not forthcoming, and the affiliated associations would be doing much useful work by collecting such information and forwarding it to Mr. Crawshaw. The question has been thoroughly thrashed out in our columns, so we propose to close this correspondence, while we now await the result of the appeal to the affiliated associations.—Ed.]

### CAPPINGS OF COMB.

BY L. S. CRAWSHAW, NORTON, MALTON, YORKS.

*Preventing Increase* (page 256).—This method has, no doubt, been pretty well tried, but I think it has not always proved a failure. It has failed with me only when the entrance was above the non-swarming chamber, as made by E. H. Taylor. Some eight or nine years ago I got a dozen of these Taylor chambers, and found this fault with them. I lowered the alighting-board, and believe that their utility has greatly increased. It is of little use to put starters under the brood nest, as drone comb is almost certain to be built in quantity. I get a number of useful, shallow combs built below with the

minimum of trouble. I do not remember a case of swarming from a hive so fitted, but that does not prove much, as I get very few swarms in any case. An objection to their use is that bees may refuse extra racks of sections, particularly if there is much sealed-honey in the brood-combs. I prefer to keep the bees a trifle crowded below for the sake of better work above. Mr. Evans' theory that an excluder below will retard drone breeding is, I fear, a fallacy. It is more than doubtful whether bees can reason so far as he supposes.

*Swarm Control* (page 264).—It is not quite clear to me what Mr. J. H. Marrs means when he implies that the success of the Stapleton plan depended upon his not destroying queen-cells. As a matter of surmise, the small cell to which he refers probably contained a dead queen.

*Position of Stores* (page 267).—Is it quite correct to say that bees *always* store above the brood-nest. My experience has been that at least one fat comb is usually to be found at the side of the nest. The difference in experience may be due to the prolificness of the queens. This year of grace storing has not been confined to the outside comb, but has encroached still further upon the bee's nursery. I have tried the plan suggested by W. Bee. It is not a success, principally for the reason that brood-comb wax is used to build and cap the sections, and they become very dark in consequence. Also, if the brood nest be extensive, pollen will very likely be stored in the sections, and that is annoying, even upon the home table!

*Instinct* (page 271).—It is at least open to indignant question whether man is not upon an equality with some wild creatures at the moment of his birth. Many of these are so helpless that if uncared for they would die, and their only instinct is one which they share with man—the desire for food. Man at least arrives with his eyes open.

*Notes from Cornwall* (page 274).—It is like the meeting of an old friend, to hear again from Mr. Farmer. No one regretted more than I, that he was obliged to temporarily desist from writing for the pages of the "B.B.J." I find myself in some sympathy with his present notes. I know of places where the cottager only manages to keep bees successfully in skeps, and I am in entire agreement as to the undesirability of the indiscriminate advocacy of bee-keeping as a pursuit. I am heterodox enough to believe that many of the unsuitable keepers of frame hives are as great a menace to bee-keeping in general as is the less educated skeppist with his sealed book.

*Sting Remedies* (page 275).—I do not know whether methylated alcohol, such as

we use in this country, is easily available to Herr Schröder. But if so, would he kindly say whether he finds it equally efficacious with pure alcohol?

## Queries and Replies.

[8173] *Using the Super-Clearer.*—May I take advantage of the kindness to which you give expression in the "B.B.J." of July 13th, by asking for light upon the following matters. (1) About June 15th, I placed a rack of partly filled sections on top of another rack on one of my hives and fourteen days after it was lighter than when put on. Would the inclement weather about the Coronation period account for this or was there any fault in the method. (2) My Guide Book (19th edition), on Page 113, suggests feeding to produce comb when forage is scarce. Could this be carried out during August, and if so would the bees build in supers, either shallow frames or sections. (3) To clear supers of bees, is there any disadvantage in placing the super above the quilts and allowing the bees to go out of the escapes in the roof, rather than using the super clearer as in Fig. 36. With the former method you have only to carry the super away when clear, but with the latter you have to remove the clearer and cover up again. I find the journal very interesting and helpful, and although a bee-keeper since 1907, I find there is a great deal more to learn.—J. W. D. (Fareham).

REPLY.—(1) The inclement weather which prevailed about that time would be the cause. Empty supers should be put under the full one, not on the top. (2) Yes. (3) It is much better to use the Porter Escape, it does the work quicker and prevents the possibility of bees or wasps getting back through the cone escapes. Many thanks for your appreciation.

[8174] *Cleaning Floor-board.*—I should be glad if you would answer me the following questions:—(1) How many loads of nectar does it take to fill one ordinary worker cell? (2) What method do you adopt for cleaning the floor-board of hive without disturbing the bees, and if the operation is done before February, are the bees likely to "ball" the queen. (3) Are there any objections to using old blanketing for packing between the inner and outer case of hive, as this would be easier to remove than chaff or paper, and equally warm.—T. R., Staffs.

REPLY.—(1) It is difficult to say, as a great deal would depend upon its density or otherwise. (2) If you refer to BEE JOURNAL of April 27th, 1911 (page 162),

you will find full instructions for cleaning floor-board. On no account must you do this in February. April is the earliest month for this to be done safely. (3) No packing is required. The air-space is most healthy.

## Bee Shows to Come.

**August 7 (Bank Holiday), at Cambridge.** Honey Show in connection with the Cambridge Mammoth Show Society. All Open Classes, four Special Hives to be competed for. This Show also includes dogs, poultry, pigeons, rabbits, cage birds, flowers, fruit, and vegetables; also grand programme of sports and motor racing, &c. Balloon ascent and parachute descent by Captain Spencer. The champion prize band (Irwell Springs) has been specially engaged. Schedules from Hon. Sec., E. F. Dant, Member of B.B.K.A., 52 Bridge Street, Cambridge. **Entries close Thursday, August 3.**

**August 7, at Epworth.** In connection with the Epworth Agricultural Show of Horses, Beasts, Pigs, Poultry, Pigeons, Rabbits, Cage-Birds, Honey, Dairy Produce, &c. Lincs. B.K.A. in charge of Honey Section. Schedules from W. E. Burrows, Secretary, Epworth, Doncaster.

**August 7, at Melton Constable.** The Annual Honey Show of the North Norfolk B.K.A. will be held at Melton Constable Park on above date. Several Open Classes. Schedules from Secretary, North Norfolk B.K.A., The Pightly, Letheringsett, Holt, Norfolk.

**August 9, at Wye, Kent.**—Kent Honey Show. Four Open Classes. Fourteen open to Kent. Trophy Cup value 3 guineas. Open to Kent, Surrey, and Sussex. Two Challenge Cups value 6 guineas each. Many other special and money prizes. **Entries closed.**

**August 10, at Madresfield, Malvern.** Annual Show of the Worcestershire B.K.A. Open Class for collection of Bee Products. Prizes, 20s., 10s. Schedules from George Richings, 2, Shrubbery Terrace, Worcester. **Entries close August 5.**

**August 16, at Lancaster.** Lancaster Agricultural Society, in conjunction with the Lancashire B.K.A. 16 Classes for Honey, Bee Produce, and Bee Hives. Numerous specials, including 2 silver challenge cups, 12 silver and bronze medals. **Entries closed.**

**August 17, at Kenilworth Castle.** Show of Kenilworth Horticultural Society. Open Honey Classes. Prizes, 10s., 5s., 2s. 6d. Judge, Mr. G. Franklin. Very popular, and an old established exhibition. Schedules from E. H. Thornett, Secretary, Kenilworth.

**August 17, at Abington Park, Northampton.** Northants B.K.A. Annual Honey Show. Special Prizes for Open Classes, including one for single 1lb. jar of Honey. Entry free. Judge, Mr. W. Herrod. Prizes, 20s., 10s., 5s., 2s. 6d., and 1s. 6d. Schedules from R. Heford, Kingsthorpe, Northants. **Entries close August 12.**

**August 23, at Radstock, Somerset.**—Honey Show in connection with the Radstock Horticultural and Farmers' Association. Open and gift classes. Write for Honey Schedule. B. M. Clark, Foxhills, Radstock.

**August 23 and 24, at Shrewsbury.** Annual Show of the Shropshire Bee-keepers' Association, in connection with the Shropshire Horticultural Society's Great Floral Fête. Eight Open Classes for Honey. Free entry for single bottle and single section. Schedules from S. Cartwright, Hon. Sec., Shawbury, Shrewsbury. **Entries close August 11.**

**August 26, at Kettering.**—In connection with the Kettering Working-Men's Horticultural Society's Show. Open Class for Honey, single 1lb. jar. First prize value 16s. Entries free. Schedules from Hon. Sec., W. Ileridge, 114, King Street, Kettering.

**August 29, at Cartmel, Lancs.** Bee and Honey Show in connection with the Cartmel Agricultural Society's 29th Annual Show. Liberal prizes. Open classes. Schedules from J. N. Parker, Cartmel, near Carnforth.

**August 30, at Chester.**—Annual Show of the Cheshire B.K.A. in connection with the County Agricultural Show. Several Open Classes. Good prizes. Schedules, &c., from Hon. Sec., E. W. Franklin, Mouldsworth, near Chester.

**August 30 and 31, at Carlisle.**—Annual Honey Show of the Cumberland and Westmorland B.K.A. in connection with the Carlisle Horticultural Society's Exhibition to be held in the Covered Market, Carlisle. Schedules from G. W. Avery, Hon. Sec., Heads Nook, Carlisle.

**August 30 and 31, at Coventry.**—Annual Show of the Warwickshire B.K.A., in connection with the Warwickshire Agricultural Society. Separate tent for Honey, Wax, and Appliances. Open Classes. Schedules, &c., from J. N. Bower, Knowle, Warwickshire.

**September 6, at Deddington, Oxon.**—Show of the Deddington Horticultural Society. Open Class for Honey. Prizes, 10s., 5s., 3s., 2s. No entry fee. Schedules from Messrs. H. J. Harnsworth or A. A. Busby, Deddington. **Entries close September 1.**

**September 7, at Peterborough.**—In connection with Horticultural Society. County Association Class and four Open Classes. Schedules from G. T. Dunham, Albion Terrace, 32, Oundle Road, Peterborough. **Entries close September 1.**

**September 13, at Conway, N. Wales.**—Great Annual Honey Show in connection with the Conway Honey Fair. Open and local Classes. Schedules from J. Hughes, Town Hall, Conway. **Entries close September 6.**

**September 13 and 14, at Cambridge.**—Honey Show in connection with the Cambridge and District Red Cross Horticultural Society. Four Classes, open to all. To be held in the Corn Exchange, Cambridge. Schedules and particulars of Hon. Sec., E. F. Dant, Member of B.B.K.A., 52, Bridge Street, Cambridge. **Entries close Saturday, September 9.**

**September 16 to 23, at the Agricultural Hall, London.**—Honey show in connection with the 19th Annual Exhibition and Market of the Grocery and Kindred Trades. Liberal prizes. Open to all British Bee-keepers. Schedules from H. S. Rogers, Secretary, Exhibition Offices, Palmerston House, Old Broad Street, London, E.C.

**September 14, at Castle-Douglas.**—Annual Show of South of Scotland Bee-keepers Association. Five open classes; Three 1-lb. jars extracted, 20s., 10s., and 5s.; three sections, ditto (Entry 2s.), 1lb. jar, also one section, 5s., 3s., and 2s. (Entry free, and exhibits retained unless otherwise agreed upon). Beeswax, 5s., 3s., and 2s. (Entry 6d.). Fourteen classes for members. Schedules from Q. Aird, Hardgate, Dalbeattie, N.B. **Entries close September 2.**

**September 26, at Horniman Hall, North End, Croydon.**—Exclusive Show of Honey, Wax, Hives, Bees, &c. Increased prizes. Six Open Classes. Judge, Mr. W. Herrod, F.E.S. Schedules from A. Wakerell, 21, Mansfield Road, Croydon. **Entries close September 16.**

**September 27, at Altrincham.**—Honey Show, in connection with the Altrincham Agricultural Show, the largest one-day show in the Kingdom. Classes open to United Kingdom. Classes for Trophy of Honey, for Best Hive, Observatory Hive with Bees and Queen, twelve Jars of Extracted Honey. Classes open to County of Chester, for Run and Section Honey, Wax, &c. Special Classes for Cottagers, and Special Classes for Society's District. Several Special Jubilee prizes. Schedules from Mr. J. Herbert Hall, 2, Dunham Road, Altrincham. **Entries close September 9, and at extra fees September 13.**

## Notices to Correspondents.

**IGNORANT (Hexham).**—*Number of Bees in a Hive.*—In the month of June there are usually from 40,000 to 50,000 bees

in a good colony; in the winter-hive about 25,000.

**A. W. (West Bromwich).**—*Using Draw-out Combs.*—If the bees did not die of disease you could use the combs, but if there is the slightest doubt, it would be unwise to do so. Comb foundation is so cheap that personally we should prefer to avoid risk by using new frames of foundation.

**C. J. H. (Northolt).**—*French Bee Paper.*—We do not know of a French farming and bee paper combined, but a good journal on bees is *L'Apiculteur*, address: Editor, 28, Rue Serpente, Paris.

**W. H. RATTENBURY (Devon).**—*Queen-mating.*—We see no reason why the plan you give should not be successful, but cannot say who advocated it in BEE JOURNAL.

**NOVICE (Holmfirth).**—*Living Swarms.*—Queens do not fly abroad, except when taking their mating flight. You may possibly have been mistaken.

### *Suspected Disease.*

**S. B. H. (Horsham).**—Bees are suffering from "Isle of Wight" disease, and we should advise you to destroy them at once.

### *Honey Samples.*

**KÜTTA (St. Asaph).**—Your second sample is a very nice honey; good in all respects. Like the other, it will granulate quickly.

**F. J. A. (Parracombe).**—No. 1 is the best for show purposes.

**M. S. (Bridgnorth).**—No. 1 is a medium honey, gathered principally from clover; No. 2 is from fruit blossom, and would be classed as a dark honey. Both are good enough to show in their respective classes.

**BEE (Paignton).**—The sample is from mixed sources, and is a very good medium colour honey. As soon as all the scum has risen to the top it can be bottled. (2) Leave two of the pollen filled frames, removing the rest for melting down. Supply draw-out combs if you have them, certainly.

**WILLMOTT (Higham Ferrars).**—The honey is a very good sample in all points, and has been gathered mainly from clover. Many thanks for your kind appreciation; letters such as yours encourage us to persevere in our work for the welfare of bee-keeping.

**E. E. B. (Yorks).**—Nos. 1 and 2 are excellent samples from white clover. No. 2 is quite good enough for showing, but should first be cleared of the air-bubbles and small particles of wax. No. 3 is not dense enough; it has been gathered partly from limes.

**H. W. (Leicester).**—The honey is mainly from clover, with a little ragwort in it. If the colour is brightened by warming it will do to show in medium class.

**Special Prepaid Advertisements.****Two Words One Penny, minimum. Sixpence.**

Orders for three or more consecutive insertions entitle advertisers to one insertion in "The Beekeepers' Record" free of charge.

Trade advertisements of Bees, Honey, Queens, and Bee goods are not admissible at above rate, but will be inserted at 1d. per word as "Business" Announcements, immediately under the Private Advertisements. Advertisements of Hive-manufacturers can only be inserted at a minimum charge of 3s. per ½ in., or 5s. per inch.

**PRIVATE ADVERTISEMENTS.****WANTED**, 12 lots of Healthy Driven Bees, 4s. per lot.—LUNNUN, Fyfield, Essex. 1 37**DRIVEN BEES WANTED**, any quantity.—Address, "BEES," Abington, Lanarkshire. 1 36**CONQUEROR HIVES WANTED**, single or double, must be guaranteed healthy, state price.—GARRETT, Hillview, Knock, Belfast. 1 38**WANTED**, Extractor, in good condition, must be cheap.—Particulars to J. PEARCE, Hollands-lane, South Ockendon, Essex. 1 20**PRIZE HONEY**, finest grade, glazed sections, in perfect condition, price, delivered, 12s. per doz.—BYLES, Redenham, Andover. 1 2**BEST SCOTCH SECTIONS**, 10s. 6d. per doz.—C. GARFITT, Barnside, Coupar Angus, Perthshire. k 76**WANTED**, 10-frame Observatory Hive; exchange folding Premo ¼ plate film camera, or sell £1. 1s.—PINKNEY, Sleights, Yorks. 1 32**FINEST ENGLISH HONEY**, 16s. 6d. per 28lb. tin; sample, 2d.—DUTTON, Terling, Essex. k 72**CLEAN full-weight Sections**, bean and clover, 8s. 6d. doz.; 6 doz, 14oz., finest quality clover sections, 8s. 6d. doz.—NORTH, Cressing, Braintree, Essex. 1 16**ENGLISH HONEY**, good quality, dark colour; sample 2d.; what offers? also Cottage Ripener with Strainer, 4s.; and drawn shallow Frames, 7s. doz.—HASTINGS, Welcombe, Stratford-on-Avon. 1 17**EXTRACTOR**, 24 by 16, with Honey Valve, almost new, 10s.—J. MORRISON, 75, Woodstock-road, Sheffield. 1 18**PURE LIGHT CAMBRIDGESHIRE HONEY**, 68s. per cwt.; sample 3d.; also 9 doz. light-coloured Sections, 10s. doz. F.O.R.—W. JOCKMAN, Sidney Farm, Cambridge. 1 19**BEES**—5 Healthy Stocks in W.B.C. Hives, 4 Section Racks, Smoker, &c., £5 10s., or 25s. each.—DRAKE, 15, Seaforth-avenue, New Malden. 1 22**SPLENDID SECTIONS**, average lb.; also run. What offers?—ALLNUTT, Wittenham, Abingdon, Berks. 1 26**FOR SALE**, 2 Stocks Bees on 10 frames, 1911 Queens, £1 each.—FARMBOROUGH, Hazlemere, High Wycombe. 1 27**FOR SALE**, 200lbs. SEALED HONEY in shallow frames. What cash offers?—REV. BRADLEY, Chapel Hill, Margate. 1 28**1 CWT. FINEST LIGHT HONEY**. What offers?—H. ROGERS, Hatherop, Fairford, Glos. 1 30**A FEW doz. first-class Sainfoin Sections**, neatly glazed, 10s. per doz.; also Extracted Honey in 28lb. tins, at £3 per cwt.—BELL, Bardwell Manor, Bury St. Edmunds. 1 31**FINE SECTION HONEY**, 10s. doz.; Extracted, in screw cap jars, 10s. doz.—A. CROSSLEY, Skewbarrow, Kendal. 1 35**FOR SALE**, 4cwt. Light Extracted Honey, 56s. cwt.—PAIGE, Station, Safron Walden. 1 34**OVERSTOCKED**.—6 Stocks Bees in W.B.C. Hives, guaranteed healthy; 1910 Queens, good form for heather, natives, excellent comb builders; deposit.—H., 25, Bedford-street, Strand, W.C. k 95**TWO BEE-HIVES** with ten Standard Frames, foundation, ready for driven Bees, 12s. 6d. each.—SAUNDERS, Thelma Stetchford, Birmingham. k 92**FINEST SCOTCH CLOVER HONEY**, £3 cwt. Sample 3d.—T. RULE, Summervale, Annan, Dumfriesshire. 1 8**HONEY**, first quality sections, 9s. 6d. dozen, 3 dozen 27s., cash with order.—R. COUSINS, The Rosary, Misterton, Gainsborough. 1 9**NEW SEASON'S EXTRACTED HONEY**, fine screw cap, in bulk 60s. per cwt., tins included; 1lb. srew cap glass jars, 8s. per dozen.—AVERY, Deverill, Warminster. 1 2**GUARANTEED** healthy secondhand Hives, fitted with frames, drawn out combs, cheap.—BARBER, Expert, Mere Farm Apiary, Chelford. k80**QUEENS**, 1911.—2 Surplus Fertile Black, 3s. each.—F. BIGGE, Tyburn, Birmingham. 1 39**BUSINESS ADVERTISEMENTS.****1911 QUEENS**, black, 3s. 6d. each, tested layers.—L. NORTON, Ferncliffe, Cleve Hill, Gloucestershire. k 90**SPRING TRAVELLING CRATES** for 12 or 24 Section, 1. 6d. and 2s. each; Boxes with corrugated cases, for 6, 12, or 24 Sections, or 1lb. bottles, 1s., 1s. 6d., and 2s. each.—H. CRESSY, Friary Mill, Dorchester. 1 25**SECTIONS**, new, wanted, by the HONIELADE Co., 23, Moorfields, E.C. 1 24**HEALTHY DRIVEN BEES**, with Queen, 6s. lot; Queens, 2s. 9d. each.—BRADFORD, Expert, Worcester. 1 33**SECTIONS OF HONEYCOMB** wanted to purchase for cash.—T. SMITH and Co., Cambridge-street, Hyde Park. W. k 13**PROLIFIC HYBRID QUEENS**, 15 years' experience, fertile, 4s.; virgins, 2s.—MOORE, 10, The Avenue, Bedford. 1 23**DRIVEN BEES WANTED**, 1s. 6d. lb. cash, boxes returned carriage paid.—A. W. GAMAGE, Ltd., The Holborn Apiary, Church End, Finchley, N.**NEWPORT**, Isle-of-Wight, June 20th, 1911. To Mr. J. B. Goodare, Wednesfield.—"Dear Sir,—The 2 Queens you supplied me with last year have done splendidly; I had two strong swarms from both. Please forward me another, and oblige." The above speaks for itself.**100 LOTS OF DRIVEN BEES**, commencing August 7th, 1s. 6d. per lb.; September, 1s. 2d. Cash with order given preference.—SOUTHCOPT, Gittisham, Honiton.**HEALTHY DRIVEN BEES**, with queen, commencing August 1st, 4s. 6d. per lot; boxes to be returned; orders rotation; cash with order.—T. PULLEN, Ramsbury, Hungerford. k 83**1911 CARNIOLAN QUEENS**, mated in Carniola, Austria, 4s.; Swiss, 5s.; Italians, 3s.; delivery in one week.—F. VOGT, 32, Selwyn Avenue, Higham's Park, Essex.**1911 QUEENS**.—Golden Italian fertile Queens, guaranteed healthy, puremated, vigorous, prolific, 4s. each; specially selected, 7s. 6d. each; prompt delivery.—J. B. GOODARE, Woden Apiary, Wednesfield, Wolverhampton. k 54



## Editorial, Notices, &c.

### MALIGNANT DYSENTERY.

Since the publication of Dr. Zander's researches in 1909 respecting dysentery ("B.B.J." 1909, page 421) investigations have been carried on by Dr. Maassen in Dahlem, which we reported in the "B.B.J.," 1910, page 483. Dr. Maassen corroborated the findings of Dr. Zander with respect to *Nosema apis* being the cause of malignant dysentery. He found the parasite very widely distributed, and that many of the colonies had entirely succumbed to the disease, but, strange to say, also some that did not show the usual characteristics of the malady. He also pointed out that the parasite may be prevalent in small numbers in healthy bees without multiplying, and only become dangerous when the health of the bees becomes impaired. In Switzerland also Dr. Burri has been investigating the disease, and although he does not find it quite so prevalent as it is in Germany he is able to confirm Dr. Zander's findings. He points out that although ordinary dysentery is caused by the bees not being able to void their excrements, the malignant form is due to the presence of the protozoon *Nosema apis* Zander. Strange to say, he has also found cases with all the symptoms of malignant dysentery in which the protozoon could not be detected. The investigations have been further carried on this year, and at the Conference of Bee Inspectors at Zug, reported in the *Schweizerische Bienenzeitung*, Dr. Nussbaumer, who assisted Dr. Burri in his investigations, stated that they were able to confirm Dr. Zander's findings. The experiments show that Dr. Zander was right in differentiating dysentery as ordinary non-infectious, and malignant or infectious. The former is well known and is caused by improper food, disturbance of bees in winter and too long confinement in the hive without a cleansing flight. In this no bacteria or spores are found. It is quite different with malignant dysentery which is caused by the protozoon. This grows in the chyle stomach and lives on the cell substance. The growth and increase of the parasites are so rapid that soon all nourishment is exhausted and they turn to spores. These are found in dead bees and in the excrements. It was pointed out that in attempts to cure the disease it was important that dead bees and excrements should be removed. In other respects the same remedy is recommended as for foul brood. There is no cure for badly infected colonies, and these should be destroyed by burning sulphur, the bees, combs, and frames, etc., being burned, and the hives thoroughly disinfected. Slightly affected colonies in the

early stages of the disease can be treated as for foul brood by being made into artificial swarms and made to build new combs. Care should be taken that the drinking places are clean, so as not to convey the disease by means of these. It was stated by Dr. Nussbaumer that 10 per cent. of the bees in every apiary contain *Nosema* without the colonies necessarily having malignant dysentery. It is just the same as with diphtheria or tubercle bacilli in man. The stronger constitutions are able to resist disease, even in the presence of these germs. It is also mentioned that much of the disease was undoubtedly due to the inclement weather of 1910, which had so disastrous an effect upon bees and had impaired their constitutions, and that the fine weather of this year and abundant income of honey and pollen has been the means of curing many affected colonies.

It will be remembered that Dr. Zander thought possibly May Pest was only another form of the *Nosema* disease. Dr. Burri has not yet been able to come to any definite conclusion on this point, as the investigations have so far only given negative results, but he is continuing the work. It is, however, probable that all the diseases which we at present class as undetermined, such as May Pest, Paralysis, and Isle of Wight disease, will be found to be more or less closely related to one another, as they all have certain symptoms in common, although they vary in slight details. Such diseases have broken out as epidemics from time to time and have entailed enormous losses, but like all epidemics they gradually wear themselves out. If such were not the case bee-keeping would have been exterminated long since.

### GLAMORGAN B.K.A.

#### ANNUAL SHOW.

The annual show of the Glamorgan Beekeepers' Association was held at Cardiff on July 26th and 27th. The number of entries constituted a record, and the competitors were representative of all parts of the country. The season has been unusually favourable, and large quantities of honey were disposed of by those exhibitors who had brought surplus stores. The exhibits were judged by Mr. S. Jordan (Bristol), who was assisted by Mr. Freeman Gravid (Cardiff), and Miss Forsdike, who undertook the duty of judging the food made from honey. The Rev. H. Morgan, county bee-keeping expert, gave interesting lectures and demonstrations with live bees at intervals on both days, and also rendered valuable assistance in consulting and advising beekeepers who needed information on the management of their bees. The judges' awards were as follows:—

## MEMBERS' CLASSES.

*Twelve 1-lb. Sections.*—1st, S. Lewis, Bridgend; 2nd, D. George, Merthyr Mawr, Bridgend.

*Three Shallow Frames of Comb Honey.*—1st, R. Morgan, Cowbridge; 2nd, E. Humphrey; 3rd, E. Church, Cardiff.

*Twelve 1-lb Jars Extracted Honey (light).*—1st, D. George; 2nd, E. Church; 3rd, R. Morgan.

*Six 1-lb. Jars Extracted Honey (medium)*—1st, C. Hood, Cowbridge; 2nd, S. Wakeford, Dinas Powis; 3rd, T. Richards, Whitechurch.

*Six 1-lb. Jars Extracted Honey (dark).*—1st, W. Morgan, Llantrisant; 2nd, S. Wakeford.

*Bee-swar.*—1st, D. George; 2nd, R. Morgan; 3rd, E. Church.

*Articles of Food Containing Honey.*—W. T. Gunter, Cowbridge; 2nd, B. Morgan; 3rd, F. Gravil, Cardiff.

*Bee Candy.*—1st, F. Gravil; 2nd, W. Gunter.

*Observatory Hive.*—S. Wakeford.

## SPECIAL PRIZES.

(For honey gathered in districts outside the vale of Glamorgan, Bridgend and Gower.)

*Six 1-lb. Sections.*—1st, T. Davis, Kenfig Hill; 2nd, S. Lewis; 3rd, W. Lewis; v.h.c., W. Morgan; h.c., D. Rees, Kenfig Hill.

*Six 1-lb. Jars Extracted Honey.*—1st, D. Rees; 2nd, W. Brook, Kenfig Hill; 3rd, T. Jones, Nantgarw; h.c., T. Davis; c., G. Braddick, Cardiff.

## NOVICES' CLASS.

*Six 1-lb. Sections.*—1st, W. Brook; 2nd, T. Richards.

*Six 1-lb Jars Extracted Honey (any colour).*—1st, W. Brook; 2nd, Mrs. Dare, Llanharan; h.c., A. Church; c., T. Jones.

## OPEN CLASSES.

*Collection of Appliances.*—1st, John Hibbert and Son, Cardiff; 2nd, E. Burt, Gloucester.

*Twelve 1-lb Sections.*—1st, D. George; 2nd, H. J. Moore, Badstock; 3rd, C. Kidner.

*Extra Prizes.*—2nd, R. H. Baynes, Cowbridge; 3rd, J. Fairall, Hellingly, and C. Dyer, Compton, Berkshire.

*Twelve 1-lb. Jars Extracted Honey (light).*—1st, W. Gunter; 2nd, D. George; 3rd, H. J. Moore. *Extra Prizes.*—1st, H. R. Saunders, Thetford; 2nd, R. H. Baynes; 3rd, R. W. Lloyd, Thetford.

*Bee-swar.*—1st, R. Morgan; 2nd, D. George; 3rd, S. Wakeford.

*Six 1-lb. Jars Extracted Honey (light).*—1st, R. Morgan; 2nd, S. Wakeford; 3rd, A. Church and D. George.

*Six 1-lb. Jars Extracted Honey (dark).*—1st, R. Edwards, Lisvane; 2nd, D. George; 3rd, S. Wakeford.

The "Small-holder" Presentation Clock was awarded to Mr. David George, Merthyr Mawr, Bridgend.

In the course of the day three candidates were examined for experts' certificates.—W. J. WILTSHIRE, Hon. Sec.

## REVIEWS OF FOREIGN BEE JOURNALS.

By "Nemo."

*How long does it take a bee to get a load of pollen?*—M. Otto Deng, who has made careful observations, says in *Practischer Wegweiser* that it takes a bee from six to eight seconds to get the pollen from one heather blossom. In five to six minutes after visiting forty blossoms one can perceive the first traces of pollen in the baskets, on the hind legs of the bee. In eighteen to twenty minutes the load is completed, and in four to five minutes afterwards the bee, which had been marked with a red spot, had returned from its hive 300 meters away, to recommence its arduous work.

*Protecting Hives from Ants.*—The persistence with which ants endeavour to overcome obstacles in their way to getting into hives is related by Signor V. Asprea in the *Apicoltore* of Milan. When he began bee-keeping, in order to prevent ants entering his hives he placed the legs of the stands in basins of water. One morning he was surprised to find a string of ants coming and going on his hives, and wondered how they had got there. On close examination he found the water in the basins covered with a film of dust which he presumed had been placed there by the ants. Watching them he found that on coming to the edge of the water the ants hesitated for a moment and then stepped on to the dust and got over without wetting their feet. Admiring their ingenuity Signor Asprea replaced the water by turpentine, believing that this would be a remedy, but what was his astonishment to find, a few days later, that the ants had placed small bits of gravel in the liquid, and thus made stepping stones which enabled them to get at the hive. He, however, found a preventive in a mixture of oil and carbolic acid which effectually kept them away.

*Making Artificial Swarms.*—M. N. Noblecourt describes in *L'Abeille de l'Aisne* a simple method of making an artificial swarm, which he recommends for those who wish to fill up gaps made by winter losses, or queenlessness. He says that about the 10th of July, strong hives can be divided so as to make two strong colonies from one. For this purpose hives should be selected that are crowded with bees noted for their industry, and other

good qualities. It is only necessary to divide the hive in two, without troubling about the queen, which at this season it is difficult to find. Half the frames with the bees are allowed to remain in the original hive and the remaining space is filled with frames fitted with comb foundation. The other half of the frames, with the adhering bees, are put into another hive and the space filled out in the same way. It is necessary to put a few more bees into the hive that is removed to one side, as the old bees will return to their original stand. Care must be taken that there are eggs and young larvæ in each part, so as to give the bees the chance of rearing a queen. Eight to fifteen days later it is desirable to add a comb of sealed brood to each colony. (These combs can be taken from other populous hives.) If there is still a little pasturage in August the two colonies will be able to earn their living. When inspected in September, if they are found to be short of stores, these may be supplemented by feeding with sugar syrup.

*Foul Brood Insurance.*—M. Leuenberger, the chief of the insurance scheme of the Swiss Bee-keepers' Society, presided at a meeting of Inspectors at Rosenberg, Canton Zug, and gave an account of the first year's working of the Federal Act which is fully reported in the *Schweizerische Bienenzeitung*. The Cantons have delegated their powers to the Swiss Bee-keepers' Society, who are authorised to administer the law. By this every one is required to notify the presence, or the suspected presence, of foul brood in his apiary, but only the members of the Society are entitled to compensation. No purchases of bees can take place without a health certificate, and the purchaser who does not conform to this condition forfeits all right to compensation in the event of foul brood being found in his apiary. Foreign bees are excluded, as a certificate cannot be obtained for bees purchased outside the country.

*Bees Transporting Eggs.*—From time to time we have evidence of bees transporting eggs, and in the *Praktische Wegweiser*, M. Mattutis describes his experience of such a case during this season. He says that he decided to allow the bees in a skep to transfer themselves into a frame hive in the way recommended in the "Guide Book" (page 150). On April 17th, he prepared a hive fitted with frames of built-out combs partly containing honey, and on this he placed the skep, packing it round carefully. On examining the hive on May 13th, he found that the queen had gone down and there was already a considerable quantity of brood. He then placed an excluder over the frames and on this two shallow-frame supers. As

the skep contained a good deal of brood and a great many drones, he placed this above the supers, putting another excluder between them and the skep. Assuming that all brood would have emerged he removed the skep on the 18th June. On examining it he was astonished to find about fifty cells of brood, some of which was already capped, as well as two queen cells. The latter were not yet capped but already contained larvæ in Royal jelly. As the queen had left the skep at least five weeks, the only conclusion M. Mattutis could come to was that the workers had transported the eggs through two supers and two excluders, especially as careful examination showed that there was no queen in the skep.

#### HELPFUL HINTS FOR NOVICES.

By W. Herrod.

*Saving and Extracting Wax.*—Truly it is the small things which as a rule pay best. We have heard of fortunes being made by individuals who have collected insignificant waste materials, and sold them. Without exaggerating in the least I am certain there are hundreds of pounds wasted annually by the carelessness or thoughtlessness of bee-keepers in the matter of saving wax. As a youngster I had a good grounding in this from the late John Howard. Though each year he handled some tons of wax in small packages, nothing annoyed him more than to see the smallest particle wasted in any shape or form, his caustic remark to any careless workman whom he saw wasting wax being "You are throwing my profit into the gutter." Even the boards upon which we worked were boiled at the end of the season to reclaim the wax which had been spilt upon them.

The first consideration is a proper receptacle in which to save the wax, and for this purpose, if possible, a metal one should be obtained, and it should have a tightly fitting lid so as to exclude moths of all kinds, especially wax moth.

I find an old hundredweight carbide tin excellent for the purpose and these can often be begged or obtained for a few pence. Failing this, a good air-tight wooden box can be used. The receptacle should be placed in some position where it is easy of access, and whenever a piece of comb, no matter how small, is removed from the hive it should be taken straight away and put into the box or tin ready for melting down when time can be found for the process. So many times have I seen waste going on thoughtlessly that it may not be out of place to give a few instances. Old black combs from brood-chamber, thrown away as not worth the trouble; scrapings from the top of frames when spring-cleaning these,

are usually thrown on the ground instead of being collected; small pieces of comb built occasionally between the brood chamber and outer case in a W.B.C. hive, on account of the bees obtaining access through the brood chamber not being pushed right up to the bridge-slip at the front; comb built on the dummy board; comb built in candy box, generally thrown away altogether; combs and unfinished sections which break down in the extractor; small pieces of foundation cut from the top of split in sections when filling up; corners from sheets of brood foundation when filling into split-top frames and also the top edge when cut level to bar; wax spilt on the floor, from the smelter or spoon, when fixing foundation to a plain top bar; and so I could go on, but the above will suffice to show that in many unsuspected ways money often runs away.

After saving the wax comes the matter of extraction. The methods for this work are two only—by the heat of the sun (Solar) and by steam or boiling water. Wax should never come in direct contact with heat; this is well known to bee-keepers of any experience. Yet I have in mind a book, written in recent years, where it is advised to put the wax in a jar in the oven; the novice, reading and following this, would be led astray, for, as sure as this is done the colour of the wax will be spoilt, and very often the texture as well.

There is no doubt that the simplest and best method of extracting is by the "Solar"; it has many advantages, as follows: No discolouration of the wax takes place, in fact, the colour as a rule is improved by the bleaching; by being carried out in an air-tight chamber the full aroma is retained; if allowed to remain long enough every particle of wax is separated from the dross; no residue is left for scraping away from the underside of the cake; it requires no attention beyond putting in the combs and taking out the cake of wax; there is no cost for fuel for heating. If a solar extractor is used there is no need for a storage receptacle, as if it is placed at the entrance to the apiary all spare pieces can be put into it on leaving after the completion of the work at the hives. The one drawback to this system is our climate; sunshine is absolutely necessary. This season we have had an abundance, and in those apiaries where a "Solar" is possessed there is not the slightest excuse for unextracted wax to remain on hand even though it be the accumulation of years. For the past few seasons only a little work has been possible with the "Solar," and I well remember the remark of a customer at the Royal Show to an appliance dealer who was trying to sell him a solar extractor (it was raining hard at the time). He said, "I will take

it if you will sell me some bottled sunshine to use with it."

To work properly the solar should not be filled too full. I find the most satisfactory work is obtained by just covering the bottom of the tin receptacle with the comb. After it is well melted the residue should be turned over and allowed another heating, then cleared out; this is carried out better while the extractor is still warm.

The cost of a "Solar" is often a consideration, but it will soon repay itself in the saving of time and fuel, while at the same time it can be made use of in another way when not being used for its original purpose—granulated honey can be liquefied in it. Where only a few hives are possessed then a good makeshift is an ordinary garden light; obtain a tin of the required size, put a partition of perforated zinc across about three inches from one end, place the combs in the larger portion and put in a tilted position under the glass, when the work will be carried out efficiently, although it will occupy a little longer. Failing this just place a sheet of thick glass over the tin and it will work all right. In the garden-light, care must be taken to exclude bees or robbing will be encouraged.

To extract by means of steam a Gerster Extractor should be purchased, or failing this the combs placed in an ordinary potato-steamer when the wax will percolate through the holes.

Another method is to tie the combs in a muslin bag and sink in water in a copper by means of weights, boil well, when the wax will rise to the top and can be skimmed off. By the latter method it is almost impossible to obtain all the wax, therefore there is a certain amount of waste. In all cases where water is used it must be rain water. The drawback to the copper method is the difficulty in getting it clean again after the operation, which often results in trouble with the head of the domestic department. This I know from experience.

---

## Queries and Replies.

---

[8175] *Honey Cake Recipes. Exhibiting Honey.*—I should be obliged if you would (1) give a good recipe for a honey-cake, suitable for showing. I have some dark honey, which I want to show; it has been extracted, of necessity, for some little time (a fortnight perhaps) and seems determined to granulate. It is now just beginning to do so. (2) How can I stop it, or reduce it to liquid form again, without hurting its quality for

showing purposes. I noticed in the *JOURNAL* of July 20th, an answer to one of your correspondents of the name of W. H. W., Harlington, about faking honey, &c. I think your answer might be made a little more explicit, as it seems plain that W. H. W. is either not a bee-keeper at all, and, therefore, not a judge of the case, or else is a producer of very poor honey, and consequently jealous of people who have a good thick sample. I have plenty of honey now, of which it might be said that "it will hardly leave the pot when inverted," and it is impossible to extract the combs clean, except when warm off the hives. I think that a little explanation might be given of the words: "We certainly should not disqualify honey for its consistency if it were good in other respects." I have always understood that, provided the flavour and aroma are good, the denser the honey is the better. Is this not so? Supposing two samples were precisely alike in every respect, except density, but one was extremely thick while the other was only ordinary, would the thick not have preference, or is it better to have honey only moderately dense? It's easy enough to get thin honey, but more difficult to get it nice and thick in my experience, which is not a very long one, though I have been through the bee-keeping mill during the last five or six years. Does W. H. W. not mean to hint that there was glucose in the honey he referred to in his letter to you? If so, of course, he is charging the judge with not knowing his business, and that is all.—R.B. M., Northants.

REPLY—(1) 4 eggs, 5 cups of flour, 2 cups of honey, 1 teacupful of butter, 1 cup sweet milk, 2 teaspoonfuls cream of tartar, 1 teaspoonful soda, 1lb. raisins, 1lb. currants,  $\frac{1}{2}$ lb. citron, 1 teaspoonful each cloves, cinnamon, and nutmeg. Bake in a large loaf in a slow oven. This will be nice months after baking, as well as when fresh. *Honey Sponge-cake* is made as follows:—One large coffee-cupful of honey, 1 cup of flour, 5 eggs. Beat yolks and honey together, beat whites to froth; mix all together, stirring as little as possible, flavour with lemon juice or lemon extract. (2) Place the honey in a vessel of water, and putting this over the fire, heat till the finger cannot be borne in the water for more than half-a-minute. Keep at this temperature (no higher), until the honey is dissolved, then remove it from the fire and allow it to cool without removing from the water. (3) If you refer to *BEE JOURNAL*, June 8th, page 224, you will there see the original letter from W. H. W., Harlington, and our comments thereon. Our notice in *BEE JOURNAL* of July 20th. was in reply to a further letter,

which was just as far from the point at issue, and for that reason we did not think it sufficiently interesting for publication. His contention is that the thickening of honey by the removal of the excessive moisture, either naturally on the hive or by artificial means, is "faking." Your experience proves that he is wrong, and that dense honey can be obtained from bees naturally. If two samples of honey were exhibited exactly equal in every respect, except density, then most certainly the more dense exhibit would be placed first. Although he does not say definitely that adulteration takes place, we do not for one moment think he wished to insinuate such was the case. His letter (8178) proves that he lacks knowledge and experience, for he says: "I have never exhibited." If he were to try, no doubt he would soon find how groundless his charges are.

[8176] *Risk to Horses*.—A friend of mine has taken a house at the end of a new road a little way out of town. The houses are built on the edge of a large field; beside my friend's house there is a piece of waste land belonging to the owner of the houses, and my friend has made quite a nice garden of this and stocked it well. The fence which the builder put round the land consists of two strong wires stapled to wooden posts. A man has rented the field and lets in horses to graze, which have got under or over the fence, broken it down repeatedly and eaten everything on the ground. He says he is not liable as it is the property owner's place to properly fence it. My friend says he will not go to the expense of fencing now, as his garden produce has all been destroyed, but has told me I may keep bees on the piece of ground, and the owner of the house acquiesced. Now if I put hives there and a horse breaks through again and gets stung and incapacitated for a time who would be liable? I will tighten up the wires and naturally try, for my own sake, to keep the horses off, but the man who rents the field is a veritable "hog," and deserves no consideration whatever. It is a splendid locality for bees, and my friend living on the spot would keep his eye on them. It would enable me to commence bee-keeping which I cannot do here. The only connection I have with bees now is reading the *Journal* which is still my great delight. If you could kindly give me a word of advice on the point through the columns of your paper I should be very grateful. I enclose a rough plan of the ground.—T. M. A., Manchester.

REPLY.—You would certainly be liable for any damage done to the horse if it breaks in where the hives stand, as it is the owner's place to properly fence in the

ground for keeping out cattle. If the hives were placed close to the brick wall and the fence strong enough to keep out cattle, there would be little risk, which, however, could be covered by insurance.

[8177] *Dead Bees in Section-rack.*—I enclose a box of dead bees. If you can say what caused their death I shall be grateful. On Wednesday last I removed the top rack of sections, and found quite a pint of dead bees, but thought they had got trapped in the rack at the rear of the sections. I worked them out with my pocket knife, and probably spilled a few over into the body-box; but every night after sun-down, on opening the hive, I find about double the quantity of bees sent, usually a few dying bees with them; a few living bees are always seen which appear to be in the act of carrying the dead bees up on to the top of the quilts, where I find them. Why do they do this rather than carry them out of the hive? There is no reason why the bees should not return to the body-box if they wished to do so, as I have since Wednesday purposely left a space clear of quilts behind the division-board, so that the bees are not trapped. I have 42lb. of honey from this hive, all very dark sealing. Perhaps I left the supers on too long.—W. R. H., Oxford.

REPLY.—The bees have died of starvation, probably through not being able to find their way back; they are robbers. Their bodies are stripped of hair either through fighting or in their endeavour to get through some small opening. You should have wrapped all down snugly, so there was no possible chance of escape.

[8178] *Bees Clustering Outside Hive.*—I should feel obliged if you will enlighten me as to the working of a thirteen-bar hive of bees I bought at the end of last year. This being my first stock, I am not exactly in a position to know what should be done. At the beginning of the season, the hive seemed to be a particularly strong one, and the bees appeared to work splendidly up till June 25th, but after that date they seemed to cluster at the entrance, and during the wet, dirty weather, after staying out there all night, they seemed to be unable to move in the morning, consequently the honey, which has been ready since June 26th or 28th, has been left unsealed. I thought that they had insufficient work to do, and on July 12th I took out ten sections, and replaced with ten empties, which they have hardly touched.—P. L., Dumbarton.

REPLY.—You should have given a second rack of sections in June. Probably the

brood-nest is choked with honey, and the queen has ceased laying. Very little nectar is coming in now on account of the drought.

[8179] *Removing Surplus.*—I should be very much obliged if you would say in the "B.B.J." whether the following would answer. After taking off a super of honey, one usually wants in a day or two to remove the super-clearer, and put back the quilts, but the bees are terribly bad tempered in spite of smoke and carbolic cloths. Would it be a good plan to put an empty hive by the side of the one whose honey is to be taken, put the super clearer over the empty brood-chamber, and the honey supers over that, and leave them for a night, so that the bees would fly back to their own hive on getting through the bee-escape. At the same time the quilts might be put back on the original hive, and also a feeder full of syrup, so that the bees need not be disturbed again for a good while. (2) I often read in the "B.B.J." about cures for stings. I was poisoned all over by a sting on the thumb last year, and was very bad indeed. The doctor told me the best thing to do was to drink as much water and bi-carbonate of soda as possible, in the proportion of a teaspoonful to a tumbler full of water. I have found this very effectual since, and thought it might be useful to others.—E. E. B. (Boston).

REPLY.—If you subdue the bees by blowing smoke in at the entrance there should be no difficulty in removing the escape board; we would not recommend your plan.

[8180] *Swarming Extraordinary*—On May 15th last a large swarm issued from one of my hives, a cast on May 22nd, and a small ditto on the following day. I have since taken 20lb. section honey from this hive (on July 12th) after having another large swarm on the 6th inst., according to the authority of my gardener (I was away from home at the time). Is it unusual to have two large swarms from one hive in the same season? I may say that upon examination of this hive, on the 12th inst., I found five empty queen cells. The swarm of July 6th was hived on ten frames, and I now find all comb built out and honey in every one of them, sealed up and in fine condition, and I intend putting on a rack of sections. Is this rapid building up unusual? A neighbour who hived the swarm says it practically filled the skep. I have so far this season taken 154lb. honey from three hives, the largest yielding 77lb., and still working hard. A reply through your esteemed journal will much oblige.—H. J. E., Broxbourne.

REPLY.—If true it is a most unusual occurrence, and we think your gardener

must have made a mistake. There is nothing unusual in so favourable a season in the rapid building up of the swarm.

[8181] *Various Queries*.—I shall be much obliged if you will tell me in the **BRITISH BEE JOURNAL** (1) What is wrong with the enclosed sample of honey? I do not think it is eatable, but would it do for feeding the bees? (2) Can I use candy which has been in a hive infected with foul brood? The candy is medicated, and has been in a room disinfected with sulphur for twelve hours. (3) Can you tell me how I can clean india-rubber gloves which have been badly stained with propolis?—B. W. D., Sheffield.

REPLY.—(1) The honey is fermented, but after being well boiled, it can be used as food for bees. (2) It would be unwise to use the candy for healthy bees. (3) They can be cleaned with methylated spirit.

[8182] *Bees and Heather*.—Water for *Bees*.—Would you be kind enough to answer me two questions through the "B.B.J." (1) Do bees visit ling to any great extent? We have plenty of it hereabouts, but little or no purple heather. (2) I placed a vessel containing water within about 10ft. of my three stocks, arranging for the water to "drip" on to a board. The bees did not visit it, although there is no water that I know of nearer than half-a-mile. I also left the top of the vessel open, and put in "floats," but they still declined it. Thanking you in anticipation.—THOMAS A. EAGLES, Birmingham.

REPLY.—Yes, ling is the best honey producing source at the moors, honey from purple, or bell-heather not being of so good a quality. (2) The drinking vessel should be put out early in the spring, as soon as the bees begin to fly. They will then find it, and if kept filled they will visit it all the season. No doubt they found a supply somewhere else very early; this being the case they will continue to visit the same spot although you may place water nearer. It is also well to put a little salt in the water from time to time.

[8183] *A Novice's Queries*.—In this district there are few bee-keepers, and the novice must perforce find out a good deal for himself. I shall be much obliged if you will answer me the following in the "B.B.J." I have noticed, during this hot weather, that in the evening clusters of bees have gathered like miniature swarms on the alighting boards. Why is this? (2) Although the weather has been so favourable, the nights warm, and my bees very busy, the store of honey does not appear to increase. Is it likely that the honey flow has ceased owing to the con-

tinued drought? How can I ascertain? (3) I have been working for extracted honey. When one rack of frames has been completed, ought I to place the empty frames on top of these or below? I have done the former.—E. N. P. (Manchester).

REPLY.—(1) The hives require more ventilation, the heat causing the bees to hang outside. (2) Evidently the honey flow has ceased in your district, either through the drought or because there is no late flowering forage near. (3) The fresh super should be placed underneath the completed one.

### BEE-STING CURE?

That a little knowledge is a dangerous thing, is evidenced from the cutting below, sent by Mr. S. J. Leigh. Exactly the reverse is the case.

"Have courage to withstand the sting of a bee, although it is very irritating. Do not attempt to disturb it by harsh means, and it will withdraw its own sting doing but little harm, which can be cured by applying a little honey dissolved in vinegar or hartshorn and oil, and the pollen of the honeysuckle is a certain cure. It is not generally known that a bee can sting twice, a wasp only once, as it leaves its sting, and this is why it is more dangerous than a bee."—*Our Home*, July 9th, 1910.

## Bee Shows to Come.

**August 16, at Lancaster.** Lancaster Agricultural Society, in conjunction with the Lancashire B.K.A. 16 Classes for Honey, Bee Produce, and Bee Hives. Numerous specials, including 2 silver challenge cups, 12 silver and bronze medals. **Entries closed.**

**August 17, at Kenilworth Castle.** Show of Kenilworth Horticultural Society. Open Honey Classes. Prizes, 10s., 5s., 2s. 6d. Judge, Mr. G. Franklin. Very popular, and an old established exhibition. Schedules from E. H. Thornett, Secretary, Kenilworth.

**August 17, at Abington Park, Northampton.** Northants B.K.A. Annual Honey Show. Special Prizes for Open Classes, including one for single 1lb. jar of Honey. Entry free. Judge, Mr. W. Herrod. Prizes, 20s., 10s., 5s., 2s. 6d., and 1s. 6d. Schedules from R. Hefford, Kingsthorpe, Northants. **Entries close August 12.**

**August 23, at Radstock, Somerset.**—Honey Show in connection with the Radstock Horticultural and Farmers' Association. Open and gift classes. Write for Honey Schedule. B. M. Clark, Foxhills, Radstock.

**August 23, at Wedmore, Somerset.** In connection with the Annual Flower Show. Four Classes for Honey, Sections, Extracted, Shallow Frames, and Granulated Honey. Entrance fee, 6d. in each class. Schedules from G. H. Tatham, Wedmore, Somerset. **Entries close August 19.**

**August 23 and 24, at Shrewsbury.** Annual Show of the Shropshire Bee-keepers' Association, in connection with the Shropshire Horticultural Society's Great Floral Fête. Eight Open Classes

for Honey. Free entry for single bottle and single section. Schedules from S. Cartwright, Hon. Sec., Shawbury, Shrewsbury. **Entries close August 11.**

**August 24, at Wooler, Northumberland.** Annual Show of the Cheviot and Tweed Borders B.K.A., in connection with the Glendale Horticultural Show. Two open classes. Schedules from Robert Robson, Cheviot Street, Wooler. **Entries close on August 21.**

**August 26, at Kettering.**—In connection with the Kettering Working-Men's Horticultural Society's Show. Open Class for Honey, single 1lb. jar. First prize value 16s. Entries free. Schedules from Hon. Sec., W. Heritage, 114, King Street, Kettering.

**August 29, at Cartmel, Lancs.** Bee and Honey Show in connection with the Cartmel Agricultural Society's 29th Annual Show. Liberal prizes. Open classes. Schedules from J. N. Parker, Cartmel, near Carnforth.

**August 30, at Chester.**—Annual Show of the Cheshire B.K.A. in connection with the County Agricultural Show. Several Open Classes. Good prizes. Schedules, &c., from Hon. Sec., E. W. Franklin, Mouldsworth, near Chester.

**August 30 and 31, at Carlisle.**—Annual Honey Show of the Cumberland and Westmorland B.K.A. in connection with the Carlisle Horticultural Society's Exhibition to be held in the Covered Market, Carlisle. Schedules from G. W. Avery, Hon. Sec., Heads Nook, Carlisle.

**August 30 and 31, at Coventry.**—Annual Show of the Warwickshire B.K.A., in connection with the Warwickshire Agricultural Society. Separate tent for Honey, Wax, and Appliances. Open Classes. Schedules, &c., from J. N. Bower, Knowle, Warwickshire.

**September 6, at Deddington, Oxon.**—Show of the Deddington Horticultural Society. Open Class for Honey. Prizes, 10s., 5s., 3s., 2s. No entry fee. Schedules from Messrs. H. J. Harmsworth or A. A. Busby, Deddington. **Entries close September 1.**

**September 7, at Peterborough.**—In connection with Horticultural Society. County Association Class and four Open Classes. Schedules from G. T. Dunham, Albion Terrace, 32, Oundle Road, Peterborough. **Entries close September 1.**

**September 13, at Conway, N. Wales.**—Great Annual Honey Show in connection with the Conway Honey Fair. Open and local Classes. Schedules from J. Hughes, Town Hall, Conway. **Entries close September 6.**

**September 13 and 14, at Cambridge.**—Honey Show in connection with the Cambridge and District Red Cross Horticultural Society. Four Classes, open to all. To be held in the Corn Exchange, Cambridge. Schedules and particulars of Hon. Sec., E. F. Dant, Member of B.B.K.A., 52, Bridge Street, Cambridge. **Entries close Saturday, September 9.**

**September 14, at Castle-Douglas.**—Annual Show of South of Scotland Bee-keepers Association. Five open classes; Three 1-lb. jars extracted, 20s., 10s., and 5s.; three sections, ditto (Entry 2s.). 1lb. jar, also one section, 5s., 3s., and 2s. (Entry free, and exhibits retained unless otherwise agreed upon). Beeswax, 5s., 3s., and 2s. (Entry 6d.). Fourteen classes for members. Schedules from Q. Aird, Schoolhouse, Howwood, Renfrews. **Entries close September 2.**

**September 16 to 23, at the Agricultural Hall, London.**—Honey Show in connection with the 19th Annual Exhibition and Market of the Grocery and Kindred Trades. Liberal prizes. Open to all British Bee-keepers. Schedules from H. S. Rogers, Secretary, Exhibition Offices, Palmerston House, Old Broad Street, London, E.C.

**September 26, at Horniman Hall, North End, Croydon.**—Exclusive Show of Honey, Wax, Hives, Bees, &c. Increased prizes. Six Open Classes. Judge, Mr. W. Herrod, F.E.S. Schedules from A. Wakerell, 21, Mansfield Road, Croydon. **Entries close September 16.**

**September 27, at Altrincham.**—Honey Show, in connection with the Altrincham Agricultural Show, the largest one-day show in the Kingdom. Classes open to United Kingdom. Classes for Trophy of Honey, for Best Hive, Observatory Hive

with Bees and Queen, twelve Jars of Extracted Honey. Classes open to County of Chester, for Run and Section Honey, Wax, &c. Special Classes for Cottagers, and Special Classes for Society's District. Several Special Jubilee prizes. Schedules from Mr. J. Herbert Hall, 2, Dunham Road, Altrincham. **Entries close September 9, and at extra fees September 13.**

## WEATHER REPORT

WESTBOURNE, SUSSEX.

July, 1911.

Rainfall, 54in.	Minimum temperature, 43° on 4th.
Below aver., 179in.	Minimum on grass, 37° on 3rd.
Heaviest fall, 35in., 25th.	Frosty nights, 0.
Rain fell on 6 days.	Mean Maximum 76.7.
Sunshine, 372.1 hrs.	Mean Minimum 53.6.
Above average, 144.2 hours.	Mean temperature, 65.1.
Brightest days, 12th & 13th, 15.1 hours.	Above average, 4.9.
Dullest day, 24th, 7.4 hours.	Maximum barometer, 30.514 on 10th.
Sunless days, 0.	Minimum barometer, 29.683 on 1st.
Maximum temperature, 86° on 22nd and 29th	

L. B. BIRKETT.

## Notices to Correspondents.

**W. A. T. (Isle of Man).**—*Swiss Brown Natives.*—We have had no experience with these bees in England, but they are better suited than Italians to the climate of Switzerland, and are therefore preferred in that country. We would advise you to keep to the British bee.

**M. A. W. (Gravesend).**—*Quilt Coverings.*—(1) Some discretion must be exercised in using quilts. The "Guide Book," on page 38, recommends "a layer of unbleached calico or bed-ticking laid over the frames, and over this should be placed two or three layers of drugget or other suitable warm and porous material." Of course when the weather is hot less covering will do, and a layer of calico with one piece of drugget would be sufficient during the day, an extra piece being given at night. In winter four or five thicknesses of drugget would do no harm. (2) You must not dispense entirely with quilts in summer, but you can obtain ventilation by putting wedges in between hives and supers, allowing a space of an eighth of an inch between. The hive can also be raised a little in the same way from the floor-board. The roof and lifts can be placed in such a way as to admit of free ventilation. (3) We use felt for our quilts, such as is usually put under carpets. It is light, warm and inexpensive.



- O. Mc C. (Balbriggan).—*Obtaining Patent*.—It does not often pay to take out a patent for feeders as there are so many good ones already on the market. It would cost you £1 on application for provisional protection, £3 on filing complete specification, and £1 on notice of desire to have patent sealed. This would do for four years, before the expiration of which on renewal for the 5th year you would have to pay £5, and up to £14 for the 14th year. We thank you for your appreciation which we value as coming from so old a reader.
- M. E. S. (Perth).—*Taking Bees to the Heather*.—(1) It will be best to extract all unfinished sections before sending the bees to the heather. The empty drawn-out ones can then be used there. (2) The hive evidently requires ventilation. (3) If very weak it will be advisable to unite with No. 2 before taking to the moors, thus making one strong stock from which a larger amount of surplus will be obtained.
- W. W. R. (Dunster).—*Phenyle for Bees*.—In both the recipes the phenyle is used neat from the bottle.
- H. J. (Ilford).—*Queen Cast Out Dead*.—The queen is apparently an old one.
- SALOP (Lliverpool).—*Flight of the Drone*.—It is rather difficult to say exactly how far drones will go, but there is no doubt that they fly some distance. They leave the hive at any time during the day when it is warm, for exercise, and also for the fertilisation of young queens when they are reared.
- A. B. C. (Herts.).—*Variety of Bee*.—The bee is a queen of the British variety. She is an old one, and has evidently been deposited by the bees.
- A. C. TEW (Essex).—*Flowering Lime*.—The tree is the *tilia petiolaris*, or late-flowering lime.
- E. J. G. (Washingboro').—*Parasites on Bees*.—The reddish-coloured insects on the bees are a parasite called *braula cocca* or blind louse. The hive must be badly infested for them to be present in such numbers. The usual remedy is to smoke the bees with tobacco, and the parasites will drop off on to the floor-board, which can then be brushed and washed with a disinfectant. An interesting letter on this subject appeared in BEE JOURNAL of June 22nd (page 245).
- H. E. S. V. (Tewkesbury).—*Heather District*.—We cannot say, as we do not know the district. You had better write the Secretary of the Gloucester Bee-keepers' Association. Rev. F. H. Fowler, Barnwood Vicarage, Gloucester, for the information.
- ELTHAM (Kent).—*Utilising Driven Bees*.—It is quite possible to establish a stock of driven bees for wintering, if properly attended to. Feed until they have at least eight combs drawn-out, and well filled with stores, which should average about 30lb. for each stock for the winter.
- Honey Samples.*
- W. H. B. (Saddleworth).—*Varieties of Honey*.—(1) The honey is quite good, and you did nothing wrong in the treatment. (2) This is evidently a sample of foreign honey of indifferent quality. (3) The quality of No. 1 is very good. If you wish to reliefs it, it is only necessary to stand the vessel containing the honey in hot water until it melts. (4) It is not absolutely necessary to have a ripener, though it is a great convenience. (5) If the honey is allowed to stand about twenty-four hours, the scum will rise to the surface. After skimming this off the honey should be strained, and it can then be bottled off.
- IDEJA (Herefordshire).—Medium coloured honey slightly discoloured by honey dew. Gathered from mixed sources, the bitter flavour being derived from Spanish Chestnut, a small admixture of which is easily perceptible.
- J. H. (Rugby).—The honey is quite good enough for staging at a county show. It should be entered in the light class. The flavour is not very first-rate.
- C. L. P. (Dulwich).—There is evidently a jam factory near you and the bees have been stealing from this source.
- J. B. NELSON.—No. 1 is good in colour and density. We can say nothing as to the flavour as it tastes of nothing but the burnt wood in which it was packed. No. 2 is unripe, dull in colour, and the flavour is spoilt in the same way as No. 1.
- T. J. A. (Norwood).—(1) The honey is fermenting badly, and must have been taken off in an unripe condition. The source appears to have been limes, but it is not fit to eat. (2) Sample is a nice medium coloured wax, but it requires cleaning more thoroughly.
- A. P. (Letchworth).—Sample No. 1 is from white clover; No. 2 from sainfoin; the former is the best for show purposes. It ought to sell at 10d. per lb. retail; wholesale from 56s. to 60s. per cwt.
- E. A. B. (Petersfield).—Sample is a good honey and should fetch from 56s. to 60s. per cwt.
- A. B. C. (Welshpool).—The honey is of excellent quality and quite fit for show purposes in the light class. We are pleased to have been of service to you.
- J. B. D. (Biggleswade). (1) A very good honey, and with proper preparation would be quite fit for show. (2) About 60s. per cwt.
- E. M. (Bucks).—Sample No. 1 is from sainfoin, quite suitable for showing.

No. 2 unfortunately is fermenting. No. 3 is from mixed sources; it is very thin and would be of no value as an exhibition honey. You cannot improve No. 1; it is quite good enough.

K. C. PAYNE (Birmingham).—Honey is from clover good in all respects except density, which is only fairly good. The latter defect would in all probability prevent it from winning in a good competition.

J. H. (Huddersfield).—A very good clover honey.

R. A. (Oxford).—The honey is of good appearance and density, but, as is often the case with very pale samples, is devoid of either aroma or flavour, therefore, it is impossible to give the source.

C. L. (Bridgnorth).—The honey is good in density, rather dull, and the flavour is spoilt a little by an admixture of ragwort. Whether it would win a prize or not depends on what is staged in competition with it.

W. G. A. (Elgin).—It is an excellent sample of honey; in fact, one of the best we have seen this season. It lacks density a little, but no doubt this will improve.

### Special Prepaid Advertisements.

Two Words One Penny, minimum. Sixpence.

Orders for three or more consecutive insertions entitle advertisers to one insertion in "The Bee-keepers' Record" free of charge.

Trade advertisements of Bees, Honey, Queens, and Bee goods are not admissible at above rate, but will be inserted at 1d. per word as "Business" Announcements, immediately under the Private Advertisements. Advertisements of live-manufacturers can only be inserted at a minimum charge of 3s. per ½ in., or 5s. per inch.

### PRIVATE ADVERTISEMENTS.

TWO HEALTHY STOCKS OF BEES, in good hives, for sale, £1 each.—COLSON, Cockfield, Suffolk. 1 41

FOR SALE, 1cwt. Light Cornish Honey, 56/- cwt., tins free; sample 3d.; cash with order.—KNIGHT, Kenwyn, Truro. 1 56

WANTED, GRANULATED HONEY, exchange for new Hives.—HUMPHRIES, 92, Ampt-hill-road, Bedford. 1 53

FOR SALE, 5 good Stocks of Bees, all on 10 frames each, with 1911 Queens, £1 each; also 200lb. of Light Extracted Honey; wanted, good Extractor.—HIGGS, North-road, Congleton, Cheshire. 1 52

5 CWT. SPLENDID ENGLISH EXTRACTED HONEY, mainly sainfoin and clover, £3 per cwt. on rail, tins and cases returnable; sample.—S. CLEAR, Shepreth, Cambs. 1 51

HEALTHY STRONG STOCKS, 10 frames, Howard's single wall Hives, 25s. each, packed.—C. DRAKE, Sutton, Ely. 1 50

PURE LINCOLNSHIRE HONEY FOR SALE in bulk, 7s. per stone, tins returnable, carriage forward; also Granulated Honey.—MRS. COULSON, Brancewell, Steaford. 1 48

WANTED, Simmins' Divided Sections and Frames.—H. THOMAS, Millbrook, Clarbiston-road, Pembrokeshire. 1 47

LADY'S BICYCLE, 23in. frame, good condition, exchange 1cwt. new Honey.—M. D., "B.B.J." Office, 23, Bedford-street, Strand, W.C. 1 43

500 LB. HONEY FOR SALE, in sections and screw top bottles; state price given.—A. E. PECK, Half-lane, Norton, near Bury St. Edmunds. 1 42

CONQUEROR HIVES WANTED, single or double, must be guaranteed healthy, state price.—GARRETT, Hillview, Knock, Belfast. 1 38

PRIZE HONEY, finest grade, glazed sections, in perfect condition, price, delivered, 12s. per doz.—BYLES, Redenham, Andover. 1 37

OVERSTOCKED.—6 Stocks Bees in W.B.C. Hives, guaranteed healthy; 1910 Queens, good form for heather, natives, excellent comb builders; deposit.—H., 23, Bedford-street, Strand, W.C. k 95

FINEST SCOTCH CLOVER HONEY, £3 cwt. Sample 3d.—T. RULE, Summervale, Annan, Dumfriesshire. 1 8

NEW SEASON'S EXTRACTED HONEY, fine sample, in bulk 60s. per cwt., tins included; 1lb. screw cap glass jars, 8s. per dozen.—AVERY, Deverill, Warminster. 1 2

### BUSINESS ADVERTISEMENTS.

HEALTHY DRIVEN BEES, with Queen, August, 4s. 10/-; September, 3s.; cash and box with orner.—Apply, J. WHITE, Fairstead Hall, Witham. 1 40

4 TESTED HYBRID QUEENS, 3s. each.—HALL, 15, Borough, Hinckley, Leics. 1 46

HEALTHY DRIVEN BEES FOR SALE, 1910 Queens, 6s. 10/-, cash with order; skeps free.—G. A. GILLET, Moreton-in-Marsh. 1 54

DRIVEN BEES FOR SALE, 1s. 6d. lb., boxes returnable; cash with order; Queens, 2s. each.—KNIGHT, Kenwyn, Truro. 1 55

DRIVEN BEES (Native), or Stocks on 8 frames, headed with 1911 Queens; district free from all disease.—JAMES AITKEN, Carmichael School-house, Thankerton, Lanarkshire. 1 44

SPRING TRAVELLING CRATES for 12 or 24 Sections, 1s. 6d. and 2s. each; Boxes with corrugated cases, for 6, 12, or 24 Sections, or 1lb. bottles, 1s., 1s. 6d., and 2s. each.—H. CRESSY, Friary Mill, Dorchester. 1 25

SECTIONS, new, wanted, by the HONIELADE Co., 23, Moorfields, E.C. 1 24

SECTIONS of HONEYCOMB wanted to purchase for cash.—T. SMITH and Co., Cambridge-street, Hyde Park, W. k 13

PROLIFIC HYBRID QUEENS, 15 years' experience, fertile, 4s.; virgins, 2s.—MOORE, 10, The Avenue, Bedford. 1 23

DRIVEN BEES WANTED, 1s. 6d. lb. cash, boxes returned carriage paid.—A. W. GAMAGE, Ltd., The Holborn Apiary, Church End, Finchley, N.

NEWPORT, Isle-of-Wight, June 20th, 1911. To Mr. J. B. Goodare, Wednesfield.—"Dear Sir,—The 2 Queens you supplied me with last year have done splendidly; I had two strong swarms from both. Please forward me another, and oblige." The above speaks for itself.

100 LOTS OF DRIVEN BEES, commencing August 7th, 1s. 6d. per lb.; September, 1s. 2d. Cash with order given preference.—SOUTHCOTT, Gittisham, Honiton.

1911 CARNIOLAN QUEENS, mated in Carniola, Austria, 4s.; Swiss, 5s.; Italians, 3s.; delivery in one week.—F. VOGT, 32, Selwyn Avenue, Higham's Park, Essex.

1911 QUEENS.—Golden Italian fertile Queens, guaranteed healthy, pure-mated, vigorous, prolific, 4s. each; specially selected, 7s. 6d. each; prompt delivery.—J. B. GOODARE, Woden Apiary, Wednesfield, Wolverhampton. k 54

## Editorial, Notices, &c.

### SOMERSETSHIRE B.K.A.

The Somersetshire Bee-keepers' Association held its annual honey show in connection with the Weston-super-Mare Flower Show on August 3rd. The splendid honey season just past was well reflected in the large number of entries, and in the general high quality of the exhibits. The weather was all that could be desired, and the tent was literally packed with members and the public during the whole of the afternoon. The judges, Messrs. T. W. Cowan and S. Jordan, made the following awards:—

#### CLASS 1.

*Best Collection of Honey and Wax.*—1st, H. J. Moore, Radstock; 2nd, R. Lane, Radstock; 3rd, G. W. Kirby, Bristol; c., W. H. Jarvis, Taunton.

#### CLASS 2.

*Best Twelve 1-lb. Bottles of Extracted Honey.*—1st, H. W. Saunders, Thetford; 2nd, C. H. Dyer, Compton; 3rd, R. Lane, Radstock; v.h.c., A. H. Bowen, Cheltenham; v.h.c., T. George, Henbury; v.h.c., H. J. Moore, Radstock; h.c., S. J. Wakeford, Dinas Powis; h.c., G. F. Braddick, Cardiff; c., G. W. Kirby, Bristol.

#### CLASS 3.

*Best Twelve 1-lb. Sections.*—1st, J. Spiller, Taunton; 2nd, C. W. Dyer, Compton; 3rd, R. Lane, Radstock; v.h.c., T. George, Bristol; h.c., H. J. Moore, Radstock; c., G. W. Kirby, Bristol.

#### CLASS 4.

*Best 1-lb. Bottle of Honey.*—1st, H. W. Saunders, Thetford; 2nd, F. Crockett, Winchester; 3rd, A. C. Jackson, Thetford; 4th, R. Lane, Radstock; v.h.c., G. F. Braddick, Cardiff; h.c., C. W. Dyer, Compton; c., H. J. Moore, Radstock.

#### CLASS 5.

*Best 1-lb. Section.*—1st, T. George, Henbury; 2nd, A. H. Bowen, Cheltenham; 3rd, J. Spiller, Taunton; 4th, H. W. Saunders, Thetford; v.h.c., R. Lane, Radstock; h.c., R. Addison, North Petherton.

#### CLASS 6.

*Best Collection of Beehives and Appliances.*—1st, E. J. Burt, Gloucester; 2nd, Brown and Sons, Bristol.

#### CLASS 8.

*Best Exhibit of Pure Wax.*—1st, Miss E. Exon, Bristol; 2nd, G. W. Kirby, Bristol; 3rd, T. George, Henbury; h.c., J. Spiller, Taunton; h.c., R. Addison, North Petherton.

#### CLASS 9.

*Best Observatory Hive with Bees.*—1st, L. E. Snelgrove, Weston-super-Mare; 2nd, G. W. Kirby, Bristol.

#### CLASS 10.

*Best Three Shallow Bars of Comb Honey.*—1st, R. Addison, North Petherton; 2nd, F. G. Hales, Wellow; 3rd, C. S. Gay, Weston-super-Mare; v.h.c., G. W. Kirby, Bristol; h.c., Miss E. Exon, Bristol; c., H. J. Moore, Radstock.

#### CLASS 11.

*Best Exhibits of Honey Products.*—1st, G. W. Kirby; 2nd, R. Lane; 3rd, J. Spiller.

#### CLASS 12.

*Best Three Bottles Granulated Honey.*—1st, R. Lane; 2nd, F. G. Hales; 3rd, J. Spiller; h.c., H. J. Moore.

#### CLASS 13.

*Best Six Sections.*—1st, J. Spiller; 2nd, T. George; 3rd, H. J. Moore; v.h.c., G. W. Kirby; h.c., R. Lane; h.c., A. P. Hunt, Penlea.

#### CLASS 14.

*Best Six 1-lb. Bottles of Extracted Honey.*—1st, H. J. Moore; 2nd, R. Lane; 3rd, Miss E. Exon; v.h.c., R. Litman, Castle Cary; h.c., J. Spiller; h.c., G. Durman Chard; h.c., T. Gibbs, Bleadney.

#### CLASS 15.

*Best Six Bottles of Dark Honey.*—1st, G. W. Kirby; 2nd, H. J. Moore; 3rd, Miss Exon; v.h.c., R. Addison; h.c., A. R. Penny.

#### CLASS 16.

*Best Collection of Six Sections and Six Bottles.*—1st, H. J. Moore; 2nd, R. Lane; 3rd, G. W. Kirby; v.h.c., T. George; v.h.c., Miss E. Exon.

#### CLASS 17.

*Best Three 1-lb. Sections.*—1st, Miss E. Exon; 2nd, A. J. Hawkins; 3rd, K. J. Wilkinson; v.h.c., A. P. Hunt; h.c., A. R. Penny.

#### CLASS 18.

*Best Three 1-lb. Bottles of Extracted Honey.*—2nd, Rev. R. H. McCall, Muchelney; 3rd, A. Hole, Wedmore.

Much credit is due to the Show Secretary, Mr. T. Jones, whose arrangements contributed in no small degree to the unqualified success of the show.—L. E. Snelgrove, Hon. Sec.

## AMONG THE BEES.

### THE EDUCATION OF THE BEE.

By D. M. Macdonald, Banff.

So multifarious are the duties performed by bees that so excellent an observer as Huber believed that the inhabitants of the hive consisted of at least eight different kinds, all performing different duties and offices. These he set down as (1) the *queen*, who lays certain kinds of eggs. (2) The *drones*, one of which is sufficient to fecundate a queen during the whole of her life. (3) *Fertile workers*, i.e., females capable of laying eggs from which males only spring. (4) *Wax-workers*, who make

no wax, but who, nevertheless, construct the cells. (5) *Wax-makers*, from whose body the wax exudes. (6) *Royal jelly-makers*, who manufacture a food where-with a queen is generated whenever the bees require one. (7) *Nurse-bees*, whose office it is to attend upon the brood and feed the larvæ. (8) *Black bees*, who are born only to be starved.

We moderns are content to recognise only three, viz., queen, drone, and worker bee. We would group all from No. 3 to 8 in one class, differentiating, if at all, in setting fertile workers in a class by themselves. By an admirable providential arrangement, bees at different ages are better adapted for the performance of certain duties or functions than are others. Nurse-bees, for instance, have special glands during the earlier stages of their existence which fit them for the preparation and administration of brood food, or even Royal jelly. In course of time these glands are atrophied, and the intelligent worker leaves the duties of preparing the "pap" to younger bees, while she assumes the office of pollen-carrier, and later of nectar gatherer. These three duties have been performed by the same bee, and to this at one or other period of its life it adds the occupation of not only a wax-maker, but also a wax-worker, as well as performing many other offices which the calls of duty impose on it.

Whether the result of acquired knowledge, of greater adaptability of means to an end, or simply as a result of progressive development, certain duties are better performed by bees as they advance in days and weeks. But I have a strong impression that a species of education goes on steadily in the hive. Quick and intelligent as a bee undoubtedly is, it takes very little telling, and perhaps not much showing or even observation, to educe latent talent, but all the same the senior educates the junior. At first, a bee newly out of the cell is a very helpless creature, but soon seeing other bees visit the open vats of nectar it observes the process of feeding, and forthwith proceeds to sip too. Led out at an early age by the more mature youngsters when they are having a play spell, imitation, if not direct instruction, teaches them to wheel about in their airy dance. Later, in several points regarding the government of the hive the fruits of education are even more apparent.

"*Breaking the Ice.*"—Three hundred years ago Purchas wrote "Southerne brak the ice," i.e., he wrote the first genuine English book on bees. We in Scotland have just broken the ice in the way of affiliating with the parent association and securing "B.B.K.A." experts. Aberdeen-

shire has the honour of leading the way in both respects, a good second being the Spey Valley B.K.A. The examination held the last week of June in the neighbourhood of Aberdeen was the first of its kind in Scotland. Seven good men and true submitted themselves for examination, and all secured a certificate. It has been a dream of mine for years that a closer connection should exist between the Central Association and Scotch B.K.A.'s, and I am pleased it is now a realised fact. Let me urge other existing associations to go and do likewise. Next year, if not this, I hope Perthshire, Midlothian, Berwickshire, Ayrshire, and the South of Scotland will see it to their advantage to affiliate with the London centre. We are all British! Hitherto we have had few Scotch experts principally on account of the long distance from examination centres, but this is a thing of the past. No association can flourish without enlisting the enthusiasm of members in favour of propagandist work, and to secure this no more successful means exist than securing a number of qualified experts.

*Cleanliness.*—Some ancient writers hold up the bees as models in the practice of this virtue. One says: "They might be a mirror to the finest dames." Did it ever strike you, reader, that you can greatly aid your bees in keeping up the good name given them by our forefathers? This you can do by keeping your stocks strong. It is a real pleasure to note how spick and span everything is in a powerful colony. On the contrary, when a diseased or even a weakling is opened we find the result of untidiness and want of cleanliness. The floorboard is a mass of debris, and the frames a picture of slovenly care; while ten to one the wax-moth is working its sweet will on the combs. This year for the first time for many years I found it present in several hives in which the bees had got weak or in those where the bees had died out as a result of disease. All strong stocks held them at bay, whereas the weaklings from want of energy allowed them a lodgment and then to work their disagreeable destruction of the combs. Then how sweet and fresh the frames and hive walls of the stronger stocks were, and what a contrast was the fouled appearance brought about by dysenteric stocks! Even the flight-board of the one proved an index pointing to internal defects. Weaklings, too, daub frames and quilts more lavishly with propolis in autumn, thereby making manipulations far from pleasant. At all seasons of the year the strong stock shows a cleaner interior. For this reason, if for no other, weaklings should be tabooed.

## TELLING THE BEES.

*J. G. Whittier.*

"A remarkable custom, brought from the Old Country, formerly prevailed in the rural districts of New England. On the death of a member of the family, the bees were at once informed of the event, and their hives dressed in mourning. This ceremonial was supposed to be necessary to prevent the swarms from leaving their hives and seeking a new home. (The scene is minutely that of the Whittier homestead).

- "Here is the place; right over the hill  
Runs the path I took;  
You can see the gap in the old wall still,  
And the stepping-stones in the shallow  
brook.
- "There is the house, with the gate red-barred,  
And the poplars tall;  
And the barn's brown length, and the cattle-  
yard,  
And the white horns tossing above the  
wall.
- "There are the beehives ranged in the sun;  
And down by the brink  
Of the brook are her poor flowers, weed-  
o'er-run,  
Pansy and daffodil, rose and pink.
- "A year has gone, as the tortoise goes,  
Heavy and slow;  
And the same rose blows, and the same sun  
glows,  
And the same brook sings of a year ago.
- "There's the same sweet clover-smell in the  
breeze;  
And the June sun warm,  
Tangles his wings of fire in the trees,  
Setting, as then, over Fernside farm.
- "I mind me how with a lover's care  
From my Sunday coat  
I brushed off the burrs, and smoothed my  
hair,  
And cooled at the brookside my brow  
and throat.
- "Since we parted, a month had passed,—  
To love a year;  
Down through the beeches I looked at last  
On the little red gate and the well-sweep  
near.
- "I can see it all now,—the slatwise rain  
Of light through the leaves,  
The sundown's blaze on her window-pane,  
The bloom of her roses under the eaves.
- "Just the same as a month before.—  
The house and the trees,  
The barn's brown gable, the vine by the  
door,—  
Nothing changed but the hives of bees.
- "Before them, under the garden wall,  
Forward and back.  
Went drearily singing the chore-girl small,  
Draping each hive with a shred of black.
- "Trembling, I listened: the summer sun  
Had the chill of snow;  
For I knew she was telling the bees of one,  
Gone on the journey we all must go!

- "Then I said to myself, 'My Mary weeps  
For the dead to-day;  
Haply her blind old grandsire sleeps  
The fret and the pain of his age away.'
- "But her dog whined low; on the doorway  
sill,  
With his cane to his chin,  
The old man sat; and the chore-girl still  
Sung to the bees stealing out and in.
- "And the song she was singing ever since  
In my ear sounds on:—  
'Stay at home, pretty bees, fly not hence!  
 Mistress Mary is dead and gone.'

## CRAYFORD AND DISTRICT B.K.A.

The third of the series of outdoor demonstrations in bee-keeping, in connection with the above association, was held at Orchard House just recently by kind permission of the President (Mr. E. R. Stoneham), who, as usual, provided tea for members and friends. The attendance was below the average, owing no doubt to the proximity of the holiday season, but those who were present spent a very pleasant and interesting afternoon witnessing the examination of the hives and hearing the best methods of wintering and utilising driven bees, etc., from Mr. W. Herrod, the lecturer. Details of the Honey Show to be held on September 2nd will shortly be issued, for which a large number of entries are anticipated.—(Communicated).

## HAILSHAM AND DISTRICT BEE-KEEPERS' CLUB.

The second annual show in connection with the Hailsham and District B.K. Co-operative Club was held late in July, in the Deer Paddock, Hailsham. From all points of view, the second effort of this much-alive club (now boasting a membership of over fifty) was a thorough success. The marquee was electrically lighted by Mr. R. W. Jackson, and great credit is due to the Hon. Secretary (Capt. H. B. Penruddocke), and those members of the committee whose energy and practical knowledge so largely contributed to the success. A demonstration tent erected on the grounds interested and amused a constant stream of visitors. The judge was Mr. J. Bridge, of Polegate, and the following were the awards:—

*Three 1-lb. Sections.*—1, R. T. Martin, Magham-Down; 2, W. J. Penn, Hailsham; 3, Miss G. M. Abbott, Eastbourne.

*Two 1-lb. Jars of Extracted Honey.*—1, Miss M. Jeffery, Carter's Corner Place; 2, W. J. Penn; 3, Miss G. M. Abbott.

*Cap of Comb Honey.*—1, W. Langley, Hailsham.

*Hives and Appliances for Modern Bee-keeping.*—First, and Certificate of Merit, Capt. Penruddocke, Hailsham.

1-lb. *Sample of Wax*.—1, W. Langley; 2, Capt. Penruddocke; 3, R. W. Jackson.

1-lb *Jar of Honey*.—1, Miss M. Jeffery; 2, Miss G. M. Abbott.

1-lb. *Section*—1, R. J. Morris, Herstmonceux; 2, Miss G. M. Abbott.

*Display of Comb Honey*.—1, Certificate of Merit, Miss G. M. Abbott; 2, Certificates of Merit, S. Maynard, and R. W. Jackson.

*Display of Extracted Honey*.—1, Certificate of Merit, A. Cull, Horeham Road.

Among many other attractive items (not for competition) were: A Display of Comb and Run Honey, Observation Hives of Bees, Electric Swarm Catcher, and a

by reading carefully. I was able to bring them both safely through the winter. I found a stray swarm in a tree in the main Fulham Road two years ago, and have had four from my own stocks. I am now able to manage them successfully, and can almost guarantee immunity from swarms. Three of my stocks have completely filled 5in. shallow frames and supers, and I am just about to put another set of supers on the top of those. I don't believe in removing honey until the whole crop is ready to be taken off, then make one job of it. I bottle my honey and sell it at 1s. per lb., and allow 1½d. to those who return the bottles. I would not be with-



MR. J. E. MEYERS' APIARY, COLEHILL LANE, FULHAM.

Wasp-nest in Section.—CAPT. PENRUDOCKE, Hon. Secretary.

## HOMES OF THE HONEY BEE.

### APIARIES OF OUR READERS.

This picturesque apiary belongs to Mr. J. E. Meyers, of Colehill Lane, Fulham, who says: I first became interested in bees through a swarm which invited itself into my garden and settled on a small fuchsia tree. For want of a better hive, I put them in a butter-tub. The next spring I transferred them to one of Taylor's Twentieth Century hives, and the following season I had a swarm and a cast. Having bought a copy of the "Guide Book,"

out my bees if they cost me a little to keep. They are a constant pleasure to me in the spring and summer months.

## THE BIOSCOPE AND BEE-KEEPING.

Even in the short span of life it is wonderful the progress made in science. To-day we walk, to-morrow we emulate the birds and fly. So it is with pictorial teaching. The magic lantern showing, in-animately, phases of bee-keeping was considered a wonderful thing. To-day we can see the actual movements of our little pets in spare time in the evening, winter or summer, resting in a comfortable seat. At the annual meeting of the B.B.K.A.

Mr. J. Bee Mason showed some wonderful pictures of bee hunting, etc. To-day we have been privileged by having a private view of more wonderful pictures still. These will shortly be on view throughout the country and we would advise our readers, no matter how well-versed they may be in the craft, to make an effort to see them.

The title is "The Life of the Bee," by J. C. Bee Mason, and as he very aptly put it to us, it shows the whole thing from the cradle to the grave.

Having done a great deal of photography we could appreciate the amount of time and trouble that must have been expended to obtain these pictures, and we have no doubt that their exhibition will give a great impetus to the craft throughout the country.

The picture starts by showing the egg and larva changing from day to day until we have the perfect bee, eating its way through the capping and emerging. We then see the nurse bees attending to the young, also the queen receiving attention from her attendants. Comb building comes next, together with the bee busy collecting nectar and pollen from the flowers; this is a marvellous production, as the tongue and legs can be seen at work very distinctly.

The bees then prepare for swarming, being busily engaged in building queen cells and feeding the princesses. The swarm issues and we see it cluster. Going back to the hive we see the princess emerge, the surplus ones killed and pitched from the hive. As a finale comes the slaughter of the drones. Mr. Mason is to be congratulated on the fine production.

---

## Correspondence.

---

*The Editors do not hold themselves responsible for the opinions expressed by correspondents. No notice will be taken of anonymous communications, and correspondents are requested to write on one side of the paper only and give their real names and addresses, not necessarily for publication, but as a guarantee of good faith. Illustrations should be drawn on separate pieces of paper.*

---

### WASP PLAGUE.

[8231] Wasps are very numerous and troublesome in this district. Some days ago I found a nucleus hive containing a valuable queen being cleaned out of stores, while young hatching bees and brood were also being dragged out and eaten by wasps. The queen was crawling about amongst her fast diminishing family looking quite miserable and disconsolate. After caging the queen I strength-

ened the nucleus by placing it upon the site of a strong colony which I moved elsewhere, and thus placed it on a fighting basis with the wasps. I next put about a pint of syrup and cider into a watering can, stuffed a cloth into the mouth and left only the spout open. The bees take no notice of this bait but the wasps go down that spout all day long. About every third day I pour out all the syrup, full of wasps, into a strainer, and return it again clear, thus accounting for hundreds of wasps and saving my bees much annoyance.

*Stings.*—I have lately used a little common salt or soda rubbed wet on to the wound. It stops the swelling and pain in my case, where other things are useless.—H. O. M., Keynsham.

---

## Queries and Replies.

---

[8184] *Points in Extracting Honey.*—(1) Which is better for extracting purposes—the ordinary sized metal ends or the wide ones? The wide ones give more scope to the bees, and there is less uncapping. (2) Is the earlier honey, say before July, likely to be of the lighter colour? I note the later is darker. (3) Should you say the darker honey is less pure on the whole? In bottles it seems not to be preferred to the lighter. But that may be a preference for table purposes only. (4) Should you say the "Wilkes" excluder is better (freer for the bees) than the ordinary kind? (5) How can I get the most perfect sections—free from popholes?

REPLY.—(1) The thick combs of drone-cells are the best. (2) Generally the reverse, but a lot depends on the district. (3) There is no difference whatever in the purity, it is only the fancy of the purchaser. (4) Yes. (5) We have never yet seen a perfect section. Full sheets of foundation in the section, a hive teeming with bees, and a good honey-flow are the main factors.

[8185] *Bees Refusing to Work in Supers.*—I should be pleased if you will advise me through the "B.B.J." the best course to adopt in the management of my bees. They were given to me in 1909; being a cast of that year I wintered them well, and during 1910, they swarmed. This year they swarmed on July 3rd, the weight being 5½lb. What I wish to know is: (1) Would you consider it advisable to change the queen; if so, when? (2) What kind do you prefer? I might say I gave the bees plenty of room in the supers, but I could not get them to take to them either this year or last, yet they fill the

brood-nest with honey. The swarm drew out nine frames in a week, I placed a rack of sections on them from parent hive, they did a little, but soon abandoned the super, and I find they have filled all the brood-frames three or four inches from top. They are black bees. The result of my two years bee-keeping is about half-a-dozen pounds of honey; and this I have chiefly extracted from brood-frames since taking off the racks. (3) Should I have done this earlier? I might say I am a new reader of your journal, therefore I trust I am not asking you to repeat information contained in previous issues. I have the "Guide Book," 19th Edition. —ANXIOUS, Edgbaston.

REPLY.—(1) It ought not to be necessary to re-queen as the one you have is a young one. (2) A British queen is best. (3) The cause of your difficulty in all probability is that you did not put on the super soon enough, or it may have been want of ventilation. Try putting on racks without the excluder next time, and attend to the above points. We are always pleased to help beginners.

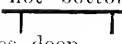
[8186] *Driving Bees*.—Will you please tell me how to proceed in driving bees from one bar frame hive into another, as I have the offer of some bees from a friend, and he will be abroad when they come back from the heather? Instructions for doing this with two skeps are given in the "Guide Book," also how to shake bees from frames, but I fear the frames in the hives are not strong enough, as they have not bottom bars, they are shaped thus  The frames are only six inches deep. Your advice will greatly oblige.—J.S., Hamilton.

REPLY.—If the frames are moveable there is no need to drive. Take them one by one and shake the bees off. If they are not moveable, then proceed as in driving a skep, using a box the same size as the one containing combs to drive into. It will be necessary to have strips of wood with a screw at each end, instead of the ordinary driving irons, as it will be difficult to force them into wood.

We notice your kind appreciation of the new edition of "Guide Book."

[8187] *Uniting Driven Bees*.—I intend to drive two skeps of bees four miles from here, and bring them home to unite in a frame-hive. There are one or two points I do not see quite clearly, on which I should feel obliged if you would advise me. (1) If an empty skep is placed on the old stand to receive the foraging bees, how long should it be left there, and how are the bees to be induced to join the driven ones? (2) I intend to hive one lot, dust them well, and then run the other lot in, dusting them as they enter. Will it be safe to leave the selection of one of

the queens to the bees, or is there a danger of both being destroyed? (3) If I give them six frames with full sheets of foundation and one of brood, how long should they be fed, and at what rate? Thanking you in anticipation.—W. R., Suffolk.

REPLY.—(1) If you carry out the operation towards evening, say, six or seven o'clock, when driven, place the skep containing the bees on the old stand until dark, and you will collect them all. Bees locate position, and not the hive, therefore they will go to the old spot, although it may have a different hive upon it. (2) There is a slight chance of disaster to both; it is best to carry out the selection yourself. (3) It will be necessary to feed. Keep a continual supply with about three holes of the feeder open until the first week in September. Then feed until the bees have eight combs well filled and sealed over.

[8188] *Re-queening Wells Hive*.—Your advice on the following points will be much esteemed. (1) I have six hives of bees at the heather at present, one of which (a Wells hive) I wish to re-queen this season, as the queen is two years old. Would you advise my dividing the stock with a perforated dummy, and wintering with the two queens, destroying the old queen in spring, and then uniting the stocks? (2) Which variety of bee do you consider the best honey gatherers, as I am undecided as to whether to buy an Italian queen? One bee-keeper here says they are uncontrollable during manipulations. (3) Can an Italian queen be introduced successfully, as mentioned in the first question, and when is the best time to do this? (4) Will you kindly name the insect which I enclose; it was caught indoors here, and they nipped his head (which I enclose also) off in trying to kill it.—J.H.W., Mold.

REPLY.—(1) No. Introduce the queen now, after having killed the old one and allowed the colony to be queenless for at least twelve hours. (2) Stick to British bees. (3) Yes, follow out the above instructions. (4) The insect is a Saw-fly.

[8189] *Transferring Bees*.—Would you be so kind as to answer me the following question? I bought a hive of bees about two months ago and on examining it I find it is a home-made one, as are also the frames, and consequently they will not fit a Standard frame hive. I want to transfer the bees into such a hive, and I would like to know the best time to do it. The bees are free from any disease and very strong, and they will winter all right in the hive they already occupy if you think it would be better to leave them until next year. The hive has not got a movable floor-board.

I would like to tell you I have only kept bees this last two months, but it is five



years since I got your Guide Book, and I always find something fresh in it every time I take it up, which is pretty frequent. I am writing to Mr. Crawshaw to-day to see if I can help him to get the opinion of bee-keepers in this district with regard to bee-disease legislation. I wish you every success for a good season.—A.H., St. Boswells.

REPLY.—If the colony is a strong one you can transfer the bees to a hive with Standard frames fitted with comb foundation by making an artificial swarm of all the bees and putting it into the hive in the usual way. Any combs containing brood can be cut out of the old frames, fitted into the Standard ones and carefully tied in with tape. After a couple of days the tape can be removed, and when all brood has emerged these old combs can be taken out and their places filled with frames of foundation. You can do this now as there is still time to build up the colony for wintering, or if you prefer it, it can be done in spring. We thank you for your appreciation of the Guide Book, and are pleased that you are ready to assist with regard to legislation.

[8190] *Moving Bees to Heather.*—As I live in a district where there is plenty of heather about one mile from my residence, where my bees are, I am wondering whether it would be advisable to move the bees on to the heather. As this is chiefly what we depend upon in this district, I am anxious to take full advantage of this bee foliage. My stocks are in splendid condition for work, and have done exceedingly well this season so far, but in previous years I have not seemed much benefited by heather produce. May be the weather at the back end has had something to do with it. I am anxious to increase my stock this year or the beginning of next. Which do you think best, to buy driven bees now, or wait until next spring and buy swarms? I should like about twenty stocks in all, and as I have had considerable experience in the management of seven for something like ten years, I think now I could manage them. If I purchase driven bees do you advise re-queening with English or Italian queens? I must thank you for your valuable journal, of which I am a constant reader.—WM. STEPHENS.

REPLY.—If you are within one mile of the heather it is not absolutely necessary to move the bees, as they fly a distance of two miles for forage. If moved nearer it would, of course, facilitate the work and in all probability you would get a better return, especially if bad weather sets in. You might with advantage buy a few lots of driven bees, which by careful nursing will build into strong stocks and give you surplus next year. You could

augment these by some swarms in the spring and so bring your colonies up to the required number. If the queens are all right, there will be no need to re-queen, but if you do, stick to English.

#### A HOME-MADE OBSERVATORY HIVE.

I have pleasure in sending a photograph showing both sides of an observatory hive that I have lately made. The hive has double plate-glass sides sliding in grooves. It takes three standard frames, and three sections. The whole revolves on a brass-turned disc 8in. in diameter. The entrance is by a glass

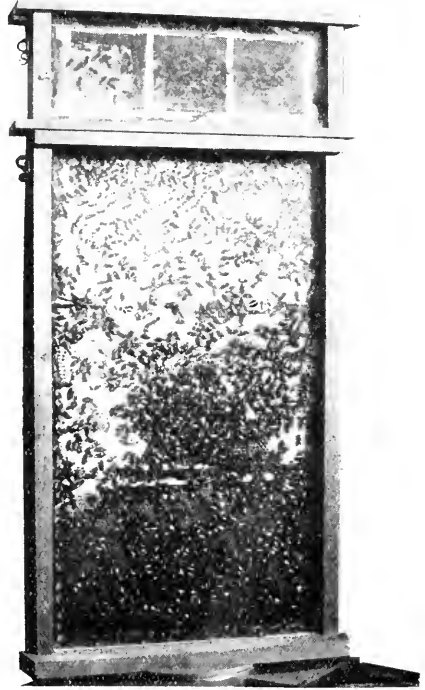

tunnel, shown under right hand corner. The white knob at the side shows where I can insert a thermometer; the temperature varies from 85deg. to 92.5deg. Fahr. The bees were hived on July 11th, a small swarm of about two quarts of bees, which were given to me by a friend living at Minehead. I placed two combs partly filled with honey, one frame of foundation, and three sections of foundations in the hive. I saw the queen laying on July 13th; on July 20th some brood was capped over. The photo was taken on July 28th, when the bottom frame was nearly solid with capped brood, the middle comb had some capped brood in the centre, the rest being sealed honey. The top frame is solid with honey, and is now sealed over from wood to wood (July 30th), and two of the sections are also nearly full of honey. I noticed that

the queen takes, on an average, thirty seconds to lay an egg, that is to say, she will lay four eggs in two minutes, when the cells are close together. I keep the hive covered with a cloth, but the bees do not mind being looked at. They became very excited with the heat from the sun when the photograph was taken.—J. D. A., Somerset.

## Bee Shows to Come.

**August 17, at Kenilworth Castle.** Show of Kenilworth Horticultural Society. Open Honey Classes. Prizes, 10s., 5s., 2s. 6d. Judge, Mr. G. Franklin. Very popular, and an old established exhibition. Schedules from E. H. Thornett, Secretary, Kenilworth.

**August 17, at Abington Park, Northampton.** Northants B.K.A. Annual Honey Show. Special Prizes for Open Classes, including one for single 1lb. jar of Honey. Entry free. Judge, Mr. W. Herrod. Prizes, 20s., 10s., 5s., 2s. 6d., and 1s. 6d. Schedules from R. Hefford, Kingsthorpe, Northants. Entries closed.

**August 23, at Radstock, Somerset.**—Honey Show in connection with the Radstock Horticultural and Farmers' Association. Open and gift classes. Write for Honey Schedule. B. M. Clark, Foxhills, Radstock.

**August 23, at Wedmore, Somerset.** In connection with the Annual Flower Show. Four Classes for Honey. Sections, Extracted, Shallow Frames, and Granulated Honey. Entrance fee, 6d. in each class. Schedules from G. H. Tatham, Wedmore, Somerset. Entries close August 19.

**August 23 and 24, at Shrewsbury.** Annual Show of the Shropshire Bee-keepers' Association, in connection with the Shropshire Horticultural Society's Great Floral Fête. Eight Open Classes for Honey. Free entry for single bottle and single section. Schedules from S. Cartwright, Hon. Sec., Shawbury, Shrewsbury. Entries closed.

**August 24, at Wooler, Northumberland.** Annual Show of the Cheviot and Tweed Borders B.K.A., in connection with the Glendale Horticultural Show. Two open classes. Schedules from Robert Robson, Cheviot Street, Wooler. Entries close on August 21.

**August 26, at Kettering.**—In connection with the Kettering Working-Men's Horticultural Society's Show. Open Class for Honey, single 1lb. jar. First prize value 16s. Entries free. Schedules from Hon. Sec., W. Heritage, 114, King Street, Kettering.

**August 29, at Cartmel, Lancs.** Bee and Honey Show in connection with the Cartmel Agricultural Society's 29th Annual Show. Liberal prizes. Open classes. Schedules from J. N. Parker, Cartmel, near Carnforth.

**August 30, at Chester.**—Annual Show of the Cheshire B.K.A. in connection with the County Agricultural Show. Several Open Classes. Good prizes. Schedules, &c., from Hon. Sec., E. W. Franklin, Mouldsworth, near Chester.

**August 30 and 31, at Carlisle.**—Annual Honey Show of the Cumberland and Westmorland B.K.A. in connection with the Carlisle Horticultural Society's Exhibition to be held in the Covered Market, Carlisle. Schedules from G. W. Avery, Hon. Sec., Heads Nook, Carlisle.

**August 30 and 31, at Coventry.**—Annual Show of the Warwickshire B.K.A., in connection with the Warwickshire Agricultural Society. Separate tent for Honey, Wax, and Appliances. Open Classes. Schedules, &c., from J. N. Bower, Knowle, Warwickshire.

**September 6, at Deddington, Oxon.**—Show of the Deddington Horticultural Society. Open Class for Honey. Prizes, 10s., 5s., 3s., 2s. No entry fee. Schedules from Messrs. H. J. Harmsworth or A. A. Rusby, Deddington. Entries close September 1.

**September 7, at Peterborough.**—In connection with Horticultural Society, County Association Class and four Open Classes. Schedules from G. T. Dunham, Albion Terrace, 32, Oundle Road, Peterborough. Entries close September 1.

**September 12, at Woodstock.** Oxfordshire Bee-keepers' Association Annual Show. Open Classes. No entry fee for the best Section, for the best jar of Run Honey. Prizes 7/6, 5/., 2/6. Entries to H. M. Turner, 4, Tune Street, Oxford. Entries close September 9.

**September 13, at Conway, N. Wales.**—Great Annual Honey Show in connection with the Conway Honey Fair. Open and local Classes. Schedules from J. Hughes, Town Hall, Conway. Entries close September 6.

**September 13 and 14, at Cambridge.**—Honey Show in connection with the Cambridge and District Red Cross Horticultural Society. Four Classes, open to all. To be held in the Corn Exchange, Cambridge. Schedules and particulars of Hon. Sec., E. F. Dant, Member of B.B.K.A., 52, Bridge Street, Cambridge. Entries close Saturday, September 9.

**September 14, at Castle-Douglas.**—Annual Show of South of Scotland Bee-keepers Association. Five open classes; Three 1-lb. jars extracted, 20s., 10s., and 5s.; three sections, ditto (Entry 2s.). 1lb. jar, also one section, 5s., 3s., and 2s. (Entry free, and exhibits retained unless otherwise agreed upon). Beeswax, 5s., 3s., and 2s. (Entry 6d.). Fourteen classes for members. Schedules from Q. Aird, Schoolhouse, Howwood, Renfrews. Entries close September 2.

**September 16 to 23, at the Agricultural Hall, London.**—Honey Show in connection with the 19th Annual Exhibition and Market of the Grocery and Kindred Trades. Liberal prizes. Open to all British Bee-keepers. Schedules from H. S. Rogers, Secretary, Exhibition Offices, Palmerston House, Old Broad Street, London, E.C.

**September 26, at Horniman Hall, North End, Croydon.**—Exclusive Show of Honey, Wax, Hives, Bees, &c. Increased prizes. Six Open Classes. Judge, Mr. W. Herrod, F.E.S. Schedules from A. Wakerell, 21, Mansfield Road, Croydon. Entries close September 16.

**September 27, at Altrincham.**—Honey Show, in connection with the Altrincham Agricultural Show, the largest one-day show in the Kingdom. Classes open to United Kingdom. Classes for Trophy of Honey, for Best Hive, Observatory Hive with Bees and Queen, twelve Jars of Extracted Honey. Classes open to County of Chester, for Run and Section Honey, Wax, &c. Special Classes for Cottagers, and Special Classes for Society's District. Several Special Jubilee prizes. Schedules from Mr. J. Herbert Hall, 2, Dunham Road, Altrincham. Entries close September 9, and at extra fees September 13.

## Notices to Correspondents.

D. G. T. (Ilminster).—*Animals Breaking Bounds.*—You are quite right with regard to poultry, the owners of which are responsible for keeping them within bounds, but as regards fences it is the owner's duty to see that they are in proper condition to keep out cattle. We have two leases before us in both of which the lessor covenants to keep the fences in proper and substantial repair. Of course the lessor can make a special agreement with the lessee by which the latter can be bound to keep the fences in repair. If the owner of the fences is also the owner of the cattle it would certainly be his duty to see that they did not break out of the fields.

- C. PARKE-SMITH.—*Price of Honey.*—If you can get 1s. per lb. for your honey, sell it as quickly as possible. You are not likely to get an increase on this price. The Secretary of the Staffordshire Bee-keepers' Association is Mr. C. R. Forse, Trentham, Stoke-on-Trent, and of the Shropshire, Mr. S. Cartwright, Shawbury, Shrewsbury. Either of these gentlemen will give you full particulars of their associations if you write to them.
- R. W. (Castle Headingham).—*Keeping Bees near High Road.*—You must use your own discretion as to the number of hives you keep. No one can prevent you keeping bees, but you are liable for any damage caused by them. In your position you should safeguard yourself by insuring them under the British Bee-keepers' Association insurance scheme.
- T. M. (Chiddingstone).—*Stock Destroyed by Wasps.*—The stock must have been in a very bad condition, for the comb was infested with wax-moth. There was no brood or honey, though evidence of immature queen-cells at the bottom of the comb. There appeared to be no disease.
- RAILWAY MAN (Basildon).—*Driven Bees.*—If the weather keeps warm and you do not give more than eight frames the bees will build the combs and store sufficient food to last them the winter. It will, of course, be necessary to pay careful attention to the food supply. At first feed with a bottle feeder, giving about three holes; you must see that the bottle is never empty. About the second or third week in September put on a rapid feeder and give the bees as much thick syrup as they will take. To make quite sure when wintering put on a two pound cake of candy.
- S. R. W.—*Dead Bees.*—You evidently did not follow the instructions given carefully enough. You should not have confined the bees without giving them ventilation. This could easily have been done by putting a strip of perforated zinc over the entrance. No doubt the trouble is caused by this, and it would be accentuated if naphthaline was present in the hive. It is necessary to consider a little before following instructions given, and you now remember that the weather we are now having is abnormal.
- J. T. H. (Whitley Bay).—*Late Reared Queens.*—The bees will allow the drones to live until the virgin emerges, and is fertilized. Considering the fine weather we are experiencing you should take the risk.
- T. N. (Erith).—*Two Queens in a Hive.*—Yours is a curious experience, but not unique. There is no doubt the various manipulations you carried out were the cause of bees proceeding as they did. It is quite possible (though unusual) for bees to allow two queens to live in one hive.
- R. U. (Farnham).—*Parasites on Queen.*—The queen is infested with *Braula caecae*.
- W. M. (Weston-super-Mare).—*Disease.*—The circumstances you mention would not account for the condition of the comb sent. If the bees could get in and out, no matter which part of the hive, they would be all right. Harm would come only if they were confined entirely, and even then you would not get chilled brood but scald brood. The comb is practically rotten with foul brood, and the sooner you kill the bees, destroy the combs and well disinfect the hive by burning with a painter's spirit lamp, the better.
- Suspected Disease.*
- H. S. (Chislehurst).—Bees are suffering from "Isle of Wight" disease. Destroy at once.
- Honey Samples.*
- A. T. S. (Mickleover).—The sample is a very good one from clover, it is good in all points and you will be justified in showing it.
- H. T. (Astley).—The honey is from mixed sources; there is a good deal of ragwort in it but no honey-dew.
- H. M. (Birmingham).—No. 1 is a good sample of clover honey, it is worth from 56s. to 60s. per cwt. No. 2 is a medium coloured honey from mixed sources of inferior quality. Worth from 45s. to 50s. per cwt.
- C. H. W. (Haslemere).—The bitter flavour you complain of is caused by a small admixture of ragwort. We do not personally object to it, and consider your honey quite a saleable sample.
- G. B. (Ormsbury).—The honey is a good sample of fruit honey, and though dark in colour contains no honey-dew. Use one-third of its bulk of water medicated with Naphthal Beta, to weight as given in "Guide Book." The honey and water should be boiled before being given as food to bees.
- G. S. B. (Cheshire).—Sample A is from clover and fruit, and is good in all points. B is from clover only, and rather thin; but in other respects good. C is the best sample of all, and is quite worth exhibiting. The cloudiness is due to air bubbles, and if the honey is carefully warmed in hot water these will rise to the top in the form of scum which can then be removed. Many thanks for your kind appreciation.

**Special Prepaid Advertisements.**

**Two Words One Penny, minimum Sixpence.**

Orders for three or more consecutive insertions entitle advertisers to one insertion in "The Beekeepers' Record" free of charge.

Trade advertisements of Bees, Honey, Queens, and Bee goods are not admissible at above rate, but will be inserted at 1d. per word as "Business" Announcements, immediately under the Private Advertisements. Advertisements of Hive-manufacturers can only be inserted at a minimum charge of 3s. per ½ in., or 5s. per inch.

**PRIVATE ADVERTISEMENTS.**

**GENTLEMAN'S** new Rudge-Whitworth cycle, not unpacked; will exchange for 25wt. of high extracted honey.—**NEWPORT**, Cattennan, nr. Chester. 1 09

**LIGHT HONEY**, in sections, or 1lb. screw-top jars, 9s. 6d. doz., packed and free on rail; also sample, 1s. 2d., post free; cash with order.—**A. JENSEN**, Hornchurch, Essex. 1 84

**4 CWT. PURE ENGLISH HONEY**, 60s. per cwt., tins returnable; sample, 3d.—**A. BANIAM**, Lilac Cottage, West Meon, Petersfield. 1 70

**6 DOZ. Light Coloured Sections**, from my own hives, 8s. per doz.; 1½cwt. light Clover honey, 58s. per cwt., sample 2d.—**J. YOUNGER**, 21, Mackenzie-road, Cambridge. 1 74

**FOR SALE**, 5doz. Fine Light Clover Sections, 9s. per doz.; 2 28lb. tins Extracted Clover honey, 32s., sample 2d.—**R. GODSWORTH**, School House Hill, Malton, Yorks. 1 75

**SEVERAL** new W.B.C. Hives; will exchange for Driven Bees or Honey; Driving required, good terms offered.—**WILLETT**, New Malden, Surrey. 1 76

**EXTRACTED ENGLISH HONEY**, 12s. 6d. per 28lb. tin, sample 2d.—**DUCTION**, Terling, Essex. 1 79

**25 STOCKS FOR SALE**, in good W.B.C. Hives, headed young Queens, guaranteed healthy; overstocked only reason for sale; exceptional opportunity to acquire reliable stock; also various appliances, and shed 11ft. by 7ft.—**W. H. SIMS**, Hall Green, Birmingham. 1 80

**SECTIONS**, 8s. 6d. per doz.; also 1lb. screw top bottles, same price.—**A. WEELEY**, Weeley, Essex. 1 77

**25 STOCKS OF BEES** on frames; will sell cheap; owner emigrating.—**H. J. MASCALL**, Radwinter, Saffron Walden. 1 58

**GENTLEMAN'S BICYCLE**, 24in. frame, free wheel, tyres good, exchange 4doz. good sections; 3 days' approval both ways, each pays own carriage.—**WALKER**, Grotto, Kirkby Stephen. 1 65

**GOOD QUALITY SECTIONS**, well fitted, 8 6 dez.—**NORTH**, Cressing, Braintree, Essex. 1 68

**WANTED**, new, clean, draw-out, shallow Frames; price and particulars.—**T. H. JACKSON**, Railway street, Kirbymoorside, Yorks. 1 67

**WANTED**, **COWAN'S BEE MODEL**, Cheshire's, 2 vols. and other Standard Bee Works, cheap.—**BARBOUR**, Ramsey, I. of Man. 1 57

**FOR SALE**, 11 acres **FREEHOLD LAND**, situate at Lambourn, Berks £240; two-thirds can remain; good site for bee farm.—**WADHAM**, 5 Gold-street, Renth, Cardiff. 1 59

**FINEST FLOWER HONEY**, in sections, 10 5 per doz. extracted Honey in tins 23 per cwt., sample 2d.—**WILLIAM WILSON**, 25, Forfar-road, Kiriemuir. 1 60

**WANTED**, from Welsh District, 10 lots healthy Driven Bees, 5/- per lot boxes returned.—**WILLIAMS ELLIS**, Glasfryn, Chwilog. 1 51

**SECTIONS WANTED**, for cash; send lowest price, any quantity, and extracted.—**F. W. WEITZEL**, 45 Kensal Rise, N.W. 1 64

**FOR SALE**, 1cwt. Light Cornish Honey 56/- cwt. tins free; sample 3d.; cash with order.—**KNIGHT**, Kenwyn, Truro. 1 56

**500 LB. HONEY FOR SALE**, in sections and screw top bottles; state price given.—**A. E. PECK**, Mal-lane, Norton, near Bury St. Edmunds. 1 52

**CONQUEBROK HIVES WANTED**, single or double, must be guaranteed healthy, state price.—**GARRETT**, Millview, Knock, Belfast. 1 36

**OVERSTOCKED**.—6 Stocks Bees in W.B.C. Hives, guaranteed healthy; 1910 Queens, good form for heather, natives, excellent comb builders; deposit.—**H.**, 23, Bedford-street, Strand, W.C. k 99

**FINEST SCOTCH CLOVER HONEY**, £3 cwt. Sample 3d.—**T. KULE**, Summervale, Amman, Dumfriesshire. 1 6

**NEW SEASON'S EXTRACTED HONEY**, fine sample, in bulk 60s. per cwt., tins included; 1lb. screw cap glass jars, 8s. per dozen.—**AVEKY**, Deveril, Warmminster. 1 2

**BUSINESS ADVERTISEMENTS.**

**DRIVEN BEES**, healthy, 6s.; F.O.R. Queens, 2s. 6d. each.—**THE HURST**, Kington, Worcester. 1 72

**DRIVEN BEES**.—For dispatch August 23rd, 12 lots, in tree boxes, 5s. per lot, guaranteed healthy.—**AVEKY**, Deveril, Warmminster. 1 83

**HIVES** in the flat carefully prepared; 3, with frames, 2ls.; tins, feeders, &c.; catalogue free.—**BURTT**, Manufacturer, Gloucester. 1 81

**VIRGINS**, 1s. 3d., safe arrival guaranteed.—**TOLLINGTON**, Woodbine Apiary, Hathern. 1 78

**DRIVEN BEES**, guaranteed healthy, 4s. per lot, package returnable.—**CADMAN**, Codsall Wood, Wolverhampton. 1 73

**HEALTHY DRIVEN BEES**, young Queens, 5s. 10/-, boxes free.—**KEMP**, Clink, Frome, Somerset. 1 71

**MESSRS. STONE AND SONS**, Chemists, Exeter, are buyers of English Beeswax, in large or small quantities.—Write, stating quantity and price required.

**GRAND STOCK**.—Simmins' "White Star" Italians, 1911 Queen, ample stores, frames (17½ by 9), packed with brood, complete, in well-made hive; Queen excluder and dry feeder, 30s.—**HEISCH**, 37, Hermon-hill, Waustead.

**SECTIONS WANTED** for cash; send lowest price, any quantity.—**F. W. WEITZEL**, 45, Kempe-road, Kensal Rise, N.W. 1 63

**200 LOTS** of healthy **DRIVEN BEES**, 5/- per lot; 30 gross 1lb. Sections, gross.—**DENNETT**, Whitechurch, Hants. 1 66

**SPRING TRAVELLING CRATES** for 12 or 24 Sections, 1s. 6d. and 2s. each; Boxes with corrugated cases, for 6, 12, or 24 Sections, or 1lb. bottles, 1s., 1s. 6d., and 2s. each.—**H. CRESSY**, Friary Mill, Dorchester. 1 25

**PROLIFIC HYBRID QUEENS**, 15 years' experience, fertiles, 4s.; virgins, 2s.—**MOORE**, 10, The Avenue, Bedford. 1 23

**DRIVEN BEES WANTED**, 1s. 6d. lb. cash, boxes returned carriage paid.—**A. W. GAMAGE, Ltd.**, The Holborn Apiary, Church End, Finchley, N.

**NEWPORT**, Isle-of-Wight, June 20th, 1911. To Mr. J. B. Goodare, Wednesfield.—"Dear Sir.—The 2 Queens you supplied me with last year have done splendidly; I had two strong swarms from both. Please forward me another, and oblige." The above speaks for itself.

**100 LOTS OF DRIVEN BEES**, commencing August 7th, 1s. 6d. per lb.; September, 1s. 2d. Cash with order given preference.—**SOUTHCOTT**, Gittisham, Honiton.

**1911 CARNIOLAN QUEENS**, mated in Carniola, Austria, 4s.; Swiss, 5s.; Italians, 3s.; delivery in one week.—**F. VOGT**, 32, Selwyn Avenue, Higham's Park, Essex.

**1911 QUEENS**.—Golden Italian fertile Queens, guaranteed healthy, pure-mated, vigorous, prolific, 4s. each; specially selected, 7s. 6d. each; prompt delivery.—**J. B. GOODARE**, Woden Apiary, Wednesfield, Wolverhampton. k 54

## Editorial, Notices, &c.

### "ISLE OF WIGHT" DISEASE.

The Board of Agriculture have been for some time investigating this disease, and it will be remembered that Dr. Malden found amongst a number of different bacilli one that he thought might be the cause of infection. His attempts to obtain cultures gave negative results, as he was not able to reproduce the disease. The investigations have been carried further this season, and, with a plentiful supply of material to work upon, the result has been that in some of the cases examined enormous numbers of spores of *Nosema apis* have been found. We have therefore much pleasure in bringing to the notice of our readers the following note on the subject, which appears in the journal of the Board of Agriculture for this month:—

"*Isle of Wight' Bee Disease.*—In some of the outbreaks investigated the spores of *Nosema apis* have been found in enormous numbers in the cells lining parts of the alimentary canals of the affected bees. These cells become completely disorganised and eventually the spores escape from them and are voided in great numbers in the excrement. Such cases, which appear to be more frequently met with in the spring, are undoubtedly due to infection with this parasite.

"In most of the outbreaks recently investigated few spores, if any, have been found, but parasites, which are probably young stages in the growth of *Nosema apis*, are usually present in the cells lining the intestinal tract.

"It appears probable, therefore, that during the colder months, when the bees show little activity, the parasites grow and reach the spore stage before the bees succumb, while during the warmer months the rapid multiplication of the parasites often kills the bees before the spore stage is reached.

"Experiments have proved that normal bees may be artificially so heavily infected that the intestinal cells are crowded with spores. Infection may be produced in various ways: (a) by feeding with spores, (b) by feeding with candy on which infected bees had fed, (c) by mixing naturally infected excrement with the food, (d) by confinement in a box in which infected bees had travelled, and (e) by contact with dead infected bees.

"The investigations and experiments which have been made hitherto seem to indicate that the 'Isle of Wight' disease is due to infection with *Nosema apis*, but that the symptoms of the disease and the growth of the parasite within the affected

bees are greatly influenced by various conditions."

We have already informed our readers from time to time of the researches that have been carried on with respect to *Nosema apis* since Dr. Zander first called attention to it (B.B.J., 1909, page 421), and so recently as on August 10th last we alluded to Dr. Burri's work in Switzerland. Seeing that the symptoms are so similar we are not surprised to find that bacteriologists in this country have found the same organism in connection with the "Isle of Wight" disease. Experiments have evidently proved that this parasite is the infective agent, and not *Bacillus pestiformis apis*, which is apparently harmless, and we would especially draw attention to the various ways in which infection can be produced. There can be very little doubt but that the inclement seasons we have had during the last few years have been responsible for a good deal of this disease, and it is satisfactory to find that there has been very little of it this season, although there are some districts not yet quite free from it. We would therefore repeat our advice given on page 311 of "B.B.J." with regard to the treatment of affected colonies. Badly infected colonies should be destroyed by burning.

In the early stages of the disease slightly affected colonies should be treated as for foul brood, and bees induced to build new combs. Of course, the important thing is to destroy all dead bees and disinfect anything coming in contact with bees, as it is by means of their excreta that the disease is propagated.

---



---

### LANCASHIRE B.K.A.

#### ANNUAL SHOW.

The show of the above association was held in the Giant Axe Field, Lancaster, on August 16th, and was a great success. The following were the awards of the judges, Messrs. J. N. Bold and W. Herrod:—

#### OPEN CLASSES.

*Twelve Sections of 1911 Honey.*—1st, A. S. Dell, Leigh; 2nd, T. Walker, Hawkshead; 3rd, J. G. Nicholson, Langwathby.

*Twelve Jars 1911 Light Honey.*—1st, A. S. Dell; 2nd, J. Ward, Hesketh Bank; 3rd, E. Church, Cardiff.

*Twelve Jars 1911 Medium Honey.*—1st, A. S. Dell; 2nd, T. Walker; 3rd, P. M. Ralph, Settle.

*Six Jars Heather Honey, any year.*—1st, M. J. Lamboll, Chiddingfold; 2nd, R. Smith, Preston; 3rd, J. Whitaker, Abbeystead.

*W.a.c.*—1st, T. Walker; 2nd, H. W. Saunders, Thetford; 3rd, A. S. Dell.

*Beehive*—1st, Jas. Lee and Son, Ltd., London.

*Cottager's Beehive*.—1st, Jas. Lee and Son, Ltd.

OPEN TO LANCASHIRE AND MEMBERS OF  
L.B.K.A. ON THE BORDERS.

*Six Sections 1911 Honey*.—1st, T. Walker; 2nd, H. Mackereth, Stodday; 3rd, A. S. Dell.

*Six Jars 1911 Light Honey*.—1st, A. S. Dell; 2nd, J. Ward; 3rd, H. Mackereth.

*Six Jars Other than Light*.—1st, T. Walker; 2nd, T. Ireland, Lancaster; 3rd, R. Smith; r., Miss D. M. Platt, Carnforth.

*Six Jars (granulated), any year*.—1st, E. P. Hale, Endmoor; 2nd, I. Willan, Kendal; 3rd, H. Mackereth.

LOCAL CLASSES.

*Six Sections 1911 Honey*.—1st, H. Mackereth.

*Six Jars 1911 Honey*.—1st, C. Hudson, Lancaster; 2nd, J. Ward; r., J. Blair, Hale.

*War*.—1st, Mrs. J. Long, Newton-in-Cartmel; 2nd, J. Wilson, Burton; r., P. M. Ralph.

*Exhibit of Bees and Bee Produce on the Most Educational Lines*.—1st, T. Ireland; 2nd, C. Hudson.

COTTAGERS' CLASSES.

*Six Jars 1911 Honey*.—1st, J. Blair; 2nd, I. Willan; r., J. Ward.

*Three Jars 1911 Honey*.—1st, J. Blair; 2nd, T. Edmondson, Caton; 3rd, J. Ward.—(Communicated.)

[We have had the pleasure of visiting this show for several years past, and have with pleasure watched its growth. The honey staged was of excellent quality and the arrangements were perfect, a credit to the local hon. secretary, Mr. W. Lloyd, whose perseverance and energy might be copied with advantage by others. This association, which a few years ago was practically extinct, has now asserted itself, and is one of the most important in the country, thanks to the splendid work and influence of its chairman, Dr. Anderton, of Ormskirk, and the late hon. secretary, Mr. J. N. Bold, of West Derby.—Ed.]

#### LEICESTERSHIRE B.K.A.

ANNUAL SHOW

The L. and R.B.K.A. exhibition of honey and bees was a very fine display, and the task of the judges proved to be a difficult one, more especially in the light honey classes. The show of the products of the apiary was larger and more varied than for many years past, and was considered by those most competent to judge to be a record.

The association was fortunate in securing the services of Mr. W. Herrod, secretary of the B.B.K.A., as judge, and he was assisted by Mr. H. M. Riley, of Mel-

bourne House, Leicester, who was one of the founders of the L. and R.B.K.A., and to whom the association has been greatly indebted in the past. During the afternoon three lectures were delivered by Mr. Herrod on "Bee-keeping for Profit." These proved to be very attractive, illustrated as they were by a hive of live bees. As usual, the observatory hives, showing the bees with their queens at work, were a great attraction. To Mr. J. Waterfield, the indefatigable secretary of the association, the thanks of the members are due for the excellence of the arrangements for showing, and generally for the well-being of the association. Awards:

CLASS 1.

*Observatory Hive of Bees*.—1st, S. Clark, Humberstone; 2nd, W. H. Fountain, Leicester.

CLASS 2.

*Twelve Sections Comb Honey*.—1st, A. J. Marriott, Market Harborough; 2nd, W. W. Faulkner, Market Harborough; 3rd, Mrs. Waterfield, Kibworth.

CLASS 3 A.

*Twelve Bottles Light Coloured Honey (North Leicestershire)*.—1st, G. S. Jesson, Hosc; 2nd, H. Smith, Melton; 3rd, B. Walker, Seagrave; 4th, Miss A. E. Draycott, Seagrave; v.h.c., J. Payne, Lutterworth; c., C. Pick, Barkby, and C. S. Spray, Melton.

CLASS 3 B.

*Twelve Bottles Light Coloured Honey (South Leicestershire)*.—1st, H. Dilworth, Shangton; 2nd, Mrs. Waterfield, Kibworth; 3rd, J. Waterfield, Kibworth; 4th, J. O. Veazey, Wilbarston; v.h.c., W. Ruddick, Desborough; c., H. Burditt, Desborough.

CLASS 4.

*Twelve Bottles Dark Coloured Extracted Honey*.—1st, Chas. Bottrill, Kimcote; 2nd, J. Kenney, Cosby; 3rd, B. Walker, Seagrave; v.h.c., A. E. Biggs, Cropstone.

CLASS 5.

*Three Shallow Frames of Comb Honey*.—1st, J. Waterfield, Kibworth; 2nd, F. Hubbard, Leicester; 3rd, H. Dilworth, Shangton; c., E. A. Jesson, North Kilworth.

CLASS 6.

*Twelve Bottles Granulated Honey*.—1st, J. Garratt, Willoughby Waterless; 2nd, J. Hunt, Botcheston.

CLASS 7.

*Honey Display*.—1st, J. Waterfield, Kibworth; 2nd, T. E. Weston, Hugglescote.

CLASS 8.

*Six Bottles Dark Honey (novices)*.—1st, M. E. Varley, Castle Donington; 2nd, Mrs. W. H. Wood, Aylestone.

## CLASS 9.

*Six Sections Comb Honey (novices).—*1st, T. E. Weston, Hugglescote.

## CLASS 10.

*Six Bottles Light Honey (novices).—*1st, E. S. Jesson, Hose; 2nd, W. Harts-horne, Market Harborough; 3rd, Miss A. E. Draycott, Seagrave.

## CLASS 11.

*Honey Beverage.*—1st, H. Geary, Enderby; 2nd, Mrs. Parkinson, Groby.

## CLASS 12.

*Sample of Beeswax.*—1st, H. A. Wheat-croft, Ashby; 2nd, E. Varty, Diseworth; 3rd, C. Böttrill, Kimcote; v.h.c., M. E. Varty, Castle Donington.—(*Communi-cated*).

### REVIEWS OF FOREIGN BEE JOURNALS.

By "Nemo"

*Mineral Constituents of Honey.*—In an article in the *Schweizerische Bienenzeitung* J. Frei tells us that dark honey contains more mineral matter than light honey, and as a consequence it has a far greater food value. The important mineral substances are phosphorus, calcium and iron. According to J. Frei, who has analysed 284 samples of honey, the amount of mineral matter in honey varies between 0.10 and 1.06 per cent. He has classed the honeys which he had submitted to analysis in four groups according to the amount of minerals they contain. In the first group there were seventy-four samples which contained 0.10 to 0.33 per cent. of mineral matter; in the second group ninety-six samples showed from 0.34 to 0.57 per cent.; in the third group eighty-two samples showed 0.58 to 0.81 per cent.; and in the fourth group thirty-two samples showed 0.82 to 1.06 per cent. of mineral matter. A comparison between light and dark honey showed that the latter contained very much more mineral matter than the former. Of the seventy-four in the first group sixty-eight were light and six dark; second group, seventy-five light and twenty-one dark; third group, ten light and seventy-two dark; and in the fourth group only three light to twenty-nine dark.

Calcium and phosphorus are constituents of the human skeleton and are absolutely necessary for bones deficient in lime, and are specially needed for scrofulous children. The brain also needs minerals, and those who have much brain work would be benefited by eating dark honey. The most important of the minerals is iron. Both plants and animals store iron in their cells which is absolutely necessary for their well-being. Without iron trees would be yellow and man anæmic. The human organism re-

quires a good deal of iron, especially in the blood. It is therefore much better to supply this necessary iron by means of honey than resort to chemical preparations. Anæmic persons should also eat a good deal of dark honey, as should also all nervous persons.

*Bee-keeping Proselytism.*—M. H. Ayme says in *Revue électorique d'Apiculture* that bee-keepers like to make converts to bee-keeping. They are so enthusiastic and have such a passion for their art that they would like everyone to share their enthusiasm. This spirit has some good in it, but should be moderated, otherwise if pushed too far it may lead to serious consequences. Everyone has not the ability to become a good bee-keeper, and a bad bee-keeper—he who only wishes to keep bees for what he can make out of them—is often a hindrance and may do much harm to the craft. The bad bee-keeper thinks he knows everything and does not wish for inspection; he does not purchase books, nor does he subscribe to a bee journal. He has no time to attend to his bees, although he is able to find time for amusement or for spending hours in a public house. His bees therefore do not produce anything like those of his neighbour, who is better instructed by reading, and more careful; consequently he accused his neighbour's bees of robbing his colonies. Should the season be a good one he sells his honey at any price he can get, but if it is a bad year he allows the bees to die of hunger, and does not notice their condition until some months after they are dead and the combs full of wax-moth. Instead of blaming himself for want of attention he attributes his disasters to advice which he has sought and which he has failed to follow. The worst comes when foul brood appears, the greatest breeder of this pest being the careless bee-keeper, who leaves about hives in which bees have died of the disease without destroying the contents or disinfecting the hives, thus rapidly spreading the malady in the whole neighbourhood. Discretion should be used in inducing persons to begin bee-keeping. Of ten who take to it perhaps two only succeed, and it is a good thing to impress on aspirants that bee-keeping requires learning like every other industry.

### HELPFUL HINTS FOR NOVICES.

By W. Herrod.

*Driven Bees.*—Let us hope that the driving of bees will soon become as great a curiosity as it was when commenced some years ago, to save the lives of condemned bees. The sooner the old-fashioned skep becomes a thing of the past the better for bee-keeping under the

modern system. That skeps abound to-day in some of our more rural districts is due to that conservatism which is so characteristic of the Britisher, more particularly with those of us who live in the country. We bemoan our fate and inability to make money, when ninety-nine times out of a hundred the fault lies at our own door. Lack of endeavour to take full advantage of all our opportunities is generally the stumbling block to progress. Then again, superstition often bars the way. I have found this even amongst the educated class of these Islands. It is a hopeful sign of the times, when we find bee-keepers complaining of the driving part of the practical portion of the examination for the third-class certificates of the British Bee-keepers' Association on account of their inability to obtain practice in the work through lack of skeps in the district. I was in the Midlands the other day, and was assured there that it would be difficult to find a skep of bees within twenty miles. While this is the case in some districts, there are others where skeps predominate. While this state of affairs continues, and until we obtain legislative powers to banish the skep for ever, it is advisable to know how to carry out the work in an efficient manner.

While admittedly a nuisance, yet the skeppist is useful to the bee-keeper who follows the right system of moveable combs in so much that he provides the bees either for making new colonies or for strengthening those which otherwise would not survive the winter for lack of numbers. If the bees are required only for strengthening purposes, it is only necessary to obtain them and unite to those already in possession of the hive. If for new colonies, then it is essential that combs should first of all be obtained.

This can be done in two ways: by reducing the colonies already possessed to eight frames, thus obtaining two from each. This method also has another advantage in that a certain amount of natural stores will be obtained for the driven lots. Or at the commencement of the season, with the idea of obtaining driven bees in view, colonies can be supered with standard frames instead of shallow. To do this it will be necessary to use a 3in. ske under the shallow frame-box. After extracting the honey these combs can be given wet to the driven lots obtained.

If obtained early in August, and the weather is favourable, the driven bees will build their own combs from foundation if kept going with a constant slow supply of food. This can rarely be done, as the skeppist has an idea, which arguing to the contrary only convinces him the more that he is right, that the later the bees

stay before being taken up the more honey he will obtain, so that it is generally September before operations can be commenced.

While some skeppists are ready and anxious to have the lives of the bees saved, there are others who through selfishness or superstition will not permit the work to be carried out but insist upon killing the bees. Yet again, clumsiness or carelessness on the part of the operator the first time they are driven, causing robbing, fighting, and sometimes members of the household being stung, means that ever after driving the bees is taboo.

As a youngster I spent many, many days round the country districts in which I lived driving bees, and in this way learned the art by several bitter experiences.

The first thing to do is to choose the right day and time. My ideal day for driving was a wet one, for then all the bees were at home and any possible chance or robbing was averted. It also enables one to get through a vast amount of work in one day, and in daylight; this counts for much when the district in which the operations are to be carried out is a large one, and prevents covering the same ground several times. All that is necessary is an open shed such as a cart shed, or even a big gig umbrella, under which to work. Providing the weather is warm the bees will run all right; they can be fastened up and carried home straight away without waiting until dark.

Failing this then the work should be done in the evening, visiting each place in turn on successive nights, gauging the time so that the work will be completed just before it is dark.

It will be necessary to carry some receptacle into which the bees can be placed as driven. If there are only one or two lots then skeps will do very well tied over with scrim cloth. If there are a number to do, then it will be necessary to have a trap and a quantity of swarm boxes; or another method is to use swarm bags. A number of these can be carried on a cycle.

Before commencing to work find a nice sheltered position as far away from that occupied by the bees as possible. Have everything ready—table, smoker, carbolic cloth, driving irons, &c. Commence by first giving a few puffs of smoke into the hive to be operated upon, wait a few moments, then lift up, taking care to hold the carbolic cloth by two corners in the fingers in such a manner that when the skep is lifted it falls naturally over the combs. The cloth should only be a weak one, and care must be exercised in lifting the skep so that the combs are kept edgewise, for if it is warm weather, and



the hive is lifted so the combs are flat they will break down, and of course confusion will be the result. To ascertain the direction in which the combs run the skep should be just tilted a little so that a peep underneath can be obtained.

If the skep is a flat topped one it will rest on the table all right; if dome-shaped, then it will be necessary to have a bucket, which should be weighted with either water or bricks.

*(To be continued.)*

---



---

## Correspondence.

---

*The Editors do not hold themselves responsible for the opinions expressed by correspondents. No notice will be taken of anonymous communications, and correspondents are requested to write on one side of the paper only and give their real names and addresses, not necessarily for publication, but as a guarantee of good faith. Illustrations should be drawn on separate pieces of paper.*

---

### NOTES BY THE WAY.

[8232] This 14th August is the fifty-sixth day of the drought, with only a short shower of rain of about fifteen to eighteen minutes on Saturday, August 5th. We are, therefore, dried up, no water except the deep wells of 75yds. to 100yds., and some of the small farmers have to fetch water for their cattle from the mill streams several miles distant. And what of the bees, do I hear someone say? Well, they are retired from business, living on their means, which, I am glad to say, are adequate to carry them on for a long time. I don't think there is much breeding going on just now, as so few visit the watering places at which a supply is kept up; evidently bees do not suffer from thirst.

The month of July, 1911, will be long remembered for its honey-flow during the first three weeks and the well-filled sections, many of which scaled 17in. to 18in. with every cell sealed to the wood, and the quality is fair, not, of course, equal to the safoin and white clover blend of early June, but a good marketable honey. All supers should be removed from the hives, and the sections scraped clean of propolis and graded, and if no orders for them are waiting they can be stored for a time in the racks, first laying a piece of paper in the bottom of the rack and wedging them up tight. These racks, if made the height of the sections, can be stored, five or six, one on top of the other, in a dry room or cupboard, and the shallow combs should be extracted

during the warm weather, as the honey will leave the combs so much more freely.

The Solar Wax Extractor has worked efficiently this summer; Old Sol has poured down his beams week after week, and I would advise every bee-keeper to read over again our Editor's article (page 313) of last week's BEE JOURNAL, on wax extracting.

Re 8176, Page 315.—I should recommend barbed wire for the fence to keep the horses back. A few stakes with charred or tarred ends to drive into the ground would make a fence that the horses would not break or even try to break through. I have a meadow at the back of my home apiary (of close on 100 hives), and I have stakes and barbed wire. The cattle which are turned out there a good part of the year never trouble me; my old wooden fence they rubbed down a few years ago, but the barbs defy them. Have the fence fairly high, and plant a row of French beans or a thick row of artichokes at the back of your hives, or a row of black currant bushes. I myself have a quickset hedge now 7ft. high inside the wire fence, but on the road side of my garden or apiary I plant artichokes; these make the bees fly high over the road, so that not one in a hundred people passing by know there are bees kept near.

The reports I have received point to a fair take of honey this season for those who were fortunate enough to keep their bees alive, but the heavy death-rate of colonies last winter from starvation and "Isle of Wight" disease must restrict the output by nearly one-half in the southern part of the country. It behoves the fortunate bee-keepers not to take any offer for their produce, but to ask a fair price for it.—W. WOODLEY, Bredon, Newbury.

### SUGAR FEEDING AND DISEASE.

[8233] Our Roman friend (No. 8228 of Aug. 3rd) would have us believe that the feeding of sugar syrup is largely, if not wholly, the cause of the malady that has recently overtaken a number of British apiaries. Other writers have expressed similar opinions in the pages of your valuable and far-reaching journal.

No statement could be more devoid of reason nor more contrary to fact. We are asked to believe that a food containing no disease germs, or at least none that are injurious to bees, is the cause of their suffering from an infectious malady that is only to be transmitted from one colony to another by the germ peculiar to that disease.

Why should the feeding of a few pounds of good sugar cause an outbreak of the malady in one apiary, when another, with ten times the number of colonies, where in

dull seasons the autumn finds the owner feeding something like a ton of loaf sugar, is found to remain free from any infectious disease whatever? Why are there hundreds of apiaries where sugar feeding is yearly resorted to, still remaining free from infectious paralysis and other complaints?

Is our Roman friend not aware that quite a number of English writers, with no more show of reason, are bitterly attacking the race of bees which comes from his own favoured land, as being the great cause of all diseases bees in this country are troubled with? Was there ever such a libel upon a desirable race of bees, or one so flagrant flung at the heads of that large and honourable class of Italian queen-breeders?

England has no monopoly in the new (?) bee-malady, and I would like my friends of the opposition to remember that infectious paralysis has been known as quite an old complaint, and that it is usually one that troubles bees most in localities where feeding is seldom resorted to.

I have before me evidence of the disease having occurred in a dozen different States of the American Union, but principally in Florida, Texas, and California where feeding is not the rule. In 1906 onwards, the complaint was causing havoc in Australian apiaries, and writing in *Gleanings*, December 1st, 1908, Mr. J. A. Hutchison, of West Maitland, stated that in that district, and many others, it was almost impossible to find an apiary which had no signs of it. The trouble had also been prevalent about the year 1894, in New South Wales; but there is nothing to show that sugar feeding had anything whatever to do with its presence.

The editor of *Gleanings* had noticed the complaint as early as 1877 in the United States. Another American bee-keeper of experience, writing recently, had never been entirely free from the trouble for more than thirty years. Another writer of some note goes so far as to say that the bacillus affecting the bee is almost identical with that which so seriously affected the silk-worm. If this is so, then possibly we may get some light thrown upon the origin of the malady.

In America the disease does not appear to give much trouble in the north, and when affecting a colony the trouble usually goes off without attention; hence there is a ray of hope for our Scotch and Canadian friends who have been somewhat anxious as to the possibility of the dreaded plague reaching their apiaries. Excepting in heather districts, northern bee-keepers have to do a good deal of feeding, and yet the malady does not trouble them.

Hence, probably, we have to look to a return of normal winter seasons rather than a good honey year, as an aid to cure. Notwithstanding the apparent subsidence of paralysis of late in this country, it is a question whether the trouble has not only been smothered, and that it may appear again later.

Only a year or so ago some of our contributors were blaming the natural stores as the source of the malady; others suggesting that the disease was in the pollen collected. Although it is possible plants may be infested with certain bacteria, I think we may dismiss all these theories as having no direct bearing upon the peculiar trouble under consideration.

At the same time it goes without question that pollen, or honey—especially inferior honey—with floating pollen, may be seriously aggravating causes where the symptoms of paralysis are present. Thus we may get dysentery, although infectious paralysis is not usually accompanied by that complaint, except as a result of confinement. Contrary to general opinion, the trouble appears to be constipation, with paralysis, both probably resulting from fever.

Because of the very fine weather there are now thousands of colonies which will stand in poor plight for wintering, simply because the combs are choked with those natural stores some of our friends consider to be desirable; and where there is any sign of the so-called new malady the excessive store of pollen will seriously discount the chances of successful wintering. There is, of course, yet time to make such preparation as should avoid disaster, but few will do other than let, what they consider, well alone.

Of course during the busy season workers and virgin queens, to say nothing of drones, will have access to nothing but natural food, especially pollen; but in wintering there are certain advantages in supplying a pure sugar syrup, free from pollen and known to contain no disease germs; a condition one is not always sure of with honey.

Professor A. J. Cook says: "Good sugar syrup is much the safest in winter." At one time Mr. James Heddon proved that his bees wintered safely on sugar stores where formerly he had great losses on natural stores. Mr. A. I. Root, when himself editing *Gleanings*, showed how he had fed barrels of sugar, and had no spring dwindling, while his neighbours who wintered their bees with natural stores lost heavily by that trouble.

Evidently, as is well known to all bee-keepers, the workers will not take syrup at the period they are doing their heaviest work; hence while sugar may be productive

of equal heat, and is known to produce more wax than pure honey, we need have no fear that sugar feeding at intervals will cause any deterioration of their natural vitality. On the other hand it has been proved by those who have fed sugar by the ton that their bees do better on it as a winter food.—SAMUEL SIMMINS, Heathfield.

### CAPPINGS OF COMB.

BY L. S. CRAWSHAW, NORTON, MALTON, YORKS.

*Swarm Control* (page 275).—Mr. Stapleton's reply to Mr. Pinkney does not seem quite conclusive, nor so novel as his first letter (page 244). Everyone knows that newly-hatched virgin queens are accepted without difficulty, and that colonies will accept older virgins after a dequeened period. The point of interest and possible dispute, which appeared to be raised, was that virgin queens received by post could be safely introduced (à la Simmins) without dequeening. Now is this so, or not so? If it were invariably successful, I think that we should have had a claim to that effect from Mr. Simmins himself. It is also reasonable to suppose that any colony building queen-cells will accept a virgin. But to confine the process to such time as a swarm is expected is to narrow its use exceedingly. Even so, it may be of distinct value, and cheaper than a lot of swarm-catchers. The point I would like to see cleared up, and which Mr. Stapleton appeared to emphasise (page 244), is whether a postal virgin can be safely run into a hive without opening or dequeening. For a virgin is not fit to travel until several days old, and so must necessarily be an "old" virgin rather than a just-hatched bee.

*A Drone Breeder* (page 282).—It is hardly surprising that these bees made no attempt to rear a queen, as apparently there were no young bees in the hive. Old bees are very reluctant to start queen-cells under such circumstances, and were they to try to rear a queen, she would certainly be of an inferior order. Even young bees, which have not been feeding larvæ, require some notice in order to prepare food.

*Bee Stings* (page 283).—Mr. Byles appears to challenge competition by his assertion of equality of experience. Perhaps I may be permitted to offer my testimony for what it is worth. In the year — I proceeded to take off a section rack, and had carried it some distance before I noticed that the hive was still attached to the under side of it. Hardly had I made the discovery when the hive fell away, which for some reason or other seemed to excite the bees. These

attacked me furiously, and stung me repeatedly through my shirt. When the bees had one and all expressed their opinion, I was able to carry the now beeless combs back to the apiary in comfort, and proceed to my own injuries. It was found impossible to remove the shirt in the ordinary way, as it was firmly nailed down, like a carpet, by thousands of stings, and it had to be cut from my back. The ends of the stings, which remained bristling in my skin, caused me some slight discomfort, and as they were too numerous and too close for separate extraction, relief was obtained by sand-papering them level with the epidermis. After a night's rest in a sheet soaked with Mother Siegel's Naphthol-Beta Solution I felt no ill-effects, and was able to go and fetch the super which had caused all the trouble.

*Dealing with Swarmed Stocks* (page 286).—One way of dealing with a similar case to that stated by W. H. C. would be to unite the No. 4 swarm and No. 5 cast and divide the four frames, giving one to No. 3 and three to No. 4. If, however, No. 1 or No. 2 were queenless I should insert the cast, combs and all, dividing the removed frames between No. 3 and No. 4. If Nos. 1 or 2 were merely weak, unite with the cast, and requeen one of the swarms with the queen of the cast. The whole of these operations, and perhaps some even better plan, are covered in the advice given, which shows how difficult it must be to deal succinctly with queries without actually seeing the conditions. The reply might very well be read in connection with the practical notes on page 293.

*The Treasury Grant* (page 291).—It is with something like amazement that one reads of this grant. Bee-keeping is apparently coming into its own, and being recognised as the important rural industry that it is. It is possible that we may have to thank the "Isle of Wight" disease in some measure for this. The recognition of the British Bee-keepers' Association as the channel through which the development is to take place is most gratifying, and a proof of the practical intentions of the Commissioners. This recognition should disarm the criticism of some of those who imagine that all sorts and conditions of inspectors will be appointed ignorantly to harass the bee-keeping community.

### HONEY IMPORTS.

The value of honey imported into the United Kingdom during the month of July, 1911, was £2,229.—From a return furnished to the BRITISH BEE JOURNAL by the Statistical Office, H.M. Customs.

## Queries and Replies.

[8191] *Shallow frame for show.*—

(1) In classes for shallow frames does it matter what width the comb is? Some of my best shallow frames were only spaced  $1\frac{1}{4}$  in. (2) How ought shallow frames to be glazed? (3) What is the best material for straining honey? (4) Can you recommend any book dealing with honey for the show bench?—N. Y. Z., Kent.

REPLY.—(1) Shallow frames should be so built that the cappings protrude sufficiently beyond the wood-work to allow them to be cut off comfortably with the uncapping knife without having to dig into the comb. It is best to work eight frames to the super, but that is immaterial, so long as the above conditions are obtained. It is also best to have the comb composed of drone cells with each cell clearly defined. (2) Cases are sold for the purpose of showing shallow frames by all manufacturers of appliances. (3) Old flannel. (4) There is no good work dealing with the preparation of honey for the show bench. When the slack season comes along we hope to publish one, fully illustrated, by the Assistant Editor of this journal. It will deal with the subject in an exhaustive manner.

## Bee Shows to Come.

**August 23 and 24, at Shrewsbury.** Annual Show of the Shropshire Bee-keepers' Association, in connection with the Shropshire Horticultural Society's Great Floral Fête. Eight Open Classes for Honey. Free entry for single bottle and single section. Schedules from S. Cartwright, Hon. Sec., Shawbury, Shrewsbury. Entries closed.

**August 24, at Wooler, Northumberland.** Annual Show of the Cheviot and Tweed Borders B.K.A., in connection with the Glendale Horticultural Show. Two open classes. Schedules from Robert Robson, Cheviot Street, Wooler. Entries closed.

**August 26, at Kettering.**—In connection with the Kettering Working-Men's Horticultural Society's Show. Open Class for Honey, single 1lb. jar. First prize value 16s. Entries free. Schedules from Hon. Sec., W. Heritage, 114, King Street, Kettering.

**August 29, at Cartmel, Lancs.** Bee and Honey Show in connection with the Cartmel Agricultural Society's 29th Annual Show. Liberal prizes. Open classes. Schedules from J. N. Parker, Cartmel, near Carnforth.

**August 30, at Chester.**—Annual Show of the Cheshire B.K.A. in connection with the County Agricultural Show. Several Open Classes. Good prizes. Schedules, &c., from Hon. Sec., E. W. Franklin, Mouldsworth, near Chester.

**August 30 and 31, at Carlisle.**—Annual Honey Show of the Cumberland and Westmorland B.K.A. in connection with the Carlisle Horticultural Society's Exhibition to be held in the Covered

Market, Carlisle. Schedules from G. W. Avery, Hon. Sec., Heads Nook, Carlisle.

**August 30 and 31, at Coventry.**—Annual Show of the Warwickshire B.K.A., in connection with the Warwickshire Agricultural Society. Separate tent for Honey, Wax, and Appliances. Open Classes. Schedules, &c., from J. N. Bower, Knowle, Warwickshire.

**September 6, at Deddington, Oxon.**—Show of the Deddington Horticultural Society. Open Class for Honey. Prizes, 10s., 5s., 3s., 2s. No entry fee. Schedules from Messrs. H. J. Harmsworth or A. A. Busby, Deddington. Entries close September 1.

**September 7, at Peterborough.**—In connection with Horticultural Society. County Association Class and four Open Classes. Schedules from G. T. Dunham, Albion Terrace, 32, Oundle Road, Peterborough. Entries close September 1.

**September 12, at Woodstock.** Oxfordshire Bee-keepers' Association Annual Show. Open Classes. No entry fee for the best Section, for the best jar of Run Honey. Prizes 7/6, 5/-, 2/6. Entries to H. M. Turner, 4, Turl Street, Oxford. Entries close September 9.

**September 13, at Conway, N. Wales.**—Great Annual Honey Show in connection with the Conway Honey Fair. Open and local Classes. Schedules from J. Hughes, Town Hall, Conway. Entries close September 6.

**September 13 and 14, at Cambridge.**—Honey Show in connection with the Cambridge and District Red Cross Horticultural Society. Four Classes, open to all. To be held in the Corn Exchange, Cambridge. Schedules and particulars of Hon. Sec., E. F. Dant, Member of B.B.K.A., 52, Bridge Street, Cambridge. Entries close Saturday, September 9.

**September 14, at Castle-Douglas.**—Annual Show of South of Scotland Bee-keepers Association. Five open classes; Three 1-lb. jars extracted, 20s., 10s., and 5s.; three sections, ditto (Entry 2s.), 1lb. jar, also one section, 5s., 3s., and 2s. (Entry free, and exhibits retained unless otherwise agreed upon). Beeswax, 5s., 3s., and 2s. (Entry 6d.). Fourteen classes for members. Schedules from Q. Aird, Schoolhouse, Howwood, Renfrews. Entries close September 2.

**September 16 to 23, at the Agricultural Hall, London.**—Honey Show in connection with the 19th Annual Exhibition and Market of the Grocery and Kindred Trades. Liberal prizes. Open to all British Bee-keepers. Schedules from H. S. Rogers, Secretary, Exhibition Offices, Palmerston House, Old Broad Street, London, E.C.

**September 26, at Horniman Hall, North End, Croydon.**—Exclusive Show of Honey, Wax, Hives, Bees, &c. Increased prizes. Six Open Classes. Judge, Mr. W. Herrod, F.E.S. Schedules from A. Wakerell, 21, Mansfield Road, Croydon. Entries close September 16.

**September 27, at Altrincham.**—Honey Show, in connection with the Altrincham Agricultural Show, the largest one-day show in the Kingdom. Classes open to United Kingdom. Classes for Trophy of Honey, for Best Hive, Observatory Hive with Bees and Queen, twelve Jars of Extracted Honey. Classes open to County of Chester, for Run and Section Honey, Wax, &c. Special Classes for Cottagers, and Special Classes for Society's District. Several Special Jubilee prizes. Schedules from Mr. J. Herbert Hall, 2, Dunham Road, Altrincham. Entries close September 9, and at extra fees September 13.

## Notices to Correspondents.

H. W. (Gravesend).—*Harm of Plants.*—This is *Brassica campestris*. One of the numerous members of the mustard family.

D. SYMON.—*Comb with Pollen*.—The comb contains pollen from clover. It happens occasionally that bees carry pollen through the excluder, but it is curious that they should store it only in this small piece of comb.

C. Y. (Wembly).—*Finding Queen*.—We do not think your plan will succeed. You should have covered the entrance with excluder zinc, placed a board as for hiving from alighting board to ground, then taken the combs one by one, brushing the bees off on to the board, and allowing them to run back. The old queen would then have been left at the entrance as she could not get through the excluder.

ENQUIRER.—*Judging Sections*.—The chief points in judging sections are filling, sealing, flavour, colour of honey, and general get up. We should judge from what you say that the judge was biased on white capping, but it is difficult to say without actually seeing the exhibits. It is most difficult to realise that one's own exhibit is not better than a competitor's.

*Suspected Disease.*

W. J. H. (Chatham).—It is a case of black brood. Treat as for foul brood, as per instructions given in the "Guide Book," which you have.

ANXIOUS READER.—The bees are suffering from malignant dysentery.

R. U. (Farnham).—*Parasites on Queen*.—The queen is infested with *Braula cœca*.

SUFFOLK (Leicester).—Sorry to say both samples are affected with foul brood.

*Honey Samples*

A. S. (Woodley).—No. 1, good in all points except density and colour, which is rather dull. No. 2 is a good, light honey, good in all points except density, but no doubt this will improve with keep. Show No. 2.

HAZEL GROVE.—No. 1 is by far and away the best sample. They are both from clover, and there is not the slightest trace of honey-dew in either. Show No. 1; the other is very, very thin, and would not stand the slightest chance of winning. It should be shown in the light class.

IDEA (Herefordshire).—No. 1 is a light sample, rather thin, flavour medium. No. 2 is a medium honey, better than the other in all points. The tiny particles are not wax, but the commencement to granulation.

W. C. (Biggleswade).—Both samples are from clover. No. 1 is the lightest, and is also more dense than the other. They are both very bright, and excellent in flavour. If you exhibit at all let it be No. 1.

NOVICE (Manchester).—The samples are all good from clover. No. 3 being the thickest, and equal to the others in every other respect, would stand the best chance if shown, and is certainly worth while trying.

H. J. (Hexham).—The sample this time is good in all respects except density, which by proper treatment you can improve. We hope your expectations at the Moors will be realised.

X. Y. Z. (Kent).—There is not much chance to criticise the sample sent; it is good in every respect, is from clover, and is certainly worth showing. It is well strained.

H. W. L. (Pinner).—No. 2, good in colour, flavour, aroma, and density is a light honey. No. 4 is of medium colour, tastes as though it had been warmed, flavour poor, density fair. No. 5 is a light honey, density and flavour fair, colour good. The three samples consist mainly of clover honey.

A. W. G. (Huyton).—The honey is a delicious heather, blend good in all points, and we are very pleased indeed to hear you have obtained so much. Write to Mr. H. S. Rogers, Palmerston House, Old Broad Street, London, E.C. for schedule of Grocers' Exhibition.

J. P. (Salisbury).—The honey is a very nice sample, but lacks a little in density; it is from clover with a little charlock, and was nearly granulated solid when it reached us.

DRUMCROG.—All three samples are good in flavour, aroma, and colour; in density they are somewhat lacking. For the purpose of showing we should select No. 1. The honey is from clover.

**NOTICE TO READERS.**

From time to time we receive complaints from subscribers who answer advertisements appearing in our columns that they cannot get a reply, even though a stamped addressed envelope has been enclosed for the purpose. If even the goods written after are sold, common courtesy demands that at least a post-card should be sent saying so.

At the same time, it is obviously unfair to write asking a number of questions about the goods without enclosing a stamp for reply.

As a favour we ask that in future our customers pay attention to these matters.

We are aware that at times, owing to our large circulation, enquiries are so numerous that a reply to each would absorb all the money taken for the goods sold. In such cases, therefore, we shall be pleased to insert a note to that effect gratis in the columns of BEE JOURNAL.

**Special Prepaid Advertisements**

**Two Words One Penny, minimum Sixpence.**

Orders for three or more consecutive insertions entitle advertisers to one insertion in "The Bee-keepers' Record" free of charge.

Trade advertisements of Bees, Honey, Queens, and Bee goods are not admissible at above rate, but will be inserted at 1d. per word as "Business" Announcements, immediately under the Private Advertisements. Advertisements of Hive-manufacturers can only be inserted at a minimum charge of 3s. per ½ in., or 5s. per inch.

**PRIVATE ADVERTISEMENTS.**

**BEST SCOTCH SECTIONS, 10s. 6d. per dozen.**—C. GARFITT, Barnside, Coupar Angus, Perthshire. K 76

**EXCHANGE** gold cased hunter for extracted honey.—M. C., 284, New Avenue, Acocks Green. 1 96

**HEALTHY DRIVEN BEES** for sale, 3s. 6d. per lot.—WOODING, Sutton, Sandy, Beds. 1 97

**HONEY, good colour, flavour and well ripened,** 58s. per cwt. on rail; tins free; ½lb. sample six stamps.—J. IRELAND, Vernham, Hungerford, Berks. 1 98

**YOUNG MAN** seeks situation on bee farm. Carpenter by trade. Can make hives, frames, &c. Well up in bee driving and manipulations.—C. WACKFORD, Goodwood, Chichester. m 5

**HEATHER SECTIONS** for sale. What offers?—HELME, Norton Canon, Weobly, Herefordshire. m 4

**FOR SALE, 5-h.p. Lloyd Motor Cycle,** in good condition, Palmer's tyres; price £6 10s.; also 3½-h.p. Lincoln Elk, just been overhauled, very fast and reliable; new tyres; a bargain, £11 10s.—H. DRAYTON, New Bovingbroke, near Boston. m 6

**SABLE Pomeranian, female; good pedigree;** include champion; will exchange for Bees or Honey.—Apply, T. MAYNARD, 175, High-street, Guildford. 1 100

**HONEY PRESS.**—A grand strong heather press, specially made to order and greatly superior to anything sold by dealers. Good as new. Price £1, or exchange for bees.—E. FRANKLIN, Mouldsworth, Chester. 1 95

**WANTED, Honey Press** in good order, to take sections.—Apply, VICAR, Milton, Pewsey. 1 85

**FOR SALE.**—Fine Clover Honey, sample, 2d.—MARSHALL, 68, Chelmsford-street, Lincoln. 1 89

**HEALTHY FERTILE QUEENS, 2s. 9d. each.**—HALL, 15, Borough, Huddersley. 1 91

**OBSERVATORY HIVE, mahogany, ornamental,** complete with turntable, tunnel, feeder, section frames.—Particulars, offers, ROBERTSON, St. Mary's Crescent, Portsmouth. 1 90

**WANTED, 12 Lots of Healthy Driven Bees.** Will give 30s. cash, and two new W. B. C. Hives, value 30s., complete with Standard Bar frames. Photo. of hives free.—BEN CASTELOW, No. 72, Nicholson-street, Portrack Lane, Stockton-on-Tees, Durham. 1 95

**FOR SALE, grand stock of Bees, in bar frame** hive, 1911 Queen, 25s.—BENN MOFFAT, "Emmerdale," Cleator, Cumberland. 1 88

**PREPARE** for Driven Bees, 18 empty hives to take standard frames; good condition; healthy.—BECKENSALL, Ringwood, Hants. 1 87

**WANTED, 5cwt. Clover Honey** and 1 gross sections.—State lowest price, carriage paid, EDWARDS, chemist, Fallowfield, Manchester. 1 86

**EXTRACTED HONEY, fine sample, 28s. per** 55lb. tin—tin included; 1lb. screw cap jars, 7s. 6d. dozen, 27s. per gross.—AVERY, Deverill, Warrminster. m 9

**"BEE JOURNALS,"** September, 1893, to date, complete and clean, cheap.—BUGDEN, Wye, Kent. m 1

**CHOICE PROLIFIC HYBRID QUEENS, Carnio-**lian and Italian, tested; safe arrival in cage guaranteed; 4s.—H. CEILEY, Higheroft, Muswell Hill-road, Highgate, N. 1 94

**A LARGE** quantity of new and second-hand appliances; also stock; must sell, leaving; send for list.—HIGGINSON, Egerton, Kent. m 3

**3 CWT. Choice Hampshire Honey, in 28lb. tins,** 65s. cwt., sample 3d.—ARCHER, Eastfield-road, Andover. 1 92

**25 STOCKS FOR SALE, in good W.B.C. Hives,** headed young Queens, guaranteed healthy; overstocked only reason for sale; exceptional opportunity to acquire reliable stock; also various appliances, and shed 11ft. by 7ft.—W. H. SIMS, Hall Green, Birmingham. 1 80

**SECTIONS, 8s. 6d. per doz.; also 1lb. screw** top bottles, same price.—A. WEELEY, Weeley, Essex. 1 77

**FOR SALE, 11 acres FREEHOLD LAND,** situate at Lambourn, Berks, £240; two-thirds can remain; good site for bee farm.—WADHAM, 5, Gold-street, Routh, Cardiff. 1 59

**FINEST FLOWER HONEY, in sections, 10/6** per doz.; extracted Honey, in tins, £3 per cwt., sample 2d.—WILLIAM WILSON, 25, Forfar-road, Kirriemuir. 1 60

**SECTIONS WANTED, for cash; send lowest** price, any quantity, and extracted.—F. W. WEITZEL, 45, Kempe-road, Kensal Rise, N.W. 1 64

**BUSINESS ADVERTISEMENTS.**

**NEW SIGHT HONEY, in bulk, 56s. cwt., or in** 1 lb. jars, 8s. 6d. doz.—CHARTER, Tattingstone, Ipswich. m 8

**REDUCING STOCK, few lots Driven Bees** with Queen, 5s., boxes free, Spare Queens, 2s. 2d. (Query's stamp).—ROLLINS, Stourbridge. m 7

**"THE BEE-KEEPERS' COMPANION,"** by S. Shapland Abbott. Just published, price 1s. 6d. nett, post free 1s. 8d.—ABBOTT BROS., Southall, near London.

**HEALTHY DRIVEN BEES (ready), with 1911** Queen, 5s.—HIGLEY, Expert, 49, Franchise-street, Kidderminster. 1 99

**HEALTHY DRIVEN BEES, with Queens, 6s.;** Queens, 2s. 9d. each.—BRADFORD, Expert, Worcester 1 33

**FINEST CLOVER SECTIONS, 8s. 6d. doz.;** ditto, extracted, 30s per cwt.—STEED, "Fennes," Braintree. m 2

**DRIVEN BEES.**—For dispatch August 25rd, 12 lots, in free boxes, 5s. per lot, guaranteed healthy.—AVERY, Deverill, Warrminster. 1 85

**HIVES in the flat carefully prepared; 3, with** frames, 21s.; tins, feeders, &c.; catalogue free.—BURTT, Manufacturer, Gloucester. 1 81

**HEALTHY DRIVEN BEES, young Queens, 5s.** lot, boxes free.—KEMP, Clink, Frome, Somerset. 1 71

**MESSRS. STONE and SONS, Chemists, Exeter,** are buyers of English Beeswax, in large or small quantities.—Write, stating quantity and price required.

**SECTIONS WANTED for cash; send lowest** price, any quantity.—F. W. WEITZEL, 45, Kempe-road, Kensal Rise, N.W. 1 63

**PROLIFIC HYBRID QUEENS, 15 years' experi-**ence, fertiles, 4s.; virgins, 2s.—MOORE, 10, The Avenue, Bedford. 1 23

**DRIVEN BEES WANTED, 1s. 6d. lb. cash,** boxes returned carriage paid.—A. W. GAMAGE, Ltd., The Holborn Apiary, Church End, Finchley, N.

**1911 CARNIOLAN QUEENS, mated in** Carniola, Austria, 4s.; Swiss 5s.; Italians, 3s.; delivery in one week.—F. VOGT, 32, Selwyn Avenue, Higham's Park, Essex.

**SECTIONS, new, wanted, by the HONLELADE** Co., 25, Moorfields, E.C. 1 24

## Editorial, Notices, &c.

### KENT HONEY SHOW.

The tenth annual Kent Honey Show was held at Wye on August 9th last, and proved a great success.

The exhibits numbered over 300, the exhibition being the largest and finest ever held at Wye. This year many prizes were won by exhibitors from the Thanet district, the hot, dry weather having specially favoured bee pasturage in that part of Kent. It was very encouraging to note such a number of new exhibitors and prize-winners (many of them beginners).

Mr. J. Garratt kindly acted as judge and made the following awards:

#### KENT COUNTY CLASSES.

*Six 1-lb. Sections and Six 1-lb. Jars of Extracted Honey.*—1st (Past President Sir Robert Filmer's Silver Challenge Cup), W. J. Moody Smith; 2nd, E. R. Nash; 3rd, S. Burden; h.c., Miss Smiles.

*Six 1-lb. Sections.*—1st (President, Sir Marcus Samuel's Silver Challenge Cup), Mrs. Davis; 2nd, A. J. E. Baker; 3rd, F. E. Green; 4th, W. J. Moody Smith.

*Two Shallow Frames.*—1st, E. R. Nash; 2nd, Miss Ambler; 3rd, T. Head; 4th, Miss Smiles.

*Six 1-lb. Jars Extracted Honey (dark).*—1st (Past President the Rt. Hon. the Earl of Guildford's Silver Challenge Cup), R. P. Potter; 2nd, A. J. E. Baker; 3rd, F. E. Green; 4th, J. T. Head; v.h.c., G. M. Norton; h.c., E. R. Nash, T. Head, R. Gray, A. Humphrey, H. C. Chapelow, R. Rossiter.

*Six 1-lb. Jars Extracted Honey (medium).*—1st, G. W. Judge; 2nd, W. Monger; 3rd, Miss E. Richford; 4th, W. K. Boys.

*Six 1-lb. Jars Extracted Honey (dark).*—1st, Miss Smiles; 2nd, R. Gray; 3rd, H. C. Chapelow; 4th, E. R. Gray.

*Three 1-lb. Sections and Three 1-lb. Jars of Extracted Honey.*—1st, F. E. Green; 2nd, S. Burden; 3rd, T. Head.

*Bee-swax.*—1st, Miss Smiles; 2nd, W. J. Moody Smith; 3rd, H. C. Chapelow.

*Mead.*—1st, A. E. Allechin; 2nd, Mrs. Hall.

*Bee-Candy.*—1st, Miss Smiles; 2nd, A. E. Allechin.

*Single 1-lb. Jar Granulated Honey.*—1st, J. G. Hall; 2nd, R. Dockeray.

*Honey Cake.*—1st, Mrs. Wilson; 2nd, Mrs. A. Lepper; 3rd, Miss Gettings.

*Three 1-lb. Sections (Novices).*—1st, C. Hutchinson; 2nd, S. Jordan; 3rd, A. E. Barnes.

*Three 1-lb. Sections (Cottagers').*—1st, J. Pack; 2nd, S. Jordan; 3rd, J. Goodsell.

*Two 1-lb. Jars of Extracted Honey (Cottagers').*—1st, J. Chittenden; 2nd, E. H. Philpott; 3rd, S. Jordan.

### KENT, SURREY, AND SUSSEX CLASS.

*Trophy of Bee Products.*—1st, Mrs. Hall (champion silver cup).

#### OPEN CLASSES.

*Single 1-lb. Jar Extracted Honey (light).*—1st, R. P. Potter, Minster, Thanet; 2nd, H. W. Saunders, Thetford, Notts; 3rd, J. G. Hall, Wye.

*Single 1-lb. Jar Extracted Honey (medium or dark).*—1st, Miss M. Richford Headcorn; 2nd, E. R. Nash, Smarden; 3rd, R. Dockeray, Westwell.

*Single 1-lb. Section.*—1st, T. G. Hillier Andover; 2nd, R. W. Lloyd, Thetford; 3rd, L. Watson, Crawley Down.

*Beginner's Outfit.*—1st, T. Head, Canterbury.

*Three 1-lb. Sections, and Three 1-lb. Jars of Extracted Honey (Members of Ashford and District Association).*—1st, S. Darlington, Charing; 2nd, W. J. Moody Smith, Pluckley; h.c., J. Mephram, Orlestone. H. C. CHAPELOW, Hon. Sec.

### HITCHIN AND DISTRICT B.K.A.

The first show in connection with this newly-formed association was held at Letchworth on August 7th. The honey shown was of exceptionally high quality, and the show was considered the best held in the district. The exhibits were judged by Mr. G. W. Bullamore (Albury) and Mr. R. Watson (Hitchin). The secretary exhibited a display of honey not for competition, and also an observatory hive of bees. The judges' awards were as follows.

*1-lb. Section of Honey.*—1st, J. Day, King's Walden; 2nd, P. Peters, Hitchin; 3rd, F. Hale, Letchworth; v.h.c., E. L. Price, Letchworth; h.c., A. Prince, Letchworth.

*1-lb. Jar of Light Honey.*—1st, A. Prince; 2nd, J. Day; 3rd, P. Peters; v.h.c., S. Carrington, Hitchin; h.c., P. G. Russell, Hitchin.

*1-lb. Jar Dark Honey.*—1st, F. Armstrong, Three Counties; 2nd, Jas. Allbon, Hitchin.

The new local Bee-keepers' Association have reason to be pleased with the following report made by the judge of the honey classes in connection with the show at Letchworth:—"The Hitchin and District Bee-keepers' Association are to be congratulated on the number and quality of the honey exhibits shown at Letchworth. In the light honey class the white clover flavour was pronounced in most of the exhibits, and although the urban character of the district was responsible for flavours from other sources, the value of the product from a commercial and gastronomical standpoint should prove very satisfactory. In the section class the exhibits were of a varying merit, and the prizes went to experienced bee-keepers, but as this is the

first exhibition of a society that has been recently formed for the purpose of improving the technique of bee-keeping in the district it is probable that at future shows a great improvement will be noticeable in this department. On the present occasion the bees, in many cases, had done well, and a little more knowledge on the part of their owner would have rendered competition much keener. As an initial effort the show must be considered an unqualified success."

#### THE BEE-KEEPING GRANT.

It is an astonishing thing that, while after many applications and years of struggling the efforts of the British Bee-keepers' Association have been crowned with success in obtaining assistance from the Government, we find a voice raised in protest. Yet such is the case, as will be seen by the following letter taken from *The Times*. It is more remarkable still when we consider the fact that the money is now in the hands of the Government to spend, and if the Association did not get a portion it would be spent in some other way. Had a special rate to be levied to obtain it we could have understood the protest somewhat; even then we claim that the industry is such an important one that it should have received assistance from this source long ago. Mr. Lamb's able reply in *The Times* is also appended.

To the Editor of *The Times*.

Sir.—Will you give space in your columns to a bee-keeper to say that he is not in the least grateful for the grant of money from the Board of Agriculture and Fisheries to which you refer in your issue of to-day? So far from feeling gratitude I wish to enter an emphatic protest against this spoon-feeding policy. Bee-keepers can get along quite well without State aid, which apparently is merely a means of putting into the pockets of one or two lecturers, money taken from the general body of taxpayers, who, Heaven knows, are drained sufficiently already. The money is not wanted, and bee-keepers should be ashamed to take it from their fellow-citizens who do not enjoy this particular hobby.

Yours obediently,

ERNEST E. WILLIAMS.

Ecclefechan, Lake-road,

Wimbledon, July 31.

To the Editor of *The Times*.

Sir.—It is difficult to realise the frame of mind in which a bee-keeper must be when he pens such a letter of protest as that appearing over the name of Mr. Ernest E. Williams in your issue of

August 3. One can only account for it as the result of that natural irritation which affects many persons in consequence of the widespread taxation under the present Government. But even if this is the explanation I think that your correspondent ought to experience some gratification at the knowledge that a fraction of what has been taken out of the pockets of his fellow-citizens, though infinitesimal in degree, will go towards promoting an industry in which he takes some, if not a very broad and enthusiastic, interest.

He seems to have quite misunderstood the purposes for which the Government grant of £500 has been made to the British Bee-keepers' Association. It is not to help expert bee-keepers, but to make known in country districts the advantages of modern methods of bee-keeping over the old-fashioned system of keeping bees in straw skeps, and to interest rural audiences in the business of bee-keeping by means of lectures of an elementary and introductory type. The special grant of £350 to provide an experimental apiary will enable a long-felt want to be supplied, since the best and latest appliances used in the industry will be provided for demonstration purposes, and those intending to become lecturers on apiculture will be properly trained for this important work.

It is well known that the success of the fruit-growing industry, from the point of view of the fertilization of fruit blossoms, is almost entirely dependent upon the agency of the honey-bee; in fact, if all colonies of bees were to be swept out of the country by disease there is no doubt that fruit-growers would be ruined. Even the prevalence of what is called the "Isle of Wight" disease has caused consternation in several fruit-growing counties, so much so that on March 27 a meeting of the Council of the National Fruit-Growers' Association was held to discuss what steps should be taken to deal with this new malady affecting bees. Professor E. S. Salmon said it was likely to cause a great loss to fruit-growers, as it was necessary for bees to visit flowers if good crops were to be secured.

I will not trespass upon your space to submit evidence as to the value of bees as fertilizing agents; but if your correspondent has access to *The Times* of December 28, 1909, he will find there some interesting facts on this important matter. A definite instance was given of peach trees covering forty acres being very poor fruit-bearers, but as a result of the introduction of stocks of bees into the orchard they in due course became heavily laden with fruit.

Your correspondent refers to bee-keeping as a hobby; but he must not forget



that there is also a practical business side, which is of much greater importance. In fact, this industry has so many distant ramifications that almost every tax-payer, whether rich or poor, is indirectly interested in its success."

Yours faithfully,

J. BERNARD LAMB.

3, Maitland Park Road,  
Haverstock Hill, N.W.

## AMONG THE BEES.

### CONTRACTION.

*By D. M. Macdonald, Banff.*

The art of contraction is little understood, and in the generality of cases is never practised. Whether a swarm is large or small, whether it comes off early or late in the season, whether the bees have little, much, or all the comb to build, they are run into the hive on the orthodox nine or ten frames, and left there to work their own sweet will, just as was done in the day when the skep was the only home of the bees. Nay, then bee-keepers did understand and carry out a system at least akin to contraction, for they had hives of so many pecks in capacity up to the large bushel size. A large swarm was given a large hive, and a small cast one of the smallest capacity. It is just as easy for modern bee-keepers to start fair with the bees, with the added advantage that they can contract or expand at any future period at their own convenience.

A large swarm, when hived, should be given the whole ten frames, especially if the weather is close and warm. In the evening of the following day draw the quilting aside to expose the outside frames on each side, and if they are not occupied withdraw them and contract the body-box by inserting dummies or drawing in the division board. This concentrates the whole force of bees on an area they can cover and effectively work, and it helps to conserve the heat, which is so necessary to the successful manipulation of wax at a time when it is being converted into hexagonal cells.

Smaller swarms or casts may be found to work best on six or seven frames, and a further gain would be derived if the internal space were still further contracted by sliding out every second metal end, thus spacing at  $1\frac{1}{4}$  in.—a plan which generally secures more perfectly built combs of the "flat-as-a-board" style, and with little or no drone cells. This should always be done in the case of swarms hived on starters. Give few frames and compel the bees to build these out before you insert others fitted with full sheets of foundation to complete the full complement.

In early spring, contraction tells in favour of comfort to the bees, and helps to increase early breeding. At the spring cleaning defective or imperfectly-built frames should be withdrawn, and the space contracted by tight-fitting division boards. Later, expand by using full sheet frames. Internal heat should be conserved in every way in spring time, and this lessening of the space requiring to be heated aids the bees in keeping up the temperature with a smaller expenditure of caloric and tissue.

In late autumn, it is generally advised that frames not covered with bees should be withdrawn, as the winter nest thus becomes more manageable by the bees. They can preserve the cluster intact, and generate and maintain the heat necessary to keep them in comfort during the almost zero temperature outside, with a smaller consumption of stores. Small lots should be contracted in proportion to their size, but there is an element of risk in over-contracting. These smaller lots would be more successfully wintered two or three in one hive, contracted, say, to five frames each, with a "Wells" dummy between each.

Driven bees are too frequently run in on all the frames allowed by the capacity of the hive. I think an average lot should be contracted to seven frames. Six should be sufficient for a smaller lot, and a strong one would do best on nine at the most. It is far better to have a small number of frames well and truly built, and all of them well stored, than to have a full set only partially built and imperfectly filled and sealed. We should not "guess" at the state of matters in any of these cases, we ought to know them definitely. Half the failures result from indefinite knowledge.

Contraction of the brood area in order that the bees may be forced into the supers may be an excellent thing, but it works in two ways. It may prejudicially affect the queen and the brood nest, while, if it is overdone, it seems to upset the workers' arrangements, and makes them discontented and unhappy. If insisted on too long, it works adversely as regards the future success of the colony, because too few bees are reared late in the season to ensure that a proper proportion of young bees shall go into winter quarters. Contraction for a set purpose may prove highly successful, but normal conditions should be restored as soon as possible to prevent future contingencies tending to evil and not good. Novices should not be tempted to experiment.

Many practise the system of using a second set of frames, set over or placed under the original brood body, and where there is a really prolific queen the plan secures a splendid army of bees for such

a late crop as the heather. Over-early contraction by the withdrawal of one of the brood-bodies works evil, as it almost inevitably sets up the swarming fever, until the last state of that stock is worse than the first. Successfully done, the work accomplished by the contracted hive is magnificent. It is worth risking much to stand and admire the marvellous industry of the contracted colony on some fine day in early August with a fine reach of heather near at hand—how super after super is taken to, and with what zeal do the heavy battalions of little labourers ply their task. In order that the full force may be concentrated on storing in the supers the body-box is generally contracted to eight or nine frames. In early August racks are given well in advance of real requirements, but later in the month contraction is carefully practised. As soon as a rack is judged to be about complete, it is withdrawn, until, on the advent of September, only one is left, and this is most carefully wrapped up, because then, even after very fine days, the nights begin to chill. All unfinished sections are collected and given to the very strongest colonies. When the full flow ceases the bees are allowed to store the waning supply in their store cupboard, and, if this is sealed, I know of no healthier food on which to winter bees.

---

## Correspondence.

---

*The Editors do not hold themselves responsible for the opinions expressed by correspondents. No notice will be taken of anonymous communications, and correspondents are requested to write on one side of the paper only and give their real names and addresses, not necessarily for publication, but as a guarantee of good faith. Illustrations should be drawn on separate pieces of paper.*

---

### ROSS-SHIRE NOTES.

[8234] Although bees are still working on the heather, the season, as regards surplus honey, is practically at an end, and supers may come off at any time. Heather came into bloom earlier than usual, and is fading rather soon, but results are good on the whole, and the best stocks will likely average a rack of finished sections apiece. In most cases bees occupied two racks, while the strongest stored and sealed honey in three supers during the heather flow. The latter colonies were those experimentally swarmed on stored shallow frames for the moors, and had their removed brood returned as hatched out (see page 305). These extra-strong colonies are still up in the third supers.

*Bee Paralysis.*—Mr. Simmins' article (page 335) reminds us that this nightmare may yet have to be reckoned with. I lost one colony only—a native. An Italian stock showed distinct traces of having acquired the disease—through carelessness in manipulating. The trouble was checked by adopting preventive methods, and the colony, divided into three, has already given me a hundred clover sections, with six racks of heather-blend and pure heather still to be taken off. Honey prices are fairly good, best clover sections bringing 10d. each and heather-blend 1s. As for the pure heather, none has been taken off yet. Last year I sold at 1s. 6d. per pound, but am prepared to accept less on this occasion.—J. M. ELLIS, Ussie Valley.

---

### SWARM CONTROL.

[8235] In reply to Mr. Crawshaw, on page 307, the queen-cell destroyed was a good one, though small. I did not mean that Mr. Stapleton's plan was a failure, but that I had spoiled the experiment by destroying the queen-cell. What the bees would have done had I left the cell is not certain, but what they did do after destroying it was to raise a batch of cells, and swarm. Mr. Macdonald (page 322) claims for Aberdeenshire the honour of being the first B.K.A. to hold expert examinations. That honour belongs to the South of Scotland Bee-keepers' Association. I have held three examinations, one in Midlothian, one in Kirkcudbrightshire, and one in Peebleshire, four candidates passing their third examination. One of these passed the second-class test in the same year. I think I can claim to be the first bee-keeper across the Border to hold the B.B.K.A. certificate: at least, the late Mr. W. B. Carr told me I was the first when I went up to be examined by him at Carlisle seven or eight years ago. I got my second certificate the following year. I hope the associations mentioned in Mr. Macdonald's letter may be induced to affiliate with the B.B.K.A.—HENRY MARRS, Hon. Expert, S.S.B.K.A.

---

### WASP PLAGUE.

[8236] The great plague of wasps seems to be very general and very dangerous for the bees. I have some colonies near Tonbridge which, though strong, have been greatly annoyed by these pests, which have made it impossible for me to ventilate the hives properly as they get in at any little hole, and also keep the bees busy at the entrance repelling their attacks. They have destroyed an observatory hive stock, though the entrance was reduced as much as possible. They cleared honey and brood

out and must have carried away the bees as well, as none could be found when the wasps were seen coming from the hive. The farmers have been destroying nests daily with poison, &c., but it makes very little difference to the number of wasps.—R. E. WRIGHT, Newgate Street, E.C.

#### RAILWAY RATES FOR LIVE BEES.

[8237] I wonder how many bee-keepers are aware that the ordinary rate for conveying live bees by passenger train was increased 50 per cent. on the 1st of September, 1910, this applying to all railways. Formerly bees were charged on the ordinary full parcel scale, but now, unless they are specially consigned at "owners' risk rate," for which the charge is full parcel scale, they are charged that rate plus 50 per cent.

I do not know how such matters are arranged, but bee-keepers being a small body, and the industry in such a flourishing (?) condition, I suppose the railway companies thought they would accept the altered conditions without any unpleasant fuss, and that there would be no one to champion their cause. No doubt they were correct.—R. B. DART, Horsham.

#### DRONE v. WORKER FOUNDATION IN SHALLOW FRAMES.

[8238] For show purposes, whether working for comb or extracted honey, no doubt it is preferable to use drone comb, one advantage being that the bees do not store pollen in drone cells, but for real practical utility worker combs are far and away the best. They may be used to hive swarms on, and later put on top of brood-frames as supers; driven bees may be hived on them; and again, they can be utilised in supers the following season.

Of course, I am referring to frames with the same sized top-bar as brood-frames. Such combs may also be cut out and refixed in full-sized brood frames if desired. There is no need for wiring, as they are as easily fixed as foundation, or rather more easily. The best way to fix them is to bind four or five duck wing feathers together with wire, about 2in. of the tips of the feathers being left. These feathers are very stiff at the tips, and make a first-class "soldering tool" (far better than a spoon), as one can make the molten wax more firmly attach itself to the wood and foundation, and far less wax is needed.

*Judging Sections at Rural Shows.*—I often wonder what rules are followed at these small shows. Some judges award first prize to sections barely half filled, but having white cappings, passing by others quite full and with only one or two of the

angles not fully sealed; when held up to the light apparently the honey is quite as light coloured, but it is close to the capping, which causes the latter to have a sort of soddened appearance. Practically, these sections are worth nearly twice as much as the others, but get no notice from the judges.

*Colour of Honey.*—When uncapping combs, I have noticed honey of various colours in one comb, a few cells decidedly green, others with a pinkish tinge, others again pale yellow, and some almost colourless. I am curious to know what particular bloom causes these various shades of colour; sometimes I notice a kind of peamint flavour in the honey.

Fortunately, we have no honey-dew in this district this season, though I saw some honey at Bletchley Flower Show almost black.—A. HARRIS, Wavendon, Woburn Sands.

## Queries and Replies.

[8192] *Cause of Death of Bees—Brace Combs.*—(1) I am very much obliged to you for the report on a Kashmir queen, which I sent to you. I have to-day sent off two dead bees for report. About a week ago we had a very sharp thunderstorm, and the temperature dropped from over 80deg. to about 70deg., and heavy rain fell in the late afternoon. Next day there were about 300 dead and dying bees outside one hive and thirty or forty outside another. Three other hives in another garden half-a-mile away were unaffected. Since then every morning dead or dying bees are brought out in the morning, thirty or forty in number. They seem unable to use their wings, and there appears to be some paralysis of one or both sides. Some move their legs less freely on one side and constantly roll over on to their backs. The abdomen seems somewhat swollen and elongated, and the colour darker. No evidence of foul brood can be seen and the hive smells quite sweet. Other bees are working well. Yesterday I counted forty-nine going in in half a minute. Is it bee paralysis, or what? (2) I am troubled by my bees making cross braces from comb to comb. What is the cause and remedy? I congratulate you on your most interesting and valuable journal, which I always read with interest.—E. F. N., Kashmir.

REPLY.—(1) The chyle stomach, which was quite decomposed, contained numberless germs, but it is impossible to say with certainty the cause of death. From the description of the symptoms and the fact that a considerable quantity of pollen was found, it is probably a case of malignant

dysentery, or one of the undetermined diseases closely allied to it. (2) Brace combs are frequently built when the bee-space exceeds a quarter-of-an-inch. Some bees build combs much more irregularly than others, especially if the frames are not placed at the right distance from each other. It is quite possible the bees of Kashmir make a narrower comb, as those you send appear to be shorter than our common bees and this might account for the brace combs. We are pleased that you are interested in the journal.

[8193] *Solar Wax Extraction.*—I should be glad if you could give me a few hints as to the management of a solar extractor in next week's journal. I have just bought one and wish to keep it in good order, and to get nice wax from it. The first wax I put in consisted of cappings from which I had washed the remaining honey. As it was not quite dry a good deal of moisture ran off first. What is in the pan has a few dirty bits amongst it, and is in untidy lumps. Should I mould it in neat blocks to be suitable for show, and would it be best to remelt it in a jar placed in a saucepan of water over the fire? Should anything be rubbed on the tray of the solar extractor, such as glycerine, to prevent the wax sticking when cold? How often should the dirt be cleaned off, and must this be done with boiling water? If I am putting an old frame in the extractor containing some honey, will this be mixed in the wax and harm it, or if it sinks to the bottom of the tray will it be fit to eat or to feed bees with?

REPLY.—It will certainly be best to remelt and mould the wax as you suggest, straining through old flannel into the mould to remove small pieces of impurities. The wax will not stick to the tray, but when cold will contract, so that it can easily be removed. There is no need to use any lubricant in the tray. The dirt can easily be removed by means of a spatula, while the extractor is still warm from the sun in the evening. The water or honey will sink to the bottom, and not interfere with the wax at all; the latter can be used as food—human or for bees. Before remelting, it will be well to wash the wax in several changes of warm rain water to remove all signs of honey, then well drain free from water.

[8194] *Late Surplus Storing.* — My observation of bees has led me to the conclusion that they do not always act alike. On August 18th I removed the 5in. frames and sections from five hives, in one case leaving the sections half-full on top of the excluder. The next day I returned all the frames for the bees to clean up, and put the half-full sections on the top. To my surprise I find that in three

cases they have cleaned the combs, and put the honey in the centre of the same combs and have started to cap it over. In one case in which I left the half-full sections they have put the honey in the sections; in the other case they have removed it to the brood-chamber. Please note that they had plenty of room in the brood-chamber in each instance. I can only suggest that the rain last week must have produced some honey, and they are trying to again store surplus in the 5in. frames. Have you any other reason to suggest?—J. H. MEYER, Fulham.

REPLY.—It is a true saying that bees do nothing invariably. The explanation is, no doubt, that a little nectar is coming in, so the queen has commenced to lay again. In some cases, although the cells are apparently empty, if you look carefully you will doubtless find eggs in them.

[8195] *Risk to Horses.*—(1) I am very much obliged for your kind reply to my query in the BEE JOURNAL (page 315) with reference to the risk to horses and also wish to thank Mr. Woodley for his remarks in the issue of August 24th, but I am rather afraid of barbed wire. I have seen horses injured by this kind of fencing, and should not like to think that I was responsible for it. Besides, if a horse were put out of action for a day or two by bee-stings, the injury might not be absolutely ruinous, but if a valuable horse got strung up in my barbed-wire fence and had to be slaughtered, and the owner made me pay up, I should find my bees rather an expensive hobby.

(2) The brick wall would certainly protect the bees from the east wind, but the ground is right open to the west, and in the "Guide Book" we are told to protect the hives from the west wind. Why is this? Mr. Crawshaw's thrilling adventure with the bees (page 337) was similar to one I had some years ago. I did not, however, have the stings sand-papered down level as he did. The wind blew my veil against the lower part of my face just as the bees got to work through it. All my chin and the sides of my face were full of stings, so I went to a barber's shop and had a shave.—T. T. M., Manchester.

REPLY.—(1) You will find that horses know the danger of barbed wire as well as human beings do, and when it is put up keep away from it. (2) From the west we generally get driving rain, and as damp is very injurious to bees it is well to avoid exposure to this as much as possible.

[8196] *Dealing with Diseased Combs.*—(1) I enclose a piece of brood-comb, and should like to know if it contains sour brood? The contents of the diseased cells are not rosy as in foul brood. (2) What is the

procedure for cure? (3) Will it matter if I extract combs containing honey and diseased cells, and then use the extractor for healthy combs? (4) A quantity of syrup made in spring from cane sugar appears and smells all right. There is no scum on top. Will it be safe to feed the bees with this for winter stores?—NEMO, Hants.

REPLY.—(1) It is a case of sour brood. (2) The treatment is as for foul brood and re-queening is also advisable. (3) It would be necessary to thoroughly disinfect the extractor before using again for healthy combs. (4) The syrup may be safely used, but you will have to increase its density, or it will cause dysentery.

[1917] *Various Queries*.—Your advice on the following questions would be appreciated:—(1) Is the enclosed sample of sugar pure cane, and is sugar of that grain and texture likely to be cane, even if not guaranteed as such? (2) Would honey which has been boiled with water, such as cappings melted down, be as suitable as honey left stored in the combs for wintering bees on, or would such diluted honey be only equal to cane-sugar syrup? (3) For what reason is the air-space in hive-walls considered better than packing the space with non-conductive material? (4) I use a hive, single-walled, of lin. stuff, 16½ in. square outside, containing ten standard frames with 15½ in. top bar, and no metal ends, and yet my stocks come out in spring fairly well. Do you think it would pay me to use more protection than this? I pack them well overhead. (5) I have tried direct queen introduction three times with success. Do you think caging the safest plan? Thanking you for past valuable help.—C. C., Alveston.

REPLY.—(1) The sample is cane sugar. The grain has nothing to do with deciding as to whether it is cane or beet. (2) The diluted honey would be a good food so long as it boiled just long enough to bring it to the right consistency for winter food. It is safer to use sugar syrup and utilize the liquid honey for making vinegar or mead. (3) A dead air-space is a bad conductor of heat, therefore there is not much to be gained by packing. To use no packing also saves trouble; if loose material, such as cork-dust, is used, it makes an untidy mess when taken out. It also harbours ants, earwigs, spiders, &c. (4) If you bring your bees through the winter in good condition in the kind of hive you use, there is no need to change. (5) We prefer to cage queens when introducing. It is much safer and very little more trouble. It would take a lot of the "saved" time to recompense you for the loss of a valuable queen through direct introduction.

## Bee Shows to Come.

*A nominal charge of 2s. 6d. is made for notices (not exceeding 7 lines) in this column, 10 lines charged 3s. 6d., up to 15 lines 5s., which covers cost of insertion from order till date of show. Cash should accompany orders for insertion.*

**August 30 and 31, at Carlisle.**—Annual Honey Show of the Cumberland and Westmorland B.K.A. in connection with the Carlisle Horticultural Society's Exhibition to be held in the Covered Market, Carlisle.

**August 30 and 31, at Coventry.**—Annual Show of the Warwickshire B.K.A., in connection with the Warwickshire Agricultural Society. Separate tent for Honey, Wax, and Appliances.

**September 6, at Deddington, Oxon.**—Show of the Deddington Horticultural Society. Open Class for Honey. Prizes, 10s., 5s., 3s., 2s. No entry fee. Schedules from Messrs. H. J. Harmsworth or A. A. Busby, Deddington. **Entries close September 1.**

**September 7, at Peterborough.**—In connection with Horticultural Society. County Association Class and four Open Classes. Schedules from G. T. Dunham, Albion Terrace, 32 Oundle Road, Peterborough. **Entries close September 1.**

**September 12, at Woodstock.** Oxfordshire Bee-keepers' Association Annual Show. Open Classes. No entry fee for the best Section, for the best jar of Run Honey. Prizes 7/6, 5/-, 2/6. Entries to H. M. Turner, 4, Turl Street, Oxford. **Entries close September 9.**

**September 13, at Conway, N. Wales.**—Great Annual Honey Show in connection with the Conway Honey Fair. Open and local Classes. Schedules from J. Hughes, Town Hall, Conway. **Entries close September 6.**

**September 13 and 14, at Cambridge.**—Honey Show in connection with the Cambridge and District Red Cross Horticultural Society. Four Classes, open to all. To be held in the Corn Exchange, Cambridge. Schedules and particulars of Hon. Sec., E. F. Dant, Member of B.B.K.A., 52, Bridge Street, Cambridge. **Entries close Saturday, September 9.**

**September 14, at Castle-Douglas.**—Annual Show of South of Scotland Bee-keepers Association. Five open classes: Three 1-lb. jars extracted, 20s., 10s., and 5s.; three sections, ditto (Entry 2s.). 1lb. jar, also one section, 5s., 3s., and 2s. (Entry free, and exhibits retained unless otherwise agreed upon). Beeswax, 5s., 3s., and 2s. (Entry 6d.). Fourteen classes for members. Schedules from Q. Aird, Schoolhouse, Howwood, Renfrews. **Entries close September 2.**

**September 16 to 23, at the Agricultural Hall, London.**—Honey Show in connection with the 19th Annual Exhibition and Market of the Grocery and Kindred Trades. Liberal prizes. Open to all British Bee-keepers. Schedules from H. S. Rogers, Secretary, Exhibition Offices, Palmerston House, Old Broad Street, London, E.C.

**September 26, at Horniman Hall, North End, Croydon.**—Exclusive Show of Honey, Wax, Hives, Bees, &c. Increased prizes. Six Open Classes. Judge, Mr. W. Herrod, F.E.S. Schedules from A. Wakerell, 21, Mansfield Road, Croydon. **Entries close September 16.**

**September 27, at Altrincham.**—Honey Show, in connection with the Altrincham Agricultural Show, the largest one-day show in the Kingdom. Classes open to United Kingdom. Classes for Trophy of Honey, for Best Hive, Observatory Hive with Bees and Queen, twelve Jars of Extracted Honey. Classes open to County of Chester, for Run and Section Honey, Wax, &c. Special Classes for Cottagers, and Special Classes for Society's District. Several Special Jubilee prizes. Schedules from Mr. J. Herbert Hall, 2, Dunham Road, Altrincham. **Entries close September 9, and at extra fees September 13.**

## NEW HONEY.

SEASON, 1911.

A great deal has been said about the prices of honey. Below we give quotations which are sent out by one of the foremost houses in the drug trade. They will, no doubt, be of interest to bee-keepers:

**CHILIAN (New Set).**—Pile X, White, 7lb., 14lb. tins, 7d.; 28lb., 6½d.; kegs, 1¼cwt., 50s. Pile 1, Pale Yellow, 7lb., 14lb. tins, 6d.; 28lb. 5½d.; kegs, 1¼cwt., 40s. Pile 2, Pale Yellow, 7lb., 14lb. tins, 5d.; 28lb., 4½d.; kegs, 1¼cwt., 36s.

**CALIFORNIAN.**—Pale Liquid, 7lb., 14lb. tins, 8d.; 56lb. tins, 68s.; 2 tins, 66s. White and Set, 7lb., 14lb. tins, 7½d.; 56lb. tins, 58s.; 2 tins, 56s.; or 2s. cwt. less from our stock in Liverpool.

**ENGLISH.**—New, in good condition for potting. Jars, 11d. lb.; 14lb., 10d.; 56lb., 9d. lb.

ventor. Mr. Marshall, of Chelmsford Street, Lincoln. The block explains the appliance very clearly, and it is claimed that it will securely grip the frame, thus enabling the bee-keeper to manipulate the frames with one hand. It is sold by Messrs. Jas. Lee and Son at the small cost of 1s. 1½d. post free.

---



---

**Notices to Correspondents.**

---



---

**E. A. G. M. (Braintree).**—*Wax Moth in Store Combs.*—The combs should be stored in the supers in such a manner that they do not touch each other. If you have not many, each one should be wrapped up securely with brown paper, and a supply of naphthaline, or, better still, "Apicure," inside. If you have a large number, then stack them one on

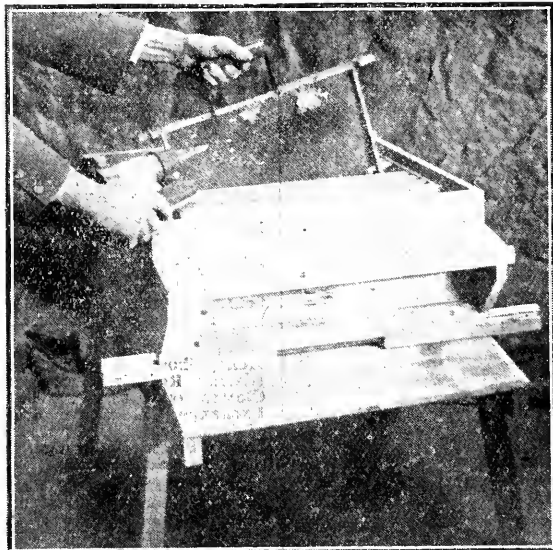

NEW FRAME LIFTER.

**FRENCH.**—New, Best Yellow (English character), recommended for potting. 7lb., 14lb. tins, 8d.; 28lb., 7d.; 90lb. (about) kegs, 64s. (on arrival).

**JAMAICA.**—White Set, 7lb., 14lb. tins, 8d.; 28lb. tins, 7d.; 56lb. tins, 6½d.; 3cwt. casks, 50s. cwt. Pale Amber, 7lb., 14lb. tins, 6½d.; 28lb. tins, 6d.; 56lb. tins, 5½d.; 3cwt. casks, 44s. Yellow, 7lb., 14lb. tins, 6d.; 28lb. tins, 5½d.; 56lb. tins, 5d.; 3cwt. casks, 40s. Flav.

**WAXES.**—The usual lowering of prices of bees-wax, which takes place at this time of year has not occurred. English Yellow Bees-wax 2s. 2d. lb.; French 2s. lb.

## NOVELTIES FOR 1911.

## FRAME LIFTER.

A very useful novelty was shown at the "Royal" Show, Norwich, by the in-

the top of the other, and on the top of the frames of each third super put a piece of brown paper about 8in. square, and upon this place naphthaline or "Apicure." The top should be covered with some thick but porous material. To make quite safe, you could paste brown paper over the joints between each super.

**HEATHER.**—*Clipping Queen's Wing.*—It is not advisable to do this: if done once it lasts for life, as the queen cannot grow another wing. Remove about half the wings on one side by means of a sharp pair of scissors.

**G. E. GALLETLEY.**—*Re-queening Driven Bees.*—We cannot quite understand your question, but presume you mean, "Is the best time to re-queen in the autumn?" Is so, the answer is yes.

- E. J. GARRETT (Belfast).—*Varieties of Heather*.—(a) is bell heather, and (b) is the common ling. Both are useful for honey, but the latter is the one from which the harvest is usually obtained.
- J. FLECK (Scarva).—*Disinfecting Combs*.—(1) You can buy a sprayer from any appliance manufacturer, or if you have only a few hives, purchase a small scent-spray from the chemist. (2) It is not necessary to use a sprayer at all. Follow closely the directions given on the bottle.
- E. J. D. (Blackheath).—*Dead Bee*.—The bee has died from the effect of losing its sting.
- W. I. (Drogheda).—*Bees Fighting*.—The bees should have been packed in a tin box; they were crushed beyond recognition in the post, so we cannot give you an opinion.
- R. B. M. (Towcester).—*Books on Fruit-Growing*.—Wright's "Practical Fruit-Grower" or "Pictorial Fruit Culture," published by Cassell's, will no doubt serve your purpose.
- G. C. (Oughtybridge).—*Queen Introduction*.—Like so many theories, it sounds very nice on paper, but in actual practice we have grave doubts as to its success. One drawback is that very young virgins must be used, so it would be no use purchasing queens for the purpose, but they would have to be reared by the bee-keeper. Like the "Wells" system, which could only be worked successfully by its originator, this method is successful in the hands of the one person; with others it would be a failure.
- E. E. BIRCH (Southport).—*County for Bee-keeping*.—We should choose Cumberland as there you will have the advantage of the heather of which there is none in Bedfordshire.
- R. R. (Glorat).—*Bees Flying Abnormally*.—The very fact of your making an artificial swarm and feeding the bees will account for their activity. Have no fear, they are doing all right, and no doubt with the attention you are giving them will come out strong in the spring.

#### Honey Samples.

- NOVICE.—Yes, it is certainly good enough to show in the light class at the exhibition you mention.
- L. M. D. (Yorks).—The honey is mainly from clover; there is very little lime in it. It is good in every respect, except density, which is only fair. Yes, the price you name would be a fair one.
- ELMSALL (Wakefield).—Both are excellent samples of clover honey; either will do for show, but our choice would be B; it is a little the thickest and slightly better in flavour. We shall be delighted to have the notes you suggest.
- W. J. H. (Luton).—The samples are both very good ones from sainfoin. Our choice would fall upon No. 2, which is
- thicker than No. 1, and equal to it in every other respect. It should be shown in the light class. We congratulate you upon your success the first time of showing. It proves what we have stated in these columns, that the novice stands an equal chance with the experienced bee-keeper on the show bench.
- ALPHA.—From clover; density fair; can be improved by warming; about 10d. It is worth a trial on the show bench at a local show. Yes, return the combs and no doubt you will obtain surplus from the heather. We are grateful for your kind remarks.
- Z. X. (Gloucestershire).—The honey is spoilt by honey-dew.
- KENTISH NOVICE.—It is a good medium honey from fruit and clover; it is very dense, and is worth showing in medium class.
- B. B. (Lewes).—Both samples are very good in every respect. No. 1 is of slightly better flavour than the other.
- ELAS (Sale).—No 1 is from sycamore, and as such is a good sample. No. 2 is from clover and lime. The latter would be the best honey to show in a light class.
- F. BIRD (Mitcham).—Sample No. 1 is a nice-flavoured light honey of good colour, but is a little lacking in density. It is from clover principally. No. 2 is also good in all respects except density, and has been gathered from clover and lime. No. 3 is the best sample and is mainly from clover. It is the one we should choose to exhibit.
- G. H. (Normanton).—A honey good in colour, but poor in flavour and density. It is worth about 50s. per cwt.
- G. M. D. (Wenden).—The sample is exceedingly light in colour and rather thin. We cannot give its source on account of it being tainted by the previous contents of the bottle in which it was sent.
- E. J. S. (Ilford).—The appearance of the honey is all that can be desired. There is, however, a slight bitterness in the flavour which we do not like, though it might not be objectionable to the majority of people.
- R. D. (Terling).—A fairly good honey; the peculiar flavour is from ragwort.
- A. B. SILEX.—Sample has been gathered from limes, and would be a very nice table honey but for the fact that it is very thin.
- WELSHMAN (Llanelly).—Yours is a beautiful sample, and is worth exhibiting at one of the big shows. You must remember, however, that competition at these shows is very keen. We are delighted to hear of your success with knowledge obtained exclusively from the "British Bee-Keeper's Guide" and our journal. May you prosper still more.

#### Suspected Disease.

- E. H. (Horsham).—You do not say anything about symptoms, or if the bees are

acting in a peculiar manner, and without some such data, it is difficult to diagnose the trouble. The bees arrived dead, and they appear to be suffering from constipation. If there is anything to cause you to suspect "Isle of Wight" disease you should send some live bees with food to Dr. Malden, Pathological Laboratories, Medical Schools, Cambridge.

### Special Prepaid Advertisements.

**Two Words One Penny, minimum. Sixpence.**  
Orders for three or more consecutive insertions entitle advertisers to one insertion in "The Beekeepers' Record" free of charge.

Trade advertisements of Bees, Honey, Queens, and Bee goods are not admissible at above rate, but will be inserted at 1d. per word as "Business" Announcements, immediately under the Private Advertisements. Advertisements of Hive-manufacturers can only be inserted at a minimum charge of 3s. per  $\frac{1}{2}$  in., or 5s. per inch.

### PRIVATE ADVERTISEMENTS.

**EXTRACTED ENGLISH HONEY**, 12s. 6d. per 28lb. tin, sample 2d.—DUTTON, Kettering, Essex. m 79

**WANTED, LIGHT ENGLISH HONEY**, any quantity; state lowest cash price.—Address, SCARBORO, c/o "B.B.J." Office, 23, Bedford-street, Strand, W.C. m 79

**CLOVER SECTIONS**, splendid quality, full weight, 8s. 6d. doz.—NORTH, Cressing, Braintree, Essex. m 18

**FOR SALE, 10 $\frac{1}{2}$  ACRES OF LAND**, well built bungalow, good outbuildings, fruit trees, &c.—JOHNSON, Sheepdrove, Lambourne, Berks. m 11

**LARGE CLOVER SECTIONS FOR SALE**, 7s. doz, packed free.—FARMER, The Nook, Fairfield. m 16

**WANTED, SMALL HOUSE** with land and buildings for Bee and Poultry Farm, near main line Selby to London.—H. D., "B.B.J." Office, 23, Bedford-street, Strand, W.C. m 15

**4 CWT. OF HONEY** in 28lb. tins, 7d. lb., tins free, cash with order.—A. COLEMAN, Gretton, Kettering, Northants. m 13

**EXTRACTED HONEY WANTED** (10cwt.)—State quantity and price, and send sample to THE FRANCIS WILLIAMS OIL Co., 551, Broad-street, Birmingham. m 12

**PURE EXTRACTED CLOVER HONEY**, season 1911, in 28lb. cans, 6d. per lb., carefully packed, free on rail, Northants County guarantee label; all enquiries answered.—MORRIS, Welland Valley Apiary, Barrowden, Stamford, m 19

**ORIGINAL pattern Yorkshire Heather Honey Press**, new, fully finned; price and particulars.—HOOD, Whitby. m 11

**ADVERTISER** starting bee-keeping desires to A hear from bee-keepers and firms selling appliances.—ROSS, Savanetta, Purley. m 10

**HONEY**, finest Hampshire, 58s. per cwt., 28lb. tin, 15s., tins returnable or charged; sample 5d.—OWEN BROWN, Ashley, Kingsomborne, Hants. m 36

**FINEST CLOVER SECTIONS**, 8s. 6d. doz.; ditto, extracted, 39s per  $\frac{1}{2}$ cwt.—STEED, Fenner, Braintree. m 36

**FOR SALE** (wing to removal, 5 Stocks of Bees in Lees Holborn Hives in good condition, all 1911 Queens, price 15s. each, or £3 the lot.—J. CRAWTER, Cheshant, Herts. m 38

**WHAT OFFERS** for 2cwt. fine Clover Honey: sample 2d. MASON, expert, Orielton School, Pembroke. m 35

**HONEY**, first quality sections, 8s. 6d. doz.; 3 doz., 25s. cash with order. R. COUSINS, The Rosary, Misterton, Gainborough. m 35

**WELLS' HIVE** with 20 Standard frames, bees in one side only; three other Hives, with 10 Standard frames, all strong, healthy, and plenty stores, highest offer gets them put on rail.—ALEX. MURRAY, Binlay Cottages, Willenhall, Coventry. m 34

**BEE JOURNALS**, bound, 1890 to 1903; unbound and clean, 1904 to 1909; Records, bound, 1890 to 1901; unbound, 1902 to 1908; what offers? Also Bee books, list sent; model of an apiary, quantity of exhibition beeswax, stocks of bees in frame hives, 25s. each.—SEYMOUR, bee farmer, Henley-on-Thames. m 30

**WANTED**, six 3lb. lots of Driven Bees, Natives, with Queens in each lot.—H. CLEAVER, 8, Northcote-street, Leamington. m 31

**TWO LARGE BUYERS**—9cwt. good light-coloured Honey, and 16 doz. Sections from own Bees, for sale.—DAVID HANCOX, Deddington, Oxon. m 28

**SECTIONS**, 1st grade, clean, white clover, 9s. per doz., packed on rail, cash with order.—BARNES, Clogger, Wigton, Cumberland. m 27

**BEE AND POULTRY FARM**, including day old chick business and appliance agency, 6-roomed house, coach-house, stable, incubator house, workshop, &c., 2 acres wired pens, low rent, ideal healthy locality, miles of heather, bees, incubators, poultry, appliances, pony, trap, &c., to be taken over; stamp for particulars.—DICKINSON, St. Ives, Ringwood. m 26

**ORIGINAL AND BEST RYMER HEATHER HONEY PRESS** for sale.—THOS. HOOD, Whitby. m 25

**WANTED**, 5cwt. light Honey; sample; also Sections.—R. CARTER, Chartridge, Chessham, Bucks. m 24

**PAIR BUFF PEKIN**, also pair black red modern game Bantams (winners), exchange for Driven Bees; extra fine quality Scotch clover Honey, 60s. cwt; sample, 3d.—IRVING, Galabank Apiary, Annan. m 21

**HONEY**, good colour, flavour and well ripened, 58s. per cwt. on rail; tins free;  $\frac{1}{2}$ lb. sample six stamps.—J. IRELAND, Vernham, Hungerford, Berks. m 19

**OBSERVATORY HIVE**, mahogany, ornamental, complete with turntable, tunnel feeder, section frames.—Particulars, offers, ROBERTSON, St. Mary's Crescent, Portsmouth. m 10

**25 STOCKS FOR SALE**, in good W.B.C. Hives, headed young Queens, guaranteed healthy; overstocked only reason for sale; exceptional opportunity to acquire reliable stock; also various appliances, and shed lift. by 7ft.—W. H. SIMS, Hall Green, Birmingham. m 18

**FOR SALE**, 11 acres FREEHOLD LAND, situate at Lambourn, Berks. £240; two-thirds can remain; good site for bee farm.—WADHAM, 5, Gold-street, Routh, Cardiff. m 19

**FINEST FLOWER HONEY**, in sections, 10/6 per doz.; extracted Honey, in tins, £3 per cwt., sample 2d.—WILLIAM WILSON, 25, Forfar-road, Kirriemuir. m 16

**SECTIONS WANTED**, for cash; send lowest price, any quantity, and extracted.—F. W. WEITZEL, 45, Kempe-road, Kensal Rise, N.W. m 14

### BUSINESS ADVERTISEMENTS.

**DRIVEN BEES**, guaranteed healthy, with queen, 4s.; do., with 1911 queen, 5s.; spare young queen in self-introducing cage, 2s. 6d.—W. PATENALL SOLE, 56, Warren-road, Collier's Wood, Merton, S.W. m 37

**200 LOTS DRIVEN BEES**, 5s. per lot.—DENNETT, Whitechurch, Hants. m 32

**HEALTHY DRIVEN BEES**, with 1911 Queens, 5s. 6d.; old Queen, 5s.—WELBOURN, Hutton-Cranswick, Beverley. m 29

**HEALTHY DRIVEN BEES**, a few lots at 5s. per lot; spare Queens, 2s. 6d. each; boxes returnable.—MORETON, Hallow, Worcester. m 23

**GUARANTEED HEALTHY DRIVEN BEES**, 1s. 3d. per lb. cash.—WATSON, Pine View, Mildenhall. m 14



## Editorial, Notices, &c.

### DISEASES OF BEES LEGISLATION COMMITTEE.

The next meeting of the above committee will be held at 2 p.m. on Sept. 21st, 1911, at 23, Bedford Street, Strand, W.C. Members of the committee who are unable to attend, and who desire to submit any amendments to the draft Bill, should forward them by post to the Hon. Sec.—L. S. CRAWSHAW, Hon. Sec. Norton, Malton, Yorks.

### COMING HONEY SHOWS.

The special attention of exhibitors is called to the Honey Exhibition at Altrincham, Cheshire, entries for which close on September 9th. It is a "Jubilee" show, and the committee are making special efforts to create a record. The honey department is well represented, and liberal prizes are offered in special classes. The time for closing entries at the most important honey show of the year is also drawing near. We refer to the Grocers' and Allied Trades Exhibition, to be held at the Agricultural Hall, London, from the 16th to the 23rd inst. All who have taken off good honey should make an entry. The value to the bee-keeping industry of this extensive exhibition of bee-produce cannot be over-estimated; it is an object lesson to the public on the attractive qualities of British honey. The "selling" classes especially ought to be well supported, as the honey-crop this season has generally been so abundant, and we hope that the fine display of last year will be eclipsed. In order to encourage bee-keepers of all classes to compete, the entry fees are only 1s. in each class, and the prizes remain on the usual liberal scale. Every care is taken to stage the exhibits in the most attractive manner, and to return those unsold safely to their respective owners.

### NORTHANTS B.K.A. ANNUAL SHOW.

The annual show of the above association was held on August 17th in Abington Park, Northampton, by kind permission of the Municipal Council, who erected a tent for the reception of the exhibits. The entries numbered 233, which constituted a record, quite half-a-ton of honey being staged, the quality of which was excellent throughout. Thanks are due to all who contributed in any way to the success of the show, special mention being accorded the President, Mrs. Irene Osgood, who gave special prizes to lady exhibitors; the Hon. Sec., Mr. R. Hefford, and the

Stewards, Mr. W. T. Munn and Mr. R. Brawn. Mr. Thos. Norman also gave valuable assistance.

Mr. W. Herrod, F.E.S., again judged the honey, and gave a demonstration and lecture in the bee tent during the afternoon. Mrs. Foot adjudicated upon the honey cakes. At 5 p.m. members sat down to tea, after which Mr. Herrod gave an address on "Preparing Honey and Wax for the Show Bench." The awards were as follows:—

*Twelve 1-lb Sections.*—1st, A. Hiscock, Loddington; 2nd, C. J. Burnett, Northampton; 3rd, E. Palmer, Kettering; 4th, R. Allen, Tusmore; h.c., G. Mason, Yardley Gobion, and H. England, Moulton.

*Twelve 1-lb. Jars Light Honey.*—1st, A. Hiscock; 2nd, C. Wells, Oxendon; 3rd, J. Adams, West Haddon; 4th, E. Thompson, Moulton; 5th, Mrs. Roberts, West Haddon.

*Twelve 1-lb. Jars Dark Honey.*—1st, E. Thompson; 2nd, W. Snow, Yardley Hastings; 3rd, C. J. Burnett.

*Twelve 1-lb. Jars Granulated Honey.*—1st, A. Hiscock; 2nd, W. Snow; 3rd, Goodburn Bros., Peterborough; 4th, J. Adams; c., R. Allen.

*Shallow Frames of Honey.*—1st, A. Hiscock; 2nd, J. Adams; 3rd, W. Snow; 4th, A. Bailey, Northampton.

*Super of Honey.*—1st, R. B. Manley, Potcote House; 2nd, H. England; 3rd, H. Williams, Overstone; h.c., G. Page, Holcot.

*Bee-swar.*—1st, A. Hiscock; 2nd, C. Wells; 3rd, B. Manley; 4th, J. Adams; h.c., W. Reynolds and J. S. Partridge, Wollaston; c., H. Williams.

*Six 1-lb. Sections.*—1st, F. Holley, Wellingborough; 2nd, — Jones, Loddington; 3rd, E. Marshman, Little Linford, h.c., Miss L. Roberts, Weedon, and W. Smart, Tower Water Works; c., — Burnett, Langham Place, Northampton.

*Six 1-lb. Jars Light Honey.*—1st, F. Holley; 2nd, W. Smart; 3rd, — Keightley, Moulton; h.c., R. Brawn, Northampton, and H. Bailey; c., H. Burditt.

*Six 1-lb. Jars Dark Honey.*—1st, R. Brawn; 2nd, A. Talbutt; 3rd, E. Marshman.

*Super of Honey.*—1st, H. England; 2nd, W. Snow; 3rd, R. Brawn.

#### SPECIAL PRIZES.

*Single Jar of Honey (open).*—1st, A. Hiscock; 2nd, J. W. Boscock, Stony Stratford; 3rd, A. C. Jackson, Elvedon; 4th, H. Saunders, Thetford; 5th, G. Page, Holcot; v.h.c., W. Canham, Soham; h.c., C. W. James, Hardwick, and R. H. Baines, Cambridge; c., E. Marshman.

*Single Jar of Honey.*—1st, H. W. Saunders; 2nd, E. Palmer; 3rd, A. Hiscock; 4th, W. Canham; v.h.c., G. Page; h.c., E. Marshman and R.

Barnes; c., H. Williams and T. G. Hillier, Andover.

*Honey Cake*.—1st, Mrs. Hefford, Kings-thorpe; 2nd and 3rd, Miss Burnett, Northampton; 4th, Miss M. Bailey, Northampton; h.c., Mrs. Mason, Yardley Gobion.—R. HEFFORD, Hon. Sec.

#### GLOUCESTERSHIRE B.K.A.

The first annual show of this revived association was held at Gloucester on the 25th, 26th, and 27th of July, in connection with the County Agricultural Show. The display of honey products, &c., were excellent both as regards the quality and quantity of the exhibits. Mr. James Brown, of Bristol, acted as judge, and Mr. E. J. Burt, the County Council Lecturer, gave demonstrations in the bee tent each day to highly interested audiences. Mr. H. E. Bailey secured the President's prize, and Mr. W. J. Goodrich the "Small-Holders'" clock for the greatest number of points. The awards were as follows:—

*Twelve 1-lb. Sections*.—1st, W. J. Goodrich, Gloucester; 2nd, H. C. Smith, Woodmancote; h.c., Miss E. M. Empson, Painswick; c., W. A. Workman, Hucclecote.

*Twelve 1-lb. Jars of Extracted Honey*.—1st, H. C. Smith; 2nd, C. Mason, North Cerney; h.c., W. J. Goodrich; c., A. H. Bowen, Cheltenham.

*Two Shallow Frames of Comb Honey*.—1st, W. J. Goodrich; 2nd, W. A. Workman; h.c., Rev. E. Roberts, Barnwood; c., P. J. Wherrett, Cambridge, Gloucestershire.

*Six 1-lb. Sections*.—1st, A. H. Bowen; 2nd, Miss F. M. Priday, Brockworth; h.c., W. J. Goodrich; c., H. Gill, Bourton-on-the-Hill.

*Six 1-lb. Jars of Extracted Honey*.—1st, C. Mason; 2nd, A. H. Bowen; h.c., W. J. Goodrich; c., H. Gill.

*Display of Honey (open)*.—1st, H. E. Bailey, Norton; 2nd, W. J. Goodrich; 3rd, J. Toombs, Leddington.

*Twelve 1-lb. Sections (open)*.—1st, C. W. Dyer, Compton; 2nd, J. Toombs; h.c., W. J. Goodrich; c., Royal Agricultural College, Cirencester.

*Twelve 1-lb. Jars of Extracted Honey (open)*.—1st, H. W. Saunders, Thetford; 2nd, H. C. Smith; h.c., R.A.C., Cirencester; c., C. W. Dyer.

*Single 1-lb. Jar of Extracted Honey*.—1st, A. H. Bowen; 2nd, H. C. Smith; h.c., H. W. Saunders; c., H. E. Bailey.

*Beehive*.—1st, J. Toombs; 2nd, H. W. Saunders; h.c., L. W. Matthews, Chipping Norton; c., A. H. Bowen.—REV. F. H. FOWLER, Hon. Sec.

#### WARWICKSHIRE B.K.A.

The Warwickshire B.K.A. held their annual "honey fair" on August 30th and 31st, in connection with the Warwickshire Agricultural Society's Show at Coventry. A good display of honey was staged, but the whole effect of the late strike had not yet passed away, and, owing to the quantity of goods at the station, the Railway Company were unable to get many of the exhibits to the show in time, beekeepers having to suffer with the rest. A number of the entries for honey were also cancelled owing to the difficulty of getting the exhibits through to the show ground. The stewards, however, had as much honey as they could comfortably deal with, resulting in a very creditable show. The trophy class was well represented, the premier honour being secured by Mr. W. Dixon, of Leeds, who is an adept at staging this class of exhibit. The competition in the open classes for light honey and for beeswax was very keen, giving the judge some trouble to decide on the winners. Mr. Franklin, the county expert, gave lectures and demonstrations at intervals to interested audiences. Two candidates presented themselves for examination for third-class certificates. Mr. J. Herrod, of Sutton-on-Trent, acted as judge, and made the following awards:

*Bees in Observatory Hive*.—1st, Geo. Franklin, Kenilworth.

*Three Shallow Frames for Extracting*.—1st, Alfred Hiscock, Kettering; 2nd, John Loydall; 3rd, J. A. Jefferson; 4th, William Duffin; h.c., John Arthars.

*Twenty-four 1-lb. Sections*.—1st, Alfred Hiscock; 2nd, John Arthars; 3rd, Henry Cleaver; 4th, J. A. Jefferson.

*Twelve 1-lb. Sections*.—1st, Henry Cleaver; 2nd, Alfred Hiscock; 3rd, J. Fairall, junr., Hellingly, Sussex; 4th, Wm Dixon, Leeds; h.c., C. G. C. Mallam and John Arthars.

*Twelve 1-lb. Jars of Light Honey*.—1st, H. W. Saunders, Thetford, Norfolk; 2nd, H. E. Seency, Chipping Norton; 3rd, Alfred Hiscock; 4th, Wm. Dixon; h.c., J. H. Dew; c., Henry Cleaver.

*Twelve 1-lb. Jars of Medium-coloured Honey*.—1st, Miss R. Haine; 2nd, J. H. Dew; 3rd, Wm. Dixon; 4th, Alfred Hiscock; h.c., Wm. Duffin; c., Mrs. Oliver-Bellasis.

#### COTTAGERS' CLASSES.

*Twelve 1-lb. Sections*.—1st, Thos. A. Denison; 2nd, W. H. Allard; 3rd, Wm. Ayres.

*Twelve 1-lb. Jars of Light Honey*.—1st, Harry Ward; 2nd, Wm. Lee; 3rd, F. Steele; 4th, Mrs. M. Ireland; h.c., E. Ilib.

*Twelve 1-lb. Jars of Medium-coloured Honey*.—1st, F. Steele; 2nd, E. Ilib;

3rd, Thos. A. Denison; 4th, Mrs. M. Ireland.

*Six 1-lb. Sections and Six 1-lb. Jars of Extracted Honey.*—1st and silver medal, Thos. A. Denison; 2nd, F. Steele; 3rd, E. Hiff; 4th, Mrs. M. Ireland; h.c., W. H. Allard.

#### MISCELLANEOUS.

*Display of Honey.*—1st, Wm. Dixon; 2nd, A. Hiscock; 3rd, Geo. Rose, Liverpool; 4th, Miss R. Haine.

*Collection of Hives and Bee Appliances.*—1st, Geo. Rose; 2nd, Geo. Franklin.

*Bee-swar.*—1st, H. W. Saunders; 2nd, A. Hiscock; 3rd, John Arthars; 4th, Wm. Duffin; h.c., Mrs. W. Craven Jones; e., Miss R. Haine, John Arthars, and Geo. Franklin.—J. INGERTHORPE, Hon. Sec.

### HELPFUL HINTS FOR NOVICES.

*By W. Herrod.*

#### DRIVING BEES.

*(Continued from page 335.)*

The method of driving is so clearly and simply explained in "The British Bee-Keepers' Guide Book," that it is unnecessary for me to go into details of the procedure, but one or two hints may be of service. Do not make the joint of the two skeps by pushing the skewer through from the outside of the empty skep; being unable to see properly, it is difficult to make a good joint. The skewer should always be pushed through from the inside of the empty skep. It is better to use a 3in. round wire nail than the ordinary skewer supplied with sets of driving irons, especially if it is necessary to catch the queen; the nail driven well home leaves an uninterrupted passage for the bees, whereas the eye of the skewer stands up and forms a block. The bees also have a great tendency to climb up this and congregate in a mass at the top. The junction of the two skeps should be made at right angles to the combs, to allow a clear run for the bees. If the combs are irregular, then fix at the point where the greater portion of the passages converge. Tie a cloth round the back of the skeps; this will compel all the bees to run into the empty one, instead of clustering at the back, and so wasting valuable time in getting them in with the smoker afterwards. Don't use a carbolie cloth over the edge of the combs nearest to the operator, as is frequently done; this prevents the bees from running freely, and for the same reason the back-cloth should be quite clean and free from smell. Strike the full skep back and front, *i.e.*, at the end of the combs, using the front hand with more force than the other. Sharp irregular taps are the best—it relieves the monotony to drum a tune. If

it is necessary to catch the queen keep a clear space for the bees to run over by wiping them away from time to time with the finger. The movement should be from each outside to the middle. This also prevents the bees clustering at the outside edge of the bridge, and keeps the bees on the combs instead of knocking them on to the ground. Care should be taken to see that the edge of the empty skep does not overlap the full one, or the bees will cluster below amongst the combs.

When all the bees are out, remove the side irons, and instead of trying to pull out the nail with the fingers, get it out by lifting the skep bodily, when it will come out quite easily.

To prevent live bees being taken indoors it is advisable to carry small pieces of brown paper smeared with sulphur; then when the skep has been driven as clear as possible, one of these is placed in a hole in the ground, lighted, and the skep put over it so that the few remaining bees are killed. The hive can then be carried into the house for the good wife to deal with.

If receptacles for conveying the bees home are few, two or more lots can be joined together by driving each lot successively into one skep. They will unite in this way without the slightest trouble from fighting. Select the best queens by allowing those to remain from the stocks that have swarmed.

A plentiful supply of empty match-boxes, each containing half a lump of moistened sugar, will enable one to save the lives of all the queens. About a dozen workers should be placed with each, and they should be kept in the pockets for warmth.

In carrying home, be sure to see the ventilated portion of the receptacle is upwards, and do not stack one on top of the other, the only exception to this rule being if it rains, when it is best to risk suffocation rather than drowning by placing the opening downwards. I have driven bees after dark, using a bicycle lamp focussed into the empty skep, keeping the head well below the line of light to avoid being stung, but under these conditions driving should not be done if it can possibly be avoided.

It is best to hive the bees immediately upon arrival home. This can easily be done if the bicycle lamp is called into use again, and so fixed that the light shines right into the entrance of the frame hive. The procedure is then as for hiving a swarm. Hiving driven bees by daylight often means great excitement in the autumn, the bees preferring to fly and settle upon potato tops, trees—in fact, anywhere but in the hive.

To strengthen weak colonies, the driven bees can be given at night by shaking sufficient necessary for the purpose on to the alighting board of each colony requiring help, taking care first of all to remove the queen from the driven lot. They run in and no fighting occurs.

Bees in wooden boxes can be driven, but in this case it is best to use a wooden box with the same length of edge—as it is difficult to fix a skep in position—a screw for a skewer, and at the sides a couple of straight pieces of wood with a screw through each end to go into the boxes and hold them securely.

It is of little use trying to drive bees from skeps that are only partially filled with comb, as the bees cluster in the empty space and refuse to go up. In such cases the quickest method is to carefully remove the combs one by one and brush off the bees.

If the queen passes up without being seen and it is necessary to catch her, this can be done by taking off the skep and inverting it by a sharp forward jerk. The bees are dislodged, and the queen is invariably seen creeping in the empty space left at the top; if not found the first time, then turn the skep round and repeat the operation, until she is seen in that position where she is easily caught.

The removal of the combs is often a trial to the cottager, so that when time permits it is policy to do this for him, at the same time cutting out all brood.

If several lots have to be driven and the bees begin to rob, do not hesitate to change the place of operation, going twenty to thirty yards away. If very troublesome although all these precautions have been taken, then, if possible, take them into a room or building where all access from the outside can be shut off.

Finally, do not scruple to pay a little for the bees, sixpence or one shilling for each good lot. Remember that smoking causes the bees to gorge themselves with honey, and each lot will carry away from half to one pound of the cottager's honey, and the small sum given will recompense him for this.

---



---

## Correspondence.

---

*The Editors do not hold themselves responsible for the opinions expressed by correspondents. No notice will be taken of anonymous communications, and correspondents are requested to write on one side of the paper only and give their real names and addresses, not necessarily for publication, but as a guarantee of good faith. Illustrations should be drawn on separate pieces of paper.*

---

### NOTES BY THE WAY.

[8239] The month of September brings the bee-keeper's active season to a close,

and having secured his crop of honey he must now look forward to what 1912 has in store, and anticipate its coming by getting his stocks into good order and condition. The brood combs should be examined and if there are patches of brood on three or four of the centre combs, every cell being evenly capped, and the queen a 1910 or 1911 bred one, make all snug for winter. If brace-combs project above the tops of frames leave them to form winter passages, but if you prefer to scrape off these natural beeways, you should provide a substitute by laying two or three little strips of wood across the centre of the brood combs. Where queens are two or three years old, the present is a good time to requeen, so that the introduced queen may have time to produce some brood before the cold weather sets in; by these means stocks will be in the best condition to meet the rigours of winter when it comes.

If all the brood combs are clogged with honey, which may happen in some districts this season, I should advise that two of these be extracted and put in the centre of the hive so that the queen may have room for eggs. This should be attended to at once. With care one may extract about three-fourths of the contents and leave a strip of capped honey along the top of the combs; in this case three of the combs may have part of the honey removed, but this work must be done towards evening, and the combs returned about 5 or 6 o'clock p.m., as there may be a big upset in the apiary if other bees get a taste of the spoils.

It is gratifying to know that the Government has at last allocated a grant for the assistance of bee-keeping. It is quite time that the utility of the bee should be acknowledged as a power in the economy of nature, by reason of the service it renders in the fertilization of flowers of the fields, fruits and vegetables. An experiment made by the late Professor Cheshire proved conclusively the necessity of insect fertilization of white clover flowers. A square yard of clover was covered with fine silk gauze, which prevented bees from gaining access to the flowers; this space produced two abortive seeds, while the adjoining square yard, which was not covered, produced between two and three thousand seeds.

*Wasp Plague.*—I should think Mr. Wright's bees (page 344) must have been queenless and in a very weak condition. Wasps have been very numerous in this district, but I have not heard of stocks being robbed out; still, as Mr. Wright observes, all the slaughter of wasps in bottles and burning out of nests does not seem to reduce the numbers that are continually invading the houses.

Will Mr. Ellis give his preventive method of curing or checking the "Isle of Wight" disease? It will be a boon to bee-keepers to know of a remedy.

Robbing is often rife during this month, strong stocks robbing out the weak or queenless colonies. Therefore it is a wise precaution to contract entrances. But examine your stocks, and if weak, buy a lot of driven bees and unite them to the weak colony, and if the queen is old, supersede her with the queen with the driven bees.—W. WOODLEY, Beeton, Newbury.

#### BEES IN OBSERVATORY HIVE.

[8240] My observatory hive is fairly interesting. One of the combs I put in was too thick and touched the glass nearly all over one of its faces. With admirable industry the bees have cut it down by about a quarter of an inch all over, leaving many curious props and straggling outlines of cells, some of which have been elaborated and are being used as temporary storehouses for syrup. The wasps are more numerous than I can remember before, and I hear of hornets' nests, but have not found one. The smell of a crushed wasp is particularly repellent to the ordinary worker bee, but occasionally one comes along whose nerves are less sensitive and she bundles the corpse out in no time. It seems to me that the live wasp has not only a very tough skeleton compared with that of the honey bee, but that it also has the knack of protecting its soft joints better. It is very rarely that a honey bee can sting a live wasp. If however you crush and paralyse the wasp before placing it in the passage-way to a hive the workers sometimes succeed in inserting their stings. I have occasionally seen a worker dragging the wasp along towards the entrance by means of her sting as a horse might draw a cart. If you observe a worker after she has succeeded in withdrawing her sting, you will find her expressing considerable uneasiness for some little while. It is a sensitive portion of her body. I have sometimes made a worker sting a piece of soft leather, and while the sting was still attached have severed it by means of fine surgical scissors, at the same time marking the bee with red paint. I could never find on the combs bees so treated and marked, after a period of twenty-four hours had elapsed. Ordinary marked bees may remain for days. I think, however, that any such markings are prejudicial to them.

I was possessed of a remarkably showy black eye this month. I have not had such a splendid specimen since I was a boy at school. I was driving skeps, and

the bees from a skep already driven were skirmishing about, and one of them stung me underneath and a little to the left of my left eye. It did not hurt much and I went on with what I was doing. When I came in to lunch there was an outcry, and on consulting a looking-glass, I found there was a claret-coloured patch under the eye. It gradually spread all round the eye and all over the eye-lid, and remained of that colour for several days, gradually passing away through the usual shades of green and yellow. If stings often had this startling effect, most of us would have to stop bee-keeping.—H. J. O. WALKER, (Lieut.-Colonel), Leeford, Budleigh-Salerton.

#### RISK TO HORSES FROM BARBED WIRE FENCE.

[8241] As I have had a similar risk to take about which your correspondent (S195, p. 346) was enquiring, perhaps my experience may be of use to him. My bees are kept in a field with only a two-barred wooden fence between them and two mischievous ponies. The only way in which the latter have interfered with the hives was on one occasion when they dislodged the roof of a hive within their reach. Also, one of them got stung while too closely watching me manipulating a hive, and has been more chary about bees since. The ponies, however, had a bad habit of frequently breaking the fence by pushing their heads underneath to get the longer grass there, and we had to put barbed wire right round the field to keep them within bounds. Within a week the younger and more venturesome pony had a nasty cut on the underside of the jaw (no doubt from the wire), which had to be stitched by the "vet." Since then no further injury has been sustained by bees, fence, or ponies. The moral seems to be that barbed wire fencing is safe except for young horses. I should say the danger your correspondent fears, of a horse getting strung up in the wire does not exist; horses have too much sense as a rule. In any case, he could not be held liable; the use of barbed wire is a recognised method of fencing. As to the bees stinging the horses, if a pure native strain is kept I think no trouble will ensue. The case I mentioned is excusable; the pony had his head over the fence, two yards from the hive which I had open and in sections; so far as I know this is the only case of the bees in any sense attacking the ponies.—CAMPBELL R. PINNEY, Sleights, R.S.O., Yorks.

#### NOTES FROM NORTH ESSEX.

[8242] Another season of labour among the bees is rapidly drawing to a close.

and, generally speaking, we feel that those who for several years have closed their communications with the ever-popular "hopes for a better season next year," have at last realised their anticipations.

The average apiary has produced a good crop of the precious "nectar of Heaven," and that not only as regards weight, but quality also. I have not yet seen a single uneatable section or extracted an ounce of unsaleable honey, and I must own up to heartily singing the Doxology at the thought of it. But the spirit of thanksgiving was less ardent when I received the handsome offer made by a London firm of 6s. per doz. for sections, and 50s. per cwt. for extracted honey, both, of course, of best quality, and it brought the question to my mind—Why sell prime honey, the choicest of all food, at one-third the price of salted butter? Why sell honey at a price that covers it with contempt as compared, for instance, with bacon?

I looked around for a scapegoat who should bear the blame of preventing my securing the full fruits of my labour early and late, and eventually found him. He was well fed and clothed, and had a comfortable banking account. He kept bees as a hobby pure and simple, and cared as little by what method he secured a "big take" from one hive as he did for his brother bee-man, whose wife and children had looked forward to the harvest with such ardent hopes in anticipation of some of the good things our honoured friend D. M. M. writes of—hopes too often doomed to disappointment. Now having, by fair means or otherwise, secured a real "Daily Mail" sort of crop, this amateur bee-keeper does all he can to persuade everybody that it only needs a mere trifle of money to start an apiary, an infinitesimal amount of labour in attending to the bees, the only real expense being the hire of a traction-engine to carry the crop from the hives home; the only difficulty to reckon the vast profits. It cannot be helped now, but, oh, I do wish Mr. Boaster had waited till I had sold out before embarking on his vainglorious labours. Maybe others do so also.—W. S. S., "Fennes," Braintree.

#### WORKER v. DRONE COMB IN SUPERS.

[8243] In the "Bee-keepers' Guide Book," page 114, it is said that "Bees may be profitably employed in drawing out comb foundation." "Some drone, as well as worker comb should be worked out." In a little work by S. J. Baldwin, he advocates using deep frames only in the super, so that the frames from super "can be exchanged for those below, &c." Langstroth, in the "Honey Bee," says

distinctly that the bees prefer and will build drone comb only unless the queen is close at hand to check them. Now if the latter is right, that only drone comb is built in supers from which the queen is excluded, the combs would be of no use for brood-chambers and in forming new colonies. I have this year put on four or five supers of deep frames, and they are all nicely sealed over, and I thought of putting driven bees on some of them, but I would like to have your opinion before doing so. I may say that the combs appear to be all worker combs. The foundation was ten-sheet brood.—MONTGOMERYSHIRE BEE-KEEPER.

[If you read the "Guide Book" carefully, you will see on page 124, in the chapter on Queen Rearing, that it is necessary to pay attention to the rearing of drones, and this is why the author advocates the keeping of a few combs of drone cells on hand. For the purpose of putting driven bees on them deep combs can be used in supers, and if full sheets of worker base foundation be used the bees will build only worker cells.—Ed.]

#### CAPPINGS OF COMB.

BY L. S. CRAWSHAW, NORTON, MALTON, YORKS.

*Care of Extracted Honey* (p. 292).—This reads more like the cure, or curing of honey. Whilst the advice is no doubt sound in its way, how much better it would be to extract only thoroughly ripe honey. The exposure and stirring must of necessity reduce the qualities of aroma and flavour. I have no sympathy with the extraction of "green" honey, and no artificial ripening can compare with that accomplished by the bees themselves. The best honey is that extracted in the autumn, and by that I mean after it has remained sealed for some time in the hive itself. By green honey, an American phrase, I mean unsealed or unripe honey, and not honey of that colour, such as is obtained from the sycamore. This, too, is best converted to the use of the bees, and not mixed with better coloured honey. In fact, judgment must be used at all times as to what should, or should not, be extracted.

*The Age of Flight* (p. 293).—Is it established beyond doubt that no bee less than fourteen days old will join the swarm? The point might be tested by placing in the old hive on swarming a set of principally-sealed brood-combs of another race, together with the returned swarm minus its queen. If this swarm, re-issuing about the ninth day, contained some foreign bees, the experiment would show that they were quite able to fly before that age. This reflection is induced by comparison of the statement that

a worker bee leaves the hive for flight on the fourteenth day, and observation of some large second swarms. If true, only a portion of the bees left behind by the prime swarm can issue with the cast. For those left behind are therefore of all ages, from fourteen days old to newly-emerged bees, *plus*, of course, workers returned from field-service. And in nine days' time only these said field-workers, *plus* such bees as were already five days old at swarming date, are fit to constitute the cast, whilst those remaining would be an army of almost similar proportions. That is to say, less the number of the aforesaid field-workers, and the difference due to diminution (if any) of oviposition, prior to the five days before first swarming. Without making accurate observation, it has seemed to me that colonies which have cast have been on occasion more depleted than a rigid observance of the above law of seniority would warrant. Hence this question. In other words, does the issue of a swarm interfere with the normal proceedings of maturity?

*Norfolk Honey* (p. 293).—This is a splendid return, and speaks well for the ability of, if I remember rightly, the young bee-keeper concerned. It is to be hoped that he has obtained his 300lb., though he may have to look forward to another year to top that notch. Most of the daily papers have an account, certified by the usual expert, of a Devon bee-keeper, who holds the world's record (*sic*) with 147lb. of honey obtained this year. Evidently he has never heard of Mr. Lancelot Quayle. Alas! Such is fame. Upon the other hand, this 147lb. is probably section honey from seven racks—no mean accomplishment.

*Clamour v. Claymore* (p. 296).—This is the first time I have seen the term "Cateran" applied to the bee. No doubt it is deserved in D. M. M.'s locality, for it is evident that he writes for Scotch readers, so his remarks for a special class, like those of Mr. Townsend, whom he justifies, may be quite in order. But is it fair to warn his countrymen alone, unless—but surely he does not mean that—we Lowland and quiet folk live in danger? For the days of forays over the Border are long past, and we now slay each other only with the ladylike pen.

*Heather Plans* (p. 304).—The plans outlined by Mr. Ellis are interesting, and some are not unlike those detailed by Medicus in the "B.B.J." (February, 1910). But the objection to a very shallow brood-nest immediately under sections seems to me to be that pollen will find its way into the sections. I hardly think that plan which unduly distorts the brood-nest when working for comb-honey is sound. Even with the excluder, pollen will be taken above. Of course, this is not so

serious an objection when shallow extracting frames are used, but heather honey should, in my opinion, be stored, and *eaten*, in sections. A further word from Mr. Ellis and Medicus would be helpful.

## Queries and Replies.

[8198] *Artificial Increase*.—I have three hives well stocked, and one empty. Will you kindly say if I can take two frames from each of the full hives to stock the empty one, or would it be better to purchase driven bees, or wait for a swarm next spring? If you advise taking the frames will you kindly tell me how to proceed?—J. W. E., Grimsby.

REPLY.—It will be better to wait for a swarm next spring to stock your empty hive, as it is too late to carry out the operation you propose, or even for the bees to build comb.

[8199] *Uniting Bees in Autumn*.—*Dealing with Foul Brood*.—(1) Is there a safe way of uniting bees at this time of year without having to move the two hives close together? The "Guide Book" says that one should not move hives more than about 3ft. a day, only counting days that bees are flying. Now, if a hive has to be moved thirty or forty yards, this will take a very long time; moreover, if one's apiary is on a steep slope, as mine is, one would have to level every time the hive is moved. Is there any other method I could try without losing bees? (2) I have three hives slightly affected with foul brood. What is my best course at this time of year? One stock is weak, the other two strong. If the bees were put into a fresh hive on foundation in the usual way, would they have time to work it out at this time of year if the feeder were kept going (the honey-flow is over)? Would it be well to unite them, having in mind my first question *re* distance apart?—B., Buxted.

REPLY.—(1) The alternative plan is to take one lot of bees a couple of miles away, let them remain for a few days, and then bring them back, and place them beside the stock they are to be united to. (2) Unite the weak lot of bees to the least strong of the others, burning all the combs, and use "Apicure" or formaldehyde. It is too late for the bees to build combs now.

[8200] *A Beginner's Queries*.—(1) Is it necessary to feed bees in the autumn when they have plenty of their own stores? (2) Should you call lewt. of section honey, with a possibility of more, a fair return from a June, 1911, swarm? (3) I am told my queen is a 1910 one. She is doing splendidly, and her offspring seem demon workers. Is she too old for next season's

work, and should I requeen? Answers in the columns of the "B.B.J." will be much appreciated.—A. H., Skye, N.B.

REPLY.—(1) No. (2) It is more than a fair return, being an excellent result. (3) As the queen is evidently a very good one you will be well-advised to let her remain for next season.

[8201] *Preventing Extractor from Rusting.*—(1) Could you tell me in your journal, which I much appreciate, a good way to keep a honey extractor from rusting? (2) Do bees generally pass through the "Porter" escape as readily at this time of the year as earlier? I find a lot left in the supers after cleaning up the combs.—J. MERRICK, Bristol.

REPLY.—(1) After the extractor is finished with for the season, wash it well with hot water, thoroughly dry, and smear it with a thin coat of vaseline. The underside of bottom should be kept well painted. (2) Bees do not go down so readily at this time of the year as earlier, the cold nights accounting for the difference. Also they do not leave combs that have been cleaned up so readily as those filled with sealed honey.

[8202] *Spacing Hives at the Moors.*—Should hives, on being sent to the moors, be placed 4ft. apart, centre to centre, as on their home stands? Several bee-keepers in this locality place them so close together that the roofs almost touch. I am a bee-keeper of only recent date, and should thank you for enlightenment on this subject.—W. R., Gordon, Berwicks.

REPLY.—It is much better to place the hives as far apart as possible for comfort in manipulating, and also to avoid undue excitement and robbing.

[8203] *Wax-mite in Sections.*—I shall be very grateful if you will let me know through THE BEE JOURNAL how to prevent what I suspect is wax-moth in my sections. They have only been off the hives about three weeks, but already small cotton-like marks are on the surface of the wax, which in one or two places is finely powdered. I have been storing them in wooden boxes. I suppose I can only extract them now. Thanking you for your anticipated help.—M. L., Emsworth.

REPLY.—It is not wax-moth, but a tiny mite which does the damage. We know of no cure, and it will be best to extract the sections if they are very bad.

[8204] *Introducing Queens.*—Excuse my troubling you again so soon for advice. On the 30th ult. I removed three old queens; and two days later I introduced the young ones in the evening. Two of the stocks accepted them at once. I found the other outside early in the morning; the stock had become very restless, and to-day I found more than a thousand bees dead about the front of the hive. I have

never had trouble in getting them to take a queen before.—J. H. MEYER, Fulham.

REPLY.—You do not say whether you caged the queens or not, and from the particulars you give it almost appears as if you had not done so. It is much safer to take this precaution. The bees in the other stock are evidently being robbed.

[8205] *Renewing Brood-combs.*—(1) When is the best time to remove old combs from the brood-chamber? (2) How should it be done so as not to destroy any brood?—BELLE VUE, Ipswich.

REPLY.—(1) If empty, remove the two worst combs from the hive in the autumn, and close the bees on to eight frames by means of the division-board. By the worst combs we mean those which are pollen-clogged, or contain an excessive number of drone-cells, or in which, through age, the cells are very small. If full of food, then place such combs at the outside, when packing down and remove them upon the first examination in the spring. (2) If outside combs are removed, no brood will be destroyed, as in the autumn and early spring this is absent in the combs in this position.

[8206] *Taking Queens to Australia.*—A friend who is going to West Australia in October next desires to take out six or eight queen bees. Can you, through the "B.B.J.," give a few hints on the packing and care of them during the voyage in order to ensure success? Thanking you in anticipation.—E. R. B., Kent.

REPLY.—The best plan will be to make some special boxes that will hold about a couple of sections, which should be full of honey. Put a queen and about a couple of hundred bees in each, taking care to see there is sufficient ventilation. When on board your friend should make friends with the steward, and get him to let them be put in the cold storage room, and they should travel all right.

---

#### "ISLE OF WIGHT" DISEASE.

We hear from Mr. S. Simmins, of Heathfield, Sussex, that he has found a cure for the "Isle of Wight" disease, and have seen the original letter of a bee-keeper who states that it has effected a cure with his stocks. It might be worth while for those whose apiaries have been affected, or who are located in districts where the disease has been prevalent, to write to Mr. Simmins for particulars.

---

## Bee Shows to Come.

September 12, at Woodstock. Oxfordshire Bee-keepers' Association Annual Show. Open Classes. No entry fee for the best Section, for the best jar of Run Honey. Prizes 7/6, 5/., 2/6. Entries to H. M. Turner, 4, Turf Street, Oxford. Entries close September 9.



**September 13, at Conway, N. Wales.**—Great Annual Honey Show in connection with the Conway Honey Fair. Open and local Classes. Entries closed.

**September 13 and 14, at Cambridge.**—Honey Show in connection with the Cambridge and District Red Cross Horticultural Society. Four Classes, open to all. To be held in the Corn Exchange, Cambridge. Schedules and particulars of Hon. Sec., E. F. Dant, Member of B.B.K.A., 52, Bridge Street, Cambridge. Entries close Saturday, September 9.

**September 14, at Castle-Douglas.**—Annual Show of South of Scotland Bee-keepers Association. Five open classes; Three 1-lb. jars extracted, 20s., 10s., and 5s.; three sections, ditto (Entry 2s.), 1lb. jar, also one section, 5s., 3s., and 2s. (Entry free, and exhibits retained unless otherwise agreed upon). Beeswax, 5s., 3s., and 2s. (Entry 6d.). Fourteen classes for members. Entries closed.

**September 16 to 23, at the Agricultural Hall, London.**—Honey Show in connection with the 19th Annual Exhibition and Market of the Grocery and Kindred Trades. Liberal prizes. Open to all British Bee-keepers. Schedules from H. S. Rogers, Secretary, Exhibition Offices, Palmerston House, Old Broad Street, London, E.C.

**September 26, at Horniman Hall, North End, Croydon.**—Exclusive Show of Honey, Wax, Hives, Bees, &c. Increased prizes. Six Open Classes. Judge, Mr. W. Herrod, F.E.S. Schedules from A. Wakerell, 21, Mansfield Road, Croydon. Entries close September 16.

**September 27, at Altrincham.**—Honey Show, in connection with the Altrincham Agricultural Show, the largest one-day show in the Kingdom. Classes open to United Kingdom. Classes for Trophy of Honey, for Best Hive, Observatory Hive with Bees and Queen, twelve Jars of Extracted Honey. Classes open to County of Chester, for Run and Section Honey, Wax, &c. Special Classes for Cottagers, and Special Classes for Society's District. Several Special Jubilee prizes. Schedules from Mr. J. Herbert Hall, 2, Dunham Road, Altrincham. Entries close September 9, and at extra fees September 13.

**WEATHER REPORT**

WESTBOURNE, SUSSEX.

August, 1911.

Rainfall, 79in.	Minimum on grass,
Below aver., 1'83in.	42° on 31st.
Heaviest fall, 18in.,	Frosty nights, 0.
on 28th.	Mean Maximum 76.
Rain fell on 9 days.	Mean Minimum 56'1.
Sunshine, 275'4 hrs.	Mean temperature,
Above average, 58'5	66.
hours.	Above average, 5'3.
Brightest days, 9th	Maximum barometer,
13'7 hours.	30'263 on 31st.
Sunless days, 0.	Minimum barometer,
Maximum tempera-	29'538 on 21st.
ture, 92° on 13th.	
Minimum tempera-	
ture, 43° on 31st.	L. B. BIRKETT.

**Notices to Correspondents.**

J. W. S. (Wembley).—*Dead Bees*.—The bees appear to be robbers. A few particulars would assist us in giving an opinion. There is no disease so far as we can judge.

D. C. H. (Coldstream).—*Insect Nomenclature*.—The insect is *Sirex Jurencens*, a kind of wood wasp. It is not rare in some districts.—F. W. L. S.

I. A. N. (Higham).—*Dealing with Sections*.—Sections should be disposed of as quickly as possible, as they become unsaleable if granulated. When in this condition they can only be relieved by cutting them up and melting the honey and wax, afterwards allowing it to cool. The wax can then be taken off and the liquid honey remains. The length of time sections remain ungranulated after removal from the hive depends upon the source from which the honey was gathered, and the place and manner in which they are stored.

*Suspected Disease.*

A. D. L. (Arbroath).—The bees are badly constipated. It will be well to send a few (alive if possible) to Dr. Malden, Pathological Laboratories, Cambridge, for a bacteriological examination.

*Honey Samples.*

H. J. B. (Walthamstow).—No. 1, fairly good in consistency and of nice flavour, but not so good in colour as No. 2; the latter is a denser honey from clover, but the flavour is somewhat spoilt by an admixture of ragwort. Either would do to enter at a local show.

W. G. WELLS (Blandford).—An excellent sample of light honey, very dense, of good colour, and bright in appearance. The flavour is also very delicate and it is well worth showing.

J. B. N.—Both samples are practically pure white clover, and very good in every respect except density, which might be better. No. 1 is undoubtedly the best and is worth staging in open competition. We regret the unavoidable delay in publishing the book, yours being only one of hundreds of inquiries as to when it will be ready. It will not be kept back a moment longer than we can help. The excessive amount of work we have had to do is the chief cause of delay.

A. D. R. (LEDBURY).—No. 1 is a medium honey from mixed sources. No. 2 is from fruit and lime. Both are good enough to show in their respective classes. The source from which it is obtained is responsible for the colour.

L. BERRY (Nelson).—No. 1 is a light clover honey, colour, brightness, and flavour good, density fair. No. 2 is also a light honey from clover, good in all respects. No. 3 contains an admixture of heather, but, unfortunately, it is spoilt with honey dew. No. 4 is a heather blend, its only fault being that it is rather thin.

Uxor (Yorks).—No. 1 has a rather strong flavour of ragwort, and this also accounts for the odour. No. 2 is good in colour and flavour, but in density is only fair.

J. J. W. (Whalley).—No. 1 is from clover, density fair, colour and flavour good. It should be shown in light honey class;

but it is doubtful if good enough to secure an award. No. 2 is a very nice heather blend and should be shown in that class. It ought to stand a good chance in any competition.

J. A. D. (Wanstead).—The sample is a very good lime honey, and a capital sample for table use. Though a little dark in colour the flavour compensates for this.

W. M. C. (Burgess Hill).—Honey is from clover and sainfoin. It is good enough to show in local classes.

A. G. W. (Wembley).—Both samples are suitable for the show bench. No. 1 should be entered in the light class, No. 2 in the medium class. They do not require more straining. The colour of honey depends upon the source from which it is obtained. Full particulars, which vary with each show, are given in the conditions printed on schedule.

### Special Prepaid Advertisements.

Two Words One Penny, minimum. Sixpence.

Orders for three or more consecutive insertions entitle advertisers to one insertion in "The Beekeepers' Record" free of charge.

Trade advertisements of Bees, Honey, Queens, and Bee goods are not admissible at above rate, but will be inserted at 1d. per word as "Business" Announcements, immediately under the Private Advertisements. Advertisements of Hive-manufacturers can only be inserted at a minimum charge of 3s. per  $\frac{1}{2}$  in., or 5s. per inch.

### PRIVATE ADVERTISEMENTS.

**STRONG LOT OF BEES**, covering ten frames, healthy condition, good hive, 21s.; two second-hand Hives and accessories, 7s. each.—75, Moffatt-road, Thornton Heath. m 62

**HONEY IN BULK FOR SALE**, about 3cwt.—BRIGHTON, New York, Lincoln. m 61

**BEST PURE EXTRACTED HONEY**, 28lb. tins, 14s., lever tins free.—BARFIELD, Broom. Biggleswade. m 62

**APIARY FOR SALE**, (in lots if desired), including 12 Stocks English Black Bees in Standard Hives, guaranteed free from disease, young Queens, clean Brood Combs, Shallow Frames, drawn out Combs, Supers, Excluders, Feeders, Smokers, Brice Swarm Catchers, Extractor, Ripener, Comb Foundation; also 150lb. medium coloured Honey in screw cap glass jars; 4 doz. medium glazed Sections; owner going abroad.—BANKWOOD, Charing, Kent. m 45

**A FEW CHOICE HYBRID ITALIAN QUEENS**, very prolific, in cage. 3s.—H. CEILEY, Highcroft, Muswell Hill-road, N. m 46

**FOR SALE, FINE CLOVER HONEY**, sample, 2d.—MARSHALL, 68, Chelmsford-street, Lincoln m 47

**POLISHED MAHOGANY OBSERVATORY HIVE**, by Abbott's, takes Standard, shallow and sections, 39s.; also 3-frame strong Nuclei, 1911 Queen, 11s. 6d.—BARLOW, bee-keeper, Newcastle, Staffs. m 48

**WANTED**, Cowan's Reversible Extractor, second-hand, good condition 2 or 4 frame; also Stocks in Skeps.—PICKERING, Willow Dale, Blythe Bridge, Staffs. m 49

**WANTED**, American Standard, Hoffman Bar Frames.—CUNNINGHAM, 51, George-street, Bonhill, Dumbartonshire. m 50

**FOR SALE**, several 8 9, 10 Comb Colonies British Bees, no Hives, 30s. each. C. J. ASHWORTH, bee expert, Heytesbury. m 53

**14 COLONIES**, Bar Frames and Skeps, enough winter stores, all Frames worked from full sheets foundation, healthy and strong, all young Queens, boxes and skeps good; also Section Crates, Dividers, Excluders, Feeders, Escapes and Boards; state requirements; no reasonable offer refused; owner getting transferred to other district, must sell. Stamp for reply.—S. HARRIS, Postman, Aberfeldy. m 52

**WANTED**, Extractor, perfect order and cheap.—Particulars to HANSPORD, 68, Brantfield-road, Blackburn. m 55

**ELEVENTH SEASON**.—Finest Clover Honey, 1 pound screw caps, 8s. 6d, tie-overs, 8s. doz, bulk, 6d. lb.—WYATT, bee-keeper, Chard, Somerset. m 56

**HONEY**, choice clover, well ripened, 60s. cwt., good medium blend, 55s.; sample, 3d.—THOS. E. ATKINS, Leire, Lutterworth. m 57

**1911 CHOICE fertile English Queens**, in introducing cages, 2s. 6d. each, guaranteed healthy.—WITHEYCOMBE, Docks, Bridgwater. m 58

**WANTED**, 4 lots of Driven Bees, guaranteed healthy.—St. Elmo, Carshalton Hill, Coulsdon. m 44

**EXTRACTOR**, worked out Combs, sundry appliances, clearing.—65, Raleigh-road, Richmond, Surrey. m 43

**VOLUMES "B.B.J."**, 1 to 15, bound, some very rare, £3; also large quantity of other Bee Books; list on application.—ABBOTT, Merchants' Quay, Dublin.

**WANTED**, Combs damaged by wax moths, perfect wax moths, and cocoons.—HERROD, Apiary, Luton.

**FOR SALE, EXTRACTED HONEY**, in 14lb. tins; sample, 2d.; 5s. 6d. cwt.—ARTIUR ADCOCK, Ashcroft, Meldreth, Cambs. m 42

**100 SECTIONS of HONEY**, well filled, 9d. a section.—Mrs. BUTLER, Gageley Vicarage, Newmarket. m 41

**SPLENDID FERTILE QUEENS**, 1911, in introducing cage, 1s. 6d.; few dozen light Sections, 8s.; light Cambridgeshire Honey, 60s.—f.o.r. W. JOCKMAN, Sidney Farm, Cambridge, E. m 60

**FOR SALE**, 3-h.p. Lloyd Motor Cycle, in good condition, Palmer's tyres; price £6 10s.; also 3 $\frac{1}{2}$ -h.p. Lincoln Elk, just been overhauled, very fast and reliable; new tyres; a bargain, £11 10s.—H. DRAYTON, New Bolingbroke, near Boston. m 6

**HONEY**, good colour, flavour and well ripened, 58s. per cwt. on rail; tins free; 4lb. sample six stamps.—J. IRELAND, Vernham, Hungerford, Berks. m 98

**FOR SALE**, 10 $\frac{1}{2}$  ACRES OF LAND, well built bungalow, good outbuildings, fruit trees, &c. JOHNSON, Sheepdrove, Lambourn, Berks. m 17

**ORIGINAL** pattern Yorkshire Heather Honey Press, new, fully tinned; price and particulars.—HOOD, Whitby. m 11

**TO LARGE BUYERS**.—9cwt. good light-coloured Honey, and 16 doz. Sections from own Bees, for sale.—DAVID HANCOX, Deddington, Oxon. m 28

**OBSERVATORY HIVE**, mahogany, ornamental, complete with turntable, tunnel feeder, section frames.—Particulars, offers, ROBERTSON, St. Mary's Crescent, Portsmouth. m 90

**FINEST FLOWER HONEY**, in sections, 10/6 per doz.; extracted Honey, in tins, £3 per cwt., sample 2d.—WILLIAM WILSON, 25, Forfar-road, Kirriemuir. m 160

**FOR SALE**, cwing to removal, 5 Stocks of Bees in Lees Holborn Hives, in good condition, all 1911 Ounces, price 15s. each, or £3 the lot.—F. CRAWTER, Cheshunt, Herts. m 38

**SECTIONS**, 1st grade, clean, white clover, 9s. per doz., packed on rail cash with order.—BARNES, Clogger, Wigton, Cumberland. m 27

**ORIGINAL AND BEST RYMER HEATHER HONEY PRESS** for sale.—THOS. HOOD, Whitby. m 25

# Editorial, Notices, &c.

## SHROPSHIRE B.K.A.

### ANNUAL SHOW.

The annual exhibition, promoted by the above association, was held in the Quarry, Shrewsbury, in connection with the great horticultural fête, on Wednesday and Thursday, August 25th and 26th, when a record entry was made, no less than 2815lb. of honey being staged. The bulk of the exhibits was of the highest quality, and with the large number of entries in many of the classes, the judges had a difficult task in satisfactorily awarding the prizes. The judges were Mr. A. Watkins, Hereford, and Mr. J. Tinsley, expert to the Staffordshire B.K.A. These gentlemen reported that they never had a finer display placed before them, and that some of the classes were so good throughout as to deserve a commendation to each exhibit. The awards were as follows:—

### OPEN CLASSES.

*Twenty-four 1-lb. Sections.*—1st, J. Carver, Wellington; 2nd, S. Cartwright, Shawbury; 3rd, F. C. Holmes, Welshpool.

*Twelve 1-lb. Sections.*—1st, J. Spiller, Taunton; 2nd, James Clay, Wellington; 3rd, R. H. Baines, Cambridge.

*Twenty-four 1-lb. Jars of Extracted Honey.*—1st, H. R. Millington, Wistanswick; 2nd, F. C. Holmes; 3rd, E. Church, Cardiff.

*Twelve 1-lb. Jars of Extracted Honey.*—1st, H. R. Millington; 2nd, F. C. Holmes; 3rd, A. O. Jackson, Thetford, Norfolk.

*Twelve 1-lb. Jars of Medium-coloured Honey.*—1st, P. Scott, Broseley; 2nd, F. C. Holmes; 3rd, J. Berry, Llanwrst.

*Twelve 1-lb. Jars of Dark Honey.*—1st, J. Berry; 2nd, H. Greening.

*Single Jar of Extracted Honey.*—1st, F. C. Holmes; 2nd, J. Chetwood; 3rd, H. R. Millington.

*Single 1-lb. Section.*—1st, J. Carver; 2nd, H. W. Saunders; r., P. Scott.

### MEMBERS' CLASSES.

*Twenty-four 1-lb. Sections.*—1st, J. Carver; 2nd, S. Cartwright; 3rd, T. Bromfield; r., P. Jones, Church Stretton.

*Twelve 1-lb. Sections.*—1st, J. Clay, Wellington; 2nd, P. Jones; 3rd, J. Bright.

*Twenty-four 1-lb. Jars of Extracted Honey.*—1st, H. R. Millington; 2nd, S. Cartwright; 3rd, J. Mills.

*Twelve 1-lb. Jars of Extracted Honey.*—1st, H. R. Millington; 2nd, T. Tudor; 3rd, J. Leech; r., J. Chetwood.

*Twelve 1-lb. Jars of Medium-coloured Honey.*—1st, S. Cartwright; 2nd, F. W. Norris, Church Stretton; 3rd, P. Glover, Bicton.

*Twelve 1-lb. Jars of Dark Honey.*—1st, P. Scott; 2nd, R. H. Elson, Wellington; 3rd, J. S. Lawton, Bridgnorth.

*Twelve 1-lb. Jars of Granulated Honey.*—1st, H. R. Millington.

### COTTAGERS' CLASSES.

*Twelve 1-lb. Sections.*—1st, J. Rogers; 2nd, J. Mills; 3rd, H. Goodall, Ludlow.

*Twelve 1-lb. Jars of Extracted Honey.*—1st, H. R. Millington; 2nd, G. E. Miles, Baschurch; 3rd, J. Mills, Baschurch.

*Six 1-lb. Jars of Extracted Honey.*—1st, H. R. Millington; 2nd, G. E. Miles; 3rd, T. Tudor; r., J. Rogers, Shawbury.

*Six 1-lb. Sections.*—1st, G. Croxton, Grinshill; 2nd, E. Micklewright, Harmer Hill; 3rd, J. Wynn, Rowton.

*Twelve 1-lb. Jars of Extracted Honey.*—1st, G. Croxton; 2nd, J. Wynn; 3rd, J. Chetwood.

*Six 1-lb. Jars of Extracted Honey.*—1st, G. Croxton; 2nd, J. Wynn; 3rd, G. Butler.

### MISCELLANEOUS.

*Trophy of Honey.*—1st, J. Carver; 2nd, P. Scott; 3rd, F. C. Holmes.

*Complete Hive.*—1st, Messrs. Little and Cooper, Shrewsbury.

*Collection of Appliances.*—1st, Messrs. Little and Cooper; 2nd, G. Rose, Liverpool.

*Bee-sauce.*—1st, J. Berry, Llanwrst; 2nd, J. W. Dovaston; r., H. R. Millington.—S. CARTWRIGHT, Hon. Sec.

## AMONG THE BEES.

### HOW ARE STORES?

By D. M. B. Macdonald, Banff.

The more experience teaches me the more am I led to emphasise the importance of this question as September draws to a close. Here, in the midst of the heather, we have a late flow, a great part of which the bees consign to the brood frames, sometimes to such an extent as to clog the cells in the lower storey, and consequently we give little care to the store cupboard, knowing it is likely to contain 30lb. or over of the most delicious nectar for the bees to feast on during the next seven months. In earlier districts, and especially where extracting takes place, it is wise to assure oneself by ocular demonstration that the bees have from 25lb. to 35lb. of healthy stores before packing them for the winter. Indeed, a great part of the success of next season depends on the present condition of the colony in regard to food, so nothing should be left to chance; mere guessing is fallacious, and may lead to disaster. See what is inside, and if your calculation is less than your ideal total stores make it up with good, thick, well-prepared syrup. Err rather on the side of over much. A well-known writer says he likes "millions of stores" in the brood frames in April and

May, or before fruit bloom, and other early sources yield a stimulating supply to encourage rapid breeding in late spring and early summer. That should be our ideal.

*Coronation Edition of the "B.B.K. Guide Book."*—New edition follows new edition so steadily and stately that we are apt to look on it as a matter of fact. This, the twentieth in number, is better than any of its predecessors, and more up to date. It seems appropriate, too, that it should happen to come in Coronation year. What changes have taken place in apiculture since the first issue of the "Guide Book" appeared in 1881—just thirty years ago! A guide book in fact, as well as in name, being founded on practical knowledge thoroughly tested, it rapidly established itself, and has led and continued an easy first from then up to the present. Not only is it the standard work in the British Isles, but it is recognised as being in the first rank wherever the English language is spoken. Further editions have also been published, translated into French, German, Danish, Swedish, Spanish, Dutch and Russian, as the preface informs us. Few features are at present bulking so largely in the apicultural world as bee diseases, and this newest edition deals with the most recent investigations, and records the latest facts in all the many troubles that afflict the bee-keeper and the bees. That the "Guide Book" will soon "come of age" by a demand for a twenty-first edition would be a crowning reward to the veteran author, and the rapid sale augurs well for such a consummation at an early date.

*Features of the Season.*—Several of these are well worth recording. It has been a season of abnormal swarming, of which many instances might be given. One skeppist started the season with only three "raskies." He ended with thirteen! One swarmed four times, all four giving a good account of themselves. One swarm swarmed twice. At least five of the collection will average 50lb. net weight. Runaway swarms have been a leading feature; almost everybody has had one or more of these, and the worst of it is most of the runaways went to regions unknown. Many instances have come under my notice of swarms giving a surplus of from forty to fifty sections, and several cases are known to me of swarmed stocks yielding a like return.

Where bees were in good heart in those glorious days of the first fortnight in July, supers were filled as if by magic. Afterwards the season proved too hot and too dry, so that even in fine weather the amount of storing bore no proportion to the apparent amount of foraging by the bees. They toiled willingly, but nectar

secretion yielded only tiny dribblets. Worse still, in most northern regions the heather bloomed poorly, and rather aggravatingly dried off very quickly, so that the yield was short. I never observed the bloom wither up so quickly or at so early a date. All who have obtained heather surplus should stand out for a good price. My own returns varied from 100lb. down to a blank—and there were too many of these latter, thanks to disease!

*The Honey-maker.*—"The bee is itself one of the most wonderful proofs of the goodness and power of God. That within so small a body should be contained apparatus for converting the "virtuous sweets" which it collects into one kind of nourishment for itself, another for the common brood, a third for the royal princesses, glue for its carpentry, wax for its cells, poison for its enemies, honey for its master, with a proboscis almost as long as the body itself, microscopic in its several parts, telescopic in its mode of action, with a sting so infinitely sharp that, were it magnified by the same glass which makes a needle's point seem a quarter of an inch, it would yet be invisible, and this, too, a hollow tube; that all these varied operations and contrivances should be enclosed within half an inch of length and two grains of matter, while in the same "small room" the "large heart" of at least thirty distinct instincts is contained, is surely enough to crush all thoughts of atheism and materialism, without calling in the aid of twelve heavy volumes of "Bridgewater Treatises." I was so taken with the above long-involved sentence when I read it that I determined to quote it for the benefit of B.J. readers. It is a fact that this small creature is a *multum in parvo*, a small body with a large intelligence, and many of the organs are a marvel of perfection in design, construction, and the perfection in which they carry out their various functions; and although the bee is "little among the fowls, yet doth her fruit pass in sweetness."

---

## Correspondence.

---

*The Editors do not hold themselves responsible for the opinions expressed by correspondents. No notice will be taken of anonymous communications, and correspondents are requested to write on one side of the paper only and give their real names and addresses, not necessarily for publication, but as a guarantee of good faith. Illustrations should be drawn on separate pieces of paper.*

---

### ROSS-SHIRE NOTES.

[8244] In reply to Mr. Woodley (page 355), the colony cured of paralysis was caught in time, so no extreme

measures were required. The cure in this case was an antiseptic dummy board supplied by Mr. Simmins, and the result complete recovery with a surplus of 190lb. section honey and increase as well. I hope Mr. Simmins will favour us with the results of his investigations into the cause and cure of this mysterious bee-malady. Later on, I may describe my own experiences. Meantime, honey-selling claims all our attention. Luckily, the bees need none in the way of feeding, so dear sugar concerns us not apiculturally. The excellent heather harvest filled up supers and store combs alike, so ample packing for the predicted severe winter is all we need attend to in the apiary. This has been a "slump" summer for stocks and shares of all kinds, but investors in apicultural "stocks" have no reason to complain. Personally, I have sold more honey than ever before with little trouble, and at a fairly good price. Like Mr. Crawshaw, I should be glad to hear how "Medicus" has fared at the heather this season. My own results from shallow brood-chambers were good, and in one instance excellent.—J. M. ELLIS, Ussie Valley.

#### HOW TO FIND A MARKET FOR HONEY.

[8245] The year 1911 will be a memorable one in many respects to bee-keepers, chiefly for the way the Press has exposed their troubles by giving prominence in the columns of papers and magazines to the disease amongst bees, the recognition of the bee industry in the form of a Government grant to extend the sphere of usefulness of the British Bee-keepers' Association, and last, but not least, the good honey harvest.

Amidst the rejoicing over the latter, we hear occasionally a discordant note coming from the younger class of bee-keepers: "What shall I do with the honey now I have got it?" These have probably started bee-keeping during the last two or three years, and in consequence of small returns, little surplus has had to be disposed of. This year the novice is called upon to show his capacity from the business standpoint, and unless he belongs to an association which assists its members to find a market for their honey he will have to enter into the commercial chase and find a market himself. The usual method of going about this is to take the honey to a market town and offer it to the tradesmen, such as the grocer, confectioner, dairyman, greengrocer, &c., but by the end of the second or third week of a bountiful season, such as we have had this year, the tradesman has as much as he requires, therefore our novice,

after searching the town over, finds there is a glut in the market. He then has to decide on a course—whether to take it home, hand it in to the auction mart, or become the victim of the smart trader, who may offer him a ridiculous price for his goods. Whichever course he adopts the question will arise in his mind, "Does bee-keeping pay?" No doubt here comes the benefit of combination amongst bee-keepers to decide on the price at which honey should be sold at their particular centre; it also makes possible the establishment of a central depot where honey could be taken, and the bee-keeper rest assured that he will get fair treatment as regards grading the honey and disposing of it at the market value. Where no association of this kind exists the bee-keeper must either dispose of his produce to the local trader, or become his own trader and cultivate the business instinct. To be successful in this, he must first decide upon the class of market he will cater for, first, that for household purposes in the form of sections or extracted honey suitable for the table, secondly, that used by manufacturers, such as wholesale chemists, sugar-boilers, confectioners, biscuit makers, and proprietary medicine manufacturers. The honey in this case is sent away in bulk, in half to 5cwt. lots. If deciding to supply in the latter form, unless he has a large quantity, it would be wise to find through his county secretary, some bee-keeper who works with a similar object, and get him to give a price for his whole stock; it will save the trouble of finding a manufacturer and also be a saving in carriage.

In deciding to search for good customers for the domestic grade of honey, the bee-keeper should remember that honey is chiefly gathered in the country, therefore, the best market is the non-producing centres such as the large industrial towns and seaside resorts. A few insertions of an advertisement in the trade papers which deal in honey, say, the grocery and confectioners' trades, the bee journals, *Exchange and Mart*, &c., will be helpful. And if it is desired to fix on a certain town and concentrate one's endeavours to create a market on it, get to know the best local paper and put in a few insertions of a smartly-worded advertisement. There are advertising agents who would help one, and it could all be worked through them.

A personal canvass, however, will prove a most effectual way of establishing a business connection. Say a day-trip is taken to a seaside town: a case with a few samples of sections and honey in jars got up in different ways ready for the counter trade, with a good label and address on same, should be taken. If not

acquainted with the names of the traders in the town the Public Library will provide a directory from which to get the names and addresses. Select the best and most up-to-date shops. Ask to see the buyer—a snub may be received, but never mind that. Don't say you have something new to dispose of, but some of the finest Wiltshire honey to show him. If he pauses, flash the samples before him. You may effect a sale or not, but leave your card. "Card?" Yes. Not an old envelope that has done service through the post with your name on, but a smart business card, say with a photo of your apiary on one side and printed matter on the other. These cards can be had for a few shillings per 100, and as for the block, write to the Editor of the "B.B.J.," he will help you. You may find it a full day, but one which you will look back upon with much pleasure and profit, for, once get a customer and serve him well, you are fairly sure of your market for the future.

Another method is to enter honey at the "Grocery" and "Dairy" shows. Buyers and sellers meet here in the business atmosphere of England's honey market. You will also see how honey and bee produce is prepared for the market to perfection. When sending honey by rail, have a label on each package with HONELY boldly printed, and name and address. Smart men are always on the look out for fresh fields for business, and even this detail may bring customers. You may say, "I don't want all this fuss and bother." Well, try a few methods nearer home. Have you tapped your own neighbourhood? You may live in a village with fifty to a hundred residents. Do they know you have honey for sale?—even though they are aware that you keep bees. Procure a printed card, which may be placed in the window or in a glazed frame hung in a prominent position: "Finest Honey for Sale." Have your card sent to the doctor, the clergyman, the manor house, or spend a few hours calling on likely private buyers, both in your own and the adjoining villages. You will be surprised at the results. Here is an incident which shows how a local flower show may add to the bee-keeper's outlet for honey, also how uninformed some of the inhabitants may be of the producing powers of their village. I was present at one of these shows; the honey staged was very good, and during the afternoon a lady inquired if there was any for sale. Knowing that one of the bee-keepers had squeezed in a dozen sections with a view to selling them, I said "Yes," and ventured to ask a good price. The order was for six to be sent to the Manor House, and the buyer inquired where she could send for more. I gave her the name and

address of the bee-keeper, and she was surprised to know she could get it in the village. During the day several bee-keepers told me they did not know what to do with their honey. After the above-noted incident, I said *sell it*, and got a wink from the friend who had secured the Manor House customer.

Here is another incident. On Aug. 19th a cutting was sent on to me, taken from the *Daily Mail* of that date, bemoaning the troubles of the Devon bee-keepers; their honey being a drug on the market. Being at a Devon watering-place at the time I took a look round. There were several shops in the place, and about 100 visiting families, with a great number of children. I called at the principal shops and restaurants, but could find no honey, until I discovered at a lock-up greengrocer's shop, in a side street, two sections at the back of the window between a marrow and three cucumbers. The condition they were in was not at all inviting, not being clean or glazed, but left just in a condition to be attacked by wasps and flies. I asked the price, and was told 1s.; I then ventured a further question: "Much honey about this year, and getting good sales?" The reply was "No." I believed it, for the seventeen days after that I kept my eye on the window the total sales were not more than six. Now, if the young bee-keeper is to get rid of his honey, and at the best price, he must push through the glut of his own district and find his market outside, and, having once secured his customers, when a shorter crop comes another year he will be able to help his brother bee-keeper by buying up his surplus honey.—J. E. PINDER, Salisbury.

#### CONTROLLED FERTILIZATION OF : QUEENS.

[8246] While recently perusing a Consular Report a statement caught my eye in reference to bee-keeping in Egypt. One passage says that "He (Professor Blandinier), by cutting the wing of the queen bee, has been able to bring about fertilization while in captivity, and so prevent swarming." Now what does this mean? Can it be that our Vice-Consul at Alexandria has got things slightly mixed. One can understand that the operation will prevent the loss of swarms, but will the cutting of the queen's wing ever prevent a colony from swarming? Even assuming that fertilization of the queen by this means has been controlled to any degree successfully, the question arises, What influence to prevent the natural tendency to swarm can this exert over the normal conditions of affairs when copulation takes place on the wing?

Evidently Professor Blandenier has been to some extent successful in his experiments, for an article has been published by him entitled, "*Eccoudation des mires abeilles en captivité. Publications de la Société d'Histoire Naturelle d'Alexandrie* No. 3, 1910." I do not remember seeing a review of this work. Can we persuade "Nemo" to come to the rescue with a brief account of the actual experiments? It is indeed welcome to see that the value of bees for the fertilization of fruit is recognised in Egypt, and as stated "cannot be over-estimated." Bee-keeping is recommended to be taken up on the many fruit farms now being established. It is said the native honey, though very sweet, has little flavour, but in spite of this there is a considerable local demand at good prices.—GEORGE W. JUDGE, Dartford.

### ANOTHER STRIKE.

[8247] Some human beings are said to have a "bee in their bonnet,"—though, by the way, one might ask: "Can anyone have a bonnet without a 'b' in it?"—if they are somewhat erratic in their ways of thinking and acting; and no wonder, as the following story of a swarm of bees will show.

The writer, to begin with, this year had three beehives loyally painted Red, White, and Blue, sitting in his garden in that order, and with a promising stock of bees in each hive. Six of the twelve frames in each were well covered with bees in the early spring. All that need be said about the White hive is that it sent off a prime swarm on July 4th, which was treated in the ordinary way by starting a new colony. And anything that may be said about the Blue hive is in the way of striking contrast to the Red hive, which turned out to be the truly erratic one of the season.

Alike on Red and Blue, "supers" were placed on June 6th. On the 16th of the same month, both hives were examined, and queen-cells were seen to have been formed in both, but more decidedly in the Red hive. All queen cells were cut out, as no further increase of colonies was desired.

The Blue hive never swarmed all the season, and has yielded over 60lb. of honey.

But the Red hive, on July 7th, sent off its "top swarm," which I put back after having again cut out all the queen cells. The queen, a second-year one, was duly observed as the bees were marching back in the evening to the hive. The very next day, however, the swarm again came off, lighting conveniently on both occasions, on a gooseberry bush near the hive.

The same returning process was gone through, and again the queen was seen. July 9th passed without further outside-movement, but July 10th was a specially warm day, and off came the swarm for the third time in the very presence of the displeased and frowning owner. As there was now a special fear of the bees taking a longer flight this time, use was made of the spray, and also of a tea-tray and drumstick. The bees again settled on the same gooseberry bush, only this time in two clusters. Nevertheless, they were dealt with as one swarm, and again returned in the evening to the old hive, after I had not only cut out all the queen cells, but removed all brood-combs, and filled their places with drawn-out combs from another hive. On July 11th signs of war having commenced amongst themselves were seen in the shape of a goodly number of dead bees lying around the entrance to the hive. At once the hive was opened; no queen was to be seen, but the bees were carefully sprinkled with essence of peppermint. But, perhaps in harmony with July 12th, many more signs of deadly strife were to be seen. All was so quiet by July 19th that the hive was again examined. No queen could be found, but about half-a-dozen new queen cells had again been formed, though no newly-laid eggs were to be seen in the cells. These queen cells were all cut out, except one, which was carefully watched till two days past the longest time for hatching-out. The cell was then forcibly opened, and only a half-developed dead queen was found inside. On July 27th a young queen, secured from a White hive cell when it swarmed on July 4th, was safely introduced to the Red hive, and by August 7th some eggs, and sealed-brood even, showed that the young queen had very promisingly commenced her reign. The strike had ended, and work had decidedly begun.

Now this strike, like all others, was doubtless the result of the strike-fever having seized the bees in this Red hive; but one naturally wishes to know why such dissatisfaction, disorder and destruction took place as stated in the foregoing story. And, therefore, Mr. Editor, you may find space to raise such questions as the following:—

(1) Was the Red hive rather late in being supered and the Blue taken in time?

(2) Should all the combs of brood and queen cells have been removed before the first returning of the swarm, and not merely at the third returning?

(3) Had the insertion of the drawn-out combs from another hive anything to do in originating the unhappy war between bees of the same hive?

(4) And is there any significance to be attached to the swarm settling into two clusters on the third occasion when they came off?

(5) Was that doubling due to the deafening noise of the tea-tray drumming?

(6) Would it not be better in the future never to begin putting back a top swarm?

Your readers may be interested and instructed in thinking out for themselves the answers to such questions, and should any one of them be able to throw light on the whole story, it will be gladly welcomed by—  
A. PERPLEXED APIARIAN, Wolfelee, N.B.

### INFECTIOUS PARALYSIS.

#### SUPPLEMENTARY TREATMENT, &c.

[8248] As I am quite unable to reply fully to the many correspondents who are applying to me since you were good enough to insert the paragraph in the *BRITISH BEE JOURNAL* of Sept. 7 regarding the above complaint, may I crave your indulgence in granting me further space that I may explain how diseased stocks can be greatly assisted, and infection to a considerable extent restricted?

I had a serious experience with bee-paralysis in 1879, while residing at Crawley, and at intervals have been appealed to for advice as to the cure of paralysis from local poisoning and other mild forms of that trouble, but I had heard of nothing in this country so serious until the late havoc was caused among Isle of Wight and English apiaries. I had no difficulty in disposing of the complaint over thirty years ago, and my clients were always able to cure the more simple cases referred to by following my suggestions.

With regard to the present insidious disease, the query crops up in different quarters, "Why did you not bring forward your present remedy sooner?" That is a very natural question; but while assured in my own mind that the plague was curable (without destroying anything), it would have been unwise to have made the proposed cure publicly known until after I had first placed it in the hands of a number of practical bee-keepers, who would give it a fair trial and carefully report the results.

This has been done, and I have to thank those who have thus helped on the good cause by their careful attention to details, both in the application of the remedy and in their final reports.

Notwithstanding that the first application of the remedy has been known to prove immediately efficacious, my advice is that periodical applications should be made, even after an apparent cure, so that the malady may be eventually worn out.

Considering the insidious nature of the

disease, although apparently a very simple matter under the treatment I offer, I am compelled to advise all bee-owners to treat every stock, well or ill, with periodical applications of the remedy, as being the only means of the plague reaching a finality.

I should like to point out the absolute necessity of collecting and destroying daily all the sick and crawling bees, as they are the most serious source of infection to other colonies, and of continued infection to remaining members of their own. I have most convincing evidence from various apiaries that the disease has quickly subsided where this very important matter has been carefully attended to; and I have reason to state that had this been done when the malady first appeared in apiaries already destroyed, a large number of stocks would have been saved.

As much ventilation as possible should be given according to the season. Here I must quite agree with Mr. Stapleton. He considers the trouble a foul-air disease; but most diseases are of this nature, and are largely prevented or expelled where a free supply of fresh air can be allowed.

There are now many colonies with stock combs dangerously crowded with pollen and other stores, but with a meagre population, which cannot in any sense be considered fit to go through the winter even without disease being in evidence. In such cases a young queen should have been given last month, and a cake of candy placed over the frames, as the only means of turning the excess of food into a profitable surplus of bees, and at the same time clearing the central spaces of pollen. Syrup-feeding will not bring about the desired result at this season where the combs are already clogged. While advocating the use of candy as a stimulant when breeding is desirable, I am compelled to condemn it utterly as a winter food.

Where syrup-feeding is desirable, as in but few instances this year, it is very necessary that no thin syrup should remain unsealed, as this will attract further moisture during winter, and will be an aggravating cause of dwindling in the spring, should disease be in evidence.

If we look at the opposite extreme, much of the store in hives already abundantly supplied with honey will be very thick, if not granulated, by the early spring; and this will also result in a form of dwindling through the bees searching for water, or, failing to secure it, they will suffer from semi-starvation. In this case an early supply of warm, thin syrup, even as early as February, if the bees are seen to be restless, will be the best method of supplying water.

Contrary to the fears expressed by many of my correspondents, it is the absence and not the presence of fresh thin



symp that may result in ordinary dysentery and dwindling in spring; and now that we may have a secret enemy to deal with, we must carefully re-consider all those items that are most essential for bringing bees through the winter successfully.

Bee-owners should watch for the first symptoms of danger. One palsied bee clinging to the frames or sides of the hive, one crawling helpless bee in front of the hive, should be a warning, but not in any sense a cause of panic. "A stitch in time saves nine" is an old adage that applies with full force in this connection, as in all bee-manipulations.—S. SIMMONS, Heathfield.

### A BEE STORY.

[8249] I always read the reports in the "B.B.J." with interest and profit, but the comments in "Cappings of Comb" (see page 337) on Mr. Byles' contribution in your issue of July 20 causes amusement also. A gentleman who carries away a hive full of bees and presumably the stand, thinking it to be the super, cannot expect to go through life without some unique experiences. From the year — (probably the same as Mr. Byles recalls) comes an account of a musical professor who was carried several hundred yards by the rising of a swarm of bees which had entangled themselves in his flowing hair. Bees capable of doing this can easily be credited with Mr. Byles' story. Our friend must be a very tall man since it would be absurd to expect bees to be alarmed by a fall of less than three feet. The ends of the stings left in correspondent's back may in time begin to grow. We would suggest the use of a safety razor rather than the continual application of sandpaper.—CREDULOUS, Lancaster.

## Queries and Replies.

[8207] *Dealing with Driven Bees.*—On Aug. 4 I brought home the greater of two stocks of bees driven from skeps, with one queen, and I hived them in a new W.B.C. hive with ten full sheets of foundation. I did not feed them until a week ago, when I gave them some candy, which they devoured with avidity. They have a lot of brood, some young bees just out, also a considerable amount of honey, and are working well upon six frames. Ten days ago they had no stores sealed, but on August 26 they had just begun to seal a few cells. I have been advised to continue with candy, as being less messy than syrup. On Saturday I reduced the number of frames to eight,

and should like to know: (1) Is this the proper number upon which to winter the stock? (2) If I continue with candy will the bees store and seal this for winter food? (3) About how much candy would they require, and how much should be given at a time? (4) Upon examining my other stock a week ago I found two queen cells, which I promptly removed. If I had left them would the young queen have been allowed to remain as a virgin until spring? I have not seen a drone for some two weeks now. (5) In the ordinary course of events, which queen comes out with the swarm, the old or the young one?—L.P., Ipswich.

REPLY.—(1) If well-filled with sealed stores eight combs will suffice to winter the bees on. (2) You should not feed with candy now. Good thick syrup as per recipe in "Guide Book" should be given. Candy is an emergency food, and should be given when packing down, as a safeguard against a possible shortage in winter or very early spring, before it is possible to open the hives for examination. (3) The cakes should be given in the 1lb. size. It is difficult to say how much the bees would consume, as much depends upon the weather; but no doubt they would take a large quantity, and it is much more expensive than syrup. (4) It is just possible, but improbable. (5) The old queen leaves with a swarm, young queens with a cast. The right way to have dealt with the driven bees was to have fed them by means of a bottle-feeder right from the time they were hived. Had you done so they would have now plenty of sealed stores and brood, also in all probability they would have built out all the combs.

[8208] *Using the Bee-escape.*—(1) Will you be good enough to tell me, when putting on the bee-escape under two section racks, which is the most convenient way to move them, with least disturbance to the bees? (2) The nights being very chilly, I have put extra covering on the hives, but the days are so hot that possibly it is bad for the bees when the sun is pouring down on them all day. How do you advise in this case? (3) I have a quantity of beautiful sections, all clean, and part of them glazed. Already I have sold a dozen at 12s., and yet the "Daily Mail" is booming section honey at 7d. a section. Surely our pure English honey, well put up, is worth more than this? I should like to know what you consider a fair price retail, free delivery? I have taken a prize this year for section honey, and do not feel inclined to sell it at the price at which foreign honey can be obtained.—M. W. B., Andover.

REPLY.—(1) The best plan is to ease the two section-racks together, and not

separate them. You can then lift them both clear from the hive, putting them cross-corner-wise on the lifts, and not on the ground, to prevent dirt and stones sticking to the bottom. Put the escape in position, and the racks back on top. At this time of the year it is better to carry out the operation in the evening, to avoid robbing. (2) There is no need to alter the wrappings at this time of the year: just let them alone. (3) We quite agree with you that if prepared properly, English honey of good quality will always realize a better price than foreign. The "Daily Mail" has made a mistake in quoting as a retail price that which is paid for honey in bulk by the cwt. Also it evidently does not know the difference between comb and extracted, or clover and heather honey. It is a case of a little knowledge being a dangerous thing. Sections will fetch 1s. each retail, and wholesale from 10s. to 11s. per dozen. No doubt many people would be glad to purchase sections at 7d. each.

[8209] *Late Swarm*.—A swarm issued from one of my stocks on Sept. 5th, and thinking it very unusual, I should like to know if anyone else has experienced a similar occurrence. The old queen remained apparently as long as she could, and on opening the hive a few minutes after the swarming came off, I found a great number of queen cells (about twenty): most of them had hatched, the rest were quite ready to do so. I took three virgins direct off the combs, and believe I have killed every virgin. There were drones present. The combs contained only sealed brood, and no eggs. The swarm, which weighed 4lb. 14oz., I put back in the evening. The stock is headed by an Italian queen, and had swarmed before this season; before doing so it gathered about 68lb. of honey, and has now about enough stores left to winter on. Can you explain this unusual occurrence? (2) On opening a hive containing a 1911 queen, I found the bees not very strong in numbers, but there was a little brood sealed over in worker cells. Do you think that this young queen is not a good one? She is a good length, but rather small, being a hybrid Italian. Would you suggest destroying her and uniting the bees with another lot, or will it be safe to leave her for the winter?

REPLY.—(1) Want of ventilation during hot weather no doubt caused the bees to swarm at an unusual time. (2) From what you say the queen is not as good as she might be, and we should unite as you suggest.

[8210] *Working for Extracted Honey*. In this district we are fortunate in having a crop from both clover and heather, and I shall be glad to

know whether you consider the following system to be the most economical I could adopt in working for extracted honey: In spring the bees are given shallow frame supers containing full sheets of foundation. The clover honey is extracted and empty combs returned for the heather. The combs are then cut out of the frames and pressed, the wax being sent to be re-made into foundation. Old frames are cleaned up, new foundation inserted, and the process repeated each year.—A. B., Leeds.

REPLY.—We do not see that you could follow a better plan.

[8211] *Transferring Bees from Skep*.—In carrying out the above operation when the queen had taken possession of the frame hive, I removed the skep, fully expecting the bees to retain drones until a virgin queen was fertilised, but they destroyed the drones the day after the separation. On examining the hive three days later, I found two queen-cells built, and knowing that the queen could not be fertilised, I sent for a lot of driven bees with a young queen, preparing the hive in the meantime for uniting by fixing a dummy in the centre of the body box, partly made of perforated zinc, also making the entrances at opposite corners. The bees arrived late owing to the strike, and after three days in separate compartments they united peaceably on dusting with a little flour. Forgetting to look for the hatched queen, I left them till daylight, it being too dark when I got them safely united. I should therefore like to know: Will the bees destroy the virgin, or leave her till the rival queens decide matters for themselves? The bees seem to have settled down, and are working all right: it is now three days since they were united.—J. T. HESLOR.

REPLY.—You do not make the matter quite clear. We judge from what you say that the skep was taken off and the queen put in it to make a separate stock, otherwise why was it necessary to have a queen reared in frame hive? You should have let the old queen remain; also had skep driven clear of bees, which should have been run in at the entrance to join those already in frame-hive to make a good stock. We do not think the bees will destroy the virgin, but the other, and no doubt you will find in the spring a drone-breeding queen. Better make sure now and see if worker brood is hatching; if not, find and destroy the queen and introduce a fertile one without delay.

[8212] *Transferring to New Hive in Autumn*.—I have bought a stock of bees on frames which have not been fitted with foundation, and there are also no metal ends on them. Consequently the bees have

built combs in all shapes and braced them together. I want to transfer them to some new frames, and have taken another hive off the floor-board and placed it on the top of the old one. It contains frames with full sheets of foundation and two frames of honey. Would it be possible to drive them up in the ordinary way later on, when the brood is hatched out?—**J. BENINGTON, Peakirk.**

REPLY.—It is too late to deal with the bees this season. Let them stay where they are until next spring, then work them down as instructed (in the case of skeps) in "Guide Book."

[8213] *Peculiar Noise in Hive.*—I shall be pleased if you will explain through the BRITISH BEE JOURNAL the cause of a peculiar muttering sound which has been going on in one of my hives for some days. I can hear it distinctly in the house, ten yards away. I am only a beginner with this delightful hobby, and also a new reader of your valuable journal.—**E. HARPER, Sedbergh.**

REPLY.—It may be that in manipulating you have imprisoned some of the bees under the quilt, or more probably it is caused by want of ventilation. When this is the case, bees will often make an intermittent noise such as you describe.

**WEATHER REPORT.**

**BARNWOOD, GLOUCESTER.**

August, 1911.

Rainfall, 1.49 in.	Mean temperature
Below average, .84 in.	for month, 66.7; 4.7
Heaviest fall, .42 in.	above average.
on 27th.	Relative humidity,
Total to date, 9.82 in.,	or percentage of
as compared with	moisture in the air
20.79 in. for the cor-	at 9 a.m., 65.
responding period	Number of days with
of last year.	sky completely
Mean maximum tem-	overcast at 9 a.m.,
perature, 77.2;	5; ditto cloudless,
7.2 degrees above	7.
average.	Percentage of cloud,
Mean minimum tem-	36.
perature, 56.3; 2.3	Percentage of wind
above average.	force, 20.
Warmest day, 9th,	Prevailing directions,
93.2	E. & S.W.
Coldest night, 30th,	
41.	

F. H. Fowler (F. R. Met. Soc.).

**Bee Shows to Come.**

**September 14, at Castle-Douglas.**—Annual Show of South of Scotland Bee-keepers Association. Five open classes; Three 1-lb. jars extracted, 20s., 10s., and 5s.; three sections, ditto (Entry

2s.). 1lb. jar, also one section, 5s., 3s., and 2s. (Entry free, and exhibits retained unless otherwise agreed upon). Beeswax, 5s., 3s., and 2s. (Entry 6d.). Fourteen classes for members. **Entries closed.**

**September 16 to 23, at the Agricultural Hall, London.**—Honey Show in connection with the 19th Annual Exhibition and Market of the Grocery and Kindred Trades. Liberal prizes. Open to all British Bee-keepers. Schedules from H. S. Rogers, Secretary, Exhibition Offices, Palmerston House, Old Broad Street, London, E.C.

**September 26, at Korminan Hall, North End, Croydon.**—Exclusive Show of Honey, Wax, Hives, Bees, &c. Increased prizes. Six Open Classes. Judge, Mr. W. Herrod, F.E.S. Schedules from A. Wakerell, 21, Mansfield Road, Croydon. **Entries close September 16.**

**September 27, at Altrincham.**—Honey Show, in connection with the Altrincham Agricultural Show, the largest one-day show in the Kingdom. Classes open to United Kingdom. Classes for Trophy of Honey, for Best Hive, Observatory Hive with Bees and Queen, twelve Jars of Extracted Honey. Classes open to County of Chester, for Run and Section Honey, Wax, &c. Special Classes for Cottagers, and Special Classes for Society's District. Several Special Jubilee prizes. **Entries closed.**

**October 3 to 6, at the Agricultural Hall, London.**—Show of Honey and Bee Produce in connection with the British Dairy Farmers' Association. Numerous and liberal prizes for Honey, &c. **Entries closed.**

**Notices to Correspondents.**

*Letters or queries asking for addresses of manufacturers or correspondents, or where appliances can be purchased, or replies giving such information, can only be inserted as advertisements. The space devoted to letters, queries, and replies is meant for the general good of bee-keepers, and not for advertisements. We wish our correspondents to bear in mind that, as it is necessary for us to go to press in advance of the date of issue, queries cannot always be replied to in the issue immediately following the receipt of their communications.*

**DRONE (London).**—*Period of Honey Yield.*—If the season is a favourable one, you would most probably get a return in May from the cherry orchards at Faversham. In all three places you mention the honey flow commences about June in a normal season.

**SCOT.**—*Dealing with Diseased Stock.*—You must confine them for forty-eight hours without food. When returned to a clean hive, feed them with medicated syrup.

**W. M. C. (Burgess Hill).**—*Wintering.*—1. You should rear a piece of glass in front of the entrance. 2. It is not advisable to try fewer than five frames.

**H. R. H. (Stoke Ferry).**—*Bee Smoker.*—Any of the firms advertising in the JOURNAL will supply you with a "Bingham" smoker.

**AMATEUR (Worsley).**—*Uncapping Partly-built Combs.*—Use a small knife, by means of which you can easily uncap the cells. It would not be advisable to allow the honey to remain until next

season, as it will granulate. After extracting, give the combs back to the bees to clean up.

W. G. (Briton Ferry).—*Uniting Bees*.—The best plan to adopt will be to move 4, 5, 6, and 7 one yard per day, when the bees are flying, to the sides of Nos. 1, 2, and 3. When they have been standing close together for a couple of days, you can unite, as the bees will remain.

#### Honey Samples.

J. C. (Newton).—All the samples are of good quality, No. 1 being a light-coloured honey of good flavour and aroma, but not dense enough to constitute a perfect sample; Nos. 2 and 4 slightly darker in colour, but of excellent flavour, and better in consistency than No. 1.; No. 3, a light-coloured clover honey with similar characteristics as No. 1.; No. 5, a medium-coloured honey from mixed sources. It is granulated, but the flavour is very good.

X. Y. Z. (Birmingham).—An intensely sweet sample with a slight trace of lime flavour about it, but the general characteristics more resemble fruit-syrup than honey. It is cloudy in appearance, of a pinkish colour, and very dense.

POSTCARD (Hereford).—A rather thin, dark honey of fairly good flavour. Having been stored in old combs, you could not expect it to be of first-class flavour and aroma. It has been gathered from mixed sources, chiefly from fruit-blossoms. More careful straining would improve it. The honey this season is of excellent quality as a rule, and very little honey-dew can be heard of. Your sample does not contain any.

MARKET (Shrewsbury).—A very good honey, gathered partly from limes.

W. D. (Plumstead).—Both samples are of good colour, No. 1 being best in flavour, it having been chiefly obtained from limes. No. 2 is of inferior quality, lacking flavour and density.

X. Y. Z. (Wilts).—Honey has been gathered from mixed sources, including clover. It is, however, of poor flavour, lacking in density, and shows signs of granulation. We should not call it a good table honey.

W. H. C. (Worcester).—Dark honey containing an admixture from ragwort, which has spoiled the flavour. We would not consider it good enough for exhibition purposes. Though the density is good, the flavour leaves much to be desired.

T. T. W. (Gloucester). A dark coloured honey of good flavour and density. From mixed sources with slight trace of lime flavour. It is good enough to exhibit in dark honey class, but of course its chance of securing a prize depends upon what is brought into competition with it.

### Special Prepaid Advertisements.

Two Words One Penny, minimum. Sixpence.

Orders for three or more consecutive insertions entitle advertisers to one insertion in "The Beekeepers' Record" free of charge.

Trade advertisements of Bees, Honey, Queens, and Bee goods are not admissible at above rate, but will be inserted at 1d. per word as "Business" Announcements, immediately under the Private Advertisements. Advertisements of Hive-manufacturers can only be inserted at a minimum charge of 3s. per  $\frac{1}{2}$  in., or 5s. per inch.

### PRIVATE ADVERTISEMENTS.

**B**EST PURE EXTRACTED HONEY, 28lb. tins, 14s., lever tins free.—BARFIELD, Broom, Biggleswade.

**F**OR SALE, EXTRACTOR (Lee's guinea), good condition; also combined Ripener and Strainer, 16s. the lot.—WAKERELL, 21, Mansfield-road, Croydon.

**M**R. EASTON, of Bankwood, begs to inform the numerous Bee-keepers who replied to his advertisement last week that most of the Appliances have been sold. The remainder and the 12 Stocks of Bees will be included in an auction sale to be held at Bankwood, Charing, Kent, on Wednesday, 20th September. Catalogues from Denyer and Collins, Tonbridge. m 45

**F**OR SALE, several 8, 9, 10 Comb Colonies British Bees, no Hives, 30s. each. C. J. ASHWORTH, bee expert, Heytesbury. m 53

**W**ANTED, Extractor, perfect order and cheap.—Particulars to HANSFORD, 68, Brantfield-road, Blackburn. m 55

**H**ONEY, choice clover, well ripened, 60s. cwt., good medium blend, 56s.; sample, 3d.—THOS. E. ATKINS, Leire, Lutterworth. m 57

**V**OLUMES "B.B.J.", 1 to 13, bound, some very rare, £3; also large quantity of other Bee Books; list on application.—ABBOTT, Merchants' Quay, Dublin.

**F**OR SALE, 3-h.p. Lloyd Motor Cycle, in good condition, Palmer's tyres; price £6 10s.; also 3 $\frac{1}{2}$ -h.p. Lincoln Elk, just been overhauled, very fast and reliable; new tyres; a bargain, £11 10s.—H. DRAYTON, New Bottingbroke, near Boston. m 6

**H**ONEY, good colour, flavour and well ripened, 58s. per cwt. on rail; tins free; 1lb. sample six stamps.—J. IRELAND, Vernham, Hungerford, Berks. 1 96

**F**OR SALE, 10 $\frac{1}{2}$  ACRES OF LAND, well built bungalow, good outbuildings, fruit trees, &c.—JOHNSON, Sheepdrove, Lambourn, Berks. m 17

**O**RIGINAL pattern Yorkshire Heather Honey Press, new, fully tinned; price and particulars.—HOOD, Whitby. m 11

**T**O LARGE BUYERS.—9cwt. good light-coloured Honey, and 16 doz. Sections from own Bees, for sale.—DAVID HANCOX, Deddington, Oxon. m 28

**O**RIGINAL AND BEST RYMER HEATHER HONEY PRESS for sale.—THOS. HOOD, Whitby. m 25

**H**ONEY, finest Essex, 14s. per 28lb. tin, carefully packed, free on rail; sample, 2d.—J. PEARCE, 14 Kent-road, Grays, Essex. m 82

**W**ANTED, Series of Micro Slides illustrative of the Anatomy of the Honey Bee.—BARBOUR, Ramsey, Man. m 67

**50** 1lb. SECTIONS HONEY, 35s., cash with order.—H. TURK, 101, Rivers Corner, Sturminster Newton, Dorset.

**F**OR SALE, PURE ENGLISH HONEY, in 56lb. tins; sample 2d.—LAW, Cuckoo, Ashwell, Baldock, Herts. m 71

**B**RAND new W.B.C. Abbott Bros.' Hive, complete with Sections in patent Frames, cost 27s. 6d.; also 4 Lee's W.B.C. Hives, good condition. Offers wanted.—FRY, Lucerne, Horley, Surrey. m 74

## Editorial, Notices, &c.

### NOSEMA DISEASE AND DYSENTERY.

At the conference of the German, Austrian, and Hungarian Bee-keepers, held at Constance, on August 8th, Dr. Walter Hein, of the Biological Experimental Station, Munich, read a paper regarding this disease, which has of late occupied a great deal of attention on the Continent of Europe as well as in this country, owing to its close resemblance to what has been called "Isle of Wight" disease. Although Dr. Hein does not entirely agree with Dr. Zander, he corroborates his findings, and says that we are indebted to him for his investigations, and for giving the name of *Nosema apis* to the parasite, but points out that the discovery is not quite new, for so far back as the middle of the last century Dönhoff and Leuckart had both noticed it, but had supposed it to be of fungoid origin.

The parasites, as such, live a certain time in the bees in which they are found, and at a later period turn to spores. In order that these may develop into living parasites, they must be excreted or escape from a dead bee, and then conveyed to a living one. The *nosema* parasites live in the cellular lining of the intestines, and then turn into spores, which are evacuated together with the detached cells, and are then in a fit condition to infect other bees. When it is considered that, introduced into the stomach of a bee, a single spore can in a very short time multiply a hundred- or even a thousand-fold, it is not surprising that when the intestine, or more especially the chyle-stomach, is examined under a microscope, thousands of these spores are found to be present.

Dr. Hein refers to Dr. Dönhoff, who in 1857 experimented with bees which he, as well as Dr. Leuckart, thought to be affected with a fungoid disease. That they did not recognise the animal nature of the parasite is not surprising, for at that time unicellular animals, such as these protozoa, were quite unknown, and it is only the researches of the last decade that have enabled scientists to class these parasites amongst animals, where we now find them. Dönhoff found that the chyle-stomach was the chief point of attack by the parasite, and demonstrated its infective nature by feeding bees. He also showed the extent to which the disease existed. Of 36 colonies in Hanover, four were diseased; of 260 in Württemberg, four were diseased; of 25 in Westphalia, 14 were found to be affected, and Dr. Dzierzon had at that time 60 colonies affected by the parasite. He attributed the spreading of the disease to the use of

moveable comb hives, by the introduction of combs from diseased to healthy colonies. Leuckart also found the "small oval bodies" which "showed no cellulose reaction," in the chyle-stomach, as did also Leydig in 1863. There is, therefore, little doubt but that these "small oval bodies" were none other than what, according to Dr. Zander, we now recognise as *nosema* spores, in consequence of a better understanding resulting from the use of more perfected instruments and better methods of research. As an instance in point we can mention that Dr. Maassen has been able to produce over 100 photo-micrographs which show the whole life history of *nosema apis*, so that now we know all about this protozoon.

Dr. Hein says that bee-keepers are interested in all practical questions that concern their industry; they desire to have strong colonies which will develop at the right time, and yield a good return. It is therefore important for them to know: (1) if this parasite is the direct cause of dysentery, as Dr. Zander thinks; (2) how to recognise this *nosema* disease; and (3), what should be done to prevent the spreading of the infection.

With regard to the first, Dr. Hein admits with Zander, Maassen, and others that bees containing *nosema* are diseased, and that they may suffer from dysentery, but points out that a large number of colonies, the bees of which were found to contain the protozoon, passed the winter very well and showed no signs of dysentery or May-pest, although he found 90 to 95 per cent. of the bees the intestines of which were completely filled with spores. Dr. Maassen noticed the same thing in Brandenburg, where in certain hives every bee contained the parasite, although these colonies showed no signs of disease. He therefore thinks that *nosema* is not as dangerous as Dr. Zander supposes it to be, and very much doubts if it really has anything to do with causing dysentery. Experiments have shown, and the observations have been confirmed, that affected colonies can develop in a normal manner, and that the parasite may be present in bees for a long time without causing trouble, so long as they are healthy in other respects. If, however, the conditions are such as to lower the vitality of the bees—for instance, bad wintering, long confinement to the hive, queenlessness or other deteriorating cause, such colonies are very susceptible, and even where *nosema* is not present, may easily develop dysentery. For this reason, Dr. Hein thinks that *nosema* is not the primary cause of dysentery, and points out that recent investigations of Dr. Maassen lead him to think that probably the malady is caused by certain bacteria in relation with the pollen consumed by the bees.

With regard to the second question, Dr. Hein does not agree with Dr. Zander that it is always possible for the bee-keeper to detect badly infected bees, even without a microscope, by the white appearance of the chyle-stomach. Although he has found it white in thousands of cases, this colour may be also due to other causes, and the only sure method is to use the microscope, by means of which it can only be determined with certainty whether the bees contain protozoa or the spores. To arrive at a more certain decision, bees intended for examination should be shut up in a box for 8, 10 or 14 days, which would give the parasites time to turn into spores, and any bees at first free from them would by that time have become infected. Dr. Hein says he has very seldom found colonies entirely free from *nosema*, which is much more prevalent than is supposed. Of 124 colonies examined, in 97 *nosema* spores were detected in May and June. Several of these colonies examined in July were found to be quite free of the parasites. This showed that young bees resisted the protozoon, and therefore were free from it, and that it is the old bees that carry *nosema* with them, and are the means of spreading it. In summer, if there are a large number of young bees, the disease seems to decrease, but in spring and autumn, when old bees predominate, the disease re-appears.

Lastly, with regard to the prevention of the disease from spreading, Dr. Hein deprecates the idea of destroying every affected colony, and does not think transferring the bees to another hive much use, as thousands of affected bees would go with them, to continue the propagation of the disease. Of course, he advises that all dead bees should be removed, and no reasonable bee-keeper would tolerate such at the entrance, but would, from hygienic considerations, remove them. His conclusion is that the bees will be able to resist the disease if they are well wintered on good honey, or syrup containing a little pollen, and kept quiet, as well as housed in well-made sanitary hives. Under such conditions, they would remain healthy, even with the parasite in them.

Owing to the importance of the subject, we have given a digest of the above paper, for an advance proof of which we are indebted to Dr. Hein. We will only add that although in some cases, and under certain conditions, the parasite may be harmless, it has recently been found as the infective agent in connection with "Isle of Wight" disease, and, knowing the havoc this has caused in this country—where it has assumed an epidemic character—we therefore advise taking drastic measures to prevent it from spreading.

## THE GROCERY AND ALLIED TRADES' EXHIBITION.

The Nineteenth International Exhibition of the Grocery and Allied Trades was opened on Saturday last, and will continue until Saturday, the 23rd inst.

The good honey season has enabled bee-keepers and traders to make a splendid show of honey, and there is no doubt that "The Grocers'" has now become the honey show par excellence of the country, the display this year being a record one, both as regards quantity and quality. The honey department is just as well-arranged and compact as was the case last year, and the exhibits make an imposing display. All the classes are good, and little comment is needed, except in the case of the light extracted class, which contains seventy-five exhibits, and forms without doubt, the largest class of honey that has ever been staged in this country. The length of staging it occupies makes a show in itself. The medium class is well filled with forty-seven exhibits, and here again a record of its kind has been created.

For the rest we can only advise all interested to, if possible, make a point of seeing the show for themselves. Messrs. Jas. Lee and Son and E. H. Taylor have each staged an excellent collection of bee appliances in bays in the gallery.

Mr. E. Walker judged the exhibits, and made the following awards:—

*Outfit for a Beginner in Bee-keeping (four entries).*—1st, Jas. Lee and Son, Highbury, N.; 2nd, E. H. Taylor, Welwyn.

*Display of Honey and Honey Products shown in Suitably Attractive Form for a Tradesman's Window (six entries).*—1st, and B.B.K.A. silver medal, A. S. Dell, Leigh, Lancs.; 2nd, R. H. Baynes, Cambridge; 3rd, J. Pearman, Derby; 4th, C. W. Dyer, Compton, Newbury; v.h.c., Jas. Lee and Son; c., A. G. Wiggins, Wembley.

*Twelve 1-lb. Sections (twenty-nine entries).*—1st, and B.B.K.A. bronze medal, J. M. Balmбра, Alnwick; 2nd, T. J. Hillier, Andover; 3rd, J. G. Nicholson, Langwathby, Cumberland; 4th, Jas. Lee and Son; 5th, A. Hiscock, Loddington, Kettering; v.h.c., A. J. Marriott, Market Harborough; J. Spiller, Taunton; R. H. Baynes; J. M. Best, St. Austell, Cornwall; R. Allen, Tusmore, Bicester; C. W. Dyer; h.c., T. Rees, Llynon, Cwawe, Lampeter; c., A. G. Wiggins; J. Fairall, Hellingly, Sussex.

*Twelve 1-lb. Heather Sections (ten entries).*—1st, J. M. Balmбра; 2nd, W. Waddington, Boro-bridge, Yorks; 3rd, T. Marshall, Sutton-on-Trent, Newark; v.h.c., J. Pearman; T. Walker, Hawkshead, Lancs.

*Three Shallow Frames (eight entries).*—1st, Jas. Lee and Son; 2nd, J. Herrod,

Sutton-on-Trent, Newark; 3rd, G. Hunt, Newark; v.h.c., A. Willmott, Stanstead Abbots, Herts; c., J. Chandler, Godmanchester.

*Twelve 1-lb. Jars Light-coloured Extracted Honey (seventy-five entries).*—1st, and B.B.K.A. Certificate, R. Allen; 2nd, S. G. S. Leigh, Boughton, Hants; 3rd, E. C. R. White, Newton Toney, Salisbury; 4th, A. Young, Chatham; 5th, W. Norris, Bradford-on-Avon; v.h.c., T. J. Hillier; C. E. Austin, Slinfold, Horsham; B. Blackburne, Minster, Rams-gate, C. E. Billson, Cranford, Kettering; C. H. Rivers, Southfleet; W. Patchett, Cabourne, Caistor, Lincs.; T. Rees; M. J. Lamboll, Chiddingfold, Surrey; J. Prior, Hildon, near Stockbridge; J. Price, Old Hill, Staffs; R. Morgan, Cowbridge, Glam.; J. Ward, Hesketh Bank, near Preston; h.c., C. Robinson, Grateley, Andover; F. Allen, Gt. Bowden, Market Harborough; E. Humphrey, Glamorgan; c., A. C. Jackson, Elvedon, Thetford; G. S. Jesson, Hose, Melton Mowbray; E. Brunette, Langdon Mill, Essex; H. Dilworth, Kibworth, Leicester; W. G. Wells, St. Mary, Blandford; H. W. Saunders, Thetford; A. Canning, Wickham Heath, Newbury; W. G. Halford, West Wrattling Lodge, Cambs.; S. Sanderson, West Wrattling, Cambs.; Dr. T. S. Elliot, Southwell, Notts; J. Berry, Llanrwst, N. Wales; H. Ward, Bath Street, Leamington; P. M. Ralph, Settle.

*Twelve 1-lb. Jars Medium Extracted Honey (forty-seven entries).*—1st, Mrs. F. Harris, High Ferry, Sibsey, Boston; 2nd, T. Manfield, Newark; 3rd, A. Young; 4th, A. S. Dell; v.h.c., P. Wells, Uffington, Stamford; J. W. Bockock, Stony Stratford; E. G. R. White; Dr. T. S. Elliot; R. H. Baynes; T. Rees; J. Chandler; h.c., G. W. Judge, Hawley, Dartford; H. Dilworth; T. Alun Jones, Halkyn, Flint; W. Woolley, Evesham; J. M. Best; c., J. Berry; G. Marshall, Norwell, Newark; H. Holland, Sutton Bridge, Lincs.

*Twelve 1-lb. Jars Dark Extracted Honey (thirteen entries).*—1st, G. W. Judge; 2nd, J. Herrod; 3rd, G. Marshall; v.h.c., E. C. R. White.

*Twelve 1-lb. Jars Heather Honey (twelve entries).*—1st, J. Pearman; 2nd, A. Young; 3rd, T. Marshall; v.h.c., W. Bowler, Chesterfield; E. W. Spink, Easingwold; T. Hood, Pickering; h.c., H. Waddington; c., T. Walker, Hawkshead, North Lancs.

*Twelve 1-lb. Jars Heather-blend Honey (seventeen entries).*—1st, T. Marshall; 2nd, J. Pearman; 3rd, A. G. Pugh, Beeston, Notts; 4th, J. H. W. Fishwick, Chaltburn, near Clitheroe; v.h.c., T. Walker; Dr. T. S. Elliot; W. Sproston, Shugborough, Staffs; h.c., H. Wadding-

ton; J. Berry; A. G. Pugh; c., A. J. Brightwell.

*Twelve 1-lb. Jars Granulated Honey (twelve entries).*—1st, R. Allen; 2nd, G. Hunt; 3rd, H. Holland; 4th, E. W. Spink; v.h.c., J. Garratt, Willoughby Waterleys, near Leicester; h.c., J. Woods.

*Beeswax in Cakes (quality of wax, form of cakes, and package suitable for retail counter trade) (eight entries).*—1st, J. Pearman; 2nd, J. Berry; 3rd, Mrs. Harris; 4th, H. W. Saunders; v.h.c., R. H. Baynes.

*Beeswax (judged for quality of wax only) (sixteen entries).*—1st, Mrs. Harris; 2nd, A. Hiscock, Kettering; 3rd, W. Patchett; 4th, T. Marshall; v.h.c., J. Pearman; h.c., C. W. Dyer; c., Jas. Lee and Son.

#### HONEY SELLING CLASSES.

*Extracted Honey in Bulk.*—Certificates, D. Jones, Llanarth, Cardigan; L. W. Matthews, Chipping Norton, Oxon; A. Harris, Woburn Sands, Beds.

*Extracted Honey in 1-lb. Jars.*—Certificates, A. G. Pugh; D. Jones; W. S. Halford; Mrs. Williams, Pwllheli; H. Briddon, Ashbourne, Derbyshire; E. Brunette; A. Harris; J. Rowlands, Pwllheli.

*1-lb. Section of Comb Honey.*—Certificate, A. Harris.

#### HELPFUL HINTS FOR NOVICES.

By W. Herrod.

*Preparing for Winter.*—So far as the human element is concerned, much depends upon the attention given now to the bees for the reaping of next year's harvest. Like gardeners, bee-keepers must look a long way ahead if they are to succeed. A great many so-called bee-keepers are very keen in the early spring and summer, when honey is coming in, but with the removal of the honey they lose further interest for that season. The first preparation for winter should commence as soon as the supers are removed. This work should be carried out methodically; all should be taken off, and the bees allowed to stand without manipulation of any kind for about a week: this will give them time to settle down, so avoiding excitement and robbing.

After they have settled down a thorough examination of each lot should be carried out, and notes made as to condition of stores and number of bees, also the manner in which the queen is carrying out her work.

During the manipulation careful attention should be paid to the combs, and any containing an excessive amount of drone-cells, those which are getting old and the size of the cells diminishing, or

pollen-clogged combs should be placed in the outside position in the brood-chamber; they will be emptied of food by the bees, so that in the spring they can be taken out and replaced by foundation without wasting food. Our consideration should be given first of all to the queen, and if she is old or deficient in any way she should be replaced. Re-queening is generally left until the spring; this is a mistake for three reasons: first, if it is necessary to purchase a queen they are more expensive then than in the autumn; secondly, it gives an opportunity to judge as to the quality of the new queen; and thirdly, to obtain the best results a young queen should be in the hive in January when breeding first commences. If re-queening is not done in the autumn, it will be about April before the new mother can be introduced, and three months of valuable time will have been wasted. In introducing queens the old one should be removed at least twelve hours before her successor is placed in the hive. A cage should always be used. Personally, I fail to see where the advantage of direct introduction comes in. There may be a slight saving in time, but this is out-balanced by the risk of the queen being balled. My experience is that direct introduction works all right with queens of no particular value so that it is immaterial if they are killed or not, but with valuable ones they are invariably thrown out dead next morning.

Cages are not expensive to buy, and if the "Howard-Benton" is used the introduction is automatic, and it is not necessary to handle a purchased queen at all. I shall have more to say about the introduction of queens later on, so will defer any other remarks for a time.

Our attention should be devoted next to the production of plenty of young bees to populate the hive for the winter. The old maxim that "the best material for winter packing is bees," is an excellent one; but those bees must be young ones, so that they will live well into the spring. The more bees we have the less food is consumed. This seems paradoxical, but it is quite true, as a quantity of bees can maintain the temperature on a very small amount of food on account of their number. There is greater body heat, and when once raised it does not escape so quickly from a large cluster as from a small one. With small numbers more fuel (food) is burnt, as heat is generated by combustion of food in the body of the bee combined with oxygen, and also by mechanical movements of various parts of the body, as for instance respiration. If there is a super-abundance of food in the hive a couple of combs should be taken out and extracted to provide room

for the queen to lay. Then gentle stimulation (say through one hole of the ordinary bottle-feeder) should be given. The syrup should be of thick consistency as per "Guide Book" recipe, so that any stored will be sealed over. If there is an absence of stores then up to three holes may be opened in the feeder. The food should be given warm, and in the evening, care being taken that none is spilt to cause robbing, and for the same reason the entrances to all the hives should be closed to half-an-inch. The feeding-bottle should be well wrapped up to keep it warm. If there is disease in the neighbourhood the syrup should also be medicated. Autumn stimulation is deprecated by some bee-keepers on the ground that the energy of the bees is taxed in brood-rearing, therefore they do not live so long. Be that as it may, I have always found those stocks in which autumn stimulation has been carried out come out best in the spring, and do the most work.

*(To be continued.)*

---

#### HONEY IMPORTS.

The value of honey imported into the United Kingdom during the month of August, 1911, was £7371.—From a return furnished to the BRITISH BEE JOURNAL by the Statistical Office, H.M. Customs.

---

## Correspondence.

---

*The Editors do not hold themselves responsible for the opinions expressed by correspondents. No notice will be taken of anonymous communications, and correspondents are requested to write on one side of the paper only and give their real names and addresses, not necessarily for publication, but as a guarantee of good faith. Illustrations should be drawn on separate pieces of paper.*

---

#### NOTES BY THE WAY.

[8250] Preparing the stocks for winter should now engage all our attention in the apiary. No humane bee-keeper will neglect the well-being of the erstwhile busy labourers who from early morn to dewy eve the whole week through have toiled for his benefit. The condition of the supers, every section filled and sealed to the outside, points to the fact that every inmate of the hive has been animated by the same strenuous desire to outvie the next colony in the amount of stores it could provide for the coming winter. Now, having secured our share—aye, and a big share too—don't let us neglect attending at once to their re-



quirements but see to it that every stock goes into winter quarters in the best possible condition, housed in a dry hive, and fixed up to withstand the gales of wind and the wet.

Finding a market for honey seems to be a difficulty with many bee-keepers. I should advise every country bee-keeper, with only two or three hives, to endeavour to create a local market for his honey, but no one should sell retail at the same rate that they would sell to the grocer or dairy man. A man cannot keep a supply of honey on his counter or in his window and sell it at a 1d. per lb. profit; if you supply the shopkeeper you should sell retail at the same price that he charges. All honey producers should grade their sections. Sainfoin and white clover honey is worth 2s. per dozen more than that from the limes, and all sections intended for shops should be glazed or put into boxes to protect the contents from dust, wasps, and flies. Finest sections are being sold in London at 1s. 2d. and 1s. 3d. glazed, and in provincial towns at 1s. each, but these prices are for extra selected quality.

Those who have large apiaries are, generally speaking, quite able to take care of themselves and know where to dispose of the bulk of their produce. There are, also, the pages of our bee papers, with enquiries for honey appearing every week; here is an outlet for a considerable quantity. The small bee-keeper when he gets an order from a big firm should send the honey of as uniform quality as possible, and repeat orders will come in another season.

The charge for advertising in the **BRITISH BEE JOURNAL** is very low, and the journal has a wide circulation, being well known to most of the commercial houses who handle honey, as well as to the bee-keeping fraternity. If your honey is extracted, get a few small bottles; sample tubes answer very nicely. These can be sent by post for a penny stamp, or if preferred you can charge these samples at twopence each without loss. Sample sections should be sent by rail, carriage forward; they are too fragile for parcel post and the chances are that they will get smashed in transit if sent in this way. If the sample secures you an order, you must use your discretion whether to charge for it or not. I do not think many buyers would object to a small charge if a sample section is sent on request, carriage paid. It should be charged at the same price as others ordered if one small parcel of one or two dozen are taken, but if it is the means of selling a gross or more no charge would be expected.—**W. WOODLEY, Beedon, Newbury.**

#### SUGAR FEEDING AND DISEASE.

[8251] An article appeared in the "B.B.J." August 3, page 305, signed "A Roman Bee-keeper," on sugar feeding and disease, on which subject I have a few remarks to make, and should be much obliged if you would kindly find room in the "B.B.J." for them. He maintains that it is possible that the prevalence of disease may be attributed to this method of feeding bees. May I say that I entirely disagree with him. He also advises feeding with honey, which I think is one of the most dangerous things a bee-keeper can do. Let us suppose a quantity of honey is taken from a perfectly healthy colony. Is it not quite possible that, despite the healthiness of that colony, it may have, and in all probability has disease spores in it? We are told by medical men that persons who are quite healthy have often in their systems germs of diphtheria and other infectious micro-organic diseases, but these are unable to harm the person in whose body they are, unless through some other cause his vitality becomes lowered and the conditions become favourable for the development and reproduction of the disease germs. Now, it seems to me quite possible that honey such as I have described above may, although harmless to the stock it comes from (and therefore considered free of germs by the bee-keeper), when fed to a weak stock, be quite deadly. It is, as a rule, the weak stocks that require to be fed most, and the strong ones that nearly always provide the food. Therefore, I say it would be wise for all bee-keepers to be careful. I had a very bad outbreak of foul brood in my apiary in 1908, and I am almost certain that it was caused in this way. I bought a fine strong stock of bees in the spring, apparently quite healthy; there was not a diseased cell, yet on giving a comb from it to a weak stock which was in a bad way, but which had quite healthy brood, this weak stock at once developed the disease, and it went over the apiary like wildfire until I had fourteen stocks affected. Another time, if you think it would interest your readers to hear of my experience, I will give a full account of how I cured them. I have twenty-three hives now, and not a trace of disease among them all. I have kept the sharpest watch, and should not easily pass over a diseased cell after my experience.

As to feeding with sugar, I really cannot see why it should not be quite as good a food as honey, if the syrup is made from really good sugar. In fact, I should say it would be better than the thin honey from unsealed combs, etc., which would very likely be fermenting when fed, especially in the hands of a beginner. I understand that honey, when freshly

gathered, is merely a form of sugar, which is afterwards modified by the bees. Also, I think the bees modify the sugar in much the same way, for sugar syrup sealed in the comb is a very different thing from the syrup when fed to the bees. One other advantage is that sugar syrup is so much cheaper than honey that I maintain it is a great waste of money to feed good honey to bees. Of course, everything fed to bees should be medicated, which ensures its being safe if sugar, and tends greatly to that end with honey. Now I should like to ask the Editor, since he seems to think it likely that diseases such as dysentery may be caused by feeding syrup to bees, which, in his opinion, is most likely to cause dysentery: plenty of good sugar syrup sealed in the combs, or a small quantity of honey only partially sealed? this latter being often the case with stocks requiring feeding. In conclusion I wish to say that anything written that might in any way tend to discourage bee-keepers from feeding their bees is detrimental to bee-keeping in the country. I say all encouragement should be given by the bee journals to bee-keepers to see that their bees have either an ample supply of good, well-sealed honey or else plenty of good sugar-syrup, medicated and well sealed down. A stock of bees packed down with a store of well-sealed syrup, provided they are not diseased and have a young queen, will almost always come out well. At least, that is my experience.

I should be glad, in case you think this worth printing, if you would pass a few remarks on it. Wishing your paper every prosperity.—R. B. MANLY, Potcote, Towcester.

[It is quite understandable that "A Roman Bee-keeper" should prefer feeding with honey, seeing that sugar in Italy is very much more expensive. Feeding indiscriminately with honey would certainly be injurious, and many outbreaks of foul brood have been attributed to such a proceeding, but there is no doubt that the honey stored by the bees in their combs and properly ripened is a more complete food than sugar syrup. It has been proved that cane sugar syrup when stored by bees is only partially converted by them, and that a large proportion of it remains as cane sugar. The cane sugar in nectar is taken in minute quantities, and is therefore more readily converted into the grape sugar of honey. It thus becomes a more complete food. We have no doubt that pure cane sugar syrup is the best substitute for honey where bees have not stored enough of the latter, and, in any case, it is safer and better than fermenting thin honey from unsealed combs. With regard to dysentery, good sugar syrup sealed in

combs would certainly be preferable to unripe honey, and any such in unsealed cells is generally recommended to be removed. We have no hesitation in saying that any colonies deficient in sealed stores should be liberally fed with medicated cane sugar syrup.—Ed.]

#### WHERE IS THE ENGLISH BEE?

[8252] I know a bee-keeper who commenced the season with five Carniolan and five native stocks. The Carniolans swarmed in May and the English in June. All went well until the progeny of the first cross showed an excessive inclination to sting. When preparing to cart the hives to the moors, they stung the two horses and chased them over several fields; they attacked the driver and the boy who accompanied him, and followed the bee-keeper inside the cottage where he had taken refuge. Is it not time we seriously made a survey in regard to the introduction of foreign races? It is a matter that affects all bee-keepers. The five Carniolan stocks be it noted, swarmed in May, and it seems clear that the district for miles around would be to no little extent dominated by Carniolan drones. A few days ago I made a scrutiny of the bees at the entrances of a row of forty hives on the moors from various apiaries, and, though showing some Italian blood, it appeared to me that the Carniolan strain was more in evidence than the English. The temper of some of these bees was what an old bee man described as "hot:" and a few days previously they had attacked a flock of geese, killed the gander, and then proceeded to attack a cow and a calf, also a tethered goat. I have no doubt that the Italian strain is bred out quickly by the English bee, but owing to the excessive and early swarming of the Carniolan bees they may eventually dominate and supersede the native strain. There is a widespread impression that the English native bee is the best for English bee-keeping, and it is possible that the strain has degenerated by the absorption of the alien blood which has been introduced on a big scale. The competition between the races is not conducted on fair lines. The queen breeders offer the best Italian and Carniolan queens that can be procured, and comparisons are made with the common strains of the native bees. Why do we not have some choice strains of English bees put on the market with as much advertisement as the foreigners? If there is not sufficient demand for improved native bees, an effort should, I think, be made to create a demand, and I hope county associations will give this important matter immediate attention. The Northumberland and Durham Association

have already taken up the question, and will at their next meeting vote upon a resolution to form a "Queen" club to investigate the relative merits of the English, Italian and Carniolan bees. I would suggest that all other County Associations take similar action and proceed by collective effort to get the best strains of native queens placed within reach of bee-keepers; and having done this, we might with equanimity leave the three races to a free and fair competition.—J. W. KIDD, Well Close, Stocksfield-on-Tyne.

The above expresses very clearly the opinion we have held and taught for several years past. There is a great deal in it, and we commend it to the serious consideration of Associations.—ED.]

#### BEE-KEEPERS' ASSOCIATIONS.

[8253] A bee-keepers' association is, in some counties, a great help to the bee-keepers in that county, but unfortunately they do not all work in the same manner, and in this short article I would like to suggest improvements which might easily be made, and help all those residing within their county's bounds. As the majority of bee-keepers are aware, an association usually exists by the subscriptions from not only bee-keepers, but from many people who, although unable to have bees, have the interests of bee-culture at heart. An expert is employed to visit the apiaries of subscribers, and to help the members by giving good advice; also, many classes at a county show are reserved "For members only." These are the chief benefits that an association usually extends. Now I would suggest that the present expert of a county be raised to the rank of superintendent, and that as many additional experts as possible be appointed to manage certain allotted districts; each should have a list of all bee-keepers in his particular district. Every bee-keeper should be visited twice a year, one of the visits being made after the honey harvest, so that in case of any disease it would be easily noticed. A report should be made by the experts each month, and forwarded to the superintendent, so that in cases of disease he might himself visit that apiary. At the present time (take the case of a labourer) a cottager who subscribes 2s. 6d. per year may perhaps have a visit from the expert. The question is: Is the visit to that particular bee-keeper of any help at all? Now, reader, you must agree with me and say: It may be. Why MAY be? Why, because that person is perhaps living in a place difficult to get at, or he may be the only member for some miles, it is a

hundred to one chance that the time when the expert finds it most convenient to himself is not at all convenient to the member. From this you will see that if my suggestion was carried out it would be a great benefit to all bee-keepers. Let all in the county have visits, whether members or not, for if the visit of the expert be made in a friendly manner, naturally a subscription to the association would follow. Visits should be made in spring and autumn, not when the bees are working well in the honey season. The experts should be paid a small honorarium per apiary visited. In winter, meetings could be arranged in the various districts, so that all could meet together and discuss the many questions that arise with regard to their hobby. This would naturally help to increase the number of apiarists, and lead to a more friendly spirit one towards another. In conclusion I would urge that all classes for bees and honey at shows that are at present "For members only" be done away with. Throw all the classes open to all residents in the county, so that all may have the same chance to compete.—W. H. T., Expert, B.B.K.A.

#### ADVERTISING IN THE "B.B.J."

[8253] My advertisement in "B.B.J." caused me to be inundated with orders. This so upset my landlady that during my absence she has refused to take in my letters, which caused several to be returned through her stupidity. All orders in hand will be dispatched in rotation. Will you kindly inform your readers. I have already returned 280 letters containing P.O. to senders.—W. H. BROWNLOW.

## Queries and Replies.

[8214] *Surplus Pollen in Combs.*—I have been using a shallow-frame super fitted with worker foundation on top of each of the body boxes of my hives, in order to have good strong stocks. After breeding in the shallow-frames I allowed the bees to store honey in them. They have left a lot of pollen in the cells. Will it be all right if I leave the pollen in the combs and store them away for the winter? If not, how can I remove it?—H. B. RIDGWAY.

REPLY.—The pollen will do no harm if left, but it will probably become a little hard, and though the bees will clean it out next spring, it will give them a lot of work. To remove it, soak the combs well in water, then use a syringe or hose on them

with plenty of force, and all the pollen will be washed out.

[8215] *Bitter Honey-Bee Parasite*.—At the end of the honey-flow several of my sections were unfinished, and I left them in the hives. The bees have now filled the empty cells with a yellow honey which has a bitter taste just like marmalade. Would you kindly let me know in the BRITISH BEE JOURNAL whether it would be safe to eat the sections? I enclose a small sample of the honey. To the best of my knowledge there is no marmalade or jam factory within three miles. (2) Could you also kindly say what is the best way of getting rid of the little red insects that cling to the backs of the bees? If touched with a camel-hair brush they simply jump on to the back of another bee.—E. F. LEDGER, Lee.

REPLY.—(1) There is no doubt the bees have had access to some jam factory. The flavour is anything but palatable, and we should not care to eat it. (2) To remove the parasites blow a little tobacco smoke in at the entrance of the hive; this will cause them to drop from the bees, and the brood chamber can then be lifted and the floor board swept clean.

[8216] *Moving Bees*.—Will you kindly advise me in the next issue of the BRITISH BEE JOURNAL as to the best time to move my bees? I have five stocks and two driven lots, which I am feeding up for the winter. Having no garden until recently, I have kept them on the flat roof of my house which is very high and exposed to the east wind, but now having a garden about a quarter of a mile away (which is on a slope facing due south). I wish to move the hives there. If bees are seen carrying pollen at this time of the year, is it a sure sign that there is a laying queen present in the hive? Thanking you in anticipation.—J. L. H., Salcombe.

REPLY.—The best time to move them will be when climatic conditions keep the bees indoors for a fortnight or so. Close the entrance with perforated zinc; cord well, and carry the hive on a hand barrow if possible. If not, then use a lorry with good light springs, and place the hives so that the combs travel end on to prevent them swinging.

[8217] *Bottling Honey*.—I shall be glad of a reply to the following queries:—(1) What causes such a number of dead bees outside the hive, after the honey has been taken from them? I estimated that there was about half a pint outside one hive. Is this unavoidable? (2) Should sections be removed from the hive as soon as they are sealed over? (3) Do you advise straining extracted honey more than once? What is the best material to use? (4) How do you get rid of the air bubbles which

lie on the top after straining?—NOVICE, Leicester.

REPLY.—(1) Generally the dead bees are the result of fighting through robbing. The bees become very excited unless the work is carried out in the evening so that they have time to settle down. (2) Yes, otherwise the cappings become travel-stained and too thick. (3) Not if it is strained through fine muslin. (4) Allow the vessel to stand until the bubbles have all risen and form a scum upon the surface: the honey can then be drawn from the tap at the bottom of the ripener, and will be found clear.

### CAPPINGS OF COMB.

BY L. S. CRAWSHAW, NORTON, MALTON, YORKS.

*Feeding and Disease* (p. 305).—I fear that many of us will have to continue to suffer from the risk of bee diseases on account of our inability to obtain that delightful and most potent specific, honey from the Roman Campagna.

*The Load of a Bee* (p. 308).—I have not fully understood the editorial answer as to the number of loads of nectar required to fill a cell. It is not clear to me why this should "depend upon density or otherwise." Presumably the reduction of nectar into honey is considered. Suppose, however, that a bee carries a fair load, and that this is represented by a sphere one-eighth of an inch in diameter, then it will take about twenty-four loads to fill a worker cell, the dimensions of which we will suppose to be those of a cylinder one quarter of an inch in diameter, and half-an-inch long. For the purposes of calculation I have taken the contents of the stomach as .00102 cubic inches, from which the number of loads required for any other size of cell may, if desired, be easily determined by T.R. (page 308). The specific gravity of honey is about 1.44, which, supposing the nectar to be of the extreme consistency of water, would mean its reduction by about one-third of its bulk, and require fewer than thirty-five loads for this size of cell; and by the same token, it would take some 38,000 loads to produce a pound of honey, which means that a colony able to spare 3lb. of bees to go a gathering would gain that weight of honey with an effort of about four journeys per bee—always supposing that I have made no mistake in a somewhat hasty calculation.

*Ants, Bees, and Wasps* (p. 312).—One cannot read this account of the intelligent work of these ants, together with that of the astonishing thoughtfulness of allied species, such as the agricultural ant, without, perhaps, pausing to consider whether the renowned intelligence of the hive-bee is comparable. I believe that

Lord Avobury was attacked for ranking the hive-bee lower in the intellectual scale. For my own part, I am prepared to believe, from observation of wasps, that whilst their economy does not lend itself to our purposes, unless we go fishing, yet that, prejudice aside, they think more quickly and intelligently than our own honey-bee.

*Bees Transporting Eggs* (p. 313). Five weeks certainly seems a long time for eggs to remain undeveloped; or, rather, five weeks less the progress of the queen-cells. But, in spite of this, I do not think that M. Mattutis proves his case. It is, I am aware, an unimportant objection, but there can have been little object in transporting fifty eggs up several flights of stairs, just to make them into worker bees. Of course, it may have been excess of zeal, or the necessity for company, but is it essential to intelligible explanation that the eggs should have been transplanted at all under the detailed circumstances? Why may not the eggs have been laid *in situ* and only developed late? Recently, I carried out a somewhat similar operation. I placed the old brood-nest over an excluder, with a recently caged and now released queen upon a set of partly stored but broodless brood-combs below. This for queen-rearing experimental purposes. I gave those bees set after set of grafted cell-cups, but they obstinately refused to attend them. I made several examinations to discover cells of their own devising, but found none. Finally, after nearly three weeks, when tiring of the experiment, I made a move to divide the stock into nuclei, and found a number of cells in progress on several combs. I removed these, and gave a further set of cells, which were at once accepted. I believe that these eggs were simply retarded, as a few cells of worker brood were also in evidence, and no queen was present above the excluder. However, I hope to try the experiment again next summer, this time with a foreign queen, to see if the foregoing result can be easily duplicated.

*Shaking Bees from Combs* (p. 326).—Advice to this effect is continually given in text-books and journals, but disaster so often follows that I feel sure bee-keepers would find it useful to make a habit of brushing the bees from the combs. Shaking is often responsible for a broken comb, a most annoying happening, and even when combs are sufficiently strong, thin honey is often thrown out and showered upon the fallen bees, and perhaps upon the alighting-board and hive surroundings. Then, too, shaking may not dislodge the whole of the bees, some of which may be singly ensconced at the first throw, and

afterwards use extra endeavour to hang on. Good bee brushes are indispensable adjuncts to a busy bee-keeper.

*Mineral Constituents of Honey* (p. 333).—It may be perfectly true that dark honey contains desirable minerals, but I fear that the consideration is little likely to weigh with a discriminating or indiscriminating public. It is evident, however, that these constituents are not entirely confined to honeys which seem as though the bees had been looking upon the honey-dew when it was black, but that some light honeys also contain them. It must be clear, therefore, that purchasers who must take their iron with their sweet should stipulate for such light honeys as are classed in group four. The fortunate producers will then be able to obtain an enhanced price for their tonic honeys (covered by a suitable guarantee of analysis), which patients may obtain without the labour attached to visiting a continental resort. It would be interesting to know from what sources, or districts, such "mineral" honeys proceed, and whether the analyses of honeys from definite sources have been fairly uniform.

---

## Notices to Correspondents.

---

**RADNORIAN.**—*Quality and Price of Honey.*

—No. 1 is a very nice clover honey, it has granulated well and is worth 10d. per lb. No. 2, is from mixed sources, not so good as No. 1, worth about 8d. per lb. No. 3, contains a good deal of ragwort. It is worth about the same as No. 2. No doubt the wax was tough through being on too long, or the foundation may have been too thick. You can reliquify the honey in the ripener by placing it in a copper of water and heating; first drive a cork into the tap to prevent water getting in. Use muslin tied under the strainer; this will prevent bits of wax, &c., going through. You should draw a fine wire between super and brood-chamber before removing in case of its being propolised. The super is evidently a little too shallow. The hives will not need painting for a couple of years, then give them two coats. No. 1 is good enough to stage at a local show.

**A. C. (Milton of Campsie).**—*Unsealed Syrup in Combs.*—You can keep the stored combs in the hive behind the dummy, where they may be left until spring, when they can be given to the bees as food. Or, if preferred, the combs of food can be taken out, and stored in a box in a warm room indoors until required.

H. S. (Cheshire).—*Sugar for Bee-food.*—The sample is evidently beet-sugar and should not be used for syrup.

H. O. (Downton). *Useful Tool.*—The appliance is very neatly made, and no doubt useful for all the purposes you name. But, as a pocket-knife or a quill will serve the same purpose, we do not think it would be a success financially to place it on the market as the limited sale would not recoup you for your trouble.

Gouk (Gordon, N.B.).—*Dead Queen.*—The queen you send is a virgin.

#### Honey Samples.

J. F. (Halifax).—The sample is a very good heather mixture, and will certainly do to show as such.

G. F. S.—Both samples are good in all respects, but No. 2 is the best flavoured honey.

L. COLLINCE.—Good in colour, density and flavour poor; from clover and charlock. Yes, even we old hands can always learn something.

NOVICE (Leicester). Good in consistency, medium colour. Mainly from chestnut, and this accounts for its colour. Honey will often vary in each super according to the flowers the bees are working.

E. TAYLOR.—The honey is from sainfoin, rather poor in flavour and density, though a splendid colour. We should not care to show it.

E. THORPE (Pateley Bridge).—The sample you send is a delicious heather honey of first-class quality. Whether it would win or not at a show you will quite understand depends upon the competition with it.

#### Suspected Disease.

A. W. H. (Salisbury.) We can find no disease in the bees. It is no doubt a case of robbing.

A. B. C. (Sussex.) The bees were too dry for us to do anything with them.

F. N. (Luttrehampton).—The bees were drowned in the food, so it was impossible to examine them. If you are doubtful, why not try the remedy advertised in our advertisement pages.

H. R. (Lincoln).—(1) We cannot find anything wrong with the bees except slight constipation. (2) Combs and honey from affected stocks should not be given to healthy bees.

H. P. (Eastbourne.) A case of malignant dysentery, and it will be best to destroy the colony.

J. G. (Stoachaven).—The comb contains foul brood of old standing. You did quite right in dealing with the stock as described.

### Special Prepaid Advertisements.

Two Words One Penny, minimum. Sixpence.

Orders for three or more consecutive insertions entitle advertisers to one insertion in "The Beekeepers' Record" free of charge.

Trade advertisements of Bees, Honey, Queens, and Bee goods are not admissible at above rate, but will be inserted at 1d. per word as "Business" Announcements, immediately under the Private Advertisements. Advertisements of Hive-manufacturers can only be inserted at a minimum charge of 3s. per ½ in., or 5s. per inch.

### PRIVATE ADVERTISEMENTS.

WANTED, few cwt. of Heather or Heather Blend.—Will send tins. Sample to DELL, Leigh, Lancs. m 70

BARGAIN.—Owner going abroad. Cottage and 3 acres land, fruit trees, Apiary, 40 Stocks Bees, and good trade connection.—G., C/O "B.B.J." Once, 23, Bedford-street, Strand, W.C. m 75

GOOD POULTRY FARM and SMALL APIARY to let, cheap, with cottage, furnished or unfurnished.—Apply, THE OFFICE, Pangbourne, Berks. n 2

CHAPMAN HONEY PLANT, seeds 4d. packet; two 3d., free.—REV. ANDERSON, Northam, North Devon. n 3

FINEST LINCOLNSHIRE WOLD LIGHT CLOVER HONEY, 50s. cwt., f.o.r.—SMITH, Rose Cottage, Nettleton, Caistor. n 1

EXCEPTIONALLY white and heavy Sections, 72 for 50s.; good ditto, 72 for 50s.; finest Extracted, in 28lb. tins, 15s., free on rail.—ALBERT SANDYS, Drayton, Abingdon. m 100

STOCK BEES, healthy, 8 Frames, Stores, in travelling box, 10s.; approval if returned free. Hives and Appliances quarter cost; giving up.—VICE, Thrusington, Leicester. m 95

GOOD SECTIONS, 7s. doz., unglazed, cash with order.—W. CANHAM, Jun., Scham, Cambs. m 95

HONEY, good colour, 58s. per cwt., tins free; ½lb. sample, six stamps.—A. PRAETOR, Calne Park, Earls Calne, Essex. m 92

HONEY FOR SALE.—Apply, VASSELIN, 102, Alan-road, Ipswich. m 91

WANTED, three good empty Hives, drawn out brood and shallow Combs, guaranteed free disease.—KNOWLMAN, Woodgate, Wellington, Somerset. m 90

FINEST CLOVER HONEY, 58s. cwt.; sample 3d.—BUTTON, Manse Cottage, Haverhill, Suffolk. m 89

FOR SALE, several excellent Stocks British Bees, cheap, guaranteed healthy; particulars, stamp.—COAKES, Clent. m 88

WHITE WYANDOTTE COCKERELS, Hunter's strain, 5s., or exchange Bees or Honey, &c.—LEECH, Newland Park, Hull. m 87

FOR SALE, fine clover Honey, sample 2d.—MARSHALL, 68, Chelmsford-street, Lincoln. m 86

GRAND EXTRACTED HONEY, 56s. per cwt.; sample 3d.—F. W. GELDER, Sturton, Lincoln. m 85

LOVELY SECTIONS LIGHT HONEY, glazed, in perfect condition, 12s. doz., carriage paid; pretty contribution to bazaars, sure to sell.—M. W. BYLES, Redenham, Andover. m 84

## Editorial, Notices, &c.

### BRITISH BEE-KEEPERS' ASSOCIATION

The monthly meeting of the Council was held on Thursday, September 21st, 1911, at 23, Bedford Street, Strand, London, W.C., when Mr. C. L. M. Eales presided. There were also present Messrs. T. Bevan, O. R. Frankenstein, A. Richards, A. G. Pugh, J. B. Lamb, E. Walker, R. T. Andrews, J. Smallwood, E. Watson, E. Garcke, and Dr. T. S. Elliot (Affiliated Association delegates), G. W. Judge (Crayford), J. Cunningham (Cambridge and District), G. Hayes (Notts.), L. McNeill Stewart and T. D. Sinfield (South Beds.), G. R. Alder (Essex), A. Willmott (Hertford and Ware).

Letters expressing regret at inability to attend were read from Miss Gayton, Mrs. Chapman, Miss K. M. Hall, Messrs. T. W. Cowan and W. F. Reid, Col. H. J. O. Walker, Rev. A. D. Downes Shaw, and Captain Sitwell.

The minutes of Council meeting, held July 20th, were read and confirmed.

The following new members were elected:—Mrs. L. Deane Streatfield, Cotage-on-the-Hill, Westerham, Kent; Mr. G. R. Alder, 176, Hainault Road, Leytonstone; Mr. R. Heywood, Pentney House, Narboro', Norfolk; Mr. S. Haigh, Quarmby, Huddersfield; Mr. J. M. Barbour, 4, Auckland Terrace, Ramsey, Isle of Man; Dr. D. Wardleworth, Sheringham, Norfolk; Mr. H. C. Chapelow, Wye, Kent; Mr. J. H. Seakins, Eastgate Lodge, Peckham Rye Common; Mr. G. Egerton Pollitt, Stanley House, Fairfield, Manchester; and Rev. D. E. Rowlands, Wollaston Vicarage, Welshpool.

The report of the Finance Committee was presented by Mr. J. Smallwood. The balance in hand at the end of August was £210 9s. 5d., and it was resolved that payments amounting to £75 0s. 6d. be made.

Reports on third-class examinations held at Stafford, Henwick, Aberlony, and Grantown, Lancaster, Northampton, Coventry, Chester, Bradford-on-Avon, Swanley, Boston, Bridgend, Worcester, Taunton, Bridgwater, Luton, Gloucester, and Cardiff, were submitted, and it was resolved to grant certificates to the following: Misses J. D. Bagnall, P. Brightman, M. Brown, E. Dowding, R. Elliot, D. Freeman, D. Gibbins, M. Gordon-Roberts, R. Gribbie, K. Hancock, C. Heath, L. Joshua, P. Jones, A. Mayo, A. Middleton, B. Mitchell, M. Partridge, E. Price, M. Rivett, D. Roberts, M. Rudolf, J. Smith, J. O. Story, W. Solomon, H. Thrupp, J. Furner, W. Warburg, A. Woodward, B. Tanner, L. Brooks, E. Greet, D. Hawley, R. Denison, R. Williams, A. Dexter, J.

Reed; Mrs. M. Hellett; Messrs. T. Richards, W. Dyer, W. F. Pick, J. Hillman, A. H. Bowen, J. H. Wilson, G. Hays, F. R. Harris, G. E. Stoakes, P. C. Doswell, J. H. Pugh, L. Hinton, A. F. Leatham, B. Collett, A. T. Freeman, W. S. Laycock, W. Eastham, J. Ratchiffe, G. Richardson, J. W. Farnsworth, J. Hulbert, R. N. Chapman, R. C. Massan, J. Bevan, H. Beynon, D. Davis, H. Cartwright, J. Bray, E. Ballard, G. W. Ash, A. R. Penny, P. Reynolds, R. Pritchett, B. Rayes, G. Steventon, F. Kenward, W. J. Cornall, P. G. Russell, V. Pickering, C. R. Forse, W. Jackson, R. Tildesly, R. G. Morrison, C. Raffan, G. Greigson, J. S. Dnubar, P. Cruickshank, W. Macdonald, J. Taylor, J. Greig, J. Sewart, W. C. Johnson, R. B. Manley, J. Blackwood, T. A. Denison, G. H. Garratt, T. Brook, H. H. Brook, T. Alum-Jones, E. W. Franklin, Col. H. Dobbie, and Dr. T. S. Sellar.

Arrangements were made for the conversation to be held on the Thursday in "Dairy Show" week, October 5th, at the Gardenia Restaurant, 6, Catherine Street, Covent Garden, London, W.C. (next door to Drury Lane Theatre). Mr. J. C. Bee Mason kindly offered to give a cinematograph entertainment, the new films being entitled "The Life of the Honey Bee," and "The Production of Honey"; papers will be read by Mr. O. R. Frankenstein on "The Marketing of Honey" and Mr. L. E. Snelgrove on "Re-queening." All bee-keepers are invited.

The examination for second-class certificates was arranged for November 24th and 25th. Messrs. D. M. Macdonald, T. W. Swabey and J. W. Mason presented themselves to undergo the lecture test for the first-class certificate. All were successful.

The report of the Treasury Grant Committee was presented, and after a long discussion it was proposed by Mr. A. Richards, seconded by Mr. O. R. Frankenstein, and carried, that the report of the Treasury Grant Committee be referred back to that committee for further specific recommendations, which committee shall have the assistance of Messrs. S. Jordan, A. G. Pugh, A. Richards, E. Walker and E. Watson, the remaining members of the special committee of delegates appointed on May 18th, 1910.

Next meeting of Council will take place on October 5th.

### CHESHIRE B.K.A. ANNUAL SHOW.

The annual show of the Cheshire Beekeepers' Association was held in connection with the County Agricultural Show at Chester on August 30th last. An excellent display of honey was staged, and

the keenness of both the new Secretary and the members augurs well for the future of the association, which only a year ago was in an almost moribund condition. Arrangements were being made for winding up its affairs, which would have been disastrous in such a splendid bee-keeping county as Cheshire undoubtedly is, but fortunately the bee-keepers made a splendid rally, and succeeded in putting the association on a sound basis once more. The Rev. T. J. Evans and Mr. W. Herrod judged the exhibits, and also held an examination of candidates for the B.B.K.A.'s third-class certificates. The following is a list of prize-winners:—

## OPEN CLASSES.

*Complete Frame Hive.*—1st and c., Geo. Rose, Liverpool.

*Twelve 1-lb. Sections.*—1st, A. S. Dell, Leigh, Lancs.; 2nd, C. W. Dyer, Compton, Newbury; 3rd, Wm. Reece, Tarporley; v.h.c., Geo. Pennington, Moberley; r., R. H. Baynes, Cambridge; h.c., John Berry, Llanrwst, and Geo. H. Garratt, Pulford.

*Twelve 1-lb. Jars of Extracted Honey.*—1st, A. S. Dell; 2nd, A. C. Jackson, Thetford, Norfolk; 3rd, H. W. Saunders, Thetford, Norfolk; r., E. Church, Cardiff; v.h.c., Hugh Berry, Llanrwst, and R. W. Lloyd, Thetford; h.c., John Berry, J. S. Stopford-Taylor, West Kirby, and D. H. Burgess, Elworth.

*Observatory Hive.*—1st, Fred C. Kelly, Hawarden.

## COUNTY CLASSES.

*Six 1-lb. Sections.*—1st, Wm. Reece; 2nd, Geo. Garratt; 3rd, W. Hulley, Northop.

*Twelve 1-lb. Jars of Extracted Honey.*—1st, H. Stubbs, Crewe; 2nd, D. H. Burgess; 3rd, Job. Astbury, Kelsall; r., J. S. Stopford-Taylor; v.h.c., A. E. Wright, Elworth, and G. E. Wilson, Puddington; h.c., Geo. H. Garratt, John Weaver, Christleton, and John Tomlinson, Buckley.

*Twelve 1-lb. Jars of Extracted Honey.*—1st, T. A. Jones, Halkyn; 2nd, T. Newport, Tattenhall; 3rd, John Tomlinson; r., Wm. Vickers, Silston, Malpas; v.h.c., S. Gerrard, Heswall.

*Two Shallow Frames.*—1st, D. H. Burgess; 2nd, A. E. Wright; 3rd, Geo. H. Garratt; r., F. C. Kelly; v.h.c., Samuel Jennings, Over Tabley.

*Bees-wax.* 1st, Job Astbury; 2nd, Moody and Wilding, Crewe; 3rd, H. Stubbs; v.h.c., W. Hulley; h.c., J. Boden, Barnton.

*Twelve 1-lb. Jars of Extracted Honey.*—1st, H. Stubbs; 2nd, Moody and Wilding; 3rd, F. Newport; r., N. Grant Bailey, Chester; v.h.c., J. S. Stopford Taylor and Job Astbury; h.c., Jos. Ward, Lower Walten.

*Six 1-lb. Jars of Extracted Honey (Novices).*—1st, F. Newport; 2nd, G. E. Wilson; 3rd, John Boden; r., Moody and Wilding; v.h.c., L. S. Taylor.—*Communicated.*

## CRAYFORD AND DISTRICT B.K.A.

The fifth annual show of the above association was held at Orchard House, Crayford (by kind permission of the President, E. R. Stoneham, Esq.), on Saturday, September 2nd, and was considered by those competent to judge to be a record one in every way. Although the society is only a small one, the entries amounted to one hundred and seven, members only being allowed to compete. The honey and wax staged was of excellent quality, and the home-made bee appliances called for particular attention. A competition in practical frame building, foundation fixing and wiring, and section fitting was held, and proved to be a very interesting event, points being awarded for time and neatness. The President presented a W.B.C. hive to be drawn for in aid of the funds, and Mr. W. Herrod, who acted as judge, presented a medal to the member securing the highest number of points. This was won by Mr. G. Judge, of Hawley, Dartford, with twenty-eight points. Third-class certificates were presented to Messrs. Barnes, Bryden, and Rivers, who had been successful in passing the B.B.K.A. examination during the summer. The awards were as follows:—

*Three 1-lb. Sections.*—1st, Miss Hall; 2nd, G. Bryden; 3rd, G. Judge; h.c., G. H. Barnes.

*Six 1-lb. Sections.*—1st, G. Bryden; 2nd, G. Judge; 3rd, The Association; h.c., Miss Smiles.

*Three Jars of Light Honey.*—1st, C. H. Rivers; 2nd, — Hankin; 3rd, — Wiggins; h.c., G. Bryden.

*Three Jars Medium Honey.*—1st, G. Judge; 2nd, C. H. Rivers; 3rd, G. H. Barnes; h.c., Miss Smiles and Miss Hall.

*Three Jars of Dark Extracted Honey.*—1st, G. Judge; 2nd, Miss Smiles; 3rd, — Hankin; h.c., J. Roper.

*Two Shallow Frames.*—1st, Miss Smiles; 2nd, G. Judge; 3rd, E. R. Stoneham; h.c., G. Bryden.

*Home-made Bee - Appliances.*—1st, G. Judge; 2nd, — Hazelden; 3rd, J. E. Smiles; h.c., G. H. Barnes.

*Bees-wax.*—1st, Miss Smiles; 2nd, E. R. Stoneham; 3rd, C. H. Rivers; h.c., G. Judge.

*Bee Produce.*—1st, G. H. Barnes; 2nd, Miss Smiles; 3rd, G. Bryden.

*Single 1-lb. Jar (open class).*—1st, C. H. Rivers; 2nd, G. Judge; 3rd, — Upton.

*Single 1-lb. Section (open class).*—1st, G. Judge; 2nd, G. Bryden; 3rd, G. H. Barnes; h.c., Miss Smiles.



*Frame Building Competition.*—1st, Miss Smiles; 2nd, A. Dewey; 3rd, G. Bryden.

The thanks of the association are due to the President and Secretary for the excellence of the arrangements; to these gentlemen the success of the Exhibition is in no small measure due, the grounds of Orchard House being an ideal place for a show of this nature.—*Communicated.*

## SOUTH OF SCOTLAND B.K.A.

### ANNUAL SHOW.

The annual show of the South of Scotland B.K.A. was held at Castle-Douglas on September 14th last, and proved to be a decided success. The judges, Messrs. W. Hogg and H. Marrs, were highly pleased with the excellent quality of both extracted and section honey, and congratulated the association on the fine display of bee products they had brought together. The awards were as follows:—

### OPEN CLASSES.

*Three 1-lb. Jars Extracted Honey.*—1st, J. Henderson, St. Serf's, Old Cumnock; 2nd, A. White, Lyndhurst, Old Cumnock; 3rd, A. F. Borland, The Knowe, Cumnock; v.h.c., J. M. Stewart, Mollance, Castle-Douglas; h.c., J. M. Stewart; e., D. Johnstone, Greenlaw, Castle-Douglas.

*Three 1-lb. Sections.*—1st, John McDonald, Lochfoot, Dumfries; 2nd, D. Johnstone; 3rd, John Ross, Barkerland, Dumfries; v.h.c., John Ross.

*Single 1-lb. Jar.*—1st, A. F. Borland; 2nd, J. M. Stewart; 3rd, R. Slater, Hardgate, Dalbeattie; v.h.c., D. Johnstone; h.c., W. Duplop.

*Single 1-lb. Section.*—1st, D. Johnstone; 2nd, J. McDonald; 3rd, R. Slater; v.h.c., J. Ross.

*Bee-swar.*—1st, J. M. Stewart; 2nd, J. Ross; 3rd, D. Johnstone.

### MEMBERS' CLASSES.

*Super of Honey.*—1st, W. D. Tait, Spottes, Dalbeattie.

*Six 1-lb. Sections.*—1st, J. McDonald; 2nd, J. Ross; 3rd, R. Slater.

*Three 1-lb. Sections.*—1st and 2nd, J. McDonald.

*Six 1-lb. Jars Extracted Light-Coloured Honey.*—1st, A. F. Borland; 2nd, J. M. Stewart; 3rd, D. Johnstone; v.h.c., R. Slater.

*Six 1-lb. Jars Extracted Medium-Coloured Honey.*—1st, R. Slater; 2nd, J. Ross.

*Two 1-lb. Jars Extracted Honey.*—1st, A. White; 2nd, A. F. Borland; 3rd, J. Henderson; v.h.c., A. White; h.c., and e., J. M. Stewart.

*Two 1-lb. Sections.*—1st, J. McDonald; 2nd, D. Johnstone; 3rd, J. Ross; v.h.c., J. M. Stewart.

*Three 1-lb. Jars Extracted Heather Honey.*—1st, A. White; 2nd, J. Halliday;

Slogarie, New Galloway; 3rd, P. Dalziel, Hough-of-Urr.

*Three 1-lb. Sections Heather Honey.*—1st, A. White; 2nd, J. Henderson; 3rd, A. F. Borland; v.h.c., J. Halliday.

*Six 1-lb. Sections Heather Honey.*—1st, A. White; 2nd, J. Halliday; 3rd, A. F. Borland.

## Correspondence.

*The Editors do not hold themselves responsible for the opinions expressed by correspondents. No notice will be taken of anonymous communications, and correspondents are requested to write on one side of the paper only and give their real names and addresses, not necessarily for publication, but as a guarantee of good faith. Illustrations should be drawn on separate pieces of paper.*

### "ISLE OF WIGHT" DISEASE.

[8254] Referring to your editorial of 24th Aug., it seems to me a little premature yet to assume that "Experiments have evidently proved that this parasite (*Nosema apis*) is the infective agent." The few notes issued by the Board of Agriculture—I would respectfully submit—can hardly be said to justify the optimistic conclusion that at last the infective agent in the dread "Isle of Wight" disease has been isolated and identified.

They say "In some of the outbreaks investigated the spores of *Nosema apis* have been found." Evidently the spores were not found present in all the outbreaks dealt with. What then was the infective agent in those cases where traces of *Nosema apis* were absent? Again they say "In most of the outbreaks recently investigated few spores, if any, have been found, but parasites which are probably young stages in the growth of *Nosema apis* are usually present in the cells lining the intestinal tract."

Can the Board of Agriculture experts definitely say that the parasites in question are *Nosema apis* parasites? Until they can, and the identity of the parasite is placed beyond doubt, all deductions would seem to be little better than idle speculations. But why should there be any doubt? Is it not possible to identify the *Nosema apis* parasite in all its stages? It looks as if further progress lies along this line of research.

If this parasite infests the intestines of the bee, how comes it that the young bee, which is fed from the presumably disease infected stomach of the nurse bee, is clean and free from disease? The queen, nurse fed also, is, if I am not mistaken, generally free. It would be interesting to know (a) if *Nosema apis* spores are ever found in healthy bees taken from healthy hives? and (b) if any of the "Isle of Wight" disease infected bees examined show no traces of *Nosema apis* spores, or of the

mysterious unidentified parasite already mentioned? My enthusiasm for bees, which I have taken up this summer, must be my excuse for this long rambling letter.—A. HENDERSON, Skye, N.B.

[As the experiments have proved that normal bees can be artificially infected, and reproduce the disease, it is very strong evidence that *Nosema apis* is an infective agent. This parasite has been fully described and illustrated by Dr. Zander, and Dr. Maassen has produced over one hundred photo-micrographs which show the whole life history of *Nosema apis*, so that bacteriologists are now able to identify the parasite in all its stages. The food of larvæ is prepared by young nurse bees, and these, up to a certain age, appear to be harmless, being free from the parasite, and are therefore not able to communicate the disease. The queen appears to be able to resist the disease longer than the workers.—Dr. Hein has found *Nosema apis* in normal colonies, and that the parasite may be present for a long time in bees without causing trouble, so long as they are healthy in other respects. We shall no doubt have more light thrown on this subject when the investigations have been carried further, and the conditions which influence the growth of the parasite within the affected bees are better understood.—Ed.]

#### ARE BEE-ESCAPES OF ANY USE?

[8255] For the last three years I have found bee-escapes utterly useless, though four and five years ago they cleared the supers. This year I got a new escape with a thin celluloid spring, which I tested, and a bee went through it easily. It has now been three days in a hive, and not a bee has gone down through it, so I have taken off all the wrappings and given the bees a clear route of escape into the open air through the hive roof, but they refuse to move either upwards or downwards into the brood chamber. I read the "Bee-keepers' Guide Book," and find that the author assumes that the bee-escape is perfect and reliable, and so gives no advice as to what should be done when the escape is found to be useless. Of course, the alternative is to smoke down the bees from the super as far as possible, then take it off, remove each frame and sweep the bees from it. This is practical, but laborious for the bee-keeper and very injurious to the bees, especially in the present heat.—J. B. C., Loughboro'.

[If you use a proper "Porter" escape instead of trying so-called improved escapes, you will find the bees are cleared all right. Unfortunately for four years previous to this there have been very few supers to clear. In the management of considerably over a hundred colonies, we

have yet to experience a failure in the working of a "Porter" escape, and would not be without these useful appliances if they cost pounds instead of shillings.—Ed.]

#### SWARM CONTROL.

[8256] Having been much interested in Mr. Stapleton's letter (page 244) under the above heading, and also in the comments on same from correspondents in the "B.B.J.," I should like to say a word or two on this subject. I have made a thorough study of the swarming impulse in bees for many years and think I may claim to be able to control it thoroughly. I would here like to say I do not doubt Mr. Stapleton's success under his system, nor do I wish to discourage any bee-keeper from trying it, but I think he must (according to my experience) have been very fortunate, as I find it no easy matter to run virgin queens in at the entrance. He also says the queen will look after the queen-cells if any are present. I would say, "And so will the workers, who will take care they are not destroyed if they have need of them." In fact, they will sometimes start queen-cells with a virgin queen in the hive. In conclusion, I must say that it is so natural for bees to possess the instinct to swarm that (according to my experience) with some strains of bees no treatment is *sure* to prevent it, unless the bee-keeper knows how to prevent or cure the swarming fever, and bring his bees into such a condition that it is unnatural for them to swarm.—JAMES FAIRALL, Hellingly.

#### A SINGULAR OCCURRENCE.

[8257] A very singular occurrence has happened in my apiary, where for many years I have kept only the real British black bees, the reason being that they are the best resisters of all kinds of bee disease. Some twelve years ago nearly every variety of bee had a home in this apiary, and after experimenting with each class to find out their qualities of productiveness—their powers of gathering nectar as well as their reliability to resist disease—it was finally decided to only breed from the pure English black bee on account of its having the best all-round qualities. During the last summer a large number of queens have been raised and mated, and all have turned out remarkably well except the last two. These, a few weeks ago, were observed leaving the hives on their making flight. They both returned quite safely, and in due time commenced laying. Judge of our surprise on examining the colonies one day last week to find their progeny a beautiful yellow colour of the type of Golden Italians. Evidently these young queens had been mated with pure Italians.

As there is no such strain in this village, it was decided to scour the neighbourhood and find whence this breed had come, and after several days' labour it was discovered that a colony of pure Italians had been located on the railway side near Norton Bridge, two miles away. It is evident that these queens had flown a good distance in order to be mated, or *vice versa*, the drones had travelled a long way. The most singular part is that the young bees do not appear as hybrids, but have all the distinctive and characteristic marks of the pure breed. It would be interesting to know if any other bee-keeper has had the same experience.—W. H. TINSLEY.

#### WASP TRAPS.

[8258] An efficient trap for wasps can be made from a cone escape, inverted into the neck of a glass bottle or jar; or even a piece of perforated zinc made into a cone so as to just fit into a large jam bottle. Another trap can be made as follows:—Prepare a small square of board, bore a hole in the centre, then fasten a cone escape over the hole (the same as in a hive roof), and invert over a jar. The jar, of course, must be baited with sweetened beer, or some such mixture. I have caught about a gallon measure of wasps, flies and wax-moths in half-a-dozen jars prepared as above in about twelve days. It is a good plan to leave decaying pears and apples where they fall. I often kill ten or more wasps from one fruit as they emerge singly. It takes but a few minutes thus to kill hundreds.

*Driving Bees.*—Where there are young bees in the skeps they seem not to know how to run with the older bees; I find that by placing the skeps mouth upwards in a dark place, with a cloth (which may be slightly raised off the combs with a bit of stick) over the top, in a few minutes the bees cluster on the cloth, and may all be shaken off on their old stand, and thus none are lost.—A. HARRIS, Wavendon, Woburn Sands.

#### SELFISH BEE-KEEPERS.

[8259] In the BEE JOURNAL of last week, your correspondent, W. S. S. (8242), complains of bee-keepers who raise large quantities of honey for mere amusement, and undersell in the market others who may be considered true representatives of the bee-keeping industry. We have heard of such men before, and rarely do they belong to a bee-keepers' association. Also they don't require visits from an expert. So-and-so, a neighbour, will help them whenever they need it, and show them anything, or even lend them an extractor. Very likely Mr. So-and-so is an expert doing all he can for his County Associa-

tion, and has been so kind out of generous instincts, and in the vain hope of procuring a new member. Or, perhaps, they know all that is needed after getting their knowledge from experts by means of lectures, demonstrations and shows, or inviting themselves to a neighbouring apiary. The brotherhood of bee-craft is only known to them for the advantage they can take of it, always gratuitously. Modern methods and improvements, the outcome of research and labour of public-spirited men, they readily appropriate, without a "thank you." Associations are "no good"; subscriptions are unnecessary. The expert, however, capable and careful, is vilified as a spreader of foul-brood, or perhaps, and per contra, as one who only wants to destroy other people's hives under the pretence that foul-brood is dangerous. Such men are no credit to the craft, and unfortunately they are met with only too frequently.—S. J.

#### THE WASP NUISANCE.

[8260] A correspondent (page 344) complains of wasps annoying bees, and of the difficulty of narrowing the entrance to enable bees to protect themselves, and at the same time ventilating sufficiently.

I had the same trouble, the wasps keeping the bees agitated from morning till night. I dared not close the entrance more, so I made another set of entrance slides, cut away part of the under-side of same along 4in. slide, and tacked perforated zinc over the slit. This gives, say, a 2in. entrance and 4in. on either side for ventilation, but wasp-proof. The immediate result has been that the bees ceased spreading themselves over the alighting-board and "going" for anything that approached the hive.

I think all dealers should supply their hives with a second set of slides like those mentioned. I can use them for shutting up a hive altogether if necessary. When wasps die out as winter approaches, I shall replace with ordinary slides.—WALTER ED. ZEHETMEYR, Twickenham.

#### THE SEASON IN LINCOLNSHIRE.

[8261] During August and September I have visited several members of the Lincs. B.K.A. as expert, and met with something which might interest your readers, viz.: a straw skep full of holes made by the woodpeckers to get the grubs. The stock was not destroyed.

I do not know whether this is an unusual experience, but I have acted as expert for nearly thirty years, and have not met with a similar case.

It is many years since I have found so little foul brood, but on the other hand, I have met with more wax-moth than usual. As far as my travels have

extended I find the season in this county has only been a fairly good one, there being very few cases of big takes, and fewer swarms than usual. The honey is of good quality, and there appears to be no honey dew.—FRANK H. K. FISHER, Sleaford.

#### FINDING A HONEY MARKET.

[8262] My own experience entirely bears out what Mr. Pinder says in his letter to you, published on September 14th. I have found many people ready enough to buy honey, if they only know where to get it. By sending out a notice of the fact that I had sections for sale, I have been able to dispose of about 250lb., and have had more than one repeat order. The carriage by rail for a reasonable distance is not great, and the difficulty of packing is solved by the use of a perfectly safe box for twelve or six sections, supplied by a well-known bee appliance maker. H. RICHARDSON.

#### CONTROLLING DISEASE IN MICHIGAN.

[8265] Though I have been only a few weeks in this State, I have already met a number of enthusiastic bee-keepers. There are four at this place, one of whom is quite an expert, and keeps some fifty colonies with good results. He uses eight-frame hives, and runs the apiary for comb honey only. American foul brood got quite a start in this section a few years ago, and he, with the bee inspector for the State, began a systematic work among the people. The chief trouble came from some ignorant persons who continually neglected their bees; but when visited some were anxious to learn how to treat the diseased stocks, and others allowed them to be destroyed. One old lady refused to do anything about it, and, as our law was not quite strong enough to compel action, it was a problem as to how to get rid of the trouble, which had to be taken in hand, or bee-keeping in this section would be ruined. But our bee-keeper was not to be defeated, and secured an outsider to buy the little apiary, and the obstinate lady has since boasted of getting "ahead" of the bee-keeper who wanted to destroy her bees. But did she? For in this way he was getting control of the situation. He watches his bees closely, and at the slightest appearance of disease uses the McEvoy treatment; he does not worry but promptly deals with it. The great need, after all, is for better and more enlightened bee-keepers, and then the possibility of this charming industry would begin to be realised. The bee-keeper I have mentioned uses only the best appliances, and takes scrupulous care of his bees. In case of any trouble he

treats promptly and thoroughly.—EDWIN EWELL, Litchfield, Mich., U.S.A.

#### A BEE STORY.

[8264] The short account I sent you last July (page 283) of my unpleasant experience when removing my section rack has provoked much mirth, and evidently is regarded as a huge joke by two of your correspondents. The account I gave you of the furious attack of my bees, owing to my own mistake, was a simple and unexaggerated statement, which I thought might be a warning to beginners, and also a hint as to a perfect remedy for bee stings. I make no claim to the enviable reputation of being a joker! One who was a witness of my discomfort remarked on reading your correspondents' remarks: "You did not in the least overstate the seriousness of the attack; it was no joking matter."—(Mrs.) M. W. BYLES, Andover.

#### A HOME-MADE OBSERVATORY HIVE.

We are indebted to Mr. F. C. Kelly, of Hawarden, Chester, for the excellent photograph of an observatory hive (shown on opposite page) made by himself and exhibited at the Annual Show of the Cheshire Bee-Keepers' Association. It was awarded the first prize as a most instructive exhibit. The hive is complete in every detail, each part, as will be seen, being labelled, so that those uninitiated in bee-craft could understand the different parts: worker, drone, and queen cells, honey, brood, pollen, supers of shallow frames, and sections are all shown in the clearest possible manner.

#### AMERICAN AND COLONIAL PAPERS. EXTRACTS AND COMMENTS.

By D. M. Macdonald, Banff.

*A Short Crop.*—This is all but the universal verdict on the other side in regard to the season up to August. Such veterans as Mr. Doolittle and Dr. Bohrer report, the one: "It is terribly hot at Bordino, 100 degrees in the shade, and we have had a poor season so far"; and the other: "Bees have not done very much here; it has been too hot and dry." Mr. Root summarises: "The crop of clover is going to be light, and basswood dried up rapidly." Mr. York considers "There will be a shortage of the crop over the whole country." Mr. Byer, Canada, reports, "Crop almost a failure."

*Finding Queens.*—Our brethren "over there" seem to find it hard work to find a black queen, and they have taken to the use of perforated zinc. Several writers in *Gleanings* recommend it. Mr. Crane "has made a basket with legs to hold the zinc a little above the ground, and it has

proved a great success. I would not take ten dollars for it if I could not make another. How easy it is to shake a swarm into a basket, let the bees through, and find the queen!" Mr. Root adds: "Several of our correspondents have found that they can shake black bees in front of an entrance-guard, and after the bees are all in find the queen on the outside." Here we have little difficulty in finding queens, but with a very strong lot of bees the foregoing might save a large amount of very warm and exhausting work.

*Interesting.*—Mr. Wesley Foster writes:

assertion that there is a very large amount of infant mortality in the brood nest. Thousands of eggs in a season fail to mature into the perfect bee. Close observers have drawn my attention to this fact repeatedly, and my own observation confirms that even in a perfectly healthy hive there are at times suspicious signs which need not cause alarm.

*Artificial Pollen.*—The *American B.J.* quoting from a German source, says: "As a substitute for pollen, flour from the legumes, as peas and beans, is greatly superior to that from the grains. The latter contains only 10 to 12 per cent. of

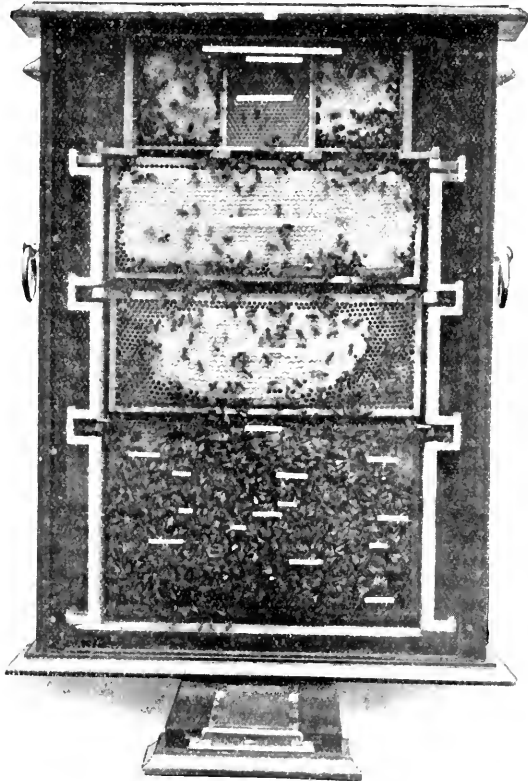

A HOME-MADE OBSERVATORY HIVE.

"My queens lay on the average 40,000 eggs from 15th May to 15th June; 10,000 of these, for one reason or another, fail to hatch, so 30,000 is what I get in new workers for this month. Now if a queen lays 80,000 eggs in May and June, and 60,000 of them hatch into bees, the probability is she will maintain throughout the honey flow a little over 50,000 workers. The mortality amongst bees is very heavy, but from watching the brood nest I am confident the heaviest loss is in the egg, larva and pupa stages." The subject deserves a little study. I am confident Mr. Foster is quite correct in his

nitrogenous matter, as against 20 to 26 per cent. in the legumes, which more nearly approach natural pollen with 30 to 40 per cent." Pea flour is most favoured in this country. Symington's pea flour suits the purpose admirably.

*Making Increase.*—The Associate Editor gives two good plans. Take from each of six colonies a frame of brood and bees, and if a flow is on they will cause no anxiety. If only two frames were used the bees would desert, but the case is different with six covered with bees, as sufficient will stay to protect the brood. Another method, "made in Germany," may

be used when harvesting the crop. Place a nucleus containing queen, brood, and bees in an empty hive, filling the empty space with combs. Above this place a bee escape, and over this several supers you want cleared of bees. Next morning remove your beeless supers, and there you are with your new colony.

Mr. Scholl gives three plans on another page. He works with shallow divisible hives, and, removing one of these without the queen, he simply places it on a new floor board in a new site. A queen is given at once, and the "entrance is chucked full of green weeds or grass." That is all the care given, because the bees eat their way out, and stay on the new site.

In early spring he uses his *weakest* colonies and breaks them up into two or more. By the end of the season he finds them all strong and fit for wintering. Under favourable circumstances he may even obtain surplus. This is in Texas!

A third time he favours us "at the tail end of the flow," when he draws on his strongest colonies only. As he counts on a fall flow, he gives a second section and winters on two.

*A Great Industry.*—A few facts in regard to apiculture are well worth recording. The value of honey produced annually is on the average £4,000,000, and of wax £40,000. The number of sections manufactured may be taken at 80,000,000, and it is estimated that extracted honey is about four times as great. The most important bee-keeping States are Texas with 60,000 apiaries, California 55,000, Kentucky 45,000. Texas again comes to the front with 400,000 individual colonies, and it takes the lead in money value with \$800,000, New York following with \$600,000. The five leading States producing the largest honey harvests are: Texas, 5,000,000; California and New York, each 3,500,000; and Missouri and Illinois, 3,000,000 each.

There are 164 registered queen breeders in the States, but the actual number is probably more than double this figure. Breeders of Italians outnumber all others by at least two to one. Texas and Alabama come to the front in wax production, each yielding 160,000lb. Most of these figures might be very considerably increased if more recent statistics were available.

*Vigour in Races.* Mr. Morley Pettit asserts, "The disease (foul brood) is not cured unless the bees are Italianised." Several at the Convention wanted proofs, and a few stood up manfully for blacks. Dr. Miller "suspects that hybrids are just as good as Italians if just as vigorous," and the Editor of *Gleanings* not only considers "a cross between Italians and Blacks might clear up the disease as well," but

he also adds: "It is conceivable also that some pure Italians will be no better than Blacks."

---

## Queries and Replies.

---

[8218] *Badly Capped Sections.*—In my strongest hives at the heather I have a great many sections badly discoloured, and the honey is oozing out through the capping, and sweating badly. What is the reason of this, and is there any remedy? The sections are all well filled, but their appearance is completely spoiled. Shall I have to ask less for such sections? I am receiving 1s. 6d. for best quality. An answer through your esteemed paper, the BRITISH BEE JOURNAL, will much oblige.—ANXIOUS, Berwick-on-Tweed.

REPLY.—The bees are bad sealers and make what are called greasy cappings. You will have to change your strain of bee. Much depends on the customer as to whether you will have to take less, but usually sections in this condition are difficult to dispose of, owing to their unattractive appearance. We are pleased to hear you value our paper so much.

[8219] *Preventing Comb Honey from Granulating.*—Would you kindly let me know whether one can make sure of keeping honey in frames from granulating during the winter, and if so, by what means? And can one, on the other hand, cause extracted honey to candy by any treatment, so that it may be given to the bees instead of sugar candy in February? I have taken many frames of honey from the brood nests: if the honey in them will remain liquid, I can put them back next spring, when the bees need feeding; but if there is a likelihood of their candying, I propose to extract the honey now, and give it as candy, or make it into "Goods" candy to give to the bees at the end of the winter.—H. BALFOUR GARDINER.

REPLY.—Keep the combs in a warm dark place, and they will be in good condition to be fed in the spring. Honey will not granulate hard enough to give to the bees in place of candy, but if you wish to use it up, a certain proportion can be mixed in the candy when making.

[8220] *Bees in Observatory Hive in Winter.*—I have made an observatory hive with ample ventilation, and have stocked it with a lot of driven bees. If I bring this hive into the kitchen where it is warm for the winter, do you think it will keep the queen laying, and so improve the stock for the following spring? Of course, I shall constantly feed it, or fill in with some 3in. combs of honey as soon as I see others empty. I could take them outside once a fortnight on a fine day for cleansing

flight. Do you think this idea practicable, and if you do not, would you kindly explain its faults?—C. R., Wembley.

REPLY.—Your plan is not practical, as you would place the bees under unnatural conditions. They should have a rest from work during the winter.

[8221] *Various Queries.*—(1) Can you tell me where to obtain working drawings with full measurements of standard hives and other apparatus? Might not the "Guide Book" be made even more useful than it is (at least to amateur carpenters) if *all* the illustrations included the principal dimensions? (2) I want to start an "Observatory" hive, but can only have it in a room on the first floor, the sill of the window being some 12ft. from the ground. Is this too high? Of course I want the bees to fly and work properly. (3) When is the best time of year to start a small colony like this? (4) How should one treat shallow-combs of honey, small portions of which are not sealed? Ought the unsealed to be extracted first? I have some combs where the unsealed honey is already fermented. What can I do with them?—J. W. P., Moseley.

REPLY. (1) You can obtain from this office "The Bee-keeper's Note Book," in which full working drawings are given. Even the pages of a text book have their limits, especially as the book is such an inexpensive one. (2) Bees are sometimes kept about the third storey or on roofs, so yours will be all right. (3) Start in the spring. (4) Extract the unsealed honey first, and ripen it before bottling. The fermented honey should be extracted and boiled for bee food.

[8222] *Preparing Microscopic Objects.*—I should be greatly obliged if you would give me the best preserving medium for the following parts of the bee's anatomy in microscopic coll slides. (1) Alimentary canal or parts of it. (2) Nervous system. (3) Circulatory system. (4) Tracheal system. (5) Eye. (6) Limbs, legs, &c. (if necessary).—GEO. STEVENTON, Bisley.

REPLY. (1) (2) (3) (4) Glycerine; (5) and (6) Canada balsam.

[8223] *Beginner's Queries.*—A swarm of bees came off one of my hives at the beginning of July while I was away from home, and they were hived in a skep, where they still remain. Would you advise me to transfer them to a frame-hive now, or to wait until the spring? If I leave them in the skep will they need reeding, and how shall I protect them from cold during the winter?—A BEGINNER, Kent.

REPLY.—You must leave them in the skep until the spring. You are in a better position to judge of their need of food than we are, but there is little doubt but

that they will have plenty of stores. The skep should weigh about 30lb.; if it does not, then feed.

## Notices to Correspondents.

J. H. (Slaithwaite). *Pressing Heather Honey.*—If not worth your while to invest money in a press, get one of the small potato-mashers, sold by all ironmongers, which forms an excellent substitute. These small hand presses are usually illustrated in bee appliance makers' catalogues.

G. L. G. (Hereford). *Bee Parasite.*—The insects are *Braula Caca*, or the blind louse, a parasite which sometimes infests queen and workers. They have been especially troublesome this season on account of the warm weather. Blow tobacco smoke into the hive, and then lift it off the floor-board; the lice will be found to drop from the bees on to this, and can then be brushed off and destroyed. The floor-board should be washed with disinfectant. These insects usually die out in winter, but as they irritate the bees very much, it is best to try to destroy them.

CLOISTERS (Abergavenny). *Dead Bees in Hive.*—There is evidently some small space through which the bees crawl, and cannot find their way back again. Those sent have died of starvation.

J. H. H. (Fulham). *Dead Queens Cast Out.*—The old queen is injured, and is of the ordinary black variety. Of the others, one is a hybrid, and has her wings injured as if she had been bailed. One other is a scrub-hybrid, and the remaining one has all broken to pieces, so we can say nothing about her. Examine the hive; in all probability there is a laying worker present.

G. J. C. (Oxford). *Immature Bees Cast Out.*—You should join the County Beekeepers' Association. The Secretary, Mr. H. Turner, Turl Street, Oxford, will send particulars if you write him. From your description of the condition of the stock, we should say that the bees are short of food, so it will be best to feed them. It may be that the brood has become chilled during the cold nights.

E. A. B. (Ruthin). *A Beginner's Query.*—Your difficulty is not very clear. You have prevented swarming by giving plenty of room for the bees to work: that is the right method with modern hives. It is now too late for the bees to give more surplus. You should requeen now with a native queen. The skep-question is rather mixed. Kindly write again, telling us exactly what you want to know. You do not say whether you have a skep already, or if you are

going to buy one. Do you wish to know if the best way of hiving driven bees is by putting the skep on the top of the frames?

#### Honey Samples.

- G. S. (Wattisfield).—Sample is good in colour, density fair, the flavour rather acid. It is worth about 50s. per cwt.
- J. H. H. (Twickenham).—A light honey from clover and lime; flavour good and density excellent.
- E. J. LEWIS (Dolafon).—A very nice sample of almost pure heather honey. It is a pity you did not try to sell it, as you might have disposed of it with advantage. The flavour of heather honey is always strong, but it is considered a great delicacy, and it brings a better price than any other kind of honey. We should not call the taste "bitter," it is merely the characteristic heather flavour. Thank you for your kind appreciation of the "B.B.J."
- J. H. T. (Hull).—Very probably you are right as to the source of sample A, as there is a distinct flavour of Hawthorn, but it is a mixed honey. It is good in all respects, except density, which is only fair. B is also too thin—worse than A in this respect, and in flavour it is not so good. Both are good in colour. The only precaution against granulation you can take is to keep the honey in a *warm, dark* place—the corner of the kitchen should not be too warm. It is impossible to prevent some honeys from granulating. Too great heat will cause fermentation.
- E. (Cheshire).—A very good honey in colour, flavour, and consistency. It would be improved by more careful straining. It already shows slight signs of granulation.
- M. M. (Chorlton).—Sample No. 1 is from clover. Good in all points except density. It is suitable to show locally. No. 2 is from clover and lime; very good on all points, but it requires clearing before being fit for show. No. 3 is partly from ragwort, and not of nice flavour, though good in all other respects. No. 4 is similar to No. 1, and No. 5 has the same characteristics as No. 2. Shallow frames can be used indefinitely, as they are not used for brood-rearing. We have seen them in use for over twenty years.
- Suspected Disease.*
- ANXIOUS (Belford).—It is a case of foul brood. Use "Apicure" in the hive, and no doubt in spring you will find all is well.
- T. D. (Merthyr Tydvil).—We cannot see any trace of disease. The bees are of the English variety.
- H. E. (Handsworth).—We cannot find anything wrong with the bees. The cause of the trouble is fighting. You

should have removed the old queen at least twelve hours before the new one was put in.

#### Special Prepaid Advertisements.

**Two Words One Penny, minimum Sixpence.**

Orders for three or more consecutive insertions entitle advertisers to one insertion in "The Beekeepers' Record" free of charge.

Trade advertisements of Bees, Honey, Queens, and Bee goods are not admissible at above rate, but will be inserted at 1d. per word as "Business" Announcements, immediately under the Private Advertisements. Advertisements of Hive-manufacturers can only be inserted at a minimum charge of 3s. per ½ in., or 5s. per inch.

#### PRIVATE ADVERTISEMENTS.

**H**ONEY, finest Hampshire, 58s. per cwt., 28lb. tin, 15s., tins returnable or charged; sample 3d.—OWEN BROWNING, Ashley, Kingsomborne, Hants. n 36

**E**XTRACTED ENGLISH HONEY, 12s. 6d. per 28lb. tin, sample 2d.—DUTTON, Terling, Essex. n 179

**F**OR SALE, 3½cwt. finest Wiltshire Honey, 55s. cwt.; tins and crates free; sample 2d.—WHITE, Gas Works, Wilton, Wiltshire. n 30

**S**URPLUS BEE APPLIANCES, all new.—Bee House 16 by 6, in sections, red tongued board, felt-covered roof, holds 36 Stocks, complete with shelves, porches and ventilator, £10 on rail; similar house, holds 15, £7; body boxes, with ten Standard frames and starters, complete, 3/-; with glass panel, 3/6; supers, with ten standard wired frames, drawn out combs, 4/6; ditto, with starters, 2/6; Standard Excluder zincs, 6d. each, four for 1s. 9d.—LEA, Moreton, Dorchester.

**F**INEST HAMPSHIRE HONEY, about 5cwt., light extracted, for sale, price, in 28lb. or 56lb. tins, 7d. per lb. cash, tins free.—STEPHEN TEMBLETT, Andover.

**E**XTRACTOR WANTED, secondhand; description and lowest price.—TAYLOR, 137 Kelgate, Beverley. n 27

**F**OR SALE, 3½cwt. pale Extracted Honey, 60s. cwt.; 10 dozen Sections, glazed, 8s. 6d. dozen.—COOK, Barton Mills, Milnehill. n 26

**1000** LB. Splendid Light Clover Honey, sample 3d., 58s. cwt.—ALBERT COE, Apiary, Ridgewell, Halstead, Essex. n 25

**B**EST quality Clover Sections, 9s. dozen; seconds, 8s., packed and on rail.—BARNES, Clogger, Wigton. n 24

**12** YOUNG CANARIES for sale, six cocks, six hens, £2 lot, or sell separate, cash with order.—A. JACKSON, Elveden, Thetford. n 24

**H**ONEY, well ripened, good flavour, 58s. per cwt., on rail, tins free; ½lb. sample six stamps.—J. IRELAND, Vernham, Hungerford, Berks. n 22

**N**OTICE, to save postages.—Bees and Appliances sold out.—VICE, Thrussington. n 21

**S**EVERAL cwt. good Extracted Honey, mainly clover, for sale, whole or part; sample 3d.; also Sections.—H. SPARKES, Clute, Andover.

**G**OOD EXTRACTED HONEY wanted; give particulars and price.—HEAP, Rowley-road, Reading. n 19

**D**RIVEN BEES.—Wanted, a few lots, with young Queens.—Price, &c., to WOOD, Old Aylestone, Leicester. n 17

**F**OR SALE, 18st. Honey, in 2st. tins, 7d. per lb.—W. H. MARTIN, Newyork, Lincoln. n 16



## Editorial, Notices, &c.

### CAMBRIDGE MAMMOTH SHOW.

The bee and honey section of the above show, held on August 7th, at Cambridge, proved to be one of the finest honey displays ever seen in the county. The entries numbered 153, and amongst them were no fewer than eighteen names of prize-winners at the Royal Agricultural Show at Norwich in June last. All the classes were open to Great Britain, and the exhibits, which came from all parts of the country, were generally of such excellent quality that the judges, Messrs. R. Brown and Allen Sharp, had a difficult task in deciding on the best, and indeed in two of the classes they admitted that every exhibit was worthy of a prize. The promoters are to be congratulated on the excellent arrangements, which greatly contributed to the success of the show. The awards were as follows:—

*Display of Honey.*—1st, R. H. Baynes, Bridge Street, Cambridge; 2nd, W. Barnes, Exning, Newmarket; 3rd, F. Humphrey, Comberton, Cambs.; v.h.c., J. Short, Garden Walk, Cambridge.

*Twelve 1-lb. Sections.*—1st, W. Jarman, Royston, Herts; 2nd, Edgar Brown, Fulbourn, Cambs.; 3rd, S. P. Soal, Rochford, Essex; v.h.c., Jas. Lee, Fulbourn, Cambs.; h.c., R. H. Baynes.

*Twelve Jars, Light Colour Extracted Honey.*—1st, Rayner and Moisey, Newmarket; 2nd, A. C. Jackson, Elvedon, Norfolk; 3rd, W. S. Holford, West Wrating, Cambs.; v.h.c., F. Long, Bury St. Edmunds; h.c., R. W. Lloyd, Thetford, Norfolk.

*Three Shallow Frames for Extracting.*—1st, S. Sanderson, West Wrating, Cambs.; 2nd, Jas. Lee; 3rd, Edgar Brown; v.h.c., A. Barber, Comberton, Cambs.; h.c., R. H. Baynes.

*Six 1-lb. Sections.*—1st, W. Barnes; 2nd, Edgar Brown; 3rd, R. H. Baynes; v.h.c., C. W. Dyer, Compton, Newbury; h.c., A. Alderman, Babraham, Cambs.

*Six Jars, Light Coloured Extracted Honey.*—1st, S. Sanderson; 2nd, W. S. Holford; 3rd, R. H. Baynes; v.h.c., F. Humphrey; h.c., W. Hall, Fulbourn, Cambs.

*Single 1-lb. Section.*—1st, A. Alderman; 2nd, H. W. Saunders, Thetford, Norfolk; 3rd, A. Barber; v.h.c., S. Sanderson.

*Single 1-lb. Jar of Honey.*—1st, A. C. Jackson; 2nd, W. Barnes; 3rd, S. Sanderson; v.h.c., W. S. Holford; h.c., C. Daniels, Balsham, Cambs.

*Bell-Glass.*—1st, R. H. Baynes; v.h.c., W. Barnes.

### SPECIAL PRIZES.

*Observatory Hive.*—1st and Certificate of Merit, Jas. Lee (Hybrid Bees); 2nd and

Certificate of Merit, R. H. Baynes and Co. (pure Italians).

The "Small Holder Clock" was awarded to R. H. Baynes for the largest number of points.—*Communicated.*

### AMONG THE BEES.

#### SYSTEM.

*By D. M. Macdonald, Banff.*

Go to the ant, thou sluggard, and learn from that tiny insect how to labour. Go to the bee-hive, thou bee-keeper, and learn from the system of labour and government there displayed how thou mayest carry on thy occupation with a minimum waste of time and expenditure of tissue. System is the secret of success. No bee has to waste time discussing who is to carry out certain operations, for each tiny toiler sees where work is required, and straightaway goes and does it with all its might. Some would fain try to convince us that the operation of fanning is carried on in a haphazard way, and that there is no regular relieving of the guards or fanners. That is the result of man's shortsighted and unscientific observations. Relief comes, or the fanner, when worn out by its toilsome labours, clears out, but only to be replaced by several successors each eager to step into its comrade's place; when the necessity arises fanners are always there. In like manner, however long the guards may be on duty, a sufficient number will always be found in position, and in the right position to spy strangers, and evict them if necessary. Nay, if summary execution is to be meted out to intruders the two, three, or half-a-dozen evicting the would-be intruder have their places at once filled by relief guards. The same principle holds good in all the internal working of the hive. Every operation is carried out expeditiously and well.

System in apicultural operations leads to economy of both time and money. The labour is lightened, more of it is overtaken in a given time, and the necessary operations are carried out at the right time—not half-a-day, half-an-hour, or even half-a-minute too late. In bee-keeping this feature cannot be over-estimated. Do things, but do them at the right time. Solomon Slow had the knack of doing everything five minutes too late. This in apiculture would mean for most operations that the time had passed for the necessity of carrying out the work. Spending time over the operation would bear comparison with the proverbial process of trying to gather up spilt milk.

With this preamble let me consider several features of bee-keeping wherein system may mean success or the want of it failure. In a model apiary lately noticed I was much struck with the

arrangements made whereby every tool and implement was always at hand when required. It was all a question of system as against a lack of it. There was a place for everything and everything was at once returned to its proper place when it had performed its duty for the time being. Think what a time-saver this must prove when several individuals at different times handle these tools. No hunting about is necessary; no querying of where a certain article may be found is required; there is no delay in carrying out the required operation, because the means are there at hand.

How few bee-keepers know the contents of each hive from year to year? Yet if success is to be made certain everything connected with every colony should be systematically recorded consecutively from start to finish. This introduces the question of some kind of record being kept, with the life history of the community contained in each domicile written down in brief. I need not pause to consider the best system, whether card, slate, book or complicated index cards, each bee-keeper can decide which suits him best, but let him have some definite record of the doings of each colony in his apiary.

Begin in early spring systematically to plan and carry out a definite line of action as to your apicultural proceedings during the season, and endeavour as much as possible to adhere to its details. Don't carry on the pastime or pursuit spasmodically. Conducted by fits and starts it is not likely to prove a profitable undertaking. It requires a little more than periodic enthusiasm, and this constant ardour a love for the bees and the hobby will undoubtedly beget and sustain. "I like my job," a President of the U.S.A. said of the strenuous work his duties entailed, and this in a small way explains how some people can make a success of bee-keeping, while others make a muddle of it and give up because bee-keeping does not pay. It does and it doesn't, but in either case the reason is in ourselves and not in our "stars." System must pervade our every act during the whole season. The spring cleaning, the renewal of defective brood-combs, the timely preparation of section cases, the seasonable placing of these on the hives and their gradual increase during the season, the withdrawal of full cases, the preparation of the finished article for the market, and its sale at a reasonable price all require system. None of them will be efficiently carried out if gone about spasmodically, or if done in a haphazard way. No other subject in bee-keeping, however, requires to be gone about so systematically as the preparation for safe wintering. Each step must be attended

to most carefully. The queen, the bees, the stores, the hive, the packing, must all be tested and proved. No true bee-keeper should grudge the thorough and precise investigation on each of these heads before putting the bees up for the winter. Remember that on its thoroughness depends mainly the condition in which each stock may be found after nearly six months' semi-liberation while they are confined to the hives, with occasional flights, during the period from 1st October up to the end of March.

Study your "Guide Book," your "Journal" and "Record," on a definite system. From the bee-papers you may read extract all the "nectar" you can on each feature of bee-keeping. Take, for instance, "swarming." Group all your facts under that head in such a way that they will be available at the desired moment.

---

#### NECTAR PRODUCING PLANTS AND THEIR POLLEN.

By *Geo. Hayes, Eerston, Notts.*

(Continued from p. 304).

*COLTSFOOT (Tussilago farfara).*

NAT. ORDER. *Compositae.*

The presence of this flower betokens stiff or poor soil, and on cultivated ground it is looked upon as a noxious weed, very difficult to eradicate, resisting the most desperate attempts to dispossess it. For all this, I hesitate to assert that its influence is wholly bad, for where—as for instance in a hedgerow, on a railway embankment, &c.—the ground is not under cultivation its presence is a decided gain, as it spots with its golden stars and afterwards clothes with its verdure many a piece of ground that would otherwise look poor and bare. To this must also be added its nectar and pollen-producing qualities—for it yields well of both—and its medicinal service, which is by no means insignificant.

The flower stems, bearing numerous scales, and covered with a loose, soft down, rise erect and directly from the ground to a height of 6in. or 8in., the summit of which is crowned with a solitary single flower-head of a pale golden hue, which opens only when the sun is shining. When all the florets have bloomed it closes up tightly, and the stem bends downwards, the decaying bloom assuming a pendant position for the purpose of warding off the rain, but as the seeds ripen the stems stiffen again into the

erect position, now bearing on its summit a globular head of winged seeds, similar to the dandelion, hawkbit, groundsell, and other members of this order, which are dispersed by the wind.

Its flowers may be found through March and April, and increase is obtained by division of its thick, fleshy roots, any small portion of which will usually grow and produce a plant, especially if it is where it is not required. It is also propagated by its seeds, in which it is very prolific: one plant under observation being estimated to produce 22,500 seeds. The struggle for existence is, however, very severe, or we might find all Britain quickly carpeted with Coltsfoot.

The plant is very dis-similar at different periods. In the spring it is a leafless flower, and throughout the summer a flowerless mass of foliage. The leaves are large and of curious angular and toothed form, somewhat heart-shaped in general appearance, but possessing many curves and points. On the underside and on the upper side, whilst young they are coated with a loose, white cotton-wool, which imparts a grey appearance to the foliage.

It is sometimes called *Tussilago folia* (Coltsfoot leaf), because the leaf is something like the imprint of a colt's foot; sometimes *Tussilago florens* (Coltsfoot flower); in this locality it is called Foalsfoot—foal and colt being identical.

Frequently the flowers are gathered, and from them is brewed a delectable wine. An extract of the plant is used in making a candy good for coughs and colds. Its leaves, when dried and mixed with yarrow and roseleaves, makes for some a good British-grown tobacco, which is said to be good for asthma.

This weed supplies nectar and pollen to the bee: its golden stars give pleasure to those beholding them; one may sit and smoke the tobacco it furnishes interspersed with sips of wine: or the more abstemious, or those suffering from throat or lung affections, may take the sweetmeat known as Coltsfoot candy.

The pollen grain of this plant is a most beautiful one, some faint idea of which may be obtained from the drawing; but it cannot convey, even though it were coloured, all that the microscope reveals.

When dry, this grain is oval in shape, having three wide flutings or grooves which reach about two-thirds of its length; and measuring  $\frac{2}{1000}$  in. by  $\frac{1\frac{1}{2}}{1000}$  in. as seen at No. 1, and its enlargement. It is covered with spines, which cause the grains to cling together in masses, and this makes it easy for the bee to load it in her *corbicula* or pollen baskets, and she generally brings home large loads of it packed right up her thigh, the colour of these packages being a light orange.

This pollen grain is seen at its best in water. It then assumes in outline an almost circular form. The grooves swell out, and form three processes, set triangularly, and bearing on its surface a number of facets, which are

surrounded by the spines, which now appear to have broken into a number of filaments; making it appear like a yellow jewel of exquisite beauty, set in a halo of golden light. (See Nos. 4 and 5.)

If it remains long in the water it sometimes develops pseudo-processes, of which I have counted as many as five on one grain.

When preserved in formalin the grains become brittle, and are generally broken

Dry.



In Water.

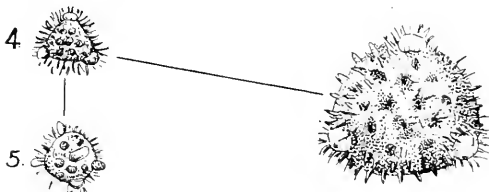

From Formalin



From Honey



POLLEN OF COLTSFOOT.

up; but those remaining whole retain much the same form as when in water. (See No. 6.) No. 7 shows one with a large-pseudo process.

In honey, after a short time, the pollen grain loses its pristine beauty as it becomes saturated with moisture. Its form is not so regular as in water, or when fresh. The processes are much larger, as shown at No. 8 and its enlargement.

It also becomes more triangular in form, and the filaments become clothed, especially round the processes. Its measurement is  $\frac{1}{1000}$  in. from base to apex, and  $\frac{2}{1000}$  in. from point to point.  
(To be Continued.)

## Correspondence.

*The Editors do not hold themselves responsible for the opinions expressed by correspondents. No notice will be taken of anonymous communications, and correspondents are requested to write on one side of the paper only and give their real names and addresses, not necessarily for publication, but as a guarantee of good faith. Illustrations should be drawn on separate pieces of paper.*

### SWARM CONTROL.

[8265] In the number for the 22nd June last (8188) (page 244) Mr. Stapleton described a method of swarm control by the direct introduction of virgin queens, as soon as possible after hatching, by running them in at the entrances of such hives as appeared likely to swarm. He added that his system would work in cases where virgin queens were bought, the only precaution necessary being the removal of the virgin from the travelling cage, and the keeping of her alone, without food, for at least half-an-hour before putting her on the alighting-board in the middle of a fine day.

Mr. Pinkney, in "B.B.J." of June 29th (8195), asked for further information, and particularly as to whether the season of the year affected the result, and how soon after hatching the young queen should be introduced, and whether the race could be changed in this manner with no precautions.

Mr. Marrs explained, in his letter (8199) in the next number, his endeavour to carry out the method, but, I confess that, though I read his letter a dozen times, I cannot make out exactly what happened. At any rate, the virgin seems to have been lost as well as the old queen, but how the experiment would, according to him, have proved a success had it not been for his accidentally destroying the only remaining queen-cell puzzles me. At the most, it shows that the introduction of the virgin led to the loss of the old queen, the destruction of the queen-cells, and the prevention of swarming, but it included the loss of the virgin, too.

In "B.B.J." for July 13th (8211) Mr. Stapleton answered Mr. Pinkney's questions. He advocated, when desirable, the removal of old queens, either in spring or autumn, and, four days after removal, the running in of a virgin, preferably of another race, or, alternatively, the dividing of the stock, and the giving of the virgin to the queenless part, at the end of four to six days, and uniting again when the young queen had begun to lay, taking care to remove the old queen before uniting.

I think I have fairly summarised the whole of the information on the subject that a diligent reader of the "Journal" could gather up to the time I made my own attempts to follow Mr. Stapleton's plans.

On July 20th I selected two hives of blacks, or hybrids, A and B. A had two sets of standard frames and B one set; both had supers. Removing from A the top set of frames, on which the queen happened to be, I put them into a new hive, C, some distance away, leaving a little less than half the stock in A with no eggs and mostly sealed brood. Four days later I ran an extra golden virgin into A—she could not have been more than two or three days old. Although B had a queen, I decided to risk running a virgin into that hive, and did so. Lastly, I removed the old queen from C, made an artificial swarm of the stock, and as the bees were re-entering the hive I dropped an extra golden virgin amongst them, and watched her enter the hive. I found no difficulty in getting any of the young queens into the hives.

In A and B they met with the least possible obstruction, and in C the virgin joined the crowd unmolested. Each had been removed from the travelling cage, kept alone and without food for at least half-an-hour, and the introduction was in the middle of the day when the bees were flying freely. I spread newspapers in front of all three hives.

Now for the sequel. Next morning I found the virgin introduced into B dead in front of the hive. I felt that that loss was quite deserved. Mr. Stapleton's advice to remove the queen and wait four days had not been followed. But A had been treated exactly as he had recommended, and C as advised on page 141 of the "Guide Book," and I saw nothing to lead me to think that these queens had been similarly treated.

Three weeks later I examined A and C. The former was queenless and dwindling rapidly, and C had a native, or hybrid, young queen just beginning to lay.

So my attempts had proved a complete failure. It is, of course, possible that both queens were lost on their mating flight. I wish I could believe it. In the

case of C the virgin must have been got rid of almost at once, and a new queen raised from an egg laid by the old queen before removal.

The system, if practicable in other hands than those of Mr. Stapleton, offers so many advantages that I would willingly try again if he or some successful follower of his method could explain it more fully, and, as far as I am concerned, tell me where I went wrong.—J. G. DALZELL.

#### BEES' WING-POWER v. NOSEMA APIS.

[8266] While it does not appear that the mischievous disease germ has yet been defined, it may be well to consider another matter which has a practical bearing upon the effects of the so-called "Isle of Wight" disease; and that is the wing-power of the bees, as regulated by those extremely important organs, the air sacs and tracheæ.

With bees in central Europe we are assured that the presence of *Nosema Apis* does not result in apparent disease; hence there is no particular reason why it should do so in this country. It is quite possible, with paralysis creeping on as a result of some obscure microbe, that *Nosema Apis*, a very common parasite, should be more in evidence as a consequence.

But the one point that no previous investigator appears to have considered is the fact that bees affected with paralysis may be induced to fly with only a few seconds' manipulation in relieving the air sacs and tracheæ which are congested, so that they are quite useless.

If a bee cannot fly it is, of course, doomed; consequently the method of cure I have offered goes to the root of the trouble, and immediately assists in opening the breathing pores or spiracles of the workers. I am, at this cooler season, recommending all users of my remedy to apply it at a temperature of 100deg., a further aid towards effecting a cure.

The line to be drawn between the sick bees' ability or non-ability to fly is so very fine that the least trouble, such as poisoning, common dysentery, or constipation, as in the present difficulty, affects the wing-power. But in all, even the worst plague under consideration, it rests solely with the bee-owner whether he will restore the power of flight or allow the bees to go to destruction.

With paralysis, whether from local poisoning or the so-called "Isle of Wight" disease, the breathing pores of the bee are choked. The air sacs and tracheæ become inoperative, and consequently the muscles of the wings cannot be used; while the absence of the life-giving oxygen, as well as the necessary pressure that should be

available when the air sacs are filled, is the cause of the constipation and bloated appearance of the sick bee.

When I repeat that these apparently doomed bees (as they first crawl away from the hive) may be induced to fly as well as ever they did—and mark this, before the bowel has been relieved—by a few seconds' manipulation, it will be realised how very slight is the margin between life and death where any sickness affects the air sacs of the workers.

Possibly the bees already leaving the hive should not be saved, but that these may still fly only shows there is really no reason why those remaining should likewise be allowed to follow the same road to destruction: the actual disease affecting the bees cannot therefore be so deeply seated as is generally supposed.

The loss of wing-power, even with those workers that do not appear to be bloated, is now fully explained. Only relieve the sick bees so that they can again use their breathing powers to the full and there is no further constipation, and there are no more bloated bees, because their wings have regained muscular activity; while at the same time the normal pressure of air is assured for the very necessary purpose of expelling the accumulations of the bowel while on the wing. It is just a question of re-opening the congested spiracles and air sacs, when the disease germs, whatever they may be, are defied.

The close relation of the wings to the condition of the air sacs may to some extent account for the dislocation sometimes referred to; but I consider they are frequently injured by the more healthy workers in their well-known attempts to throw the sick members out.

But the few seconds' manipulation! What is that? naturally asks the reader. The most simple experiment possible; yet it results in a great truth. Any unfortunate owner who has bees crawling away from the hive in the helpless way now so well known may pick up one that has recently left the hive. He should then hold it in his closed, *hot, moist* hand for a few seconds, and upon opening it he will observe a very strange occurrence. The bee hitherto struggling helplessly to rise (although in the meantime it has not relieved the bowel) will now fly just as well as ever it did.

The insect may have been attempting to rise while in the full glare of the sun at 100deg.; but dry heat never helped a feverish patient. It requires moist warmth to relieve the parched skin, or in the case of the bee to relieve the dried-up air passages.

Consequently if one renovates the wonderful air sacs of the failing bees he

also restores the muscular activity of their wings; and while not forgetting the necessity of destroying the disease germs, the natural vitality of his little friends is quickly restored. SAM. SIMMONS, Heathfield, Sussex.

#### FINDING QUEENS.

[8267] Referring to D.M.M.'s remarks on finding queens (page 386), novices like myself look with dread on the task, which has from time to time to be attempted, of finding the queen in an ordinary well-stocked hive. It is not the labour that daunts one, but the probable futility of the search. Surely in these scientific days there must be some harmless chemical preparation which can be applied to the back of a young queen before she is introduced to a stock and which will leave such a plain and indelible mark upon her that she can be afterwards readily found. There are several preparations which will mark, without harm, animals, not excluding human beings, and I should certainly think there is something that can be as well applied to bees—only it has to be found. Perhaps some of our chemist bee-keepers will be so kind as to bring their knowledge to bear upon this problem, the solution of which will be a boon to their fellow honey-growers. —A. E. B., Northfield.

#### BEES COLLECTING OLD PROPOLIS.

[8268] Although bee-keepers are generally interested in the collection of nectar and pollen by bees, I do not think that the collection of propolis attracts their attention so much.

I have occasionally observed bees collecting propolis from the buds of plants, &c., and very often have cause to remember how they seem to overdose the ends of frames in their endeavours to stop up every crevice.

Quite recently, while on a visit to an apiary, I had an interesting example of how bees gather old propolis. Some queen-excluders, having been laid aside for cleaning purposes, had attracted the attention of several bees, and on watching their movements I found they were removing the old propolis and carrying it away. It was an interesting study to see the bees tearing away piece after piece with their mandibles. The energy of their whole body seemed taxed to its uttermost in pursuing the task. Their position (resembling a dog with a bone) was amusing, but the rapidity with which they transferred the propolis from the mandibles to the pollen-pocket was

startling, and it was some time before I could detect how it was done.

As soon as the mandibles wrenched off a piece of propolis the front leg took hold of it and carried it on to the hind leg. This done, the middle leg tapped it into position, whilst the mandibles went to work again. The size of the pieces varied; sometimes the bees would load up with two pieces, but at other times it took several pieces to make a load.

I believe that for bees to use up old propolis in this way is very unusual, and probably it is only done when natural supplies are scarce. Perhaps the drought had something to do with this. It would be interesting to know if any other reader has observed a similar occurrence. I dare say it will be useful to some to know that washing the fingers in methylated spirit will remove propolis stains.—J. PRICE, Staffs.

#### SENDING HONEY BY POST OR RAIL.

[8269] The following may interest bee-keepers. The other day I went to the Post Office to send off one  $\frac{1}{2}$  lb. screw-top jar of honey to a friend. I said to the attendant, "Will this go all right?" Her reply was, "Oh, yes, if I place the Post Office label marked 'Fragile' on it." "But," I said, "what if you bring down the stamp with a bang on it?" Again she replied, "I will stamp the ticket before I paste it on." The consequence was it arrived all right at its destination. A few days afterwards I went to the railway station to send off four jars, and told the porter I had written "Fragile" on it. He said, "You had better pay 4d. more and let it go at the Company's risk." I paid 8d. at my risk, and said, "Surely if I put 'Fragile' on a parcel well packed in straw you don't throw it about like you would a stone; moreover, it is only going forty miles, I will risk it." Now, I ask how is it the Railway Company, like the Post Office, have no official labels to paste on to make their porters more careful? Why should bee-keepers have to use tins for extracted honey, or place their sections in biscuit tins to satisfy the carelessness of railway porters? A train draws up, a parcel is thrown into the van like a brick, and if it contains honey jars, even well packed in cardboard boxes and straw, the question is, Will it stand the rough treatment porters mete out to luggage of any description? They are careful enough when a parcel goes at their Company's risk. Station-masters and guards should call the porters to account when they see them careless.—C. W., Barnstaple.

[In sending parcels of honey or any other fragile article through the post it

is advisable to put a tie-on label with the address and also stamps; in this way all risk of breakage by stamping is avoided, as the label must be laid on the table to stamp and the parcel is not touched. Railway companies do supply a red label marked "Glass with care," which can be put on fragile parcels. The postal authorities do not always deliver parcels intact although they have a fragile label on them, as the many broken packages of honey which reach us amply testify.—Ed.]

#### CAPPINGS OF COMB.

BY L.S. CRAWSHAW, NORTON, MALTON, YORKS.

*Sugar-feeding and Disease* (p. 335).—I am not quite able to reconcile Mr. Simmins' assault upon "A Roman Bee-keeper" with his known views upon the origin of disease. If I have rightly understood Mr. Simmins, he believes that, whilst microbes may transmit disease, they do not cause it, but that the origin of disease is to be found in a lowered vitality. (*Vide* Micro-organisms not the Origin of Disease, pp. 109-129. Modern Bee Farm, 1904 edition.) Something akin to this would appear to be the argument of the writer on page 305, *i.e.*, that sugar, being an imperfect food, causes a lowered vitality which results in disease. Unlike Mr. Simmins, I do not understand him as asserting that sugar directly produces disease. It would be well if, in such discussion, direct and indirect cause were clearly defined. Now, a perusal of Mr. Simmins's writings warrants the assumption that he disbelieves in the direct micro-organic causation of disease. Here he appears to occupy a fresh position (*vide* paragraph 2), where he postulates that an infectious disease must be derived from a diseased source. Is it possible that he has advanced his views? And is it not apparent that reconciliation of these various views is to be found in the modern belief that micro-organisms are ubiquitous, but only multiply, as in disease, when a suitable situation occurs? I am not to be understood as asserting that sugar does lower the vitality of bees, although I am inclined to the opinion that it does do so where they have work to perform. However satisfactory it may be as a winter ration, it is inferior to honey as the basis of brood food, as witness the inferior queens reared upon a sugar diet. Nor am I prepared to admit that beet sugar is always an unsuitable food. I have not found it to be so. But there may be winters when the difference between cane and beet sugar is strikingly apparent, as there may be summers when the difference in value between honey and sugar syrup calls serious attention to itself.

*The Bee-keeping Grant* (p. 342).—I have not the pleasure of knowing Mr. Ernest E. Williams, and it is perhaps as well, since he appears to be a gentleman with a grievance, and this class is distinctly dangerous. But as up to the time of going to press Mr. J. B. Lamb appears to have escaped slaughter, I venture also, tremblingly enough, to utter a word of criticism. Mr. Williams's argument would be pathetic if it were not so ludicrous. For, as Mr. Lamb clearly shows, the grant will not, or at least not solely, go into bee-keepers' pockets. Even did it do so, it is nonsense to talk of taking £500 from the general body of taxpayers, the bee-keepers themselves, presumably, failing to contribute. It is perhaps a little late in the day to talk of brigandage in connection with taxation! Be that as it may, it is at least certain that bee-keepers contribute £500 to general taxation, whilst on the other hand it is likely that at least £500 is devoted to purposes of which the contributors disapprove. It may even be that some of them strenuously disapprove, and were it not that they are—being bee-keepers, and as such continually learning lessons from the economy of the hive—an extremely docile class they might voice their protest against grants which benefit other sections of the community, did they not clearly realise that such moneys are in circulation to-day and invested for tomorrow. But, dire as he may consider our tribe, it is to be hoped that Mr. Williams will appreciate the force of our diatribe, and not see fit to join the noble army of passive resisters and refuse to subscribe towards such a shameful misuse of his hard-earned moneys, lest he die a tribal death at the weapons of infuriated bee-keepers and their bees! Dear me! one might imagine from the foregoing tirade that I was a lover of that arch tax-gatherer who hails from Taffydom and reigns in Merrie England!

*At the Moor* (p. 244).—It is evident that Othello lives in the midst of heather-land, for he speaks of manipulation of the supers during the flow. Such work is beyond the power of those of us who travel nearly twenty miles to the ling, and whose bees never satisfactorily occupy more than one super when there. This year of blessed memory the heather flow was all too short to satisfy even those modest beemen who are more than content with one full super per hive.

*Drone v. Worker Foundation* (p. 345).—The arguments used by Mr. Harris in his advocacy of worker combs for extracting are not very convincing. Anyone who has extracted from both varieties knows the difference in favour of drone comb. It is not clear either why worker combs, presumably produced from full sheets of

foundation, should be transferred from shallow-frames to standard frames. If swarms be hived upon them, surely they may continue to live upon them. But why hive upon them at all? I am convinced that hiving swarms upon combs results in a loss. Here are bees ready and willing to build comb, and the bee-keeper should take advantage of their instinct. As to show purposes, it is by no means certain that judges prefer drone comb in sections, as suggested. The only instance in which it might be favoured would be in the case of a shallow-frame exhibit. Personally, I do not care to extract honey from brood-combs, and if such shallow brood-combs be mixed with section frames, dark sections are sure to result from the borrowed wax.

## Queries and Replies.

[8224] *Liability for Damage Done by Bees in Transit.*—(1) Can you tell me the present value of the original 1808 edition of Hubers' work on bees (English translation)? (2) I presume I am responsible for injuries caused by my bees to persons or animals during their transit to and from the heather, and also while they are located at the moors. Is this risk covered by the B.B.K.A. Insurance Scheme, and, if not, could it be included by payment of an extra premium? (3) Will you kindly give your opinion on the source and quality of enclosed two samples of honey, and say whether you consider them fit for show?—A. B., Bishop Monkton.

REPLY.—(1) Its value is about 2s. 6d. (2) There is no doubt you are responsible for damage caused by your bees in transit. We are under the impression that the insurance of the B.B.K.A. does not cover this risk; it cannot be covered by extra payment. The new location at the moors must be insured as well as the one at home. (3) A is a good clover honey, though lacking a little in density. B is a good heather blend. Both honeys will do to show locally.

[8225] *Best Hive—British Golden Bees.*—(1) Which is the best hive for securing large quantities of honey? (2) What is the general opinion of the "British goldens" from those who have had experience of them? (3) I have a British golden queen (hardy and prolific), and I am going to breed from her next year. Should I mate the young queens with her own (golden) drones or with black? (4) Also mating black queens with golden drones. Would the cross be good in either case?—F. H. W., Ashstead.

REPLY.—The W.B.C. hive is admitted by all practical bee-keepers to be the best for general use. (2) Opinions vary very much. (3) It is best to keep them pure, but you must not inbreed if you can possibly help it. (4) We do not advise hybrids of any kind, for, though good workers, they are usually very vicious.

[8226] *Using Drone-foundations for Swarm.*—Supposing, in the early swarming season, I prepared a hive of ten frames with full sheets of drone foundation, and put into it a good strong early swarm containing a young tested fertile queen, would the bees persist in building out the lot into drone cells, and the queen in laying nothing but drone eggs, and this most intelligent insect persist in committing *fo-lo-de-se*?—G. C., Sheffield.

REPLY.—If you try the experiment as we have done you will find the bees will either tear down the foundation and build worker cells, or they will build worker cells upon the drone base foundation.

[8227] *Wintering Bees in W.B.C. Hive.*—(1) Is there any advantage in making use of the 3in. eke for wintering? When should it be put in, and when removed? I take it the body-box or brood-chamber is removed bodily, placed on a table, the eke put in its place, and the brood-chamber returned. (2) I have closed the entrances as far as they will close on account of robbing some weeks ago. Shall they remain thus all the winter? There is room for about three bees to pass in abreast. (3) With this W.B.C. hive is it necessary to pack round the sides or not?—T. P., Ipswich.

REPLY.—(1) The advantage of an eke is that it provides ventilation, also space for the dead bees in the winter. It should be put on as you suggest when packing down for the winter and removed on the first manipulation in the spring. (3) When all danger of robbing is over, open to about four inches. (4) It is not necessary to pack round the sides.

[8228] *Transferring from Skeps.*—(1) Can I be sure of a fertile queen when bees are alive in cells? (2) Would bees destroy a virgin queen and destroy queen cells if bees were robbing and fighting with one another? Thanking you for your wonderful help through the BEE JOURNAL.—J. T. HESLOP, Whitley Bay.

REPLY.—(1) Not absolutely; you should look for eggs to be quite certain of a fertile queen being present. (2) Yes.

[8229] *Is it a Fertile Worker?*—During the very hot weather every frame in the brood-box of one of my hives broke down except one, the queen and thousands of bees being destroyed. Having put the hive in order again the remaining bees raised another



queen, which was duly hatched out of her cell; but although I have looked over the hive several times since I noticed that she had emerged, about a month ago, I have not been able to find her. The bees have worked out new comb from foundation and accumulated stores. There is no worker brood in the hive, but there is some drone comb containing eggs and larvæ in different stages, some sealed over. I have taken out the enclosed piece of comb, and should be glad if you can tell me: (1) Have the eggs in this been laid by a queen or a fertile worker? (2) Is it usual for a considerable number of bees to carry and store pollen in a queenless hive? (3) If a frame containing brood from another hive was introduced into a queenless hive containing drones would they rear a queen from the same, and would she become fertilised if reared at this time of the year?—A. EDGE.

REPLY. (1) By a fertile worker or an infertile queen. (2) It is not unusual, but in your case they would be sure to do so, as brood is being reared. (3) They would rear a queen, but it is now too late for her to be fertilised.

[8230] *A Novice's Queries.*—I enclose a few bees which were imprisoned among the quilts in one of my hives. (1) My reason for sending them is for identification of the breed as I would like to know what breed they are, and if a good one? I bought a swarm of these bees on June 15th, covering six or seven frames. For some time after they reached me the weather was wet, so I fed them with syrup, and about the middle of July put in all frames, making ten, which were soon filled up. I also put on at that time a rack of sections with full sheets of foundation in each. By the second week in August the super was packed with bees, while on August 14th a swarm issued from the hive and settled on a tree quite near. As I never anticipated a swarm from a first swarm of that season I had no skep ready, so it was 9 p.m. when I began to hive them, which I did into a skep. I then placed it (the skep) on a sheet with a stone under the edge and brushed all the remaining bees off the branch on to the sheet, from which they quickly ran into the skep. As it was getting dark I left it covered over with cloth where it was till next morning. I was up at day-break and found the bees all safe in the skep. I hived them into the bar-frame hive as soon as I could, and on lifting the quilt a few days afterwards found they covered the ten frames. (2) Was that swarm not large and exceptional, for such a short time? to come of a first swarm, I was afraid of returning them to hive in case they should swarm again, and as this is my first season at bee-keeping I

did not venture to open up the hive and cut out all the queen-cells. After the swarm issued, I examined the sections and found the foundation all drawn out—this work being practically done in ten days (3). If I had put on a second rack do you think that would have prevented the swarm? Since the swarm issued the bees are very cross, and seem to resent the presence of anybody near them, while before swarming they never minded anybody. (4) What accounts for their change of disposition? Notwithstanding the swarm, some of the sections were being sealed over, so I placed the first rack on top and put an empty one below it, so that there should be plenty of room. When I have started to feed the swarm I found they had commenced sealing some of the frames at the top. I want them to be strong for the spring. I am studying Cowan's "Bee-keepers' Guide" just now, and find it very instructive. I am also taking in the BEE JOURNAL. (5) What do you think of this district which yielded swarms in May? Is that a sign of productivity in honey? (6) When is the right time to remove all sections?—U. D. A., Ross-shire.

REPLY.—They are ordinary British bees. (2) This is unusual in an ordinary season, but not this year, which has been exceptionally favourable. (3) Yes, but you should have put on the second super earlier. (4) The change in temper is probably due to the queen being mated with a drone from a colony of bad disposition. (5) The district is a very good one judging from your experience. (6) As soon as the honey-flow is over.

---

## Bee Shows to Come.

---

Oct. 31 and Nov. 1, at Brighton. Sussex B.K.A. Show in connection with the Brighton and Sussex Horticultural Society's Chrysanthemum Show. Free Open Classes. Schedules and Entry Forms from C. A. Overton, Beecroft, Crawley, Sussex. Entries close Oct. 24.

---

## Notices to Correspondents.

---

B. E. B. (Cobham).—*Value of Book.*—If you can give the correct title, name of author, date and condition of book, we would be able to give the value. We do not know of a seventh edition of "Female Monarchy" published in 1741. "The True Amazons: or the Monarchy of Bees," by J. Warder, seventh edition was published in 1742. It is probably this book that you allude to.

S. C. S.—*Observatory Hive out of doors.*—If out of doors you must provide a shelter of some kind to go right over the hive to keep it dry and warm. It will be much better if you can

- arrange it indoors with a passage through the window sill. The shutters should not be off for more than an hour at a time.
- H. T. (Pontypool).—*Disinfecting Combs*.—You can disinfect without destroying by means of formaldehyde, to be obtained from this office with full directions post free 1s. 6d.
- J. H. MEYER (Fullham).—*Suspected Queenlessness*.—From your description we should say there is a young queen present. The fact that the bees have not killed off the drones points very strongly to this condition. If a worker is laying the brood in worker cells will be sealed with a drone capping; if not, and there are eggs and brood the queen is all right. Make a thorough examination and if you are satisfied they are queenless do not wait until the spring, but re-queen at once.
- I. A. N. (Higham).—*Amount of Wax and Honey in Section*. There is about one ounce of wax, and anywhere from thirteen to eighteen ounces of honey.
- J. T. S. (Co. Cork).—*Drone Foundation for Worker Cells*.—When they require them the bees will wax down worker-comb to build drone cells, usually at the bottom edge of corners. In the case of a swarm full sheets of worker foundation usually result in nothing but worker-comb being built.
- J. WHITE (Hepscott).—*Candy Making*.—Receipts for soft candy making are given on page 195 of "Bee-keepers' Guide Book," 1s. 8½d. post free from this office.
- J. S. (Fife).—*Name of Plant*.—The sprig of bloom sent is the true ling (*calhuna vulgaris*) from which heather honey is gathered.
- Honey Samples.*
- J. H. W. (Mold).—No. 1 is a good sample and worth 1s. 6d. per jar retail. No. 2 is from clover, rather thin, good in every other respect, and worth 9s. 6d. per dozen jars.
- L. S. W. (No. 1).—No. 1 is a good medium honey and is quite fit to put up in bottles and should fetch 7d. per lb.; it is from fruit, and good in every respect. No. 2 is from sainfoin, good in all points and worth at least 9s. 6d. per dozen.
- H. (Pewsey).—Colour good, density excellent, mainly from clover.
- A. H. B. (Cheltenham).—A well-ripened honey from clover with a very slight trace from the limes. Of good colour, aroma, and flavour.
- Suspected Disease.*
- X. Y. Z. (Beckenham).—Bees were very dry, but from what we could see they are suffering from "Isle of Wight" disease; better destroy at once.

G. W. S. (Bristol).—The bees you sent are suffering from malignant dysentery; destroy at once combs and all, and disinfect the hive before using again; sweep up and burn all dead bees.

J. S. (Haycroft).—The bee was much too dry for us to diagnose any trouble.

### Special Prepaid Advertisements.

**Two Words One Penny, minimum Sixpence.**

Orders for three or more consecutive insertions entitle advertisers to one insertion in "The Beekeepers' Record" free of charge.

Trade advertisements of Bees, Honey, Queens, and Bee goods are not admissible at above rate, but will be inserted at 1d. per word as "Business" Announcements, immediately under the Private Advertisements. Advertisements of Hive-manufacturers can only be inserted at a minimum charge of 3s. per ½ in., or 5s. per inch.

### PRIVATE ADVERTISEMENTS.

**STOCKS OF BEES REQUIRED**, any quantity, with or without hives, cheap for cash.—**TALBOT**, 7 Stafford-road, Brighton. n 56

**FOR SALE or LET**, a small Homestead in Cambs. of ten acres, suitable for dairying, poultry, and bee-keeping, good supply of water.—For particulars, apply to H., 45, Bunyan-road, Hitchin. n 55

**FOR SALE**, 12 doz. good Sections at 8s. per doz.—**J. BEETCHER**, Abbot's Ann, Andover, Hants. n 54

**CHAPMAN HONEY PLANT**, seeds 4d. packet; two 6d., free.—**REV. ANDERSON**, Northam, North Devon. n 3

**GOOD CLOVER BLIND SECTIONS**, 8s. doz. £8s. gross; cash with order.—**STEED**, Fennes, Baintree. n 50

**1 CWT.** best Hampshire Honey for sale, granulating, on rail, 58s., 25lb. tins, returnable or charged.—**W. B. CORBETT**, Hurstbourne Tarrant, Andover. n 48

**SUPERIOR HONEY**, direct from producer, screw jars, 8s. in bulk, 55s. cwt., tins included.—**TODD**, 2, Springfield Cottages, Saffron Walden. n 45

**HONEY FOR SALE**, in 7lb. or 14lb. tins, 7d. per lb., free on rail.—**THOMSON**, Thurlleigh, Bedford. n 44

**8 DOZ.** 1lb. screw top jars of light coloured Honey, 8s. 6d. per doz; Extractor, cog gear, 18s.; Ripener, holds 1cwt., 9s.; 400 split top Sections, 10s.; 8lb. medium brood foundation, 15s., free on rail.—**L. W. MATTHEWS**, Gt. Rollright, Oxon. n 43

**FOR SALE**, good white Clover Sections, 8s. doz., well packed.—**DAVID HANCOX**, Deddington, Oxon. n 42

**FOR SALE**, several excellent Stocks British Bees, cheap, guaranteed healthy; particulars, stamp; also six young white Ferrets, ready for work, 2s. 6d. each, or 14s. the lot, cash.—**COAKES**, Clent, Stourbridge. n 41

**WANTED**, Heather Sections.—State quantity and price to **S. WHATFORD**, St. Anne's Cafe, Manchester. n 40

**FINEST ENGLISH HONEY**, light and medium, in 28lb. tins, 56s. per cwt; sample, 2d.—**BIGG-WITHER**, Birdwood, Wells, Somerset. n 39

**SEVERAL** cwfs. good Extracted Clover Honey for sale, whole or part; sample, 2d.; also Sections.—**MORC AN**, Aberperdw, Llandoverly. n 37

## Editorial, Notices, &c.

### BRITISH BEE-KEEPERS' ASSOCIATION

The monthly meeting of the Council was held on Thursday, October 5th, 1911, at 23, Bedford Street, Strand, London, W.C., when Mr. T. W. Cowan presided. There were also present: Messrs. W. F. Reid, C. L. M. Eales, O. R. Frankenstein, A. Richards, E. Watson, J. B. Lamb, J. Smallwood, A. G. Pugh, T. Bevan, E. Walker, and Col. H. J. O. Walker. Affiliated Association Delegates: Messrs. J. P. Phillips (Worcester), G. W. Judge and J. E. Smiles (Crayford), G. R. Alder (Essex), L. E. Snelgrove (Somerset), W. Faulkner (Leicester), J. Cunningham (Cambridge and District), and W. Herrod (Secretary).

Letters expressing regret at inability to attend were read from Miss Gayton, Messrs. E. Garcke and G. Hayes, General Sir Stanley Edwardes, Captain Sitwell, and Dr. T. S. Elliot.

The minutes of the Council Meeting held September 21st were read and confirmed.

The following new members were elected: Mr. J. M. Balmbra, East Parade, Alwicks; Mr. W. H. Crowe, Tythe Barn, Cookham Dene, Berks; Mr. C. W. Dyer, Compton Crossing, Newbury, Berks; Mr. A. H. Hamshar, Eastwood Road, Bramley, Guildford; Mr. R. H. Attenborough, High Cross, Alderham; Mr. H. P. Perkins, Ver Cottage, Frogmore, St. Albans.

The report of the Finance Committee was presented by Mr. J. Smallwood. The balance in hand at the end of September was £144 14s. 5d., and there were no payments due.

The report on the Third Class examination, held in London, was presented, and it was decided to grant certificates to the following: Messrs. E. Watson, E. L. Jones, H. C. Jones, H. G. Ceiley, W. G. Coates, and A. Ross.

Mr. T. W. Cowan and Col. H. J. O. Walker kindly consented to undertake the work as examiners for the Second Class examination.

A letter was read from Mr. G. Thomas with reference to the draft of a Foul Brood Bill, which had appeared in "The Smallholder," and after discussion, it was resolved to postpone the matter till the next Council meeting. In the meantime the Secretary was instructed to obtain and post to each member of the Council a copy of "The Smallholder," of September 23rd, containing the draft of their proposed Bill.

The next Council meeting will be held on November 16th.

The Council then adjourned to the Gardenia Restaurant, 6 Catherine Street, Covent Garden, when over eighty members and friends assembled. Light refreshments were served, after which a special general meeting was held, presided over by Mr. T. W. Cowan.

The Chairman read the notice convening the meeting, and called upon Mr. J. B. Lamb to move his resolution.

Mr. Lamb said it gave him great pleasure to move his resolution, as he was quite sure it would be the means of bringing the Affiliated Associations into closer touch with the Central Association. Hitherto, he felt that those associations had been taxed without direct representation. The affiliation fee was paid, but before representation could be obtained on the Council it was necessary for the representative to become a member of the Central Association. The rule as it then stood was as follows: "3.—Each Affiliated Association shall hold an annual general meeting, and elect two of its members (not necessarily residing within the county or district) to attend the conversaciones in spring and autumn, one of whom (approved by the Council of the Central Association), being a member of the Central Association, shall be an ex-officio member of the Council, with full power of voting at any of its meetings." He therefore moved that No. 3 of the "Conditions of Affiliation" be amended as follows: "Each Affiliated Association shall hold an annual general meeting and elect two of its members (not necessarily residing within the county or district) to attend the conversaciones in spring and autumn, one of whom (approved by the Council of the Central Association) shall for one year be an ex-officio member of the Council, with full power of voting at any of its meetings, and exercise all the rights of membership of the British Bee-Keepers' Association." They would see by this that not only did they get representation without taxation, but that the delegate actually became a member of the Central Association without any payment whatever.

Mr. W. F. Reid seconded the proposition, and in doing so said that the Association were going further than any other society did in doing this. He knew of no other society that treated their affiliated bodies in so liberal a spirit, which only showed how anxious and willing the Central Association were to be helped by the affiliated associations in managing their affairs. He hoped it would result in a better attendance

of the delegates in future. Although the compulsory taxation would be removed, from what he knew of the majority of bee-keepers he was quite certain the delegates would not let the funds of the Association suffer through this spontaneous generous action on the part of the Association and that the delegates on the list of members would still have a figure in the cash column following their names.

The resolution was then put and carried unanimously.

(*The report of the conversazione will appear next week.*)

### THE DAIRY SHOW.

The Thirty-sixth Annual Exhibition of the British Dairy Farmers' Association opened on Oct. 3rd at the Agricultural Hall, London, and closed on the 6th inst.

The honey show was an improvement on last year, some very fine exhibits being staged, but it did not bear comparison with the Grocers' Exhibition. The exhibits numbered altogether eighty-six only, just eleven more than the numbers shown in the light-honey class alone at the latter exhibition.

It is curious that this show is not better supported by bee-keepers, as it brings them into touch with the dairying industry. One commodity sold in the present-day dairy produce shops is honey, generally of the best quality, and being put up in an attractive manner realises a good price. For a good selling line such as this the vendor is always willing to pay a reasonable figure. It has been suggested that the larger entry fee of half-a-crown as compared with a shilling at the more popular show is the cause of the difference in numbers, but surely this cannot be the case with those who wish to find a market for their honey.

Mr. E. Walker judged the exhibits and made the following awards:—

*Twelve 1-lb. Jars of Light Extracted Honey.*—1st, T. G. Hillier, Hurstbourne Tarrant, Andover; 2nd, A. C. Jackson, Elvedon, Thetford; 3rd, H. S. Jesson; 4th, H. W. Saunders, Croxton Road, Thetford; r., Jas. Lee and Son, Martineau Road, Highbury, N.; v.h.c., R. Brown and Son, Flora Apiary, Somersham; R. H. Baynes, Bridge Street, Cardiff; J. M. Stewart, Mollance Gardens, Castle Douglas, h.c., J. Tildesley, Bolerbridge Street, Tamworth; J. Ward, Hesketh Bank, Preston; W. T. Gunter, Cowbridge, South Wales.

*Twelve 1-lb. Jars of Medium-coloured Extracted Honey.*—1st, R. Brown and Son; 2nd, E. C. R. White, Newton Toney, Salisbury; 3, C. H. Rose, New Malden, Surrey; 4th, A. J. Harris, Portland House, Moreton-in-Marsh; r., F. Alun Jones,

Halkyn, Flintshire; v.h.c., C. E. Billson, Cranford, Kettering; h.c., W. Sells, Twickenham Road, Loxtonstone.

*Twelve 1-lb. Jars of Dark Extracted Honey (including heather-blends).*—1st, E. C. R. White; r., Dr. T. Elliott, Southwell, Notts.

*Twelve 1-lb. Jars of Heather Honey.*—1st, John Berry, Llanrwst, North Wales; r., A. Borland, The Knowe, Cumnock; v.h.c., Mrs. J. Whitaker, Abbeystead.

*Twelve 1-lb. Jars of Granulated Honey.*—1st, Jas. Lee and Son; r., H. Holland, Sutton Bridge, Lincs.; v.h.c., R. Brown and Son.

*Twelve 1-lb. Sections.*—1st, J. M. Balmбра, Alnwick, Northumberland; 2nd, Jas. Lee and Son; 3rd, T. G. Hillier; r., R. H. Baynes; v.h.c., J. G. Nicholson, Langwathby, Cumberland, and R. Brown and Son; h.c., R. Robson, Wooler, Northumberland; c., Arthur J. Marriott, Market Harboro'.

*Six 1-lb. Sections of Heather Honey.*—1st, J. M. Balmбра; 2nd, T. Walker, Hawkshead, Lancs.; r., R. Robson; v.h.c., H. Waddington, Borobridge, Yorks, and A. F. Borland; h.c., J. G. Nicholson.

*Honey Trophy.*—1st, Jas. Lee and Son. *Beeswar.*—1st, R. H. Baynes; 2nd, J. N. Stewart; 3rd, H. Roughton, Spalding Road, Holbeach; r., J. Berry; v.h.c., Jas. Lee and Son and R. Brown and Son; h.c., Goodburn Bros., Millfield, Peterboro.

*Beeswar.*—1st, J. Berry; 2nd, Goodburn Bros.; r., H. W. Saunders.

*Interesting Exhibit of a Scientific or Practical Nature.*—1st, A. S. Dell, Leigh, Lancs.

### HELPFUL HINTS FOR NOVICES.

By W. Herrod.

#### PREPARING FOR WINTER.

(Continued from page 374).

About the beginning of October a second examination should be carried out to ascertain the amount of food in each colony. There should be at least 30lb. of stores in the combs, and as much of this as possible should be sealed; it is difficult for some people to estimate the weight of food in the combs from their appearance. A simple method is to see that each colony has at least eight combs well filled with stores, *i.e.*, they will be full with the exception of a small space at the bottom centre, about three inches in diameter. The stores should be sealed as far as possible, though a little unsealed will do no harm as it will be used up first. Should the bees not have sufficient stores then they must be fed as rapidly as possible; for this purpose a large rapid feeder should be used. I prefer one that holds about one gallon of syrup at a time, it is less trouble, the bees are not disturbed so

often by filling and the greater volume of liquid retains its temperature longer. There are various forms of rapid feeders on the market. I have made many serviceable ones from biscuit tins; this is easily accomplished by anyone with a little mechanical ingenuity, the only tools necessary being a pair of shears and a soldering iron. A wooden float must be provided for the bees to rest upon while taking the syrup, otherwise a large number will be drowned and the feeder choked with their dead bodies. Where food is short bees will take down syrup very quickly; I have seen a colony clear a gallon of syrup in less than six hours.

*Making Syrup.*—There are various ways of doing this, to some people an irksome task. It is possible to buy syrup ready made, but this is an expensive way of obtaining it. In the first place nothing but pure cane sugar should be used, in lump or crystallised form. There is no excuse at the present time for using beet sugar as guaranteed cane sugar can be obtained, and though it may be a little more expensive the outlay will be well repaid by the better health of the bees. All brown sugars should be avoided as they contain molasses which will cause dysentery. Where a large number of bees are kept it will be well to make up a quantity at a time, say one or two hundredweight; this can be done in a copper, it should be stored in a large ripener and be warmed before being given to the bees. For this purpose a spouted can (an ordinary watering can will do) is filled and placed over an oil or gas stove until the syrup is new milk warm, it is then quite a simple matter to fill the feeders. Small quantities can be made in an ordinary saucepan over the fire. Personally I prefer not to boil the syrup, for I find by so doing it is more likely to crystallise in the feeders, and also in the combs. My method is to place the sugar in warm water and let it thoroughly dissolve, then heat it to just on boiling point, no further. I know one very large bee-keeper who makes his syrup by having a large cask in which the sugar is dissolved in cold water. In the spring and summer the syrup is taken and given to the bees without heating at all. For autumn feeding it is slightly warmed before being given; this is a practice I would not recommend generally, but in his case it works well. Salt and vinegar should be added to the syrup; the majority of bee-keepers neglect to put in these two ingredients, either because it is too much trouble or they imagine they are of no use. Salt is necessary for bees just as much as it is for human beings, and if they cannot obtain it in any other way they will get it from objectionable sources, such as the liquid from manure heaps. Vinegar prevents granulation and when

the syrup is boiled in no case should it be omitted. The feeder should be kept well wrapped up for the sake of warmth. Avoid spilling the syrup when filling the feeders as this saturates the calico quilt; when dry it hardens, becoming like a piece of thin board, in this condition it is difficult to make it sit down snugly over the frames, and it also encourages the bees to eat it away; they then creep through the holes so made and being unable to find their way back hundreds of them perish; a spouted can should be used to avoid this.

Our next work will be in connection with the hive. We must guard against damp getting inside, therefore attention must be given to the roof and floorboard; damp rises and of course rain and snow fall from above. Many are content to see that the roof is all right, and take no care of the floor-board. The roof, if properly treated when the hive is new and before it is occupied, by stretching calico or fine canvas over it very lightly and well painting the same, will require no attention beyond a couple of coats of good oil paint every two years. If not so treated, be it ever so well made and of the best seasoned material, changeable climatic conditions will eventually make it crack, or, as carpenters call it, shake; when this has happened thin paint should be run into the crack, and when this has set, soft putty should be well worked into it from the underside until it oozes through on the top side, rub down level by means of sandpaper, allow it to stand for a day or two to allow the surface of the putty to harden, then paint. A good plan after this has been done is to stick strips of calico over the cracks on the underside by means of white lead. Personally, on no account would I use the stepped roof as it is impossible to keep it watertight. The roof should be made flat on each side; if calico is used it does not matter how many joints there are—it will be quite watertight. I have a roof made of strips of wood none of which is more than one inch in breadth.

(To be Continued).

---

## Correspondence.

---

*The Editors do not hold themselves responsible for the opinions expressed by correspondents. No notice will be taken of anonymous communications, and correspondents are requested to write on one side of the paper only and give their real names and addresses, not necessarily for publication, but as a guarantee of good faith. Illustrations should be drawn on separate pieces of paper.*

---

### HEATHER PLANS.

[8270] In recent numbers of the "B.B.J." I have noticed requests from

Mr. Crawshaw and Mr. J. Ellis, asking "Medicus" to report on his further results at the heather.

Unfortunately "Medicus" has not been able to conduct any experiments on the scale he would like, as he now lives in the Midlands and a long way therefore from the glorious heather moors. Such observations and experiments as he has been able to make he is pleased to report for those who may be interested in the question of how best to ensure a harvest from the heather. In 1910 the results of using a shallow and restricted brood-nest were excellent, considering the bad season, and the surplus obtained was much in excess of the average "take" of the neighbourhood. The procedure was that outlined in the "B.B.J." from time to time. The bees were made as strong as possible on the old North Country maxim that for the moors there is no packing like bees.

At the time the bees were sent to the moors the queen was confined to a single division brood-nest with  $5\frac{1}{2}$  in. deep frames, and any surplus brood was placed above the super and separated from it by a piece of calico which had a small hole cut in it by which the young bees could go below. These brood-divisions were renewed as soon as the bees had all hatched out. The results, when compared with the standard hive, have been equally satisfactory this season.

A further experiment was made in 1910 of hiving driven bees on to  $2\frac{1}{2}$  in. brood-combs. These very shallow combs are  $5\frac{1}{2}$  in. combs in which the lower part of the comb is filled in by a block of wood with a resulting inside measurement of  $2\frac{1}{2}$  in. by  $16\frac{1}{4}$  in.—they are close ended. The bees unfortunately did not arrive until after the main ling-flow was over, which, in 1910, took place during the first twelve days of August. Two lots were received about August 20th, 1910, and weighed roughly 6lb. and 4lb. respectively. To my surprise, the first lot produced 13lb. in weight of marketable honey, and the other 9lb. absolutely free from pollen. This was a larger surplus than the majority of neighbouring bee-keepers obtained with standard hives. In each case, owing to the cold weather, the bees only occupied one side of the brood-nest and of the super, and only had 2lb. or 3lb. or honey in the brood-nest at the end of the season, preferring to put it in the super and cluster there rather than occupy a larger area of the brood-nest. Each colony on their return home was given a set of filled  $5\frac{1}{2}$  in. combs above their shallower combs and placed above each other on the same stand (but quite shut off from each other) so as to conserve their heat. Both wintered safely,

although they had a 230-mile railway journey in February of this year.

The results were so interesting that I intended to carry out further experiments, but, owing to my departure from the North, I was unable to do as much as I would have liked. But my friend Mr. J. N. Kidd, of Stocksfield, kindly undertook to come to my rescue, and to carry out experiments for me.

On August 5th,  $6\frac{1}{2}$  lb. of driven bees were hived on eight frames  $2\frac{1}{2}$  in. by  $16\frac{1}{4}$  in., inside measurement, which were fitted with 2 in. super foundation the full length of the bars. Above the excluder they were given forty-eight sections, 4 by 5, including three bait-sections partially filled with clover honey (about  $1\frac{1}{2}$  lb.) so as to feed the bees after their long confinement, and as a safeguard during the next few days. They were placed on their stand on the moors on the following afternoon (August 6th). On August 20th they were found to have (counting in some removed previously) fifty sections filled and being sealed, and the brood-combs all sealed solid, except the four central ones, which contained brood.

There was no further flow after this date, probably owing to the continued drought, but the sections were all completed.

On September 4th all the sections were taken off, and the two outside combs and one of those next the outside were removed from the brood-nest, as they contained no pollen and were snowy white and free from travel-stain. These combs from the brood-nest must have weighed about  $1\frac{1}{2}$  lb. each, and contained excellent well ripened honey. There was a further 5lb. or 6lb. of sealed honey left in the hive at the ends of the remaining combs. The centre was filled up with  $5\frac{1}{2}$  in. drawn-out combs. With feeding and some sealed stores the colony ought to winter well.

Three other driven lots of about 5lb. were by mistake given  $5\frac{1}{2}$  in. frames partially provided with stores. These did not give as good a result, and made but twenty sections each. This was, if anything, above the average the majority of bee-keepers obtained on that moor. In each case the value of the honey would well repay the cost of the bees, carriage, &c., and also leave the owner a colony which, with feeding, should winter safely. If these lots of driven bees had been put on to standard combs they would probably have stored the same quantity of heather honey, but it would have been in the brood-combs, and, therefore, only of the value of sugar syrup.

Mr. Crawshaw, in his ever-welcome "Cappings of Comb," in criticising a shallow brood-nest, raises the objection

that he fears that in such a brood-nest pollen will find its way into the supers.

I have for four seasons used  $5\frac{1}{2}$ in. brood-nests at the moors, and for the last two seasons I have, as already described, used  $2\frac{1}{2}$ in. brood-frames, but I have never found pollen in either sections or shallow frames, not even when the excluder is removed during the last half of the heather season, as is my custom. With a brood-nest of  $5\frac{1}{2}$ in. at other seasons of the year I have found that a certain amount of pollen tends to be stored above.

The reason of this difference probably is that bees at the moors gather little pollen beyond their requirements, and gather it only as they require it. This statement may be unorthodox, but is the result of careful observations I have made.

One of the features of the heather seasons 1908-10 was the paucity of brood in the hives and the intervals, sometimes long, during which there were no eggs or unsealed larvæ present.

I noticed in these seasons how relatively rare a pollen-gatherer was. If there was any flow of nectar the bees were hard at work bringing it home, and it was only rarely that a bee with filled pollen-bags was seen. If there was no flow the bees stayed at home and did not bother about pollen-gathering.

This scarcity of brood at the moors in 1910 sent the bees into winter quarters very weak, and only with old bees, and it resulted—in the neighbourhood of which I am speaking—in a very heavy winter loss, or, to be more accurate, in very heavy spring losses.

The heather season of 1911 has been one during which breeding has gone on continuously, and it was a surprise during the time I was able to be in the North Country and have the bees under close observation to see the large number of pollen-gatherers which were at work, both during a nectar flow, and in times of dearth. In none of these years has examination of the brood-combs revealed a store of ling pollen much beyond the immediate requirements of the colony, and only in the combs next to the brood, and there is none of that clogging of the brood-nest which, in May, often proves so annoying to the bee-keeper. As I have said, experience proves that with shallow brood-nests there is no danger of heather sections being spoilt by pollen.

Another obvious criticism is that such restriction of the queen must lead to a diminished production of young bees, and so damage the prospects of successful wintering. This certainly may be so in warm seasons, but in normal and bad seasons queens seldom occupy more

comb than a set of  $2\frac{1}{2}$ in. frames allows. In either case, feeding on the return from the moors and the extending of the brood-nest by partially-filled combs will largely obviate this, and the extra surplus will more than repay any loss due to weakening of colonies.

These experiments, which I hope to continue, suggest that bigger returns of heather honey could be obtained from a normal colony if it was made into a "shookswarm" and was shaken on to shallow starters, and if its brood with sufficient bees was placed above the super on the plan I have described above.—MEDICUS, Worcester.

#### ROSS-SHIRE NOTES.

[8271] The past bee season has been a record one in more than one way. The honey crop was seldom before so large, or so easily sold, while the selling price has been above the average. Honey gathering began and ended both early and well, thus discounting the usual need for sugar, so for once at least it has been all give and no take on the part of our little workers. Winter preparations began early here. I had every colony closed down by mid-September, after making certain that stores were abundant and hives proof against damp and mice.

The strongest stocks are being wintered in double-storey hives, on which a rack of partly stored sections is left on, while conversely the weaker colonies and nuclei are safer in contracted dual queen hives. Bees were profitable assets this year. Stocks of mine brought me in £3 apiece (average from actual sales of honey, to say nothing of what was used at home or given away), and I have still about a hundred clover sections to sell.

Heather honey, of course, sold at sight. One wholesale buyer took 100lb. from me at 1s. 2d., and I have since had several enquiries from the South for Highland heather honey, but couldn't possibly supply all. Luckily I have got over a hundred sections just now from a friend situated in one of those glens where the ideal rich, fragrant heather honey is obtained. My own produce, I must confess, is inferior to the nectar from the high hills. Perhaps some day I may start an out apiary in this favoured spot, and then be in the happy position to fill all possible orders.—J. M. ELLIS, Ussie Valley.

#### THE SEASON IN MID-CORNWALL.

[8272] The season just closed is the one we have been hoping to see for several years past, for although not a record one it certainly is the best we have enjoyed

for five years; probably it was a "record" while it lasted, but I never knew a honey-flow drop off so quickly owing to the prolonged drought.

*Where do Truant Swarms go?*—A swarm weighing 10lb. "took itself off" after being hived in a skep three times. I followed it across four fields, a main road, and a railway, and lost sight of it whilst rounding a clump of trees. The next morning, however, I learnt that the bees had taken possession of a ferret's box; I hastened to the spot, which was a quarter of a mile further on, and brought them back rejoicing. The ferret however was stung so badly that it died; needless to say the owner has been supplied with another.—**J. M. BEST**, Treavor Apiary, South Austell.

### INTRODUCING VIRGIN QUEENS.

#### THE GOOD HONEY SEASON.

[8273] This season I have been experimenting with some surplus virgin queens I had, in the first cases by introducing one to a stock in full working swing and secondly by introducing the queen to a swarmed stock. Both were allowed to run in direct, one at the entrance and the other at the top of the frames. In the first case I wanted to requeen an English stock (with supers on) with a young virgin Italian queen. About midday, when the bees were flying well, the virgin was put into a tubular cage of perforated zinc, and after having smoked the bees well at the entrance, she was allowed to run in from the alighting-board. Before running her in she was kept quite alone and without food for thirty minutes. About evening the old queen was lound cast out, and in four days the stock was examined, and the newly-inserted virgin found to be laying freely. In the second case my experiment was carried out with a colony that swarmed. After cutting out as many queen-cells as I required for queen-rearing purposes, a young virgin was kept quite alone, and without food for thirty minutes, and then allowed to run down from one corner on the top of the frames. On examining the stock a few days afterwards, this queen was also laying freely, and the queen-cells left in the hive destroyed. Not only did this stop further swarming, but the colony went ahead so rapidly that they came up into the supers again and at once got to work. Whether the above methods would always work successfully I am unable to say, but I hope to test further next season. In regard to introducing fertile queens, I use nothing but the direct method, and out of some 200 queens, introduced for myself and other people, I have only had one failure, and this was more or less expected, for the bees were confined in a

small nucleus hive during the hot weather, and became very excited.

It is pleasing to note that at last we have had a good season, which seems to have been general all over the country. Several skeps in this district are reported to have given as much as 100lb. surplus, and in my own apiary, from five hives I have taken a little over 880lb. and nine swarms (three being artificial). One White Star Italian stock gave off no less than 328lb. of honey, and two artificial swarms. Wishing all bee-keepers success.—**JULIAN E. LOCKWOOD**, Hunstanton, Norfolk.

### PAINTING QUEENS.

[8274] May I offer a few remarks in reply to your correspondent A. E. B. (8267, page 396) on "Finding Queens."

A few years ago it was my practice to paint queen bees, and I well remember the friendly controversy I had through the "B.B.J." with the late Secretary of the Lincolnshire B.K.A. (Mr. R. Godson), and the opinion expressed against the practice by the Editor (Mr. W. Broughton Carr) at that time; since then, however, I have slightly altered my opinion, and do not now think that it should be adopted in general; certainly not by those unacquainted with the anatomy and physiology of the insect.

If a queen bee could be marked or painted without irritating or harming her, then it certainly would be an excellent way of not only "spotting" the queen, but also of determining her age by means of colour to denote the year.

I found the tube oil paints (with the oil nearly dried out) and one dot supplied on the top and centre of the thorax, or on one wing most efficacious; a yellow or orange colour paint being used for preference. The queen bee is then easily found; the paint spot, as large as a pin's head, can be seen at several yards distance, and will last her lifetime.

But, apart from the risks of injuring the queen by blocking up the spiracles, and by clumsy handling, it is hardly a practical proceeding, for the queen must be found in the first place, and for ordinary purposes no queen should be found more than once, and then only for the purpose of dethroning and introducing another properly reared, otherwise queen hunts are unnecessary. If queenlessness is suspected, look for signs or evidence and thereby save time, temper, and —paint.—**T. W. SWABEY**, Lincs.

### DRONE v. WORKER COMB.

[8275] Mr. Crawshaw's criticisms (p. 345). prove the old adage: "Opinions differ



and experiences vary," but will he please bear in mind that I write from actual practical experience. I have made many and various experiments, and I practise what I have found to be the best methods. I do not extract from brood combs, and never said so. I however extract from standard combs, as well as shallow frames, and even skep combs and partially filled sections; what would Mr. Crawshaw do with combs 7lb. to just under 9lb. gross weight, many of them perfectly opaque and flat as a board, completely sealed too, with only the lower angles imperfect? I have proved, too, that there is a great gain on living swarms or driven bees on clean, empty combs. Once again I repeat, "That for real practical utility worker combs are far the best," and I should like Mr. Crawshaw to tell us of a real practical objection to worker combs in shallow frames.

He seems to have misunderstood me about drone combs in sections. I had in mind honey from shallow frames. Drone comb in any shape or form is, to me, simply an abomination, I even fix worker-comb out of skeps (after extracting the honey and getting the bees to clean them) into standard frames. I find it quite easy to clean out pollen, and the bees clean out the old cocoons, too; thus I have no occasion to melt down old combs.

*Extractors.*—Is not the tin extractor liable to corrode, and when by oversight honey is left on the outside, does not that change to an inky colour? I have an home-made extractor, made of selected yellow deal (memel I think), which has been in use for fifteen years, and is as perfect now as when made and practically air-tight. In my opinion this is far preferable to tin, for it never discolours in any shape or form. A. HARRIS, Wavendon, Bucks.

#### DEALING WITH "ISLE OF WIGHT" DISEASE.

[8276] For the benefit of brother beekeepers I send you a few lines of my experience in connection with the "I.O.W." disease. The first stock showed signs of the disease during honey-gathering time; we isolated it in the country where there were no other bees. The stock did not seem to get much weaker, but was not strong enough to work in the supers. We were of opinion that if we took the bees away and gave the stock healthy bees, it might effect a cure. I am glad to say it has been a complete success. We watched the stock weekly for a time, and noticed how well it was doing; we did not even disinfect the hive, but put in the

same combs, which were well filled with brood. On the faith of this stock doing so well we have set up for winter ninety-seven stocks with driven bees on brood-combs. We brought the affected stock home a few days ago, and examined it on the following day. It would cheer the heart of any bee-keeper to look at it—eleven standard frames filled with bees. We have rarely seen so good a stock of bees at this season. We have treated every stock in the apiary. We lost eighty-six out of eighty-eight stocks during our dearly-bought lesson on "I.O.W." disease. We scorched every hive, and have disinfected three or four times, hives, ground, and all. So long as the type of bee-keeper exists who offers stocks of driven bees at 3s. 6d. a lot—not guaranteed, of course—the disease will not be stamped out of the country. A neighbour of mine bought two lots, ten days or so ago, and we had to burn them four days after they came.—A MUIR AND SON, Kirkcubright.

#### DEALING WITH FOUL BROOD.

[8277] I send you a report of my bees, which may be of interest. In May I had three lots of bees in W.B.C. hives, two being slightly affected with foul brood. I got the expert's help on May 16th, and we destroyed the combs, &c., and united the bees, putting them on new combs in a hive washed with carbolic. They swarmed out of this, but were caught and put into a clean skep without carbolic. Three days later the skep was found empty, except for a small piece of newly-built comb containing eggs.

My third and only remaining hive seemed strong and doing so well that I had already supered it on May 8th, with twenty-one sections. These I took off finished on June 3rd. A second rack put below this on May 26th, was finished still more quickly by June 8th, and by July 20th, I had taken eighty-three well-filled sections, and from a box of shallow frames put below the last rack of sections on June 24th, I have taken 37lb. of run honey, making 120lb. in all.

I cannot understand why the diseased bees deserted the skep after comb-building and egg-laying had begun. I am also astonished at the extraordinary rapidity with which the third hive worked, and wonder if the diseased ones could have joined forces with this one, and so account for it, but I do not think a strong lot of bees, as this third lot was in May, would admit strangers. I should be glad of your opinion on these two points.—(Miss) G. WILLAN, Hanley Castle.

[There is no doubt the bees joined together.—Ed.]

## Queries and Replies.

[8231] *Wintering a Nucleus Hive.*—What amount of stores, in your opinion is required for the safe wintering of a four frame nucleus well packed with bees? Thanking you in anticipation.—NEMO, Essex.

REPLY.—All the combs should be full of stores: for the rest it will be necessary to keep a cake of candy on the top in a glass topped box, so that an inspection can be made of this food supply periodically. When exhausted replace candy with another cake.

[8232] *Supposed Late Swarm.*—I hived a cast at the beginning of July, and put the bees on eight frames. They formed a fairly strong colony, and the queen was soon fertilized. All went well, and I stimulated the queen after the honey-flow. They certainly were not overcrowded, but about September 1st, I noticed a commotion outside the hive, and attributed it to robbing. When I looked at the combs, I found three quite empty, two contained syrup, and three brood. What surprised me was the presence of two empty queen-cells. They had evidently been used, as one was ragged at the opening. There was also present, a queen which had laid eggs in brood-combs. There seemed to be very few bees in the hive, and no drones, although there were a few about a week ago. If these circumstances point to a swarm, is it not unusual so late, and especially the late fertilization of the queen? Could you give any other explanation?—K. C. P., Erdington.

REPLY.—Although unusual, it is quite possible that the hive had swarmed. We should rather attribute the cause to an accident having happened to the original queen.

[8233] *Difficulties in Transferring Bees.*—I shall be obliged if you will kindly answer the following queries:—I bought a swarm of bees last June, which were sent in a skep. I had a hive ready for them fitted with frames of foundation, and being unable to get help, I tried to run the bees in at the entrance, but after throwing about a pint of bees out on the sheet, who all appeared to have a common grievance against me, I left them to settle down a little, as I did not care to risk any more stings, and sent for a man who had some knowledge of bees. He advised me to put the skep on top of the brood-chamber. I contrived to do this, and he told me they would work down, taking possession of the hive, but although they have drawn some combs out they have never done anything further in the brood-chamber. I took the skep

off in a day or two, and put a quilt over the frames with a hole in the centre, placing the skep above this again; the top of the hive fits on the brood-chamber over the skep. About three weeks ago the skep weighed 32lb., which, I take it, is sufficient for wintering, but I should like to know: (1) Will the bees be warm enough for the winter, or will they require more wrappings? (2) Will they possibly work down into the frame-hive next spring, and, if not, how can I get them on to the frames, as I do not wish to have bees in skeps? (3) Should I contract the entrance for the winter? I am only a novice, so any advice will be greatly esteemed.—P. M., Donington.

REPLY.—(1) The bees will be quite all right as they are for the winter. (2) If the season is favourable they will work down next spring. (3) Leave the entrance open about 4in.

[8234] *Suspected Queenlessness.*—(1) Are British bees inclined to be bad-tempered? I examined the swarm from which a swarm issued, and find not a trace of brood—nothing but sealed honey at the top of the frames and empty cells in the centre. There are many drones and the bees are not killing or ejecting any of them. That in itself made me suspect there was no queen, and now the bees do not seem to carry in any pollen. (2) Does the absence of a queen make the bees more unsettled and more bad-tempered? (3) If I requeen just now what breed should I try? The apiary from which I got the bees has had no new blood introduced for many years. Should I keep to black queens, or go in for an Italian? (4) There were several queen-cells in the hive. What could have happened to the queens? (5) In the fight for sovereignty would the queens be apt to injure each other so much that both would die? (6) How far on into October or November will brood continue to be raised?—U. D. A., Ross-shire.

REPLY.—(1) British bees are no more inclined to be vicious than other races. Selection for disposition should be carried out to ensure a gentle strain of any race. (2) Yes. (3) We should advise you to stick to British bees. (4) We cannot say what has happened to the queens. (5) It is quite possible. (6) A great deal depends upon the weather; this year breeding has ceased altogether now, as it is cold.

[8235] *Age of Worker Bees.*—Having read several standard works upon bees, including the "Guide Book," "Lore of the Honey Bee," &c., and the "B.B.J." for three years, I have been until lately under the impression that worker bees live only about six or eight weeks during the busy part of the season. Now, on

June 26th, I found one of my hives queenless—a nucleus I had strengthened to six frames. Although there were no eggs, there was plenty of seated brood. I gave the bees a ripe queen-cell, but upon examination a week later, no trace of a queen could I find. In the meantime a friend of mine sent for an American golden queen, which duly arrived on July 22nd. Arriving late, she was introduced next morning. She was readily accepted, and quickly showed evidence of her presence, the young bees being bright golden and the old ones black. I could easily distinguish one from the other. Now, after practically four months in such a busy season, there is quite a good number of blacks entering with the goldens. After this experience I shall have an independent opinion of my own as to the longevity of the worker bee.—W. P. L., Baldock.

REPLY.—You have missed the point: worker bees die off rapidly in strong stocks in the summer time on account of the large amount of work they do. In your case the labour of the bees was practically nil for some time, so naturally they would live longer. You might try to apply your argument to bees which live throughout the winter; yet, for the reason given above, those bees which emerge in the autumn often live six months. It is necessary to read bee books intelligently, as a statement applicable to one condition or portion of the year should be read in conjunction with that time only, and not applied indiscriminately to all seasons and conditions.

[8236] *Keeping Race of Bees Pure.*—I will be grateful if you will let me know through the pages of your valuable paper a little about queen-rearing. Suppose I got two golden queens and introduced them into my hives, how can I be sure their queens will mate with golden drones when there are so many blacks in the neighbourhood? Surely they would bring forth hybrids, and finally, would degenerate into blacks again! How do queen-rearers manage this? Nothing is said about it in any books I have read on the subject.—L. A. S., Broadway, Lines.

REPLY.—It is impossible to keep any but the native race pure, and very often even these get hybridised through the keeping of foreign bees in the neighbourhood, but if no further importation takes place this soon dies out.

[8237] *Making an Observatory Hive.*—Could you kindly inform me on the following points, as I am desirous of making an observatory hive:—(1) If the walls are made of thick plate glass, should there also be wooden shutters to keep the

hive in darkness when not being used for observation purposes? (2) Owing to the small interior space will not the bees be continually swarming in the spring? (3) Is there any material advantage in a revolving base, and should one side of the hive be made to open? (4) Can a "Brice" feeder be obtained by itself?—ROBERT W. WIGHT, Suffolk.

REPLY.—(1) Yes, shutters must be provided. (2) You should arrange for a super of three sections to avoid this. (3) It is best to use a proper brass base which can be obtained from any appliance manufacturer. One side must be removable so that the frames can be got in and out. (4) We believe Messrs. Lee and Son supply these feeders separately.

### WEATHER REPORT.

#### BARNWOOD, GLOUCESTER.

September, 1911.

Rainfall, 1·34 in. in 10 days.	Mean temperature for month, 57·7; 3 of a degree below average.
Below average, 91 in.	Relative humidity or percentage of moisture in the air at 9 a.m., 69.
Heaviest fall, 42 in. on 27th.	Number of days with sky completely overcast at 9 a.m., 4; ditto cloudless, 7.
Total to date, 11·16 in., as compared with 21·42 in. for corresponding period of last year.	Percentage of cloud, 36.
Mean maximum temperature, 69·2; 4·2 degrees above average.	Percentage of wind force, 21.
Mean minimum temperature, 46·2; 4·8 below average.	Prevailing directions S.W. & N.W.
Warmest day, 8th, 92·0.	
Coldest night, 15th, 31·4	

F. H. Fowler (F. R. Met. Soc.).

### WEATHER REPORT

#### WESTBOURNE, SUSSEX.

September, 1911.

Rainfall, 1·55 in.	Minimum on grass, 34° on 19th & 22nd
Below aver., 57 in.	Frosty nights, 0.
Heaviest fall, 63 in., on 19th.	Mean Maximum 68·6.
Rain fell on 10 days.	Mean Minimum 49·8.
Sunshine, 240·6 hrs.	Mean temperature 59·2.
Above average, 65·4 hours.	Above average, 3·4.
Brightest day, 1st, 11·8 hours.	Maximum barometer, 30·367 on 18th.
Sunless days, 0.	Minimum barometer, 29·424 on 21st.
Maximum temperature, 85° on 8th.	
Minimum temperature, 37° on 19th.	

L. B. BIRKETT.

## Bee Shows to Come.

**Oct. 31 and Nov. 1, at Brighton.** Sussex B.K.A. Show in connection with the Brighton and Sussex Horticultural Society's Chrysanthemum Show. Free Open Classes. Schedules and Entry Forms from C. A. Overton, Beecroft, Crawley, Sussex. **Entries close Oct. 24.**

### AN APPRECIATION.

We reprint the following gratifying testimonial as to the value of the "B.B.J.," from a contemporary:—

**To Learn the Latest** about Bee-keeping at home and abroad, subscribe through us for the **BRITISH BEE JOURNAL**, *Gleanings* (American), *American Bee Journal*, *Canadian Bee Journal*.

## Notices to Correspondents.

**W. P. L. (Baldock).**—*Planting Hedge.*—Both *Ligustrum vulgare* and *L. japonicum* are equally good for bees, and are both classed as useful bee plants. It is therefore quite a matter of choice, but the latter has large coriaceous leaves, and is the handsomer of the two, while those of the former are small and elliptic-lanceolate.

**HOUND (Edinburgh).**—*Hives for the Moors.*—Special hives are made for taking to the moors, and no doubt it will be to your advantage to use these, if you intend to take your bees periodically there. We are glad to hear that you are so pleased with the "Guide Book," and hope that you will continue to find it useful.

**NOVICE (Yorkshire).**—*Preparing Stocks for Winter.*—(1) It is too late to feed bees with syrup now, so you must see that a constant supply of candy is kept on the hive. (2) Leave all the eight frames in, and give a good cake of candy, renewing when required.

**H. P. (Sandwich).**—*Harvest Moon.*—We cannot say; you should consult a good calendar.

### *Honey Sample.*

**ALPHA (Darwen).**—The honey is rather thin, but good in colour. It is from mixed sources, but has a distinct flavour of ragwort.

**F. A. C. (Scarborough).**—Sample 1 is a good heather blend. No. 2 is heather honey, but is spoilt by fermentation. No. 3 is also fermented.

**G. M. L. (Leicester).**—The honey has been gathered from limes; it is this flavour that you notice, as it is very strong.

**T. H. W. (Hurstpierpoint).**—Sample is from mixed sources; its inferior flavour and lack of density make it unsuitable for showing.

**A. B. C. (Pitsea).**—(1) Mainly from clover. (2) A great deal depends upon the samples which enter into competition with it. If shown in the light class it would have stood a fair chance of being awarded a prize. (3) A fair price retail, 1s. per jar.

### *Suspected Disease.*

**J. R. (Morayshire).**—A case of foul brood. If the stocks are not worth saving, they should be destroyed now; if you prefer to leave them till spring, use "Apicure," and naphthaline in the hives at once.

**GILLGARRION (N. B.).**—The bees are badly constipated, and there are signs of "Isle of Wight" disease. You had better destroy the stock to avoid risk of spreading infection.

**T. DAVIES (Merthyr Tydvil).**—We cannot see any trace of disease. The bees are of the English variety.

**CLONTERS (Abergavenny).**—We regret to say that your letter did not reach us.

## Special Prepaid Advertisements.

**Two Words One Penny, minimum Sixpence.**

Orders for three or more consecutive insertions entitle advertisers to one insertion in "The Beekeepers' Record" free of charge.

Trade advertisements of Bees, Honey, Queens, and Bee goods are not admissible at above rate, but will be inserted at 1d. per word as "Business" Announcements, immediately under the Private Advertisements. Advertisements of Hive-manufacturers can only be inserted at a minimum charge of 3s. per  $\frac{1}{2}$  in., or 5s. per inch.

## PRIVATE ADVERTISEMENTS.

**FOR SALE,** good Honey Plants, Limmanthes, Douglasii. 9d. score.—MISS ELLIOTT, Oundle, Northants. n 58

**GOOD SUFFOLK EXTRACTED HONEY,** in 28lb. tins, 56s. cwt.; tins returnable.—RICE, Newton-road Apiary, Sudbury, Suffolk. n 79

**FOR SALE,** 100lb. pure Down EXTRACTED HONEY.—Please apply J. STONE, Long-street, Down, Enford, near Pewsey, Wilts. n 79

**GCWT.** good WORCESTERSHIRE HONEY, 42s. cwt, rather dark; sample free.—BONELL, Witley Court Gardens, Worcester. n 78

**PURE EXTRACTED CLOVER HONEY,** season 1911, in 28lb. cans, 61d. per lb., carefully packed free on rail, Northants County guarantee label; all enquiries answered.—MORRIS, Welland Valley Apiary, Barrowden, Stamford. m 19

**HONEY,** finest Hampshire, 58s. per cwt., 28lb. tin, 15s., tins returnable or charged; sample 3d.—OWEN BROWNING, Ashley, Kingsomborne, Hants. m 36

**EXTRACTED ENGLISH HONEY,** 12s. 6d. per 28lb. tin, sample 2d.—DUTTON, Terling, Essex. 1 79

## Editorial, Notices, &c.

(Continued from page 402).

### THE CONVERSAZIONE.

The half-yearly conversazione followed immediately after the general meeting, and was attended by over one hundred and twenty members and friends. The first item on the programme was a very interesting and popular one, being a private cinematograph entertainment, kindly provided at his own expense by Mr. J. Bee Mason.

Mr. Mason said that for the benefit of those who were not present at the annual meeting in March last, and also for those who had to leave early, so missing the pictures, he would again show "The Bee Hunter." This series of incidents of bee-life was received with loud applause. Then followed "The Life of the Bee," a most interesting set of films which have already been described in our pages. This was followed by "The Production of Honey." The pictures were received with prolonged applause, and Mr. Cowan, in thanking Mr. Mason on behalf of the meeting, said that he was sure they would all agree that their very best thanks should be given to him for his trouble, and for the pleasure the pictures had given them. Mr. Mason was a practical bee-keeper, also a fellow member of the Association, and they would notice that the operations in the pictures were carried out by himself.

Mr. Burt seconded the resolution, saying that the pictures were more than "an excellent production"; they were "marvellous," especially those illustrating the birth of the queen.

Mr. Mason, in reply, said it had given him great pleasure to be of service to the Association. It would be unfair to claim all the credit for himself as, fortunately, amongst his friends were some of the cleverest animated photographers in this country, and they were at all times ready and willing to help him. To give some idea of the trouble expended to obtain the pictures, "The Birth of the Queen" took him six weeks, and many days he stayed by the hive all day with the camera, even having his meals brought to him. Next year he hoped to show some totally different subjects, and members could help him by letting him know if anything unusual happened in their apiaries, and giving him the opportunity of coming and photographing it.

Mr. Frankenstein was then called upon by the Chairman (Mr. T. W. Cowan) to read his paper on "Marketing Honey." This was as follows:

How varying the bee-keepers' harvest is cannot be better evidenced than in the last two years—the present one so generous that bee-keepers of all grades have succeeded in obtaining a substantial honey-crop, whereas last season many of them were threatening to give up bees altogether on account of the poor results.

Now, having obtained the honey, the question arises, what is the best manner of disposing of the surplus? and this deserves much consideration which, however, should have been given at the time one was deciding on the number of stocks to keep.

If one is a small bee-keeper, keeping bees principally for pleasure, one should limit the number of stocks to about four or five, which number one should be able to attend to satisfactorily, without having to devote too much time and trouble to them; the honey obtained from this number of hives can generally be made use of in the household, and a portion sold at a fair figure to one's friends, or perhaps in the locality, although I have found that the local market is generally so well supplied that the price is low.

If the bee-keeper desires to make his bees principally for pleasure, the number of stocks should be limited to about four should endeavour to keep as many stocks as his district is capable of supporting, providing that he has time to attend to them; and he must make it his duty to find out how to dispose of the bulk of his produce at a fair price, and he will probably soon note that the towns offer the best outlet. He will realise that there is keen competition to be met with, and he must consider the best means to overcome it. The bee-keeper who makes a business of his craft not only makes a profit on his own honey, but is also able to buy up and sell the honey of his neighbour, the bee-keeper in a small way.

During my own short life—for I am still a comparatively young man—I have several times come across individuals who complain about not being able to get a fair price for their honey, and they generally belong to one of two categories—either they keep bees in a haphazard and desultory fashion, and do not take the trouble to make their honey sufficiently attractive for the market—or else they belong to that class which, for want of a better term I shall refer to as "the between and betwixt men"—these are neither amateurs nor professionals. They want to make money from their bees, but having other work to attend to they have not sufficient time to devote to the ten to fifteen hives they may keep, and the amount of honey they obtain, although considerable, is not sufficient for them to build up a good connection:

consequently they offer their produce to a local retailer or a grocer at a figure much below the normal market-price, and thus by their underselling—for that is what it amounts to—they inflict a hardship on the bee-keeping community, by helping to keep the price of honey low. But failing this outlet for their produce they are glad to accept the price offered by the larger and more enterprising bee-keeper.

In marketing honey I find many of the smaller bee-keepers are ignorant, not only of the first essentials of business transactions, but also of the manner in which honey should be made attractive and the methods of packing it for transit; it should be borne in mind that however fine the honey, unless suitably got up and carefully packed good prices can never be realised for it. It therefore behoves bee-keepers to learn how to prepare and pack honey for the market, and I have always found bee-keepers very generous in their willingness to help a brother in the craft.

The professional bee-keeper's way of selling his produce is to take a few samples of it in jars and sections, and visit likely shops in a suitable district or town, principally dairymen and high-class grocers. He should have some cards neatly printed with his name and address, stating the various kinds of produce handled, and if an attractive photo of his apiary be included on the card this will most certainly cause more attention to be directed to it. By this means he comes in contact with the competing wares, and notes the manner in which they are got up to please the public, and incidentally, if he is shrewd enough, he may find out the figures his competitors sell at. He will note that all first-class quality honey is displayed as attractively as possible, whereas the second-grade stuff is disguised or concealed from the public in the form of tins, cardboard mugs, and such mediums.

Business will frequently result from entering honey at the larger shows, and if a visit be paid at the same time one may come across several buyers, and also note the different methods of getting-up honey.

The bee-keeper anxious to solicit orders should possess (or contrive to acquire) that dogged persuasiveness which makes the buyer feel satisfied that he knows someone on whom he can rely for good-class honey. Before seeking an outlet for his honey the bee-keeper should find out how to clean, glaze, paper, and for preference enamel band sections, as it enhances their appearance materially; many of the bigger bee-keepers are now making use of ready-made cases for their sections, and if a neat but not too ex-

pensive pattern be bought, the resultant saving in time and trouble, to say nothing of the quick sale of early produce, is no inconsiderable advantage. One must also learn how to extract, strain and bottle honey; jars should be neatly labelled, preferably with name and address, if permissible, for these labels serve as distinguishing marks for a certain brand or quality, and if the honey is good the labels advertise the fact, which greatly assists sales; sections are seldom labelled, but should always be stamped with the wording, "This side up."

With a big bee-keeper it is very essential to know how to store honey for several months, in order to be able to keep up a regular delivery to one's customers, otherwise if one fails to execute repeat orders opportunity is given to a competitor to step in, and thus good wholesale buyers are lost. With reference to storing honey, I have kept sections unglazed for several months by the following means without granulation setting in, and this must be guarded against, for sections when once in this state are unsaleable: After cleaning and grading, I pack them in racks and store these with layers of paper between, placing the racks where neither mice nor severe cold penetrate; extracted honey should be strained and run off into 14lb. or 28lb. tins, and if it granulates it may be liquefied just prior to bottling.

As to packing, methods vary; sections may be safely packed, either glazed or not, in half-dozen lots, with strips about 4in. wide of four-fold newspaper run between each section, the ends being protected with cardboard squares, each packet being then securely tied; the whole is then wrapped afresh in paper, and once more tied; the package may then be placed in a Tate's sugar-box, and firmly packed with hay, straw, or woodwool in lots of six half-dozen section-blocks. If great care be exercised, double this quantity may be safely packed, leaving but scanty room for packing material. Jars travel well wrapped in paper to keep out dust, and then packed in lots of two dozen to three dozen, with some elastic material as mentioned.

Some people take still more pains when sending off honey, and purchase specially-made returnable boxes or crates with cardboard fittings. This would be an excellent plan were it not for the difficulty of getting these empties returned by the wholesalers; the cases and packing are generally free and carriage paid by sender, and all breakages deducted from the account.

Small bee-keepers may manage to get rid of quite a respectable quantity of their produce by letting their friends

know that they have some real pure English honey for disposal. By selling to consumers in small retail lots, not less than 1s. per jar or section should be realised, and if less than 6lb. be required, postage or carriage should be charged. The great drawback to this system of selling is the difficulty in packing these few jars or sections in an inexpensive manner, so as to avoid the breakages which frequently result from our present gentle (?) modes of transit. I hope we shall this evening hear of some inexpensive methods whereby the number of smashes by rail or post may be successfully avoided.

Where bee-keepers are located in a neighbourhood frequented by a good class of leisured folk, such as seaside and health resorts, touring centres, &c., the mere statement of the fact that home-produced honey is procurable within, when displayed as a sign to the passer-by, will often bring many of the smaller private buyers to one's door. Local advertising will also help sales, but care must be taken that the money is received before sending off the produce.

I have recently heard a great deal of the benefits of co-operation—especially amongst farmers—and there undoubtedly is a great deal to be said in favour of it, but I am of the opinion that the disposition of the Englishman is not sympathetic to the idea; his inherent conservatism and desire to remain free and unfettered are factors which work against the adoption of this system, whereby small expenses are saved. I am well aware that there are several instances where it works very successfully, but this is generally because affairs are in the hands of very capable persons, who possess commercial foresight and adopt up-to-date business methods. These are the type of individuals, not often met with, who would make a success of any business undertaking, co-operative or otherwise.

I believe I am right in stating that co-operation has already been tried in this country in connection with the disposal of honey, and that it ended in failure, owing to the commercial talent evinced by some thoughtful bee-keepers who, generously desirous of assisting in such an eminently good object, disposed of their best honey elsewhere and forwarded their worst to be sold by the depot.

Respecting prices of honey, I can often buy off local bee-keepers fair sections at 7s. to 8s. per dozen. These are straight from the racks, and require cleaning, glazing, &c. I can command 9s. 6d. to 10s. 6d. per dozen for fair marketable sections when glazed. Run honey can be bought in 28lb. tins from 52s. per cwt., of very fine quality. As I only work for

sections, I buy all my run honey. I can buy first-class clover honey in jars at 8s. 6d. per dozen. However, considering the extra cost and trouble of buying bottled-honey, it is not a really profitable business, but it serves to keep one's customers together. I get 9s. 6d. to 10s. 6d. per dozen for nominal 1lb. jars, and 5s. 6d. to 5s. 9d. for the  $\frac{1}{2}$ lb. jars. I sell all honey net, with one month's credit, and I take the usual precautions for finding out the reputation of a house before selling them any goods.

The foregoing figures I have given you relate to good commercial samples of honey, but higher prices may sometimes be obtained for really first-class produce, although it is only a good salesman that realises these better prices. As to inferior grades of honey, I do not know how the prices rule. Very inferior and black honey is bought for manufacturing purposes, and I do not think there is much profit in it for the bee-keeper.

With reference to heather honey, I have had very little experience with it. I am aware it is worth more than clover and the other honeys, but I do not know whether it fetches a much better figure on the wholesale market. I find that granulated honey in jars requires a little more pushing, but it sells at the same rates as the liquid.

I should like it to be borne in mind that the foregoing is merely the experience of a small bee-keeper. I have often wondered how some of the big bee-keepers dispose of their large crops of honey, amounting, as it does in many cases, to some tons. I am sure the craft would be very grateful to learn something from them, and I feel that these are the men who, if only willing, should be able to give the rank and file a great deal of useful information."

In opening the discussion which followed the paper Mr. Lamb asked for a suggestion as to whether there is any means of bringing the producer and consumer together. Would it be possible for the Council of the B.B.K.A. to issue a honey sales circular compiled in conjunction with the County Association? The circular should give the names and addresses of bee-keepers who are willing to sell honey and the price proposed to ask, and should be issued only by the Central Association.

Mr. Hingworth was glad to hear the question of a standard price for honey raised. He found a great deal of difficulty in knowing what price to set at, as prices vary so much. He would ask Mr. Frankenstein what reduction he made on large quantities of honey.

Mr. Richards said he would like to put in a word for the half-and-half man. If the demand was great and the half-and-half man took a low price for his honey, he did

not of necessity reduce prices. If there was a demand for honey at 1s. a pound, and he sold at 8d., he was only putting 4d. into someone else's pocket. He recommended bee-keepers if possible to go round to the large shops and see what honey was retailed at, and that would give them some idea of what price to ask. Another point: no one wants to reduce the price of honey, but while educating the public to appreciate honey, we are doing a very great deal. Every year we find different means of gathering more honey and different methods of reducing the cost—labour saving appliances and so forth. If honey is to be made a popular commodity it will have to compete with jams, fruits, &c. Seeing there has been such an enormously increased output of honey and a gradual reduction in working expenses, we should reduce the standard of price to the public. At one time everyone expected to pay a shilling a pound. Should we not be doing better work by producing more honey and giving it to the consumer, and so cultivating the taste, making our extra profit by increasing the number of stocks, with a consequent larger output?

Mr. Burt remarked, as regards selling honey from the bee-keepers' standpoint, that it was a very good plan to encourage customers to take it in 3lb. bottles, the cost of which (the bottles) was a penny or less. It was only a matter of educating the public; the housewife should be encouraged to take a 3lb. bottle at a slightly reduced price, and the bee-keeper was practically as well off.

Mr. Herrod said one of the main factors in marketing honey had been only slightly mentioned by Mr. Frankenstein, and omitted altogether by Mr. Lamb in the proposed circular: that was the packing of honey, and that was where the bee-keeper failed more than in anything else. It was not difficult to sell honey, but the condition it arrived in when purchased was often indescribable. Under such conditions it was not to be wondered at that the purchaser was very loath to risk buying again. One of the greatest boons would be a leaflet describing "How to pack honey." Again, every producer seemed to imagine that the only market was London, the result being that the London market was glutted. He and his partner never tried to sell honey in London, but sold in the northern towns, where good prices were obtainable. Further, they did not believe in offering inferior produce at a very low figure. If this were done once the buyer was never willing to give a reasonable price for good sound honey afterwards. It was much better to use this as bee-food, or for the making of mead or vinegar.

(To be Continued.)

## HONEY SHOW AT CAMBRIDGE.

The honey section at the Red Cross Horticultural Society's Show, held at Cambridge, on September 13th and 14th last, was a decided success. The four classes attracted no fewer than seventy entries, just double last year's number, nine counties being represented by exhibitors. Passing mention should be made of the well-staged stand of Messrs. Baynes and Co., of Bridge Street, Cambridge. An observatory hive, where one could see the bees at work, was another centre of attraction. The prize list was as follows:—

### OPEN CLASSES.

*Six 1-lb. Sections.*—1st, R. H. Baynes, Bridge Street, Cambridge; 2nd, Edgar Law, Croydon, Royston; 3rd, W. Barnes, Exning, Newmarket; v.h.c., A. Barber, Comberton; h.c., H. W. Saunders, Thetford.

*Six 1-lb. Jars of Light Coloured Honey.*—1st, H. W. Saunders; 2nd, R. H. Baynes; 3rd, F. Humphrey, Comberton; v.h.c., F. Hurry, Sawston; h.c., A. C. Jackson, Elveden, Norfolk.

### GIFT CLASSES.

*Single 1-lb. Section.*—1st, R. H. Baynes; 2nd, J. Short, Garden Walk, Cambridge; 3rd, T. G. Hillier, Andover, Hants; v.h.c., H. W. Saunders; h.c., W. Barnes.

*Single 1-lb. Jar of Honey.*—1st, B. Stokes, Royston; 2nd, R. H. Baynes; 3rd, H. W. Saunders; v.h.c., W. S. Halford, West Wrating; h.c., F. Hurry.—*Communicated.*

---



---

## HONEY IMPORTS.

The value of honey imported into the United Kingdom during the month of September, 1911, was £4,189.—From a return furnished to the BRITISH BEE JOURNAL by the Statistical Office, H.M. Customs.

---



---

## AMONG THE BEES.

### THE GROCERS' SHOW.

By D. M. MacDonald, Banff.

If for no other reason, my recent trip to London would be a red-letter day on account of the time spent in the Agricultural Hall at the above exhibition of honey and other bee products. In itself it was a liberal education. Imagine about 900 bottles of honey in one single class—almost every entry capable of taking a prize in an ordinary show! All the other classes were splendidly filled, and, I think, all over, it was a record show—one of the very best ever seen in London. The judge, Mr. E. Walker, had an onerous and



herculean task to perform; a heavier one indeed than should be placed on the shoulders of any one man. I could not, and would not if I could, try to re-judge or even criticise the awards, but I am confident they were conscientiously given, and I know they met with general approval from those who ought to know. One or two features of the show may call for future reference; but the point which struck me most was the very limited interest shown in the honey exhibition, not by the general public attending the "Grocers," but by the large body of bee-keepers one would naturally expect to see deeply interested in such a magnificent display of bee products. Perhaps the hours I spent on Monday and Wednesday were unfavourably chosen? I hope so, most sincerely, because the attendance thoroughly disappointed me.

*The Olive Branch.*—Two or three points in the drafted Bee Diseases Bill deserve careful consideration from opponents of that projected measure. First, it has always been contended by Mr. Woodley and several other extensive bee-keepers that there was a danger of the inspector carrying germs from one apiary to another hitherto immune. I grant that with the ordinary run of third-class experts that danger might be very real, but I have always presumed that under the new regulations men of superior intelligence and more experience in bee-keeping would be selected for the post; certainly that no grade under the second-class should be permissible, and that, if at all possible, only first-class experts should be chosen for inspectors. This would be a guarantee that men of some standing socially and bee-keepers of wide experience in the craft should alone be eligible for this onerous and very important position.

A further suggestion thrown out at the last meeting of the committee for drafting the proposed Bill is also of great importance, and practically eliminates the supposed danger of infection through the instrumentality of the inspector during the examination of an apiary under suspicion. Mr. Woodley will pardon me for again introducing his name in my supposed illustration. Should he be the inspected and I the inspector (an impossible hypothetical supposition), *he*, not I, would have the privilege of doing all the necessary manipulations while the inspection was going on. He would do all handling of frames, use his own smoker, &c., and thus surmount a difficulty which correspondents say might arise. I can see no possible cause of friction, provided the inspector is a man of tact and urbanity, gifted with an ordinary degree of common-sense, and thoroughly conversant with all the necessary require-

ments arising from the duties of such an office as he would be called on to fill.

On yet another point, after mature deliberation, the committee held out the olive branch to placate opponents. Honey is undoubtedly one of the most common mediums for the propagation and spread of foul brood. Larvæ fed with infected honey are bound to die before reaching the imago stage, therefore many hold that honey from an infected apiary should not form an article of commerce. But how infinitesimal a quantity is ever used in a way to carry infection, and only a fool would use such honey to feed bees! On the contrary, honey consumed by mankind is in no way prejudicial, even if the germs of bacillus larvæ, or *B. alvei*, are present. Consequently, it would be folly to destroy healthy human food. This view of the case is met by the deletion of the words implying the destruction of honey in a saleable form.

I have always been an opponent of compensation in any form being introduced into any Act of Parliament for the suppression of foul brood or "Isle of Wight" disease. Of what value, may I ask, is a putrid mass of vile smelling matter? The most rabid must admit it is represented by a cipher! So, also, must a collection of diseased combs fast hastening to this unenviable condition. Why, the party who eradicates disease, or the cause thereof, is the one who should be compensated; therefore, another of the difficulties in securing an Act is got rid of.

*Records.*—In spite of what my friend, Mr. Marrs, states on page 344, my assertions on page 322 hold good—that the "Aberdeenshire" was the first Scotch association to affiliate with the B.B.K.A., and that "the examination held the last week of June was the first of its kind in Scotland"—that is, the first under the auspices of an association in Scotland in affiliation with the "British." I am pleased to learn that the roll of experts bore the names of several Scotchmen examined in Scotland before this year, and I know a few more crossed the Border to obtain the coveted degree.

*A Point of Order.*—"Apparently there were no young bees in the hive," says our "Capper," page 337. Who said so? I introduced a frame of brood, so there should be young bees somewhere. But apart from that, I do not fully agree with Mr. Crawshaw or the "books" in regard to the age when bees can perform certain duties in the hive. Bees age from the effects of hard work more than from actual length of days, weeks, or months. This admitted, there were *young* bees in that colony, apart from those produced from the brood in the frame inserted. I hold a very large proportion of these old-young bees, owing to the glands not being

atrophied by hard work, still possessed the power of manufacturing "pap," and so acting as nurse bees, or even preparing "royal jelly" for the creation and sustenance of a queen.

---

## Correspondence.

---

*The Editors do not hold themselves responsible for the opinions expressed by correspondents. No notice will be taken of anonymous communications, and correspondents are requested to write on one side of the paper only and give their real names and addresses, not necessarily for publication, but as a guarantee of good faith. Illustrations should be drawn on separate pieces of paper. We do not undertake to return rejected communications.*

### BEEES IN THE COTSWOLDS.

[8278] The glorious summer of 1911, with its long periods of delightful sunshine, has gone at last, and left behind pleasant memories of a honey yield of such excellent quality and quantity rarely experienced of late years in this island of weather samples." Bee-keepers in this district have every reason to be satisfied with the result, and also for the entire absence of the dreaded "Isle of Wight" disease. We cannot, however, boast of such heavy yields as some of the correspondents of a certain popular "daily" seem to have experienced.

My bees came through the winter in good condition, and built up rapidly in the spring, winter losses being exceedingly small considering the exposed position in which my apiary stands. The colonies located in the vale stored a considerable amount of honey from fruit blossoms, and when these were over I moved the bees a distance of seven miles out on to the Cotswold Hills, for the sainfoin and clover harvests. We started shortly before midnight, timing the journey so as to arrive at break of day, and although the weather was very hot and the track to the plantation rough, the bees travelled quite safely.

Of forty colonies, thirty-five were supered with frames and sections of foundation, and from these I have taken 1,200lb. of comb and extracted honey, and have on hand 200 drawn out shallow combs, which should secure me a crop next year, even if the season is a poor one. From the strongest colony I took 100lb. of extracted honey, from the next 85lb., and from the remainder quantities varying down to ten sections; most of these having sufficient stores left for the winter. By the way, your judgment of the sample of honey sent early in the season has been proved to be sound by my success on the show bench, both in local and open classes, at various shows.

During the past two months I have rescued thirty-five lots of bees from the sulphur pit, and have used them for strengthening and re-queening weak stocks and establishing new ones. But for the poor swarming season I should have probably driven more, as many cottagers with six to twelve skeps had only one swarm, and several none at all. By this means I have increased to sixty-five colonies, most of these, having taken 20lb. of medicated syrup, are settled for the winter.

Driven bees, if headed by a young queen, usually turn out well, for the majority of stocks once inhabited the quaint, old-fashioned dome of twisted straw. On the whole, I do not experience much inconvenience in having bees six or seven miles from home, and although the railway runs close to both apiaries, I rarely take advantage of it, as cycling to and fro is such healthy exercise. The chief disadvantage is that the owner cannot be always with his bees during swarming time, but if they are worked on a non-swarming system—as mine are—no loss is risked.

In concluding, I may say that any success which I have attained is largely due to the thorough grounding I received in bee-keeping while a pupil of one of the largest and most experienced apiarists in this county, and who was once a frequent contributor to your valuable journal.—A. H. BOWEN, Cheltenham.

---

### UTILISING DRIVEN STOCKS.

[8279] One often unites two driven lots of bees in order to make one colony of reasonable wintery strength. This means generally the sacrifice of one of the queens—possibly the best one.

To avoid this sacrifice, divide an ordinary hive into two compartments by means of a "Wells" perforated division-board. Place a driven stock of bees in each compartment. To keep the stocks well separated when entering the central portion of the entrance should be closed with a slide, and then each colony enters at its own extreme end of the alighting-board. If the hive has frames parallel to the entrance, then an entrance for the second stock must be made at the back of the hive. This dual stock will cluster as one on both sides of the division-board, and in spring, having the advantage of two laying queens, they will multiply so rapidly that soon they will need transferring to two separate hives. If, by chance, one side proves queenless in the spring, the removal of the division-board is all the manipulation necessary safely to unite the two stocks.

This plan has given me excellent results for years. Sometimes, instead of transferring the two stocks to separate hives,

another hive is added above; but if this is done great care is necessary that the "Wells" division-board above fits accurately on to the one below. When the honey-flow comes, place an excluder on the doubled hive, and add a super to which both stocks have common access. It is surprising how rapidly such supers are filled, even in comparatively low average seasons. The tedious process of making several "Wells" division-boards can be simplified by making one out of board an inch thick. This can be slit into four thin boards at any shop where steam band saws are in use.—E. A. MILLWARD, Kidderminster.

#### DEALING WITH "I.O.W." DISEASE.

[8250] I think it would be well, seeing that Messrs. Muir and Son so kindly write "for the benefit of brother bee-keepers" (page 407), for them to inform readers how they came by this "I.O.W." disease, and when it first appeared. Also they might give a short account of how they treated this isolated stock that has proved such a complete success. Have they set up their 97 new stocks this autumn on their old stock combs? And what has been their total yield of honey this season? How did they disinfect their hives, etc.? It would be interesting to know where did this neighbour of theirs purchase the bees that had to be burned four days after they came? A plain account from their own experience will, no doubt, clear up much of the mystery that still surrounds this dreaded foe, and will also confer a boon on many bee-keepers.—A CONSTANT READER.

## Queries and Replies.

[8238] *A Novice's Queries.*—(1) I am sending you a queen, and would be glad if you would examine her and tell me, through the "B.B.J.," what is wrong with her. She has headed a stock which this year has given me nearly 100lb. of surplus, but gave up laying about the middle of September, and there is now no brood of any description. I don't know her age, as I only bought the stock in March. (2) I have a young English queen, raised this year, and half of her progeny show two tints of yellow, the other half being ordinary blacks. A sister queen produces true blacks right through. There were no Italian bees within half-a-mile of my hives when these queens were fertilised. Is this a case of breeding back? (3) Is it necessary to have contamination to get foul brood?—J. M., Warrington.

REPLY.—(1) The queen (now dead) should not have been removed, as she was a good one. Queens ceased laying very early this year. (2) The queen has been mated to an Italian drone. This is not unusual, if there are Italian bees within two miles. (3) We suppose you mean can foul brood develop spontaneously without infection from other sources; if so the answer is "No."

[8239] *Time for Transferring Bees.*—Might I ask your advice in a difficulty? (1) I have purchased a hive and bees, and find the hive is an old one. When and how can I transfer the bees into a new hive, as I find the frames are full of stores, but cross-braced to one another and to the sides? (2) In the new hive can I feed the stock without giving them their own stores, starting the season with new frames and new foundation?—W. P., Wainstead.

REPLY.—(1) You must wait until the spring, then cut away as many of the braced-combs as possible, replacing them with new frames fitted with full sheets of wired foundation. These will be built out, and as the brood hatches from the remaining braced-combs, which should be pushed up to the outside of brood-nest, cut away again, and replace until all new frames have been inserted. (2) If you feed the bees it will facilitate the work, but they will use up the food in the old combs.

#### RANDOM JOTTINGS.

*By C. H. Heap, Reading.*

The wasp plague is at an end, for which bee-keepers in general are truly thankful. Under the favourable influence of the wonderful summer just past, the gay marauders began their depredations in the apiary very early. In the middle of July a beginner in bee-keeping asked me to have a look at his hive as the wasps were going in and out in large numbers. I went. The wasps were hovering around in hundreds, and I saw at a glance that they were in complete possession. Without the formality of an ultimatum, we commenced hostilities. Approaching the first hive, we narrowed the entrance, and then shot through it a withering blast of sulphurous vapour. The brigands were taken by surprise. What a commotion there was! Just enough yellow jackets escaped to tell the tale; but we might have saved ourselves so much trouble. The colony, which had swarmed, was headed by a young queen, but when at length the hive was opened not a bee was to be found, dead or alive and the honey, with which the hive was well stocked a week before, had also vanished.

In the RECORD for September I noticed "W.H." had a good word for the work of the wasp in general. It is possible that bee-keepers are indebted to them more than they think. Many an old hive reeking with the germs of foul brood will have been rendered by them unattractive to the bees; and as to the scavenging in the apiary in these days of "Isle of Wight" disease, its value is probably incalculable. This summer, in more than one apiary, I was interested in watching the wasps hunting for the diseased bees which had left the hive to die. Without waiting for dissolution, the wasps, with their powerful mandibles, cut off the head, the wings, and legs of the living bee. Then, getting the corpse nicely clasped with their feet, off they flew to their vespiaries. The fondness of the wasp for fresh though somewhat unsound meat undoubtedly led to the prompt removal of these sources of infection.

*Driving Bees.*—This leads my thoughts to bee-driving expeditions. At the request of a neighbouring bee-keeper, who found himself unable to keep the engagement, I cycled to a village just over the Hampshire border, in which the skep system still prevails. Fortunately I had a good look round the apiary before commencing operations, and discovered "Isle of Wight" disease. After advising the skeppist to resort on this occasion to the sulphur pit, I visited another bee-keeper and discovered a similar state of things. Here, too, I tendered a little advice and returned empty away.

*An Interesting Visit.*—A pleasanter experience befel me another day, the relation of which may interest a few of the older bee-keepers in Oxfordshire. During a quest in South Oxfordshire for condemned bees, I was directed to some almshouses, in one of which, I was told, lived a septuagenarian bee-keeper. I found the old gentleman and introduced myself. I shall not soon forget the merry twinkle that appeared in his eye and the gentle shake of his head when I mentioned the object of my visit. Instinctively I knew that I had not found a skeppist. The old bee-master is one of Nature's gentlemen, and my mistake was, therefore, by no means embarrassing. We both enjoyed the joke, and settled down for a pleasant chat, after which we visited the apiary, in which were fifteen bar-frame hives, most of which were home-made. A curious hive attracted my attention. It was of American manufacture, costing, when new, about 50s. The purchase was made after reading a description of the merits of the hive; but when it arrived no frame usually made in the United Kingdom would fit it. V-shaped frames were necessary, so these were made at home, and subsequently the height of the

hive was slightly increased in order that it might take a special rack containing sections. Notwithstanding its peculiarities, bees, I was told, have always done well in this hive. All the hives in the apiary were not full, because "Isle of Wight" disease had for three years in succession done its worst. Nevertheless, the veteran apiarist was still enthusiastic and hopeful. Returning to the house, my host, after rummaging in the drawer of a dresser, handed me a package wrapped in paper, and a little case, saying: "Perhaps these will interest you." They did interest me. The case contained, to my agreeable surprise, a silver medal given by the British Bee-keepers' Association for the best comb-honey at the Oxfordshire Bee-keepers' Show in 1874. The reverse of the medal bore the name of "H. Edgington," and the cards, of which there were fully a score, showed that Mr. Edgington, who formerly lived at Cassington, had for a series of years been a prize-winner (mostly firsts). Mr. Edgington said that when he was younger he was an active member of the Oxfordshire Association, and did much in his own neighbourhood, gratuitously, to spread a knowledge of modern bee-keeping. On the morning of my visit he received an order for bees, and was planning to borrow a pony cart (for he is troubled with a bad knee) in order to enable him to go on a driving expedition.

---

#### CAPPINGS OF COMB.

BY L. S. CRAWSHAW, NORTON, MALTON, YORKS.

*Hornets' Nests* (p. 356).—Reports of these in the North are rarely correct; at least, I have visited many reported finds, but none have proved to be the real thing. Usually it is the wood wasp, which makes the hanging nest, and occasionally other species, for the layman is delightfully vague as to what constitutes a wasp, or even an insect. Thus, the *Yorkshire Evening Post*, a paper of considerable repute, published in a recent edition a sketch of a large sawfly, which it described as a wood wasp! Generally speaking, any small creeping or flying creature is an "insect" in England, just as it is described in America by an even less pleasant and more significant term.

*Price of Honey* (p. 356).—I must confess to more than a sneaking sympathy with W. S. S. in his diatribe against those who paint only the glowing side of bee-keeping. But then, I am probably one of those pessimists who are never known to smile! On the other hand, I don't see why he should be any less praiseful to Providence for a good crop, in view of the poor prices offered for it. Thee must blame where blame lies, friend! But 6s. per

doz. for best sections does not pay for correspondence or packing. At that rate, there is some justification for the adage that "fools raise sections, wise men buy them." They are worth at least 8s. per doz. unglazed and undelivered. After all, price depends largely on the bee-keeper, his ability and energy. Those who are doubtful whether they possess these qualities would do well to read again the excellent article by J. E. Pinder on page 363. I believe that it would pay bee-keepers to buy up the honey of those neighbours who habitually lack energy to obtain a proper price for their product. The difference between their price and the retail simply goes, without benefiting the public, into the pocket of the middleman, who knows his market, whilst at the same time assisting to depress the price paid to bee-keepers generally.

*A Honey Depot* (p. 363).—It is interesting to note the constant recurrence of a demand for a central depot. It would, however, be much to the point if those who call for this channel were to formulate the conditions upon which it should be run. Incidentally they should enquire into the causes of failure of similar efforts in the past. It is a difficult subject. The demand for honey fluctuates more than that for, say, butter or eggs, and a depot selling honey alone might have some very slack quarters of an hour.

*A Scotch Joke* (p. 365).—A perplexed apiarian proposes a conundrum as to whether one can have a bonnet without a "b." Feeling incompetent to solve this, I referred it to an expert in headgear of the beehive description, who said, "Certainly, a toque!" But even so, we were not free of natural history tenants, for she described one befeathered nest as a duck of a hat. "Now, here," she went on, "is a lovely model, and so cheap, only 30 guineas!" As I fled, I meditated upon the significance of other letters of the alphabet, as L, and S, and D.

---

## Bee Shows to Come.

---

**Oct. 31 and Nov. 1, at Brighton.** Sussex B.K.A. Show in connection with the Brighton and Sussex Horticultural Society's Chrysanthemum Show. Free Open Classes. Schedules and Entry Forms from C. A. Overton, Bacroft, Crawley, Sussex. **Entries close Oct. 24.**

---

## Notices to Correspondents.

---

W. A. C. (Somerset).—*Bees Dead Behind Division-board.*—October is very late for syrup feeding. The bees should have been confined by means of the

dummy to just the number of combs they could cover. Your advice with regard to candy was quite correct. The Hon. Secretary of the Lancashire B.K.A. is Mr. W. H. Martin, Thurston Lea, Cambridge Road, Southport.

L. B. (Lancs).—*Variety of Bee.*—It is a fertile Italian-hybrid queen.

W. T. (Middlewick).—*Partly Stored-combs.*—Keep the combs in a dark, dry, warm place, and they can be used as baits next season to attract the bees up into the supers.

T. D. (Merthyr Tydvil).—*Honey Samples.—Drone Brood in October.*—(1) The samples duly reached this office, but it is impossible to report upon honey sent in such receptacles. Let us have it in small glass bottles, and we will endeavour to help you. (2) It is unusual to find drone brood at this time of the year, and it almost appears as if the queen were old and the bees preparing to supersede her. There is no occasion to remove the brood, but if the queen is too old she should be replaced by a new one.

A. E. T. (Malden).—*"Balled" Queen.*—The queen is a fertile one, and the bees have evidently "balled" her through your carrying out manipulations so late in the year. It does occur sometimes if the hive is disturbed in this way very early or very late in the season.

H. T. (Eccles).—*Drones in October.*—It is almost a certain indication that the bees are either queenless, or they have a virgin queen.

H. S. (Oxford).—*Insect Nomenclature.*—(1) The insect is not a bee at all, but a drone fly. (2) A little honey is still being stored on fine days from the ivy. (3) Yes.

A. J. W. (Earnley).—*Varieties of Bee.*—No. 1 are ordinary English bees. No. 2, hybrids, from English queen mated to an Italian drone. No. 3 are similar to No. 2. No. 4 is not a bee, but a young queen wasp.

A. D. (Cheshire).—*Supers in Winter.*—(1) Yes, see that they are well covered up, naphthalene being used to keep out wax-moth. (2) The feeders should be removed and everything packed snug and warm. It would not do to leave the feeder on all the winter. Candy is the best auxiliary winter food.

A. V. W. (Gloucester).—*Age of Queen.*—The queen is an old one, and 1909 should be about right, judging by her appearance.

F. C. I. L. (Chesham).—*Keeping Honey in Tins.*—If placed in a proper lever-lid airtight tin, the honey will take no harm. See that the lid is properly fitted on each time after opening.

*Honey Samples.*

- M. O. (Groeslon).—Sample is a medium honey from mixed sources. Colour is rather dull, but would be improved by warming.
- X. Y. L. (Todmorden).—Honey is of very poor quality, and is worth about 6d. per lb.
- NOVICE (Newcastle).—Both samples are of very good quality, gathered from white clover. No. 1 has granulated beautifully, and as such should certainly be exhibited. The other also would stand a good chance on the show bench.
- T. H. (Llanidloes).—No. 1 is a good heather blend; the presence of the heather honey was the cause of your having to squeeze it out of the combs. It is worth 11d. to 1s. per lb. wholesale, and 1s. 3d. retail. No. 2 is from clover with a very slight trace of heather; this is worth 1s. retail, and in bulk 7d. or 8d. per lb.
- NEWCASTLE READER.—Sample No. 1 is a light honey of fair flavour, gathered mainly from clover. It is poor in density. No. 2 is also a light honey from the same source; density fairly good and flavour good. No. 3 is the best sample of the lot. It is from white clover, and good in all respects.
- H. C. (Droitwich).—A honey of delicious flavour from fruit blossom. Though darkish in colour, its flavour should make it sell well.
- A. B. C. (Herts.).—Samples of honey were not properly packed. The tin in which the bottles were enclosed should have been cleaned of the sugar dust, &c., which it contained, before being used, and some of the bottles were made of green glass, which prevents our judging of the colour. No. 1 is from mixed sources, worth about 50s. per cwt. No. 2 has been gathered from sainfoin, and should sell at 56s. No. 3 is the same as No. 2, but, being nicely granulated, can be shown in this class. No. 4 is mainly from fruit blossom, worth about 50s. per cwt. No. 5 resembles No. 1. No. 2 is the best honey, No. 3 being next in quality.
- T. J. (Abington).—The honey is a very good heather blend, nicely granulated, worth about 1s. per lb. retail, wholesale 8d.
- W. G. (Lytham).—The dark sample is from sycamore, and the light one from clover. The latter is good in every respect except density, but might be exhibited. The former is not suitable for the show bench, though it is a good table honey.
- Suspected Disease.*
- N. G. (Beckenham).—The bees are apparently suffering from "Isle of Wight" disease, and you had better destroy them. The sample of comb contains

- pollen only; the honey from such combs can be used for home consumption.
- T. H. (Llanidloes).—You followed the right course in destroying the combs, as they showed that virulent foul brood was present.
- NOVICE (Denbigh).—The bees are badly constipated, and there are slight outward signs of "Isle of Wight" disease.
- ENQUIRER.—The comb is badly affected with foul brood. The bees should be killed and the combs, internal fittings of hive, and all débris should be burnt. Then scorch the hive itself inside with a painter's spirit lamp.
- L. F. (Eastleigh).—The bees were very dry, but the signs are suspiciously like "Isle of Wight" disease.

**Special Prepaid Advertisements.**

**Two Words One Penny, minimum Sixpence.**

*Orders for three or more consecutive insertions on title advertisers to one insertion in "The Beekeepers' Record" free of charge.*

*Trade advertisements of Bees, Honey, Queens, and Bee goods are not admissible at above rate, but will be inserted at 1d. per word as "Business" Announcements, immediately under the Private Advertisements. Advertisements of Hive-manufacturers can only be inserted at a minimum charge of 3s. per ½ in., or 5s. per inch.*

**PRIVATE ADVERTISEMENTS.**

**6** CWT. good WORCESTERSHIRE HONEY, 42s. cwt, rather dark; sample free.—BONELL, Witley Court Gardens, Worcester. n 78

**S** EVERAL 4-frame Nucleis, with young Queens, 12s. each; with good W.B.C. Hives, 20/- each. WILLETT, JUN., New Malden, Surrey. 1 1

**S** PLENDID LIGHT CLOVER HONEY, 58s. cwt.; sample, 3d.—ALBERT COE, Apiary, Ridgewell, Halstead, Essex. n 100

**4** HIVES of BEES FOR SALE, healthy, fed up for winter, 22s. 6d. each.—GILBEY, Bretton West, Wakefield. 1 3

**H** ARES FOR SALE, 6lb. and 8lb. each.—PHILIP JONES, Blakeney, Glos. n 94

**F** OR SALE, Sections of Honey at 8d.—Mr. BLUETT Moreton, Bideford. n 95

**D** RIVEN BEES, Queen with each lot, wanted.—Particulars to KEEBLE, Mawneys, Romford. n 96

**8** DOZ. well-filled Light Coloured Sections, glazed, 9s. per doz.—W. ADAMS, Claremont Villa, Welwyn, Herts. n 97

**S** IMMINS' Double Conqueror Hive wanted, must be cheap.—TAYLOR, 137, Keldgate, Beverley. n 98

**W** ANTED, 3cwt. Light Honey; sample.—R. CARTER, Chartridge, near Chesham, Bucks. n 99

**W** HAT OFFERS for 7 dozen 1lb. screw top jars of Good Light Honey?—L. W. MATTHEWS, Great Rollright, Oxon. 1 2

**L** IMNANTHES DOUGLASII; strong plants, 4d. per score, post free.—R. LITMAN, Castle Cary. 1 4

## Editorial, Notices, &c.

### BRITISH BEE-KEEPERS' ASSOCIATION

#### THE CONVERSAZIONE.

(Continued from page 414).

Mr. Stapley said he did not agree with Mr. Herrod as to selling second-grade honey. This should be kept for a separate market, and the lower-grade shops should have this honey. He kept over 100 hives, and having found himself with a surplus which his ordinary customers were not prepared to take, he came to London to sell it. He went to a shop near London Bridge and put his sections before the buyer. This man said he was buying glazed sections at 7s. 9d. a dozen delivered, and was selling them at 1s. each. Another establishment he visited near Moorgate Street was retailing 1lb. jars at 10½d. each. He advertised his sections in the *BRITISH BEE JOURNAL*, and the whole of the 1000 sold at once, and 2000 more could have been disposed of if he had had them. With regard to knowing the value and market price of honey, they could do as he had done: send a small sample to Mr. Herrod, and back per return of post would come a report with the figure at which it should be sold. What Mr. Herrod had done for him he was quite sure he was ready and willing to do for anyone.

Mr. Steventon suggested educating the public by means of introducing bee-keeping into the schools, considerable latitude being given in the educational code. In his own school great enthusiasm was shown by the boys, several of whom were absolutely bee "lunatics." One boy is saving every penny in order that when he leaves school he can have his own hive, and a brother is saving up so that he can also help him. In this way people get to know the value of honey and purchase it.

Col. Walker said, with reference to packing, that the great difficulty arose from the weight of the package. This year, like many others, he was surprised by the unexpected produce, and did not know what to do for bottles, as they could not be obtained anywhere. He had a gross of paper jars stored away, and filled about a hundred of these. The honey went into them satisfactorily, and the people who have had them said they were very neat. The weight was about 2oz., as against the 8oz. of the jars.

Mr. Ceiley said he had sold about 200lb. of surplus. He could get 1s. per lb., and should not think of selling at less. He was employed in a bank and sold it amongst the clerks. If he had had more than they could take he should have gone into other banks, and so found customers at a very remunerative price.

Mr. Reid, in speaking of the attractiveness of honey properly put up, said the Japanese excel us in this respect, and referred to a jar which was shown at a previous conversation. The Americans go to other extremes and sell "chunk" honey, and if they get any imperfect sections they cut them up and put them into bottles, with the pieces of comb floating about. A good plan was to give away samples as an advertisement. Small sections are produced in America, one quarter the size of the ordinary one for this purpose.

Mr. Cowan, in closing the discussion, mentioned the British Honey Company started some years ago, but which failed chiefly on account of the difficulty of getting a regular supply. They had to give up because there was not a sufficient supply of British honey. Since that time the production of honey has increased enormously, now most bee-keepers have no difficulty in selling their produce if they go about it in a business-like manner. One reason why honey fetches so low a price is because people rush it into the market at the end of the season, but if they were to keep it for some time they would obtain a much better price.

Mr. Frankenstein, in reply, said that it was impossible to fix a standard price. Selling was a question of business capability, and depended upon the ingenuity of the bee-keeper. Grading was very desirable in the case of sections, and also with bottled honey. Inferior honey should be sold for manufacturing purposes.

Mr. Cowan proposed a vote of thanks to Mr. Frankenstein for the excellent paper he had read, which had opened a very useful discussion. This was duly accorded, and Mr. L. Snelgrove then read a paper on "Re-queening" as follows:—

"The practice of preventing natural swarming, which is such an important factor in the production of large crops of honey, has caused artificial re-queening to become one of the most important, if not the most important, feature of modern bee-management.

No work in the apiary admits of so much skill on the part of the bee-keeper as queen-rearing and re-queening, and as all of us who have been visiting experts know, such work, if not entirely neglected by small bee-keepers, is commonly performed in unscientific and unprofitable ways. If I were asked my opinion with regard to the lines on which the art of bee-keeping may be expected to improve, the two most important points in my reply would be: The improvement of stock by more general, systematic and scientific selection and rearing of queens; the reduction of the prevalence of disease.

The latter, however, would undoubtedly be a result of the former, so that we can

say that the one broad avenue of development open to the bee-keeping industry is that of the improvement of stock. The fact should not be lost sight of that since queen-fertilisation is practically uncontrolled, the production of every good queen may in some degree, through the agency of her drones, beneficially affect the stock of the whole country, while on the other hand, every inferior queen reared tends to perpetuate and accentuate undesirable qualities. I do not propose this evening to deal with the admirable and efficient methods of queen-rearing as practised by the professional queen-rearers, but to criticise and to make suggestions with regard to the methods of renewing queens which are commonly practised by amateurs.

It is generally recognised that the prosperity of a colony of bees depends upon the fertility of its queen, and that this fertility is at a maximum when the queen is some twelve months old. Writers on bee-keeping often express this fact by saying that a queen is most prolific in her second year, and not infrequently we find that this is interpreted as meaning at the age of two years. The prolificness of a queen, of course, depends, amongst other things, upon the work she has done, and it may sometimes happen that where her flying powers have been restricted by circumstances, such as being kept in a nucleus or a succession of weak colonies during her second summer, she may be wisely kept another year. Similarly, a queen that has displayed exceptionally great fertility should be preserved to the third season, not only because she will do better than many a young one, but she should be utilised for breeding. Apart from these exceptions, however (and they are only exceptions which prove the rule), it should be a general principle for every bee-keeper that his hives be re-queened annually. Before criticising the methods commonly adopted for renewing queens, it may be as well to call attention to the conditions essential to the rearing of a prolific queen. It is important that she should be bred from a mother who has displayed great fertility, and who is consequently at least a year old. She should be reared in a strongly-populated hive capable of maintaining the requisite temperature, and in the presence of large numbers of young bees, who themselves have access to plentiful supplies of honey and pollen. Further, she should be fed as a queen from the first day of the larvæ stage, and should be ready to fly at a time when young drones are plentiful and vigorous. Careful, but somewhat limited observations have led me to believe that the neglect of this last condition accounts for the great majority of indifferent queens reared in the late

summer. The drones are then comparatively few, and the result often is that the young queens fail to become mated until the third week. In 1910, owing to the wet weather, I had several young queens fertilised in their third week, and in every case they have turned out less valuable than older queens, whereas their sisters, reared in the same hives, at the same time, and under the same conditions, but mated in their first week, have headed splendid and profitable colonies. It would not be safe, of course, to generalise from the results of such limited observation, but there appears to be some *prima-facie* evidence that the earlier queens are mated the better. I hope to subject this question to the test of experiment during the coming year. The lack of vigour in aged drones unnaturally preserved in queenless colonies must render them more or less incapable of efficient fecundation, for what holds good of the youth of farmers' breeding stock may reasonably be assumed to hold good in the case of the drone. It is obviously desirable, therefore, that until all queens are safely mated the bee-keeper should provide for a succession of young and vigorous drones, and also should see that they are caused to fly in great numbers. Queenless colonies preserve their drones, but strong stocks will not only preserve, but continue to produce drones out of season if they are liberally fed. I have found that a bottle of thin syrup given to a colony containing drones about noon will cause them to fly vigorously and in increased numbers. I have practised this during the present year, when young queens have been flying and have had all of them successfully mated, some as late as the middle of September.

Where the only re-queening effected is that resulting from natural swarming, the conditions respecting population, food, temperature, nursing, and drones are ideal, and strong, vigorous queens result. Those who depend on this system, however often vitiate it by serious errors, for they fail to take advantage of selection, which is easily accomplished by utilisation of ripe cells from the best stocks, and they preserve the old queens which head their swarms. This latter error is often due to the common misconception that the swarm being a new colony is headed by a young queen.

We are all familiar with the cottager who so unduly prizes what he calls a "young" stock, and who at the same time is quite willing to allow his "old" stock containing his young queen to be driven and taken away. It is a common fallacy that old queens may be retained, because the bees know best when to re-queen themselves. Unfortunately, they usually refrain from doing this till the old queen



has been for some time unprofitable, owing to her failing powers. Besides, such natural re-queening often takes place at very inconvenient times—*e.g.*, in the middle of a honey-flow, or in the autumn. Three years ago I watched the bees in my observatory hive re-queen themselves in September. The young queen was never mated, as there were no drones, and this, of course, would have entailed the death of an ordinary colony during the winter. Indeed, my experience of natural re-queening leads me to believe that it is always attended by a period of unprofitableness, if not followed by the loss of the colony, and that the loss of many a fine colony, attributed by the bee-keeper to an *ictus dei*, is due to the retention of an old queen followed by an abortive attempt at natural re-queening. I know some bee-keepers who endeavour to ensure the renewal of queens by returning swarms to their parent hives and killing the old queens as they run in. Extra super room is given at the same time. The advantages of this method are that young queens of the best quality succeed the old ones, and the stocks seldom require autumn feeding. The advantages, however, are greatly out-weighed by the disadvantages, for not only will swarming often be persisted in, but the absence of a laying queen from the hive for three weeks or more causes the honey coming in to be stored in the brood-nest instead of the supers. I have heard of cases this year where the brood-nests were completely filled with honey, and had they not been relieved by the abstraction of honey and the substitution of foundation, the young queens would have had no room to lay, and their stocks would certainly have dwindled very seriously. A further consequence of the absence of a fertile queen, during the weeks succeeding swarming time is that the reinforcement of the foragers ceases in July.

This method makes no provision for re-queening those stocks which may really need it most, namely, those which do not reach the swarming pitch. It has the further disadvantage of tending towards the extinction of the non-swarmers and the direct encouragement of the swarming instinct. The easiest, perhaps the most common, and certainly the most slovenly mode of renewing queens is that of merely killing the old queen at the end of the summer and leaving everything to chance.

In this method few, if any, of the above-mentioned conditions essential to the rearing of first-rate queens are present. The hive is without a fertile queen for a month, and during this period the population is dwindling at a greater rate than at any other time of the year. In their

haste, the bees rear a number of queens, some, perhaps, from larvae of the second or third day, and if the weather is bad, stores short, and the feeding-bottle absent, these larvae are frequently underfed. The resulting queens are usually smaller and less robust than those hatched under better circumstances, and although the differences may be so small as not to be apparent to the bee-keeper, the cumulative effect of breeding successive generations of queens under such unnatural conditions is unmistakably reflected in the profit and loss account. Of course, we all know that the method sometimes appears satisfactory, but a few precautions on the part of the bee-keeper will make it less objectionable. In the first place, a frame of new comb, containing eggs laid by the best queen in the apiary, should be placed in the centre of the brood-nest the day before de-queening. The colony should then be made extra warm, if necessary, and supplied liberally with syrup, preferably that containing honey. I regard this latter point as of such great importance that I would feed a queen-rearing colony, even if I had to abstract sealed stores to do so. The feeding not only produces heat, but stimulates the natural secretory functions of the nurse bees, and ensures that the queen larvae are abundantly supplied with royal jelly. Besides, continuously-fed queenless stocks do not seem to dwindle nearly so fast as hungry ones, and the conditions in such stocks both with regard to queens and drones are more favourable to the accomplishment of fertilisation. It is wise to examine the hive on the fourth day after removing the old queen. Should there then be any sealed queen-cells they should be broken down (provided, of course, that there are good unsealed cells as well), for they will have been reared from larvae of the second or third days, and as these will hatch out first if allowed to remain, the younger and superior queens will perish. In practice it is seldom found necessary to do this, but short, early-completed cells are occasionally found, and they should certainly be destroyed. The various ways of utilising nuclei for re-queening are in themselves excellent, though they involve much extra work. For instance, it is a capital plan to divide a stock which has just swarmed into several nuclei, each with a queen cell. The novice, however, is inclined to form too many of these nuclei, with the result that the requisite temperature is not maintained.

Further, such nuclei should not be formed until the queens are almost ready to hatch: for then they will be unlikely to suffer from daily variations in the temperature of a nucleus hive. In this connection I am reminded of certain bee-

keepers who actually rear their queens through all the stages in nucleus hives. It seems almost unnecessary to comment on the undesirability of such a system. Extremes of heat by day and cold by night, and often the lack of sufficient young bees to feed adequately a single royal larvæ, are just the conditions which will produce worthless stock. The purchase of virgin queens is extensively practised, and when due care is taken this is a capital means of re-queening. It is to be feared, however, that virgin queens are often kept prisoners so long either by the seller who waits for his customer, or by the customer who has not prepared his hive, that the earliest and best days for the marital flight are lost, and the continued existence on unnatural food has a deleterious effect on organic development during a critical period. Where these dangers are avoided the method is sound, and has the great advantage that a desirable crossing of unrelated stock is attained. Taking into consideration, however, the difficulties of introducing virgins, and the uncertainty of their ultimate value, it would seem to be more satisfactory to the small bee-keeper to pay a little extra for fertile queens. For the inexperienced, for the busy amateur, and for the small bee-keeper, the purchase of fertile queens from reliable queen-rearers is undoubtedly the best method of renewal. Few amateurs can hope to rear queens under such good conditions as those enjoyed by our largest professional breeders, who not only breed from excellent mothers, but are able to a great extent to control fertilisation by swamping a neighbourhood with selected drones.

I have recently elaborated a method of re-queening which is easy, efficient, and suitable for all. The following are the main points:—

On removing the supers in July, the brood-box is divided into two parts by a closely-fitting division-board. Behind this are placed four frames of bees with the queen, one frame containing brood, the others either empty or containing little stores. A  $\frac{3}{4}$ in. hole bored in the floor of the hive about 2in. from the back serves for egress for the bees, and a suitable small alighting-board is affixed. The hole is closed by a cork when not in use. An extra frame of bees is shaken into this compartment to compensate for those bees which return to the front.

The greater part of this stock with the young brood will occupy the front of the hive, and this compartment is then suitably arranged for queen-rearing. Both compartments are then fed. The crowded state of the front compartment is specially favourable for queen-rearing, and the old queen makes a good brood-

nest at the back. The mutual warmth is conducive to the general prosperity. Both queens, and particularly the old one, are encouraged to lay until the autumn, when the division-board is removed and the two stocks are united, with the young queen at their head. The limited time at my disposal does not permit me to deal with some important details of management.

I claim the following advantages for the method:—

(1) There is no period of queenlessness. (2) The young queen may be reared under very favourable conditions, heat being in particular economised. (3) The stock goes into winter strong in bees and thoroughly supplied with brood and food. (4) Should the young queen fail to be fertilised the old one may still be permitted to head the colony. (5) If purchase is decided upon the young, fertile queen can be inserted in the queenless compartment by one of the ordinary methods in the first instance, and time is gained. The old queen may be stimulated right up to the winter, while the younger one may be permitted to rest early. I have on two or three occasions wintered both queens and removed the old one in the spring. I am inclined to think there is little or no advantage in this, however, and now remove and destroy the old queen in the autumn."

(To be continued.)

---



---

## HELPFUL HINTS FOR NOVICES.

By W. Herrod.

PREPARING FOR WINTER.

(Continued from page 403.)

Avoid covering the roof with zinc, for although well painted it will attract the heat in the summer, and in the winter it is very cold; further, no matter how snugly it is fitted there is bound to be a certain amount of condensation of moisture on the underside, and this does harm by slowly rotting the wood. I have seen old sacking thrown over the roofs of hives with the idea of keeping them watertight, on the top of which bricks are laid to keep it from blowing off. A better or more complete way of totally ruining even the best roof could not be found, as the damp is kept continually present under the bricks, and consequently the woodwork rapidly decays. If a roof cannot be made watertight without this addition the sooner it is chopped up for firewood the better. Another plan followed is to bend a piece of corrugated iron to the shape of the roof, and lay this over the top loosely, again using bricks to keep it in place. This has all the disadvantages of the close fitting zinc, and is further detrimental

inasmuch as in rough weather the wind moves the iron, and there is jarring and noise which excites the bees and causes them to take more food than is good for them, probably resulting in dysentery, the action being exactly that of smoke or carbolic fumes, it frightens the bees. Even rain beating on corrugated iron will disturb the bees; it is a very bad covering for this reason. A remark I heard one day explained this very tersely; it was that if it looks like rain it rattles.

We next attend to the floorboard, and in all cases this should be well painted on the underside to protect it from the damp which rises. See there are no chinks right through, or there will be a draught through the brood-nest in the early and most important part of the year; the spirit level should be used, the floorboard should be quite level from side to side, and slope about half-an-inch to the front. If the hive tilts ever so slightly to the back, it is impossible to keep the interior dry. Moisture, which condenses during the winter, will saturate the debris caused by chewed cappings which collect on the floorboard, so providing a damp mouldy mess, bad for the bees in every way, and making them more susceptible to disease, and often I have seen this a seething mass of maggots, the offspring of other creatures. Again, when it rains the wet will draw in, and the same thing will happen from melting snow; therefore the slight tilt does away with all these drawbacks.

The next thing is to pack down inside, first placing naphthaline in the brood-chamber, and then winter passages over the tops of the frames, see "Guide Book," page 191. Curiously enough bees will not pass down and under the combs during very cold weather, but will go over the top. It is no unusual thing to see seams of bees dead on empty combs through starvation while in the combs adjacent on both sides there is an ample supply on account of winter passages being omitted. See the calico quilt sits down tightly all round, then put three or four good thick quilts on top, also seeing that they fit properly. They should be neat and clean; there is a general idea that anything will do to cover bees, and often one sees most disgusting material such as guano bags used for this purpose if no better material is to hand. Then get a number of newspapers, fold them neatly, and cover with these; they form a very warm covering and are quite clean. To keep down moths break up into fine powder a couple of balls of naphthaline and sprinkle this amongst the quilts.

If the slightest doubt exists as to the food supply, a cake of candy weighing one pound should be placed over the cluster of bees when finally packing down. Candy-making to some people is a gigantic

and difficult task, but if pure cane sugar is used, and the recipe given in "Guide Book," Coronation Edition, page 195, is carefully followed, the task is an easy one. I have seen a boy fifteen years of age make splendid candy from this recipe. I prefer to put the candy into glass topped boxes, which can easily be made by glazing one side of a section, the glass enabling the bee-keeper to see if the candy is exhausted in the winter with very little disturbance to the bees; it also forms in the spring-time a very good barometer as to the condition of the colony.

The extended alighting board where used should be removed, the entrance opened to four inches, and the roof secured by means of a stake on one side to which is tied a cord passing over the roof, with a brick tied at the other end. This enables the cord to be lifted off quite easily, instead of the trouble of untying knots—a very difficult problem after rain—if two stakes are used, and the cord tied on to each.

Once or twice during the winter the entrance should be raked out with a hooked wire, and if snow falls it should be swept from the roof and alighting board. If the sun shines while snow is on the ground a board should be reared in front to prevent the reflection of light into the hive, attracting bees out to their death. If all the details given are attended to, the novice bee-keeper may rest assured that so far as he is concerned the bees will winter well.

---

## Correspondence.

---

*The Editors do not hold themselves responsible for the opinions expressed by correspondents. No notice will be taken of anonymous communications, and correspondents are requested to write on one side of the paper only and give their real names and addresses, not necessarily for publication, but as a guarantee of good faith. Illustrations should be drawn on separate pieces of paper. We do not undertake to return rejected communications.*

---

### NOTES BY THE WAY.

[8281] We have had continued fine weather till 21st October, but the barometer is falling steadily, so that we are hoping for a plentiful rain to fill the tanks and ponds, as our water supply is running very short. Most of my stocks have now been attended to. I am glad not to have had to feed a single colony; how different from last autumn when every stock wanted feeding liberally. All have been put into winter quarters

except a few nucleus hives where I have held queens for customers' convenience, these I double—*i.e.*, unite two lots together for winter stocks. Those bee-keepers who have neglected to attend to their bees should give large cakes of soft candy over the brood-nest when packing down if they are in doubt as to the sufficiency of the stores, having after a heavy rain examined each hive to see if the quilts and wraps are wet. (Oct. 23. The rain has come and our tanks are filled).

Regarding Miss Willan's communication (8277), page 407. What other result would a bee-keeper expect—especially an expert—who put a swarm into a hive reeking with the fumes of carbolic acid? and I should opine the bees left the straw skep in search of food—*i.e.*, they were a starvation swarm, and in such a condition would not, as a rule, be very joyfully received by an established stock; but bees do nothing invariably.

I have just finished scraping and grading the last of my crop of section honey, and I do not remember in any of the many past years having the sections so well filled, taking them as a whole, or so few unsealed ones. These latter I have extracted, and put on the hives for the bees to clear out, which is promptly done, and they will be carefully stored for use as bait-combs another season (D.V.). Those who have these clean combs and only a back room or loft to store them in would be wise to store them in racks with each wedged up tight and wrapped in paper. If mice are about place a super clearer or a board on the top of the stack, even a queen-excluder will prevent mice getting in and playing havoc with the combs. Another point regarding mice and bees: don't forget to place excluders of mice at the entrance of your hives; a strip of perforated zinc with bee space, tacked on to those hives with big entrances may save a stock from destruction during the winter.—W. WOODLEY, Beedon, Newbury.

#### NATURE STUDY AT SCHOOLS.

[8282] The accompanying photograph represents one of our classes at the Shaftesbury School, Bisley. I also send another of the woodwork class with two "Cowan" hives which they made co-operatively during the last few days. The average age of the boys is just over thirteen, and they have been at wood-work just over eighteen months. I have never seen them so delighted as when they were making the hives. I found it an excellent exercise for various reasons.

The best "workman" of the class had the hardest work to do—for instance the stand with the floor-board—with its tongue-and-groove joints, while those not so clever with tools had simpler parts—the lift, &c. Then again it required absolute accuracy. Further it was a real thing, a thing to be used, and which will be used in their apiary for their education, and we hope for their ultimate benefit.

The apiary is seen in the school illustration. It is not large yet, but will most probably grow. We have taught apiculture for over a year now, but have had bad luck, having to destroy our stocks on account of "Isle of Wight" disease. We hope to stock it again in spring and make a flourishing concern of it within its limits. It is well situated, being protected on three sides by a shrubbery, a thick hedge, and another shrubbery, while in front is an orchard of about 200 good fruit trees in addition to about 300 fruit bushes, currants, &c. The heather and ling pastures are within a stone's throw and there is an abundance of white clover close at hand. In close proximity to the hives we are making as complete a collection of bee flowers as possible with a view to making it a corner of beauty as well as a corner of instruction, a principle capable of extension in most small apiaries. Half the glory of bee-keeping to my mind is missed if we do not study the exquisite adaptations of the bee-folk to plant life, and learn to love them, because they have such a great part to play in nature. It gives an excellent opportunity for the correlation of horticulture and apiculture. It is the nature study syllabus for the fifth form, and has proved most interesting. The boys look upon a sting much as a Crimean veteran would look upon his scars—a judicious way of taking things. It takes the boys out of doors in summer, and in winter they are engaged on the more theoretical branches of the subject—the principles of making hives, the external anatomy of the bee from micro-slides and specimens in the museum, comb foundation, candy making, winter work in the bee-garden, disinfectants, &c. As a proof of the interest taken in it I will quote one example. When we destroyed a stock affected with "Isle of Wight" disease, we decided to preserve the queen and name her. "Cleopatra," was suggested. This sounded well—"classical" in fact—but after a heated debate "Boadicea" was decided upon. Both were ill-fated, as was the queen bee, the fact of Boadicea being British decided it.

Curious ideas are expressed in examinations on the subject. One answer ran, "The queen lays between 2000 and 3000 eggs a day, and hatches them." What a task! Another ran, "To see if a bee has the "Isle of Wight" disease squeeze it, and if a thick yellow fluid comes out of its *heart* you know it has it." The young student said nothing about a microscope.

The Headmaster (Mr. W. S. Patey, F.R.H.S.), is seen to the left of the picture. He is a master of the progressive type, seizing upon any reasonable opportunity for giving his boys a thoroughly practical education.—GEO. STEVENTON, A.C.P., Bisley.

in class six, with six entries, the first prize was withheld, while in class eight, with two entries only, a first prize was awarded to the Chairman of the Association, and a second to the Secretary. On the same ground, a fortnight later, the Mammoth Show, as reported in your paper, which is an open show not connected with the association, took place, with entrance fees two shillings, when over 150 entries were received. In the same county, a month later, at another open show, also reported in your pages, not under the association, seventy entries were made. These facts speak for themselves, and show that many bee-keepers



THE BEE-KEEPING CLASS AT SHAFTESBURY SCHOOL.

#### BEE-KEEPERS' ASSOCIATIONS.

[8283] Your correspondent W. H. T. (p. 377) has opened up a wide question on the value of associations for bee-keepers. Much depends upon the secretary and executive of the association, much depends upon the expert, as experts, like associations, do not all work on the best lines to help and improve the craft.

As an instance take a district association in the county of Cambridgeshire, where, at a show held under its control, with members' classes entry free, about sixty entries were made, and out of ten classes six first prizes were withheld, the reason for this being given in the local press "entries not up to expectations," yet

have lost faith in the usefulness of the local association as at present managed.

Then, with regard to the experts. It would appear that any one who could handle bees might be sent round a county to (so-call) inspect apiaries, doing it often at most inconvenient times, presuming to know, but often showing less real practical knowledge than the humble bee-keeper himself, sometimes fancying he detects foul-brood, but offering no remedy, much to the annoyance and often serious loss of the apiarist. It should be made an illegal act for any man to go to another's hives and open them without the permission of the owner. Who would allow another man, possibly quite a stranger, to walk into any

other part of his private garden or farm and examine things at his leisure?

Experience certainly proves that open shows properly organised and managed are the only successful means of conducting a Honey Exhibition.

Perhaps some of the prosperous county associations can tell us how they are constituted and managed. Are their experts duly qualified?—A WORKING WELLWISHER.

#### DEALING WITH "ISLE OF WIGHT DISEASE."

[8284] As a "Constant Reader" of "B.B.J." has asked for further particulars as to my experience with the above disease, I may say that it started first in June, 1910, in a swarm I received from Basingstoke, Hampshire. For years we have re-queened our bees in August and September with English queens, and we may have imported it through that source, also from Hampshire, last autumn. Knowing nothing of the symptoms of the disease, we thought the dead bees were old ones dying off.

We isolated the diseased stock and drove every bee out of the hive, and had healthy bees ready to introduce on to the brood-frames. We had no means of disinfecting the hive. This is now one of the best stocks any bee-keeper could wish for. To-day we had a warm afternoon, and I watched the bees taking flight, and not an unhealthy bee could be seen. We are still of opinion they are completely cured. We scorched every hive in the apiary with a painter's spirit lamp.

My neighbour purchased the diseased bees that were mentioned in "B.B.J." from Whitchurch, Hampshire.

Regarding the honey season we might write it down a failure this year. We hope to report in the spring ancient this disease: foul brood was nothing to this. We cured foul brood by *vice-versa* treatment—keeping the bees and burning the combs.—ANDREW MUIR AND SONS.

#### "A NOVICE AND A HAY-FORK."

[8285] I have read books on bee culture, but I have never seen the hay-fork recommended as a useful implement in taking swarms. Last year I found one an excellent article for this purpose. The swarm was in a seemingly inaccessible place. A neighbour, one night about 8 o'clock, pointed out a swarm to me settled on a tree in his garden, which he gave up as being impossible to take. It was hanging at the end of a long, slender branch, about fifteen feet from the ground, and he told me I was welcome to it if I could make the capture. After puzzling

over the problem I thought of a hay-fork. At 7 o'clock the next morning off I went provided with a sheet, two skeps (I often use two, because if I don't get the queen in the first shake I make sure of getting her in the second), a ladder, a piece of cord and a hay-fork. I placed the ladder against an adjoining stouter branch, and by that means could just reach the swarm with the hay-fork; next I threw a cord round the branch, as I could not reach it, in order to give it a shake. The plan being likely to succeed, I stuck the fork in the skep, placed it underneath the swarm, pulled the cord, and secured about half the bees. Then I ran down the ladder, inverted the skep on the sheet, stuck the fork in the second skep, mounted the ladder, got the remainder of the bees, shook them before the first skep, and thus secured the swarm. The hay-fork does not injure a straw skep, and forms an excellent shank. A nervous man, if he was afraid in taking a swarm of the bees getting on his hands, or if he wanted to dump a skep on a body-box, might use a hay-fork. — CHARLES WILLIAMS, Ashford Rectory, near Barnstaple.

#### AMERICAN AND COLONIAL PAPERS.

EXTRACTS AND COMMENTS

By D. M. Macdonald, Banff.

*Disposing of the Honey Crop.*—Messrs. Dadant and Townsend deal with this interesting subject in the *American Bee Journal*. Both plead for a more energetic working up of the home market, and a more direct communion between the bee-keeper and the ultimate consumer. At present the middleman bulks large in most transactions. The bee-keeper sells to Jones. He sells to the general public at a profit. Mr. Townsend advises "*Just sell to Jones' customers!*" Mr. Dadant preaches and practices the same sound doctrine. His reasoning is somewhat like this. The bee-keeper sells at eight to ten cents to the large wholesaler. He resells about twelve to twenty cents per pound, because each man must have a profit. This high price depresses the market and consequently less honey is sold. On the contrary home sales at the middle prices given are more remunerative, while they will positively tend to raise prices and *increase the demand*. The editor of *Gleanings* warns bee-keepers against stiffening the price over much, as that will tend to lessen sales, thereby doing permanent harm.

The Canadian and also the Michigan Association have an advisory board which estimates the values of the crop, and then decides on a minimum price under which bee-keepers are advised not to sell. I wish our "B.B.K.A." would follow suit. The idea is an excellent one.

"*Scotching the Snake!*"—Dr. Miller reports: "In the season of 1911, foul-brood showed itself in forty-one colonies out of my 116." I told you so, doctor! Youthful as ever, in spite of his "Fifty years among the bees," he takes an optimistic view of matters and congratulates himself "that in most of the hives there were only a few cells." A hive with disease in one cell is diseased!

*Californian Honey Crop.*—In 1909 the crop in this State was as high as 11,532,000lb. That would be about 330 car loads, averaging 35,000lb. to the car. This year from all accounts the crop will be a small one.

"*Keep Better Bees.*"—The late Mr. Hutchinson preached "Keep more bees." That may appeal to a very few. Not every bee-keeper can carry out the precept, but everyone who prosecutes the calling can, and should, follow this new and better advice. Everyone will profit by securing better stock. Three of the most prominent contributors to *Gleanings* emphasise this in the September 15 issue. Mr. Doolittle summarises: "It is not so much from numbers as it is in making each number turn out the highest possible percentage of profit. The item of improving the stock is one well worth paying attention to." He carries out the principle to the full in his own person. He is not an extensive bee-keeper, but an *intensive* one.

"*Tips.*"—(1) Mr. House describes a blazing torch he uses at night for attracting and killing moths, which, if left to breed and increase, would work havoc on his combs. The idea was known in the south of England nearly 200 years ago. (2) Feeding *sweetened water* outdoors to take up the attention of bees when a robbing boom is probable is given as a remedy, and "it is wonderful how little of it will stop all the robbing nuisance." Five pounds of sugar and nine pounds of water will keep a whole apiary in good humour a whole day. (3) For moving bees a short distance, the following plan may be tried. Move a hive facing south, say on Monday morning, to face nearly east. On Tuesday give it another quarter turn. Now it faces directly opposite its first position. On Thursday shift again. Bees get so accustomed to hunting for, and finding, their entrance, they easily fix the new location! (4) To secure the best and purest queens have "Mating Stations." Forward the virgin in a fertilising-box, and have it returned after mating. With parcels post cheap transit can be secured as well as quick return. More of this anon! The idea is not a new one in this country. (5) When a hive is being robbed, remove it "down cellar," and set in its place a hive containing an old comb with a little honey in it. The bees on cleaning this out will

desist, and next day the colony may be returned to its place. (6) Here's my latest feeder for a small quantity at dusk in hot weather. A tumbler of syrup at the entrance, with cork chips for a float. If the evening be cool, kick the hive and then run. This is a device of Dr. Miller's—that young man of eighty. By the way, a new edition of his book, "Fifty years among the Bees," is just published.

*Australian Disease.*—A disease that has been very prevalent and deadly in its ravages has been studied by a Government pathologist, and here is his description of the parts most affected: "On taking out the digestive tract of a diseased bee, the colour is usually found to be distended with dirty brown material. Occasionally it is of yellow colour. The contents are loose and watery, and have a peculiar smell. In the excrement exist pollen grains, particles of wax, waste matter, yeast, moulds and bacteria. In some cases enormous numbers of particular bacteria are present, and they are the specific cause of the disease." It is contended that *Nos. ma Apis* has nothing to do with the trouble; indeed Dr. Brown asserts that his protozoon "seems to be a messmate of the bee." At present I would simply point out that several features bear a kindred resemblance to our present deadly disease.

---

## Queries and Replies.

---

[8240] *Rendering Wax.*—I enclose a sample of wax. Could you give me your opinion of same? I may say it was melted from old combs, partly by a solar wax extractor with an oil lamp underneath, and partly over the fire. Do you think it would do to make up into brood foundation, or what use could I make of it? A reply through B.B.J. would oblige.—D.H., Cleator Moor.

REPLY.—You have spoilt the wax by bringing it into direct contact with heat. As pointed out many times in our pages, this is always a fatal mistake to make. We find that there are a few over-educated people who cannot understand the simple expression "direct contact with heat." Ordinary folk can understand this, but for the benefit of the former we explain that direct contact means putting the vessel containing the wax directly on to a hot plate, such as an oven, or, as you have done, in a saucepan over the fire, or over a paraffin stove. Wax should neither be melted by the direct rays of the sun in a solar extractor, the action being entirely different to that from coal, paraffin, or

gas, or by placing it in a water jacket, or in such a position that it is melted by steam. The sample sent can be used for making furniture polish.

## Bee Shows to Come.

**Oct. 31 and Nov. 1, at Brighton.** Sussex B.K.A. Show in connection with the Brighton and Sussex Horticultural Society's Chrysanthemum Show. Free Open Classes. Schedules and Entry Forms from C. A. Overton, Bécroft, Crawley, Sussex. **Entries closed.**

## Notices to Correspondents

*Letters or queries asking for addresses of manufacturers or correspondents, or where appliances can be purchased, or replies giving such information, can only be inserted as advertisements. The space devoted to letters, queries, and replies is meant for the general good of bee-keepers, and not for advertisements. We wish our correspondents to bear in mind that, as it is necessary for us to go to press in advance of the date of issue, queries cannot always be replied to in the issue immediately following the receipt of their communications.*

J. E. S. (Eull).—*Keeping Bees in Garden Village.*—(1) Yes. (2) We know of no reason why you should do so. (3) Yes, but the B.B.K.A. Insurance Scheme covers risk of damage to third parties up to £30. The premium is 1d. per hive with a minimum of 9d. Non-members of the Association or its affiliated bodies are charged an additional registration fee of 1s. (4) There is no need to use a non-swarming hive. The Brice appliance is efficient in capturing swarms that try to issue.

A.W.C. (Watford).—*The Wasp Nuisance.*—Close the entrance so that only one bee at a time can pass in or out. You will not be troubled much longer, as the cold weather is rapidly killing off the wasps.

W. T. (Barrow-in-Furness).—*Microscope for Nature Study.*—A suitable microscope can be obtained from C. Baker, 244, High Holborn, London, E.C.

### Honey Samples.

J. A. S. (Penzance).—The honey is a good heather mixture, and if boiled with about a quarter of its bulk of water added, can be used as food for bees, though it seems a pity to use it for such a purpose.

T. P. (Lancaster).—A fine sample of clover and heather blend. The latter predominating is the cause of your having to press it from the combs. It is quite good enough to show in the heather-blend class.

BEE-KEEPER (Montgomerys).—No. 1 is a very good light clover honey, should sell at 7d. to 8d. wholesale, 11d. or 1s. retail. No. 2, though a dark honey is of good flavour and density. It has been

gathered from mixed sources, mainly fruit blossoms. Worth about 6d. lb. wholesale, 10d. retail.

T. H. (Yorks).—Sample No. 1 is from white clover, colour light, density, aroma and flavour good. No. 2 is a nice heather blend gathered from clover and heather.

E. J. G. (Bow, E.).—None of the honeys are of good quality. No. 1 a medium honey of fair density, but the flavour is so insipid that we are unable to name its source. No. 2 and 3 are light honeys of fair density, but the only impression we get of the flavour of either is a burning sensation in the throat after swallowing the honey.

C. B. (Glasgow).—The honey is a very good heather blend with clover, the quantity of the former predominating. Evidently you do not appreciate heather honey as your sample is fine in flavour and not nearly as strong as the pure heather would be. Owing to its gelatinous nature, the air-bubbles always remain in pressed heather honey.

### Suspected Disease.

NOVICE (St. Leonards).—We fear that the bees are suffering from "Isle of Wight" disease. Send a few (alive, if possible) to Dr. Malden, Medical Schools, Cambridge.

J. B. H. (Bucks).—The bees are badly constipated, and there are indications of Isle of Wight disease. Send a few to Dr. Malden (address as above).

A. B. C. (Devonshire).—(1) Comb is affected with foul brood. (2) Use Apicure or formaldehyde. (3) There is no need to destroy the hive, but if you wish to disinfect in the spring, scorch it well inside with a painter's spirit lamp. You might deal with the bees on the starvation plan, as described in "Guide Book." (4) Keep your colonies strong, use naphthaline in the hives, and prevent robbing.

## Special Prepaid Advertisements.

**Two Words One Penny, minimum Sixpence.**

Orders for three or more consecutive insertions entitle advertisers to one insertion in "The Bee-keepers' Record" free of charge.

Trade advertisements of Bees, Honey, Queens, and Bee goods are not admissible at above rate, but will be inserted at 1d. per word as "Business" Announcements, immediately under the Private Advertisements. Advertisements of Hive-manufacturers can only be inserted at a minimum charge of 3s. per ½ in., or 5s. per inch.

## PRIVATE ADVERTISEMENTS.

CHAPMAN'S HONEY PLANT, seeds. 4d. per packet; two 6d.; also *Limnanthes Douglasii* plants, 25 6d., 50 10d., 100 1s. 3d., free.—REV. ANDERSON, Norsham, N. Devon. p 14

DELICIOUS WELSH HONEY, in 56lb. tins, 58s. per cwt.; 28lb. tins, 30s.; sample 3d.; new geared Extractor, £1.—G. THOMAS, Coed-melyn, Stackpool, Pembroke. p 27



## Editorial, Notices, &c.

### BRITISH BEE-KEEPERS' ASSOCIATION THE CONVERSAZIONE.

(Continued from page 424).

The subject of re-queening comprehends that of queen introduction. The various methods described in the "Guide Book" are both efficient and adequate for general purposes. Personally, I have never failed to introduce a new queen successfully by any caging method, and I am persuaded that the novice does well to confine himself to such of these methods as involve the least amount of handling of the queens. Mr. Simons's direct method of introduction has worked well with me, for out of some one hundred introductions I have only experienced three failures, and in each of these I was able to satisfy myself, on reflection, that I had not adhered strictly to the requisite conditions. Most, if not all, of these methods, however, involve two visits to a hive in order to re-queen it, and where an out apiary is, like my own, at a distance, this is a serious inconvenience. I have consequently looked about for a method of introduction even more direct than the "direct" method, and in doing so have rejected as unsatisfactory those involving chloroform, rolling the queen in honey, and running her in with the bees at the hive entrance. The method I have found most expeditious is that of previous immersion of the queen in water. I have practised this method occasionally for some years, and have, until recently, been under the impression that it could be safely followed during the honey season only. This year I have introduced all my queens in this way, and have experimented with my old queens all the autumn. Save in the one instance discussed below I have never failed to replace a fertile queen by another at one operation.

The procedure is as follows: The hive to be re-queened is well-prepared with smoke at the entrance, and after a minute or so is opened with little disturbance. The bees will be found to be very quiet and scarcely moving on the combs. The old queen is removed. A match-box containing her successor is then opened beneath tepid water, and the young queen, held by a wing, is well washed. After a quarter of a minute's bath she will still crawl vigorously on to the finger, and is then allowed to walk amongst the bees on the brood. The bees approach her respectfully, and attempt to clean her with their tongues. The frame is replaced for a minute or more, and the hive covered.

It is then withdrawn for inspection, and a glance will serve to tell whether the queen is to be accepted or not. She is by this time perfectly dry and clean, and the warm water seems but to have increased her activity. If the bees are respectful, and touch her with their tongues, it may be concluded that she is accepted. I have considered it advisable to give her another dip before closing down the hive, as the second examination is likely to arouse the suspicions of the bees. Of about forty introductions by this method, two have failed with me. One I attributed to insufficient dipping, that is to say, the characteristic scent of the queen had not been entirely washed from her, and the other to the fact that the bees were constructing queen-cells. In each case the hostility of the bees was indicated on the second opening of the hive by their seizing the legs or wings of the queen. I have found the method to answer in autumn as well as in the summer, though in the honey season less dipping seems requisite. This might be expected, for it is well known that bees are then less suspicious of new arrivals. The bath appears to do no harm to the queen, but, on the contrary, if it is tepid, it seems to invigorate her. As a proof of this, I may mention the case of a queen introduced by this method on September 18th of this year, at 6 p.m. She had laid about 200 eggs by 10 o'clock the next morning. I do not suggest that this method has great advantages over other methods in ordinary cases, but it is valuable for the purposes of an out apiary, for the whole operation takes only a few minutes, and the apiarist has the satisfaction of ascertaining that the queen is accepted before he leaves.

By whatever method queens are introduced, however, it is certain that a plentiful supply of food and the absence of excitement are always conducive to success.

What, then, should be the guiding principles of the bee-keeper in respect of re-queening?

(1) He should resolutely set his face against the retention of inferior or old queens.

(2) He should, as a rule, re-queen annually, and only by means of selected stock.

(3) He should rear his own queens only when circumstances permit him to pay full attention to the numerous important conditions of success.

(4) Failing this, he should purchase from reliable breeders, particularly from those who make a speciality of selection.

(5) He should persuade his neighbours to do likewise. By observing these principles, not only will he ensure greater

profits both for himself and his neighbours, but his interest and pleasure in bee-keeping will be greatly increased, and he will have the satisfaction of reflecting that he, at all events, contributes regularly and effectively to the improvement of apiculture. (Applause).

An interesting discussion followed the reading of Mr. Snelgrove's paper, in the course of which several of the members asked for further information.

Mr. Lamb said he would like to know if anyone could tell him providing three eggs were taken of equal age, and one was sealed over first, if that one would hatch out before the others, and be as good a queen, and would she kill the two remaining in the cells.

Mr. Snelgrove said his experience was that this would be the case.

Mr. Smallwood asked Mr. Snelgrove if he destroyed the old queen at the same time as the new one was put in, and if the queen was put in the centre of the cluster, or at one side.

Mr. Snelgrove: The old queen is removed and the new one put in at the one operation, and she is placed in the centre of the cluster.

Mr. Newman next inquired about what temperature was the water in which the queen was washed.

Mr. Snelgrove: 90 degrees Fahr.; or about blood heat.

Mr. Salmon said he could support what Mr. Snelgrove said about water; he had successfully united bees by sprinkling them with cold water. It was quite by accident he found it out.

Mr. Bevan asked if there was any difficulty in introducing a queen of a different colour, or uniting bees of two colours such as English and Italian.

Mr. Snelgrove: No difficulty whatever.

Mr. Cowan, in closing the discussion, said that personally he should hesitate to introduce a valuable queen by this method. Mr. Snelgrove had mentioned two failures out of fifty trials, and no doubt in practice those two queens would be the most valuable ones. The use of the ordinary cage was the safest plan for introducing queens under ordinary conditions. A very hearty vote of thanks was passed unanimously to Mr. Snelgrove for his most interesting and instructive paper.

A number of objects of interest which had been sent by members and friends were on exhibition, amongst them being cases showing the ravages of the wax-moth sent by Mr. Steventon and Mr. Barnes; a quilt with winter passages by Mr. Joyce; aluminium rapid and slow feeders, and candy mould by Mr. Wilkes; a candy and bottle feeder by Mr. White; spring cleaning trays by Mr. Fischer Webb; and the

original plaster cast for making foundation used at South Kensington Exhibition, also light metal plates used before the introduction of roller mills, sent by Mr. Andrews; a winter protective entrance by Mr. Tew; and a Reich foundation press by Mr. Vogt.

Mr. Richards, in proposing a vote of thanks to the chairman, said he was quite sure he was expressing the feelings of all when he said how delighted they were to have Mr. Cowan amongst them, and they hoped he would be able to preside at their meetings for many years to come.—Mr. Newman seconded, and it was carried with loud applause.

Mr. Cowan expressed his thanks, and said that it was always a great pleasure to him to be present amongst them. The meeting then closed.

ERRATA.—In "B.B.J." of Oct. 26th, in Mr. Snelgrove's paper on re-queening, page 422, line 62, for "larvæ" read "larval"; page 424, line 8, for "larvæ" read "larva."

## AMONG THE BEES.

THE EARLY LIFE OF THE BEE.

By D. M. Macdonald, Banff.

*The Egg.*—As developed in the ovary of the queen, and even as they pass down part of the oviduct, all eggs are alike. Every one would hatch out as a drone if no other event happened subsequently to differentiate them. The many, however, in passing down by the spermatheca received an impregnation from the connecting duct, and all these eggs are capable, under normal conditions, of resulting in worker bees. All do not, as will be seen hereafter. Those not impregnated, however, will be deposited by the queen in drone cells, but whether consigned there or not matters little, for nothing but a drone can issue from them, even when laid in worker cells. They have received no fruition, and are just as if they had been oviposited by a fertile worker or an unfertilised queen. Here we have two distinct results of the queens' egg-laying. The simple egg develops into a drone; the impregnated egg produces a worker bee.

But at times the worker bees step in and deal with this last species of egg, either when in that state or during the first three days after it hatches, and they have the mysterious power of changing the whole current of its life. Some of its organs are suppressed, some are all but eliminated, while others are phenomenally developed. Its sting is altered; its pollen baskets are banished; its tongue is greatly modified; its glands remain undeveloped; its honey-sac all but disappears, and its desire for toil in or out of the hive is rendered non-existent. Its very brain is

atrophied, and many other organs are kept under subjection, apparently to develop its special organs to the very highest extent. Nature, as it were, suppresses all unimportant or unnecessary organs to enable the essential ones to attain perfection. This egg, when oviposited, contains the living germ, and has been granted the essential fertilising substance for developing into a worker bee. It is an ovoid cylinder, rounded at each end, but at the top it is broader. At the time it consists of the chorion or shell, and the vitellus or yolk. From the very start it receives attention. The queen places it resting on the base, and its length lies parallel to the sides of the cell, attaching it by a glutinous secretion. On the second day it will be seen at an angle of 45deg.; it is later shifted to a horizontal position lying at the base of the cell. From the beginning it is endowed with life, containing, as it does, the blastoderm or germinal membrane, originated cell by cell. The amnion appears, the ventral plate originates, and a superficial layer, the ectoderm, as well as a deeper one, the mesoderm, is formed. The nervous system originates, the spiracles form as well as the cerebral ganglia and ventral chain. The antennæ appear, and the ganglionic chain of thirteen ganglia shows in rudiment. The trachæ and other breathing organs originate, and even the alimentary tract and rectum at least show. All this time the yolk is gradually disappearing. Blood corpuscles are seen just before hatching, some glands appear, and the genital organs in a rudimentary form are evident. The antennæ and mouth parts are developing. Three pairs of legs show distinctly, to disappear before the egg hatches, which it does at the end of the third day or subsequently, the exact period depending somewhat on temperature.

*The Larva.*—The now appreciably living larva lies at the bottom of the cell slightly curved. Later it grows and occupies the base of the cell, forming a ring somewhat like the letter C. Gradually it raises its head into a vertical position. For the first three days the larvæ of the worker drone and queen are fed alike, on simple chyle food, administered by the nurse bees so profusely that they float in the liquid food, absorbing it at every pore. Consequently, growth develops very rapidly. A larva selected for a queen is fed on royal jelly right through, and this feeding and the enlargement of the cell is all we can see as a cause of the marvellous change, little less than miraculous, which it undergoes. Workers are fed sparingly on chyle food and digested pollen; drones on the same, but more sparingly, and later to this is added honey

and undigested pollen. The larva in perfect health should be pearly white, but with a slight colouring in the head. It undergoes several moults. The progress in growth is very rapid until, on the ninth day, it completely fills the cell in which it lies with the head forward. Another day in the case of the queen, two in the worker, and three for the drone are occupied in the spinning of the cocoon, in which it wraps itself all round as in a blanket, although the queen is not so completely enveloped. The different classes take two, three, and four days of complete rest after this arduous task has been performed, and then another day is taken up in transforming the larva into a nymph.

*The Nymph.*—The embryo formations already noted have considerably developed, and now we have the real actual bee in more than rudimentary outline, for during the period since it was sealed from the prying eyes of man the transformations have been marvellous. As a nymph, the queen lies in her natal cradle only three days, whereas the worker and drone occupy their concealed beds for seven days. Normally, the queen issues in fifteen days from the laying of the egg, the worker in twenty-one days, and the drone in twenty-four days. In cool weather each may take a day or two longer, and under certain circumstances bees can imprison the queen two or three days after she is fully matured—a wise provision on which much may depend.

*The Imago.*—The perfect bee, as it eats its way out of its wax cradle, is at first a weak, grey creature, with little energy in its movements for a few hours, but this stage is worth a little further study.

## NECTAR PRODUCING PLANTS AND THEIR POLLEN.

By Geo. Hayes, Beeston, Notts.

(Continued from page 394.)

No 12. THE WILLOW, SALLOW, OSIER  
OR PALM (*Salix caprea*).

NAT. ORDER, *Amentaceæ*.

Of the willows called "Salix," a name derived from a Latin word meaning "to spring up," and given on account of its great rapidity of growth, there are many species, no fewer than 140 having been enumerated. To these species generally the specific name of "caprea" has been given, because goats are very fond of the catkins, "caprea" being a Latin word signifying a goat.

There are two species used in basket-making and commonly called osiers. These are *Salix viminalis*, the Green Willow, or Common Osier, and *S. vitellina*, the Yellow Willow or Golden Osier, which is a variety of the common Willow (*Salix alba*), also called White Arborescent

Willow This species grows into a fairly large tree, and may be found on the sides of rivers and streams. When the wind agitates its twigs and turns up the silvery sides of its leaves it has a very pleasing appearance, more especially if it is set in a dark background of trees or other darker objects. This is one of the first to bloom, and gives the very necessary early pollen so much needed by our bees. It is more on this account than from the quantity of nectar they yield that the willows find a place in this list.

After the first few primroses have cast their blooms and the golden disks of the coltsfoot have lighted up the waste ground one of the most welcome signs to the bee-keeper is the blooming of yellow and green willows, these being more numerous than the white variety. The willows are dioecious, that is to say, the blossoms, instead of being like those of the apple, pear, plum, or strawberry, which have both pistillate and staminate parts in one flower, have the staminate or pollen-bearing parts on one tree, and the pistillate or female sex on another. The golden yellow clusters of the Salix are the stamen-bearing catkins; the pistillate ones being green in colour and somewhat longer and narrower.

The male catkins, before flowering, are of a soft grey colour; very smooth and silky to the touch; but as the stamens develop the silver-grey is changed to a golden yellow.

To the entomologist the Sallow is especially dear, as its fragrant catkins offer a great temptation to many kinds of butterflies, moths, wild bees, &c., thus providing him with a happy hunting ground. I have myself spent many an hour at different times, watching the myriads of

insects visiting them during sunshine, and to one unaccustomed to such a sight it is simply astonishing.

The Sallow or Willow is generally used in churches on the Sunday before Easter, usually called Palm Sunday, and no doubt from its use for this purpose it has acquired the appellation of "Palm," and it is only known as such to many people.

It blooms for a considerable period, the time depending, of course, on climatic conditions, and owing to its long blooming it provides a good supply of pollen. The

pollen from the different species varies in colour, some being golden-yellow, others a greenish-yellow, all of which may vary in intensity. The grains are ovoid in form with three grooves or depressions along the sides, and the whole surface is covered with short spines. When dry, they are as seen at Nos. 1 and 2, No. 3 being a section through the middle. They measure  $\frac{14}{1000}$  by  $\frac{1}{1000}$  of an inch.

In honey, the pollen for a time maintains the same form, but is more transparent, as seen at Nos. 4, 5, and 6. After a period it assumes a spherical form, the grooves disappear, and an irregular number of processes and pseudo-processes appear on its surface, at

the same time the spines almost wholly disappear, as seen at No. 7. The pollen grains then measure from  $\frac{3}{1000}$  to  $\frac{14}{1000}$  of an inch.

### Dry

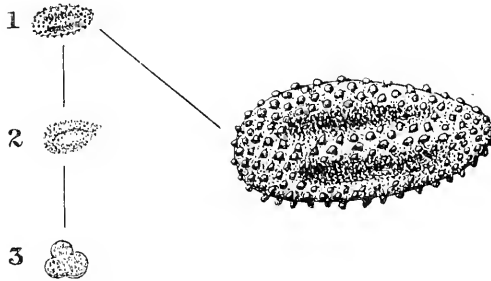

### In Honey

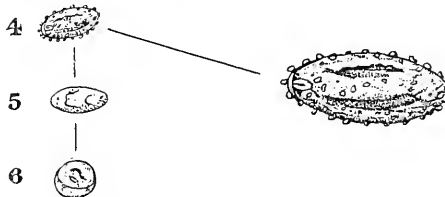

### From Honey

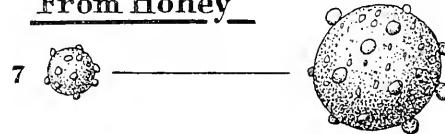

POLLEN OF WILLOW.

## HOMES OF THE HONEY BEE.

### APIARIES OF OUR READERS.

We have pleasure in presenting the illustration of Mr. F. C. Kelly's attractive little apiary, and we are sure that beginners will feel encouraged on reading the interesting notes which he has sent to accompany the picture. We hope his

interest and enjoyment in the bees will continue to grow as time goes on, and the number of his stocks increases. Mr. Kelly writes as follows:—

In writing you a short account of my apiary, I may say that I commenced bee-keeping in the September of 1905, after hearing a lecture on the subject given by an expert of the Cheshire B.K.A., at Chester Show. I came home from that show with the full intention of trying my hand at it, and in the following week I purchased three W.B.C. hives in the flat, a "Guide Book," and a goodly number of other necessary requirements. I then felt very well pleased with myself.

Well, so far, so good! The next and most important item—"The bees"; where were they to come from at that time of

patience for the coming of the bees. In the meantime I settled down to study the "Guide Book," and find out how I was to feed them. About three days later, amid great excitement, the bees arrived in a small box, and I prepared to hive them as a swarm in front of the hive on a sheet, as instructed in the "Guide Book." The result was success, and within a week the stock was packed down, provided with a cake of candy and 30lb. of syrup for winter food. During the winter months I studied the "Guide Book," and prepared my frames and sections for supering, and in the meantime I joined the Cheshire B.K.A., who, in the spring of the following season, sent their expert to visit me. After he had given me a good bit of advice I commenced my first season, and



MR. F. C. KELLY'S APIARY, THE MOOR, HAWARDEN, CHESTER.

the year? So on my way home, on looking over the railway bookstall I saw a paper called the BRITISH BEE JOURNAL, and took one home with me (and, by the way, I have not been without one since). The result was I sent off for some driven bees, which were supplied me by the secretary of the Worcester B.K.A., and while waiting for them to be sent I commenced to put my hive together, which I managed to do by taking all my particulars from a picture of a W.B.C. hive in the "Guide Book." With the assistance of my father, who had kept bees thirty years ago, but had had none for many a long time, we pulled through all right, and I got my first hive together, and waited with im-

finished up with 117lb. of honey, which included twenty-one sections off my first hive (an account of this honey take from driven bees appeared in the "B.B.J.," I believe, in the back end of 1906). I then prepared to get my honey in order for the Chester Show, and am pleased to say with good result, securing first prize for shallow-frames, third prize for sections, and third for extracted honey. I was advised to try at Altrincham a month later, which I did, with still better result: first prize and special bronze medal for sections, second for shallow-frames, second for extracted honey. So I was very pleased with my first season. Since then I have never been out of the prize list at these shows, and I am also pleased to say that

I obtained my B.B.K.A. expert certificate last year. I have tried my best to encourage bee-keeping in this part of the country, and am always pleased to help brother bee-keepers when able. We have now eighteen members of the Cheshire B.K.A. in this district, of which I think I was one of the first (my father was the other), and I hope to increase the number by next season. You will observe that all my hives are the W.B.C. type, with the exception of the small nine-frame makeshift at the far end. I buy all my hives in the flat, and knock them up myself.

---

## Correspondence.

---

*The Editors do not hold themselves responsible for the opinions expressed by correspondents. No notice will be taken of anonymous communications, and correspondents are requested to write on one side of the paper only and give their real names and addresses, not necessarily for publication, but as a guarantee of good faith. Illustrations should be drawn on separate pieces of paper. We do not undertake to return rejected communications.*

---

### ROSS-SHIRE NOTES.

[8286] Like the other day the bees were revelling in bright sunshine, while pollen was being carried into hives where young queens reign. Now premature winter holds the apiary in its icy grasp. But although frost and snow are outside the hives, all is snug and warm within, where the little workers are at rest. I am wintering fifteen stocks and nuclei, but will be quite satisfied if a dozen working colonies are at my call when the days come for honey-gathering.

Theoretically, a properly cared for apiary should go through winter and spring without loss. In practice, this is rarely the case, and in most apiaries there will usually be one or more empty hives after winter. Sometimes the queen mysteriously disappears, and her bees join on to an adjacent colony, while the stores are looted by robbers.

In all cases of queenlessness, prompt uniting with a nucleus puts matters right at once. Hence the idea of carrying surplus queens over winter in "Combination" hives adapted to the dual-queen principle.

*Bee-paralysis.*—I regret to hear that this pest has deprived the Messrs. Muir of their usual large honey-crop. I was particularly interested in their method of cure (page 428), as it coincides with my own ideas on the subject. Last spring, when the disease was raging everywhere, no one could suggest anything better than the "total destruction" treatment. So when one of my own stocks became affected I destroyed it.

But after thinking matters over I came to the conclusion that destruction, if really necessary, should be confined to the diseased portion alone. That meant sulphuring the entire population of a diseased colony, and restocking the hive by running a healthy swarm on to the beeless brood. However, as the scheme was fully described in these columns at the time, I need not recapitulate.

I heard afterwards that the theory was put into practice by others, and with complete success.—J. M. ELLIS, Ussie Valley.

---

### CREATING A MARKET FOR HONEY.

[8287] As one who has taken your valued journal for many years, I notice that the old question is still brought up by bee-keepers at the close of each season, "What shall we do with our honey?" and in this year of plenty the cry is greater than ever. Now, why is this? Is it not entirely the fault both of bee-keepers themselves and the Associations? Honey, like every other commodity, will not sell unless it is pushed and well advertised (I am dealing now, of course, with the bee-keeper who is trying to work up a retail trade.) The best advertisement that I know of, and which is at the same time inexpensive, is to purchase a few dozen 2oz. tie-over jars, and having filled them, start on a round of likely buyers, and give them a sample—get them interested in bees generally. Having thus secured their attention drive home the points with regard to the medicinal and food values of honey, &c. He will, indeed, be a bad business man who does not secure customers, and once having got them it is an easy matter to keep them. I have tried this way of disposing of honey, and know that it succeeds. Unfortunately I had to give it up, for business reasons, but my round was passed on to another bee-keeper who travels it to this day. I am, therefore, forced to the conclusion that the inability to dispose of honey is the fault of the bee-keeper. Now just a word to the committees of Bee-keepers' Associations: Don't leave all the work of disposing of their honey to the members. Instead of giving so much attention and time to demonstrations with bees at shows, just try to educate the public to appreciate the value of honey as a food and medicine, also for making excellent drinks; distribute literature, give lectures, and get out a list of "Honey cooking recipes;" in fact do anything which will create a demand for honey. If any proof were needed of the ignorance of the public in regard to the value of honey, just stand for a few minutes by the show bench where honey cakes, &c., are exhibited, and listen to the remarks which are passed. Demonstrating

with bees in a tent may be all very well, but why continue to make bee-keepers if at the same time you do not create a demand for their produce? The whole thing is on a par with any business firm who sends its travellers round and makes its wares known while it goes on with the manufacturing at home. This then is clearly the work of Bee-keepers' Associations working in harmony with their members, and until some such system is devised this "hardy annual" will always be with us.—A. WAKERELL, 21, Mansfield Road, Croydon.

#### AN EXCELLENT RETURN.

[8288] I am sending this short account of the profit realised on one hive this season, as it may interest those of your readers who are bee-keepers in a small way. The stock went into winter quarters fairly strong, and with ample stores, and came out in good condition in spring. It swarmed in May, and twice more in June, and the swarm was returned each time. Finally I made a nucleus on four frames which I sold for 10s., and put two extra racks of sections on the original hive without an excluder, and with only triangular starters in the sections. The bees worked steadily all the summer, and I took off over eighty sections, besides taking out four more frames of honey from the brood-nest, as it was getting clogged with stores. These I replaced with frames of foundation. The sections, well-filled with excellent light honey, I sold for 1s. and 1s. 1d. each, unglazed, and carriage not paid. My only expenditure was on foundation for the sections, and I cleared £1 10s. profit altogether. I should like to add that the bees are English Blacks.—M. R. HAMMOND, Hants.

#### CAPPINGS OF COMB.

BY L. S. CRAWSHAW, NORTON, MALTON, YORKS.

*The Simmins Treatment* (p. 366.)—Recently I had the pleasure and privilege of some conversation with Mr. Simmins at his hospitable home, and discussing his new remedy for "Isle of Wight" disease, I suggested that the year 1911 itself may have accounted in some measure for success. He quite reasonably admitted this, and it is to be hoped that the remedy will be further tried by all concerned should the plague be with us next year—the which may a merciful Heaven forbid! With regard to the quilt, I do not remember whether he advises that it should not be used whilst supers are on the hive. I am prepared to believe that at all other times it will do good.

*A Bee Story* (p. 367.)—"Credulous" seems to doubt, for some reason difficult

to discover, my story of a stinging affray. For his benefit I must explain that the hive was sectional, the super being the full width of the hive, whilst the brood-section was double-walled, "W.B.C." fashion. Now, surely that explains matters and makes the story more probable. At least it is the best I can do for Thomas. But his suggestion of a safety-razor is a distinct improvement, and would have been the "salvation" of the narrative. As for his story of the professor, I don't believe a word of it! At any rate, without being irascible, I shall not allow him to raise my hair!

*Renewal of Old Combs* (p. 373.)—Mr. Herrod's very practical advice is generally so sound that I almost hesitate to detail some of my practice in this matter, lest it should seem to question his dictum. But I am by no means alone in the opinion that the bees form their winter nest normally in a manner far superior to any that the bee-master can devise. Supposing this to be true, I allow the combs to remain *in situ* in autumn, whether pollen-clogged, or old, or badly-built. I have not many of the last variety. If at any time during summer manipulation I discover a comb which needs replacement, I mark it. For this purpose I use small tin clips. These I make from pieces 1½ in. long by about ¾ in. wide. When the ends are bent up the result is a channel-shaped clip , which exactly fits the top bar. If a trifle slack, the ends may be closed a little. These marked combs are selected by preference for nuclei, or driven bees, or similar purposes. They thus automatically collect themselves, and may be disposed of in due course. If a stock be wintered upon them, a number will be free the following spring. The method is not very different or original, but may have some advantages.

*Sugar Feeding and Disease* (p. 375.)—An exceedingly interesting theory is here propounded by R. B. Manly. It is to the effect that one colony of bees may be able to resist the onslaught of germs contained in its own honey; whilst if the said honey be fed to another colony it may cause an outbreak of disease. It is widely believed that disease may exist in an endemic form in certain districts, which rather bears out the theory, but one would hardly expect it to be true of related stocks in the same apiary. The matter might be tested by placing in the healthy stock a comb from the affected colony. I admit that it is hardly a complete test, but if immunity were obtained it would substantiate the theory. We are apt to consider the health of bees entirely from the communal standpoint, but there is no apparent reason why individuals in a strong colony should not possess a

lowered vitality, which would predispose them to disease.

*Where is the English Bee?* (p. 376.)—The "B.B.J." seems to be fuller than ever of these difficult conundrums. "In the hive," is too obvious a reply, yet it seems the best this weather. "In the North" is challenged by Mr. Kidd's own location. So, after a careful perusal of his article, I am driven to conclude that the English bee is sulking at home, cross in mind and body, at the advent of the undesirable alien. However that may be—and I speak as a believer in our own bees—is it not possible that desirable traits may be obtained from these crosses? In our young bee-keeping days we learned that the Carniolan bee was typically gentle, and that its happy nature might be transmitted through its drones. Undoubtedly the Carniolan has excellent qualities. Is it true that the Carniolan-English hybrid is invariably bad-tempered? Or is it only occasionally so? Can anyone tell us?

## Queries and Replies.

[8241] *Dealing With Extracted Combs.*—I shall be very grateful if you will give me an answer to the following questions in the "B.B.J." (1) Is it too late to give the bees combs to clean up? (2) How can I clean combs that have had very thick honey in them, if the bees may not do it? (3) What is the best way to "thaw" honey that has got too thick to extract? I am afraid to put it very near the fire for fear of melting the wax too much. (4) Will you please tell me of a good recipe for making bee candy with honey in it?—H. E. SMITH, Northants.

REPLY.—(1 and 2) Yes. Save them as bait-combs for next season. (3) The only way is to keep the combs in a very warm room or near the fire, but not too near to melt the wax. (4) A recipe is given in the "Guide Book" Coronation Edition, page 196, No. 3.

[8242] *Treating Diseased Stock in Autumn.*—I have sent you a piece of comb taken from one of my hives, from which I took forty sections this year. I am in doubt what is wrong with it, as I thought they had done so well and that it cannot be disease. I would be much obliged to you if you would kindly say in the columns of your much-valued journal if it is foul brood, as I have never seen it. I started bee-keeping four years ago with only one bar frame hive. I have now sixteen, and have been entirely guided by your "Guide Book" in the management of them. I cannot praise it enough, for they have always done well. I took 650 sections this year from them, 250

being heather. I have read so much about foul brood, how difficult to cure and how terribly infectious, that I am anxious to know if this is it. I have gone through all my hives and there are four with combs like this one, but not so many cells together not hatched out. That is by far the worst comb. If it is foul brood I will try bravely to fight it in the spring as per "Guide Book," but what would you advise in the meantime? Thanking you in anticipation.—J. R., Morayshire.

REPLY.—The comb is affected with foul brood. Use Apicure and naphthaline in the hives and see how they come out in the spring.

[8243] *Wintering Driven Bees.*—I set up a hive in September with two lots of driven bees, put on to eight frames of comb foundation. As I did not see a queen in either, I feared that I had not secured one, but during the last ten days or fortnight they have been very industrious, fetching in pollen, and so I hope that this indicates that there is a queen. I fed with syrup from the first, and they took down about 8lb. of sugar in syrup form. I conclude that they store some of it in the cells for winter use. Neither lot was very large, and as far as I can see they do not seem to be filling more than four or five frames, so shall I be right if I take away, a little later, the unoccupied frames and replace with a dummy? I noticed in the "B.B.J." that another correspondent (page ) was similarly placed as myself, and the reply you gave him has made several things clearer to me. I was surprised, though, to see that he put his bees on to empty frames, and did not feed them at all. It will be evident that I am a new recruit in the fields of bee-culture. I always thought bees interesting little creatures, but now I have learnt more about them I find they are extremely fascinating, and I hope in time to find them remunerative also.—(Miss) I. S., Essex.

REPLY.—Before finally packing down for winter close the bees on to the number of combs they cover by means of the dummy. For the winter give a two-pound cake of candy, and do not forget to look at this from time to time, to see that it is not exhausted. The correspondent referred to secured his bees earlier than yourself, when honey was probably coming in freely, but he gave his bees a considerable amount of work to do at the wrong time of the year. Had it been an unfavourable season they would probably have died.

ERRATA.—In the reply to query No. 8240 in our last issue on Rendering Wax a printer's error appeared. Line 14 should read, "Wax should *either* be melted by the direct rays of the sun, &c."



### HOW TO SELL HONEY.

The marketing of honey has occupied considerable attention of late. What can be done in this direction is shown by an enterprising north country firm of grocers. The leaflet, as given below, is distributed amongst customers, the result being greatly increased sales:—

*Honey as a Food.*—Honey as a food is most valuable, and it is again becoming very popular as an article of food in daily use. Before the introduction of sugar, honey was almost entirely used as a sweetening agent for all purposes for which sugar is now used. Honey, however, has valuable properties as a food which sugar does not possess. When honey is eaten practically the whole of it is assimilated by the system, there being little residue, and therefore little digestion required. This is due to the fact that the sugar of commerce requires "inverting" before it can be absorbed by the system; whereas honey, being partly digested by the bees already, calls for no tax on the digestive organs. It is thus especially valuable for children and for such persons who from various reasons are unable to take ordinary sugar. Honey is very valuable in the kitchen, where it can take the place of sugar in the making of many dishes in daily use.

*As a Medicine.*—As a medicine, honey is much recommended for coughs, colds, asthma, and all throat and chest affections, and also for constipation and similar troubles.

Our honey is produced by our own bees, extracted under the best possible conditions under our own personal supervision, and is *guaranteed pure*. In 16oz. screw stoppered jars, 1s. each; or in customers' own jars at 10d. per lb. Messrs.—Grocers and Provision Merchants.

### PROSPECTS OF SEVERE WINTER.

A correspondent sends the following curious press cutting from a daily paper, as an interesting item for bee-keepers. "A certain and sure production for a severe winter is forthcoming in the reports received from bee-keepers that they are everywhere noticing the bees doubling the walls of the hives with an extra lining of wax. The instinct of these intelligent builders is never at fault, and when they take this extra precaution it is in provision of an exceptionally cold winter. The ancients of the villages can only remember a similar proceeding on the part of the bees in the year 1869, before the cold year that preceded the Franco-German war."

A correspondent writes:—"With reference to an interesting recent note from a correspondent, who infers from the fact that this year the bees are doubling the walls of their hives with an extra lining of wax that these "intelligent builders" have an intuitive perception that a cold winter is in prospect, I suggest that there may be another explanation of the double walls. Is it not possible that the extreme heat of this summer made the bees' wax unwontedly soft, and that it was necessary to build thicker walls than usual in consequence of this? Your correspondent quotes the year 1869; the preceding summer, 1868, was, I think, the hottest and driest summer within the last quarter of a century, which seems to support the suggestion I venture to make."

### Notices to Correspondents.

*Letters or queries asking for addresses of manufacturers or correspondents, or where appliances can be purchased, or replies giving such information, can only be inserted as advertisements. The space devoted to letters, queries, and replies is meant for the general good of bee-keepers, and not for advertisements. We wish our correspondents to bear in mind that, as it is necessary for us to go to press in advance of the date of issue, queries cannot always be replied to in the issue immediately following the receipt of their communications.*

J. H. M.—*Covering Hive Roofs.*—We cannot agree with you; as a practical carpenter we know that damp is sure to collect between the linoleum and the roof. Having tried all methods, we find the only successful one is to use calico treated in the manner described; by so doing it is made part and parcel of the wood.

R. E. (Amlech).—*Buying Honey.*—You were right in returning the honey under the circumstances. It is certainly "vile stuff." There is a slight smell of heather about it, but it is full of impurities, and has portions of dead bees floating about in it, being altogether so unsavoury that we prefer not to taste it. It is also fermenting, which is not surprising considering the amount of foreign matter it contains.

D. M. (Wishaw).—*Drone-breeding Queen.*—The queen is not a good one and should be replaced by a new one as early as possible.

W. A. C. (Castle Cary).—*Queen Lost While Manipulating.*—The queen you found was no doubt a fertile one, and the stock is now most probably queenless. This can be definitely ascertained by a thorough examination. The bees will remain quiet for a longer time when queenless at this period of the year than in the summer. Her absence from the

hive for so long a time, and consequent feeble condition, would account for the bees in the hive refusing to allow the queen to enter.

J. D. (Denbigh).—*Queen Found on Alighting Board*.—The queen was badly crushed in the post, so we can say nothing about her. If you are quite sure the hive is queenless, it will be best to requeen even now.

C. R. (Wickford).—*Bee-keepers in Canada*.—Write to the editor of the "Canadian Bee Journal," at Brantford, Ontario, who no doubt will be able to give your son the names of bee-keepers near Woodstock.

S. M. (Hounslow).—*Foundation in Shallow Frames*.—You must wire foundation even in this case, or the combs may break when extracting.

A. W. (Ilfracombe).—*Increase Extraordinary*.—Your description is quite correct; it is a "fairy tale." If you are wise you will not attempt it.

J. L. (Newton).—*Dealing with Soiled Combs*.—(1) You should not try to save the combs, but melt them down. There is some danger of the food stolen affecting the colonies which robbed the diseased stock. Keep a sharp watch for signs of disease, and if they appear, treat the stock as advised in the "Guide Book."

Mrs T. T. (Surrey).—*Honey from Diseased Stock*.—The honey is quite fit for human consumption, but must not be given to bees. You must also be careful to burn the wood of the sections when the honey has been used.

A. D. (Tipton).—*Vitality of the Wasp*.—The insect is a queen wasp, and in spite of the immersion it had undergone it was still alive when it reached us.

#### *Honey Samples.*

B. (Lewes).—The samples are not numbered or distinguished in any way. The light honey is good in all respects but density, which is only fair. The darker sample is also good, and would certainly do for a local show.

H. F. (Pontypool).—A good heather mixture, worth from 1s. to 1s. 2d. per lb., retail.

ENQUIRER (Hereford).—Both are very good samples. No. 1 is pure clover and No. 2 mainly sainfoin.

F. O. S. (Newton Abbott).—No. 1 is mainly from bell-heather, good in every respect but density. No. 2 is from mixed sources and has just a little heather in it. Extracting from brood-combs accounts partly for its dull ap-

pearance; there is no honey-dew in either and both are quite fit to eat.

C. P. (New Barnet).—A very insipid, light-coloured honey of poor density and no aroma. As it has practically no flavour except sweetness it is difficult to say from what source it has been gathered.

WILLIAM STEPHENSON.—Sample No. 1 is a very nice clover honey worth 56s. per cwt. No. 2 medium colour from mixed sources, density very poor, worth 50s. per cwt. No. 3 sample was smashed in post, but appears to be fermenting. No. 4 was also smashed. It is a good heather blend worth 60s. to 70s. per cwt.

#### Special Prepaid Advertisements.

Two Words One Penny, minimum Sixpence.

Orders for three or more consecutive insertions entitle advertisers to one insertion in "The Bee-keepers' Record" free of charge.

Trade advertisements of Bees, Honey, Queens, and Bee goods are not admissible at above rate, but will be inserted at 1d. per word as "Business" Announcements, immediately under the Private Advertisements. Advertisements of Hive-manufacturers can only be inserted at a minimum charge of 3s. per ½ in., or 5s. per inch.

#### PRIVATE ADVERTISEMENTS.

LIMNANTHES DOUGLASII; strong plants, 4d. per score, post free.—R. LITMAN, Castle Cary. 14

12 DOZEN good Dark Honey, screw bottles, 6s. 8d. dozen; ½cwt. fine Light Clover Honey, 28s.; ¼cwt. medium ditto, 25/-.—M., c/o "B.B.J." Office, 23, Bedford street, Strand, London. p 39

6 28lb. tins of Honey, splendid flavour, 58s. cwt.; sample 3d.—CUTFORTH, Oakham, Rutland. p 47

HONEY, splendid flavour, light or medium colour, 8s. 6d. and 8s. dozen; sample full size bottle, 1s.—ANDREWS, Longthorpe, Peterborough. p 47

WANTED, two strong stocks healthy Bees, plenty winter stores, old Queens and without Hives preferred, cheap.—CROWE, Central-avenue, Wigston, Leicester. p 46

COCKERELS.—White Wyandottes, Goode's strain, strong and healthy, utility birds, reared with freedom in fields, February, March hatched, 7s. each.—HOPKINS, Broadoak, Leigh-ton Buzzard. p 46

6 DOZEN good Sections, 7s. 6d. per dozen, safely packed; cash with order.—EDWIN BLAKE, Jun., Deddington, Oxon. p 44

FOR SALE or exchange, good line Ferret, rabbit. — II. SIAMARK, Willingham, Cambs. p 43

BUCKWHEAT HONEY for SALE; also 20lb. good Beeswax, fine colour; sample 2d.—HAZZARD, Haddenham, Ely. p 42

WANTED, lewt. good Dark Honey, price on rail.—8, Orchard-road, Colchester. p 41

## Editorial, Notices, &c.

### BEE DISEASES LEGISLATION.

This matter has been brought before us owing to the receipt of several letters on the subject, one of which, headed "Apiaries Regulation Act," by Mr. G. Thomas, will be found on page 445. While commending and thanking the "Smallholder" for assistance we cannot help expressing our regret that it should have taken up the matter without reference to what has been done and is being done at the present time by the British Bee-Keepers' Association with regard to legislation. This Association has had the question before it for very many years, has not allowed the matter to rest, has been in close touch on the subject with the Board of Agriculture, and was now obtaining the information required. It will be recollected that in the interview with Lord Carrington on 17th March, 1910, he asked that the B.B.K.A. should obtain evidence that the majority of bee-keepers were in favour of legislation, which would strengthen the hands of the Board of Agriculture in dealing with the matter. The Chairman of the B.B.K.A. at that interview produced 700 voting cards obtained by one county Association, all those signing with the exception of one being in favour of legislation. We would also point out that most county Associations, as well as local Associations, have already passed resolutions in favour which they have sent to the B.B.K.A. and the Board of Agriculture. That a large number of bee-keepers favour legislation is already well known, but this is not sufficient, as the Board of Agriculture, before moving in the matter, naturally desire to know the extent of the opposition. This can only be obtained in the way the B.B.K.A. is now proceeding. We would point out that a strong representative committee was appointed, and held its first meeting in Liverpool on 23rd June, 1910. At that meeting the draft of the bill, proposed in 1904, was taken as a working basis, and after being discussed, clause by clause, alterations were made to include all bee-diseases in the proposed bill. This as amended was printed on page 273 of "B.B.J.," for 14th July, 1910. This led to a considerable correspondence in our columns both for and against, and the committee have since taken into consideration all the objections raised, and have amended the proposed bill, so that it is hoped there will now be no opposition to it, or, at any rate, that it may be so insignificant as not to influence the Government against legislation.

We would therefore urge upon those secretaries of Associations and district secretaries who have not already done so to assist the B.B.K.A. in obtaining the ballot required in order to arrive at an estimate of the opinion of the majority of bee-keepers. This is the only obstacle at present in the way of legislation and we do not think petitions in favour, however numerous and well intentioned, are likely to have any influence on the Government at present.

### GENERAL SIR STANLEY EDWARDES GOLDEN WEDDING.

We have much pleasure in reprinting the following from *The Daily Telegraph* of October 13th:—

"General Sir Stanley and Lady Edwardes, of Sponden, Sandhurst, Kent, will celebrate their golden wedding on Sunday next. Sir Stanley is a son of the late Captain George Edwardes, of the Bengal Army, was born in 1840, entered the Bombay Corps in 1857, and has seen a great deal of active service. In 1858 he joined in pursuit of Tantia Topce, was in the Abyssinian Expedition of 1868, for which he received the medal, took part in the Afghan Campaign of 1879-80, was appointed colonel of the 102nd (King Edward's Own) Grenadiers in 1905, having a few years previously been made a K.C.B. Lady Edwardes, whom he married on October 15th, 1861, is a daughter of General G. A. Leckie, Indian Army."

General Sir Stanley Edwardes is a practical bee-keeper, and for many years has been an active member of the Council of the B.B.K.A., and we are sure all bee-keepers will join with us in congratulating Lady Edwardes and himself on the happy event, and in wishing them many more happy years together.

### BRITISH BEE-KEEPERS' ASSOCIATION NOTICE.

Will any reader having a copy of the Report of the British Bee-keepers' Association for the year 1897 kindly forward it to the Secretary, 23, Bedford Street, Strand?

### AYRSHIRE AGRICULTURAL SOCIETY.

The annual show of the Ayrshire Agricultural Society was held on October 19th and 20th, at Kilmarnock, and proved in many ways one of the most successful exhibitions ever held by this association, the show being in point of size a record one for Ayrshire. In the honey section there were 150 entries against 103 last year, and the judge (Rev. R. McClelland) had some difficulty in making his awards, the

quality being so uniformly good. The awards were as follows:—

*Six 1-lb. Jars of Extracted Honey* (29 entries).—1st, A. White, Lyndhurst, Cumnock; 2nd, P. McDonald, Amulree, Cumnock; 3rd, John Henderson, St. Serfs, Cumnock; v.h.e., Richard Allen, Tusmore, Bicester, Oxon; h.e., Alexander F. Borland, The Knowe, Cumnock; S. G. Leigh, Broughton, Hants; c., James Pearman, Derby.

*Six 1-lb. Jars of Extracted Heather Honey* (15 entries).—1st, A. White; 2nd, James Halliday, Slogarie, New Galloway; 3rd, P. McDonald; v.h.e., James H. W. Fishwick, Cathburn, Lancashire; James Pearman; h.e., W. M. Lloyd, Lancaster; c., John Ross, Dumfries.

*Six 1-lb. Sections* (15 entries).—1st, John Ross; 2nd, James Pearman; 3rd, John McDonald, Dumfries; v.h.e., Joseph G. Nicholson, Cumberland; h.e., H. C. Gibson, Ballygowan, Belfast; c., Richard Allen.

*Six 1-lb. Heather Sections* (10 entries).—1st, P. McDonald; 2nd, James Halliday; 3rd, Joseph G. Nicholson; v.h.e., Alex. F. Borland; h.e., John Ross; c., A. White.

*Six 1-lb. Jars of Granulated Honey* (10 entries).—1st, Robert Steven, Irvine Road, Kilmaurs; 2nd, Richard Allan; 3rd, J. Woods, Mansfield; v.h.e., R. Brown and Son, St. Ives, Hunts; h.e., R. W. Lloyd, Norfolk; c., John Shannon, Kingscourt, Co. Cavan.

*Bee-wax* (15 entries).—1st, John Ross; 2nd, W. Patchett, Caistor, Lines; 3rd, R. Brown and Son; v.h.e., John Rowlands, North Wales; h.e., John Shannon; c., John Duncan, Burnhouse, Galston.

*Three 1-lb. Jars of Extracted Honey (limited to exhibitors resident in Ayrshire)* (13 entries).—1st, P. McDonald; 2nd, A. White; 3rd, Alex. F. Borland; v.h.e., John Henderson; h.e., John Duncan; c., David Briggs, Maybole.

*Three 1-lb. Sections (limited to exhibitors resident in Ayrshire)* (7 entries).—1st, Hugh McQuiston, Dankeith Dairy, Kilmarnock; 2nd, A. White; 3rd, P. McDonald; v.h.e., John Nisbet, Cumnock; h.e., David Briggs; c., Allan Gibson, Tarbolton; John Dodd, Tarbolton.

*Two 1-lb. Jars of Extracted Honey* (25 entries).—1st, A. White; 2nd, P. McDonald and John Henderson (equal); 4th Alex. F. Borland; v.h.e., John Shannon; h.e., W. Patchett, Caistor, Lines; c., Lindley Alderson, Kingscourt, Co. Cavan.

*Two 1-lb. Sections* (15 entries).—1st, John Ross; 2nd, Joseph G. Nicholson; 3rd, John McDonald; v.h.e., A. White, James Smith, James Pearman; c., Hugh McQuiston.—*Communicated.*

## LEICESTERSHIRE B.K.A.

### AUTUMN CONFERENCE.

A very successful autumnal conference under the auspices of this association was held at the Higheross Restaurant, Leicester, on October 28, Mr. A. E. Biggs, chairman of the organisation, presiding.

Mr. Faulkner, delegate to the meeting in London of the British Bee-keepers' Association, presented a résumé of the business dealt with by the parent society for the benefit of county associations and the bee-keeping industry.

The Chairman distributed the silver medals won at honey shows held during the past season to A. J. Marriott, C. Bottrill, J. E. Weston, G. S. Jesson, H. Dilworth, M. E. Varty, and J. Waterfield.

Objects of interest to those engaged in the craft were exhibited, and a general discussion followed.

After tea musical items were well rendered by the Orpheus Male Quartette Party, and Mr. W. K. Bedingfield followed with a very instructive lecture entitled "More about bees and their relations," illustrated by photo-micrographic lantern slides.—*Communicated.*

---

## HELPFUL HINTS FOR NOVICES.

By W. Herrod.

### PROCURING SURPLUS.

There is no doubt but that the most profitable system of working for surplus is shallow frames for extracting. At the same time it is necessary to take into account the district and also the demands of our particular market. There are some districts where it is impossible to produce good comb honey. In such it is futile to attempt the production of sections, the only successful method in such cases being to work for extracted honey by means of shallow frame supers. If the district is suitable for the production of comb-honey and the bees are kept near a town which is more residential than industrial, or near a seaside or inland holiday resort, then undoubtedly comb honey production will pay the best. Amongst the class of people usually residing or visiting in such localities comb honey is more in demand than extracted, for two reasons; first it is more delicate and appetising when put on the table in the comb, and secondly they imagine it is impossible to adulterate comb honey. In a manufacturing centre, on the contrary, the people desire to get all they can for their money, and therefore prefer to buy the honey in a jar, and not in the comb, looking upon the latter in the same light as they do on the bone in their joint of meat, "some-

thing which is useless and has to be thrown away."

The points in favour of producing extracted honey are as follows: (1) There is less danger of swarming; (2) a greater quantity is obtained on account of saving comb building; (3) the supers can be tiered up and remain till the end of the season; (4) the honey obtained can be stored for any length of time.

We will first of all consider the super. This, as already remarked, should contain shallow and not deep frames except under exceptional circumstances, such as mentioned before in these hints, where they will be required for driven bees at the end of the season. Many bee-keepers use shallow frames, yet if asked why, they can give no reason beyond the fact that everyone else uses them. In extracting there is not so much danger of the comb breaking as there would be in a deep frame; they are also much more comfortable to handle so far as weight is concerned either singly or collectively in the super. Then again the shallow super can be given much earlier than a deep one, as it will not check brood-rearing by giving too much space at one time. Heat rises; therefore if a 9in. chamber is given, the bees have to maintain the temperature in it as well as the brood-chamber, thereby wasting their energy and also food. The object of the bee-keeper should be to obtain combs as straight as possible; the combs should also project beyond the woodwork of the frame so that the cappings can be cut off quite easily, and not have to be dug out. The cells should be drone, as they take less wax, and the honey presents a larger surface for ripening; it also leaves a larger cell more easily than a small one, and it provides the bees with a means of exercising their natural instinct in building drone comb in a place where it will be harmless, the excluder preventing the queen from getting up and ovipositing; therefore the rearing of a lot of useless drones is prevented. The foundation should be wired, and the combs eight in number, for the storage of food we can dispense with the  $\frac{7}{8}$ in. thick comb and go to 2in. In doing so two sheets of foundation are saved in each super, also the secretion of wax for sealing the faces of four sides of combs, which would be necessary if ten frames were used as in the brood chambers. It is difficult occasionally to get the bees into the super when all the frames contain foundation and are widely spaced. This can be overcome by using the ordinary narrow end until the combs are built out, when they can be replaced by the wide ones.

(To be continued.)

## Correspondence.

*The Editors do not hold themselves responsible for the opinions expressed by correspondents. No notice will be taken of anonymous communications, and correspondents are requested to write on one side of the paper only and give their real names and addresses, not necessarily for publication, but as a guarantee of good faith. Illustrations should be drawn on separate pieces of paper. We do not undertake to return rejected communications.*

### THE B.B.K.A. AND LEGISLATION.

[8289] In the report of the Council meeting of the B.B.K.A., published in the BRITISH BEE JOURNAL for September 12th, mention was made of the draft of a Bee Diseases Bill which had appeared in the "Smallholder." As I am mainly responsible for this Bill, and a great many communications regarding it have reached me from bee-keepers all over the country, I should like to define as clearly as possible my own position in the matter, as well as that of the paper with which I am connected; and at the same time to dispel certain misconceptions that have arisen respecting my motive in bringing the Bill forward at the present juncture.

In the first place, it is in no spirit of antagonism or journalistic rivalry that the measure proposed by the "Smallholder"—which, for convenience, I have called the Apiaries Regulation Act—has been put before the public. Nor have I, as a loyal member of the British Bee-keepers' Association, any other feeling than one of warmest sympathy towards the Council in their renewed efforts to get a Bee Diseases Prevention Bill presented to Parliament. To all that they have done, and are trying to do, no bee-keeper of experience and foresight could extend less than a whole-hearted admiration and support.

But, so far as my knowledge goes of the provisions of the Bill which the B.B.K.A. will be advised by the Legislation Committee to adopt, I find it impossible to agree that these provisions are sufficient to meet the necessities of the case.

I have before me the B.B.K.A. Draft Bill, published in the BRITISH BEE JOURNAL for July 14th, 1910; and so far as I am aware, no amended version, nor any official communication regarding the Bill, has since appeared. Taking, therefore, of necessity, the original text as that still representing in the main the committee's proposals, I, and I believe many other bee-keepers having the welfare of British apiculture at heart, profoundly mistrust the efficacy of the measures advocated.

The points raised from time to time by opponents of legislation in general have been effectively dealt with by the Editor of the "B.B.J." and others, and all reasonable men must now regard them as finally out of court. My own sincere objection is quite on the other side. I cannot but think that the association is only tinkering with the matter; that it is trying to effect a compromise which will not only satisfy objectors to the Bill, but will fail in a great degree in the achievement of its principal object—the mitigation, and perhaps the final stamping out, of bee-diseases throughout Great Britain.

To this view I know there exists a certain amount of adverse opinion, but I am also assured that a very large body of bee-keepers agree with it in the main.

The two vital points wherein I think the B.B.K.A. Bill is deficient are, first, that the fixed-comb hive is apparently to be allowed to remain in the country as a perennial source of re-infection of cleansed stocks, thereby being a means of nullification for all legislative effort; and, second, that nothing is to be done to control the importation of infected queen-bees, honey, and foundation.

If we allow box- and skep-hives, which are practically unsuspectable, to exist in the land, and if we continue to permit contamination to be brought freely into the country from infected foreign districts, it seems to me that no Act of Parliament, however admirable in other respects, can be anything less than a dead-letter. No one who has studied the working of the Apiaries Act in New Zealand during the last four years, and the masterly reports thereon by Mr. Isaac Hopkins, could, I think, arrive at any other conclusion.

I am fully aware that the task of getting a Bee Diseases Bill through Parliament would be greatly facilitated if the Bill proposed were of so mild a nature as to ensure its being treated as uncontroversial matter by both sides of the House. I am convinced, however, that the B.B.K.A. are sacrificing too much for expediency's sake; and I have felt it, therefore, my duty to lay before bee-keepers—before the great body of smallholders who are so rapidly recruiting our ranks, and especially before all honey-lovers, the public generally, who are equally interested in the prosperity of bee-farming—what form I think legislation must take if it is to have any permanently beneficial effect on the industry.

In a sense, we are at the end of our tether in this matter. As the Editor of the BRITISH BEE JOURNAL truly said some time ago: "Unless something is soon done (to combat bee-diseases) it is difficult to see how the industry can go on much

longer." But if that something is only to be aimed at the effect, while leaving the main cause of the evil largely untouched—if we are only going to lop off the twigs of the poisonous tree and leave branch and root still to flourish—I for one would rather see the whole question shelved for the present, and trust to the hard logic of events in the near future to bring home to legislators the truth of what bee-laws are really needed. Will not our new Minister come to our aid?—TICKNER EDWARDES.

#### THE SURVIVAL OF THE FITTEST.

[8290] In reference to the question asked by me at the recent conversazione, quoted on page 432 of the BRITISH BEE JOURNAL, as the reporter has condensed my long, detailed query into seven lines, and has thus failed to convey my meaning, may I ask your permission to refer again to the matter?

The question I asked was this: If queen-cells are begun on the same day over three larvae of one day, two days, and three days of age respectively, would the last-mentioned cell produce a queen first, so that, as she would destroy the two remaining queens, there would not be the survival of the fittest?

The theoretical answer to this question is in the affirmative, and almost all bee-keepers, including myself, hold this view; yet a gentleman who is both an experienced bee-keeper and a scientist argues that the last-mentioned cell would not produce a queen first, the inmate having been fed on the highly-nourishing food for so short a period, but that the first queen would issue from the first-mentioned cell, as a result of the normal period of feeding.

To test the point with certainty would involve time and opportunities which are not at my disposal; but I shall be glad to hear whether any of your readers have carried out the experiment and recorded definite results. To put the matter in another way: Does the length of time that the larva feeds on the highly-nitrogenous food affect its development after the queen cell has been sealed over?—J. B. LAMB, 3, Maitland Park Road, N.W.

#### A SUCCESSFUL COTTAGER.

[8291] An illustration of what can be done by cottagers (especially in such a season as the past one has been) has recently come to my notice. A farm labourer, living in a quiet little Somerset village, recently took to bee-keeping, and made his own hives. The outer cases are Lipton's tea boxes, but the inner fittings are all right. At the commencement of 1911 he had eleven stocks, which have

been increased to eighteen. But, in addition to this increase, he has made a net cash profit of £20 during the season from the sale of honey, &c. When he is in full work he earns 13s. 6d. per week, but often receives less, in consequence of bad weather and slackness of employment, so it will be readily understood what a boon the additional income has been. Indeed, he is most enthusiastic and devoutly thankful as he speaks of his bees. Like a careful and intelligent man, he has opened a Savings Bank account, "so as to have a nest egg if a rainy day should come." His best hive yielded 130lb.—C. T., Somerset.

#### FACTS ABOUT BEES.

[8292] Life is too short for one to learn all there is to know about bees, yet, if one hundred bee-keepers would share the details of but five years' experience, would not each become nearly as wise as though he had kept bees some 500 years?

Your columns furnish an opportunity for the experiment to be tried, at any rate, and what I propose is a sort of Referendum on interesting questions. I offer as a simple example the question of the way bees build combs in new (previously unused) skeps or boxes. I invite your readers who have had cases before them to write me a post card stating what was observed, as below, and I will undertake to tabulate the results and present the conclusions in a further letter. The following questions should be answered, referring to same by number and without repeating the question:— (1) Name and address of owner of skep or box. (2) Race of bees. (3) Was a skep or a rectangular box used? (4) Were the combs placed (*a*) substantially at right angles to entrance, *i.e.*, end on, (*b*) substantially parallel to entrance, *i.e.*, side one, or (*c*) diagonal to entrance? (5) If diagonal, were the ends to the left or right of entrance, as seen by observer, facing the entrance? (6) Did the entrance face N., N.W., W., S.W., S., S.E., E. or N.E.? (7) Was the box or skep previously unused, and if not so, then which way were the combs built previously?

This is a method by which bee-keepers in a small way, and with no literary ability, can be of service. If the idea is acceptable, I shall be happy to follow it up with further questions, and would ask for your readers' suggestions.—E. B. WEDMORE, The Old Hall, Clifton, Warwickshire.

#### APIARIES REGULATION ACT.

[8293] I would like to draw the attention of your readers to a proposed Bill for

the benefit of bee-keepers published in the "Smallholder" of September 23rd. Our thanks are due to the Editor of this paper for the interest he displays in bee-keeping by bringing forward this "Bill."

I wrote to him, pointing out what I thought to be deficiencies in the proposed Bill, *e.g.*, Clause III. I ask for three days' notice of intended visit of inspector to avoid the balling of newly-introduced queens. Some notice is necessary to extensive apiarists, because they might not be on hand to inform him of such recent introductions.

I also suggested dates between which stocks may not be examined, and in the "Smallholder" of October 14th Mr. Tickner Edwardes (the framer of this Bill) urges the examination of stocks any time "when the thermometer stands above 50deg., with absence of rain or strong wind" *between the dates October 1st and May 1st, that is, in winter* (page 176, "Smallholder," bottom third column).

In my opinion, it is not safe to examine any stock at any time during the winter. The bees should be fed well in autumn and not disturbed until late spring.

The examination of the brood in each hive does not take long; in fact, I would undertake to examine all stocks in Pembrokeshire in one month in summer. In my own apiaries I can examine 170 stocks in five days quite comfortably; in fact, at a pinch it can be done in three days.

Clause III. must be altered to allow the importation of appliances, and Mr. Tickner Edwardes quite sees the force of this in his reply of October 14th to my letter. It is quite impossible to cure foul brood without the new frames and foundation, a point which seems to have been overlooked. He makes a point of the danger of infected foundation, but if the importation of any other than "weed" foundation into an infected area were prohibited that point would have been got over.

There are a certain number of bee-keepers who are opposed to legislation of the kind proposed. It is only right that their opinions should be, to a certain extent, respected, but the majority of us wish for an efficient Act. Under these circumstances I think we ought not to allow too much to the inspectors in the matter of interpreting it. Their duties should be clearly stated, so that all shall know to what extent they may proceed. This is only fair to opponents of legislation.

Clause VI.—Mr. Tickner Edwardes, in his suggested Bill, proposed that no honey shall be removed from an apiary which has

been taken from the brood-box of an infected stock. I have had no experience of foul brood, but cannot imagine anyone extracting honey from a rotten comb; yet there may be clean combs of honey in the brood-box of those hives which contain from fifteen to twenty-two combs, of which there are many in use in South Wales, and, I presume, other parts also. Would not this honey be in the same category as honey from the supers of an infected stock?

Clause VII. prohibits the importation of foreign bees from infected districts abroad. This will be of great benefit, but at present I do not see how it will be discovered whether a certain apiary abroad is infected or not.

The British Bee-keepers' Association have, I believe, the draft of a proposed Bill, and I think a good opportunity now presents itself to take the good points of both Bills, put them before the readers of the "B.B.J." and of the "Smallholder" for discussion, and proceed to get signatures from bee-keepers and others interested in bee-keeping.—G. THOMAS, Coedwelyn Stackpole, Pembroke.

[We allude to this in an article on page 441, but would point out that the question has already been thoroughly discussed in these columns, and that the B.B.K.A.'s amended Bill is based to meet the objections raised. We do not think any good can be served at the present moment in going over the same ground again, but when the proposed Bill is published we will give ample opportunity for discussing any fresh objections which may be raised.—ED.]

#### RANDOM JOTTINGS.

*By C. H. Heap, Reading.*

Mr. D. M. MacDonald has indicated how the objections of Mr. Woodley and others to legislation with regard to bee-diseases may be met; but I think if some of the opponents of Parliamentary action had the misfortune to have stocks which suffered from foul-brood or some other pest their opposition would be appreciably weakened. Isolated on the heights of Beedon, Mr. Woodley, for instance, has never had an outbreak of foul-brood in his apiary during the many years he has been a notable and honoured member of our craft. For a dozen years after I bought my first swarm foul-brood was unknown to me, and I took a languid interest in foul-brood bills. In an evil hour, however, I bought two stocks of bees at a country vicarage, on the assurance, in writing, that they were free from disease. As I had to place them close to a road, and they showed a vicious disposition, I

thought it advisable to put the supers on without making a careful examination of the combs. When I took off the shallow frames at the end of the summer I discovered foul-brood. After my purchase I cycled into the neighbourhood from which the bees came, and was not surprised by my subsequent discovery, for I found an apiary the like of which one might travel a thousand miles without seeing. The bees for the most part inhabited boxes piled promiscuously on the top of one another, and covered with sacking, pieces of old oil-cloth, tin, or anything that would turn a drop of rain. The place resembled a marine store dealer's yard more than anything else. Some day, if this wonderful apiary still exists, I hope to get a photograph of it for reproduction in the BEE JOURNAL. It will provide a good argument without words for a little regulation of some phases of the industry.

*Ignorance and Experts.*—From time to time there is a disposition to criticise and to magnify the faults of the bee expert. While there are varying degrees of competence among experts, we must not forget that many owners of bees know so little about their tiny labourers, and about scientific methods, that they cannot properly understand the advice given them, while others will interpret the advice in such a way as to suit their own ends. Through the purchase of a swarm I once made the acquaintance of a middle-aged lady who kept bees. She knew practically nothing of the subject, and had to engage a man living in the village to hive swarms, and to put on and take off supers. One day early in June I gave her a passing call. She was greatly troubled because she had some broken comb and could not get the honey from it. The comb was badly infected with foul-brood, and I was told that the bees one day got to it and were very troublesome. It seemed that as the combs were old the lady had decided to have the bees driven later on, but the old fellow who did the work in the apiary, on learning her intention, persuaded her to let him drive the bees there and then. As he did not know what was the matter, his act was reprehensible in the extreme, and no doubt in this case brought its own retribution. Had the colony not been diseased, the driving of his stock and the break-up of combs full of brood would have been a wanton destruction of bee-life.

*An Injustice.*—I was asked to look at the remaining hives, and at the end of July examined the two frame-hives and found one with foul brood in several combs. I advised one of several courses; but the lady would not be satisfied until the super was placed on the hive again, although there was not the remotest pros-



pect of getting an ounce of surplus honey. Now came an injustice to one of the county experts. I received a letter two months later saying that Mr. —, the expert, had called. He said the bees I had looked at would do no more good, and had advised her to sell them. Would I make an offer? Of course, I did not want the worthless stock; but it showed me how easily an expert's advice may be perverted. I knew the expert, and did not for a moment believe he had advised the sale of these diseased bees. What probably hap-

#### AN EGYPTIAN APIARY.

The picturesque illustration below of an apiary in Egypt gives one an interesting view of the scenery in that Old World country. The bees are kept in very primitive fashion.

The hives, which are constructed of clay, are cylindrical in shape, the ends being loose. In the centre of one end can be seen a hole which allows ingress and egress to the bees. The hives are stacked together and present the appearance of a clay wall. The honey is obtained by removing the back end, the

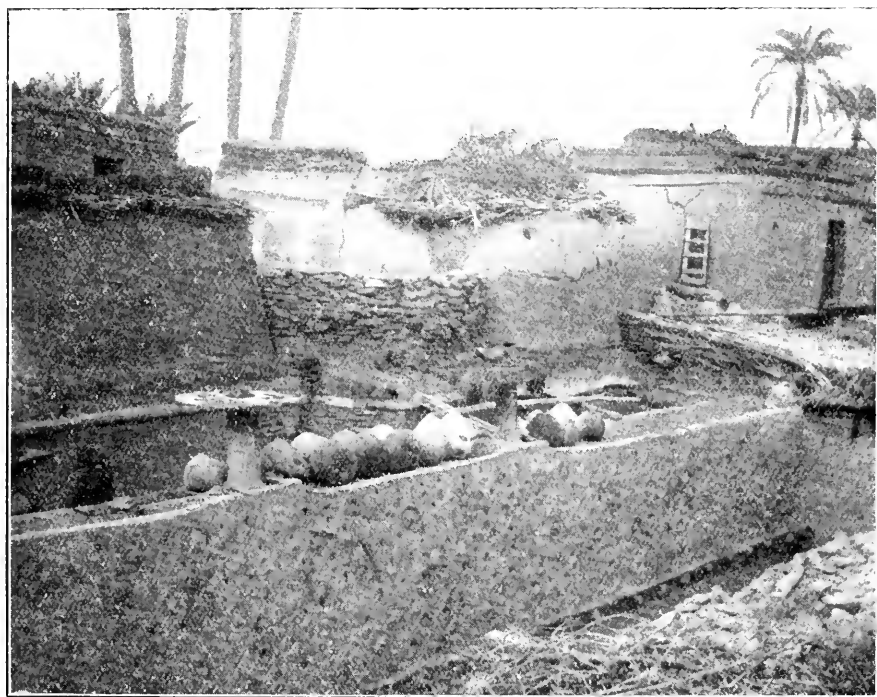

AN EGYPTIAN APIARY.

pened was this: the expert advised her to get rid of the bees; and being possessed of a strongly-developed commercial instinct, the lady bee-owner jumped to the conclusion that the bees should be disposed of, as sickly cattle, pigs, and poultry are, to some unwary purchaser. Why I was singled out for this doubtful compliment I cannot imagine. How much better it would have been if the expert had had power to order the destruction of the bees than that the owner should have the right, providing a customer could be found, of sending the stock to infect a neighbourhood in which possibly the disease was unknown.

bees being then driven from the combs by burning a particular kind of wood. The combs containing honey and brood are then removed and consumed intact. The natives do not seem to mind eating the brood as well as the honey; in fact, they seem to prefer this mixture. One man will own as many as two thousand of these primitive hives.

The greatest enemy of bees in Egypt is the hornet, and to prevent their depredations Arab boys are employed to kill them with a flapper, *i.e.*, a large piece of leather fastened to the end of a stick, by means of which they knock down and kill the hornets.

## Queries and Replies.

[8244] *Candy as a Food for Bees.*—With regard to feeding with candy in autumn or putting candy on for use in winter to make sure that there is sufficient food, how do you account for the bees taking the candy down, say in late October? Is this not as bad as feeding syrup late in the year, and does it not defeat the object for which the candy is supplied? Can there be any difference between feeding good thick syrup and feeding candy? if there is, I should say that the syrup is better, as no water is required by the bees in addition.

I have fed with candy as you advise for wintering, and I find that the bees have taken the whole lot below as soon as possible after it has been put on the hive. I do not understand this wintering with candy at all.—LUKE BERRY, Nelson.

REPLY.—If candy is well made bees will often take it in preference to their own stores for immediate use. Syrup feeding would be wrong as the bees do not require a lot of moisture in late autumn and winter. It cannot be used up in their bodies, and causes distension of the bowels unless they can get out to void their excreta. When breeding, liquid is necessary to make chyle food; at that time the bees are flying, which makes all the difference. The idea of candy is to give a food practically all of which can be used up in the body of the bee.

[8245] *Utilising Large Hive.*—I shall be glad if you will advise me on the following through the "B.B.J." I bought a job lot of hives, and among them is one very large one; it is 24½ in. long, inside measurement: (1) I should be glad to know what was the object of the bee-man in making such a hive. (2) How can I utilise it? It will take sixteen standard frames and division-board. (3) Can I make two hives of it? If so, how can the supering be done? What would you suggest to make the best use of it, as there is so much waste space. It is very elaborately made, and must have cost a lot in making. (4) What is the best thing to keep extractor from rusting? Can it be painted with aluminium paint?—MOXMOUTH.

REPLY.—(1) The hive is no doubt one of the old combination pattern in which the honey was obtained at the back of an excluder dummy placed at the tenth frame. (2) Simply use a dummy board and work the stock on ten frames. (3) No, don't try it. (4) After use, the extractor should be well washed in hot water, thoroughly dried, and rubbed with vaseline.

[8246] *Various Queries.*—Would you mind answering the following questions in your next issue of "B.B.J."? (1) Could I insure against injury to cattle by barbed wire fence, of course for an extra premium? (2) Will honey keep well in tins, if kept airtight? Will it be contaminated in any way by the metal if allowed to stand for months? (3) Is there any danger of bees balling the queen if the hive is opened on a fine day in March or the beginning of April? (4) Is it useless introducing a fertile queen (or virgin) to a hive with a laying worker in possession? Would the bees prefer the fertile worker, and does the season make a difference? (5) In uniting two stocks, which queen is sacrificed, the incoming one or the one in possession? Of course, if both were equally valuable we should take one away. (6) We are Derbyshire people, but live on the borders of Notts. Would it matter if we joined the Notts Association, as that county is the handiest for us? I may say we appreciate the Journal very much, and although bee-keepers of some years standing we have picked up several ideas from it.—W. A. H., Alfreton.

REPLY.—The B.B.K.A. do not issue such a policy. (2) Honey will keep for any length of time without contamination in tins if hermetically sealed. (3) There is always a certain amount of danger of balling on the first examination after a winter's rest. (4) The only way it can be done is to cage the queen on a comb of unsealed brood from another hive. (5) Always select the youngest and most prolific queen irrespective of which colony she is in, and cage her. (6) The Notts Association, like most of the others, take members two miles over the border, and as the Derbyshire Association is not affiliated to the B.B.K.A. its members are not eligible for the benefits therefrom. We should strongly recommend you to join the Notts Association.

[8247] *A Beginner's Queries.*—I am only a beginner in bee-keeping, and have made a few hives. In the meantime I have been looking about for some bees. I have just found some for sale, and went to see them yesterday; they are about eight miles from here. They are on bar frames the two lots, being in a box covering the whole. The owner has become too old to look after them, the result being that both colonies are full of honey which has not been touched this season. There are no supers on. Now I am having them sent over to my place and should like your advice as to the best way to settle them for the winter. Should I take some of the honey away, or let it remain? The stocks seem strong, and I should like to divide them next spring. If this is advisable, how should I proceed? But for the present I should be glad to

know how I shall be able to make them comfortable for the winter.—F. WOODHOUSE, Chelmsford.

REPLY.—The hive should be set quite level from side to side, and tilt about  $\frac{1}{2}$  in. to the front. See that the quilts fit down neatly, provide winter passages, and put in naphthaline. Make sure that the roof is quite watertight. Drive a stake down at one side, to which tie a cord; pass it over the roof and tie a brick at the other end, so that it hangs just below the floorboard and does not knock against the side of the hive. Do not remove honey at all. The entrance should be open about 4 in. Leave quite quiet until next spring, and in the meantime buy the "Guide Book" and read up the methods of increase.

[8248] *Hive Blown Over in a Storm.*—During last week-end we have had a very bad storm here and unluckily one of my hives was blown over, although I had taken the precaution to rope it down. I discovered the accident soon after it happened, and immediately set up the hive and tried to arrange the frames. I was very surprised to find that the bees had not suffered much, and though a great many must have been blown away, there is still a good stock in the hive. I moved the hive into a portable wooden building and it is there now. Also, I found a bee which I am afraid is the queen lying dead on the ground where the hive had overturned. (1) I enclose it, and would be glad if you would let me know if it is the queen. (2) In future I shall keep my bees in a beehouse, and would be glad if you would let me know how to fit one up. (3) I noticed several drones in the hive, and wonder why these have not been killed off. Can you find any reason for this? (4) Do you think the stock will survive the winter, or will the disturbance have been too much for them? Thanking you in anticipation.—E. E. W. G., Symonstone.

REPLY.—(1) The bee is a worker. (2) We do not advise keeping bees in beehouses. If you rope the hives they should be quite safe. (3) It points to queenlessness. (4) They should be all right now; there is nothing more you can do to ensure their survival at present.

[8249] *Dealing with a Queenless Stock in November.*—The bee-keeper must be prepared for all sorts of surprises, many of them unpleasant. I packed my stocks for winter some five weeks ago, assuring myself, first, that each had a laying queen, and plenty of stores. For the past week, or more, the bees have been bringing in pollen in considerable quantities. Two days ago all were exceptionally active, the temperature rising to 56deg. One of my strongest stocks, on ten frames, with a July queen raised by themselves, which

was laying well when I packed the hive, was particularly busy at 11 a.m. At 11.30 I happened to look at the hive again, and saw a queen standing motionless about a foot in front of the hive. I picked her up and warmed her in my hands and presently her wings began to quiver and she crawled over my hand. Making sure that she came from the hive in front of which I found her, I put her three successive times at the entrance, and each time she was seized by a worker and hustled off the alighting board. The last time a worker seized her by the head or antennæ, rolled off the alighting board with her, and even then I had some difficulty in separating them. Not knowing what else to do I brought her into the house, put her in a match-box, and gave her some honey and kept her warm, but by 4 p.m. she was dead. I suppose I ought to have caught about a dozen workers, put her in a queen cage with them, and given them some Good's candy, but I had neither a queen-cage nor any of the candy. My intention was, if I could keep her alive, to let her slip under the quilts at dusk by Simmins' method. About 2 p.m. the bees seemed to have discovered their loss. Numbers of them were scurrying in and out of the hive and all over the alighting board, taking short flights and returning, frantically searching for the missing queen, and yesterday they were doing the same till long after the other hives were quiet. I confess I am quite at a loss to understand the reason for the queen thus leaving or being forced out of the hive, but, no doubt, with your long experience you may be able to suggest one. May I ask you, further, which, if any, of the following alternative plans you approve of? (1) Put the queenless stock on the top of the next hive only 3ft. away. The latter is not nearly so strong, but has a laying queen. Put no excluder between them, but a sheet of brown paper with a few small holes in it, so as to allow some days to elapse before the bulk of the two stocks meet, and remove the paper at the end of a week. I wish to avoid using smoke or exciting the bees more than I can help, and therefore I do not suggest dusting the two stocks with flour. My idea, too, is to choose a cool day when very few bees are flying, and moving the hive with the two stocks 18 in. nearer the stand where the queenless stock is at present; of course, removing the latter altogether. (2) Put the weaker stock with the laying queen on the top of the queenless stock in the same way. (3) Place a clean warmed hive between the other two and remove both stocks into it, one on the top of the other in the same way, and remove the other two hives. I wish to give them all their stores and that is why I desire to put one on the top of the other.—J. G. DALZELL.

REPLY.—We should adopt plan No. 1. It is difficult to suggest a reason for the strange occurrence without examining the queen.

## Notices to Correspondents

Letters or queries asking for addresses of manufacturers or correspondents, or where appliances can be purchased, or replies giving such information, can only be inserted as advertisements. The space devoted to letters, queries, and replies is meant for the general good of bee-keepers, and not for advertisements. We wish our correspondents to bear in mind that, as it is necessary for us to go to press in advance of the date of issue, queries cannot always be replied to in the issue immediately following the receipt of their communications.

J. A. S. (Penzance).—*Honey Granulating Badly*.—Yes. Reliquefy it by standing it in a vessel surrounded by hot water.

E. L. (Forest Hill).—*Good Honey District*.—We do not know very much of Raynes Park. It is no doubt a suitable place in which to keep a few hives of bees, but if you intend to go in for bee-keeping on a large scale, it will be necessary to locate the apiary more than twelve miles outside London.

B. J. (Kirriemuir).—*Dealing with Infected Hives and Honey*.—You must certainly not use the honey for spring feeding. The hives can be used if they are first thoroughly disinfected by scorching the insides with a painter's spirit lamp.

### *Honey Samples.*

SILICON (Co. Durham).—The sample of heather honey you send is a very fine one. We are using it personally and find it excellent. Thanks for your kind remarks *re* the BRITISH BEE JOURNAL.

### *Suspected Disease.*

J. S. (Carnforth).—From outward symptoms it appears that the bees are suffering from Isle of Wight disease. In order to verify this, send a few (alive, if possible) to Dr. W. Malden, Medical Schools, Cambridge. In the case of the sample of comb, it contains chilled brood only.

CONSTANT READER (Swansea).—(1) The comb shows that the stock is affected with foul brood. Put Apicure in the hive until spring, when you can see the state of the colony. (2) It is not powerful enough. (3) Yes, by using either Apicure or Formaldehyde. (4) Strong stocks sometimes become affected through robbing weak and diseased colonies, and the robbers carrying home the disease.

A. H. D. (Brighton).—We are sorry to say the bees show outward signs of having died of "Isle of Wight" disease. We congratulate you on the neat way in which you packed the bees, and wish all our correspondents would take similar pains, as it would save us both trouble

and annoyance. Though meeting with such discouragement at the outset of your bee-keeping career, we hope you will try again, as your neatness and method show that you are just the one to succeed eventually.

## Special Prepaid Advertisements.

**Two Words One Penny, minimum Sixpence.**  
Orders for three or more consecutive insertions entitle advertisers to one insertion in "The Beekeepers' Record" free of charge.

Trade advertisements of Bees, Honey, Queens, and Bee goods are not admissible at above rate, but will be inserted at 1d. per word as "Business" Announcements, immediately under the Private Advertisements. Advertisements of Hive-manufacturers can only be inserted at a minimum charge of 5s. per  $\frac{1}{2}$  in., or 5s. per inch.

## PRIVATE ADVERTISEMENTS.

**5 CWT. PURE EXTRACTED CLOVER HONEY,** 28lb. 15s. 2d.; new cans free, carefully packed, free on rail; Northants County guarantee label; immediate delivery.—MORRIS, Welland Valley Apiary, Barrowden, Stamford.

**M**R. FARROW begs to inform customers that all the goods are sold.

**B**ACHELOR, Nurseryman, well connected, successful apiarist and breeder prize poultry, pigs, &c., stock now value £60, wishes correspondence with Bee Expert who understands cows, with view to combine apiaries, milk round, and fruit farming; must have moderate capital and genuine worker; half house rent free; all correspondence welcome and replied to; profits shared.—NURSERYMAN, c/o Mr. Dryer, Glenside, Great Hadham, Herts. p 50

**WHAT OFFERS** in motor cycle or fittings for gentleman's 3-speed cycle, value £6, and 3 strong Stocks Bees, new standard hives; particulars.—E. WHITEFIELD, 7 Elizabeth-street, Houghton-le-Spring, Durham. p 51

**D**ESIRABLE HOUSE, 1 $\frac{1}{2}$  acres ground, stables, out-buildings, To be Let, £40; or sold. Suitable for small-holding, excellent bee district, within 20 miles London.—JUDGE, Lanes-end, Dartford. p 52

**C**HAPMAN HONEY PLANTS, all sizes, seeds, wallflower seeds, borage do., cornflower plants, pansy do., assorted packet, 6d.—JOHN BRADLEY, Stretton, Yockleton, Shrewsbury. p 53

**A**BOUT 60lb. DARK HONEY; free sample; no reasonable offer refused.—JACKSON, Duxford, Cambs. p 54

**E**XCHANGE for good Granulated Honey in tins, two gentlemen's 25in. frame cycles, value £3 and £6 respectively.—W. H. WYATT, Bishopswood, Chard, Somerset. p 55

**W**ANTED, secondhand copy Cheshire's "Bees and Bee-keeping," vol. 1 (scientific).—DENTSON, Stockton, Rugby. p 56

**6000 WALLFLOWERS FOR SALE,** Vulcan and Golden King, good bushy plants, 2s. 6d. per 100 or 22s. 6d. per 1000; packing free.—J. BROOKFIELD, 108, Stamford-road, Birkdale, Southport. p 59

**2 CWT. of LIGHT COLOURED EXTRACTED HONEY** at 56s.; carriage paid.—E. BENNETT, Heacham, Norfolk. p 58

**W**ANTED, instructive or interesting Bee-keeping Lantern Slides or Photos to produce from.—R. STEELE, Newburgh, Fife. p 59

**W**ANTED, well-made Body Boxes and Ripener, in perfect condition.—BUZZARD, Buxted. p 60

**F**OR SALE, LIMNANTHES DOUGLASHII PLANTS, 1s. 100, post free; also Canaries.—A. JACKSON Elveden, Thetford. p 61

## Editorial, Notices, &c.

### THERAPEUTIC VALUE OF HONEY.

Dr. Demade, who writes on this subject in *L'Abeille de l'Aisne*, says that for some years he has been convinced as to the valuable properties of honey, resulting from his observations on young children suffering from acute or chronic diarrhœa, which he had at that time under his treatment. He relates that the Lady Superior of the Convent at K— asked his advice about a tiny, miserable-looking baby of eight to nine months old which lay in its mother's arms. It gave one the feeling that it had only to close its eyes and die. It was a lamentable example of diarrhœa, with all the symptoms of the most advanced stage of this disease, which the Flemings call *d'oude man* (old man). It was emaciated to an extreme degree, had a cadaverous appearance, with black rings under the eyes and the lower stomach fearfully large. The sufferer had no appetite whatever, but was tormented with almost incessant vomiting and diarrhœa. What could a medical man hope to do in such a case, when any breath might be the last?

However, on the supplications of the mother, who stood there pressing this little remnant of life to her heart—her ninth child, which she said she loved better than all the rest—Dr. Demade prescribed a diet of nothing but honey and water for eight days, and, turning to the Lady Superior, he added that if the child were still living at the end of that time she should put it on a diet of diluted goat's milk, in the proportion of one-third milk to two-thirds water.

Dr. Demade thought no further about this case, as he never expected the child to live, but three months later, on visiting the establishment, he was shown a healthy-looking, well-nourished child, only slightly discoloured under the eyes, its stomach reduced to normal proportions, with an excellent appetite and regular habits. This was the miserable little creature which had been metamorphosed by means of the honey. He also learned that the grateful mother recommended his remedy in all her district. Every time a child in her neighbourhood suffered from stomach disorder she advised the use of diluted honey for a more or less extended period, and showed her child as an example of the beneficent results of such treatment.

Dr. Demade profited by his experiments, and afterwards used this honey remedy systematically in all cases of infantile diarrhœa. By his general success in numberless cases he came to the con-

clusion that honey—unfermentible and easily assimilated—was a valuable therapeutic agent in most diseases of the digestive organs. How does honey act? Dr. Demade thinks in two ways: by reason of its cleansing and nutritive properties. It is antiseptic, almost free from fermentation, and it is also an aliment ready for assimilation without digestion.

To complete his demonstration Dr. Demade adds that he has tried honey in two other very different cases.

(1) In that most obstinate of all diarrhœas which follow an advanced stage of pulmonary consumption;

(2) In diarrhœa to which young animals, such as chickens and turkeys, are subject during their early growth.

In every case he obtained the same results—namely, the stoppage of diarrhœa and the return of the desire for nutrition.

The list of chemical products that have been tried up to the present for cleansing the intestinal canal, with variable results, some of which work other mischief, is a long one, and the doctor thinks that honey can with advantage replace them all, and that its therapeutic and nutritive value in such cases as have been mentioned must be obvious to everyone.

In a communication to *La Reforme Alimentaire*, Dr. Demade says "that it should be easy for any practitioner with commonsense to recognise the reasons for this high value possessed by honey. It is, in the first place, a most extraordinary natural product. It is a sugar, but not of the ordinary kind. It is antiseptic, almost free from fermentation, and withal capable of almost instant assimilation in the organism with next to no exertion on the part of the digestive agents. Ordinary sugar is saccharose, whereas honey is glucose. The former ferments readily, and has to be turned into glucose by the action of the saliva or some of the other digestive juices before it can be assimilated. In the case of a healthy stomach saccharose can be dealt with at no great expense to the system; but when the digestive organs have been weakened by disease, and the whole nervous system is extra-sensitive, sugar should be withheld and honey given."

[Several of our readers have cured a number of cases of infantile diarrhœa, which was so prevalent during the past summer. They were induced to try the remedy by an article in our pages on the matter some time ago, and it is in response to a special request, to bring it to the notice of the public for the benefit of others, that we reprint it. We give above the most recent information on the subject,

and hope our readers will give it their earnest attention.—Ed.]

### SUSSEX B.K.A.

#### ANNUAL SHOW.

The Sussex Bee-keepers' Association held their first honey show on October 31st and November 1st, at the Dome, Brighton, in connection with the Brighton and Sussex Horticultural Society's Chrysanthemum Show. The quality of the honey shown was excellent, and the number of entries very large, especially in the open classes for 1lb. bottles and 1lb. sections, and in consequence the competition was very keen. The show was largely attended on both days, great interest being taken in the honey department, as it was quite a new feature in Brighton. Lectures were given during the day by the Expert, Mr. C. T. Overton. The judge, F. B. White, Esq., made the following awards:

#### MEMBERS' CLASSES.

*Six 1-lb. Sections* (nineteen entries).—1st, E. Baruch Blaker, Worthing; 2nd, Miss Burder, Barcombe; 3rd, Mrs. Hossack, West Wittering; sp., A. G. Davey, Burgess Hill; v.h.c., E. Watts, Partridge Green; h.c., E. S. Read, Arundel, and J. Fairall, jun., Hellingly.

*One Shallow Frame* (six entries).—1st, Parker and Hind, Rottingdean; 2nd, Sisters of Bethany, Crowborough; 3rd, A. Capelin, Falmer; sp., Miss Thomas, Lewes.

*One Standard Frame* (three entries).—1st, the Hon. Mrs. Goldman, Rottingdean; 2nd, A. Capelin; 3rd, Miss Thomas.

*Six 1-lb. Jars of Light-coloured Extracted Honey* (twenty-one entries).—1st, Miss Burder; 2nd, Rev. W. R. Nightingale, Selvaston; 3rd, A. Capelin; sp., B. J. Burtenshaw, Cuckfield; v.h.c., Mrs. Hossack; h.c., G. Butler, Crawley, and A. J. Stevens, Siddlesham.

*Six 1-lb. Jars of Medium-Coloured Extracted Honey* (eighteen entries).—1st, A. J. Stevens; 2nd, Rev. A. A. Evans, East Dean; 3rd, Mrs. Charrington, Lewes; sp., J. Fairall, jun.; v.h.c., Miss Burder; h.c., A. G. Davey, Miss Longhurst, Frant, and Miss Thomas.

*Beeswax* (eleven entries).—1st, G. Butler; 2nd, J. Fairall, jun.; 3rd, E. Baruch Blaker; sp., Mrs. Bissett, Broadwater.

#### OPEN CLASSES.

*Single 1-lb. Section* (nineteen entries).—1st, Richard Allen, Bicester; 2nd, Miss Hossack; 3rd, A. Burtenshaw, Hassocks.

*Single 1-lb. Jar of Extracted Honey* (twenty-eight entries).—1st, S. J. S. Leigh, Broughton; 2nd, A. Jones, Farnham; 3rd, B. J. Burtenshaw.

#### NON-COMPETITIVE EXHIBITS.

*Display of Honey*.—E. Baruch Blaker,

and C. T. Overton and Sons, Crawley.

*Observation Hive of Bees*.—C. T. Overton and Sons, Crawley.—C. OVERTON, Hon. Sec.

### CRAYFORD B.K.A.

#### ANNUAL MEETING.

The annual meeting of the Crayford and District Bee-keepers' Association was held at Crayford on October 27th. There was a good attendance of members from several miles' radius. Mr. E. R. Stoneham (President) was in the chair.

The Secretary (Mr. J. M. Bates) presented the balance sheet, which showed receipts amounting to £19 13s. 8d., and expenditure totalling £15 1s. 4d., leaving a balance in hand of £4 12s. 4d.

The Secretary's report for 1910-11, which dealt in detail with the Society's work, was also presented.

In adopting the report, very great regret was expressed by those present at the news that Mr. E. R. Stoneham was unable, owing to pressure of public work, to accept nomination as President for 1912. A special vote of thanks was passed, and a note of Mr. Stoneham's highly valued services ordered to be placed on the minutes.

Mr. S. K. Keyes, of the Dene, Dartford, was elected President, whilst Messrs. E. R. Stoneham, A. Dewey, A. M. Fleet, J. Roper, G. Bryden, and G. P. Baker were appointed Vice-Presidents.

Mr. J. M. Bates was again re-elected Secretary and Treasurer; Messrs. Judge, Bryden, and Roper, experts; Messrs. Judge and Smiles, representatives on the B.B.K.A. Council; and Messrs. Smiles, Abraham, Barnes, Firmin, Judge, Hewitt, Sykes, Upton, Newman, with Mrs. Simms and Miss Smiles, as the Council for the ensuing year.

A very fine winter programme was submitted by Mr. Judge, and he received the cordial thanks of those present.

For the first time the experts of the Society (Messrs. Judge, Bryden, and Roper) presented their annual report, and the following interesting information is culled from it:—The year 1911 was an excellent one for apiculture. There was very little disease, only seven per cent. of the total number of colonies being affected. Experts are of opinion that compulsory Parliamentary powers should be sought for dealing with bee diseases. Close watch must be kept for so-called "Isle of Wight" disease. Members—Bee-keepers, reporting, 71; non-bee-keepers, 8; bee-keepers refusing information, 3; bee-keepers now left district, 5; total, 87; stocks in frame hives, healthy, 254; diseased, 21; total in frame hives, 275; stocks in skeps, 6; grand total, 281;

swarms secured, 29; nuclei formed, 17; queens reared (for requeening), 31; honey production, complete sections, 2,100; extracted honey, 5,307lbs.; total, 7,407lbs.; beeswax, 41lbs. Retail price for sections and extracted honey, 11 $\frac{1}{2}$ d. per pound (average).

### HONEY REPORTS.

The value of honey imported into the United Kingdom during the month of October, 1911, was £3,064.—From a return furnished to the BRITISH BEE JOURNAL by the Statistical Office, H.M. Customs.

### AMONG THE BEES.

#### EXPERIENCES.

By D. M. Macdonald, Banff.

"A Hollow Tree."—This favourite home of the bee, so well known in Virgil's time, is now and again resorted to by a run-away swarm. Two came under my notice this year, one of which I aided in "taking down." My assistant was one of our new third-class experts, and on him fell the burden of the work. By "soundings," it was judged that bees occupied about 9ft. of the hollow interior, so, after the tree was thrown, this length was cut off. The bees were partly stupefied with sulphur fumes, and the log cut into three parts by a cross-cut saw. The bees, during this operation, were discovered to be pretty active owing to the large number of openings and cracks in the timber allowing the fumes to escape freely. In spite of this, combs were quickly broken out of their setting and transferred to a roomy receptacle, after being brushed clear of bees. Two or three spectators kept at a respectful distance, leaving the work to the two experts. In the end, a quantity of about 30lb. of honey was handed over to the owner of the bees, the workers not having received a single sting. Very curiously, the queen was discovered on one of the last combs handled. The opening in the tree would have measured only 5in. or 6in. in diameter, but ran up for over 10ft., and every inch of this was utilised by the bees as a breeding-place or for storing honey.

*Hiving a Swarm.*—We were three of the most enthusiastic bee-keepers who ever handled bees, perhaps. We had done valorous deeds on a broiling hot summer's day in hiving a double swarm which had settled high up in a tall tree, and then transferring it to a capacious hive. Dinner had been kept waiting until the operation was brought to what we short-sighted mortals thought was a successful climax; and we attacked the meal with a hearty zest, imparted by duty well

done. Across the walnuts "and the wine" my two clerical "aids" and I were discussing our various performances in hiving swarms, when the sharp tones of a female voice was heard shouting, "The bees are off!" So they were, and on a higher tree, and high in that tree too. The youngest of the trio volunteered to ascend, and the other two were nothing loath to let him. It was a stiff climb, and he was burdened with a heavy rope and a saw, but he shinned up that tree marvellously, in spite of the torrid heat and the broiling sun, and the clouds of bees covering his track. The rope was with considerable difficulty thrown over a higher branch, fastened to the one on which the swarm had clustered, and then the saw was plied successfully; we two below doing all the "bossing," he, aloft, doing the work! Slowly but surely that mass of bees came down steadily, in spite of stings freely administered to the operator above, from that high altitude where they had clustered, to be eagerly seized by two excited apiarists. What a mass of bees were everywhere—there must have been fully 10lb. of them! A solemn procession of three—for we honestly waited until the "worker bee" had joined us—carried the branch to the empty hive, all three proud of our prowess. First to last, it took four hours or more to perform the doughty deed. What a splendid future was predicted for that mighty swarm! Did they fulfil expectations? Somehow, bees seldom do; they do nothing invariably. These did not; they decamped, not leaving a single bee behind, at 1 p.m. next day!

*Waspish Bees.*—They were worse than wasps! Hornets could not be so bad. Bees in all my past experience never were before. The day was not an unfavourable one, and the smoker did its duty fairly well, while the fuel was corrugated packing-paper, which usually works correctly. They were stranger bees, but I had no reason to suspect them of undue ire. My duty was to take off two racks of sections, and as soon as I had drawn aside the under-quilt I used the smoker gently. Clouds of bees rushed out, however, and stung every exposed part. I blew in more smoke, but that only incensed them still more. I saw it was to be a pitched battle, and tried to wrench the top rack off, when it *parted in two*, one half coming off in my hands, the other remaining solidly glued to the under one! My hands, by this, were really bristling with venomous stings, twenty or thirty in each. More smoke was tried, but it only roused more Amazonian warriors eager to engage in the fray. My veil caught in a thorn hedge, in front of which the hives stood, and this tore an extensive rent. Then my head and face received tokens of the loving kindness of those "blessed"

bees. I had no one near at hand to appeal to. I think if I had I would have bolted! But I kept at it until I had withdrawn both racks, covered up frames, and put on the roof. Then I cleared out with as great pleasure as I ever turned my back on a bee-hive. In those ten minutes I got the worst stinging of my life, and I never want to receive such another!

*Experiments.*—I have had a busy season of experimenting with every known so-called cure of "Isle of Wight" disease (but "B.Well"), and all proved equally effective, *i.e.*, none had any effect. The nearest I came to doing any good was by carrying two fairly strong stocks down to the foot of my garden, shaking every bee off the combs, carrying queens away, and letting all healthy bees return to a clean hive with sheets of foundation on new frames. I presumed the affected bees would remain behind. So very many did. The united lot progressed well for a time, but later the well-marked signs re-appeared. A splendid swarm, my only one this year, was accepted, and placed in a clean, fresh hive on full sheets. They drew out eight combs well, but a month from hiving showed patent signs of being diseased. A driven lot of last year hived on contaminated combs, died out in early summer. A swarm procured this year for the purpose caught the trouble early through being hived on foul combs. So did two driven lots introduced in early August for experiment. I mention these cases as a warning to others, and advise them not to play with fire—*Experientia docet!*

## Correspondence.

*The Editors do not hold themselves responsible for the opinions expressed by correspondents. No notice will be taken of anonymous communications, and correspondents are requested to write on one side of the paper only and give their real names and addresses, not necessarily for publication, but as a guarantee of good faith. Illustrations should be drawn on separate pieces of paper. We do not undertake to return rejected communications.*

### DEALING WITH "ISLE OF WIGHT" DISEASE.

[8294] Will any of the readers of this Journal who have had their bees swept off with "Isle of Wight" disease, and have successfully started again, be kind enough to give their methods of disinfecting? I am informed on good authority that it is unwise to start again. I propose to have a tank made large enough to hold a hive, as I have 130 hives to treat straight off, and putting each hive twice into the disinfectant at an interval of

twenty-four hours, also disinfecting all tools, supers and appliances.

Disinfectant: 8oz. carbolic to gallon of water, *vide* Board of Agriculture pamphlet. Melt up all brood-combs and boil frames in disinfectant. There will be no fear of infection from beeswax, because it will afterwards be treated with sulphuric acid. I have about twelve stocks left healthy in each affected apiary, and I propose to leave these and their combs alone, after first transferring them into disinfected hives and disinfecting the vacated hives. I have about 1,400 shallow extracting combs at my two apiaries, and I propose to leave these alone, as it is such a big loss to melt them up. What do you suggest? [Melting them, or, better still, burning them.—Ep.]

The ground at each place I propose to treat to two loads of lime. Both the daughters and grand-daughters of one queen have had none of their bees infected yet. Do you think there can be something in the strain? Will any who have successfully started again please reply?—G. THOMAS, Coedmelyn Stackpole, Pembroke.

### A NOTE FROM SOMERSET.

[8295] A village curate who lives in a parish on the moors commenced bee-keeping this year, and had 150lb. of honey from two stocks. These he has now increased to four by driving bees for his neighbours. He is keen on giving instructions to those who are willing to learn, as to the use of the frame-hive and its many advantages.—C. T. (Somerset.)

### HOMES OF THE HONEY BEE.

#### APIARIES OF OUR READERS.

We have great pleasure in presenting a photograph this week of a veteran bee-keeper, Mr. F. V. Hadlow, who has been a reader of the "B.B.J." almost since its commencement. To continue with the hobby for over forty years, and to still take a delight in it after so long a period, shows that Mr. Hadlow is a true lover of bees, and the industry is much indebted to him for the work he has done in promoting the more humane treatment to the "bee people."

The view of my apiary was taken about five years ago. The more distant figure shown is my gardener, who has been with me forty-one years and more. The youth standing nearer the front of the picture is in training as my helper. He has been such an apt pupil that when he joined the Territorials three years ago, and was asked to describe himself, he said he was a bee-expert.

Though a Londoner by birth I have always loved the country. In 1850, I started a business in Brighton, and travel-



led there daily, but in spite of this I have kept bees at my present place for forty years. I naturally thought that the natives here would teach me the craft, but I soon found myself drawing very large diagrams, giving lectures, and manipulating bees in the bee-tent.

When I began, there was a magazine conducted by the late Mr. Charles Nash Abbott, and bees were shown at the Crystal Palace by a gentleman who took for his motto "Never kill a bee," because at that time almost always bees were killed when their honey was harvested.

At first I made innumerable experiments as to hives, using the ordinary skeps at the beginning, then buying large flat skeps and fixing wooden tops adapted for glass bells, which were much used by Mr. A.

the back was taken off and a long case hooked on, all the bars, which were hinged together, could be drawn out and the bees on each side of all the combs could be seen. This was very well received at Brighton Park, and at Preston, where Mr. Cowan presided. He was very kind, and though it was not for competition, gave me a certificate of merit.

I took the same exhibit to London, and was so disappointed with the result that I shut it up and returned home, not a single question being asked. I was soon asked to send it North, but I wrote to the secretary, saying that it had been badly received in London, so that I was disheartened, and did not mean to try again. I am now nearly eighty-five, and my sons attend to my business. I can still em-



A VETERAN BEE-KEEPER (MR. F. V. HADLOW) IN HIS APIARY AT BUXTED, SUSSEX.

Neighbour. Once I fitted bars into a round skep, but it was not long before I found the immense advantage of the now indispensable bar frames in rectangular hives. On one occasion when "Peace" was in the air, I made my bees work out the word in honey-comb, and exhibited it at a Brighton Flower Show. A lady who was much pleased with it asked me how it was done, and as it would not have been easy to explain, I told her that one had to whisper to the bees overnight what you wanted, but added that it was just as well to give them at the same time a "plan" of operations. Once after a great deal of thought I invented an observatory hive with glass sides for show purposes. The bees were on bars in a square hive, but if

ploy myself with roses, bees, &c., but I require help. All my hives are home-made, though I am not a carpenter, but an engraver.

I provide a bee-way at the top of each hive by having a wooden cover under the quilts; this is lifted  $\frac{1}{4}$  in. above the bars and is divided into about six pieces, the largest being provided with a feed-hole. The other five vary in size, till the last is only 1 in. wide.

In order to regulate the supply of naphthaline, I make short round boxes of perforated zinc, which are fitted into round holes at the lower part of the back; these can be examined at any time without disturbing the bees.

I could keep on writing much longer, but I believe I may already have exceeded the limit. I always take in the bee magazines, and keep a recent edition of the "Guide Book" handy, and I think Mr. Cowan and the whole of the B.B.K.A. have great reason to be gratified at the progress that has been made in advanced apiculture in a comparatively short time.

## THE HONEY HARVEST OF 1911.

### BRIEF REPORTS.

Readers in many parts of the country have been good enough to send us short reports of the season in their locality. It is both interesting and instructive to study them and observe the varying degrees of success in the different counties, though the general consensus of opinion appears to be that the season was a very good one on the whole.

#### BEDFORDSHIRE.

Season good right through for both quantity and quality, some hives yielding as much as 200lb. of honey.—H. S.

#### BERKSHIRE.

The honey season in this district, although the takes are not so good as one could have wished in several instances, must be recorded as a fairly good one. Some stocks that were strong in bees yielded 60lb., others less, and some nothing. Hives that were weak in spring were left to be strengthened with swarms which never came off; the weather in April was cold enough to chill the brood in some cases, and before the bees could recover themselves a month later the honey flow was full on, and consequently the brood-nest got filled with honey instead of young bees. The few swarms that did come off had a mania for absconding; straw skeppists had swarms galore, and very good takes of honey. The takes of honey in this district this year from bar-frame hives may be classed on an average from 35lb. to 40lb. per hive, which is about the usual for a moderately good season. Of course this is about three times more than last year.—NOSEMA APIS.

#### CAMBRIDGESHIRE.

The bee-keepers of Cambridgeshire have this season had the best honey harvest for very many years. What the harvest would have been had the weather not been so dry and hot, it is almost impossible to say. I understand in some parts of Cambridgeshire the "takes" have been very large indeed, and I may say in all my wanderings through the county I have not heard one single complaint. In fact, the bees appeared, in the early spring, to be so busy gathering nectar that they had no time even to swarm, for swarms have been very scarce indeed. What swarms

did come off soon established themselves, and did remarkably well, giving in some cases four and five racks of sections. Honey is fairly plentiful in Cambridgeshire, but not so abundant as some of the London newspapers seem to imagine, when they say that producers can give it away. I find that not to be the case; at any rate I cannot get anybody to give me any. Trusting to have another such season next year. I am sure it has done the bees a world of good, and disease a very great deal of harm.—ERNEST F. DANT.

#### CHESHIRE.

I find that the honey harvest in this district has been the best since the last Coronation year. Honey has not only been abundant but of good quality. Takes of 1cwt. from a single hive are quite common.—E. W. FRANKLIN.

#### CUMBERLAND.

The season in Cumberland and Westmorland has been a fairly good one, although nothing like the quantity of honey expected has been secured. In the majority of districts the want of rain was detrimental to the free blooming of clover, whilst on more retentive soils the pasture was good, and a large surplus was secured. The honey was of very good quality, and no honey-dew has been gathered. I have had reports from many districts, some to the effect that a very large amount has been harvested, but the majority have taken less than in 1910. The heather season was a peculiar one. Fine weather prevailed, but the honey-flow was one of the shortest owing to the heather drying off prematurely on account of the drought. The fortunate ones who had their stocks on the moors early secured an average of from 30lb. to 40lb., but the harvest was over here by August 15th, and bee-keepers who sent their stocks up at the usual time harvested little or none at all.—G. W. AVERY.

#### DEVONSHIRE.

You will be glad to hear our hive of black bees has done well for Okehampton, having given us 114lb. of honey. My Carniolans have done badly, so I have started them again with driven bees and one of Mr. Sladen's British golden queens.—C. T. B.

#### DORCHESTER.

The honey harvest in this district varied: some parts gave very good returns, others a good average crop. Much depended on clovers; owing to drought there was little or no second growth. Heather and ling gave no returns, the bloom having quickly dried up. Bees are generally in good order everywhere. No "Isle of Wight" disease, and very few cases of foul-brood, then only through neglect. Honey was of grand flavour and colour.—H. C.

## DURHAM.

In Tyneside and West Durham the season has been splendid, heather honey in the comb selling readily at 1s. 1d. to 1s. 4d. per section in shops. Shopkeepers are offering 1s. wholesale, but bee-keepers can sell (if they are known) all they have easily at these prices direct to the consumer. Losses during last winter were very heavy owing to early cessation of breeding in the autumn, which has caused a 50 per cent. reduction of stocks, so that the total crop is relatively small. Good hives gave 30lb. clover and 20lb. heather.—J. N. KIDD, Stocksfield.

## ESSEX (Terling).

Some bee-keepers about here tell me they have done very badly. I have never had a better season myself so far as quantity goes, but the quality of quite two-thirds of my surplus leaves something to be desired, being flavoured more or less with ragwort.—RICHARD DUTTON.

## GLOUCESTERSHIRE.

I quote the opinion of our largest bee-keeper, who has several hundred hives in the Cotswold Hills. "I do not consider the season a record yield: just a good average and nothing more, except in certain extra-well situated localities." His crop, I may add, is almost entirely from clover and sainfoin, the honey-flow from which was of short duration, owing to the abnormal heat. Another bee-man from the Cotswolds writes: "What a good season we should have had with a drop more rain." On the other hand small apiaries in the valleys and lowlands, where successive harvests are obtained from fruit blossom, flowers, field crops, and limes, have done well. Thus I have four hives in my garden, which I fed early, and got into good condition for the fruit blossom: they have given me 364lb. surplus, best hive 126lb., and have required very little feeding for winter. The harvest from lime-trees was exceptionally good, thanks to the showery weather during the latter part of June. A bee-man from near Bristol tells me that he had 300lb. from five stocks, and no swarms, "they did not seem to want to swarm."—REV. F. H. FOWLER.

## HERTFORDSHIRE.

Have been very successful this year with the bees, 321lb. extracted and 130 sections from nine hives.—F. P. HOWARD, Ware.

## HAMPSHIRE.

The honey harvest in this district has been well over  $\frac{3}{4}$ cwt. According to report of course, sufficiently so to make up for the many bad ones preceding it. In many apiaries the average per hive has been well over  $\frac{3}{4}$ cwt. According to all reports that we have been able to collect from members of the local association,

there has been no honey-dew gathered, and all the honey is of prime quality, light, thick, and of good flavour. Stocks in the majority of cases, have abundant stores for winter, the only drawback in seasons of this description, for those who have not sufficient spare time to give full attention to their hives, being the insufficient number of winter bees owing to the clogging of the brood frames with honey.—E. L. and H. C. JONES, Andover.

## HEREFORDSHIRE.

This has been a record year for honey in this district. I have taken 463lb. of honey from seven hives. The most I took from one hive was 90lb. 12oz.: from one super I took 51lb. 2oz. All are shallow frames.—A. D. R., Ledbury.

## ISLE OF MAN.

I had twenty hives spring count, three I used for increase, I have no queens beyond their second season. Had one swarm only. Have taken 900lb. of good quality honey, from seventeen stocks.—A. W. GRANT, Sulby Glen.

## KENT.

The season in the district between Otford and Maidstone, has, after the fine promise of the earlier months, been very disappointing. The bees were very late in flying and working, and it was May before manipulations were safe. From early May till the second week in June it was ideal weather, and the bees took full advantage of the fruit blossom. During the second and third weeks of June bad weather was experienced, and then a very hot dry period set in: instead of helping the honey harvest, it scorched up the blossom, and fields of sainfoin and clover, destroying all chance of a good harvest. A little honey was gathered from the limes, but only in a few places was any stored. Owing to the shortage of food, the queens practically all stopped laying in August, and have only started where feeding was in progress. A little honey has been gathered from the ivy, also from third crops of lucerne and clover. The heat so scorched up vegetation, that I have repeatedly seen apples that had been partially baked on the trees.—HENRY BRICE.

(To be continued.)

---

## Queries and Replies.

---

[8250] *A Beginner's Queries.*—I have read in some bee books that the "Queen only leaves the hive for fertilisation by the drone, and that fertilisation only takes place in the air," which I take to be when a swarm issues. Now if you treat this swarm as a separate stock and put

it in another hive, all well and good, but as the reigning queen goes away with the swarm what possible good can become of the new queen when she hatches with the old stock if you prevent further swarming, unless fertilisation takes place in the hive as well as in the air. You will see by my query that I understand that the queen never leaves the hive unless she accompanies a swarm.

Doubtless your reply to the same will prove interesting to other beginners. Needless to say I take "B.B.J." and find some "daylight" in it. I also have your Guide Book which I find also very enlightening.—J. E. J., Pontardulais.

REPLY.—The queen leaves the hive on two occasions, first for mating purposes, and secondly when accompanying a swarm. The queen goes out alone when taking her mating flight. As she usually emerges from the cell about three days after the swarm issues, and does not leave for mating for another five days, you will see how impossible your suggestion is. When once accomplished, the mating lasts for life. If you read the Guide Book carefully, you will find this explained clearly there.

[8251] *Making Observatory Hives.*—In your issue of the BRITISH BEE JOURNAL, of May 11th last, and also in the RECORD for August a very interesting article from Mr. J. Anderson appeared on "Bee-keeping in Lewes," describing a "Nicholson" observatory hive. I make my own hives and am desirous this winter of making a small observatory hive, but the drawings and measurements I have are of huge things like the Encyclopædia Britannica revolving bookcase. However, as the "Nicholson" is now in the hands of a manufacturing firm, I presume that it is not possible to obtain the measurements. (1) Could you kindly inform me where I could obtain particulars of a hive similar to the "Nicholson"? I was much interested in Mr. Snelgrove's article on "Re-queening," in the "B.J." of October 26th. He advises small bee-keepers to purchase their queens fertilised, but I have bought queens that have let stocks die out, and now having strong stocks would very much like to breed from them. Suppose I were to make a small one-frame observatory, and when the stock in this raised a queen I were to cage it and introduce it à la "Guide Book," and shortly afterwards unite the one frame to any stock in need of it, after removing new queen-cells on frame. Do you consider the idea practicable? It seems to me that I could do all my queen-raising like this, as I never require more than two queens a year, I should lose the foraging bees. (3) Many of your correspondents mention going to their hives in a way that seems to show that they must

open them about once every week in the season. One correspondent, advised novices to practice on one stock, and said, "It will practically ruin it." As one who reads to learn, I would like to know whether it is not better to leave the bees alone as much as possible. (4) Would it be possible to approach your correspondent "Nemo"? Being a bit of a linguist, I would be glad to see some of those French and German bee papers. Would it do to offer to purchase old copies, or should I be gently "sat upon"? If you could spare me a few lines for a short reply to my long queries I should be very grateful. How refreshing the little "Journal" is! All facts, instructive and intensely interesting, in a small compass, a literary, apicultural nut in a shell, whereas we buy our daily paper, and wade through pages and pages of stuff that is of no interest to find a few paragraphs worth reading.—ABEJERO.

REPLY.—(1) The "Nicholson" hive has been patented. The nearest in similarity to it is a "Brice" observatory hive. (2) It is possible to rear your own queens, and you will find it most interesting work. We would advise you to use not less than a three-frame nuclei to get the best results. (3) The "correspondent" who wrote this is now answering you. Having had over twenty years' experience of teaching bee-keeping, he realises the great amount of harm that is done by the novice practising manipulations on all his stocks. It is much better to set one aside and ruin it alone than ruin the lot. That is the idea he wished to convey. You are quite right; let bees alone except for necessary manipulations, and they will thrive the better for it. (5) "Nemo" likes to keep those foreign papers, but if you wish it, and will let us know exactly the papers you desire, we will endeavour to let you have them.

[8252] *Bees Re-queening Themselves.*—On August 13th, I lost a queen of a good colony through bad management, and on the 21st I found five queen-cells in the hive, all sealed. On August 30th I found the queen-cells removed, and on September 9th, I found three frames with brood; some cells irregularly distributed were sealed, and contained *dronc larvæ*. I also found much regular brood, of which none was older than seven or eight days. The queen now lays regularly, and only worker brood. (1) How did these irregular drones originate? (2) Were they laid by fertile workers before the queen was mated, or how is it to be explained? (3) Is it a frequent occurrence that fertile workers develop during the development of a new queen? Thanking you in anticipation of the explanation.—L. W. DEUSS, Fort Johnston, Nyasaland.

REPLY.—There are occasions when unfertile eggs are laid in worker-cells, even by a fertile queen. It is a very rare occurrence, and no doubt this is what happened in your case. Laying workers do not develop during the rearing of a queen; they occur generally when a colony has been queenless for a long time, and the bees have no means of producing another.

[8253] *Bees Clustering in Hive Roof.*  
—A neighbour has a swarm clustered in the roof of the hive. They have combs provided in the brood-chamber, but have not worked down to take possession as it was expected they would do. They are a weak lot, and short of stores. (1) What would be the best way to feed them? (2) In the case of one of my own stocks some few handfuls of bees persisted in clustering in the upper shallow-frame of two boxes put on for them to clean. One cool night the roof was left off, but the cold did not dislodge them. Do you think they could have had a queen with them. I cannot understand why they should persist in staying when there was plenty of room below to which they had access.—  
ICHO, ROSS.

REPLY.—(1) The only way to feed them is to wedge a cake of candy as near the cluster of bees as possible. (2) Bees will sometimes hang about the combs in this manner, and be loth to leave in the autumn for no apparent reason.

#### THE COMMON WASP.

There were five wasp nests in my grounds this year, and two were well placed for observation. The frames of two hives, of which the bees had been lost, were left with their combs, and these were taken possession of by two queen wasps. The nests were opened in early August, and the following points noticed: In the large one, the six central frames (the hives contained twelve each) were filled by the grub pupæ in various stages of development. There were many queen and male cells; these cells were almost the same size. The larger must have been the queen cells, although the male is as large as the female. The queen wasp had taken possession of the bees' cells and deposited her eggs in them without altering the cells in the least. Wasps build their combs with the cells arranged vertically, and the grub is placed with the head downwards. This shows that the queen wasps can adopt changed conditions when there is a saving of labour. Neither queens nor males were noticed among the young wasps in the hive, but empty queen and male cells were there. The smaller nests were probably built by a queen of this year. If these small nests were not

built by this year's queens, how is it that they were so small in the middle of August?

A queen wasp is larger than the worker, but not much, for the difference is not so great as in the queen bees. The male is larger than the worker, and almost the same size as the queen; but its markings are different. In the antennæ, *i.e.*, those fine spines which spring from the head, there are thirteen points, while the queen has twelve. They are feelers, and possibly have a power of smell. The workers are females with undeveloped ovaries as in bees; under certain conditions possibly they may be made to breed. The queens and workers have the power of stinging but not the males.

The queen wasp hibernates during the winter, and at the first approach of warmth she begins to wake up and come out of her quarters. She is seen often near some fluid or offal. Her next duty is the finding out of a good position for her nest. If watched she will be seen to examine carefully many places, especially banks facing south by west; but queen wasps will and do build their nests facing all points of the compass. The amount of energy, skill and forethought shown by the queen wasp is extraordinary. She is an architect and builder, then mother and nurse. She feeds her young on flies, meat, or any soft food that she can find. She cannot suck up the honey like bees. If watched she will be seen chewing up the food before taking it to her young; later she will carry bodily large flies, butterflies, weevils, pieces of fruit and meat. The author watched one nest for hours; he saw the workers carry into the nest bluebottles, grubs, caterpillars, flies, pieces of fruit, parts of the honeybees and portions of wasps. Thus wasps are cannibals.

The art of making paper was known to the wasp possibly before the advent of man. Wasps make their paper from wood pulp. (Wood pulp paper-making is new within the last few years to man.) Watch wasps—one must be near a nest to do so—and you will see that they make their paper from the outside of wood which has been sawn, and by exposure to the weather has become softened. The soft wood is gnawed off, rolled into a ball after being mixed with a secretion from the mouth of the wasp, and carried away to the nest. The ball taken from a wasp and examined with a needle, aided by a hand-lens, is soft and exactly like brown paper made soft or pulped.

The author saw at the entrance of the largest nest the workers feeding young wasps just as a bird feeds its young at the edge of its nest. They carried particles of fruit and other organic matter.

Wasps keep their nests and combs clean, and one sees at the entrance, especially if the nest is in a bank, the débris which is cast out. The comb once made is used time after time. The wasp lays its eggs, and in eight days the grub is hatched. It thrives until it fills the cell, when it spins a silken covering for the floor, and passes into the second stage, where it remains for about ten days, and emerges as the imago, or fully developed wasp. The cycle is eighteen days, possibly as in the bee; the queen and male will take a little longer.

The queen begins to lay in May and there is a brood in June and July; this year there was one in August and September. The worker's life is not a long one; and Nature, in order to keep up the stock, is able quickly to replace the lost ones. Wasps, like bees, ants and hornets, know each member of their own colony by a distinct smell. If a strange wasp be put into another nest, it will be killed or expelled at once; but if both be smeared with oil of peppermint it will not be recognised.—M. CARRINGTON SMITH, M.D. in *Country Life*.

(Concluded next week.)

## Notices to Correspondents.

W. H. B.—*Queen Cast Out*.—The queen is a fertile one.

J. W. S. (Lancs.)—*Purchasing Honey*.—We are continually advising both sellers and buyers to insist on the use of our deposit system when dealing with advertisers. It is the only means by which persons can be safeguarded against loss, and we provide it at some considerable inconvenience to ourselves. The honey is very good; it has a little from heather in it. We are afraid you have no redress from the railway company; to take action would waste more money than you have lost already.

W. RANDALL (N. Devon).—*Wasps*.—The insects are queen wasps. In response to your request, and as the subject has been much discussed lately, we reprint an interesting article from "Country Life" on the habits of the wasp (see page 459).

GONNE (Wales).—*Bees Dying Outside Hive*.—From your description, we should say that the bees have come out tempted by the sunshine, and have become chilled. Queenlessness would not cause this. Thanks for your kind appreciation of "B.J."

### *Honey Samples.*

ROUND NOB (Staines).—The colour of honey is good, as is also the aroma and flavour. It lacks density, however, and would do to show locally. Worth 10d. per lb. retail.

MULFRA (Penzance).—The honey is mainly from clover, rather thin, but good in

colour and flavour. You could prosecute the man for stealing the sections, and for wilful damage. If you apply to your County Council they will send the expert free.

M. S. (Devon).—The honey is of good quality, mainly from clover, worth about 56s. per cwt., and 10d. retail.

H. S. (Oxford).—We should say the material you send is what is called Honey Substitute, and sold as such.

L. R. (Carmarthenshire).—The honey is from mixed sources, with just a slight trace of heather, which makes it delicious eating. There is no need to try and sell all your honey in one year. When extracted it will keep for several years, so you should ask a fair price, and save what you cannot dispose of until next year, when the honey crop may not be so abundant.

## Special Prepaid Advertisements.

Two Words One Penny, minimum Sixpence.

Orders for three or more consecutive insertions entitle advertisers to one insertion in "The Beekeepers' Record" free of charge.

Trade advertisements of Bees, Honey, Queens, and Bee goods are not admissible at above rate, but will be inserted at 1d. per word as "Business" Announcements, immediately under the Private Advertisements. Advertisements of Hive-manufacturers can only be inserted at a minimum charge of 3s. per ½ in., or 5s. per inch.

## PRIVATE ADVERTISEMENTS.

PLENDID LIGHT CLOVER HONEY, 58s. cwt.; sample, 3d.—ALBERT COE, Apiary, Ridgewell, Halstead, Essex. n 100

APIARY of 11 Strong Stocks, stored for winter, for sale; will sell separately.—LEAD-BEATER, Manor Farm, Shirley, Warwickshire. p 93

12 CWTs. GOOD HONEY FOR SALE, 60s. cwt. 2—Apply. F. H. BUCK, Wimbish, Saffron Walden. p 92

5 CWT. good Medium Honey for sale, granulated, 28lb. tins; sample, 2d.—HAZZARD, Haddenham, Ely. p 91

CLOVER HONEY, 58s. cwt., 28lb. 15s.; tins free; sample, 3d.; Light Beeswax, 1s. 8d. lb.—THOMAS, Coedmelyn Stackpole, Pembroke. p 90

ABOUT 50lb. of Finest Beeswax for sale.—H. COLLIN, Kirtling, Newmarket. p 89

SUPERIOR Pale Lincolnshire Wold Clover Honey, 60lb. tins, 35s.—SMITH, decorator, Caistor.

FOR SALE, several dozens 1lb. jars Light Honey.—Offers to L. W. MATTHEWS, Great Rollright, Oxon. p 86

HONEY, 20lb. Extracted, 10s.; tin free.—G. SHARP, Cuckfield, Suffolk. p 85

WANTED 1st, 2nd, 3rd, 4th, 5th, 12th, 13th, and 16th Editions of "British Bee-keepers' Guide Book."—Particulars and prices to "British Bee Journal," 23, Bedford-street, Strand, London, W.C.

RHODE ISLAND REDS, splendid cockerel, rose combed, 21s.; also single comb, 12s. 6d.; pure white Orpington cockerels, Cooks' noted strain, 6s. 6d., April hatched. Approval.—MISS PALING, The Nest, Partridge Green, Sussex. p 83

10 DOZEN full Clover Sections of Honey, 9s. per dozen; carefully packed.—JOHN IRVING, Armthwaite, Carlisle, Cumberland.

HEATHER HONEY, 9 dozen screw capped jars; also 9 dozen medium coloured Honey; what offers.—HAFOD Hope, Mold. p 81

## Editorial, Notices, &c.

### BRITISH BEE-KEEPERS' ASSOCIATION

The monthly meeting of the Council was held on Thursday, November 16th, 1911, at 23 Bedford Street, Strand, London, W.C., when Mr. T. Bevan presided. There were also present Miss M. Gayton, Messrs. E. Watson, O. R. Frankenstein, J. Smallwood, H. Jonas, E. Walker, A. Richards, and J. B. Lamb (Affiliated Association delegates), G. W. Judge and J. E. Smiles (Crayford), G. R. Alder and T. W. White (Essex), and the Secretary, W. Herrod.

Letters expressing regret at inability to attend were read from Mrs. Chapman, Messrs. T. W. Cowan, C. L. M. Eales, A. G. Pugh, R. T. Andrews, G. Hayes, G. W. Avery, J. N. Kidd, and Captain Sitwell.

The minutes of the Council Meeting held October 5th were read and confirmed.

The following new members were elected: Mrs. E. Bissett, Yew Villa, Broadwater, Worthing; Miss J. Sargeant, Bank Street, Braintree, Essex; Mr. J. T. Studley, Wellington Club, Grosvenor Place, London, S.W.; Mr. D. Wilson, Windmill Lane, Belper; Mr. Wm. McNally, Glenluce, Scotland; Mr. A. Wakerell, 21 Mansfield Road, Croydon.

The report of the Finance Committee was presented by Mr. J. Smallwood. The balance in hand at the end of October was £212 0s. 6d., and it was resolved that payments amounting to £138 16s. 10d. be made.

Mr. D. Wilson, of Belper, presented himself to undergo the lecture test for the first-class certificate, and it was resolved to grant it to him.

The interim report of the Development Grant Committee on the arrangements made for a site for the Experimental Apiary in the gardens of the Zoological Society at Regent's Park was presented. It was considered most satisfactory and was accepted.

It was resolved that to reduce the number of copies of Annual Reports required from Affiliated Associations, the members of the Council forego the copy they are entitled to.

Correspondence was read from the South African Bee-Keepers' Association, *re* conditions and privileges of affiliation, and it was resolved that a Sub-Committee consisting of Messrs. T. W. Cowan, W. F. Reid, A. Richards, and O. R. Frankenstein draw up a report and present it to the Council in due course. Correspondence *re* the "Smallholder"

Foul Brood Bill was read and it was resolved that the same lie on the table.

The next Council Meeting will be held on December 21st.

### BARNET AND DISTRICT B.K.A.

The Barnet and District Bee-keepers' Association held their first show of honey and wax at High Barnet on November 14th and 15th. The various classes were fairly filled, and the quality of the exhibits left little to be desired. Mr. W. Herrod kindly acted as judge. A great deal of interest was aroused in the visitors who thronged the room the whole time the show was open.—G. JAMES FLASHMAN, Hon. Sec.

### REVIEWS OF FOREIGN BEE

#### JOURNALS.

By "Nemo."

*Preserving Combs from Wax Moth.*—M. Buguet, of Rouen, has been making a series of experiments in preserving velvets, silks, woollen goods and furs from the depredations caused by moths, and we read in *L'Abeille de l'Aisne* that he has discovered a valuable remedy which is equally efficacious with wax-moth. M. Denis, who writes about this discovery, says that you simply procure from your chemist some carbon tetrachloride, a small quantity of which is poured into a bowl or saucer. This is placed with the articles to be preserved in a box, cupboard, or other receptacle, taking care that it is hermetically closed. There is nothing more to be done. The vapour given off by the tetrachloride of carbon very soon destroys all insects within its sphere of action. There is no inconvenience and no fear of danger. Tetrachloride of carbon is not inflammable, and it has no noxious effects either on colours or on the material of the most delicate objects exposed to its fumes. It is important not to leave any fissure for the escape of the vapours, and it is recommended not to amuse oneself by smelling it as it acts somewhat like chloroform. Up to the present nothing better has been found, and it is superior to bisulphide of carbon in not being inflammable, therefore it avoids the danger of fire. It is a heavy, volatile and mobile chloroform-like liquid with a pleasant pungent, quince-like odour if pure, and can be purchased for about 3s. 6d. a pound.

*Introducing Queens.*—M. J. Dupont, writing in *L'Abeille et sa Culture*, says that the introduction of a queen into a hive requires great precaution. There are some bee-keepers who are content to allow a queen to run in at the entrance of the hive and take her chance. This is simple enough, but it is a plan which cannot be

recommended, as in most cases the results are not satisfactory, although it may succeed sometimes. In order to be successful in the introduction of a queen, the first thing is to ascertain the exact condition of the colony; for not to make sure that the hive one supposes to be queenless does not contain a defective queen, or even laying workers, is to court defeat. A queen is introduced under two different conditions, first, immediately after the removal of the queen which it is desired to replace, and second, when a colony has been queenless for a greater or shorter length of time.

The operation in the first case will succeed provided certain precautions are taken, and only fails in the rare instance of there being several queens in the hive. This, however, may happen if, for instance, there is an old queen which the bees are keeping after they have reared a young one to replace her; and as only one of the two queens is removed by the bee-keeper who has overlooked the second one, this one will not allow the entrance of a stranger. In the second case, success depends entirely on the condition of the colony. Young bees accept a queen more readily than do old ones, and this is the reason why the introduction becomes more difficult the longer the colony has been queenless. There is a very simple way of finding out if a colony is really queenless. It is by introducing a frame of comb containing eggs and young larvae. As soon as this is done the bees of a queenless colony at once begin to construct queen-cells.

The absence of worker brood and the presence of drone brood indicate that there is either an old drone-breeding queen, an unfertilised one, or laying workers. These last are recognised by the irregularity of the brood, as they usually lay several eggs in some of the cells, and leave others empty. A queen would not be accepted if introduced into such a colony, and it is therefore necessary to renew the population and get rid of these adverse conditions.

*Are Bees Attracted by the Colour of Flowers or the Nectar?*—Dr. Büttel-Reepen discusses this question in *L'Apiculture Nouvelle*. He says that whereas Plateau strongly maintains the theory that bees are principally attracted by nectar and not by colour, Aug. Forel, who was almost alone in advancing the opposite idea, has supported it by conclusions arrived at after several years of experimenting. A few younger investigators have recently associated themselves with him, and are now able to verify his conclusions that it is mainly the colour which attracts bees. Relying on the investigations of Forel, Andreas, Giltay, Detto, and Kienitz-Gerloff, it may be considered as

proven that the bee, *Apis Mellifica*, L., is strongly attracted by the colour of flowers, and not principally by the nectar. The colour of the flower serves as a brilliant sign which indicates from a distance that "Here food is provided." The fact that the foraging bee as a rule does not visit two sorts of flowers, but only one species, sufficiently proves that bees observe flowers very minutely. This is easily seen in examining the pollen baskets of foragers returning to their hive. Only one colour of pollen is noticeable, and Dr. Büttel-Reepen says he has only once seen a mixture.

---

#### HELPFUL HINTS FOR NOVICES.

By W. Herrod.

PROCURING SURPLUS.

(Continued from Page 443.)

It is also an advantage to have a bait comb or two on hand, *i.e.*, according to the number of hives, one or two supers of shallow combs should be kept just as they leave the extractor without being cleaned. These can be distributed amongst the other supers when put on the hives next season.

In working for extracted honey it is imperative that an excluder be used. A great many bee-keepers are averse to its use, but if it is desired to have nice clean combs free from brood and pollen, then the only way is to use the excluder. That it does hinder the work of the bees to some slight extent there is no doubt, but if a "Wilkes" excluder is used this is reduced to a minimum.

Probably one of the difficulties a novice has to contend with is to know just when to put on the super. Many imagine that the work can be done by rule on a certain date, just as they pay their rent on quarter day. Owing to the vagaries of our seasons, and the difference in climatic conditions between north and south in these islands, it is impossible to give any set date. As an instance, I have seen full supers removed in the south, where cherry orchards abound, in the month of May, while in the north very often the first surplus is not obtained until the beginning of July. Then again, we must take into consideration the strength of the colony. I have seen supers put on with only five or six of the brood-combs covered with bees. Until the brood-chamber is full to overflowing, and there is an abundance of forage, it is useless to put on extra chambers. Neither should we go to the other extreme, and wait until the bees are upon the point of swarming, for if once a stock gets the swarming fever it is very difficult to prevent the swarm issuing. The best gauge is to wait until the bees



begin to elongate the first rows of cells next the topbar; this is easily seen as they are very white. When this occurs, put on the super at once, and the bees will take possession of it immediately. I have seen them crowding supers put on under these conditions within an hour. The explanation of the extension of these cells, though rarely understood by the novice, is very simple. Bees when crowded use up all the available space. The usual space between the combs from capping to capping is  $\frac{3}{8}$  in. for brood; this can never be smaller, but between honey cappings a bee space, *i.e.*,  $\frac{1}{4}$  in., will suffice; so when honey is coming in abundantly the bees utilise the extra  $\frac{1}{16}$  in. on each comb for the storage of food. As the food is always stored above the brood-nest we get the cells drawn out in the position indicated.

The bee-keeper should ascertain at what period of the year in his district the flowers from which surplus is obtained come into bloom; he can then bring his bees to full strength at that period by carefully stimulating them.

It is just as harmful to get bees to full strength too early as too late; in the former case only swarming will result, while in the latter no surplus will be obtained.

When once supering has commenced a watchful eye must be kept on the bees so as to keep them fully employed. Even with a super on they may become crowded to such an extent that they will swarm. Room just a little in advance of the bees' requirements should be our motto. When the first super is about two-thirds full it should be raised, and a second one placed underneath, and so with a third or more if the season and district are favourable. Do not put the empty super on top of a full one, or the bees may refuse to take possession of it and swarm instead. The best time to put on the empty super is mid-day when the bees are hard at work. Many will be out in the fields foraging, so the hive will not be too crowded for the novice to carry out the operation. When the bees are working in full swing, draw the entrance slides right out so they may not be impeded in the least in coming out or going into the hive.

If the honey-flow comes on at a time when colonies are not quite up to full strength, surplus can often be obtained by crowding them on to eight or nine frames. In such cases careful nursing will be necessary at the end of the season to get them into proper strength for wintering.

*(To be continued.)*

In dealing with Helpful Hints to Novices I endeavour to touch upon those subjects which I think are most difficult

for the beginner. The thought has struck me that novices may help me by suggesting subjects they would like advice upon. Therefore, I shall be grateful if they will send me their ideas, which shall have my careful consideration.—W. HERROD.

---

## Correspondence.

---

*The Editors do not hold themselves responsible for the opinions expressed by correspondents. No notice will be taken of anonymous communications, and correspondents are requested to write on one side of the paper only and give their real names and addresses, not necessarily for publication, but as a guarantee of good faith. Illustrations should be drawn on separate pieces of paper. We do not undertake to return rejected communications.*

---

### WHAT THE DISEASES OF BEES COMMITTEE IS DOING.

[8295] So many inquiries have been addressed either to the JOURNAL or to members of the committee that I may profitably report progress.

The draft of the Bill which was published in the "B.B.J." of July 14, 1910, met with so much criticism, some of which was helpful and some destructive, that the draft has been considered in the light of such objections and fully revised. Subsequent to the last meeting of the committee in September, copies of the revised draft have been supplied to the members for review. Several further suggestions have thus reached me, and I have tabulated them for the committee's consideration. I hope to be able to publish the completed draft at an early date, when readers generally will have the opportunity of seeing the work done by the committee, and voting upon it. I should not in the ordinary course have dealt with the matter until the labours of the committee were complete, but in view of a counter proposal in the "Smallholder" I feel it is fair to all concerned, and to those who have devoted their time and thought to this matter, to do so now.

Mr. Tickner Edwardes has given us some of the reasons which have induced him to take the course of proposing separate action, but I feel that they are not quite convincing. He is, of course, a free agent, but his action is liable to be construed into opposition to the B.B.K.A. proposals. I say this in consideration of the fact that he made no inquiry of the committee appointed for this special purpose as to the progress

made, although aware that the subject was under their consideration, and bases his reasons upon the draft published in July, 1910, knowing that this was under revision. Now one of the objections raised to a postal ballot has been that bee-keepers were asked to vote in the dark. This objection will be removed in the case of the B.B.K.A. draft. And I make an appeal to readers of the "B.B.J." and such others as they can reach, to withhold their signatures until they peruse the draft of the committee, which it is hoped will meet all reasonable objections, whilst providing an efficient remedy for admitted evils.—L. S. CRAWSHAW, Hon. Secretary, Diseases of Bees Legislation Committee.

#### NOTES BY THE WAY.

[8297] Now that our bees are snugly packed away for the winter months we turn our attention to providing new hives during the long winter evenings if we intend to increase our apiaries. With such good results for the 1911 season no doubt many are wishing their stocks had been more numerous. As it is possible that we may have several successive good bee seasons, such as we have had in the past, if our new recruits intend to share in the spoils they must make ready in advance. One of the first points to consider is the hive in which to house the swarm. For my own use there is no hive like the "Combination," as a home for the bees, for easy manipulation of the brood-combs, also supering for comb-honey. I have seventy frame hives in use in my apiaries and they are very good hives, but for easy handling of the bees the Combination is, in my opinion, far in advance of the square hive with its fully-exposed top-bars. First there is the removal of the dummy, frequently fixed with bee-glue—not an easy job, and unless the dummy is a thick packed one the first comb has to be taken out also before you have room to reach the brood nest; then if the bees are at work there is a general upset of the apiary if you keep the hives open very long and the flying bees get a taste of the exposed comb of honey. If the apiary is in an exposed position and the wind rough, the quilts will be sent in all directions. In manipulating with the Combination hive this is easily avoided; the 11in. sides give good protection for the quilts, the length of the hive enables the examiner to spread his carbolized cloth over the brood-combs. As he removes the quilt the dummy is moved back and the whole of the frames can be made loose before a bee is exposed, then if they are troublesome a little puff of smoke may be blown under the car-

bolized cloth, though this is rarely needed, and the brood-combs can be examined, and each one returned to its previous position most expeditiously; in fact, I have many times examined a stock in five minutes. I may say I rarely use more than two racks of sections on a hive at one time, and my best takes this season have been from Combination hives. Another point in their favour is that the cover though loose need not be hinged to the body of hive, but by inserting two strong screws or nails in the front of your hive body, just below but touching the fillit of the cover when in place, the cover can be turned up on these projecting screws, and held by a piece of cord, thus forming a good screen from the bees at the front of hive. With the W.B.C. type of hive the whole is exposed to the bees in all directions. For extracted honey I should use a W.B.C. or similar pattern, but for comb honey, if starting bee-keeping again with my present experience, I would rather purchase "Combination" hives than start with W.B.C.'s at a gift. I have no wish to start a controversy on this subject, but if any one wishes for more points of its merits or dimensions, I shall be happy to oblige.—W. WOODLEY, Beedon, Newbury.

#### KEEPING THE EXTRACTOR FREE FROM RUST.

[8298] There have been several enquiries lately as to the best way of keeping an extractor free from rust, so I give my method: Warm the extractor and rub over the inside and the cage with a cake of wax, then invert it with the cage inside over a blow-lamp until the wax has melted and spread over the surface, being careful that the flame does not play on the metal. The advantage of a covering of wax is that the extractor is ready for use at any time without having to be first cleaned, and it may be used through the season without cleaning, as the honey does not get in contact with the metal.—W. A. C., Castle Cary.

#### MAKING HIVE-ROOFS SECURE.

[8299] I should like to give "B.B.J." readers my plan of preventing hive-roofs from blowing off. I run a length of wire underneath the hive, bring the two ends to the top, then pull the wire tight, and twist the two ends, leaving each end about four inches long. It is a simple matter to undo them, when required, and there is not the least fear of the roof blowing off if these directions are followed.—H. HOLDEN.

(Correspondence continued on page 466.)

## HOMES OF THE HONEY BEE.

APIARIES OF OUR READERS.

Mr. Haynes' apiary presents a charming picture, combining both beauty and utility. The situation of the hives is an ideal one from the bees' point of view, with its sheltering trees in the rear and an unimpeded flight over the trimly-kept grass plot, to where the most abundant forage can be found. The excellent results recorded by Mr. Haynes show that under capable management bees can be made to pay, even in a "second-rate" honey district. He is to be congratulated on the long immunity from disease his apiary has enjoyed, and we trust that this happy state of things will continue.

has ever troubled me; perhaps strict attention to cleanliness and the free use of disinfectants have done something in keeping the arch fiends at bay. At the time of beginning I was told I should never get any honey. "Well, perhaps not," I said, "but wait and see," and then when I brought it in by the hundred-weight I was told again, "I should never dispose of it all." Suffice it to say I have never had any difficulty in selling all my produce at good prices (wholesale only), because of the attractive way I put it up. I work mainly for section honey; the largest surplus I have ever taken from any one hive being 132lb., and this from a second-rate district is a fairly



MR. C. R. HAYNES' APIARY, HANLEY CASTLE, WORCESTER.

In the notes sent to accompany the picture, Mr. Haynes says:—

At the invitation of the Editors, I have pleasure in offering a few notes on my bee-keeping experiences. I commenced the hobby as far back as the year 1880, through reading a leading article on apiculture in the London "Standard."

My first happy thought was to write to the late Rev. H. R. Peel, who kindly advised me what to do and how to do it, and with the help of the BEE JOURNAL and "Guide Book," I became fairly launched on the road to success. Foul brood has only paid me a visit once during thirty-one years, and then "cleansing fire" banished it. No "Isle of Wight" disease

good return. Of course, it goes without saying that I have had some novel experiences with bees, one of which was a swarm hived in the usual way, which after a brief stay decamped and entered a hole high up in an elm tree. After a little cogitation as to the best way to circumvent it, I induced my gardener to erect a thirty-rung ladder and go up "armoured" with a bottle of carbolic solution and sprinkle some of the contents in and about the place of entry. In less than an hour the truants came forth and settled low down on a bush, and I had no further difficulty with them. I could go on relating my experiences connected with my bees and their erratic doings, but

fear to trespass further on the valuable space at the disposal of the Editors of the B.B.J. After trying a number of foreign races I have come to the conclusion that the English bee for utility purposes is far and away the most desirable kind to keep.

(Correspondence, continued from p. 464.)

#### TALES I HAVE READ.

[8300] From the easy-flowing pen of your correspondent, D. M. McDonald, instruction and amusement flow simultaneously. I know not in which he excels, but this I do know, that BEE JOURNAL readers owe him a heavy debt of gratitude for time and trouble so lavishly bestowed on research into the history of bee-craft, how our knowledge has accrued, and when, and where. And yet only lightly has he touched its surface. Often on a summer evening have I watched swallows playing over the tranquil waters of a deep lake. Anon, one in rapid flight will breast the reflecting mirror, and with a shiver of its wings, speed swiftly away, leaving behind rippling circles, ever widening to the shore. But these undulations, sparkling, and tinted by the westerling sun, conceal profundities below, where caught up in the lap of the mountains Nature has garnered her wealth of waters. In similar manner, like the floods pent up in a Highland loch, is the accumulated history of our craft. It is written in the Assyrian cuneiform, in the Hebrew letters, once traced by the awful finger of Jehovah on tables of stone, in the sonorous sound simulating characters of Homer, in the liquid cadence of Virgil's Latin verse. In Saxon, in Norman, in English, in every language has the pean of the nectar-gatherer been sung—she, an ever ready object-lesson to illustrate industry, organisation, and obedience to established authority. And the volume is so great, that the few who have written of its treasures are but as swimmers breasting the floods. No diver yet has plunged into its very depths, nor has mariner yet with master mind dredged to its bottom that he might tabulate its treasures for the benefit of less gifted brethren. Presumptuous am I, therefore, that I may interest and amuse in essaying a few random casts thrown here and there.

Whenever reading, should I happen on anything touching on my madness, I jot it down, or, as Captain Cuttle advises, "When found, make a note of." Lately I was reading Herodotus (we had been discussing Babylonian wars), and right in my way came some very amusing conceits, some sidelights on bees, and on honey—real and unreal—which quite took

my breath away, and made me feel how much I had still to learn of what bees can do, when evil disposed, and how their main production can be *done*, but I will quote his own words as follows:

"Now the Thracians say that the other side of Ister is occupied by bees, and by reason of them it is not possible to proceed further."

Thank Heaven, the bees in our days are better mannered. But they had an awful bad character in those very old times, if but half of what is written about them is true. Just imagine, bees stopping the advance of a victorious army! And there is some corroborative evidence from another writer; I believe it is Thucydides (I cannot at the moment verify the quotation), who speaks also of them staying an army of the Greeks. Again, in Deuteronomy it is written, "The Ammonites chased you as bees." We could have believed very much that is wicked of the Cyprians, or the Syrians, it never took much to rouse their anger, but here, close to the Danube, the bees should be much more gentle. My heart sank, but I dared to read the next sentence, and it rose again, for I found that the historian *did not believe the tale himself*. He proceeds: "But to me it seems, that when they so speak, they say that which is not probable" (what a delicate way of calling it a lie), "for these creatures are known to be intolerant of cold, and to me it seems, that the regions which go up towards the North are uninhabitable because of the cold climate." For those days, Herodotus was a great traveller and explorer, as also an historian, but unfortunately he had a very loose way of accepting any tale that was told him without investigating the truth of it, and for this he was satirized by Juvenal and others. But it would appear that he could not quite swallow this "on dit" of the Thracians. He tells one or two other "historical facts" with more appearance of credulity, and with the Editors' permission I will relate them another week.—J. SMALLWOOD.

#### THE HUMBLE BEE.

[8301] The late Charles Darwin, writing on the subject of Natural Selection, makes the following interesting observations on the habits of the humble bee:—

"It has been noticed that there are a great many more humble bees in the neighbourhood of towns than out in the open country; and the explanation of the matter is this: the humble bees build nests, in which they store their honey and deposit the larvæ and eggs. The field mice are amazingly fond of the honey

and larvæ; therefore, wherever there are plenty of field mice, as in the country, the humble bees are kept down; but in the neighbourhood of towns, the number of cats which prowl about the fields eat up the field mice, and, of course, the more mice they eat up the less there are to prey upon the larvæ of the bees—the cats are therefore *indirect helpers* of the bees."

To this paragraph the late Professor Huxley added: "Coming back a step farther, we may say that the old maids are also indirect friends of the humble bees and indirect enemies of the field mice as they keep the cats which eat up the latter."—F. DE SILVA, Bath.

#### LATE BROOD REARING.

[8302] A short time ago I was asked to remove some bees from the wall of an old plaster bungalow. I went on Thursday, November 9th. After a night of rain the sun shone out and the morning became quite warm by eleven o'clock. The first thing that met my eye was a sting, but after removing some of the plaster and lath, I saw a good large patch of healthy brood. Some of the young bees were just eating their way out. The colony was a vagrant swarm of this year, and the combs were the whitest I have ever seen. Though a very strong stock, I got them out quite safely, and also took about 15lb. of very fine honey, almost water white, but in first-rate condition and of good flavour. This is the latest brood I have ever seen or heard of. I caught the queen, placed her in a match-box, and put the box in my hat to keep her warm. I ran her in without trouble on arrival home, and the bees have made themselves quite comfortable in my garden. The bees in one of my strongest stocks are still turning out one or two drones on fine, warm days; this also is late for this part. There has been a field of mustard in full bloom near me, and I think that accounts for the late brood and late drones. Can you give me a description of the weed called ragwort.—C. REED, Third-Class Expert.

[Ragwort (*S. Jacobaa*) is a very common weed in Britain, and unfortunately the flavour it imparts to honey is rank and unpleasant. It grows some two to three feet high, flowers in summer, and the flower-heads are a bright yellow. The leaves are covered with a loose woolly down, especially on the underside.—ED.]

#### A GOOD REPORT.

[8303] I have been reading the reports in "B.B.J." of the honey harvest in

different counties, and think that the following may be of interest to your readers.

Having kept bees in North Wales for three years, I removed to this district during the second week in May, and brought one strong stock of bees with me headed by one of Simmins' queens (two years old). About three weeks after arrival I made an artificial swarm which I allowed to breed their own queen, giving them one frame of eggs and one of brood.

From this stock and swarm I have taken 210lb. of honey, of which I have since used about 10lb. of uncapped for feeding. So that since the middle of May I have obtained 200lb. of honey and a swarm from one stock. A sample of the honey was sent to the Editors, who reported it to be of excellent colour, flavour, and density.

I do not know how others in this district have fared, but from enquiries I have made most of the stocks had previously been wiped out by "Isle of Wight" disease. And I am afraid with the too frequent result that the old infected hives and frames have been left open to all bee visitors, because early in October I found both my hives showing indications of this disease. I immediately commenced treating them with the "B. Well" cure, apparently with success, for paralysis has been decreasing and breeding increasing, until on Nov. 11th the bees were out in large numbers, and did not show any signs of the disease. I am using both the quilt and dummy board, so hope that both stocks will survive the winter and come out strong and free from disease next spring.—H. WILLOUGHBY LANCE, Pinner.

#### CAPPINGS OF COMB.

BY L. S. CRAWSHAW, NORTON, MALTON, YORKS.

*Bee Escapes* (p. 384).—I wonder whether J.B.C. put that escape the right way up. Presumably he did, as the bees had an alternative exit and yet remained. Clearly they were both warm and comfortable, and in touch with the brood-chamber. Possibly the escape allowed passage each way. The removal of all but one light quilt or the insertion of an empty super might have made a difference. The editorial note upon this letter suggests the idea that, as escapes have not been used for several years, the bees may have forgotten how to use them!

*Driven Bees* (p. 385).—This is a helpful hint. It troubles me not a little to leave a number of these fledglings aimlessly crawling amongst the combs. One tender-hearted driver, kindly desirous, determined to drive to the bitter end. But the queen having been extra prolific, he was kept busy coaxing up to their fellows a continuous stream of hatching bees. It

was hot weather, and the swarm started housekeeping above. The first larva was just hatching when he gave the final exhausted pat to the bottom skep.

*A Bee Story* (p. 386).—My apologies are here tendered to Mrs. Byles for appearing to scoff at her account. In extenuation of my crime, I can only say that I had no idea from the signature that the writer was a lady. And by way of humble penance I will confess that I did not doubt the story, although foolish enough to make light of it. But then I thought it was a mere man! So I trust my fair critic will be appeased, and find this *amende* as soothing as Coult's acetic acid.

*Isle of Wight Disease* (p. 395).—If warm moisture be the essential of cure, how comes it that the disease spread in damp summers and diminished in a dry hot season? Given a strong stock, would it not be fair to describe the hive interior as hot and moist whatever the outside summer conditions?

*Secondhand Propolis* (p. 396).—In reply to Mr. Price's query, I may say that I have often observed bees collecting old or used propolis. I did not think to make notes at the time, but I am under the impression that it was usually during a dearth of honey. I noticed that the bees packed the propolis whilst standing, although they pack pollen whilst on the wing, leaving the flower temporarily for the purpose. The phenomenon may be easily observed by placing propolised quilts in a sunny corner. The bees do not, however, make a clean job of the work, or this might be the easiest way of getting separators cleaned.

*Honey by Rail* (p. 396).—C.W. seems to answer most of his queries. Clearly the porters act in the railway companies' interest if they take extra care of goods consigned at company's risk. The consignee pays for such extra care. In this world interest is more generally powerful than altruistic teaching. Anyhow it is too much to expect of a porter that he should read the word "Fragile" written upon a parcel. Proper labels should be used and plenty of them.

*Where Do Truant Swarms Go?* (p. 406). Is the reply, into ferret hutehes? First ferret them out, and then out-ferret them? That a ferret would be no use for hunting bees is made clear by this narrative of a ferret tragic affair. The owner of these bees must be possessed of both patience and perseverance, in that he three times tried to hive 10lb. of bees in a skep. Was it not expecting too much of some 40,000 bees that they should adopt such quarters in such a summer? It was at least an emphatic protest on their part to leave one of the Best apiaries for a not over-clean box.

*Painting Queens* (p. 406).—As one who took part in the discussion, I am grieved to find Mr. Swabey an apostate. But his new arguments do not carry conviction. What is more easy than to paint fertile queens before introduction? Then no extra time would be used in their discovery. On his own showing they must be hunted up for supersedure, and the one operation would cancel the time of the other. The pleasure of finding at a glance, and the certainty of age, using colour for year, surely compensates for "time, temper and paint." In any case, a bee-keeper should have plenty of the first, and none of the second. As for paint, a little goes a long way, especially if the bees abscond. It would not be easy to block the spiracles, but anyone so inept as to be likely to do this would never attempt to paint his queens.

---

## Queries and Replies.

---

[8254] *Feeding in Spring*.—Will you please answer the following questions in the BRITISH BEE JOURNAL and oblige? (1) What would be the proper time in April to commence feeding bees in South Devon with candy? I notice you say about the middle of April. Seeing that the fruit blossom and flowers are about four weeks earlier here than in the Midlands, would earlier feeding be beneficial? (2) I have a piece of ground I intend planting with clover next season. Which kind is best to sow—White Dutch or Giant White Clover? (3) What is the proper time to set the Chapman honey plant seed? (4) Will the bees gather from the ordinary mustard seed?—"FRUIT," Paignton.

REPLY.—(1) Candy is given only in the winter months. Syrup should be given in April. You can commence in the first week in March, if the weather is warm, as you say you are a month earlier than other parts. (2) Sow White Dutch clover. (3) Sow in the spring of one year, and plant out in the autumn for the next season. (4) Yes.

---

### THE COMMON WASP.

(Continued from page 460.)

A nest may be located as follows: (1) Watch a wasp on an old wooden post; it will be making paper for the comb. Follow it when it leaves, and the nest will be found near at hand. (2) Watch a wasp feed; when filled it will fly in almost a straight line to its nest. (3) Bait a place with a strong-smelling bait,

such as putrid meat; soon a crowd of wasps will be at it; and follow single ones or more, and you will soon find the nest. (Note that a wasp when it knows of a feeding-place will fly from the nest in a direct line to the food.)

Wasps are guided to their food, not by vision, but by their powerful sense of smell. This can be proved by placing some putrid meat or highly-scented food at the inner side of a keyhole. Given wasps, before long one will see a wasp creeping through the hole to the inner side of the door, and feeding on a well-earned meal; once one has found the food, others out of the same nest will follow at once, guided by the smell of the wasp, not by any signalling or way showing.

Wasps are deaf, but the sense of feeling is developed highly, compensating for the deafness; the least vibration sets a whole nest buzzing. Much doubt has been shown about the manner in which the queens are fertilised. The author, by good fortune and patience, saw this take place on August 26th. The queen was at the entrance of her home; a young queen, known by her bright and new clothing. She appeared dazed, as if by the bright light, when suddenly she was seized, I thought at first it was a fight, by a large wasp, a male, who carried her off on their honeymoon *in coitu*. They flew as one wasp to a great height, and were lost to vision. Wonderful Nature comes in here; the male wasp was evidently from another nest (this stops inbreeding) and guided by that instinct followed a queen to her home, seized her and carried her off. This is a common custom among some of the savage tribes. This was very early for queens to take their flight, and from this one can believe that this summer young queens have made homes for themselves and caused the pest of wasps.

What use has Nature for wasps? Wasps, when in reasonable numbers, are beneficial to man, plants and fruit. They acts as scavengers, eating up or carrying away putrid organic matter; they also kill thousands of flies, blue-bottles, blow-flies, grubs and small snails. The author, some years ago, called attention to the danger of house-flies, disease and germ carriers. Infection and infectious diseases would soon die out if the common, house-flies were extinct. Wasps destroy these in thousands, also their gentles (grubs). The author exposed hundreds of gentles; these were carried off in a few minutes after the first was found. This year, to prove the beneficial use of wasps owing

to their numbers, there never were less insect life, caterpillars, green flies, maggots and small snails in the gardens. The wasps have eaten or carried them off; so much so, that they have had to find, owing to their numbers, other food, as fruits, meat, game and anything which came their way. The next year's growth of plants and other shrubs which, in ordinary seasons, would have been eaten up by insect life, will benefit to a remarkable degree.

Wasps are not the only fruit-eaters: the fruit is broken oftener by birds and then seized upon by the large flies, when the wasps come on the scene and eat the flies and fruit, carrying off both. It is amusing to see a wasp in a state of intoxication. Expose an apple or plum which has been well broken into and just beginning to decompose: keep this in a position to hold a little water, *i.e.*, fill the eaten part with water and keep it all night in a room to allow fermentation, expose this the next day, when wasps, by the scent, will soon be on the spot; the fluid will be taken at once, when the wasps will be drunk indeed. An interesting experiment, which may be made without danger, is to place some weevils or maggots in the palm of the hand and expose the hand in the vicinity of a nest or in the wasps' track; soon their attention will be drawn to these grubs; the wasp will seize one by the junction of the head and body, pierce it—it is dead instantly—and carry off the body in its jaws.

Wasps do not attack a person except in self-defence, either of their body or home. One can train them to visit a given spot and feed them. The sting of a wasp affects a person in several ways. (1) The wasp's sting leaves in the puncture a little of its poison (formic acid). (2) If it is disturbed or rubbed off the part, it may leave the sting along with its injection. (3) It may puncture the skin and leave no injection (the latter is the most harmless). (4) It may puncture the skin and leave in the wound germs of serious troubles, *viz.*, streptococci, resulting in dangerous septic poisoning.

Stings of the mouth, tongue, larynx and palate are dangerous owing to the rapid swelling of these parts. A septic sting, *i.e.*, a sting which conveyed septic germs, on the face is very dangerous; fortunately the wasp is a clean person, if dirty in its taste. The best remedy for a sting is ammonia applied to the parts, or a raw onion; the latter will act almost like magic if it can be well pressed on to the part. The action of the onion is due to the powerful oil which volatilises from the cut surface. Kind Nature has her use for all living things.—M. CARRINGTON SYKES, M.D., in *Country Life*.

## WEATHER REPORT

BARNWOOD, GLOUCESTER.

October, 1911.

Rainfall, 1.95 in. in 16 days.	Coldest night, 23, 28th.
Below average, 74 in.	Mean temperature, for month, 49; 1.5 in. below average.
Heaviest fall, .32 in. on 21st.	Relative humidity or percentage of moisture in the air, at 9 a.m. 84.
Total to date, 13.14 as compared with 24.59 in. for the corresponding period of last year.	Number of days with sky completely overcast at 9 a.m., 15; ditto cloudless, 1.
Mean maximum temperature, 56.6; .6 of a degree above average.	Percentage of cloud, 69.
Warmest day, 63.7, 19th.	Percentage of wind force, 24.
Mean minimum temperature, 41.4, 3.6 below average.	Prevailing direction N.E.

F. H. Fowler (F. R. Met. Soc.).

## IMPORTANT NOTICE.

Owing to the increased work of our staff in other directions, and also on account of so many subscriptions remaining unpaid, we are unable to undertake the extra work and expense involved in sending out bills for small accounts, or yet bear the loss of these unpaid sums. We therefore respectfully notify our subscribers that on and after January 1st, 1912, the "Journal" can on no account be sent unless the subscription is prepaid.

## Notices to Correspondents.

Letters or queries asking for addresses of manufacturers or correspondents, or where appliances can be purchased, or replies giving such information, can only be inserted as advertisements. The space devoted to letters, queries, and replies is meant for the general good of bee-keepers, and not for advertisements. We wish our correspondents to bear in mind that, as it is necessary for us to go to press in advance of the date of issue, queries cannot always be replied to in the issue immediately following the receipt of their communications.

C. R. J. (Hants).—*Dividing a Swarmed Stock*.—We cannot recommend the plan; it is very questionable if you would attain the desired end. When the colony has swarmed make a small nucleus with a good queen-cell on the comb. Introduce the Carniolan to the parent colony. When the queen in the nucleus has emerged, been fertilised, and commenced laying, she can be taken and introduced to any colony desired. The nucleus can then be united again to the parent colony. In this way no time will be lost.

R. J. M. (Somerset).—*Transferring Bees*.—The plan you propose would not work. Follow the instructions given in "Guide Book," page 149.

*Honey Samples.*

SISTER REBECCA.—The "peculiar flavour" you mention is from the chestnut.

J. T. W. (Hants).—It is a very good heather honey, and should sell at 1s. 6d. per section retail.

*Suspected Disease.*

R. S. P. (Oxford), and J. D. (Gainsborough).—We are afraid, judging from external symptoms, that the bees are affected with "Isle of Wight" disease. Send some bees (alive if possible) to Dr. Malden, Medical Schools, Cambridge, in order to confirm our suspicions (or otherwise).

## Special Prepaid Advertisements.

Two Words One Penny, minimum Sixpence. Orders for three or more consecutive insertions entitle advertisers to one insertion in "The Beekeepers' Record" free of charge.

Trade advertisements of Bees, Honey, Queens, and Bee goods are not admissible at above rate, but will be inserted at 1d. per word as "Business" Announcements, immediately under the Private Advertisements. Advertisements of Hive-manufacturers can only be inserted at a minimum charge of 5s. per ½ in., or 5s. per inch.

## PRIVATE ADVERTISEMENTS.

WANTED, good Cowan Extractor, Bees and Appliances; will exchange black Pomeranian puppy, 10 weeks old, or would sell 2 guineas.—ROKER, 8 High-street, Bloomsbury. r 7

HOLLYHOCK, improved double pink, marvelous size, seeds 100 6d., 250 1s.—HOCKLEY, Long Grove, Epsom. p 94

ABOUT 4 doz. ½ lb. jars Heather Blend Honey, 4s. doz.; sample jar 6d.—W. WOODS, Normandy, Guildford. r 6

WANTED, HONEY in bottles and bulk.—THOS. WILCOX, Rosedale, Talywain, Mon. r 5

24 GOOD SECTIONS, at 9s. per dozen, on rail.—H. DOBELL, Marden, Kent. r 4

HONEY, in glazed Sections, required, quote price.—GREEN, 4 Goldspink-lane, Newcastle-on-Tyne. r 3

280 LBS. HONEY, good flavour and colour, 6d. lb.—J. LEE, Cambridge-road, Dunton.

YORKSHIRE HEATHER HONEY, 14lb. and 28lb. tins; sample and quotations, 4d.—JAS. B. MARSHALL, Garforth, near Leeds. r 1

WANTED, one or two secondhand W.B.C. Hives, good condition.—FIELD, Baildon, near Shipley. p 100

EXCELLENT EXTRACTED HONEY, quantity 15st. at 55s. per cwt.; sample 2d.—CHARLES DAVY, Loddon, Norwich. p 99

3 DOZ. good, clean Sections; also about ½ cwt. 3 medium colour mixed Honey for sale.—C. F. STORY, Braceboro' Spa, Stamford. p 98

2 STOCKS OF BEES, in W.B.C. Hives, made very strong, calico tops, in excellent condition, guaranteed healthy, sufficient food for winter, with two drawn out shallow crates with each, 42s. each, free on rail; surplus stock reason for sale.—C. J. ELLETT, The Gardens, Chicksands Priory, Shefford, Beds. p 97



## Editorial, Notices, &c.

### REVIEWS.

*The South African Bee-keepers' Journal* (published in Johannesburg, monthly, price 6d.).—We have received the first number of this journal, and we congratulate the South African Bee-keepers' Association for its enterprise in venturing to publish a paper of its own, as this step marks another stage in the history and progress of South African bee-keeping. The starting of such a paper is no easy task, but the Association has boldly launched forth, and with the assistance of so many willing helpers there is every prospect of its attaining the object intended, and that it will bring bee-keepers in touch with one another. Among the names of the writers we find several who have been for many years able contributors to our columns, and, with Mr. G. S. Oettlé as editor, there is no reason why the undertaking should not be a success; but this can only be assured by every member of the S.A.B.K.A. giving it loyal support. The editor has our heartiest good wishes, and we shall watch with interest the development of bee-keeping in South Africa, more especially as now there is, by affiliation with the British Bee-keepers' Association, a bond of union between the bee-keepers in the Colony and those of the Mother Country.

*Neighbourhood*, by Tickner Edwardes (London: Messrs. Methuen, price 6s.).—Mr. Edwardes is known to bee-keepers as the author of that brightly-written book, "The Lore of the Honey Bee." He is a graphic writer who, with a keen eye for the picturesque and as a lover of country life from childhood, in the volume before us describes the scenes and people amongst whom he has lived for more than twenty years. He writes as a villager, and tells us that life in an English village derives its charm from "neighbourhood," the daily interchange of thought and word and kindly deed, as well as from intimacy with wild Nature and all her wonders and beauties. Of course, bees form part of village life, and Mr. Edwardes devotes a chapter to these and introduces us to an old cobbler "ringing" his bees, and relates all that he saw until the swarm was safely hived in a skep. There are several chapters devoted to every month of the year, so that we get a glimpse of country life at all seasons. The book is well illustrated, and the stories should be read by every lover of the country.

### HITCHIN AND DISTRICT B.K.A.

A meeting of the Hitchin and District Bee-keepers' Association was held at the Workman's Hall on the 13th November. Mr. James Allbon was in the chair, and there was a good attendance. The speaker was Mrs. Douglas Wilson, who gave a very interesting and instructive lecture on the "Romance of the Beehive." Interest in the subject was considerably enhanced by lantern views, manipulated by Mr. P. C. Russell. At the conclusion of the lecture a hearty vote of thanks was accorded the lecturer. The Chairman then presented two silver medals to Mr. A. Prince, of Letchworth, one for the best six sections of comb honey and one for the best six jars of run honey in the classes open to members of the Association at the Chrysanthemum Society's show at Hitchin. The lecture was the first of a series to be held under the auspices of the Association. At the subsequent three monthly meetings Mr. W. Herrod, F.H.S., lecturer, expert and secretary of the British Bee-keepers' Association, will be the speaker. The public are admitted free.—J. COOPER, Hon. Sec.

## Correspondence.

*The Editors do not hold themselves responsible for the opinions expressed by correspondents. No notice will be taken of anonymous communications, and correspondents are requested to write on one side of the paper only and give their real names and addresses, not necessarily for publication, but as a guarantee of good faith. Illustrations should be drawn on separate pieces of paper. We do not undertake to return rejected communications.*

### SUGAR-FEEDING AND DISEASE.

[8304] I shall be glad if you will kindly give me space in your valuable paper, the *BRITISH BEE JOURNAL*, to write a few lines in reference to some remarks made by Mr. L. S. Crawshaw, in his "Cappings of Comb," on page 437, "B.B.J.," Nov. 2, *re* "Sugar-feeding and Disease." He here refers to a letter written by me on this subject. May I say that I am not of the opinion that the ease would stand where stocks were closely related in the same apiary, but I do not think that this affects what I said, as I believe that in the majority of modern apiaries a great many of the bees are not related to one another in any way. Of course, where the bee-keeper rears his own queens systematically each year, the bees would be almost, if not all, of one breed,

but men who do this are in a small minority. The case I referred to was that of a frame from a bought stock being given to a weak colony of my own wintering.

As to the "test" which Mr. Crawshaw suggests, in my opinion he misses the point altogether. To introduce a diseased frame to a clean stock would almost inevitably cause that stock to become badly affected, because although the bees, through being in a state of great vitality, may be able to resist a small quantity of germs, if a diseased comb was introduced with its thousands of millions of active bacilli, they would no longer be able to do so, and would succumb to the disease. It is possible, on the other hand, that the diseased comb might become purified without injury to the stock, but it is unlikely, and the process would not constitute a test of the case.

If bees can be induced to clean out diseased cells, a cure is effected much quicker than otherwise, and a diseased colony has been known to have been cured by exchanging places with a *strong*, clean stock. The bees from the clean stock being in a high state of vitality, and, of course, gathering honey at the same time, soon clear out the diseased cells. The bees from diseased hives do not, as I have found, carry the disease *if the hive is moved in the middle of a hot day, when honey is coming in, without shaking or disturbance to cause the bees to fill themselves with the honey from the diseased hive*. I have found that a good race of Italians are much easier to cure than natives, as they clean out the foul cells much more readily. It is not the *health* of bees I referred to, but their general vigour for work and action. All bee-keepers must have noticed the great difference there is in bees in this way. I do not think that a few individual bees, being weakly, would affect the matter as Mr. Crawshaw appears to think. I believe it is the right way to judge the natural vigour of bees from the "commercial standpoint."—R. B. MANLEY.

#### MAKING A MARKET FOR HONEY.

[8305] The attached cutting was taken from the issue of November 17th of the "Leamington Spa Courier," and I, thinking it worthy of publication in your JOURNAL, am sending it with that in view.

##### WASPS KILL SIX STURDY ELM TREES.

"For several weeks during the latter part of the hot summer we have experienced, a number of elm trees, measuring 4ft. in circumference, have been infested from top to bottom with wasps. The sight may have been interesting to passers-by, but the colonisation was to the detriment

of the trees, which, owing to the sap being taken out by the wasps, have died. The Rev. Canon Sitwell, of Leamington Hastings, the owner of the land, has had the trees felled."

I would like to remark on my success in the disposal of honey. As a beginner I had to devise some way of getting a market. One old friend said to me, "Ah, you'll find 'tis easy enough to *give* it away; but you'll never sell it!" This caused me to think round the matter, resulting in my getting a somewhat costly card printed with a specially made embossed die. These I sent out in a first-class envelope, and the result has exceeded expectations. All sales have been carefully filed, and these records will be dealt with another year. Of course *you* will quite see that future prints of the cards will cost much less than the first hundred.—T. J. K., Leamington.

#### TALES I HAVE READ.

(Continued from page 466.)

[8306] Was it in a nursery tale book, or was it on a hoarding as an advertisement for somebody's incubator, that I saw an old hen "in doleful dumps," head a-side-ways, cackling out (while regarding the, to her, hateful invention) the following lamentation:—

"Hatching chickens by machine!

Well, indeed, I call *that* mean.

But I suppose we soon shall see Eggs laid by machinery."

Irresistibly, the next references of Herodotus reminded me of the excusable fear the poor barn-door matron had that her natural products would be dispensed with by the aid of science and invention combined. And they read thus:—

"Next to the Zauckes (Libyans) are the Gyzantes, among whom honey is made in great quantities by the bees, but in much greater quantities still it is said to be made by men, who work in it as a trade." And again, he writes:—"Xerxes passed from Phrygia into Lydia, then crossed the Manda, and passed by the city Callatebos, where men live whose trade it is to make honey of the tamarisk tree and of wheat flour."

Impossible! quite impossible! That these "Barbarians" should be 3000 years in advance of us. Three thousand years in advance of "civilisation." Yankee notions, "and wooden nutmegs." It was unthinkable. And whatever did they need to make honey for? Here was a country where "honey is made in great quantities by the bees," in a neighbouring country the bees were so numerous that a victorious army was unable to proceed, and yet it was made "in much greater quantities" by men themselves—

and as a trade, too. Evidently there must have been considerable money invested in appliances, however rude they might have been. Where was the market? Who ate it all? How was it consumed? I grew excited. I felt myself on the brink of resuscitating a great industry that had lapsed. What a benefit I should confer on my brother bee-keepers. And, of course (this was to be a secret), what a lot of money I should make.

Why do people devise vain things? Why do they build castles in the air? Why live in a fool's paradise? My dream was cut very short. I had but to proceed a few chapters further, when I read: "The Babylonians bury their dead in honey."

The bubble was burst! Here was the demand—never failing, never satisfied and the supply was in no way equal to it. Further, to the general death rate—by no means low—they had such nice ways of increasing it in those days by decapitating a few thousand captives at a time, as testify the inscriptions which have come down to us. Shades of the mighty! Was this the end of all your glory, the reward of all your valour, to die and to be *candied*. For my own part, if I might have been permitted to choose, I think I should have preferred the bitumen and cloth wrapping mode of sepulture, as in fashion with their neighbours the Egyptians. It had, at any rate, the merit of allowing the artists of those days to depict in vivid tints on the outer coverings some slight representation of what the "dear departed" had been like.

Presuming for a moment that this tale is true, or, at any rate, that there was some foundation for it, the thought naturally occurs: To what extent did the ancients know the preservative action of sugar, and its affinities? What a great pity it is that some of the great "jam-smashers" of those days did not stow away in some corner of the Pyramids, or in the tomb of a mummy, a sample of their manufactures. Or, better still, if one "of the men whose trade it is to make honey" had left behind one of their long-necked jars filled with his confection. It would have been so interesting to analyse it. The efforts to preserve the *corpus vile* by the "candying" process do not seem to have stood the test of time so well as the "pitching" process. Therefore we are unable to comment on the finished article. Even here the almost universal custom seems to have prevailed. It was considered necessary that the warrior should be buried in marching order, weapons, clothing, food, and even money to pay his entrance fees on the other side of "Styx," or its equivalent river. If

only from one of these tombs we could disgorge a pot of honey, what a price we would pay for it in the suggested museum of the B.B.K.A.—JNO. SMALLWOOD.

#### BEE NOTES FROM DERBYSHIRE.

[8307] A few lines on the honey crop in this part of the country for this most glorious summer just ended may be interesting to BEE JOURNAL readers. To commence with, we had five weeks of the very worst bee weather imaginable, cold north-east winds that seemed to blow the bees down in an eddy at the house-end quite close to their hives. Before they could recover from the ill-effects of it white clover burst into bloom by the 1st of June. At that time my best stock only had brood on nine frames, while many others only had brood on five or six, so I united ten stocks, making five, and took them one night to the clover fields, six miles away. It was a lovely night, the temperature seeming about 70deg.; there were four cuckoos singing near as I lay out in the open all night. Would this unusual time for singing in May and June indicate the dry, hot summer we were to have? It almost looks like it, for I never knew the cuckoo to sing all night before, though having to be out every night during this summer from eleven till two I heard it many times. Well, I got my bees fixed up in the clover field and how they did work those first three weeks in June. The honey gathered during that time has scarcely shown signs of candying yet, while honey gathered after the Coronation is quite solid now. Running these out-apiaries is all very well till the bees swarm, when the disadvantages are manifest, but I was very lucky; although I had three swarms I managed to secure them all. I mostly take a spare hive on such occasions, and one swarm most obligingly hived itself on a certain Wednesday after I had left. On the following Friday (July 7th) I felt sure the bees would swarm, so instead of going to work I went to the apiary, reaching it about 4 p.m. Sure enough three swarms had come off since I was there last. Two of them hung in the largest cluster of bees I have ever seen; it was about a yard long, and one foot thick. The weight had pulled the hedge down till the swarm rested on the ground not four yards from the hives; there would be at least 14lb. or 15lb. of bees. I carried the spare hive with the other swarm in it close up to the cluster, and after taking the queen out, a young one just returned from her mating flight, I put the whole lot together. I gave them two racks of partly-filled sections, and an

empty rack. They went to work with a will; at a rough guess there were 20lb. of bees put into that hive (the first swarm had partly filled the six frames that were in it). Although the best of the clover was cut and dry—hot weather was burning it up—they completed over fifty sections. What they would have done had the conditions been better can best be conjectured, but in a month's time that hive was no stronger than any of the others. I took 170lb. of clover honey from the five hives. The remaining five hives I kept at home gathered only 35lb., though I never saw so much clover in this valley before. I have not heard of anyone taking more than 10lb. or 15lb. per hive just round here. I had six swarms altogether; I never had so many before. The heather season also seemed amazingly short; I don't think it lasted a week, for it was half over before any honey came into it. It only rained on four days in the six weeks the bees were at the heather, and they did not get any more honey than they did in the first year I took them to the moor, when we had only six fine days during the whole time they were there. I then got 20lb. from two hives, and I have only taken about 60lb. from six this year. Out of eighty sections put on four hives, there were only about two dozen anything like filled. It was enough to make one resolve never to go near the moors again. I wonder how it is the heather honey has never been that deep maroon colour since the year it was gathered early in September.—Tom SLEIGHT, Danesmoor.

## RECOLLECTIONS OF AN OLD HAND.

*By James A. Abbott.*

Under the above title we are promised some reminiscences by Mr. J. A. Abbott, eldest son of the late Mr. C. W. Abbott, founder of the *BRITISH BEE JOURNAL*. Mr. J. A. Abbott was well known to all those who took a prominent part in bee-keeping about forty years ago, being his father's chief assistant. He caused amazement among the spectators by his cool handling of the bees without veil, gloves, or smoker at the first Crystal Palace Show. He was also a keen photographer, and some of his work, done at a time when the bee-keeping hobby was not so common a feature at shows as it is now, will be seen with interest by amateur photographers of the present day. He was best known as "Jim," that being the way his father always spoke to him, and a name he still answers to. Mr. Abbott says:—

I make no apology for intruding again into the bee world. For some twenty-five years I have resided in Ireland, and have

lost touch with nearly all who knew me in the old days, our editor, Mr. T. W. Cowan, being the only one I can remember of the original members of the Association, though there may be others still connected with the industry.

*Price of Honey.*—In those days, comb honey was thought much more of than now. I well remember my father selling a glass super with about 40lb. of honey-comb in it at 2s. 6d. per lb. to the president of an officers' mess. I also remember a large exhibit of heather honey at one of the earliest bee shows being bought by Messrs. Fortman and Mason, of Piccadilly, at 2s. 6d. per lb. for the lot (several hundredweight), and it was at once put in their window marked 3s. 6d. per lb. What a time some of us would have if we could get these prices now. We also sold our entire stock of run honey at about



A GOOD SWARM.

the same price. This was honey which had remained in the comb till it had partly candied, and when strained and bottled it granulated in the bottles like thick butter, without a particle of grain or grittiness. It was all bought by an experienced bee-keeper, who probably had customers waiting for it. The photograph of a natural swarm was taken under very peculiar conditions. I noticed that in the sunlight the bees moved their wings, &c., so quickly that no shutter I could make would keep pace with them, but I also observed that they hung like dead creatures after dark, so I focussed the swarm in full daylight, and left the camera standing till it was practically dark, and then took the photo with an exposure of about half-an-hour, yet any present-day photographer on seeing it

would call it instantaneous work. That of the queen and her attendants was really instantaneous, taken with a shutter I made myself, and was practically the first photograph I ever took. A regular photographer did the dark-room work, but did not care about facing live bees, so I got my first lesson in photography, and liked it so well that I took it up thoroughly. I made lantern slides on dry plates, though I was told they would never be good enough to show. I am sending some of these lantern slides made over thirty years ago to the Editor for his opinion. I do not see my way to improve on them with all modern conveniences, which the photographer of that day had not the advantage of possessing. For a developing tray I often used a cardboard plate box, or its lid, in which I had melted a common candle. I still do the same occasionally, and any of your readers may find it worth a trial if they run short of a developing tray of the size required, and the shops are shut. In

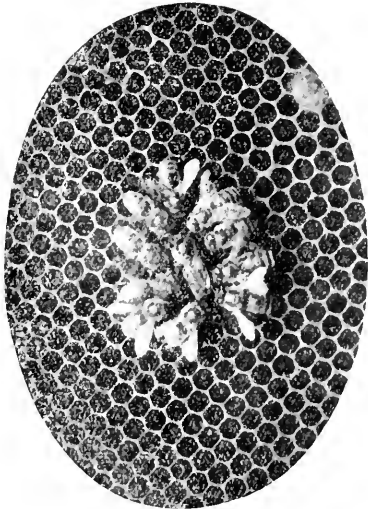

THE QUEEN AND HER ATTENDANTS.

printing lantern slides on bromide plates I gave fifty times the exposure that would have made a picture, and modified the developer to suit (no matter how).

(To be continued.)

AMERICAN AND COLONIAL PAPERS.

EXTRACTS AND COMMENTS.

By D. M. Macdonald, Banff.

*Doctors Differ.*—The *Australian Bee Bulletin* advises: "When stung, place the feet in cold water as soon as possible after being stung. The cold water draws the blood from the head and chest in order to counterbalance the difference at the feet!" An editor nearer home advises: "Apply hot water, as hot as it can be borne, which will reduce the swelling and irritation in

the only natural manner." Cold means congestion, inactivity, death! Warmth means movement, circulation, life!

*Stings Cure Rheumatism.*—This subject crops up eternally. *Gleanings* relates that Mr. John Renner, Cincinnati, visits the apiary of Mr. Fred Muth, and takes stings unflinchingly. The experiment has been going on for weeks with the result that he has been "Transformed from a patient hobbling about on a cane to a man who can walk almost as sprightly as anyone."

*America's Poorest Season.*—Mr. Root records: "The year 1911, from the very best information we are able to gather, appears to be doomed to go down to history as the poorest one for honey that has been known for many years back." Worse still, he reports other food-stuffs, including luxuries, are advancing in price; but honey has not kept pace with other commodities.

*A Golden Wedding.*—Fifty years ago Mr. and Mrs. A. I. Root were bound together in matrimony. Excellent pictures are given on pages 594-5, showing the "counterfeit presentment" of the pleasant and intelligent-faced old gentleman, and that of his genial and motherly help-mate of fifty years. May they see the diamond anniversary of their wedded bliss!

*Afterthoughts.*—"Oh, my imperfections as a bee-keeper!" writes a contributor to the *American Bee Journal*. "I make mistakes, blunders, and resolve to do better to-morrow. Here and yonder I could have requeneed colonies, and greatly increased returns. I could have given storing-room where it was required. I could have arranged things more ideally. I could have arranged the brood-nest better, so that queens would increase the population. These and many other things too numerous to mention." But these are afterthoughts. How very many of us could do things better if we had to do them over again?

*Man the Chief Factor.*—Mr. Townsend writes: "It's the man, not the hive, that produces tons of honey annually. That you cannot know too much about your business is as true to-day as ever. If you are not getting good crops of honey—as good or better than your neighbour who is in close proximity to you—do not attribute it to your hives or your location. In other words use your brains; they will help you out, take my word for it."

*Concentrated Wisdom.*—Last month I quoted the advice to "Keep more bees," improved into the advice to "Keep better bees." Last *Gleanings* improves on this still further: "Keep bees better." This is the soundest advice of the lot; how very frequently do we find badly-kept bees. Their dwellings, their surroundings, their store cupboard, their surplus chambers are

all evidences of slovenly bee-keeping. A well-kept apiary of one hive may pay better than one containing half-a-dozen.

*Working in Tent.*—"While working under a tent it was a revelation to me to learn that, although the bees outside were very cross, yet inside one could work with impunity, without a hat or veil on, and get scarcely any stings. The cross bees from the hive seemed to cluster in the corner of the tent, and stay there until shaken down when moving to another hive." Mr. Root, in commenting on the above experience of Mr. Byer's, says: "We have noticed this time and again. When robbers are prowling about bees are apt to be cross: but even when they are inclined to sting from other conditions, they can usually be handled easily under a tent or cage, for the moment a cross bee, or a number of them, find they are imprisoned in the enclosure, their desire to sting is immediately transformed into a desire for liberty. They bump their heads against the wire cloth, and then when tired out they cluster quietly on the top of the cage." A tent is an excellent article to use when any manipulations are absolutely necessary during a dearth of honey with robbers prowling about. I think those who do much handling of bees in a tent will agree that, for several reasons perhaps, stings come rarely their way. The same holds good when handling bees in a house apiary. Any bees left inside seldom sting of stinging.

*Selling Honey.*—The editor of the *Review* has been taking up a good deal of space in recent numbers. Many have recorded their own experiences, and in the latest issue Mr. Tyrrell gives his own experience. He believes in selling direct to customers instead of through a middle man, as thereby the producer pockets all profits. He considers a 10lb. pail the smallest package, as most customers will purchase one of these about as readily as a pound tin or bottle. For securing new customers he employed a high-school boy to canvass from house to house. At first he carried a sample, but later he trusted to verbal explanation. No one objected to the price asked, and no one made a request for a smaller package. Another plan he follows is to canvass clubs, associations, and restaurants. From one pail sold at a social gathering he secured orders for seventeen other pails. He gave the first gratis merely to advertise his trade. Still another source of customers is the working man. Call on them where they are working, say on new houses or at somewhat similar employments. He uses no samples, and takes care to talk only to one man at a time. Avoid talking to a crowd unless you

can have their undivided attention. He believes in selling on the plan of direct-to-the-customer and, without hesitation, advises his readers to follow it out as much as they can.

---

## THE HONEY HARVEST FOR 1911.

(Continued from p. 457.)

### MONMOUTHSHIRE.

The past season has proved the best that has been experienced for very many years. Not only was honey plentiful in quantity, but excellent in quality. Honey, which last year could be sold at 1s. 2d. per lb., this year has changed hands at 7d. Many of those who sold their honey at the beginning of the season, got a slightly higher price. It is no uncommon thing in the county to find a single hive yielding 120lb. In the more northern part of Monmouthshire, among the hills, where heather is plentiful, the yield has been without a parallel. When you contrast this with last year, when some beekeepers reported their return as "nil," and others a few pounds of very dark-coloured inferior quality, the change is a very welcome one. Generally, if the weather is inclined to be damp elsewhere, it is something worse than damp in these hilly districts. When a fine summer does come along this is an ideal county for bees.—F. G. S.

### NORTH MIDDLESEX.

I append report of season in my district, North Middlesex and South Herts, which includes South Mimms, Barnet, Muswell Hill, East Finchley, and New Southgate.

The bees did not come through the winter very well; most stocks, other than those fed up in late autumn, were short of stores, owing to the last bad season, and the mild winter caused a number of colonies to dwindle in the spring. The warm May brought all surviving colonies on rapidly, and by the end of the month all stocks properly cared for were in good condition, and a small surplus was secured from the fruit blossom. In June, just as the clover came into bloom, a cold and wet spell set in, and the bees were unable to take full advantage of a good crop of clover, mixed in among the grass. Hot and dry weather continued after the hay was cut, the pastures became dry and parched, consequently there was no second crop of clover. For the same reason the flow from the lime trees was very short. I got a little honey from a field of sainfoin close by me, but bee-men in this district depend on the clover and limes for their main crops. The general results are good; though not a record season for quantity, the quality has been excellent. There is little disease about,

but I heard of several cases of "Isle of Wight" disease having broken out during the earlier part of the year in Barnet. Stocks have gone into winter quarters in strong condition with plenty of sealed stores. We now have a Barnet and District Bee-keepers' Association, which was formed this year with a number of enthusiastic members. The association holds meetings, at which lectures are delivered, once a month. They held their first honey show at Barnet on November 14th and 15th.—H. CEILEY, Muswell Hill.

## NORTHAMPTON.

We have had in this county a good honey season. Some large "takes" have been reported of good quality, which has secured for our members many prizes, including the first in the light honey class at the Grocers' Exhibition.—ROBERT HEFFORD.

## NORTHUMBERLAND.

The honey harvest of 1911 has been much above the average, both from flowers and heather. From mid-April right on the bees were busy: fruit, hawthorn, charlock, &c., all in turn kept up a flow, while the clover was abundant in July right into August, the clover on the "fog" being exceptionally good. We have no bee-keepers on a large scale in the district, but with from two to four supers per hive all that I have spoken to are well content. Friend Crawshaw, I notice on page 397 "B.J." bemoaning that the honey-flow at the moors was all too short. I wonder whether he sent his bees up in time? My own stocks were sent on July 26th, and most were up in the supers by August 1st. Bees began at the heather at once, and the flow lasted till about the 15th. The drought dried up the nectar, and even the bloom was all burnt and withered before September came on, whereas a flow in the first or even second week of September is by no means uncommon. One result of the clover in the fog so late this year was that in many cases there was a certain amount of heather blend in the first racks, where hives stood near the edges of the moors, but the second and third racks were pure heather. That many racks of twenty-one fully-sealed sections were taken off proved that the flow was good while it lasted.

Mr. Robson, one of the joint secretaries of the Cheviot and Tweed Borders B.K.A., tells me that this season, for the first time in his ten years' experience, parent stocks with young queens did well. As a rule, it has not proved worth while sending such stocks to the moors. The successes of Mr. Robson at the "Royal" and Mr. Balmbra, of Alnwick, at the Dairy and other big shows, will, I trust, increase

the fame of our Northumberland honey, which, though much appreciated locally, is hardly as widely known as it should be. That entries at local shows have risen from about five or six to eighty-six in two years goes to prove the value of associations, but I was not asked to write on that subject. That all hives may winter well and be ready for as busy a year in 1912, is the best wish to all bee-keepers of F. SITWELL (Wooler).

## OXFORDSHIRE.

A year remarkable both for quantity and quality. Many very heavy takes are recorded, several of from 100lb. to 150lb. from a single hive. The flow commenced very early, and lasted long. The effect of the wonderful season was to increase the health of the hives and diminish foul-brood, but the moths were very troublesome.—J. S.

## SHROPSHIRE.

The honey harvest in Shropshire has not been as good as many people anticipated, except in some favoured localities. The spring was a very late one, and stocks did not begin to build up till several weeks later than usual. In addition, owing to the preceding bad season many stocks were weak and short of stores, and there was considerable loss where bee-keepers had neglected to feed up for the winter, one man, to my knowledge, losing seven colonies—the whole of his apiary—from sheer starvation. There was a large quantity of honey, of excellent quality, staged at the honey show held in connection with the Horticultural Fête at Shrewsbury in August; but taking it on the whole, although much above the average of the last three or four years, the yield was not so large as supposed by the outside world, owing to the continued drought drying up the nectar of the flowers.—(REV'D.) G. H. PRATT.

## SOMERSETSHIRE.

The honey season of 1911 in Somerset has been the best experienced for many years. The fruit bloom yielded well, though more stocks than usual were unprepared to take full advantage of it. The honey obtained showed slight indications of honey-dew, although in other respects it was of excellent quality and exceedingly thick. In several parts of the county considerable quantities of honey-dew were stored during the early part of June, some of the produce being almost black. Other parts of the county, however, appear to have escaped this entirely. The latter part of June and the month of July brought a continuous flow of excellent clover honey. Yields of from 80lb. to 100lb. per stock were frequent, and the exhibits at the annual show were so numerous that it was difficult to find

room for them all.—L. E. SNELGROVE,  
Hon. Sec. Somerset B.K.A.

(To be continued.)

## Queries and Replies.

[8255] *Uniting Bees.—Age of Queens.*

—I have a problem to put before you, the answer to which may interest many of your readers who, like myself, do not go in for queen-rearing, or the introduction of purchased queens, but rely on natural swarming for the renewal of their stocks. Suppose that in the spring of 1912 there are four stocks, A, B, C, D, all of equal strength, but none of them very strong; and that it is known that A swarmed in 1911, but the others not since 1910. In what way would you make these four colonies into two? Would you leave A, with its young queen, alone, and unite the others? Or would you unite A and B, and C and D? In the former case you would have one weak lot of bees with a young queen, and another strong lot of bees with an older queen; in the latter case you would have two hives, equally strong to begin with, but one with a young, prolific queen, and the other with a queen that is less prolific. By which of these two arrangements is one likely to secure the greater surplus of honey?

I have put my question in a concrete manner because I believe it is easier to answer in that way: but I should be glad if you could tell me, generally, what is the relative value of queens in their first, second, third, and fourth year? By their first year I mean the year in which they are hatched.—H. BALFOUR GARDINER.

REPLY.—(1) To obtain the best results you should unite A and B, and C and D, leaving the 1911 queen to head the united lots. A little later you could make a nucleus from the lot headed by the 1911 queen; place it beside the united colony of C and D. When the queen has emerged and been fertilised, remove the old queen and unite the nucleus with queen caged, to C and D, first removing the old queen, and letting them remain queenless at least twelve hours. In this way you will get young queens in both lots without purchasing. (2) Queens gradually depreciate after the second year; how much, depends a great deal upon the strain. There is no advantage in keeping a queen beyond her second season, unless of very good known qualities, and then only for queen-rearing purposes.

[8256] *Stock Ruined by Error in Manipulating.*—I bought for a friend a

stock of bees during the summer (through an advertisement in the "B.B.J."), which turned out to be exceptionally strong, on ten frames, and I had great hopes that they would eventually give a good account of themselves. About a week after they were put in position my friend brought a swarm, which had been promised for some time, and placed it in an empty hive adjoining the newly-purchased stock. As far as I can understand he had great difficulty in getting it into the hive, so he took four of the best frames with brood and bees attached from the stock, and put them in the hive with the swarm, giving frames with strips of foundation in exchange. I was not present at the time, or I should not have allowed it to be done. About a fortnight after I examined the stock and found they had made no progress at all, and had not even touched the foundation, and I now find they are dead, and apparently have been so for some time. The swarm adjoining is in fairly good condition, covering six frames.

Could you give me the reason why they should have died off in this manner? There was about half a pint of dead bees in the hive. I have an idea that the wasps may be accountable for it, as when I opened the hive I saw about half a score of wasps on the combs, and they have been very numerous this season. Should you think they were weakened to such an extent that they could not defend themselves successfully against the wasps? or is it possible it may be some kind of disease, though I could detect no smell about the combs or anything unusual.—J. L. H., Salcombe.

REPLY.—There is no doubt from what you say that the queen was removed from the colony together with the combs. Naturally, there would be a fight between the two queens, and one would be killed. The colony would rear another queen, which evidently got lost or destroyed when taking her mating flight. The colony now having no means of replacing her, gradually died out. It was most foolish to take out four combs and bees. The proper procedure was to take one comb of brood, brushing back the bees and place this in the hive in which the swarm was being established.

[8257] *Re-queening by Mr. Snelgrove's Method.*—I have been greatly interested in Mr. L. Snelgrove's paper on "Re-queening" (page 424). I understand that the body box is divided into two parts by a division-board. Behind this is placed four frames of bees; a hole is bored  $\frac{3}{4}$  in. in size, and 2 in. from the back of the hive, and the alighting-board is fixed for the bees to get out and in. An extra frame of bees is brushed in to the back



of the hive to make up for the flying bees that will come in at the front. Now, I would take it as a very great kindness if Mr. Snelgrove would advise me on the following points:—(1) Would he recommend this plan in spring as well as in August? (2) How many pounds of honey would he give to this stock to raise the young queen? (3) And if it was in the autumn would it do to feed the old queen with sugar syrup, so that they would go into winter quarters with a full stock of young bees, or would he feed her also with honey?—RENFREW, N.B.

REPLY.—Mr. Snelgrove has kindly replied to your inquiry as follows:—(1) The plan would work equally well in spring, but should not be allowed to interfere with the honey harvest. (2) Give the bees five or six holes of the feeding bottle, and keep it filled for the first ten days. About 2lb. of honey may be mixed with the necessary syrup. (3) Yes, sugar syrup.

[8258] *Honey Vinegar.—Granulation of Honey.*—Some time ago there was an article in "B.B.J." on the various frames in use previous to the adoption of the first "Standard" frame. (1) Can you give me the date of issue? (2) What quantity of honey should be put in a nine-gallon cask for making vinegar? (3) How would you account for two bottles of honey having about  $\frac{1}{2}$  in. in the bottom, remaining liquid, while the honey above and all other bottles of that extracted have granulated in a solid mass. Had the liquid been on top I should have concluded that it was thin, unripe honey, but I don't understand it being liquid at the bottom.—JOHN GOODELL, Cranbrook.

REPLY.—(1) "B.B.J.," 1906, April 19th, page 151; also "B.B.J.," February 1st, 1882, page 203. (2)  $11\frac{1}{2}$  lb. of honey will suffice. (3) It is the levulose that has got to the bottom, being more dense than the crystallisable dextrose. The reason it has not shown itself in other jars is because it has been more intermixed, and it is possible that the two jars were the first filled. Thin, unripe honey would float on top, whereas this seems to be dense levulose which does not granulate.

[8259] *Dwindling Stock.*—During the last fortnight of October I had one of the most extraordinary experiences of dwindling in one of my hives. Towards the middle of September I went carefully over my stocks, examining each hive carefully before packing up for the winter, and found that they had an exceptionally large supply of stores, the bees being also very strong in numbers.

I was attracted to the hive in question

about a fortnight later by the number of bees flying, and also by the dead bees on the grass in front. I was alarmed to find that the latter daily increased in numbers, and one mild day I opened the hive and found I had only about three frames of bees left. The day following was wet, but in spite of the rain the entrance of the hive had quite a busy aspect. I felt assured that robbing had commenced.

On further examination of the grass I found that the quantity of dead bees had greatly increased, and that there were quite a number creeping on the blades of grass.

Three days later I again opened my hive, this time just before dusk, and found it quite empty. There were not more than thirty dead bees on the floor-board. The combs were practically unbroken, and not more than 2 in. square of the honey had been used.

I shall be glad if you can give any enlightenment as to the cause, or likely cause, of the bees leaving the combs only to die a few yards from the hive? Their bodies seemed quite healthy, and on one of the combs there was a small patch of brood at stages from six to eighteen days' old. The hive is now securely closed, and the grass cleared of dead bees.—J. H. S., Selkirk.

REPLY.—Your description points very strongly to their being affected with "Isle of Wight" disease. We can give no other cause for the mortality.

---

#### OBSERVATORY FLOOR-BOARD FEEDER.

Mr. R. Grose, of Bodmin, sends us his improved feeder. This is made so that it may be used as a floor-board feeder, or placed above the frames. It is arranged for either slow or rapid feeding, and has an adapter which enables it to be used for skeps. It consists of a rectangular wooden feeder divided into two compartments. Each compartment is also divided longitudinally by means of a piece of glass, on one side of which there is a float and on the other a block of wood nearly filling the space. On this block there is a broad wick which by capillarity draws up the syrup and enables the bees to obtain it without any risk of drowning. The quantity of syrup taken is regulated by a zinc slide which covers the wick so that the slowest stimulative feeding is easily accomplished. For rapid feeding the division glasses are removed and placed on the top of compartments containing the floats, the other part of the feeder being also covered with a piece of glass when top feeding.

Mr. Grose calls this an observatory floor-board feeder, because when used below the hive one portion of it covered with glass is exposed for watching the bees at work. The feeder is suspended on two ledges fastened to the floor-board and the hive is slid backwards into place over it. The two compartments can be used also to feed two lots of bees in one hive, when divided by a division-board for queen rearing. The feeder is an improvement on the one described on page 455, of "B.J.," Nov. 18th, 1909, and we have no doubt will accomplish all that Mr. Grose claims for it.

## Notices to Correspondents.

*Letters or queries asking for addresses of manufacturers or correspondents, or where appliances can be purchased, or replies giving such information, can only be inserted as advertisements. The space devoted to letters, queries, and replies is meant for the general good of bee-keepers, and not for advertisements. We wish our correspondents to bear in mind that, as it is necessary for us to go to press in advance of the date of issue, queries cannot always be replied to in the issue immediately following the receipt of their communications.*

### *Suspected Disease.*

**J. W. M.** (Edinburgh.)—*Medicated Candy.*—The candy is a little too soft, and you have overdone the chemical addition.

**DUNRAGH** (Wigtonshire.)—Your best plan is to destroy bees, combs, and all contents of the hive, well disinfecting the latter. If the seller was aware that the bees were diseased it was a dishonest action to sell them to you as healthy. We should not advise trying remedies at this time of the year.

**ANXIOUS ONE** (Cams.)—We are much afraid from our external examination of the bees that when you receive Dr. Malden's report it will be that the bees have died of "Isle of Wight" disease.

### *Honey Samples.*

**H. W. R.** (Catford.)—The honey is partly from lime, but the bees have been visiting a jam factory or sweet-boiler's for a portion of their stores. It is quite suitable to use as food, the percentage from the latter source being very small.

**H. H.** (Cromer.) Sample No. 2 is best, being from pure white clover. No. 3 comes next, and No. 1 third in quality. The two last-mentioned are a mixture of clover and sainfoin.

**A. B. C.** (Welshpool.)—The honey is from mixed sources, being good in every respect, except colour, which has been

somewhat spoilt by a very small quantity of honey-dew. For home consumption this will not matter, but it will make it difficult to sell.

**V. C.** (Penzance.)—The honey is good in every respect but density, it being rather thin. If the sections are well filled they are worth about 9d. each retail.

**T. H. H.** (Bangor.)—The sample is a good honey, from clover with a little buckwheat or ragwort in it. Yes, utilise the sections as you suggest.

## Special Prepaid Advertisements.

**Two Words One Penny, minimum Sixpence.**  
*Orders for three or more consecutive insertions entitle advertisers to one insertion in "The Bee-keepers' Record" free of charge.*

*Trade advertisements of Bees, Honey, Queens, and Bee goods are not admissible at above rate, but will be inserted at 1d. per word as "Business" Announcements, immediately under the Private Advertisements. Advertisements of Hive-manufacturers can only be inserted at a minimum charge of 3s. per ½ in., or 5s. per inch.*

### PRIVATE ADVERTISEMENTS.

**CLOVER HONEY**, 58s. per cwt.; one 28lb. tin, 15s.; dark Honey, 5d. per lb. sample, 3d.—**THOMAS**, Coedmelyn, Stackpole, Pembroke. r 23

**WANTED**, Cheshire's "Bee-Keeping," volume 11., Practical.—Particulars and price to **HERROD**, "B.B.J." Office, 23, Bedford-street, Strand, W.C.

**BEST CLOVER SECTIONS**, 9s. dozen; seconds, 8s., packed on rail.—**BARNES**, Clogger, Wigton, Cumberland. r 21

**FOR SALE**, nice white candied Honey, guaranteed pure English, 4 28lb. tins, 60s., tins returnable; 1½ gross s. cap bottles, 4s. 6d.; 1 gross s. cap bottles 8s. 5d.; 1 dozen sections, 9s.; 1 lb. sample jar, 6d., cash with order.—**F. SAPLEY**, Madingley, Lytten-avenue, Letchworth. r 22

**WANTED**, Honey, White Wyandottes, or useful exchange, for new Beehives, Extractor, Ripener, 2 Incubators, 60. 40, gentleman's new 25in. lady's 25in. gentleman's 24in. cycles.—**BOWDEN**, Broomhill, Witley, Surrey. r 20

**BEEKEEPER**, can make appliances, plain gardening, seeks situation.—**PRITCHARD**, New-street, Stockbridge. r 19

**168 LB. HONEY**, in 28lb. tins, 6d. lb. splendid flavour and colour; sample, 3d.—**CUT-FORTH**, Oakham, Rutland. r 18

**1½ CWT. HONEY**, ½wt. tins, with tap, excellent flavour, dark; sample 1lb. jar, 1s.—**RECTOR**, Stanford Bridge, Worcester. r 17

**2 CWT.** good run English Honey, 6d. per lb.; clear.—**SHEPETH**, Cams. r 9

**GOOD**, pure English Honey, 55s. cwt, 28lb. 14s.—**GEORGE THOMPSON**, Helpringham, Stamford. r 16

**COMPOUND MICROSCOPE** in case, objective giving three powers, in good order, suitable for nature study. 12s. 6d., cost 30s.; particulars free.—**MASON**, Moored, Stony Stratford. r 15

**FOR SALE** Extracted Honey in 14lb. tins, at 6d. per lb.; sample, 2d.—**ARTHUR ADCOCK**, Ashcroft, Meldreth, Cams. r 14

**FIRST** grade Clover Sections and Clover Jars, 9s. 6d. dozen; ditto Heather Sections, 14/-; second grade Heather Sections, 11/-; 20lb. Bees Wax, 1s. 8d. lb.—**NICHOLSON**, Langwathby. r 13

## Editorial, Notices, &c.

### WHITBY AND N.E. YORKS B.K.A.

#### HONEY SHOW AT WHITBY.

The first annual show of this progressive Association was held at Whitby on Wednesday, 29th November, in the Silver Street Lecture Hall, and the numerous visitors to it were pleasantly surprised at the very large display of honey, wax, and bee-keeping appliances; over 300lb. of honey was shown in various neat and tempting forms. Mr. L. S. Crawshaw judged the exhibits, and had considerable difficulty in deciding which should receive premier awards in some of the classes, so high was the standard of excellence attained.

A brisk sale of honey went on during the afternoon, and the whole of the honey entered for the gift classes was disposed of to the many visitors, as well as a good deal from the selling classes.

At five p.m. there followed a lecture illustrated by lantern views of apiaries, appliances, manipulations and the natural history of bees. Mr. T. Hood gave the lecture and descriptions, and Mr. Pinkney described the aims, objects and the work of the Association, asking for the support of all bee-keepers in making it a still greater success. The membership is already over seventy. The lantern was manipulated by Mr. Cooper.

#### LIST OF AWARDS.

*Three 1-lb. Sections.*—1st, C. R. Pinkney, Whitby; 2nd, R. Hunton, Fryup; 3rd, Mrs. E. Adamson, Yarm.

*Three 1-lb. Sections Heather Honey.*—1st, Hy. J. Scaife, Pickering; 2nd, E. Baker, Pickering; 3rd, Mrs. W. Bowes, Stokesley; v.h.c., J. Shaw, Sandstead, R. Hunton; h.c. Mrs. W. Bowes, Stokesley; c., A. Botham, Whitby, and Mrs. E. Adamson.

*Three 1-lb. Jars Extracted Honey.*—1st, T. Hood, Whitby; 2nd, R. Hunton; 3rd, A. E. Harrison, Pickering; v.h.c., M. Benson, Pickering; h.c., Mrs. E. Adamson; c., Wm. Burn, Whitby.

*Three 1-lb. Jars Heather Blend Honey.*—1st, E. Baker; 2nd, T. Hood; 3rd, W. Burn.

*Three 1-lb. Jars Heather Honey.*—1st, R. Hunton; 2nd, E. Baker; 3rd, W. Bowes; v.h.c., F. W. Hutchinson, Malton; h.c., J. Shaw.

*Shallow Frame of Comb Honey.*—1st, N. W. Maud, Pickering; 2nd, R. Hunton; 3rd, Wm. Burn.

*Beeswax.*—1st, H. J. Scaife, Pickering; 2nd, A. E. Harrison; 3rd and c., T.

Hood; h.c., E. Burt, Pickering; c., E. Baker.

#### NOVICES' CLASS.

*1-lb. Jar of Honey.*—1st, A. E. D. Cooper, Whitby; 2nd, A. Thompson, Glaisdale.

#### SELLING CLASSES.

*Six 1-lb. Sections.*—1st, E. Baker; 2nd, N. W. Maud; 3rd, Mrs. E. Adamson; h.c., C. R. Pinkney; c., A. E. D. Cooper, Whitby.

*Six 1-lb. Jars of Honey.*—1st, A. E. Harrison; 2nd, P. J. C. Francis, Whitby; 3rd, R. Hunton; v.h.c., T. Hood; h.c., H. J. Scaife; c., P. J. C. Francis.

#### GIFT CLASSES.

*1-lb. Jar of Honey.*—1st, F. W. Hutchinson; 2nd, R. Hunton.

*1-lb. Section.*—1st, Hy. J. Scaife; 2nd, Tickle and Carr, Scalby; v.h.c., E. Baker.

*Straw Skep.*—1st, Hy. J. Scaife.

*2-lb. Cake of Bee Candy.*—1st, withheld, 2nd, E. Burt.—C. R. PINKNEY, Hon. Sec.

### HEREFORDSHIRE B.K.A.

This Association, after a lapse of several years, has, by the activity of Mrs. H. Mynors, of Llanwarne Rectory, been resuscitated, and a large number of bee-keepers have already joined. Sir James Rankin is the president, and Mrs. H. Mynors secretary and treasurer.

An exhibition of honey was given in the Shirehall in conjunction with the produce show of the County Council, and very satisfactory entries were made in the four classes provided. There were eight entries for sections, seven for light extracted honey, fifteen for dark extracted honey, and three for the best and most attractive display of honey and wax, to be over 56lb. in weight and not more than 1cwt. Three prizes were offered in each class, and after Mr. Alfred Watkins and Mr. Joseph Thomas, who undertook the onerous task of judging, had carefully examined and tested each entry, the result was given as follows:—

*Sections.*—1st, M. Meadham, Huntington; 2nd, Mrs. M. B. Bankes, Much Birch; 3rd, J. Helme, Norton Canon; r., Miss E. Gardiner, Peterchurch.

*Light Extracted Honey.*—1st, J. Helme; 2nd, J. Arnfield, Breinton; 3rd, A. Barker, Kington; r., J. Turbill, Pontshill, Ross.

*Dark Extracted Honey.*—1st, A. Barker; 2nd, C. J. Lewis, Pontshill, Ross; 3rd, G. Meredith, Westfields; r., Miss Barnes, Lugwardine.

*Display of Honey and Wax.*—1st, J. Helme; 2nd, Mrs. H. Mynors, Llanwarne; 3rd, J. Arnfield.—(Communicated.)

### SYMPTOMS OF "ISLE OF WIGHT" DISEASE.

As there still exists considerable doubt as to the symptoms of the so-called "Isle of Wight" disease, especially among those bee-keepers who have been so fortunate as to escape its ravages, I took a recent opportunity of obtaining some photographs of a colony severely attacked: these are reproduced in the hope that an illustration of the actual appearance of an infected colony will assist those who are inexperienced in recognising the disease so that in the event of an outbreak steps can be taken to prevent the whole apiary or district becoming contaminated.

It is hardly necessary to say it is a disease that attacks the adult bees only;

a distended appearance, and crawling over the combs and floor-board, unable to fly. When the temperature is not too low these work their way to the entrance, falling to the ground to perish in large numbers.

In warm weather the soiling of the hive and ground adjacent to it does not usually occur, but with a colony badly attacked during a cold spell the alighting-board, front of the hive, and ground in the immediate vicinity, as well as the inside walls of the hive, become very much stained with excreta from the diseased bees. This is probably one of the chief means of infection, containing as it does numberless *nosema* spores, which on contact with food supplies are automatically transferred to the alimentary canal of the bee, there to commence a fresh growth.

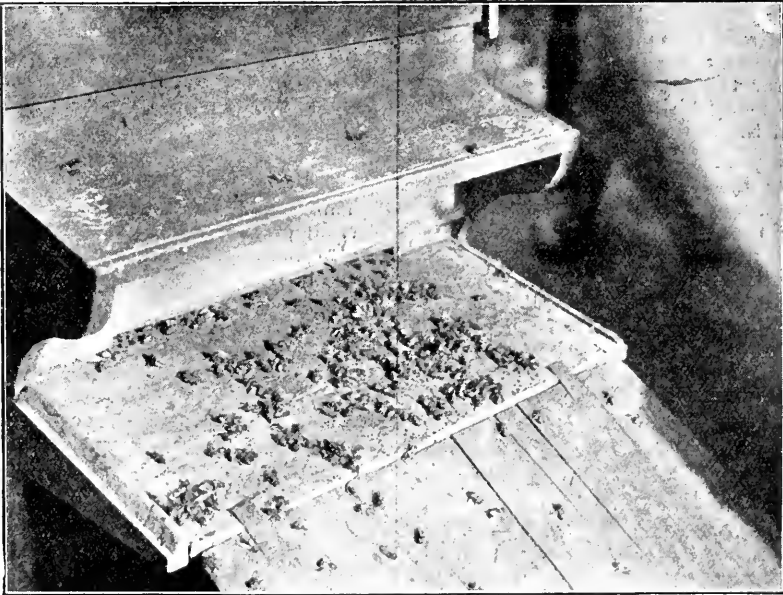

ALIGHTING-BOARD OF INFECTED HIVE.

the brood to all appearance remaining perfectly healthy, and with the exception of that portion which is killed through chilling, hatch in the normal way. The queen, too, apparently does not suffer, and usually is the last to survive.

Unlike other diseases of bees an outbreak may occur at any period of the year, and it is to be noted that very often the strongest stocks are those first attacked, and these appear to be the ones that suffer most. At this season probably the first sign of an attack is brought to notice by the number of dead and dying bees lying on the floorboard, both inside and outside the hive, as shown in the illustration, and if an examination is made a number of bees will be seen having

Wasps and other insects which occasionally gain access to the hives are possibly agents in transferring the germs. Wasps are scavengers and consume large numbers of diseased bees, and it seems very reasonable to suppose that they act as carriers, contaminating either the honey itself, or even by actual contact with the guards in their endeavours to steal into the hive.

A peculiar feature very noticeable in the complaint is the position of the small posterior wings. In healthy bees the wings, when in repose, are laid over one another on each side, and almost parallel with the body, the posterior ones being covered by the anterior pair; but when diseased the small wings seemingly become paralysed, and retain the posi-

tion as when in flight. I do not think this effect is peculiar to the "Isle of Wight" disease alone, as I have occasionally noticed it in healthy stocks, but it is certainly very marked in all suffering colonies, and thus forms one of the means of diagnosing the complaint.

The illustrations, of course, show only a portion of the mortality of the stock, but those bees that are in view all perished within a few hours. Every precaution should be taken to prevent further spreading by destroying diseased colonies and disinfecting the stand by means of carbolic acid or lime. Any dead bees lying about should be collected and burnt.—  
GEO. W. JUDGE, Dartford.

callow days we may have considered delicious.

I think school-boys of the present time are less familiar with the sweet concoction, and they less seldom than in the past trouble to undergo the fiery ordeal of harrying a bike with the attendant *pleasure* of a stinging. Or is it that the *bombus* tribes are dying out, or that perhaps the years are teaching them wisdom which induces them to resort to tracts unrequented by these roving biped corsairs? For quite a long time, whether from climatic or other reasons I know not, fewer wild bees' nests have come under my direct observation. This year, however, persistent hunting, with the aid of some

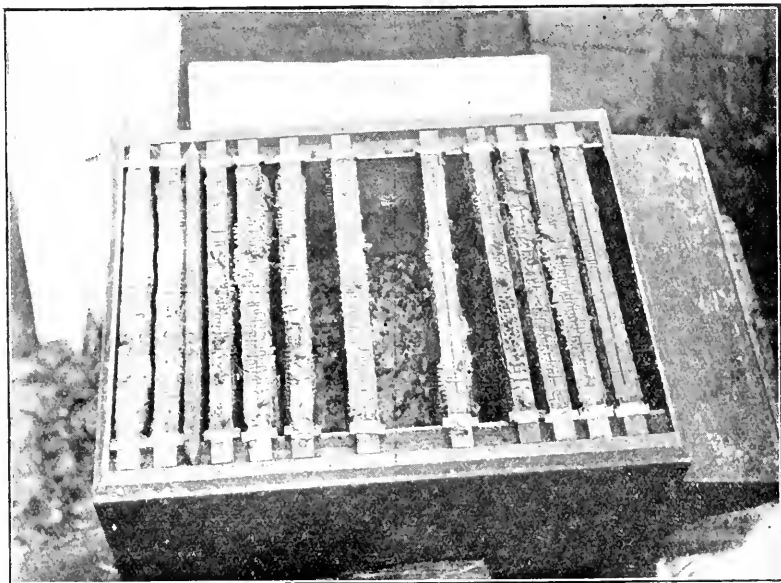

INTERIOR OF THE DISEASED HIVE.

## AMONG THE BEES.

OUR HUMBLE-BEES.

By D. M. Macdonald, Banff.

What school-boy bred in the country does not know a humble-bee when he sees it, and what would we think of one who is not familiar with the appearance and construction of a "hum-bees-bike"? I think Shakespeare in his youth must have known all about the subject, to judge by the words he puts in the mouth of Bottom—"Kill me," he says to Cobweb, "a red-hipped humble-bee on the top of a thistle, and, good sir, bring me the honey bag." Then Titania speaks of "honey-bags stolen from the humble-bee." Few of us now would relish the conglomerate mass stolen from a nest of these "humble dumbledors," which in our

eager and expectant youngsters, quite a number turned up, and received careful attention and interesting study. The great majority of the bees seen and the nests discovered were those of *Bombus Terrestris*, the earth-burrowing humble-bee. It makes its home generally in some dry bank where it scoops out a hole of considerable size, or it accepts such a hole if found made by some other means. This is one of the largest of the species, and it is rather a burly fellow, who may be known by its deep sonorous hum even before it is seen. Frequently the home-nest was found a foot or more beneath the surface. At times the gallery leading to it went straight from the entrance, at other times it took a winding and devious course. Every single queen-bee seen in early spring provides a nest of its own, and there sets

up housekeeping, the construction entailing a large amount of hard work before it finds a family and provides for its wants.

Before recovering from the weakening influence of its long hibernation it rests a little, seeking at first only sips of the strengthening nectar found in few flowers then. Soon it works like a Trojan, carrying in pollen and honey, completing the tunnel or vestibule of its home, or enlarging the roomy apartment in which its young are to be reared. Several early spring flowers are favoured, and the hum on some of the willows, sycamore trees, and fruit bloom is constant and pronounced. No rest or stay is now indulged in by the busy toiler. This patient mother, alone and unaided, founds the home, gathers the pollen, carries in and stores the nectar; and to these duties she adds that of comb builder and egg layer. Rude cells are built, not as our hive-bees construct them, perpendicularly, but laying horizontally with the mouth up, and the cells are round and cup-shaped. A pellet of pollen mixed with honey is placed in each cell, and into this mass is consigned an egg, which is practically left to its own resources to develop into a young bee, the mother being busy gathering more stores, building other cells, and ovipositing. Soon her daughters come to her aid, and between them several hundreds are raised before the end of the season. Then all males and neuters die off, leaving only the young queens to outlive the winter and carry on the race in a subsequent season.

This is the typical "Bumbee." No one hunting for this insect can mistake a specimen once seen. The feathering is mainly black, with a yellow ring in front of the wings and another on the abdomen, while the part near the tail is white. The length is about an inch, and the perfect females are rather larger than either workers or males.

*Bombus Hortorem*, as the name implies, is commonly found haunting our garden flowers. A little smaller than *Terrestris*, its colours and shadings are somewhat similar, and it constructs its nest in much the same way. Hereabouts it is by no means so frequently seen as most of the other *bombi*.

*Bombus Muscorum* is in many parts the most common of all, and in its season can be found in every field and meadow, as well as in our woodlands, wherever the insects can find sufficient moss wherein to make their home. Over a great part of the northern and central counties thousands of these bees' hives are disturbed by foresters cutting grass on the borders of woods and fields. I saw during August several hundreds in a small area.

*Bombus Lapidarius*, the red-tailed humble-

bee, chooses a different location for its residence, as it constructs its nest amongst stones. They are not widespread here. All these four classes of humble-bees are very hairy, and these hairs are sometimes arranged in different coloured bands. The long hairs of the under part of the abdomen are frequently used to carry home pollen, although this at times is carried on the hind legs as in the case of the hive bee. The communities are generally small, numbering frequently under one hundred, while they rarely exceed from two to three hundred. In the early part of the season workers only are reared, while males and perfect females are produced later. All these *queens* are allowed to inhabit the nest, and live in perfect amity towards the end of the season. "Bumbees" never swarm.

Several nests of all the four species of humble-bees were taken carefully from their selected sites, and provided means for nature study of a very interesting kind, and the bees in several cases became at least half domesticated. They became so far tame that they allowed close observation, occasional manipulation, and considerable teasing without showing any signs of annoyance.

---

## Correspondence.

---

*The Editors do not hold themselves responsible for the opinions expressed by correspondents. No notice will be taken of anonymous communications, and correspondents are requested to write on one side of the paper only and give their real names and addresses, not necessarily for publication, but as a guarantee of good faith. Illustrations should be drawn on separate pieces of paper. We do not undertake to return rejected communications.*

---

### BEEES AND FLOWERS.

[8303] I continued my observations on bees and pollen last summer, but have no fresh facts to add to what was published in the "B.B.J." last year (page 454). The only point of interest was that last summer I did not see a single load of birds-foot-trefoil pollen brought in (though I captured numerous samples that proved on examination to be something else), while in 1909 and 1910 it was a very important source of pollen. (I should mention, however, that the stock on which this year's observations were made was situated in a different part of the garden to that occupied by the bees in 1909 and 1910—the stock itself was a Whit-Sunday 1911 swarm from one of our old stocks, which we had given to a neighbour, and which had escaped the "Isle of Wight" disease). The

birds-foot-trefoil was, perhaps, a good deal less plentiful than usual, owing to the drought; but it is a curious instance, is it not, of how bee-forage varies? The same stock also gathered a lot of pollen from the white water-lily (*Nymphaea alba*), although they had to go nearly half a mile (as the bee flies) to get it, and the Portugal laurel, white clover, and charlock were in full bloom. The honey season here has been fair, and would have been very good but for the drought in August, which spoilt the heather crop. I fear we still have "Isle of Wight" in the district, but have not made any enquiries lately.—ANNIE D. BETTS, Camberley.

#### THE DRY SEASON AND DISEASE.

[8309] Mr. L. S. Crawshaw, p. 468, "B.B.J." of November 23rd, says: "If warm moisture be the essential of cure, how comes it that the disease (I.O.W.) spread in damp summers and diminished in a dry, hot season?"

Does not Mr. Crawshaw realise that he is referring solely to the condition of the atmosphere *outside* of the hive? A damp season is one of depressing inactivity to the bees, and the *inside* of the hive, where the elements of cure should be active, is then wholly deprived of those desirable conditions.

In a poor, damp season the hive itself is in a drier condition, internally, than during a hot, fully active season, when every possible cell is crowded with the glistening newly gathered nectar. In the latter case there are other most essential elements offering resistance to disease. The bees are active night and day, expelling the excess of moisture in ripening the thin honey with which the combs are heavily charged, the result being a continual change of air. This is without considering the greater activity out of doors, the more frequent flight, and a larger successive population. Compare this with the general inactivity of the bees in a damp season. Infrequent flights, with the bees shut in for several days at a time, bare, dry combs, little or no ventilation by fanning, and it is easy to see how the poor season adversely affects the internal economy of the hive, should any lurking enemy be ready to take advantage of stagnant nature.

Again referring to Mr. Crawshaw's text, he may be interested to know that after my statement in the "B.B.J." (8266), October 5th, p. 395, several readers put the matter to the test. One took a helpless diseased bee indoors, and placed it under a steaming saucepan-lid on the table, and after a few seconds the bee was able to fly away. Another, following a more drastic course, took a rose watering-

can, and poured some rather warm water on a lump of the usual crawling bees in front of a diseased colony, and presently, after cleaning themselves a bit, several took wing. Now this does not imply that these bees were definitely cured, but it shows moist warmth may be taken as one of the first aids towards effecting a cure.

How does Mr. Crawshaw know that the disease really diminished in the dry season? I have, as he says, already admitted that, with so many favourable items during the fine honey season, the treatment I recommended might then have a more beneficial effect; but to think that hot weather alone is likely to result in a permanent cure is one of the fallacies the majority of bee-keepers must dismiss from their minds, as many have already done through recent bitter experience. Some of the worst cases were reported to me during the hottest weather in July; and as soon as the honey-flow was over, while the weather still remained hot and dry, during the early autumn further sad cases, in increasing numbers, came to my knowledge.

The trouble developed further as the warmth gave place to chill autumn days, heavy rains, and a few days of confinement. The surplus honey being removed, and with little unsealed stores, loss of general activity, and ventilation, the old calamity was again seriously in evidence, and thousands of stocks went under before any attempt was made to save them. In some instances where the trouble was new to the unfortunate owners, the stocks had been slowly decreasing from August until the latter part of October, when appeals for help were, of course, too late. In hundreds of other cases stocks were allowed to become reduced before anything was attempted, and too late for any chance of recuperation before winter.

Through November, down to the present time, further freshly developed cases are being reported, and it must be recognised by the community that we are face to face with a disease which has yet but begun to run its course, and is very far from having worn itself out, as many like to delude themselves by imagining. In a former article in this journal I suggested that the autumn would in all probability find the "Isle of Wight" disease again largely in evidence. Unfortunately I have since then heard from hundreds of afflicted bee-owners; but from what one knows of the common spring reports, we have no alternative but to look forward to a still heavier outbreak in the early season of 1912. My object is not to create panic, but rather to put readers on their guard, so that losses may be avoided by timely observation and early attention.

Candy given in winter is one of the first elements of danger, especially where there



is any possibility of disease. The same writers who advocate candy for winter use will tell the reader that candied stores in the combs are unfit for wintering. How can they reconcile these opposite statements? Diseased bees, whether they have dysentery or constipation, as with the "Isle of Wight" malady, suffer from the want of water, while its absence is often the cause of trouble when candied stores are allowed. I have frequently been able to assist distressed correspondents in early spring who have complained of stocks having dysentery, although well stored (?), dry, and breeding freely at the end of February. The stores have been too thick, especially when consisting of heather honey; hence I advise that thin warm syrup be given in a 3lb. dose rapidly. But in this case nothing but a plain bottle is of much use, having two thicknesses of old thin linen (or cheese cloth) tied over the mouth, and the bottle inverted close in the frames, just over the cluster. Of course, it is desirable to do this while the bees may fly at the middle of a sunny day, and then they will settle down quietly after a free flight. It is better, however, to do it anyway rather than not at all, as the water is of the first importance, and the operator will use his own judgment at the time as to whether a medicinal application is required. My own motto is: "Never feed without."—SAMUEL SIMMINS, Heathfield, Sussex.

#### NOTES BY THE WAY.

[8310] I have to thank Mr. Crawshaw (8296, p. 463) for his report on what the Bee Diseases Act Committee are doing. Since the "Tickner Edwardes" draft bill appeared in the "Smallholder" I have had several letters on this new "terror" to bee-keepers, which will meet with our most strenuous opposition, and I trust bee-keepers will carefully read and study the effect that such a measure will have on our industry before they append their signature to the so-called petition—to condemn the straw skep to extinction. As regards the B.B.K.A. draft of the Bill (F.B.), there will have to be included a clause exempting large apiaries from compulsory inspection. D. M. M. says (p. 415) the owner conducts the manipulation while the inspector looks on. That may appear very fair from one point of view; but suppose the inspector calls just after we large bee-keepers have finished our spring cleaning; is it reasonable that we would willingly go through our apiary again? or would it be necessary? I contend that any bee-keeper who has twenty or more hives is not likely to allow foul broody colonies to exist in his apiary, as every practical bee-keeper knows that such colonies are not only use-

less of themselves but also a great danger to his other healthy colonies. Besides, a large apiary of two to three hundred hives would take a fortnight, in some English springs, to go through. Who would endure such compulsion? I shall be glad to hear from my friends—the owners of large apiaries—as I cannot write them individually, if a clause exempting us from *compulsory inspection* be included in the next "Bill" will meet their approval. This clause would not prevent anyone of us calling on the inspector to inspect our bees if we wished his help or advice, but we must not have any affected area business with bee produce, or bees either, *except bees and queens from infected apiaries*. A friend of mine had over  $4\frac{1}{2}$  tons of honey this season. What would it mean to a man such as this if his apiaries were within an affected area, and he was debarred from selling his produce?

My note on the combination hives has brought me so many letters I cannot reply to all of them. I ought to have said that the "Combination" hive was brought out by the late Editor of "B.B.J.," Mr. Chas. Abbott, and is still made by Messrs. Abbott, Southall. It is not a cheap hive; it is too good and durable to be cheap. My frames run parallel to the entrance, and a packed cork-dust dummy in some hives, and plain board dummy in others, with space at back. The sides of body are 11in., and in bee-gluey districts a 2in. piece at the back end should be made to turn down on two hinges; this gives a better chance of inserting a screw-driver to prise up the racks of sections if required. My racks are of the usual size, to take twenty-one  $4\frac{1}{4}$ in. by  $4\frac{1}{4}$ in., two bee-way sections with slotted dividers. My best dividers are cut from thin zinc, and with these thin dividers I get very little propolisation. There is no difficulty in parting the sections, as is often the case with wood or even thick tin dividers. Perhaps I should add my racks have slotted wooden rests and a plain follower, and a wedge to tighten up the sections. I use Abbott's broad shoulder frames, and fix a strip of wood each side of the section racks, so that the rack of sections, when on the hive, prevents any bees from escaping from the brood combs. I have never used hanging frames for sections, or excluder under sections, but always use it under shallow frames.—W. WOODLEY, Beedon, Newbury.

#### A NOVICE'S BEE-NOTES.

[8311] Having been a BEE JOURNAL reader for the past two years, I had a desire to start a hive of my own, so in June, 1910, I purchased a swarm from a friend in this village. The queen was:



about eleven months' old, but as it was such a cold summer, I got very little honey—about 11lb. or 12lb.—which I left in the hive, and supplemented this supply in the autumn by giving them 11lb. of sugar made into syrup, according to directions in the "Guide Book," and they came out in good condition in the spring of 1911.

On the 6th of June last I decided to make an artificial swarm as the bees were increasing so fast which I succeeded in doing, and on the 10th July was rewarded by finding eggs in the hive. On that date I made a second swarm, placing it on the old stand and removing the original stack to a new location, as I also did in the first instance. On 1st August I found eggs in the second stock; thus I had three stocks all the progeny of one queen.

I have had during the summer 38lb. of extracted honey, and the bees have drawn out twenty-four sheets of foundation (standard frames), and fifteen shallows, also five shallow frames half-drawn; and when I examined them on 7th September, I found two of the hives with nearly sufficient honey to winter on, and the third hive had four frames filled from top to bottom, besides five more nearly half full. I gave the three stocks 10lb. of syrup, and I believe they will have sufficient to bring them through the winter.

I may add that my stocks are just the ordinary dark coloured bees that have been in the village for a generation—quite forty years. I was also told that bees would not do any good round here, as we are too near the sea for honey. Certainly, I know some that do not seem to do any good.

Now, Mr. Editor, how does this experience compare with other young bee-keepers? [Very well indeed.—ED.]

Some of my friends in the craft say they have never seen more perfect frames (they are all wired), and that my manipulations are all right, I am hoping to increase my stocks next year and get a few more pounds of honey. Wishing all brother bee-keepers success.—T. H. P., Grainthorpe.

#### JUSTICE TO WASPS.

[8312] With reference to the "cutting" in "B.B.J.," page 472, from T. J. K., Leamington, the writer is wrong when he accuses the wasps of Warwick of having killed elm trees. It has been found by the scientists at Kew that these elms were attacked by a fungus called "slime-flux," and that the wasps only came to suck up the sweet fluid. The trees were doomed as soon as the slime-flux got to such lengths, and the wasps had no more to do with it than the dogs that licked the chariot had to do with the death of Ahab.—G. G. DESMOND.

#### CAPPINGS OF COMB.

BY L. S. CRAWSHAW, NORTON, MALTON, YORKS.

*Drone v. Worker Comb* (p. 407).—As Mr. Harris pointedly remarks, when comparing our opinions, that he writes from "actual practical experience," which does not appear to leave much loophole, there is little for me to do but admit a dangerous leaning towards theory! He asks me questions, however, which admit of difference of opinion, and must forgive me if I appear to theorise in an endeavour to arrive at solutions. First, then, I think there can be no "practical objection to worker comb in shallow frames." At least, it must depend upon the purpose of the comb. If bees are to be reared in the combs, then worker cells are desirable, but if the combs are to be devoted to the production of extracted honey, drone size has many advantages! Mr. Harris himself points out: (1) the practical immunity from pollen (p. 345), and Mr. Herrod deals *seriatim* with the question (p. 413); (2) less wax is required, a small point, perhaps, but (3) allied to this, combs are more readily extended to the wide spacing; (4) the natural instinct is complied with to the advantage of the bee-master; and (5) the bees more readily adopt the super in springtime; (6) moisture is more easily evaporated, a big point; and (7) honey leaves more readily, and thus more is obtained in the extractor—a considerable gain. On the other hand, excluder must be used, a debatable disadvantage, and the combs are not available for driven bees, &c., as the bees cannot pack so well. But I have dealt with this point, in supposing a distinction between brood combs and super combs. The question is still further affected by the type of hive used. The user of the sectional hive is master of the situation, and well-filled drone combs can be placed outside the brood-nest. But if, as I judge, Mr. Harris uses the standard, he must own surplus roofs to be able to use these shallow combs to advantage, otherwise standard combs would be preferable. And, according to his showing, they cease to be super combs when so used, so that he is forced into the necessity of removing them from shallow to standard frames. Apropos of this, if it must be done, would it not be better to substitute standard end-bars and leave the comb attached to the original top-bar? I have abandoned this kind of work, and as for extracting from skep-combs, I can only describe it as a messy business. Again, the building up of pieces of comb into a larger frame involves a number of transition cells, which result in the rearing of drones, the which Mr. Harris seeks to avoid. I do not object to a few drone cells in the extreme corners, but I do not like them to occur in the centre of otherwise good combs. I

prefer, indeed, to devote a comb to the purpose, and such comb is marked by a V-shaped notch cut out of the end of the top-bar, which gives it a swallow-tailed appearance. Mr. Harris further asks what I would do with heavy and perfectly opaque combs. Well, if they really were opaque, I should judge their opacity to be caused by honey-dew or—remote possibility—by much pollen, and I should give them to needy nuclei. What else could I do with them? Certainly I should not extract them, as Mr. Harris seems to expect. Evidently, I misunderstood him as to drone comb in sections, but he wrote of "comb honey for show purposes," in connection with the freedom from pollen, so that my mistake was perhaps pardonable. Be that as it may, I have had so many sections spoiled this year that I am seriously considering the use of drone base, instead of worker, for all super purposes.

*Wooden Extractor* (p. 407).—I have never used one of these, but I imagine a danger in the hands of a less careful bee-keeper than Mr. Harris. For if it were left one season without being properly cleaned, would it not become tainted with sour honey? A "tin" extractor requires equal care, but carelessness is not fatal. It can be heated and brushed over with hot paraffin wax, and made satisfactory. The best treatment is to let the bees clean the extractor out when thoroughly drained immediately after use.

*A Point of Order* (p. 415).—D. M. M. demands the name of the villain who said there were no young bees in the hive. I admit that I presumed it, if I did not actually say so. But D. M. M. implied it, I thought, for he wrote (p. 282) of introducing "eggs and larvæ," to a stock in which no worker bee had been reared for months, if at all. Now, unless sealed or hatching brood, or young bees, were also introduced (and in my first and perhaps over-hasty reading, I presumed there were not), the resulting bees would find no larvæ to rear at their date of hatching. But even supposing brood were hatching, I doubt whether that would be sufficient. Such very young bees would not, I suggest, sufficiently influence the mind of the colony, already discouraged beyond measure by their abortive attempts to rear a queen. Nothing but the introduction of sufficient bees to reorganise the colony would suffice. Now having made that point afresh, I would ask D. M. M. to re-peruse my note. For he has unintentionally misrepresented me as asserting *inability* on the part of certain bees to perform certain functions. I referred, as he will see, to their reluctance—which, however, I am willing to admit, for the sake of argument, implies a temporary incapacity, and I further

stated that their performance would be, under the circumstances detailed, inadequate. Beyond that I did not go, for, like D. M. M. himself, I am inclined, perhaps too much inclined, to measure the conclusions of others by the foot-rule of a necessarily limited experience. Upon re-reading D. M. M.'s note, I see he makes a point of the bees not being aged in the worn-out sense, but that is a little stretching of the term "young," as we understand it, is it not? In any case, my comment (p. 337) seems entirely to cover the point.

---

#### A CHEAP AND WELL-MADE HIVE.

We give below a very interesting account of this work done by an enthusiastic young bee-keeper Mr. S. Heaselden, with a photograph on opposite page of a hive made by him. We had the pleasure of awarding this a first prize in its class at the Crayford Show, and can testify to the excellence and accuracy of the workmanship, which would be a credit to a much older person. We prophesy a successful future in bee-keeping for its builder.

Mr. Heaselden describes it as follows: "The hive is 'W.B.C.' pattern, and consists of a stand on splayed legs, a loose floor-board with sunk entrance, and a sloping alighting-board, body-box with movable porch (which slopes to the sides), regulating slides, one 7in. lift, one 6in. lift, and a roof which is calico covered, and afterwards painted. This makes it quite waterproof. The inner brood-chamber, with a division board, containing ten standard frames, is inside the body-box. I shall probably make the shallow frame, and section racks next spring, as I require them. All parts exposed to the weather are painted with three coats of white lead paint. The joints of the hive are dovetailed together, and the whole was made from two Quaker Oats boxes, costing 8d., and other old wood which was found about the yard. The paint cost 1s. My age is sixteen, and I have made the hive from instructions which I have heard at Mr. Herrod's lectures at Crayford."

---

## Queries and Replies.

[8260] *Wintering with a Super in Position.—Sting of the Bee.*—I should be very much obliged if you would set my mind at rest upon the following:—In the early autumn, having extracted the honey from the supers, I placed the latter back on the hives again to be cleaned up. Before taking the supers away in the first place I had made certain that the honey-

flow had ceased; but shortly after this the drought was broken, and the bees in one hive set to work again, and stored a quantity of honey. This I left with them, and they are now wintered with a partly filled super, the combs of which they do not cover. Above this there is a chaff cushion and felt quilt. Will they be able to generate sufficient heat to survive the cold? I should be very loath to lose the stock. Another question I have been asked, and to which I have never been able to discover a reply, is:

[8261] *Spacing Shallow Frames.*—I shall be glad if you will kindly let me know through the medium of your valuable "B.B.J." whether it is advisable to space the shallow frames 2in. apart from centre to centre, or  $1\frac{1}{2}$ in., as I have seen this plan recommended, and also adversely spoken of. I feel inclined to favour it myself seeing that it would mean a saving of comb drawing to the bees to the extent of, say, two frames. If you advise this plan how do you fix the frames? as I have tried fixing them thus, but I can-



MR. S. HEASELDON AND HIS PRIZE HIVE.

"Does a bee die after having used its sting?" You will doubtless notice I am a beginner in beecraft, and I may say that the "B.B.J." affords me pleasure every week.—E. N. P., Manchester.

REPLY.—(1) You must leave the super as it is now. You would do more harm by disturbing the bees in taking it off than in allowing it to remain. (2) The bee usually tears away the sting on account of the barbs. When this happens it dies in the course of a few hours. If it extracts the sting, which it can succeed sometimes in doing by going round and round, so freeing the barbs, it does not die.

not get eight frames to fill the rack and get them 2in. from mid-rib to mid-rib. Perhaps I might overcome this difficulty by using extra wide metal ends, so if you advise this spacing kindly let me know what size ends I should use.—J. E. J., Pontardulais.

REPLY.—Shallow frames should be spaced 2in. apart after the comb is built out. You can obtain the wide metal ends for the purpose from any appliance dealer.

[8262] *Extracting Wax.*—I should be very much obliged if you would kindly tell me what is the best method of

extracting the wax from brood-combs? I have used a "Gerster" extractor for some time, but it is a very slow and, I consider, unsatisfactory process. It takes almost as much coal to keep it going as the wax is worth, though it works very well with cappings or scraps of natural comb. The wax-extractors, fitted with screw presses, seem to be rather expensive, and the question is whether the benefit derived is worth the outlay. If it is a fair question to ask, which one should you recommend?—WAX, Worcester.

REPLY.—The best and cheapest way of extracting wax is by means of a "Solar" wax extractor. They soon repay their cost.

---

## Notices to Correspondents.

---

*Letters or queries asking for addresses of manufacturers or correspondents, or where appliances can be purchased, or replies giving such information, can only be inserted as advertisements. The space devoted to letters, queries, and replies is meant for the general good of bee-keepers, and not for advertisements. We wish our correspondents to bear in mind that, as it is necessary for us to go to press in advance of the date of issue, queries cannot always be replied to in the issue immediately following the receipt of their communications.*

---

W. Iox (Grimsby).—*Producing Comb Honey.*—Your questions would need pages to answer properly, and as our space is limited you had better purchase a copy of the "British Bee-keepers' Guide Book," in which you will find simple instructions for working. Briefly, you did wrong in driving the bees so late in the year, and it is doubtful if they will live. Should they survive the winter, and are still weak in spring, unite them to make a strong colony.

ANXIOUS (Lazonby).—*Stock Short of Stores.*—The stores will not be sufficient for the whole winter. To make all safe give a cake of soft candy; medicated is best.

W. A. C. (Castle Cary).—*The Common Wasp.*—The wasps sent are queens. We have always found that the queens are much larger than the workers.

E. A. (Leamington).—*Honey District.*—We regret our inability to speak of the district you mention with personal knowledge. Write to the Hon. Secretary of the Warwickshire Association, Mr. J. Noble Bower, Knowle, Warwicks. No doubt he will be able to give you the desired information.

SANDYCROFT (Renfrew).—*Good Honey Districts.*—At present it would not be advisable to start in either of the counties you name, on account of the

presence of "Isle of Wight" disease there.

### *Suspected Disease.*

A. B. C. (Woolwich).—The bees have died from "Isle of Wight" disease. All combs and internal fittings of the hive should be burnt.

R. W. W. (Suffolk).—They are suffering either from "Isle of Wight" disease or malignant dysentery. Send a few bees (alive, if possible) to Dr. Malden, Medical Schools, Cambridge, for his opinion.

A. D. T. (Nantwich).—Yes, isolate the affected colonies, and write Dr. Malden again.

INQUIRER (Basingstoke).—We regret to say that the bees show distinct symptoms of "Isle of Wight" disease.

### *Honey Samples.*

J. C. A. (Grangemouth).—The heather honey you send is good in every respect except density. The defect is due to an admixture of other honey, probably clover.

A. C. S. (Norwich).—A light-coloured honey of good flavour and aroma, gathered from mixed sources.

---

## Special Prepaid Advertisements.

**Two Words One Penny, minimum Sixpence.**  
Orders for three or more consecutive insertions entitle advertisers to one insertion in "The Bee-keepers' Record" free of charge.

Trade advertisements of Bees, Honey, Queens, and Bee goods are not admissible at above rate, but will be inserted at 1d. per word as "Business" Announcements, immediately under the Private Advertisements. Advertisements of Hive-manufacturers can only be advertised at a minimum charge of 3s. per ½ in., or 5s. per inch.

---

## PRIVATE ADVERTISEMENTS.

REVOLVING OBSERVATORY BEEHIVE, iron axis, taking two Standard frames, 15s.—HART-WRIGHT, Fernhurst. r 41

GOOD LIGHT HONEY, 56s. per cwt.; sample, 3d.—DEAN, Bower Vale, Epping. r 40

3 CWT. BEST HAMPSHIRE HONEY, granulated, 4 f.o.r. 42s.; in 28lb. tins; single tin, 15s.—CORBETT, Hurstbourne Tarrant, Andover. r 39

HONEY, first quality Sections, 8s. dozen, three dozen 23s.—R. COUSINS, The Rosary, Merton, Gainsborough. r 38

SEVERAL dozen 1lb. jars Light Honey, 7s. 6d. per dozen; few strong Stocks, on eight frames.—L. W. MATTHEWS, Great Rollright, Oxon. r 37

12 LB. extra light Beeswax, 1s. 8d. per lb., carriage paid.—AVERY, Deverill, Warminster. r 35

HONEY in 14lb. tins; granulated, at 6d. per lb.; sample, 2d.—W. JOHNSON, Melbourne, Cambs. r 35

5 CWT. good medium Honey for sale, granulated, 28lb. tins; sample, 2d.—HAZZARD, Haddenham, Ely. r 34

HEATHER HONEY, 16oz. screw cap jars, 10s. dozen; 6 for 5s. 6d.; sample, 3d.—COOPER, Thorley, Isle of Wight. r 32

OFFERS WANTED for two Bee Hives, with fittings, Makers, Overton, Crawley.—Apply by letter to WOOD, 13, Dyers-lane, Putney. r 31

## Editorial, Notices, &c.

### REVIEW.

*Bees and Honey, or First Lessons in Bee-keeping* (G. W. York and Co., 117, North Jefferson Street, Chicago, U.S.A., price 50 cents. 2s. 1d.).—This is a new edition of "Bees and Honey," written by Thomas G. Newman, editor of the *American Bee Journal*, and published first in 1878, under the title of "Bee Culture, or Successful Management of the Apiary." The present edition has been revised by Mr. C. P. Dadant, one of the most successful honey producers and the reviser of the last edition of Langstroth's book, so this is a guarantee that the work is well done. The book before us is principally intended for beginners; it contains the foundation principles of bee-keeping, and is not meant to take the place of the larger works on the subject. Progress in bee-keeping has been so great during the last thirty years that we are not surprised to find that much which appeared in the earlier editions has had to be left out, new matter taking its place. The book consists of 189 pages, is profusely illustrated, and the cover, which represents a reproduction of a comb showing sealed honey-cells and brood in all stages of development, at once shows that the work is devoted to bees. A number of useful recipes will be found at the end in which honey figures both as medicine and food, nearly four pages containing recipes for various sorts of cakes.

### HONEY IMPORTS.

The value of honey imported into the United Kingdom during the month of November, 1911, was £5,326.—From a return furnished to the *BRITISH BEE JOURNAL* by the Statistical Office, H.M. Customs.

### HOW POLLEN IS COLLECTED BY THE SOCIAL BEES, AND THE PART PLAYED IN THE PROCESS BY THE AURICLE.

By F. W. L. Staden, F.E.S.\*

(Illustrated with Drawings by the Author.)

At the base of the hind metatarsus of the worker honey-bee there is a strange thorn-like projection, named by Kirby the auricle.

The auricle forms with the apical end of the tibia, which is truncate, a powerful pair of pincers, the function of which, according to modern text-books on the honey bee, is "for removing the scales of wax from the abdomen."

A few days ago, feeling dissatisfied with this as a full explanation of the function of the auricle, more particularly because the wax of the queen and worker humble-bee, which also possess the auricle, is soft and sticky, I determined to carefully examine the auricle and its socket in the tibia in some specimens in my collection, and found that in several queen humble-bees the socket contained particles, not of wax, but of pollen. Moreover, in a worker humble-bee (*Bombus vuderatus*), which had been captured in the act of collecting pollen, and had a small quantity of this substance in each corbicula or pollen-basket, the space between the auricle and its socket was crammed full of pollen, the pollen extending from here in an unbroken mass on to the apical end of the corbicula. It then occurred to me that the auricle might be used to push the pollen on to the corbicula, and on looking for corroboration I saw a beautiful apparatus for this.

The structure of the auricle with the surrounding parts is essentially the same both in the honey-bee and the humble-bee, though there are differences in detail, and while not denying that it is used in the honey-bee for holding the wax scales, I think it is plain that its primary function in both bees is to assist in conveying the pollen to the corbicula. How it does this adds an interesting page to the wonderful story of the life of the bee that is not given in our text books.

The inner side, that is the side next the body, of the metatarsus, is densely clothed with stiff, short bristles (in the honey-bee these form ten transverse rows). These bristles, as Cheshire and Cowan observe, constitute the pollen-collecting brush by which the pollen is gathered from the hairs on the body, and in my *B. vuderatus* worker they were thickly covered, towards the apex, with pollen. Along the apical end of the tibia on the inner side, bounding like a wall the socket of the auricle, is a comb called the pecten. The function of the comb is, clearly, to scrape the pollen off the metatarsal brush into the space between the auricle and its socket, for this is where we next find the pollen, the pollen on the metatarsus of the left leg being gathered by the comb on the right tibia, and that on the metatarsus of the right leg being collected by the comb on the left tibia. And now, with the space between the auricle and the end of the tibia stuffed full of pollen, what is the next stage? Simply by the straightening of the leg, the auricle enters its socket and the pollen is forced outwards and upwards on to the corbicula. By a continual repetition of this process the corbicula is gradually loaded, each fresh contribution being pressed up by the auricle and

\* Copyright reserved by the Author.

tending to push forward the mass that has gone before.

It is now clear why the corbicula is so perfectly smooth and impunctate, for the pollen actually slides up it. The edge of the corbicula is fringed all round with long, slightly incurved hairs to retain the accumulated pollen, except—and this is very significant—that portion of it which adjoins the socket of the auricle, and here the corbicula is slightly hollowed. Over this hollowed entrance to the corbicula the hairs springing from either side form an arch. In the humble-bee this arch appears to be for the purpose of safely guiding the stream of pollen on to the corbicula, but in the honey-bee there is another arrangement to carry out this duty, and in both bees the main function of the arch of hairs is probably to hold the accumulated pollen without interfering with the passage of fresh pollen on to the corbicula.

and guides it on to the corbicula. The process is easily understood by referring to Fig. 4, which demonstrates strikingly the modification of structure for forcing material through the legs outwards and upwards. I made the drawings of the leg of the honey-bee here shown from freshly-killed specimens, and, while viewing them under my microscope, muscular action caused the joint to open and shut and showed how perfectly the auricular fringe performs its duty.

In the humble-bee the entrance into the corbicula is not perfectly hairless, but is densely clothed with short fluff (mossy hairs), and bears about three basket hairs. In the honey-bee there are traces of fluff, but no longer hairs. The presence of the fluff and hairs is probably to prevent the pollen slipping off at its start.

It is to be observed that the auricle does not merely push forward the pollen, but acts in conjunction with its socket

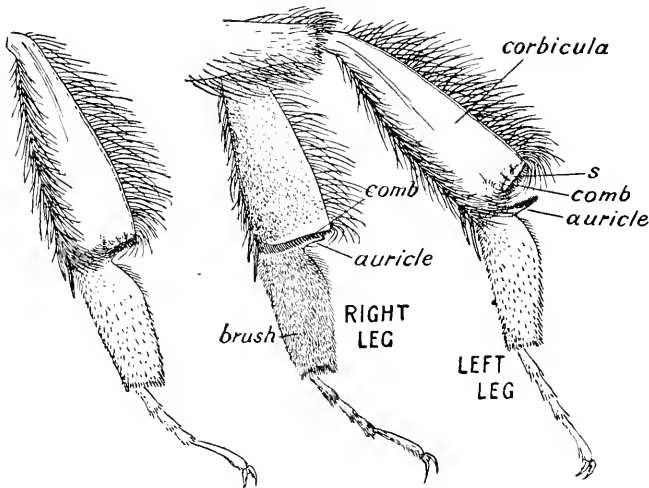

FIG. 1.  
HIND-LEGS OF QUEEN OF *Bombus Terrestris*.

There is an angle between the surface of the socket of the auricle and that of the entrance to the corbicula. In the humble-bee this angle is obtuse, and so the pollen is easily pushed on to the corbicula. But in the honey-bee the angle (see Fig. 4) is much sharper, the surface of the socket of the auricle being concave (in the humble-bee it is slightly concave), and the auricle is produced into a lamellate wing, its surface being also concave. The pollen, when compressed between the auricle and its socket, can find no way of escape except by forcing back the weak wing of the auricle, and so it passes to the outer side of the leg. Here, owing to the sharpness of the angle, it would fail to pass on to the corbicula, but this is prevented by a fringe of hairs on the auricle, which deflects the stream of pollen

as a pollen press, and this is probably a very important and essential function, for the pollen on the metatarsus is in a loose condition. Unless each little contribution was well compressed before being added to the bulk on the corbicula it would crumble to pieces. But a press that stamps out each lot of pollen as a separate cake would be useless; this is prevented in the humble-bee by the shelving away of the surface of the socket, and in the honey-bee by the yielding wing of the auricle. And so each little lot of pollen is not only compressed, but is plastered firmly to the lump on the corbicula.

Different specimens of queen and worker humble-bees in my collection showed the whole process in different stages; it was also shown well in a worker of *Apis*

*dorsata* from India, caught after it had collected a little pollen.

The fact that the pollen always begins to collect at the apical end of the corbicula is now satisfactorily explained.

To test the working of the auricle and its socket, I relaxed a queen of *Bombus lapidarius*, and after filling the socket

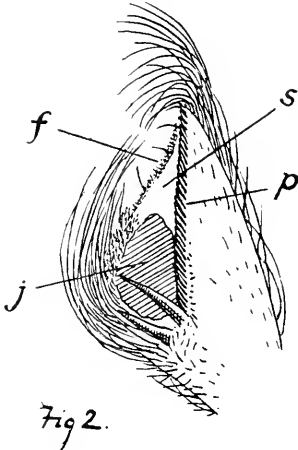

with some pollen that I dug out of a comb from one of my hives, I worked the joint and began loading the corbicula just as the bee does it. I was struck with the freedom of action of the joint and noticed that the auricle could be placed in its socket in various positions, so that it can not only compress pollen there, but it can scrape

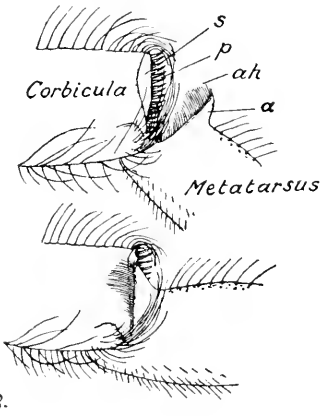

out the socket, and on the other hand can deliver the pollen right on to the corbicula.

It should be added that the metatarsi of the middle pair of legs also possess pollen brushes, and the pollen dust is gathered by these (at least in the humble-bee) out of the hairs on the upper surface of the thorax. The pollen dust on these legs is

moistened with honey from the tongue, and is conveyed to the Corbiculae of the hind-legs in the manner explained. Probably it is also conveyed to the hind metatarsi by rubbing the legs together. Unless the pollen dust was thus moistened it would not cohere.

Although our modern authors do not connect the auricle with pollen-gathering, Kirby, writing of the parasitic humble-bees, now included in the genus *Psithyrus*, said:—

“The females and neuters of these insects, it is probable, do not, like the rest of the *Bombinatrices*, carry masses of wrought pollen upon their hind-legs, or they would have been furnished with a corbicula for that purpose; from the absence of the pecten of the posterior tibia, and of the auricle at the base of the corbicula, which are usually concomitants of the corbicula, we may conjecture that these instruments, which are over against each other, are given to the insects which have them for the purpose of preparing their little masses of pollen; the pecten, which consists of strong bristles, probably breaking the grains, and the auricle assisting to knead them into a paste, previous to their being laid upon the tibia.” (“*Monographia Apum Angliae*,” 1802, vol. 1, page 210.) But Cheshire, in “*Bees and Bee-keeping*,” vol. 1, page 132, says that in the honey-bee the pollen is transferred from the metatarsal brush (or combs as he calls it) by the “metatarsus scraping its comb-face on the upper edge of the opposite tibia, in the direction from the base of the combs towards their tips. These upper hairs are nearly straight, and pass between the comb-teeth. The pollen as removed is caught by the bent-over hairs and secured. Each scrape adds to the mass, until the face of the joint is more than covered and the hairs just embrace the pellet.”

I have proved by experiment that the wax of the humble-bee exudes from between the dorsal segments of the abdomen, not as stated by Hoffer and others, from the ventral side, and that the wax is collected like pollen on the hind metatarsal brushes, but does not pass on to the corbicula.

Looking through the workers of several species of *Melipona* in my collection, I notice that although they possess a very wide corbicula and a pecten, the auricle is absent, and the metatarsi are extremely narrow at the base. Apparently therefore in these bees the pollen is not compressed, but is scraped on to the corbicula by the pecten in a loose state, and the corbicula bears a beautiful rack like a long-toothed comb to retain it. The shape of the metatarsus, however, suggests that the metatarsus may sometimes be bent up so

that its upper edge presses against the end of the tibia to form a pollen press.

In the solitary bees there is no corbicula, the pollen being conveyed on brushes situated either on the hind-legs or on the underside of the abdomen.

#### EXPLANATION OF DRAWINGS.

Figure 1. Hind-legs of queen of *Bombus terrestris*.

Figure 2. End view of hind tibia of *Bombus terrestris* queen, showing arch of hairs covering entrance to corbicula.

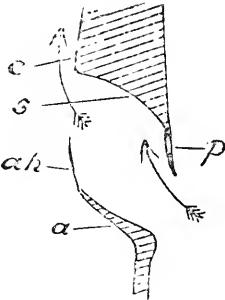

Fig. 4

*P*, comb or pecten.

*S*, socket of auricle.

*J*, juncture of the metatarsus with the tibia (this is a ball and socket joint, the socket in the tibia being here shown).

*F*, hollowed entrance of the corbicula, covered with fluff and bearing only three strong hairs.

Figure 3. End of tibia and base of metatarsus in hind-leg of worker honey-bee, outer side, showing the pollen press open and closed.

*P*, comb or pecten.

*A*, auricle.

*S*, socket of auricle.

*AH*, fringe of hairs on auricle for guiding pollen on to the corbicula.

Figure 4. Section through auricle and end of tibia in honey-bee worker.

*C*, surface of corbicula. Other lettering as in the other figures.

### HELPFUL HINTS FOR NOVICES.

By *W. Herrod*.

PROCURING SURPLUS.

(Continued from page 463.)

The removal of supers is the next operation, and probably the one which is faced with more mingled pleasure and dread than any other by the novice. This was excusable in days gone by, but the improvements in bee-keeping appliances have rendered the majority of manipula-

tions simple and expedient in the hands of the thoughtful and careful bee-keeper.

In the case of shallow-frame supers, the honey should be allowed to remain on the hive as long as possible to ripen thoroughly. "What do you mean by ripening honey?" asks the novice. Generally he is so anxious to take off his first surplus that he overlooks this important factor in the process of obtaining good saleable honey, that will keep for any length of time when properly stored. In passing, this is a matter often little understood even by bee-keepers of long standing. I have tasted honey over thirty years old that was as good in flavour and aroma as on the day it was taken off, simply because it was harvested and stored in a proper manner.

Honey, when first placed in the cells, contains an excessive amount of moisture, which, if allowed to remain, would eventually cause fermentation. This is evaporated by the heat generated by the bees, it condenses on the side of the hive and runs away at the entrance. To see this for yourself, go to a colony very early in the morning, when the honey-flow is at its height, and you will see the moisture coming away from the entrance. All the bees being at home at night, evaporation takes place quicker than at any other time. To facilitate this the bees change the honey from one cell to another, so that the heat can penetrate the liquid better, just as good wine is racked off into other bottles from time to time to mature it and get rid of the sediment.

In my last hints I said the empty super should always be placed underneath the full one to prevent over-crowding and swarming. Here we have another important reason why the partly-filled super should be lifted. Heat rises, therefore by lifting to the top it is placed in the warmest part of the hive, so that the honey ripens quicker.

When thoroughly ripe, and not until, except in very rare instances, the bees seal over the honey hermetically with cappings made of pure wax. If sealed before it is ripe, the same result occurs that would happen in the case of insufficiently boiled jam placed in jars and tied down; fermentation would take place, and the honey would be spoilt.

Tiering up of supers must be carried out with care and foresight, to avoid having a number of combs at the end of the season with a quantity of unsealed honey in them. By the exercise of a little trouble this can be avoided; in fact, in small apiaries there is no excuse at all for such a condition.



We will suppose, as an illustration, that the second super has been on for some little time, and that in it, as well as the upper one, there are combs complete and incomplete. Instead of putting on a third super, remove the top one, take out the incompleting combs and replace them with completed ones from the second super. Put all the unsealed and incomplete combs into the second super, when being next the bees they will be finished off, whereas if a third super were added the bees would commence working upon it, and if the honey-flow ceased before it was finished we should have a number of combs containing unsealed and unripe honey. The same would not be wasted, as it can be got into condition, but that entails a lot of extra work and trouble; also the honey is never so good as when ripened in the natural way by the bees.

The novice is, as a rule, anxious to do the best he can for his bees, and very often is over zealous. For instance, he reads that to prevent the bees from swarming a good plan is to cut out queen-cells, so he goes about every other day to the supered stock, removes the supers, and searches diligently for queen-cells. All this can be avoided to a very great extent if the first super is put on at the right time. Once let the bees get the desire to swarm by being cramped for room, and there will be difficulty in preventing swarming for a week or two, although the supers are in place. Let the bees alone as much as possible compatible with proper management, and they will thrive all the better for it. If it is considered necessary to remove queen-cells, (this can easily be ascertained by the bees crowding at the entrance, although everything possible has been done in the way of adding supers, giving ventilation, &c.); then examine the brood-nest and remove all queen-cells. The work should be done at mid-day, for the reason given previously. Place a board slanting from the entrance to the ground, as for hiving a swarm. Take out the combs one by one, and brush or shake the bees clear from each on to the board at the front; by so doing every queen-cell and commencement of cells can be seen at once and destroyed. I defy the most experienced bee-keeper to do this work thoroughly without removing the bees; if even the base of a queen-cell is missed the labour is in vain, as the bees will swarm as they intended. Should all quieten down the operation need not be repeated, but if at the end of about nine or ten days the bees crowd again at the entrance then make another examination.

(To be continued.)

## Correspondence.

*The Editors do not hold themselves responsible for the opinions expressed by correspondents. No notice will be taken of anonymous communications, and correspondents are requested to write on one side of the paper only and give their real names and addresses, not necessarily for publication, but as a guarantee of good faith. Illustrations should be drawn on separate pieces of paper. We do not undertake to return rejected communications.*

### BEE CULTURE IN KASHMIR.

[8313] Bees in Kashmir have many enemies to contend with, but they have one great advantage in the length of the warm season. Even when the night temperatures are below freezing point, in the daytime the semi-tropical sun shines warmly and enables bees to bring in pollen and honey from hardy plants, such as cosmea, helianthus, dahlias, mignonette, and sweet sultan. As late as the second week of November stores are still being brought in, although the amount is very limited. In the winter the cold is intense, the thermometer in January sometimes registering zero. Last winter I used sawdust for extra packing, and also covered in the hives with dry grass, put on slabs of candy in case of need, and then left the bees absolutely alone.

On March 6th the first crocuses were out, and it was amusing to see the race for pollen. The bees jostled and hustled each other as they struggled into the partially open blossoms. As they were so keen, I put flour in, and also distributed little saucers of it among the flower-beds, and these were soon emptied.

"To him that hath shall be given," is a truth verified by daily experience. Two outside swarms came to me—the first as early as March 25th, and the second on April 15th. As these were both small, I united them, and fed them well till the fruit-blossom appeared.

The spring in Kashmir is perfectly glorious. In addition to pears, apples, cherries, plums and quinces there are large numbers of peach trees with their masses of pink blossom, but owing to the great sun heat the fruit trees very soon cast off their gay robes and assume the more sober green garment of summer.

Swarming usually occurs in the last week of April or the first few days of May—earlier than in England—but by giving plenty of room and ventilation, three out of five of my hives gave off no swarms. Kashmir swarms are apt to be wild, and rising rapidly to dash off beyond all possibility of control. One which I caught and hived bolted on the second

day, as I had omitted to put "excluder" across the entrance to keep the queen at home. Outside two of the hives which did not swarm dead young queens were found.

Owing to the drought, hornets were very troublesome. The first was seen on April 22nd. From that time they steadily increased, and often as many as ten a day were killed. Strong hives are able to protect themselves, the bees massing on the alighting-board when the hornet comes near. If it tries to pick off a bee the others hang on, and running up, ball the hornet. I have seen this occur several times. Once the ball rolled off the alighting-board, and the colony constructed a rope of bees, on to which it hung like an attenuated swarm.

This year scrupulous insulation of the hives in water completely protected them from the depredations of ants, except in one case, where some ardent red ones walked over the dead bodies of their drowned comrades. Should, however, any bee be guilty of indiscretion or excess, and come back too late, or drink too much nectar or honey, the ants always formed an avenging Nemesis, and it was often a horrid sight to see them attacking living victims which had fallen on to the ground.

The time for the honey harvest in Kashmir is at the beginning of October. This year I attained the ideal of the small amateur, with four or five hives, and obtained enough honey for the consumption of my own household and for sale to friends. Although shallow frames were well filled, once more I failed to get bees to go up into sections, through the colonies not being strong enough. The Kashmir bee appears to be somewhat smaller than the English variety. Possibly, as a consequence, I was much troubled by their inveterate habit of building cross brace-combs. There is also great uncertainty as to whether comb foundation will be properly drawn out. In some cases they have constructed parallel combs between two sheets of foundation, in others they have built their own combs on to the foundation, but left the latter intact and of full thickness. This year the honey was so dense that it was difficult to empty the combs with the extractor.

Of enemies, wax moth is the most persistent; some of the grubs were two inches long, so it appears to be a larger breed than the British.

Owing to the warm autumn days I have found that November is the best month for doing the final feed up with warm syrup. This year I have also left an extra supply of honey in two of the hives with a view to obtaining really strong colonies next year. So far I have been unable to import foreign queens, which

I regret, as, judging from the general similarity of climate, Ligurians ought to do well. The great gentleness of Kashmir bees is noteworthy. When they are having supplies of artificial food you can handle them with impunity, subduers of any kind being rarely necessary. The workers appear to be somewhat smaller than English bees.—ERNEST F. NEVE, Kashmir.

#### A GOOD "TAKE."

[8314] It was a swarm late in the spring of 1910 which settled on an old apple-tree in the vicarage garden at Waterstock, Oxfordshire. It is always the unexpected which has such a perverse way of happening, and therefore, of course, nothing was ready for the due and worthy reception of the humming crowd, and to fetch a hive from the nearest town—Oxford—eight miles away, meant possibly that the "Spirit of the Hive," as Maeterlinck loves to call it, would have incited the restless crowd to seek other pastures; therefore an old box standing by was requisitioned for the moment, the resolve being that a new hive should be procured on the morrow. But, alas! that morrow never came. Prevented by the myriad demands of a country cure of souls, it was a week before the newly "boxed" swarm could have attention, and then it was found that so rapidly had they proceeded with the furnishing and fitting of their home, that it were a shame to disturb their labour. Box and bees were placed on the top of the new hive, which had at length arrived, hoping that they would work out the frames below. But again another trouble arose. Frame-hives measure, as we know, about 16in. over all in length, but our box measured 21in. in length; slates therefore had to be requisitioned to ledge on the top of the frames, and to extend under the overlapping box. Thus packed and fortified they went to "bee-bye" during the last winter.

In the spring of this year of grace the expert on his tour suggested that it would be a saving of time and trouble to drive the bees, cut out the combs, and tie them into the empty bars of a frame-hive, which was done. As, however, there were more combs with brood than could be utilised below, it was resolved to place the box on the hive again with excluder zinc beneath it, and after due time allowed for hatching the remaining larvæ, to replace the box with the usual racks of sections, or shallow frames. But "man proposes and bees dispose"—at any rate they did in this instance. They were insects of character, had a determined will of their own, and were not to be confined 'twixt straitened walls. So in their thousands they teemed up into the space

above. Nectar in the fields was abundant, of space there was ample, and the workers were willing. What wonder, then, that the work went right merrily on. The interior measured 20in. by 13in. by 13in. One wonders how the pliant wax could bear the weight. There were two perfectly straight built combs of these dimensions each measuring 260 square inches, or the two together 520 cubic inches. It was not possible to measure the other combs; they were irregularly built, as we know they often are, but every possible inch was filled, and the contents being weighed struck the beam at 103lb.

vicious lot of bees using their lancets remorselessly, you, too, would have been glad to place it gently and safely on its side and trust to Providence. Nor is it "professional" for an expert to wear a veil. But if the bees, scorning the power of the human eye, find a delight in going for that same organ, or the nose, being prominent, and getting there, I commend his discretion as being the better part of valour.

Of the driving of those bees from the box and the cutting out of the combs the expert writes nothing. Those who have essayed a similar task, when the bees will



BEEES IN A BOX.

It would have been a pity not to have preserved a photographic record of such a "take," and therefore the Rev. E. C. Spicer, the fortunate owner of the hive, brought the camera into action. Now I know that critics will at once say, "What a very stupid fellow that expert was to turn the box on its side. Why did he not place the box so that the combs hung perpendicular?" Perfectly true, my dear critics, but if you had a box filled with honey weighing nearly one hundred-weight and a quarter on the top of a frame-hive threatening to topple over from head-weight, and in addition a remarkably

stick in the farthest corner and the combs begin to break, know the delights of the work. It sufficeth that it was managed to the satisfaction it is believed of all concerned. One is tempted to quote the Persian proverb:

"Lick up the honey and ask no questions." (*Maqamat of Heriri.*)

Now, from experiences such as these much wisdom may be drawn, and what are the special moral lessons here inculcated? First, always in swarming time (this lesson is for bee-keepers) have your hives ready for your bees. Don't let your bees have to

wait for the hive. The possibilities are that if the hive had been ready in this instance the take would have been many pounds heavier. Second (this is for anyone), never put off until to-morrow what you can do to-day. You may have a fixed and firm intention when you retire to rest to be up and doing early in the morning. However, we are told that a certain broad road leading to a place not often mentioned in good society is paved with good intentions, but as it is not within the memory of man that anyone who has travelled on that way has ever returned we have no confirmation of this legend. It is "not proven." A bee-keeper also might have made a third deduction, viz., "What a grand queen there must have been! Why not raise other queens from her?"—J. SMALLWOOD.

### HAMPSHIRE NOTES.

#### "ISLE OF WIGHT" DISEASE.

[8315] It is now some time since I sent any communication to the "B.B.J.," not since the above disease has made its appearance in England (at least in its present form), and though not wishing to unduly trespass on your valuable space, I should like to give a brief account of its peculiarities as experienced by myself.

My trouble began in the autumn of 1910, some few colonies being at that time entirely destroyed, and then in the spring of 1911 colonies went under very rapidly, until I had lost thirty odd stocks. In the beginning of the month of May I still had about a dozen lots affected, which I certainly had no hope of saving, but, to my surprise, towards the end of the month I noticed a marked improvement, and one by one those affected colonies seemed to quite recover: early in June they began to increase in strength very rapidly, and before the end of the month almost all had supers on. I naturally attributed such a wonderful change to the weather, the like of which we had not experienced for many years, and I really began to hope that such a glorious change had *killed the disease*. But I have now something else to tell, for at the first appearance of dull weather the disease began to reappear, and to-day it is rapidly spreading in all directions in a more malignant form than hitherto, being much more rapid in its destructive work, though the first symptoms are exactly the same. In connection with this disease there is one thing I particularly wish to mention, namely, the uncertainty of the extent and nature of the contagion. For instance, there is a doubt in my mind if combs are contagious, and if combs are not, hives are not, and if such a supposition should prove to be true much of our trouble and loss

ceases. If I state the following facts it will be seen why I have strong doubts as to the infectious nature of combs. Two swarms (quite by accident) took possession of hives and combs in which the bees had been killed by "I.O.W." disease. Both hives were supposed to be bee-proof, but in one instance the swarm found its way through the cone escape in the roof, which had been forgotten. When it was discovered that swarms had taken possession of these hives they were given up as lost, much to the sorrow of the owner. Day by day they were anxiously watched, but up to the present moment there is not a trace of disease. Now, I can vouch for the absolute truth of the above statement, for I am the owner of those swarms, and even should disease break out with them now, there would still be no proof that the combs are contagious, because of the fact that it is not only those colonies which were diseased in the spring that are showing it now, but others which were perfectly healthy, and also swarms of this year. There is just one other noticeable feature which I must mention before I finish these notes. Sugar-feeding has been suggested as a cause of this disease, but, strange as it may seem, those colonies sugar-fed (sugar only) have been in several cases to my knowledge the only ones to escape. I have always gone in very strongly for natural stores, and the above facts will not alter my conviction as to the advantage of these in a general way; yet facts are facts, and I am *certain* that sugar-fed colonies withstand the disease, if not entirely, to a very great extent, and I feel equally certain that pollen has not so much to do with the complaint as honey itself. Though in the early days I thought it was set up by pollen, I now feel certain that to search for the cause along this line will be utter waste of time. Not that I wish to imply that either honey or pollen is actually the *cause* of disease, but that the disease (of whatever nature it may be) seems to find a better medium in honey than in syrup, and that the well-known "clog" is not caused by masses of pollen. I must apologise for the length of this letter, but I trust it will be of some interest, if not of any help in solving the problems of this mysterious malady.—O. BROWNING, Hants.

### A GOOD BEE-PLANT.

[8316] As an old bee-keeper who keeps fairly up to date in bee lore, I do not remember reading anything about the shrub *Buddleia Globosa* as being useful to the bees. I have had one bush in my garden for several years, and it is a pleasant sight when in flower to see three or four bees working upon each ball of blossom. The flower consists of three, four, or five round

orange-coloured balls upon a stem; the balls or globes are a mass of V-shaped cups from which the bees gather the nectar. The flowers have a peculiar smell of wax (slightly), which most bee-keepers are familiar with. I would like to know if other bee-keepers have observations in any way corresponding with mine. There are other species, I believe.—J. BROWN, Polyphaet, Launceston.

### BEDFORD B.K.A.

#### LECTURE AT BEDFORD.

It is not often that the busy human bees that swarm in the street on Saturday afternoons can furnish many of their number to hear an educational lecture, but on the occasion of a lecture given by Mr. W. Herrod, F.E.S., Secretary to the British Bee-keepers' Association, the gathering was large and representative of town and country. It was a lecture which illustrated the best uses of the kinema as a means of making quite familiar the ways of the provident insect, and some phases of bee management that many people might never come into practical contact with in the course of a lifetime and which the more timid ones would be quite content to read about in Maeterlinck. The lecture, which was held on Saturday, November 28th, at the Modern School Hall, Bedford, was given under the auspices of the Bedford Bee-keepers' Association by arrangement with the County Education Committee.

Mr. H. Trustram Eve, President of the Association, was in the chair. He congratulated Mrs. Hemsley, the Hon. Secretary of the Association, upon having originated this excellent idea of having a meeting to hear Mr. Herrod and to see Mr. J. Bee Mason's beautiful pictures of bee-life, and upon the very encouraging attendance of her friends.

Mr. Herrod first showed a number of lantern views, and said the kinema pictures to follow were now shown for the first time before an Association out of London. Bee-keeping was suitable for both sexes, especially in these days when ladies are taking up so much work which has been the privilege of men, and it was a subject which both practically and theoretically would appeal to the ladies.

In New Zealand and the Orange Free State the Government apiculturists were women. People who lived in the country thought they knew a great deal about it, but he once came across a man who had been keeping bees for forty years, and never saw a queen bee till he (Mr. Herrod) showed him one. Inexpensive text-books could be obtained, and a good deal learnt by reading, but there were

people who did not believe in "book-learning," and no doubt a good deal of knowledge could be picked up by practice, only they might spend a life-time in doing it, and have to leave off when their education was getting fairly advanced. Mr. Herrod also touched upon the physiology and practical work of this wonderful insect, and concluded his interesting address by showing the value of bees in pollinating the flowers of fruit trees, and so promoting the production of fruit.

Mr. J. Bee Mason then exhibited his kinema pictures of bee life. Very amusing it was to watch the young bees wriggling out of their cells and shaking themselves as they walked off. The birth and acceptance of the young queen was witnessed, and the ignominious ejection of the rejected one. The disablement and casting-out of the drones, the building of the comb, the capture of the swarm, the search for a truant swarm, the living and settlement in a new home, the capture of a swarm and a store of honey in a beer-barrel were among the wonderful living pictures shown. Instruction of great practical value was conveyed by the pictures illustrative of bee management, the preparation of sections, the extraction of honey by centrifugal force, &c. They were marvellous pictures of the inner history and intimate life of the bee.

In answer to questions, Mr. Herrod said the temperature of the hive is raised by the bees eating more food, and lowered by the fanning of their wings. Cross-bred bees are cross and not nice to handle, but they are prolific and good workers. Pure cane sugar syrup is used for feeding in winter.

The Chairman said they had had a delightful hour, and thanked the lecturer and Mr. Bee Mason for his pictures; also Mr. Kaye for kindly lending the hall.—*Communicated.*

## Queries and Replies.

[8263] *Artificial Increase.*—I should like your opinion as to whether the following plan would be successful:—  
(1) I propose to divide a hive with an excluder zinc dummy, make a small entrance at one end, and then put two frames of honey and brood, with a ripe queen cell on it, in that end. When the new queen becomes fertilised I should remove the old queen and the dummy. Would a perforated wooden dummy be

better than the zinc, and if a section rack is on could both lots work in it? When the dummy is removed, should I dust the bees with flour? (2) If I have a nucleus colony, and want to unite it to another, would I have to cage the queen, or just dust the bees with flour after killing one of the queens? I have only been a bee-keeper for two years, and I started on my own when seventeen years old.—P. WILSON.

REPLY.—(1) You could work in this way, and as the bees would all have the same scent there would be no need to flour them. (2) Yes. Cage the queen for at least twelve hours, in addition to dusting the bees as you suggest.

[8264] *Various Queries*.—I shall be much obliged if you will give me a little light in your valuable paper on the following questions:—(1) Is it possible for a queen to be mated in captivity, *i.e.*, without letting her go on her first flight? (2) Would you advise oilcloth as a sheet or quilt? It seems to me to prevent all ventilation and to collect moisture through evaporation. (3) An empty hive (but fitted with eight combs of brood foundation) was taken possession of by a swarm this summer. The next morning, when complimenting myself on my luck, I found it had decamped again. The hive is a good W.B.C., and has been used for many years past. What could have been the reason of this desertion? Hoping that that most useful and instructive chapter "Hints to Beginners" may continue.—LANCASTRIAN BEE.

REPLY.—(1) No. It is quite impossible. (2) You are quite right; oilcloth should on no account be used as it collects damp, which is fatal to the well-being of the colony. Use calico or ticking, then about three pieces of some warm felty material. (3) Swarms will very often develop this trait of restlessness. To prevent them absconding it is advisable to put into the hive a comb of unsealed brood. We are pleased that you find "Helpful Hints" so useful.

[8265] *Dealing with Granulated Sections*.—I shall be grateful if, through the medium of the "B.B.J.," which is a weekly help to me, you could advise me in the following difficulty. I have some sections, which, in spite of their having been stored in a suitable place, have become granulated. As they are now, of course, unfit for sale, I should be pleased if you could tell me how I can reliquely and extract the honey from the wax.—J. STEELE.

REPLY.—Cut the sections out, place them in an earthenware vessel, stand it in water, and heat until the wax just melts. Allow the mass to stand until cold; you will then be able to lift off the wax and strain the honey.

## WEATHER REPORT.

WESTBOURNE, SUSSEX.

November, 1911.

Rainfall, 5.41 in.	Minimum on Grass 22° on 22nd.
Above Average 2.39 in.	Frosty nights, 9.
Heaviest fall, 1.10 on 11th.	Mean maximum, 49.9.
Rain fell on 20 days.	Mean minimum, 36.8
Sunshine, 53.7 hrs.	Mean temperature, 43.3.
Below aver., 14.9 hrs.	Above average, 0.1
Brightest day, 1st. 5.9 hours.	Maximum barometer, 30.339 on 30th.
Sunless Days, 7	Minimum barometer, 28.837 on 18th.
Maximum temperature, 58° on 4th.	L.B. Birkett.
Minimum temperature, 27° on 11th	

## Notices to Correspondents

*Suspected Disease.*

E. A. B. (Hants).—(1) The bees have "Isle of Wight" disease. (2) It is quite possible that the germs have lain dormant for that time.

NOVICE (Dudley).—We are much afraid that the trouble is "Isle of Wight" disease.

A. G. C. (Surrey).—The bees show every sign of "Isle of Wight" disease. The queen was amongst the bees sent. We should not advise you to use the honey, you had better destroy everything in the hive.

R. W. R. (Ripon).—There is every appearance of "Isle of Wight" disease about the bees you send.

## Special Prepaid Advertisements.

**Two Words One Penny, minimum Sixpence.**  
Orders for three or more consecutive insertions entitle advertisers to one insertion in "The Beekeepers' Record" free of charge.

Trade advertisements of Bees, Honey, Queens, and Bee goods are not admissible at above rate, but will be inserted at 1d. per word as "Business" Announcements, immediately under the Private Advertisements. Advertisements of Hive-manufacturers can only be inserted at a minimum charge of 3s. per ½ in., or 5s. per inch.

## PRIVATE ADVERTISEMENTS.

**WANTED**, 28lb. Beeswax; state lowest price.—ORAM, Lark Hill, Worcester. r 42

**WHAT OFFERS**, four 28lb. tins Granulated Dark Honey; no reasonable offer refused.—C. J. ELLETT, Second Lodge, Shefford, Beds. r 43

**SCOTCH HEATHER HONEY** FOR SALE, 200 sections, splendid quality.—CRUICKSHANK, Edin-road, Gordon, Berwickshire. r 44

**LIGHT ENGLISH HONEY**, 28lb. tins, 55s., 60s.; sample, 2d.—W. H. STOPPARD, Tiptree, Essex. r 45

**12 DOZEN** First-class Sections; what offers?—WILTSHIRE, Potterne Wick, Devizes, Wilts. r 46

**FOR SALE**, 4cwt. finest Hampshire Honey, 20lb. Beeswax.—PRITCHARD, New-street, Stockbridge. r 47

**BEEES**, five strong stocks, 1911, Italian Queens, in frame hives, 15s. each, or offers; must sell.—8, Orchard-road, Colchester. r 48

## Editorial, Notices, &c.

### CHRISTMAS.

Christmas Day, the great day of the reunion of families, will have come and gone before our next issue. Therefore we wish that Joy and Happiness may reign supreme in every home into which our Journal enters, and that the coming season may be as good as the one just passed.

### ANDOVER AND DISTRICT B.K.A.

A large attendance of members of the above association and the general public assembled in the Town Hall, Andover, on Saturday, 25th November, to discuss the question as to what steps were being taken to obtain proper legislation for bee diseases. Mr. E. C. R. White presided, and as no information was available at the moment from the B.B.K.A. (their Bill being *sub judice*), is was resolved that Mr. Tickner Edwardes's Bee Diseases Bill published lately in the "Smallholder" should be taken as a basis for discussion. The majority of those at the meeting were of the opinion that the Bill, taken *en bloc*, was a very good one, but that certain amendments were necessary.

Mr. Pinder (Hon. Sec. Wilts B.K.A.) said that in his opinion the Bill was too drastic, and conferred too much power upon those appointed as officials, thereby interfering with the liberty of the subject. Legislation bee-keepers certainly wanted, and that badly, but we should be careful not to get an "over-dose" of it.

A resolution was then passed that the B.B.K.A. be written to, and the resolution of this meeting given to the parent association, viz.:—"That this meeting calls upon the parent association to do their utmost to bring to a satisfactory position the Bill which is now in its hands without delay, "Isle of Wight" disease being still rampant in this county."

The joint secretaries of the association, Messrs. E. L. and H. C. Jones, tendered their resignation, as they are shortly leaving for New Zealand, and proposed that Mr. N. A. Allen be asked to take up the duties *pro tem*. Mr. Allen accepted, promising to do his best to make the association a real live business affair, and on the vote being taken Mr. Allen was elected unanimously.

A vote of thanks was proposed by Mr. T. Norridge to the retiring secretaries for their past services, which was carried unanimously.—N. A. ALLEN, Hon. Sec. (*pro tem*).

### AMONG THE BEES.

By D. M. Macdonald, Banff.

*Queen Mating Stations.*—The idea is not a new one. Some years ago the late Mr. Weston, with an energy all his own, went heartily in for the provision of such centres. He proposed that here and there all over the country apiaries should be provided in situations where pure mating should be secured. The very choicest drones would be bred there, and bee-keepers, for a small fee I presume, could forward their selected virgin queens for mating. On their safe return, these high-bred and choicely-mated mothers would be placed at the head of their best stocks. In course of time, every colony would have such a queen mother at its head. The anticipation was, of course, that more bees would be bred in such a hive, stronger battalions would go out foraging, and heavier takes of surplus honey would result. At present the choice of sire, even in our best regulated apiaries, is very much a rule of thumb, or a matter of the merest chance. Hence scrub stock results. Bees too often are simply mongrels, frequently of the most undesirable strains, weak in body, short-lived, waspish in temper, and defective in sealing; given to heavy propolis, and poor honey-gatherers, poor winterers and poor breeders. Switzerland already has such mating stations, and good results are reported. I do not know any better purpose to which part of the Development Grant could be assigned than to some such scheme which would secure us *better bees*. Can this not yet be arranged?

*Defective Sections.*—In a good many cases these were very noticeable this season, and I was frequently asked, why? In some instances, I believe, if the history of the sections could be traced from the time they had been placed in the racks, the secret would be revealed. They were allowed to lie about at all angles, in all temperatures, many of them a whole year, some of them two. One bee-keeper owned that some of his had stood on their *sides* the whole winter. Foundation in this case could not but be at an angle. Hence bees built it out so. Most of the sections would be connected with the dividers, producing brace-combs, free attachment, and consequently there would result bleeding honey and unsaleable sections. The slant in the saw-cut has a tendency to throw the full sheet out of the perpendicular unless fair pressure is brought to bear on the foundation at the time of fixing in to counteract the slant. Dividers, too, when left lying about, are apt to twist and buckle. Defective sections naturally follow the use of such between rows. Some racks are a sharp 12 $\frac{3}{4}$ in. across, thus compelling

dividers to be forced in. This twists metal dividers out of the straight, resulting in a thick and thin section on either side of such a malformed division between rows. If sections are not wedged tightly in the filled rack, irregular spacing will cause defective sections. Many blame the bees or the appliances for defects which are potently due to their own carelessness.

*"Decorating" Prize Wax.*—Certain colours blend well together. Others, by contrast, secure harmony. I feel that a bright shade of wax, such as our prize-takers delight to obtain, does not harmonise well with a vivid green. Some competitors in such a leading show as the Grocers' did themselves an injustice by the juxtaposition of such unassimilable colours. I was at first coming away with the impression that the judge had committed an error of judgment in assigning the sample so high a place, but fortunately was given an opportunity of seeing the cake in its purity, apart from its "adornments," and it proved a model sample in every way. "Nature unadorned is adorned the most!" and I felt the same sentiment was applicable in this instance. The colour of the cake, when it stood by itself, was not the same by very many degrees compared with what it showed in its fancy surroundings. Honey, too, is very much improved or deteriorated, as far as looks are concerned, by an uncongenial surrounding or backing. I have a recollection of a case of beautiful extracted clover honey at a local show being thus much injured in its effective display—and I have no doubt in its ready sale as well. It gave an altogether untrue and distorted idea of the genuine appearance of the product. Great care should also be taken that section cases should harmonise with the sample shown on the show bench.

*A Frame Hive.*—I am not about to describe this well-known home of the bees, but I should like to call attention to a very common error in the use of the name. I bar the bar! The employment of the word is a "superfluity of naughtiness." Why not as well call it a side-bar frame, or a lower-bar frame, or a top-bar frame. Either would be as appropriate as the other. Why think of the top-bar at all? It is simply a frame; only that and nothing more, and the introduction of the word "bar" is a redundancy. It is a clumsy term for a simple and well-known part of a hive. Then the designation appears so frequently that really it takes up a considerable amount of printer's ink, which is literally thrown away. In the aggregate, although the word is so small a one, it occupies a large space in our pages during a year's time which might well be spared

for other and more useful words! Might I plead with our writers to eliminate it from their manuscripts; with the editor to blue-pencil it when used; with the "reader" to erase it when he spies it! I hope it will not appear in our New Year's volume. It is a dirty little word at best. I read of the "bar" of the police-court. I know of it only from hearsay! Then there is a "bar" which no good bee-keeper, according to Butler, should have any acquaintance with. But I must draw up or the word will get on my nerves!

---

#### DEATH OF MR. C. DUNN GARDNER.

The sad news has reached us just as we are going to press of the death of Mr. Cyril Dunn Gardner, of Fordham Abbey, Cambridgeshire. Mr. Dunn Gardner was one of the most extensive bee-keepers in this country, being especially successful in the production of extracted honey. As a member of the British Bee-keepers' Association, he took a keen interest in bee-keeping and his loss in the prime of life will be regretted by all. We are sure all our readers will join us in tendering our deepest sympathy to his sorrowing family.

---

## Correspondence.

---

*The Editors do not hold themselves responsible for the opinions expressed by correspondents. No notice will be taken of anonymous communications, and correspondents are requested to write on one side of the paper only and give their real names and addresses, not necessarily for publication, but as a guarantee of good faith. Illustrations should be drawn on separate pieces of paper. We do not undertake to return rejected communications.*

---

#### BEE-DISEASES LEGISLATION.

[8317] Mr. Woodley's remarks in "B.B.J." for Dec. 7: (p. 486) are, I think, liable to create a false impression as to the nature of the petition to the Board of Agriculture which the "Smallholder" has for some time past been putting forward amongst its readers. The petition does not, as Mr. Woodley states, ask for the abolition of the straw-skep, nor does it advocate any particular measure whatever. It merely records the opinion of its signatories on the general question of the need for legislative control in cases of bee-disease, and for State promotion of sanitary methods in apiculture; and as such I am sure it cannot but meet with your own approval, as well as that of most of your readers.



The petition is quite distinct from the Apiaries Regulation Bill advocated by me in the same journal, and characterised by your valued contributor and our common friend, Mr. Woodley, as a new "terror" to bee-keepers. You have already allowed me to lay before readers of the "B.B.J." my views on the legislation question, and I do not here propose to re-traverse the ground already covered. But I should like to ask our professional apiarists, large and small—and particularly those who are opposing legislation in any form—whether they quite realise what developments the near future may, possibly and probably, have in store—developments which may fundamentally affect home honey-production.

We are all at one in our desire to lessen, and, if possible, stamp out bee-diseases; but this is not an end in itself: it is only the means to an end. A really effective bee-diseases Act will result, most of us believe, in a large reduction in cases of disease throughout the country, with a corresponding saving in bee-life. Stocks that would otherwise have perished will remain in the land to increase and multiply. The principal object, therefore, and indeed the inevitable result of a good bee-law, will be the production of a greater honey-harvest everywhere; and each year will see us better able to cope with the home demand for prime British honey.

So far, so good. And now I recommend for the earnest perusal and consideration of our professional bee-keepers the following extract from a recent issue of the "New Zealand Canterbury Times":—

"Perhaps the most interesting item of bee-keeping news at the present moment is that referring to the proposed establishment of one or more depôts in Britain for the putting up and sale of New Zealand honey. . . . British bee-keepers cannot raise enough to supply the needs of Britain's markets. . . . The Waikato (New Zealand) Bee-keepers' Association alone has guaranteed to the Government an export supply of thirty-five tons of honey annually from April, 1912; and I really see no reason why, if taken energetically in hand by all N.Z. Bee-keepers' Associations and the season proves an average one, a hundred tons of first-class honey could not be made available for shipment in bulk by April next."

The meaning of all this is plain. While, for the last fifteen years, the more wide-awake among British bee-keepers have been agitating for Government help in the control of disease and for the State promulgation of scientific methods in bee-keeping, and nothing has been done, New Zealand has been quietly going ahead. For four or five years back the Dominion has possessed the most enlightened bee-diseases prevention Act in the world, and during

that time we know that the hive produce of the country has doubled itself. Now it looks as if it is to reap the reward of its progressive energy at the expense of our home producers. British honey farming, so long unfostered and unprotected by the State, is seemingly face to face with a crisis such as it has never yet encountered. Colonial honey is no novelty here, and hitherto we have easily beaten all comers on the point of quality alone. New Zealand honey, however, is a vastly different thing. No one who examined and tasted the magnificent collection of samples staged at the late "Japanese" Exhibition could be in two minds on the matter. But a hundred tons of such honey, and that only as a first contribution! No wonder some of us take a gloomy view of the prospects of British apiculture, believing that it will go the way of many another of our important minor industries unless a stringent Act is passed.

In conclusion, I trust you will allow me to acknowledge here the courteous criticism of Mr. Crawshaw in "B.B.J.," November 23rd, as to my action in bringing forward what he feels compelled to regard as an opposition measure to that of the B.B.K.A. I venture to hope, whatever may be the views of readers on the merits of my proposals, no one will credit me with any other motive than a sincere desire to see the honey industry of this country placed on a sound commercial footing. But is there any question of clashing Bills? Surely there can be only one Bill, and that the Bill eventually prepared by the Board of Agriculture, after hearing all representations.—TICKNER EDWARDS.

[Our correspondent has overlooked the fact that the letter accompanying the petition asks for "support in bringing about the passing of a Bee (Prevention of Diseases) Act as drafted in the 'Small-holder,' and in the first clause of this it is distinctly stated that its object is the abolition of the skep. The exact wording is "Keeping of bees in anything but movable comb hives prohibited. Abolition of old skeps, box-hives, and the like to be complete in one year from date when the Act comes into force." We therefore cannot see how the petition can be dissociated from the proposed Bill, and the signing of the former would be a pledge of support of the latter.—EDS.]

#### WHY I ADVOCATE BEE-KEEPING.

[8318] I have often been asked at shows and various bee-keepers' meetings why I am always on the look-out for recruits to commence bee-keeping, when as my enquirers avow there are already too many

bee-keepers, and the result is that few of us can get a large take from our hives. I invariably reply to my enquirers that their fears are unfounded, and ask them to take a more unselfish view of the hobby and see if there is not something besides honey to be gained by keeping bees.

In the first place I advocate bee-keeping because of its levelling influence; notice a meeting of bee-keepers, and you will see bankers, doctors, and labourers all so interested in the hobby that their position in life is insignificant and they all become friends, aye, and fast friends. Of course,

the very fields look different to him, in fact he discovers beauty in things which he would not have had the patience to look at before his bee-keeping days, and he makes, as I have said before, friends; in short, he becomes a different man altogether, and finds life is really worth living. There is another point which commends itself to me, and that is that bee-keeping is an outdoor pursuit, and the person who has to follow an indoor occupation will derive much pleasure and benefit from the hobby because it is carried on in the open-air. Even when no manipulations are to be carried out, the bee-keeper can sit for



MR. M. J. STEVENSON.

I admit that amongst all fanciers to a certain extent this spirit is noticeable, but in bee-keeping it is most pronounced, and on this score alone, the hobby is to be greatly commended. Then again, I advocate bee-keeping because of its educational value. Persuade one of the roughest labouring men (as I have done and love to do) to keep bees, and you will begin to notice a change come over him; inoculate him with what we call "bee fever," and he begins to see things which he had never observed before, he commences to study, he becomes interested in the flowers and

hours without ennui and watch the bees, while he might perhaps have been fast asleep having as it were a P.S.A. in the armchair. One might continue to enumerate the many benefits to be derived from bee-keeping, but I think that the foregoing are the principal ones, and to my mind are of far greater value than the honey obtained, although I admit that a little honey is acceptable at all times, but it is not the most important thing to be gained.—A. WAKERELL, Croydon.

(Correspondence continued on p. 506.)

## HOMES OF THE HONEY-BEE.

## APIARIES OF OUR READERS.

Mr. M. J. Stevenson, whose apiary we present this week, is not only the most extensive bee-keeper in Ireland, but has the unique distinction, with a neighbouring bee-keeper, of being the first offenders under the Irish Bee Diseases Act to be prosecuted for refusing to allow the inspector to examine their stocks. As the inspector in question, with more zeal than discretion, wished to do this during the height of the honey-flow when the hives were supered and working well, readers will sympathise with Mr. Stevenson and his

the paper was set fire to under the condemned skeps. After a few minutes I thought the bees would all be smothered, and went to lift up the skep, when to my surprise I found the combs and honey were falling down in the hole and only some of the bees were dead. I got a milk pan and put the combs of honey, and half-dead bees into it as best I could, but I shall always remember the good stinging I got. Till 1900 I had but little further experience of bees, but in that year I got a swarm, and the following spring this stock swarmed. I put the swarm into a C.D.B. hive, and in the autumn I sold what surplus honey it had gathered for £1 15s. 10d. I

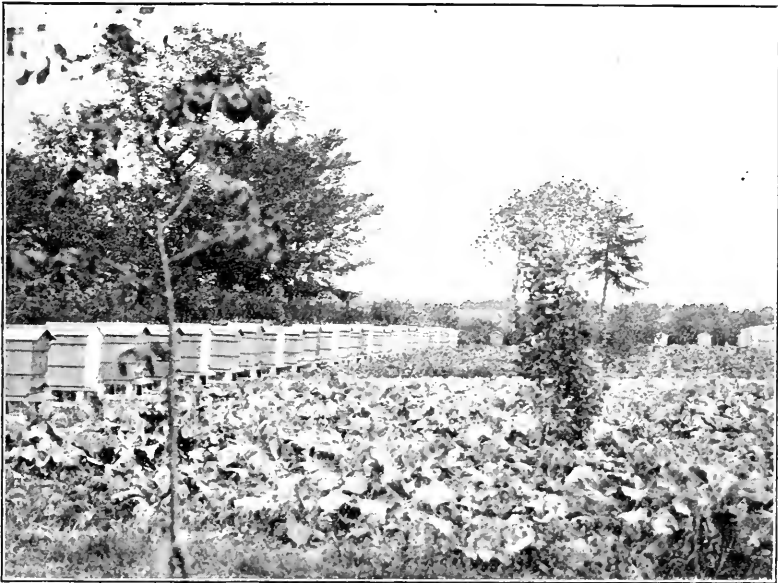

PART OF MR. STEVENSON'S APIARY, ADAMSTOWN, CO. WEXFORD, IRELAND.

neighbour, who, however, were merely fined a nominal sum, and told "not to do it again." In his interesting notes, our friend excites our envy by relating the substantial profit he has made from his bees, and we congratulate him on his success. Perhaps on some future occasion he may let us into the secret of how he does it. We certainly are not surprised at his considering bee-keeping a good paying business. Mr. Stevenson says:—

My first experience of bees was in 1887, when a great-aunt of mine told me to smother an old skep. She showed me how to make a large hole and put the brimstone on the paper; when I had done this

made up my mind that there was money in bees, and I bought eighty stocks in skeps. About this time I also bought about forty C.D.B. hives and drove the bees from every two skeps into one of these hives and fed them for the winter with the honey taken out of the skeps. I started the season of 1902 with forty-two stocks and have increased my apiary every year since. Up to the present time they have done and paid me well. In the season of 1910 I made a net profit of £152 17s. 2d. from ninety-nine stocks, and this season (1911) from one hundred and two I have made a net profit of £203 11s. 1d. Do you wonder that I consider bee-keeping, if well conducted on proper lines, the best paying business known?

(Correspondence continued from p. 504.)

### THE POLLEN-COLLECTING APPARATUS IN THE SOCIAL BEES.

[8319] In my paper on this subject, published in last week's BEE JOURNAL, the name *Bombus vuleratus* should read *Bombus ruderatus* and *B. lapidarius* should read *B. lapidarius*. A suitable name for the socket of the auricle in the end of the tibia would be the "receiver." I find that its surface is smooth and shining both in the honey-bee and in the humble-bee, but in the humble-bee the margin of it that borders on the entrance to the corbicula is striate, the little ridges and furrows running in the direction of the movement of the pollen.—  
F. W. L. SLADEN.

### FIGHTING FOUL BROOD.

#### NEED FOR LEGISLATION.

[8320] On page 486 of BEE JOURNAL for December 7th I read with feelings of dismay the letter from Mr. Woodley regarding the proposed legislation for bee diseases. After all that has been written in favour of such legislation and the numerous amendments introduced (with a view of conciliating opposition) into the recently recast Bill, I am at a loss to understand how any reasonable bee-keeper could write of it as a "new terror" and endeavour to stir up opposition against it.

With your permission I should like to put some of my experiences before your readers, and Mr. Woodley in particular, and afterwards to ask them and him if there is not an urgent need for something to be done. I have kept bees for the last fourteen years, my apiary ranging from twenty to thirty stocks. In 1904 I had two stocks affected with foul brood, and these I promptly destroyed, burning combs, quilts, and all movable material, afterwards scorching the inside of hives with a blow lamp. Since then I have annually destroyed by fire on an average five stocks from the same cause. No one could take greater precautions than I do to prevent the disease from spreading. I never open a hive without first washing my hands in a strong solution of Izal. I keep naphthaline in the hives summer and winter, clean and scorch all section racks and empty hives before use, and still the disease held sway.

I strongly suspected that the source of infection was in my own neighbourhood, two decaying apiaries being situated within a short distance of my own. I had mentioned my trouble to the owners of these apiaries, and asked if I might be allowed to have a look through the hives, but was met with a curt refusal, indicating that their bees were all right.

Driven to despair this spring by finding twelve colonies affected, I called on the owners and told them that if they would be kind enough to let me examine their hives I would replace with English swarms at my own expense any stocks which I found diseased, provided I was allowed to destroy them. The fairness of this offer overcame all scruples, and I proceeded to open the hives. I need hardly say that my suspicions were fully confirmed. One apiary of thirteen stocks had dwindled down to four hives containing live bees simply reeking with disease. The remaining hives contained combs in a deplorable condition, and being open were hotbeds of infection. The other apiary consisted of four hives, two of which were tenanted with dying and dwindling stocks rotten with disease, and two contained empty combs in a like condition.

I made a bonfire of the lot after sulphuring the few remaining bees, and the replacement cost me over £5. I may say that neither of these men knew that such a thing as foul brood existed, paid little or no attention to their bees, and when they died off, left the hives standing wide open, spreading death and destruction around. After clearing out these pest holes I destroyed the affected colonies of my own, and when I tell you that the fifteen healthy stocks left gave me 70 sections each, I leave it to your readers to estimate my loss. I might instance another case which came under my notice a few years ago. I assisted an old man with his bees and found that one stock had contracted foul brood. I counselled destruction at the time, but my advice was not heeded, with the result that every stock (ten) perished within two years. I was told by a party who happened to be passing his place that the rotten combs were lying exposed on the ground, and black with bees.

Is it any wonder that foul brood is rampant in the land? It seems to me to be nothing short of scandalous that I or anyone else seeking to augment a somewhat slender income by the delightful hobby of bee-keeping should thus have to suffer loss of capital without any means of redress, and yet when fellow sufferers have been goaded into action and try to get some sort of protection which will preserve their industry from extinction they are met with opposition from bee-keepers, who claim to be advanced and enlightened. It is maddening to think of the cruel injustice of it, and anyone who, out of pure arrant selfishness, because he has hitherto been immune from disease, tries to block this measure deserves to be boycotted by every right-thinking member of the craft.

I should like to ask Mr. Woodley, and I trust he will answer me with candour, how and by what means he or any bee-keeper can rid his apiary of foul brood if he is powerless to remove the source of infection from his neighbour's garden. One might as well disinfect every corner and crevice of a room in which a fever-stricken patient lay, and leave the bed untouched, and expect to be clear of infection, as expect to rid an apiary of foul brood while your neighbour leaves the polluted source untouched.

My experience is that only a very small percentage of bee-keepers, especially those living in rival districts, know anything about the habits of the bee or its diseases. They have never seen a Guide Book or read a manual of any description on bee-keeping, and it is from such that protection is needed if the industry is to exist and prosper.

An inspector would not only detect and destroy affected stocks, but he would educate the people in the management of their bees, so that they would know the disease and be able to notify an outbreak. The owners of large apiaries may safely be trusted to keep their own hives clean, and to obviate any hardship which might be entailed on them. I would certainly favour the inclusion of a clause exempting them from compulsory inspection if such would be the means of removing their objections and gaining their support to a measure which would confer the greatest possibly boon on bee-keepers in general.—SUFFERER, Inverness.

#### DRONE v. WORKER COMB.

[8321] In reply to Mr. Crawshaw's criticisms (page 487), I can only repeat what I said before: That for practical utility worker comb is the best. I do not understand what Mr. Crawshaw means by "sectional hives," or "surplus roofs."

I use shallow-frame drawn out worker combs in brood frames for driven bees, also skep combs with worker cells in them; and, as everyone knows, in the driven-bee season any spaces will be filled up with worker cells. There are—with me—no "transition cells." We could not substitute standard for shallow frame end-bars; the combs would break away from the top bars. Of course, I fill the standard frames with comb and fix it with melted wax, using duck-wing feathers as a "soldering" tool.

I do not find it the least bit "messy" to extract from skep-combs, and, with me, it is quite easy and effective to fit in the pieces in a brood frame without a single transition cell, let alone drone cells.

In reference to the heavy combs, I had

intended to say, or rather I meant transparent combs, for after extracting and bees cleaning them they weighed 8 to 10oz. each. There was not a sign of pollen or honey-dew in them. In fact, the honey was bulked, and the samples shown by me in the Grocers' Exhibition Selling Class, (for which I got two diplomas besides the only one for sections), were taken from the bulk. Mr. Crawshaw seems very unfortunate with his sections. I had less than one per cent. with brood in, and these were of the nature of brace comb with drone cells.

*Wooden Extractor* (page 488).—Mine holds about 120lb. below the gears, and, of course, the honey has to be run off when nearly at that point, and is lightly scraped out. The extractor is then left till again wanted, and being air-tight it always seems perfectly sweet. I always scald it out and leave for a few minutes, then run out the water and place in the full sunshine tilted so that the sun plays all over the inside. It is then again ready for use; I, too, have sometimes let the bees clean it out. It is this way with me: I happen to be a practical joiner, and the wood and gearing cost me 7s. or 8s., and my extractor appears to answer as well as a tin one costing 50s. It seems sounder and sweeter now than when made fourteen years ago.—A. HARRIS, Wavendon.

#### DECEMBER POLLEN GATHERING.

[8322] Sunday, December 3rd, was unusually bright and warm with little or no wind. Three of my four stocks were flying freely between 1 and 2.30 p.m. To my astonishment, the bees from one which I requeened at the end of August, and am wintering on seven frames, I observed to be bringing in bright yellow pollen in considerable quantities. I have mentioned the facts to several of my bee-keeping friends, and they are quite at a loss to give any explanation or to venture any suggestion as to the probable source from which the pollen was derived. The incident appears to be so unusual that it may interest readers of your journal.—H. P. PERKINS, Frogmore, nr. St. Albans.

#### RECOLLECTIONS OF AN OLD HAND.

By James A. Abbott.

(Continued from page 475.)

Perhaps an interesting part was the discovery of "open" driving. The old-fashioned way was to put the empty straw hive on the inverted full one, and wrap a towel round the joint. Of course we soon omitted the towel, and it was generally my part of the work to keep the two hives in proper position with my hands, knees, or any other way I liked. Boy-like, I got

impatient, and lifted up one side of the top skep to see if the bees were going up. Finding that more were running up on one side than another, I gradually lifted one side of the top skep till I saw the queen entering the skep with the bees. This seemed to settle the fate of the old-fashioned plan of driving, and the new "open" driving soon came into general use; and now the old way is never heard of. The new method was first shown publicly at the Crystal Palace Show before the British Bee-keepers' Association was inaugurated, and no doubt the interest it created helped considerably in the success of that very successful show. I generally adopted a position which I do not see copied now: perhaps it involved too great familiarity with the bees. The full hive was put on the ground, and the empty skep with its edge fastened by a skewer to it was held securely between the knees, which kept it free from vibration, and while in a stooping position I looked over the hive. This position had the advantage of giving the spectators a clear view of the whole operation, though the position was more suited to a youth than an older man. I was very cool-handed and somehow the bees never seemed to trouble to sting me as they would some people, particularly those with hot, moist hands. Then the wearing of a linen jacket made tightly fitting at the wrists was a great advantage, as the bees did not often get up my sleeves—a common nuisance with an ordinary coat. The ease with which these thin jackets were washed periodically, was a great advantage as the washing removed the smell of previous stings, which always annoys the bees. A point not generally understood is the great courage bees possess in defending their hives as compared with wasps. I remember once when on a boating holiday the ladies of the party being annoyed by wasps at dinner time, I determined on revenge, so clad in cricket flannels only, and without veil, gloves, or other appliances, I borrowed a spade and a bottle of paraffin oil from a lock-keeper. I poured a little paraffin in the nest either at the entrance or another hole made with a boat-hook, and set fire to it, and immediately dug out the nest and flattened the combs with blows of the spade. Although owing to my thin clothing I was vulnerable all over, I disposed of seven nests without a sting. I could not have done this with bees without suffering severely, and probably the first would have been the last. Though the bees that stung me would have lost their lives, they would not have died in vain. At the time of the first Crystal Palace Show the merits of skeps and bar-frame hives were strongly contested, and a great octagonal glass super was shown holding nearly a hundredweight of honey which was said to have been produced from

a small skep. One glass was broken and had been replaced by wood with a label on it stating that the glass was accidentally broken, but that all behind it was finest honeycomb. The judges, however, were not credulous folk, and wrenched off the board, when it was found that the thing contained a lot of brood, and was not a super at all, but a hive. It came out afterwards that to produce this monster "super" the bee-keeper had put into it the bees from about six hives, and a small skep underneath. Soon after this the introduction of sections did away with the big super, and it was left out of the prize list altogether. The biggest super my father ever got weighed 76lb., but this was during an exceptionally abundant glut of honey, and was all worked in eighteen days. I never remember honey being so easily gathered; even nucleus hives stored surplus. Anything put over the feed-hole of a skep was at once converted into a full super—feeding bottles, flower pots, and anything else the bees could fill. I never tasted better honey than some I got here in the middle of Dublin City, though this happened only once. Bees cannot as a rule be kept profitably in a large town. The various manufactories of sweets, &c., prove death-traps to them. I see some talk of open-air feeding. We once tried that extensively, but I strongly deprecate it. The bees lost so much in vitality in their struggle for the food, and their vain search for more that I am sure it did them more harm than good, so I simply repeat *Punch's* advice to those about to marry—"Don't!"

(To be continued.)

---

#### CAPPINGS OF COMB.

BY L. S. CRAWSHAW, NORTON, MALTON, YORKS.

*Utilising Driven Bees* (p. 416).—E. A. Millward advocates a practice I have tried and proved. Two driven lots will generally winter well in an ordinary hive. But why use Wells partitions? Possibly ventilation is better, but I have had good results without the perforations. I have just packed up the last of my hives in this way. Two five-frame nuclei were side by side, and until recently I had no hive for them. How to transfer without breaking the clusters? I placed a couple of end-bars thwartwise of the frames above the quilt, and ran fine screws through quilt, and all into each top-bar. I then lifted the combs bodily, and slipped them into the prepared hive, and placed this on the original site. No disturbance, no stings, and no loss of bees, in spite of the season.

*Source of "Isle of Wight" Disease* (p. 417).—This is a difficult question. One must sympathise with "Constant Reader."

Why should we not be told where disease was obtained? Mr. Beemaster says, "I have got 'Isle of Wight' disease. It is confined to a lot of bees purchased from — Hampshire." Is this not likely to do Hampshire bee-keepers generally more harm than if the exact place were communicated? Why the mystery? Surely the risk of action for damages is slight, and might be dealt with collectively, if we were more united. But in the interests of bee-keepers the truth should be available, or at the least the matter should be investigated by the local association.

*Medals for Meddlers* (p. 427).—To the old hand, glory is a strange attribute of a bee-sting. A glorious wound received in a hazardous undertaking! Surely none but a boy could see such compensation in such tribulation! This must be at once the terror and the attraction of the wasp's nest. Of such stuff are men (beemen) made!

*Fruition of the Drone* (p. 432).—I don't quite gather D.M.M.'s meaning here. When he says that an unfertilised egg has received no "fruition," does he mean that the resulting drone is impotent? If so, it is not generally believed. Or does he here advance the theory that the pleasure of laying is confined to female eggs?

*Position of the Egg* (p. 433).—Would it not be more correct to say that the egg is laid in a horizontal position? That is, considering the position of the cell in the hive, and not relative to the comb when removed for examination.

*Creating a Market* (p. 436).—This is a sound, sensible article. Many of us would like to know the answer to Mr. Wakerell's query, "Why make more bee-keepers, if it be difficult to sell honey?" One of the results would be to depress prices. This, however, may be in the interest of the community. But *should* it be difficult? Does it not rather depend upon the ability of the salesman? Some beemen have no difficulty in disposing of their crop at excellent prices. (See No. 8288, p. 437). But if their sales be large, they assuredly attend to quality and get-up of their produce, and hunt up their customers, either personally or by post. They do not merely sit at ease at home like gentlemen of England. Selling classes at shows help somewhat. I suggest that a card might be sent with each set of entry numbers, which could be returned to the secretary, and placed in front of the exhibit after the judging. Something like this: Name of show, judge, and date, and the legend, "This honey is the produce of ——— who will be glad to hear from you. Honey supplied direct to consumers."

*Facts about Bees* (p. 445).—Would 100 five-year-old bee-keepers collectively know as much as one who had kept bees continuously for 500 years? I trow rot.

Supposing, of course, that the old gentleman were in a sound intellectual state! Would there not be a large amount of overlapping of elementary knowledge in the former case? Apropos of Mr. Wetmore's interesting inquiry, I hope, if not prevented by legislation, to hive some swarms in new skeps to further his investigation.

*Tetrachloride of Carbon* (p. 461).—I shall certainly try this substance for preserving combs from waxmoth. I have a fumigating chamber (made by Mr. G. M. Saunders) to which I have fitted a removable comb-rack. It is a capital safe for stored and other combs during winter, and I usually put the whole of the surplus combs through once at least. I have always used bisulphide with great success. Every maggot dies the death. The new remedy may allow the chamber to be similarly used during summer for furs and other articles.

---

## Queries and Replies.

---

[8266] *Swarm-Catchers — Preventing Damp Hives*.—Would you kindly advise me on the two following matters? (1) I am hoping to move one hive soon to another garden half a mile away, and being very busy shall not be able to pay it very frequent visits. The owner of the garden also not being in residence often, I am in danger of losing possible swarms. Would it be wise to use a "Brice" swarm-catcher? Might it be put on in May and left on till August or September, and what is the cost of the article? The hive will be worked for sections. (2) On opening my hives a week or two ago after a heavy driving south rain I found that three of them were damp (the strongest colonies unfortunately). In two cases the damp had gone right through to the calico cover. I pulled the damp calico off very quickly and put a dry piece where needed. Did I do more harm than good? Will the fact of rain getting into a hive do great harm beyond lowering the temperature, which is bad enough? Yesterday we had another terrible rain, and I am afraid from its direction more wet will have got into the hives. I am quite unable to find out where the water enters, so can do nothing to prevent it. Will it be safe after heavy rains on a mild day to open the hives and put on dry covers? Will the lowered temperature prevent the queen laying early? Each hive is well packed with thick carpets, and I quite thought the bees were perfectly secure for the winter. Each stock has plenty of food as no frames were taken away, the smallest number of frames

in any hive being ten and the greatest number thirteen. The hives face full south without any protection. When last examined after heavy rain the wet places were in the corners of the hives, not in the centre, but after yesterday's rain I am afraid of what I shall find, as the wet came into our own house in a manner not before experienced. I hope I am not giving any trouble through asking so many questions. With many thanks in anticipation. —B.M. (Essex).

REPLY.—(1) Yes, you can put on a "Brice" swarm-catcher, but it would not be necessary to leave it on after the end of June. It can be obtained from Messrs. Jas Lee and Son, the price being 4s. (2) It is much better to remove the damp quilts than to allow them to remain. Certainly damp conditions will lower the vitality of the bees and prevent the queen laying as early or even as vigorously as she should do. It will be well to look round the plinths of the hive, and if openings are discovered use putty and paint when the wood is dry. It would also be an advantage to cover the roofs with calico. It is no trouble, but a pleasure to help our correspondents.

### WEATHER REPORT.

BARNWOOD, GLOUCESTER,

November, 1911.

Rainfall, 2.87 in. in 20 days.	Coldest night, 24.5, 21st.
Above average, .56in.	Mean temperature for month, 42.4, .6 of a degree below average.
Heaviest fall, .57 in., on 10th.	Number of days with sky completely overcast at 9 a.m. 9; ditto cloudless, 1.
Total to date, 16.01, as compared with 28.79 in. for the corresponding period of last year.	Percentage of cloud, 72.
Mean maximum temperature, 47.5; .5 of a degree above average.	Percentage of wind force, 32.
Warmest day, 59, 4th.	Prevailing direction N.E. and S.W.
Mean minimum temperature, 37.4, .6 of a degree below average.	Barometer highest, 30.3 on 29th., lowest, 28.8 on the 18th. Daily mean, 29.73, below average; .09 each reading reduced to Sea-Level.
Relative humidity or percentage of moisture in the air at 9 a.m. 81.	

F. H. Fowler (F. R. Met. Soc.).

### Notices to Correspondents.

C. M. (Bournemouth).—*Total Honey Imports*.—The value of honey imported

into this country in 1910 amounted to £45,844. In 1909 the imports were £42,378. The total for last year shows an increase of £3,466.

J. W. M. (Edinburgh).—*Medicated Candy*. The candy is quite right now, and very well made.

#### Honey Samples.

J. R. M. (Starbeck).—The honey is from mixed sources, and worth about 50s. per cwt. It is rather thin. The cloudiness is caused by air bubbles; this defect, of course, can be removed.

P. J. (Rhayader).—No. 1 sample is a nice heather mixture worth 1s. per lb. retail, and about 70s. per cwt. No. 2 is from white clover, worth about 10d. per lb. retail, and 56s. to 60s. per cwt.

### IMPORTANT NOTICE.

Owing to the increased work of our staff in other directions, and also on account of so many subscriptions remaining unpaid, we are unable to undertake the extra work and expense involved in sending out bills for small accounts, or yet bear the loss of these unpaid sums. We therefore respectfully notify our subscribers that on and after January 1st, 1912, the "Bee Journal" can on no account be sent unless the subscription is prepaid.

### Special Prepaid Advertisements.

Two Words One Penny, minimum Sixpence.

Orders for three or more consecutive insertions entitle advertisers to one insertion in "The Beekeepers' Record" free of charge.

Trade advertisements of Bees, Honey, Queens, and Bee goods are not admissible at above rate, but will be inserted at 1d. per word as "Business" Announcements, Advertisements under the Private Advertisements. Advertisements of Hive-manufacturers can only be inserted at a minimum charge of 2s. per ½ in., or 5s. per inch.

### PRIVATE ADVERTISEMENTS.

5 CWT. good Light Extracted Honey, tins, 14lb. 7s. 6d.; 28lb., 14s. 6d.; cwt., 56s.; gross 1lb. screw top jars Honey, 90s.; cash with order.—STEBBINGS, postmaster, Hilborough, Norfolk. r 59

GOOD STOCK BEES, 18s. 6d.; secondhand Standard Hives, 3s., carriage paid.—REV. JARVIS, Coleford, Glos. r 58

TO OFFER, a few dozen Sections of Comb Honey, 8s. per doz., unglazed, on rail for cash.—T. GILLES, Cowsfield Apiary, Salisbury. r 55

11 STONE Finest Honey, 7s. per stone. — G. COLLIN, Cheveley Hall, Newmarket. r 57

BEEES FOR SALE, in Standard Hives.—THOS. B. HILL, Scotland's Cannock Board, Wolverhampton. r 53

STRONG W.B.C. HIVES, warranted healthy, some used once, brood chamber and two shallow bar supers, each 5s. to 12s. 6d.—JACKSON, Duxford, Cambs. r 54

BEST quality Honey Sections for sale, 10s. 6d. per dozen.—C. GARFITT, Coupar Angus, Perthshire. r 56



## Editorial, Notices, &c.

### BRITISH BEE-KEEPERS' ASSOCIATION

The monthly meeting of the Council was held on Thursday, December 21st, 1911, at 23, Bedford Street, Strand, London, W.C., when Mr. W. F. Reid presided. There were also present Messrs. C. L. M. Eales, J. Smallwood, J. B. Lamb, A. Richards, and E. Gareke. (Affiliated Association delegates), G. R. Alder (Essex), G. W. Judge (Crayford), and the Secretary, W. Herrod.

Letters expressing regret at inability to attend were read from Messrs. T. W. Cowan, O. R. Frankenstein, R. T. Andrews, E. Walker, A. G. Pugh, T. Bevan, E. Watson and Captain Sitwell.

The minutes of the Council Meeting held November 16th were read and confirmed.

The Council heard with regret of the death of Mr. Cyril Dunn Gardner, of Fordham Abbey, Cambridgeshire, a well-known member of the Association. A vote of sympathy with the family was passed, and it was also resolved to ask Mr. E. F. Dant, of Cambridge, to represent the Association at the funeral.

The following new members were elected. Mr. C. Redshaw, South Wigston, Leicester, Mr. T. A. Roberts, 58, Warwick Street, Daventry, Northants., Mr. W. P. Holland, 35, Wyatt Park Road, Streatham Hill, London, S.W., and Mr. E. Baruch Blaker, 16, Ann Street, Worthing.

Cheques amounting to £25 9s. 6d. were passed for payment.

The Secretary was instructed to arrange for the insurance against loss by damage to third parties, for 1912-13, on the same terms as those for 1910-11.

The report of the Development Grant Committee was received and accepted. A draft letter to the Board of Agriculture was also passed, and the Secretary instructed to send the same.

The report of the Examiners on the second-class examination was received. The number of candidates sitting was forty-two, the largest number that have ever sat at one time for this examination. It was resolved to grant certificates to the following:—Misses Muriel Gordon-Roberts, Rose Gribble, Adela Middleton, Mildred Partridge, Hilda Thrupp, Winifred Warburg, Agnes Woodward, and Edith Weston; Messrs. R. C. Osborne, W. J. Cornall, F. Kenward, L. Andrews, R. C. Massam, N. J. Reynolds, W. O. Jones, D. Davis, A. Richards, P. G. Russell, A. Manson, C. H. Heap, C. R. Forse, C. J. Ashworth, W. C. Johnson, J. Litman, and Capt. Sitwell.

A hearty vote of thanks was passed to

Mr. T. W. Cowan and Colonel H. J. O. Walker for undertaking the arduous work of examining the papers.

The next Council meeting will be held on January 18th, 1912.

## Correspondence.

*The Editors do not hold themselves responsible for the opinions expressed by correspondents. No notice will be taken of anonymous communications, and correspondents are requested to write on one side of the paper only and give their real names and addresses, not necessarily for publication, but as a guarantee of good faith. Illustrations should be drawn on separate pieces of paper. We do not undertake to return rejected communications.*

### REMOVING BEES FROM A ROOF.

[S823].—The old proverb has it, "It is an ill wind that blows nobody good," and this proves true in the following case. I was accosted by a friend one evening: "Here! When will you come out and see what can be done with the bees in our roof? Something must now be done, as during the storm the other night the wind blew off the finial from the gable of the roof, and crashed on to the tiles of the bay roof, where the bees are. Will you come out to-morrow?" to which I promptly replied in the affirmative. I had not the remotest idea what that promise entailed, but on reaching the house I found the bees were in the roof of a two-storeyed bay, about 30ft. from the ground. There was no means of access through any existing aperture, either inside or out, so a very long ladder had to be obtained from the cellar of the house, and I quickly ascended this and proceeded to locate the nest. I found that the bees entered the roof by a small chink in the angle, where the roof abutted against the wall. I then started to remove the tiles, to find it battened and boarded underneath. The obstructions I removed by boring holes and cutting with a saw, only to find the bees were not at this point. I then tried a similar operation farther up the steep slope of the bay, and luckily came upon the nest. What an extraordinary sight was revealed to view! Combs were built at right and other angles from the entrance: the bees evidently liked the closed end system of working, because the ends of the combs were closed, and their centres braced to one another, which produced a very compact nest from a structural standpoint. The next work was to try to get the bees out. I put up a swarm box provided with empty combs, thinking they might enter it; but this they would

not do, preferring to go down the rain-water pipe, the bottom end of which ran into the ground, so that I could not get them out. Meanwhile I started the work of clearing out the combs, which I had to do almost with one hand through a small aperture, as I wanted to avoid rain getting on to the ceiling below. The combs were almost black at the entrance, and varied in depth from six to twenty inches, as they receded in the rear; the whitest and newest ranged at the back. I took out about  $\frac{1}{2}$  cwt. of good honey this time, but as darkness came on the work had to be abandoned for the night, and the bees were left in their new iron home. In the interim I had time to consider what means to adopt to secure the bees, which were a grand lot, so I took with me some carbolic acid and a cloth to stop

African correspondent which, to my mind, was liable to give the British bee-keeper a somewhat wrong impression of bee-keeping in South Africa. Thanks are due to the Bee-keepers' Associations for the change which has been made in the last few years. Every year men and women enter the ranks of modern bee-keepers and the old boxes, barrels, &c., so commonly used in the days gone by, are rapidly being replaced by movable comb hives.

It is now a little over six years since I got my first colony; well do I remember going under cover of the darkness and bringing home a stock in an old rotten box on a wheelbarrow, which treatment the bees very much resented. I transferred them to a W.B.C. hive, but, owing to want of knowledge on my part, the bees evidently became disgusted and left me



APIARY OF MR. L. HARDWICK, BELLVILLE, S. AFRICA.

them going down the pipe again. On reaching the spot I found they had come up out of the pipe, and had started a fresh new nest farther up the inside, and out of reach. So first I stopped the pipe with the carbolic cloth, and proceeded with the smoking, the bees stampeding and flying in all directions. They eventually entered the swarm-box, and were closed in. They are a very healthy lot of natives headed by a very prolific queen. Over 1 cwt. of honey was taken, and a good lot of bees. Stray swarms are thought to be diseased, but I have not yet seen one.—R. Grose, Bodmin.

#### BEE-KEEPING IN SOUTH AFRICA.

[8324] Some little time ago a letter appeared in your journal from a South

with an empty hive. I soon secured another lot, these remained, and I have now about thirty colonies.

Bee-keeping is a splendid hobby affording any amount of open-air exercise. My hives are all on the W.B.C. pattern, which I have made myself, and the accompanying photograph will illustrate my apiary, which is on pure English lines.

Recently I held a field meeting at my apiary, which was well attended by enthusiastic bee-keepers, many coming from long distances. As a result of this gathering, a public meeting is to be called in Cape Town, with a view to forming a bee-keepers' association in affiliation with the South African Bee-keepers' Association. The distance bee-keepers are from one another, is, I dare-

say, a reason why this step has not been taken long ago.—LOUIS HARDWICK, Bellville.

### THE HONEY HARVEST FOR 1911.

(Continued from page 478).

#### ABERDEENSHIRE.

Taken all over, the honey yield in Aberdeenshire has been a very satisfactory one. The bees came through the mild winter in good condition, but did not make much headway till early summer. When the white clover came into bloom about the middle of June, forward stocks made good use of their time and backward ones built up rapidly. As the summer advanced the heat increased, and swarming became the order of the day. Early swarms did very well: some filled up to three racks of sections, and strong stocks that did not swarm have done much better. In one instance I heard of, over 170lb. of extracted honey was taken from one hive; this, I think, is a record for this county. It is difficult to give a correct average, but I think from 50lb. to 80lb. would be near it. The heather harvest has not been so favourable owing to drought and frosty nights, and the supply is therefore limited. Prices have kept up fairly well considering the quantity of honey in the market. Clover honey is selling from 8d. to 1s. per lb., heather honey from 1s. 2d. to 1s. 6d. per lb., and beeswax from 1s. 6d. to 2s. per lb., according to quality.—ALEC. LOW, Secretary A.B.K.A.

#### BANFFSHIRE.

All over the north of Scotland the honey harvest has been a bountiful one, the best indeed for ten years. The June and July flow from clover was copious, and the weather all that could be desired for ingathering. Later the prolonged drought began to tell, and little nectar was secreted, so that late July yielded smaller returns. The heather was early in flower, but the bloom was partial and gave way quickly, with the consequence that except in very favourably situated localities the surplus from this source was only a small one. In both cases very fine samples were secured. Heather honey sold well at a good price, but clover honey, owing to the rushing of the crop on the market, has a slow sale at a reduced price. Many sold at 7d. and 8d., but the writer sold out with several others at 10d. per section. Heather sold readily at 1s. 3d. to 1s. 6d. Bees go into winter quarters in excellent condition, apart from diseased colonies.—D. M. M.

#### CAMBRIDGE.

We had eight hives, and the average surplus was 161lb. per hive. We did not keep a separate account of each. If we

had done so I am sure two of them would have totalled 2cwt. at least of good honey.—J. CRABTREE (Melbourn).

#### NORTH BUCKS.

Bees here have done very fairly; my best take was 93lb. with an average of about 60lb. (Previous best was 83lb. and 55lb. average.) Quality good, and the most dense honey I have ever had. I took three diplomas in the selling class at the Grocers' Exhibition in September.—A. HARRIS.

#### SUFFOLK.

We started bee-keeping in the autumn of 1909 with six skeps. With the aid of the British Bee-keepers' "Guide Book" we transferred the bees into frame hives during 1910, and then improved our apiary with swarms and driven bees, starting 1911 with eleven frame-hives. Ten were worked for surplus, one for increase, our take of honey being fifty-four stone extracted, all of good quality (taking three prizes at local shows).—WM. AND S. PECK, Bailey Pool Cottages, Ixworth.

#### SOUTH WORCESTERSHIRE.

This has been a good year for honey in this district. I have taken 251lb. of extracted honey and 305 sections from seven hives, my best hive yielding 114½lb. of extracted honey, another with eighty-two sections coming second, besides two good swarms which came off in May. The honey was chiefly from the fruit trees and beans. There was not much white clover owing to the drought.—W. B. C. (Eldersfield).

(To be continued.)

### AMERICAN AND COLONIAL PAPERS.

#### EXTRACTS AND COMMENTS.

By D. M. Macdonald, Banff.

"Gleanings" from *Gleanings*.—"In carrying bees a short distance we have no difficulty in preventing bees returning when we take the precaution to smoke them thoroughly, and then bump them on a springless barrow to a new location. The work should be done on a cool morning. The average bee-keeper had better allow the bees to ripen the honey thoroughly inside the hive before it is extracted. The better-class honeys with their delicate flavours have a distinctly finer aroma if allowed to ripen in the hive." I say "Amen" to that!

"A doctor tells me that one of the best remedies known for nervous exhaustion is the patient taking from a teaspoonful to a table-spoonful of honey in a glass of water six or seven times a day." The same doctrine has been preached in this country.

"The practical apiarist who handles bees every day during the season can tell,

even before he goes to work, about the quantity of smoke the bees will need. I do not smoke one colony in twenty other than over the frames as the cover is raised. At midday there is less need of smoke."

*Straws.*—"To unite without having bees return to the old stand, put a newspaper over one hive and set the other over it. Is there any safer way to unite?" I would reply that at least the plan is an excellent one, but I would demur to two conclusions sought to be deduced. First, "Pure Italians don't need even the paper to keep them from fighting." *Here* there would be a battle royal! I would add, if the doctor's assertion is correct: Poor craven American-Italians! Besides, nine-tenths of the bees to be united are not pure Italians" is another assertion in the "straw." That means, according to my reading, that nine-tenths of the *weaklings* in U.S. are blacks or hybrids. If that is the true reading, it puzzles me to know why for fifty years he clung to bees who have such a bad reputation in his eyes. A very happy New Year, doctor!

*Pure Queen Mating.*—Doolittle, in the *American Bee Journal*, "sits" upon several queen-breeders who are content with having their yards one, two, or even three miles apart, in order to secure pure mating, and he favours *five*. "The live apiarist will find that selected queens will mate with drones four miles away, so that his area must be ten miles in diameter, instead of eight. Therefore, I have done the best I could to procure all queens from my best stocks within the last distance from my apiary." Not content with this, he masses his drones from the best and choicest drone-mothers in such a way that when all other drones have been massacred he has these choice virile males ready to fertilise his very best virgin queens. Even these liberally fed and pampered sires are weeded out as far as is possible. "The hive is opened up some cloudy day when there is no fear from robber bees, and every drone inferior as to size, imperfections, colour, or in any way deformed, is picked off and destroyed, so that only hand-picked stock is left for the queens to mate with." Another extensive bee-keeper lifts the curtain and gives us a peep at the reverse side of the shield: "We cannot afford to pinch the heads off the inferior queens. No, the orders have to be filled with the queens, taking them as they come, and only rarely do we pinch a very inferior one." This is how orders are filled for "cheap" queens.

*"Smoking" at the Antipodes.*—The *Australasian B.K.* devotes a considerable

part of its space to the question of smoke and smokers, and several contributors have dealt with the subject in a very interesting manner. The first prize essayist goes back to Virgil's recipe:—

"With sweetened water first the city choke

And then pursue the citizens with smoke." He says, "the best method of subduing bees is to sprinkle them with sweetened water. A *little* smoke should be blown *over* the frames when lifting off the cover, a *little* smoke should be blown *on* the bees when you want to drive them a short distance from one part of the hive to the other. Smoke should never be used to irritate bees, nor to subdue them. Smoke blown in at the entrance excites all the bees in the brood-chamber, so I consider it objectionable." The third prize man says, "I never blow smoke in at the entrance, as I believe it is bad policy," and the second only resorts to it in a case of extremity. A third man does not practise it, and a fourth, while he tolerates it, "does not consider the practice necessary." The editor has a leaning to the last opinion. Not *in*, but in an extreme case *across* the entrance. "Smoke blown in at the entrance disturbs every bee in the hive, and often causes the queen some excitement." Amongst the material used as fuel may be named dry chips, burning rags, clean bagging, tan bark, wood shavings, decayed wood, "punk" wood. The editor declares that old rags should never be used for smoker fuel, giving a dozen reasons for its disuse.

---

## Notices to Correspondents.

---

Miss M. L. N. (Dorset).—*Bee-keeping in Canada.*—Write for the information you require to the Editor of the "Canadian Bee Journal"; address, c/o. The Hurley Printing Co., Brantford, Ontario.

Puzzled (Eccles).—*Frames Propolised to Side of Hive.*—The frames evidently fit too tightly, and the bees have fastened them with propolis, not wax. Do not meddle with them just now, but in spring they can be loosened by inserting a screw-driver down the sides and gently levering them away.

J. J. (Haughton).—*Cane or Beet Sugar.*—Without a chemical test we should say the sugar is cane, and if the dealer guaranteed it you run no risk in using it.

### *Suspected Disease.*

P. C. BLAND (Birmingham) and F. A. A. (Warminster).—The bees are apparently affected with "Isle of Wight" disease, or malignant dysentery. We fear the former.

