

★ UMass/AMHERST ★



312066 0333 3305 4

LIBRARY
OF THE



MASSACHUSETTS
AGRICULTURAL
COLLEGE

SOURCE.

THE
British Bee Journal,
AND BEE=KEEPERS' ADVISER.

EDITED BY

THOS. WM. COWAN, F.C.S., F.L.S., F.R.M.S., &c.

VOLUME XXXVII.

JANUARY-DECEMBER, 1909.

PUBLISHED BY

SIMPKIN, MARSHALL, HAMILTON, KENT, & CO., LIMITED,

23, PATERNOSTER ROW, E.C.

LIBRARY

UNIVERSITY OF
MASSACHUSETTS

AMHERST, MASS.

LONDON:

PRINTED BY L. UPCOTT GILL, AT THE LONDON AND COUNTY
PRINTING WORKS, BAZAAR BUILDINGS, W.C.

INDEX.

EDITORIAL, NOTICES, &c. :-

Bees Killed near Copper-smelting Works, 331
 Board of Agriculture, 251, 253
 British Bee-keepers' Association : 181; Annual Meeting, 112; Conversazione, 121, 131, 141, 151, 401, 421, 431, 442; Monthly Council Meetings 31, 71, 112, 162, 201, 231, 281, 311, 371, 401, 411, 461
 Coming Honey Shows, 323
 Controlling Swarming, 21
 Death of Mr. W. Broughton Carr, 61, 74
 Disease of Bees in Isle of Wight, 101, 251
 Fertilisation of Fruit Blossoms by Bees, 401, 411
 Foul Brood and Chloride of Lime, 201, 323
 Importation of Bees, &c., into Transvaal, 291
 "Now is the Winter of Our Discontent," 501
 Our Journal and its Work, 1
 Prevention of Bee-Diseases in Cape Colony, 262
 Progress in Cuba, 291
 Recent Investigations of Bee-Diseases, 421, 431
 Respecting Parthenogenesis, 51, 62
 Revival of the Glucose Canard, 241
 "Royal" Show at Gloucester, 181, 202
 Scheme for Working B.B.K.A., Mr. Garcke's, 311
 Seasonable, 501
 The Bee in the Earliest Ages, 391

REVIEWS (Editorial) :-

A B C de l'Apiculture, 282
 A French Garden in England, 133
 Alexander's Writings on Practical Bee-Culture, 232
 A Year's Work in an Out-Apiary, 21
 Beiträge zur Naturgeschichte der Honigbiene, 22
 Brief Survey of Hawaiian Bee-keeping, 232
 Children's Story of the Bee, 451
 Conduite de Rucher, 181
 Die Mendelschen Vererbungsgesetze, 73
 Die Rassenzucht der Schweizer Imker, 1
 "Faul Brut," by Dr. Maassen, 481
 Hawaiian Honey, 1
 How to Keep Bees, 114
 Kalendar Ptschelovoda, 154
 Lawns, 114
 Mendel's Principles of Heredity, 271
 Mineral Waxes, 72
 Moderne Bienenzucht, 154
 Nature Through the Microscope, 492
 One & All Gardening, 154
 Patent Road to Fortune, The, 451
 Relation of the Etiology of Bee-Diseases, 232
 Recherches Expérimentales de Galleria Mellonella, 91
 Small Estate Management, 301
 South African Bee-keeping, 232
 Status of Apiculture in U.S.A., 233
 Successful Dairy-work, 301
 Successful Jam-Making and Fruit-Bottling, 301
 The Food of Some British Birds, 72

The Methods and Scope of Genetics, 73
 Winning a Living on Four Acres, 281

PROMINENT BEE-KEEPERS :-

Mr. T. B. Blow, 261
 Monsieur U. Gubler, 161
 Mr. Isaac Hopkins, 491
 Dr. Ulrich Kramer, 321
 Mr. D. M. Macdonald, 191
 Dr. C. C. Miller, 221
 Lieut.-Colonel H. J. O. Walker, 111
 Mr. W. Woodley, 441

AMONG THE BEES. By D. M. M., Banff :-

As the Queen Wills, 212
 Back to the Land, 253
 Bees and Flowers, 324
 Cappings of Comb, 5, 416
 Checking Robbing, 343
 Checking Swarming, 154
 Cheap Weed-Killer, A, 324
 Comments, 415
 Crude Criticism, 454
 Current Topics, 302
 Deep Bottom-Space, 254
 Driven Bees, 2
 Feeding in Spring, 103
 Fertile Workers, 471
 Filling Empty Hives, 173
 Flour in the Apiary, 155
 Foreign Honey, 493
 Golden Rule, A, 453
 Handy Tool, A, 254
 Hints to Beginners, 103
 Honey-Dew, 455
 Honey Packing-Cases, 273
 Increase, 193
 Influence of Weather on Honey, 454
 Intermixture of Bees, 2
 Introducing Queens, 3, 302; Virgin, 324
 Involuntary Wax-Secretion, 493
 Keeping Foundation, 233
 Lest We Forget, 135
 Locality and Surplus, 414
 Loss of Queens, 302
 Mild Winters, 155
 Misapplying Terms, 494
 My Bee-Garden in Spring, 84
 My Slight Mistake, 135
 New-Old Cures, 233
 "Novel" Claustal Hive, A, 134
 Queens, 103
 Queen's Egg-Laying, A, 362
 Robber-Traps, 415
 Season Up-to-Date, The, 254
 Short Crop, A, 302
 Some "Don'ts," 155, 234
 Stocks Likely to Yield Profit, 45
 Summer Honey-Drinks, 253
 Taking Care of the Smoker, 454
 The Controlling Force, 213
 The Dominating Influence, 212
 Thick and Thin Combs, 135
 To Paste in Your Hat, 392
 Useful Hints, 102
 Value of New Combs, 363
 Wax-Cake, 102
 Winter Vestibules on Hives, 22
 With the Critics, 65

NOTES BY THE WAY. By Wm. Woodley, Beedon, Newbury :-

Advice to Beginners, 95
 American Methods, 56
 A Remarkable Stock, 373
 Bees in May, 182
 Christmas Greeting, A, 505
 Feeders, 486
 Floorboard Feeder, 406

Folding Sections, 314
 Foundation-Making, 314
 Glazed Sections, 95
 Handling Queens, 12
 Keeping Bees on Allotments, 75
 Painting Hive-Roofs, 75
 Planting Bee-Flowers, 12
 Preparing for Winter, 353, 373, 405, 424
 Queen-Rearing, 34
 Sending Honey by Rail, 182
 Shaking Bees, 146
 Simmins' Uncapping Machine, 34
 Spring Cleaning, 145
 Spring Stimulants, 165
 Swarming, 182, 264
 Vitality in Bees, 56
 Wax-Extracting, 34

REVIEWS OF FOREIGN BEE-JOURNALS. By "Nemo" :-

Adulteration of Comb-Foundation, 471
 Adulteration of Honey in Germany, 82
 A Significant Warning, 144
 Bee-keeping in Abyssinia, 212
 Claustal Hive, 143
 Comb-Foundation Experiments, 171
 Congress for Suppression of Adulteration, 222
 Death's Head Moth, 81
 Degeneracy of the Common Black Bee, 211
 Diseases of Bees, 351
 Divisible Brood-Chambers, 211
 Do Bees Hear? 351
 Do Bees Injure Fruit? 471
 Foul-Brood Cure, 171
 Granulation of Honey, 211
 Harness Blacking, 223
 Harness Soap, 223
 Honey Tea, 82
 Necessity for Numbers of Drones, 81
 New Extractors, 171
 Planting Trees for Bee-Pasturage, 81
 Plurality of Queens in Hive, 351, 511
 Pollen for Bees in Spring, 143
 Production of Wax, 223
 Propolis Varnish, 351
 Queen-Rearing in England, 81
 Race-breeding is the Proper Way, 211
 Remedy for Wax-Moth, 471
 Respecting Parthenogenesis, 471
 Revue Française d'Apiculture, 144
 The Late M. Ch. Zwilling, 144
 The Late Wm. Busche, 172
 Tree-Planting for Bee-Pasturage, 171
 Tunisian Honey-Cake, 82
 Well-merited Distinction, 144

CAPPINGS OF COMB. By L. S. Crawshaw, Norton, Malton, Yorks :-

Abbott's "W.B.C." Hive, 297
 An Effete Queen, 449
 Aspen Pollen, 198
 Australian Honey, 158
 Autumn Expansion, 108
 Balling the Queen, 237
 Bee-Law, 198
 Black Bee, The, 257
 Brace-Combs as Winter Passages, 316
 Brace-Combs on Separators, 499
 Bee-District, A Good, 198
 Bee-keeping in Japan, 158
 Bees and Pollen, 397
 Bees and Railways, 108
 Bees as Creators, 48
 Bees Driven, 108, 118

- Bees in Paradise, 418
 Bees Leaving Hive, 138
 Bees Hanging Out, 216
 Bees on Bicycles, 16
 Bees Re-queening Themselves, 237
 Better Queens, 68
 B.B.K.A., The, 258
 Cane v. Beet Sugar, 378
 Catching the Queen, 378
 Chlorine for Foul Brood, 347
 Colour and Climate, 157
 Cone Escapes, 418, 499
 Controlling Swarming, 69
 Cost of Driven Bees, 68
 Cost of Feeding in Winter, 499
 Cruelty in Mismanagement, 88
 Cursory Examination, 15
 Death's Head Moth, 138
 De-capping Rake, 119
 Disinfection, 298
 Early Breeding, Signs of, 237
 Early Honey, 257
 Early Pollen, 178
 Electrical Swarm Alarm, 216
 Energy of Swarms, 317
 Ensuring Worker Comb, 216
 Entrance Screens, 68
 Feeding Driven Bees, 68
 Feeding, Late, 448
 Finding the Queen and Feeding Bees, 348
 Foundation, Strength of, 158, 317
 Hampshire Moor, 379
 Heather Secretion, 509
 Hints to Beginners, 138
 Hive Roofs, 15, 88, 138, 157
 Honey, Foreign, 509
 Honey Imports, 138
 Identifying Swarms, 258
 Isle of Wight Disease, 138
 Late Mating, 347
 Leaky Roofs, 178
 Lighting the Smoker, 237
 Matters Current and Under-Current, 137
 Mice, 15
 Mid Pike and Fell, 198
 Mouldy Combs, 237
 New Ideas, 277
 Northern Conference, 16
 Old Combs, 69
 Parthenogenesis, 89
 Prophets of Old, 109
 Rats, 197
 Scheme, Mr. Garcke's, 378
 Size of Old Cells, 237
 Suffocation, 198
 Superseding, 138
 Swarms and Foul Brood, 298, 347, 418
 Swarms, Second, 298
 Swarms *versus* Stocks, 439
 Swarms Without Increase, 277
 Time for Manipulations, 397
 Twice Matinz, 439
 Warmed Water for Bees, 49
 "Wax Craft," 197
 Wax-Gathering in Malaya, 418
 Wax Extractors, 16
 W.B.C. (Ay, Tell the Bees), 119
- AMERICAN AND COLONIAL PAPERS. EXTRACTS AND COMMENTS.
 By D. M. M., Banff : 39, 78, 79, 127, 167, 168, 205, 245, 287, 338, 388, 427, 428, 469, 513
- ANNUAL MEETINGS OF BEE-KEEPERS' ASSOCIATIONS :—
 Bedford, 352; British, 112; Cambridge, 152; Crayford, 453; Cumberland, 71, 583; Derbyshire, 53; Devon, 83; Essex, 182; Glamorgan, 83; Hertford and District, 102; Keighley and Craven, 163; Lancashire, 123; Leicestershire, 145; Lincolnshire, 144; Northants, 113; Notts, 64; Oxfordshire, 212; Shropshire, 192; Somerset, 163; South Africa, 153; Staffordshire, 391; Suffolk, 114; Surrey, 172; Sussex, 181; Warwickshire, 163; Worcestershire, 142
- BEE AND HONEY SHOWS :
 Aberdare B.K.A., 322; Ayrshire Agricultural Society, 471; Berks B.K.A., 242; Cambridge Mammoth, 341; Croydon B.K.A., 462; Cumberland B.K.A., 361; Dairy Farmers' Association, 462; Devon B.K.A., 462; Glamorgan B.K.A., 291; Grocers' and Allied Trades, 371, 381; Horsham, 362; Kent, 341; Leicester and Rutland B.K.A., 292; Lincoln B.K.A., 282, 292; Mid-Kent B.K.A., 471; Northants B.K.A., 531; North Norfolk B.K.A., 342; Notts B.K.A., 513; Perthshire B.K.A., 362; Royal Counties at Reading, 242; Royal Agricultural Society's at Gloucester, 251, 262; Shropshire B.K.A., 272; Somerset B.K.A., 381; Suffolk Agricultural Society, 231; South of Scotland B.K.A., 444; Surrey B.K.A., 391; Warwickshire B.K.A., 352; Worcestershire B.K.A., 352; Yorkshire Agricultural Society, 342
- Absorbent Covers, 168
 Adjustable Gauge for Hive Making, 359
 Adulteration of Comb-foundation, 471
 Adulteration of Honey, 82
 Advertising Medium, *Bee Journal* as, 166, 204
 Aeroplanes, Bees and, 28
 Africa, Bees in Central, 89
 Agricultural Union, Women's, 9
 Allotments, Keeping Bees on, 49, 58, 75
 America, Foul Brood in, 469
 Apiary of the Rock, The, 194
 Apicultural Notes, 116, 495
 Apiculture Nouvelle, 480
 Appeal for the B.B.K.A., 183
 Are Bees Possessed of Intelligence, 344
 Aristotle, Tales from, 494
 Artificial Honey, 256; Distinguishing Pure from, 12
 Artificial Swarm, Making an, 209, 219
 Artificial Swarming, Re-queening by, 199
 As the Queen Wills, 212
 Australia, Bee-keeping in, 149, 157, 158
 Automatic Management, 338
- Baby Mating Boxes, 189
 Baby Nuclei, Queen-rearing in, 98, 156
 Bacillus Alvei, 120
 Back to the Land, 253
 Baling the Queen, 237
 Beckenham and District B.K.A., 453
 Bedford, New B.K.A. for, 332
 Bee-Applications at Shows, 386
 Bee-Club in London, 296, 346
 Bee-Districts, 219
 Bee-Farming, 349
 Bee-Flora, Books on, 480, 510
 BEE-FLOWERS : 240, 249, 259, 260, 290, 324, 440, 460; in Spring, 84; Planting, 12; Seed Distribution, 117; Strawberry Tree, 419; Utilising Vacant Ground for, 9
 Bee-House, Making a, 300; Value of, 279
 Bee-Keepers and County Associations, 295, 326, 337, 345, 357, 375, 394
 Bee-Keepers' Association for South Africa, 25
 Bee-Keeping in Abyssinia, 212; in Berks, 488; in British Columbia, 510; in Bucks, 246; in Cornwall, 477; in Derbyshire, 244, 335; in East Essex, 506; in Egypt, 41; in Hawaii, 332; in Holland, 176; in Isle of Man, 477; in Japan, 124, 158, 470; in Kashmir, 365; in Liguria, 103, 139; in Mexico, 246, 426; in New Zealand, 130, 474; in Orkneys, 397; in South Africa, 232, 350, 369, 512; in South Australia, 149, 157, 348; in South Islands, 196, 456; in Suburban Gardens, 28, 47; in Switzerland, 185; in the Midlands, 184, 236; in Warwickshire, 196, 265, 305
 Bee-Keeping, Starting, 30, 229, 270, 308, 349
- BEE-SHOWS TO COME :—
 168, 179, 189, 199, 207, 218, 229, 238, 248, 258, 268, 278, 288, 299, 308, 328, 339, 348, 358, 368, 419
- Bee-Stings and Rheumatism, 85, 92, 107, 427
 Bees Accepting Virgin Queen, 219
 Bees and Aeroplanes, 28
 Bees and Carrion, 468, 474
 Bees and Cucumbers, 105
 Bees and Daisies, 205
 Bees and Lucky Days, 470
 Bees and Pollen, 105, 143, 146, 198, 334, 397
 Bees, Brood-Diseases of, 6
 Bees, Common Black Race of, 41
 Bees, Damage or Injury Done by, 164
 Bees Deserting Skep, 228
 Bees, Doctors and, 26
 Bees Doing Well, 226
 Bees, Do They Injure Fruit? 471
 Bees, Driven, 2, 8, 14, 168
 Bees Dying, 270
 Bees, Faulty Slow Feeders for, 30
 Bees, Feeding, 121, 409
 Bees Fertilising Fruit Blossoms, 60, 86, 167, 376
 Bees Forsaking Hive, 208
 Bees, Handling, 12
 Bees, Heredity in, 37
 Bees Idle after Swarming, 280
 Bees in a Tombstone, 183
 Bees in Burma, 376, 513
 Bees in Central Africa, 89
 Bees in Hants, 196, 456
 Bees in the Cotswolds, 426
 Bees in the Earliest Ages, 391, 509
 Bees, Intermixture of, 2
 Bees Killed near Copper-Smelting Works, 331, 377, 426
 Bees Leaving Hive, 79
 Bees, Moving, 28, 40, 69, 140, 170, 186, 205, 246, 439, 440, 450
 Bees Objected to by Neighbours, 218, 430
 Bees, Odds and Ends About, 24
 Bees on Allotments, Keeping, 49, 58, 75
 Bees on Railway Embankments, 40, 58, 98, 135
 Bees, Planting Trees for, 27, 171
 Bees Ready for Supers, 179
 Bees Refusing Syrup, 430
 Bees Refusing to Work in Supers, 260, 280, 309, 459
 Bees Re-queening Themselves, 196
 Bees, Responsibility for Loss of, 30
 Bees Robbing by Agreement, 129
 Bees Running About Floorboard, 309
 Bees, Shaking Energy into, 175
 Bees, Size of, 168
 Bees Superseding Queen, 208
 Bees, Transferring, 60, 110, 120, 129, 150, 169, 247, 259
 Bees Transporting Eggs, 227, 245
 Bees, Utilising Driven, 168
 Bees, Vitality of, 35, 56, 67
 Bees, Water for, 11, 49, 126
 Beeswax, Discovery of the Origin of, 31, 42
 Beeswax, Rendering, 24, 27, 34, 38, 102
 Bees Working in Glasshouses, 160
 Bees Working on Fir-trees, 269
 Beginner's Experiences, 387
 Beginner's Hints to, 103, 138
 Beginner's Queries, A, 70, 218, 269
 Best Position for Hives, 108
 Black Bee, Degeneracy of, 211
 Blow, Mr. T. B., 261
 Board of Agriculture and Isle of Wight Disease, 293, 326
 Books on Bee-keeping, 458; Foreign, 105; on Bee-Flora, 480, 510
 Brace-Combs, 479, 499; Attached to Separators, 437
 Breeding the "British Golden" Bee, 482, 497, 507, 511
 Bristol, Bee-Notes from, 296
British Bee Journal as an Advertising Medium, 166, 204
 British B.K. Association, 202, 225, 226, 238, 421, 422, 446, 466, 473, 486, 487, 496, 505, 505, 513
 British B.K. Association, An Appeal for, 183, 421

- British B.K.A. and Its Secretary, 457, 446, 447, 448
 British B.K. Association Exhibit at International Exhibition, 265
 British Birds, Food of, 72, 97
 British Hives in Natal, 136
 British Honey Market, 110
 Broken-down Combs, 259
 Brood Cast Out, 240, 248
 Brood-Chambers, Divisible, 13, 211
 Brood-Combs, Using Old, 80
 Brood in Supers, 239, 247
 Brood, Mummified, 6
 Burmah, Bees in, 346
 Buying Foreign Queens, 266
- Calico Quilts, Painted, 490
 Calorimetric Method of Wax-Analysis, 41
 Canada, Foul Brood in, 428
 Candy-Feeding, 440
 Candy-Making, 60, 450, 490
 Cane for Skep-Making, 469, 478
 Carr, The Late W. Broughton, 61, 74, 75, 77, 97, 98
 Carriage, Bees and, 474
 Carrying Bees on Motor Bicycle, 395
 Catching the Queen, 309, 378
 Cell-Cups, Queen Rearing Without Using, 20
 Cells, 265
 Celluloid Quilts, 468
 Certificates, Experts', 7, 427, 510
 Changing Breeds, 310
 Changing Hives, 549
 Checking Robbing, 343
 Chilled Bees, 490
 Chloride of Lime for Foul Brood, 171, 200, 201, 205, 215, 237, 243, 246, 259, 264
 Chlorine as a Disinfectant, 298, 303, 325, 353, 345, 347, 355
 Christmas Dream, A, 7
 Christmas Rose, The, 107, 135
 City Bees in Scotland, 9
 Claustral Hive, The, 99, 134, 143, 208, 409
 Clematis Montana, 249
 Clipping Queens, 80, 289
 Colour and Climate, 88, 115
 Colour Inheritance in Bees, 96
 Colour of Wax, 358
 Coloured Plates of Bees, 20
 Comb-Foundation, 356, 471
 Comb-Foundation Experiments, 171
 Comb-Honey, Production of, 141, 151
 "Combination" Hive and Nucleus, 348
 Combs Built Across Frames, 510
 Combs, Irregular, 159, 258
 Combs, Old, 69
 Combs, Renewing Old, 159
Commonwealth Bee-keeper, The, 10
 Conditions of Nectar Secretion, 304
 Cone-Escapes on Roofs, 374, 418, 438, 499
 Controlling Force, The, 213
 Controlling Swarming, 21, 69, 246
 County Associations and Bee-keepers, 295, 325, 337, 345, 357, 375
 Covering Hive Roofs with Calico, 70, 149
 Crews as a Bee-District, 40
 Criticism, Crude, 454
 Croaking Noise in Hives, 337
 Cross-Breeding of Bees, 509
 Cruelty in Mismanagement, 46, 86, 88
 Cucumbers, Bees and, 106
 Cumberland B.K.A. Meeting, 583
 Cumberland Bee-keeping, 75
 Cumberland Show, 325
 Curious Behaviour of Bees, 304, 429
 Curious Custom, A, 41
 Current Topics, 283, 302, 303, 326, 374, 395, 407, 447
- Damage Done by Bees, Responsibility for, 164
 Danger of Suffocating Bees, 366
 Dead Bees Cast Out in January, 19
 Dead Bees in Super, 369
 Dead Brood, 338
 Death of W. Broughton Carr, 61; Rev. E. Davenport, 489; W. Hetherington Harris, B.A., 5; E. L. Pratt, 134; Geo. Wells, 158; Mrs. Woodbury, 148; Luke Wren, 297
- Death's Head Moth, 81, 429
 Decoy-Hives, 207
 Degeneracy of the Common Black Bee, 211
 Derbyshire, Bee-Notes from, 244, 355
 Detention Chambers, 208
 Direct Introduction of Queens, 3
 Discovery of the Origin of Bees-wax, 31, 42
 Disease, Isle of Wight, 101
 Diseased Brood, 247
 Diseases of Bees, Brood, 6, 351
 Diseases of Bees, Investigating, 351, 421, 431, 453
 Disinfectants, Diseases through, 243
 Disinfecting Combs with Formalin, 149, 329
 Disinfecting Hives, 264, 274, 292, 298, 420
 Distance of Bee's Flight, 185, 293, 388
 Divisible Brood-Chambers, 13, 211
 Do Bees Hear? 351
 Doctors and Bees, 26
 Domesticating Humble Bees, 518
 Doubling for Extracted Honey, 100
 Doubling Stocks, 207
 Drinking-Trough for Bees, 49
 Driven Bees, All About, 14, 116
 Driven Bees, Cost of, 68
 Driven Bees, Feeding, 66
 Driven Bees, Swarms and, 8, 27, 37
 Driven Bees, Utilising, 168
 Dr. Maassen's Book on Foul Brood, 8
 Drone-Brood Cast Out, 248
 Drone-Brood in Worker-Comb, 248
 Drone Cast Out, 219
 Drone-Comb, Superfluous, 19, 90
 Drone or Worker Cells for Supers? 50
 Drones Being Killed, 280
 Drones in January, 50
 Drones Late in Season, 430
 Drones, Necessity for, 81
 Dwindling Colony, 219
 Dwindling Stock, 368
 Dwindling Swarm, 329
 Dysenteric Bees, 140, 249, 490
- Early Honey, 275
 East Anglian Observations, 205, 275
 Echoes from the Hives, 389, 419, 458, 508
 Eggs in Sections, 359
 Eggs, Laying, 364
 Egypt, Bee-keeping in, 41
 Eggs, Removing, 120
 Electrical Swarm Alarm, 185
 Empty Hives, Filling, 173
 Entrances, Protected, 22, 68
 Eucalyptus Flavour, 128
 Examining Hives, 159, 187
 Excluder, The "Wilkes," 166, 427
 Exhibit at International Exhibition, 265
 Exhibiting at Dairy Show, 419
 Experts' Certificates, 7, 427, 510
 Experts' Certificates in South Africa, 25
 Experts in Kent, 229
 Extracted Honey, Doubling for, 100
 Extracting, Frequent, 288
 Extracting Honey, 419, 459
 Extracting Shallow-Frames, 500
 Extractor, A Cheap, 136
 Extractor, Cleaning Rusty, 310
 Extractor, Making a Rapid, 109
 Extractor, Using an, 280
 Extractors, New, 171
- Faire Tales and Profits, 66
 Fanning, Queen, 284
 Faulty Spring Management, 20
 Feeder, Improved Floorboard, 375, 455
 Feeders, 180, 309, 359, 359, 369, 385
 Feeding Bees, 121, 409
 Feeding Bees in Skep, 450
 Feeding Driven Bees, 68
 Feeding in Winter, 495, 499, 509
 Feeding, Late, 448, 470
 Feeding with Candy, 459
 Fertile Workers, 472
 Fertile Workers, Dealing with, 169
 Fertile Workers, Drones from, 180
 Fertilisation of Fruit-Blossoms by Bees, 60, 86, 167, 376, 399, 401, 411, 479
- Fertilisation of Queen, 398
 Fir-Trees, Bees Working on, 269
 Fixing Foundation in Sections, 218
 Flight of Bees, Distance of, 186, 293, 388
 Flour in the Apiary, 155
 Food, Granulated Honey for Bee-, 150
 Food of British Birds, 72, 97
 Foreign Books on Bee-keeping, 106
 Foreign Honey, 276, 493
 Foreign Honey, Price of, 256
 Foretaste of Spring, 127
 Formaldehyde and Foul Brood, 218
 Formalin, Disinfecting with, 149, 329
 Fossil Coal, 349
 Foul Brood, 120, 399, 450
 Foul Brood and Chloride of Lime, 201, 205, 215, 323
 Foul Brood, Chlorine for, 298, 303, 325, 353
 Foul Brood, Cure of, 171, 379
 Foul Brood, Dr. Maassen's Book on, 8
 Foul Brood in America, 469
 Foul Brood in Canada, 428
 Foul Brood Legislation, 296
 Foul Brood, Suppression of, 46
 Foul Brood, Swarm Developing, 259
 Foundation, Adulteration of, 471
 Foundation and Foul Brood, 305, 316, 379
 Foundation Experiments, 171
 Foundation, Keeping, 233
 Foundation, Old, 219
 Foundation, Strength of, 158, 317, 356
 Foundation, Testing, 126
 Frame-Hive in Italy, The, 54
 Fruit? Do Bees Injure, 471
 Fruit-Growing, Books on, 440
 Fruit Trees, Wash for, 89
- Garcke, Mr. E., His Scheme for B.B.K.A., 311, 378, 506
 German Hives, 295
 Glass Over Rack of Sections, 358, 378
 Glazing Sections, 79, 290, 396
 Gloucester, New B.K.A. for, 228, 272
 Gloucestershire, Bees in, 468
 Glucose Canard, Revival of, 241, 256
 Good Bee-District, A, 198
 Granulated Honey for Bee-Food, 150
 Granulated Honey in Sections, 100
 Granulated Honey, White Patches in, 50, 399
 Granulation, Light Retarding, 389
 Granulation of Honey, 211, 260, 420
 Granulation, Rapid, 7
 Great Industry, A, 168
 "Guide Book," How to Use the, 353
 "Guide Book," The New Edition of, 99
- Hampshire Moors, The, 315, 379
 Handling Queens, 12
 Handy Hive-Scraper, A, 254, 419, 426, 457
 Hants, Bees in, 196, 456
 Has the B.B.K.A. Outlived Its Usefulness, 466, 486, 487, 505
 Hawaii, Honey in, 59
 Hawthorn, Bees Not Working on, 270
 Heather Honey, Granulation of, 420
 Heather Seasons, 23
 Heather Secretion, 463
 Heather, Sending Bees to the, 228, 329
 Heredity in Bees, 37
 Hieroglyphs of the Bee, 264, 397
 Himalaya Bees, 365
 Hive, A Decoy, 208
 Hive, A Novel, 214
 Hive-Construction, Modern, 56, 67, 76, 87, 115, 117, 148, 205, 359
 Hive-Roofs, 15, 106, 149, 175, 186, 276
 Hive-Roofs, Calico for Covering, 70
 Hive-Roofs, Painting, 75, 100
 Hive, The Claustral, 99, 134, 143, 208, 409
 Hive? What is a "W.B.C.," 97
 Hives, Disinfecting, 274
 Hives, Filling Empty, 173
 Hives, Levelling of, 284, 317
 Hives Near Road, 110

- Holland, Bee-keeping in, 176
Homes of the Honey-Bee, 434
Honey as Medicine, 59
Honey-Cake, Nut, 14
Honey-Cake, Tunisian, 82
Honey-Dew, 299, 309, 319, 320, 369, 408, 435
Honey, Distinguishing Pure from Artificial, 12
Honey-Drinks, Summer, 253
Honey, Early, 275
Honey-Excluders, 479
Honey, Granulation of, 211, 260, 420
Honey Harvest, 416
Honey Imports for 1908, 77
Honey Imports for December, 1908, 12; January, 68; February, 95; March, 154; April, 182; May, 233; June, 275; July, 323; August, 373; September, 405; October, 445; November, 506
Honey in Brood-Combs, 239, 399
Honey, Influence of Weather on, 454
Honey in Italian Hotels, 77
Honey Market, British, 110
Honey-Moons, 151
Honey Packing-Cases, 273, 283
Honey, Production of Comb-, 141, 151
Honey, Pure Raspberry, 7
Honey, Sending, by Rail, 166
Honey-Tea, 82
Honey, Uses of, 128
Honey, Varying Colours of, 470
Hope, 338
How to Use the "Guide Book," 353
Humble-Bees, Domesticating, 318
Hunger-Swarms, 175
- Improved Floorboard Feeder, 376, 455
Improving Bee-Pasturage, 440
Improving Honey Flavour, 167
Improved Rapid Feeder, 385
Increase, 195
Indian Bees, 479
Influence of Weather on Honey, 454
Injury Done by Bees, Responsibility for, 164
Insect Nomenclature, 339, 340
Insurance, 170
Insurance, Advantage of, 276
Intelligence of Bees, 344
Interesting Experiences, 488
Interesting Judgment, 41
Intermixture of Bees, 2
Introducing Queens, 11, 226, 338, 347, 364
Investigations of Bee-Diseases, 421, 431
Irregular Combs, 159, 238
Isle of Man, Bees in the, 477
Isle of Wight Bee-Disease, 101, 138, 235, 243, 251, 253, 255, 267, 285, 286, 293, 304, 315, 326, 451, 455, 478
Italian Bees, 384
Italian Bees and Foul Brood, 476, 506
Italy, The Frame-Hive in, 34
- Japan, Bee-keeping in, 124, 158, 470
Japanese Bees, 269
Judging Honey, 388, 409
Judging Sections, 335
Judgment, Interesting, 41
- Kashmir, Bee-keeping in, 365
Keeping Bees in Suburban Gardens, 28, 47
Keeping Bees near Railways, 40, 58, 98, 136, 501
Keeping Bees on Allotments, 49, 58, 75
Kent, Certificated Experts in, 229
- Lanarkshire, Poor Season in, 445
Lantern-Slides for Bee-Lectures, 20
Late Gathering of Pollen, 439
Late Mating of Queen, 266, 306, 347
Law Relating to Bees, 164, 166, 180, 198, 249, 318
Leaf-Cutter Bees, 359
Lecture on Isle of Wight Disease, 451
Lectures, Reliability of, 29
Levelling of Hives, 284, 317, 418
Liability of Bee-keepers, 382
- Liguria, Bees in, 103, 139
Lime Trees, Value of, 176
Locality and Site of the Apiary, 187
Locality and Surplus, 414
Longevity, 59
Loss of Bees, Responsibility for, 30
Loss of Queens, 302, 310, 369
Lucubrations, 48, 66
- Maassen's Book on Foul Brood, 8
Macdonald, D. M., 191
Making a Rapid Extractor, 109
Making Soft Candy, 490
Malden on Isle of Wight Disease, 451
Mason Bee, The, 480
Mendel's Law of Parthenogenesis, 54, 96, 271
Mexico, Bees in, 246, 426
Midlands, Bees in the, 184, 236, 286, 337
Mid Pike and Fell, 177, 194, 198, 235, 254
Mild Winters, 155
Miller, Dr. C. C., 147, 221, 389
Miller on Wax and "Wax Craft," Dr., 156
Miller, Visit to Dr., 146
Mismanagement, Cruelty in, 46, 86
Models in Beeswax, 245
Modern Hive-Construction, 56, 67, 76, 87, 115, 117, 148, 205, 339
Mouldy Combs, 237
Moving Bees, 28, 40, 69, 140, 170, 186, 205, 246, 439, 440, 450, 500
Moving Bees Short Distances, 368
Moving Bees to Clover Field, 119
Mummified Brood, 5
- Naphtha in Syrup, 430
Nectar Secretion, Conditions of, 304
New B.K.A. for Bedford, 332
New B.K.A. for Bromley and Beckenham, 453
New B.K.A. for Gloucester, 272
New Bee-Tree, 375
New Edition of "Guide Book," 99
New Zealand, Bee-keeping in, 130, 474
Nomenclature, Bee, 170
Non-Standard Frames, Using, 500
Non-Swarming Bees, 287
Notes by the Way, 478
Notes from Berkshire, 488; Cumberland, 75; North Bucks, 364, 426; North Herts, 46, 115; Ross-shire, 35, 203, 284, 417; the Cotswolds, 426
Novel Bee-Hive, A, 214, 258
NOVELTIES FOR 1909: "Carver" Section-glazing Machine, 79; "Hunter" De-capping Instrument, 69; "Silver" Reversible Floorboard, 98; "Simmins" Multiple Uncapper, 17; "Wilkes" Queen-Excluder, 185
Nuclei and Queen-Rearing, 156
Nuclei, Small, 39
Nucleus, Bees Leaving, 160
Nucleus Management, 319
Nut Honey-Cake, 41
- OBITUARY: Mr. W. Broughton Carr, 61; Rev. E. Davenport, 489; Mr. W. H. Harris, B.A., 5; Mr. E. L. Pratt, 134; Mr. Geo. Wells, 158; Mrs. Woodbury, 148; Mr. L. Wren, 297
Objection to Bees, 218, 430
Observatory Hive, Bees in, 160, 239
Odds and Ends about Bees, 24
Origin of Beeswax, Discovery of the, 31, 42
Our Failures, 223
Our Journal and its Work, 1
Out-Apiaries near Dwellings, 19
Out-Apiary, Managing an, 35
Out-Apiary, Moving Bees to, 69
Over-Dosing with Naphthol, 368
Ownership of Swarm, 248
- Painting Hives, 75, 100, 338
Paper Honey-Packing Cases, 273, 283
Paper Pulp Honey-Pots, 327
- Parasite on Bee, 209, 259, 369
Parthenogenesis, Respecting, 51, 54, 62, 64, 87, 89, 96, 245, 271, 286, 452, 471
Partnership Agreement, 369
Persistent Swarming, 39
Phenol Solution, 170
Philanthropist, A Real, 38
Planting Bee-Flowers, 12
Planting Trees for Bees, 27, 171
Plants for Bees, 460
Pleasures of Bee-keeping, 287
Plurality of Queens in Hive, 351
Polestes Gallica, 448
Pollen and Bees, 105, 143, 146, 198, 334, 397
Pollen in Spring, 143, 247
Pollen, Late-gathered, 439
Pollen Mould, 110
Portsmouth as a Bee-District, 166, 198
Portugal, Sending Bees to, 329
Predominating Partner, The, 213
Preventing Swarming, 309
Prevention of Bee-Disease in Cape Colony, 262
Production of Comb-Honey, 141, 151
Products of Bees into Transvaal, Prohibition of, 291
Profit, Stocks Likely to Yield, 45
Profitable Queen, A, 275
Prominent Bee-keepers, 111, 136, 161, 191, 221, 251, 321, 441, 491
Promising Outlook, A, 204, 214
Propriety and Profits, 8
Propolis Super-Clearer, 239
Propolis Varnish, 351
- Quality of Honey Collected by Various Races, 120
Queen, A Profitable, 275
Queen-Bee's Sting, 37
Queen-Breeding at Ripple Court Apiary, 482, 497, 507
Queen-Cage, Watts' Simplex, 443
Queen Cast Out, 9, 359
Queen, Catching the, 309
Queen-Excluder, The "Free-way," 186, 421, 495
Queen-Excluders, 389, 407, 438, 448, 457, 468
Queen, Finding a, 128
Queen Flying During Manipulation, 328
Queen Getting Through Excluder, 279
Queen in Sections, 270, 359
Queen Laying in Shallow-Frames, 269
Queenless Colony, Dealing with, 269, 315
Queenless? How Do Bees Become, 227
Queenless, Yet Carrying Pollen, 288
Queen-Mating, 398
Queen-Mating Difficulties, 385
Queen-Mating, Late, 266, 306, 347
Queen Outside Hive, 130
Queen-Rearing, 34, 49, 130, 156, 188, 197
Queen-Rearing in Baby Nuclei, 98, 156
Queen-Rearing in England, 81
Queen Rearing in Spring, 129, 200
Queen-Rearing Without Using Cell-Cups, 20
Queen Twice Mated, 396, 439
Queen Wasps Active in January, 19
Queen Wills, As the, 212
Queens, 103
Queens Carrying Disease, 128
Queens, Direct Introduction of, 3
Queens, Flight of, 175
Queens, Good Qualities of, 59, 68
Queens, Handling, 12
Queens in One Hive, Two, 203
Queens, Introducing, 11, 226, 302, 324, 347
Queens, Introducing Virgin, 324, 364
Queens, Loss of, 302, 310, 369
Queens Pipinx, 269
Queens, Superseding, 170, 208
Queens, Telling Age of, 179
Queens with One Swarm, Two, 305, 385, 426
Quilts, Material for, 208, 459
- Race-Breeding is the Proper Way, 211
Race of Bees, Changing, 419

- Railway Charges, 417
 Railway Risks, 499
 Railways, Keeping Bees Near, 40, 58, 98, 108, 138
 Rainfall for 1908, Total, 10
 Rainfall, for December, 1908, 10; January, 60; February, 99; March, 149; April, 217; May, 247; June, 299; July, 327; August, 358; September, 429; October, 449; November, 489
 Raising Queens in May, 200
 Random Notes, 175, 183
 Rapid Feeder, An Improved, 385
 Rapid Granulation, 7
 Raspberry Honey, Pure, 7
 Rats, Rough on, 156, 197
 Raw Cane-Sugar for Spring Feeding, 20
 Rearing and Introducing Queens, 11
 Record Swarm, A, 306
 Re-making Candy, 490
 Remarkable Stock, A, 357, 364, 398
 Removing Bees from above Window, 329
 Removing Bees from Trees, 139
 Re-queening, 246, 430; and Transferring, 130
 Re-queening by Artificial Swarming, 199
 Re-queening Every Two Years, 39
 Re-queening Hives, 90
 Re-queening: Is It Always Advisable? 29
 Re-queening Themselves, Bees, 196
 Respecting Parthenogenesis, 51, 54, 62, 64, 67, 89, 96, 245, 271, 286, 452, 471
 Retarding the Hatching of Eggs, 440
 Reversible Floorboards, 107
 Rheumatism and Bee-Stings, 85, 92, 107, 427
 Ripening Honey, 368, 419
 Robber Traps, 368, 397, 415
 Robbing by Agreement, Bees, 129
 Robbing, Checking, 343
 Ross-shire Notes 35, 203, 284, 417
 Royal Counties Show, 164, 199
 "Royal" Show at Gloucester, 251, 262
 "Rymer" Honey-Board, 420
 Scotland, City Bees in, 9
 Scotland, Examination for Experts in, 427
 Scraper, A Handy Hive-, 254, 419, 426, 457
 Scraping Frames, 283
 Scrupulous Bees and Honey, 456, 509
 Sealing, Airtight, 128
 Seasonable Advice, 195
 Seasonable Occupations, 12
 Season in Gloucestershire, 468; Lanarkshire, 445; Mid-Cornwall, 287; North Cornwall, 8; Northumberland, 346; Ross-shire, 416; Sunderland, 384; Warwickshire, 305
 Seasons, The Past Heather, 23
 Second Swarms, 266
 Secretion of Heather Honey, 463
 Secretion of Nectar, 304
 Section-Racks 504
 Sections, Folding, 314, 338, 364, 379
 Sections, Removing and Extracting, 189
 Sections, Utilising Partly-filled, 168, 179, 440
 Selborne Society, The, 16
 Selling Honey in Bulk, 109
 Selling Swarms, 215
 Sending Bees to Portugal, 329
 Sending Bees to the Heather, 228, 329
 Sending Honey by Rail, 166
 Several Eggs in Cells, 270
 Shaking Energy into Bees, 175, 206
 Shallow-Frames, Extracting, 500
 Signs of Early Breeding, 237
 Simmins' Uncapping Apparatus, 17, 34
 Size of Old Cells, 237
 Slow-Feeders for Bees, Faulty, 30
 Smell as a Foul Brood Index, 288
 Smoker, Curious Old, 354
 Smoker, Taking Care of the, 454
 Snow on Hives, 500
 Some Don'ts, 155
 Song of a Whitby Bee-keeper, 278
 Sophora Japonica, 375, 458
 Source of Dark Honey, 276
 South Africa, B.K. Associations in, 25, 256
 South Africa, Bee-keeping in, 232, 350, 369, 438
 South Africa, Experts' Certificates, 25
 Space Below Frames, 364
 Spider Plant, 416
 Split Cane for Skep-Making, 469, 478
 Spring at Last, 175
 Spring Bee-Flowers, 84
 Spring, Bee-Work in, 90
 Spring Examinations, 128
 Spring-Management, Faulty, 20
 Springtime, 126
 Square Sections, Block for Securing, 284
 Staffs, Good Report from, 227
 Starting Bee-keeping, 30, 229, 270, 308, 349
 Starving Stock, A, 488
 Stimulative Feeding, 129
 Sting of the Queen-Bee, 37
 Stings, 227
 Stings, Effect of, 410
 Stock, A Remarkable, 357, 364, 398
 Stock Found Dead in February, 60
 Stocks Likely to Yield Profit, 45
 Storm-Doors, 128
 Strength of Foundation, 158
 Suburban Gardens, Bee-keeping in, 28, 47
 Successful Apiculture, 187, 207, 267, 307, 347
 Suffocating Bees, Danger of, 366
 Sugar, Cane versus Beet, 315, 379
 Sugar for Spring Feeding, Raw, 20
 Sugar that Kills Bees and Babies, 317
 Stroke, 167
 Superfluous Drones, 90
 Supers, Bees Ready for, 179
 Supers, Drone or Worker Cells for, 50
 Supers on Skeps and Frame-Hives, Working, 169
 Supers, Putting on, 150
 Superseding Queen, Bees, 208
 Surmisable, 16, 35, 59
 Suspected Combs, 189
 Swarm, An Early, 197
 Swarm, A Record, 306
 Swarm Building in Tree, 280
 Swarm, Dead Bees in, 229
 Swarm Developing Foul Brood, 259, 276, 298, 374, 418
 Swarm from Your Best Stock, 453
 Swarm Separating, 478
 Swarm Settling on Horse, 276
 Swarming and Supering, 288
 Swarming, Checking, 154
 Swarming, Controlling, 21, 69, 288
 Swarming, Late, 310
 Swarming, Persistent, 39
 Swarming, Preventing, 309, 310
 Swarming Vagaries, 214, 226, 326
 Swarms, 489
 Swarms and Driven Bees, 8, 27, 37
 Swarms Curious, 489
 Swarms, Identifying, 258
 Swarms, Ownership of, 248
 Swarms, Price of, 270
 Swarms, Treatment of, 298
 Swarms versus Stocks, 283, 407, 439
 Swing Windows in Honey-House, 374
 Switzerland, Bees in, 185
 Taking Time by the Forelock, 12
 Tales from Aristotle, 494
 Technical Terms, 476, 494
 Telling the Bees, 248
 Testing Strength of Foundation, 126
 Thick versus Thin Combs, 135
 Thompson's Essay on Bee-keeping, 390
 Time for Manipulations, 397
 Tits and Bees, 455
 Tombstone, Bees in a, 183
 Tool, A Useful, 254, 479
 To Paste in Your Hat, 392, 417, 418
 Total Honey Imports for 1908, 77
 Total Rainfall for 1908, 10
 Trade Catalogues Received, 119, 137, 159, 207, 228, 258
 Transferring Bees, 60, 110, 120, 130, 150, 169, 217, 260, 349, 358, 409
 Transferring Bees from Skeps, 208, 319
 Transferring Themselves, Bees, 247
 Transporting Eggs, Bees, 227, 245
 Tree-Planting for Bee-Pasturage, 27, 171
 Two Queens in One Hive, 203
 Two Queens with One Swarm, 305, 385, 426
 Two Stocks in One Hive, 310
 Uncapping Apparatus, Simmins', 17, 34
 Unfinished Supers, 328
 Uniting Bees, 217, 329, 349, 399, 419
 Uniting Bees, Failure in, 316
 Uniting Swarms, 310
 Useful Hints 236
 Utilisation of Wax-Residues, 41
 Utilising Driven Bees, 168
 Utilising Partly-filled Sections, 168, 179, 440
 Vacant Ground for Bee-Flowers, 9
 Vagaries of Swarms, 214, 226, 326
 Value of Lime Trees, 176
 Value of New Combs, 363
 Virgin Queens, Introducing, 324
 Visit to Dr. Miller, 147
 Vitality of Bees, 35, 56, 67
 Warmed Water for Bees, 49, 126, 146
 Warwickshire, Bees in, 197, 265, 305
 Wash for Fruit Trees, 89
 Wasps, 406, 407, 416, 426
 Wasps and Flies, 383, 406
 Wasps, A Plea for the, 367, 384
 Water for Bees, 11, 49, 126, 146, 169
 Water-Heater, A Cheap, 136
 Wax-Analysis, Calorimetric Method of, 41
 Wax and "Wax Craft," Dr. Miller on, 156
 Wax, Colour of, 338
 Wax-Extracting, 28
 Wax-Gathering in Malaya, 377, 387
 Wax-Moth, 91, 219
 Wax-Moth in Combs, 139
 Wax-Moth in Sections, 440
 Wax-Moth, Remedy for, 471
 Wax-Mould, 420
 Wax-Rendering, 24, 27, 34, 38, 102
 Wax-Residues, Utilising, 41
 Wax-Secretion, Involuntary, 493
 Wax, Sterilising, 459
 "W.B.C." 74
 W. Broughton Carr, The Late, 51, 74, 75, 77, 97, 98
 W. B. Carr Memorial Fund, 94, 114, 144, 178, 184, 193, 202, 212, 253, 282, 292, 298, 313, 332, 362, 438, 445, 462, 512
 "W.B.C." Hive, The, 97
 Weaklings, Building Up, 288
 Weather Reports, 10, 60, 99, 149, 217, 247, 299, 327, 358, 429, 449, 489
 Weather, Variable, 205
 Weed-Killer, A Cheap, 324
 Were There Bees in the Garden of Eden? 391, 394, 417, 418
 What the Bees Think, 427
 White Patches in Granulated Honey, 50
 "Wilkes" Queen-Excluder, 427, 448, 457, 468
 Winter Bee-Work, 36
 Winter Feeding, 495, 499, 509
 Winter, Preparing for, 353
 Winter Passages, Providing, 440
 Winter Stores, 3, 49, 389, 398, 427
 Winter-Vestibules on Hives, 22
 Wintering Bees, 309, 359, 368, 369, 419, 420
 Wintering on Shallow-Frames, 390
 Winters, Mild, 155
 With the Critics 66
 Women's Agricultural Union, 9
 Women's Horticultural Union, 276
 Woodbury, Death of Mrs., 148
 Worker Wills But the, 213
 Working for Increase, 131
 Wren, The Late Mr. L., 297
 Youngest Lady Bee-keeper, Onr, 166
 Young Queen Twice Mated, 396
 Zander on Diseases of Bees, Dr., 351, 421, 455

LIST OF CONTRIBUTORS.

- Avery, G. W., Croft House, Heads Nook, Carlisle, 7, 15, 46, 75, 105, 126, 146, 175, 184, 325, 383, 437, 466, 487, 501
- Bertrand Edouard, Nyon, Switzerland, 105
- Betts, Annie D., Camberley, 534
- Blow, T. B., Shimu, Kyoto, Japan, 124
- Breach, F. W., Chinipas, Mexico, 246, 426
- Bullamore, G. W., Albury, Herts, 46, 115
- Calvert, C., Cheltenham, 8
- Campbell, H., Cookham, 325, 345
- Coates, W. G., Rugby, 367, 373, 446
- Crawshaw, L. S., Norton, Malton, 15, 48, 68, 88, 108, 118, 138, 157, 178, 197, 216, 237, 257, 277, 297, 316, 346, 378, 397, 418, 427, 438, 448, 478, 499, 509
- Downes-Shaw, Rev. A. D., Fakenham, 37, 505
"D. Y.," Dunaskin, 24
- Edwardes, General Sir Stanley, Hawkhurst, Kent, 85
- Egglestone, J. W., Bishop Auckland, 86, 356
- Ellis, J. M., Ussie Valley, N.B., 35, 205, 284, 417
- Gray, J., Long Eaton, 187, 207, 267, 307
- Green, A., Notts., 264, 363, 355, 377
- Grose, R., Bodmin, Cornwall, 186, 276, 376, 455, 477
"G. S. X.," Godstone, 115, 504
- Hall, H., Bishop's Waltham, Hants, 456, 476
- Harris, A., Wavendon, Bucks, 27, 148, 205, 364, 426
- Harrison, T. N., Nottingham, 47, 166, 204, 327, 386
- Hastings, S., Johannesburg, 25
- Hepburn, G., Sutton, Surrey, 202
- Herrod, W., Luton, 184, 438, 448
- Jordan, S., Bristol, 314, 327, 354
- Kuckuck, Dr., Bordighera, Italy, 54, 64, 77
- Lamb, J. B., London, 183
- Lloyd, E. L., Inner Temple, E.C., 164, 382
- Macdonald, D. M., Banff, N.B., 2, 22, 38, 45, 66, 84, 98, 102, 127, 134, 154, 167, 175, 192, 206, 212, 223, 233, 246, 254, 274, 287, 302, 324, 338, 343, 352, 398, 392, 415, 427, 455, 453, 459, 472, 493
- Martin, H., Dannhauser, Natal, 344, 367
- Matthews, F. E., Northfield, 184, 236, 286, 337, 395
- Miller, Dr. C. C., Marengo, U.S.A., 156
- Moir, J. W., Edinburgh, 137
- Morgan, H. O., Bristol, 292
- Neve, Dr. E., Kashmir, India, 365
- Newstead, R., School of Tropical Medicine, Liverpool, 97
- Odier, P., Nyon, Switzerland, 6
- Oettlé, G. S., Johannesburg, 105
- Pearman, J., Derby, 266, 306
- Pratt, E. L., Swarthmore, U.S.A., 98, 452
- Rathborne, H., Trieste, Austria, 185
- Salmon, A. W., Chingford, 166, 275
- Schroder, A., Trieste, 147, 417
- Sharp, Allan, Brampton, 116
- Silver, J., Croydon, 14, 235, 243
- Simmins, S., Heathfield, Sussex, 3
- Sladen, F. W. L., Ripple Court, Dover, 96, 448, 481, 497, 507
- Sleight, Tom, Danesmore, 244, 355
- Smallwood, J., Hendon, 146, 177, 194, 225, 235, 254, 394, 456, 494
- Soal, S. P., Roehford, Essex, 56, 67, 76, 117, 127, 274, 283, 303, 326, 374, 395, 407, 437, 476
- Taylor, D. S., Ilminster, 87, 397
- Tere, Dr., Marburg, Germany, 92
- Thomas, G., Pembroke, 127, 156, 473
- Till, E. D., Eynsford, Kent, 375, 426
- Wakerell, A., Croydon, 117
- Walker, Lieut.-Colonel, Budleigh Salterton, 31, 42
- Watson, H. J., Banff, 285
- Watson, W. S., Durham, 13, 36, 195
- "W. F. I.," Ballindalloch, 305, 385
- Whyte, R., Glasgow, 377, 387, 417
- Wiemann, W., Erdington, 196, 265
- Wilcox, H., Alton, Hants, 305
- Woodley, W., Beeton, Newbury, 12, 34, 56, 75, 95, 145, 165, 183, 263, 313, 353, 373, 405, 424, 486, 505
- Zander, Dr., Erlangen, Germany, 351, 421, 455
- Zehetmayr, W., Twickenham, 226, 376

ILLUSTRATIONS.

- A Japanese Apiary, 125
- "Alexander" Improved Floorboard Feeder, 376
- Ancient Egyptian Coin, 397
- A Novel Bee-Hive, 215
- Automatic Smoker, 355
- Bee-Exhibits at German Show, 295
- Carrying Bees on Motor Cycle, 395
- Carrying Queens in Tubular Cages, 4
- Chart of Honey Secretion, 465
- Cheap Extractor and Water-Heater, 137
- Chyle-Stomach of Diseased Bee, 422
- Corrugated Paper Packing-Case, 283
- Curious Old Smoker, 355
- Dr. Miller in his Apiary, 147
- Electrical Swarm Alarm, 185
- German Hives, 295
- Hive-Construction, 87
- Hive Infected with Nosema Spores, 423
- Hive-Scraper, A, 479
- Improved Floorboard Feeder, 455
- Manipulating a Frame-Hive in Japan, 125
- Model Apiary in New Zealand, 495
- Monsieur Oreggia's Honey-Moons, 151
- New "Free-way" Excluder, 186
- "Now is the Winter of Our Discontent" 501
- Old-fashioned Skeps on a Dutch Heath, 177
- Part of Mr. J. Clayton's Apiary, N.Z., 475
- Pears, Cross- and Self-Pollinated, 403, 404
- Picking Queen Off a Comb, 267
- Pollen Damaged by Rain, 404
- Protecting Hives from Storms, 419
- Rainproof Roof, 276
- Ripple Court Apiary, 307
- Simmins' Multiple Uncapper, 17
- Testing Strength of Foundation, 127
- The Apiary of the Rock, 195
- The "Carver" Section-Glazing Machine, 79
- The "Hunter" De-capping Instrument, 69
- The Late Mr. W. Broughton Carr, 61
- The Late Mr. W. H. Harris, B.A., 5
- The Late Mr. G. Wells, 159
- The Late Mr. L. Wren, 297
- The "Silver" Reversible Floorboard, 99
- View of Mount Peel, New Zealand, 475
- Youngest Lady Bee-keeper, 167
- HOMES OF THE HONEY-BEE:—
- Apiary of Mr. H. L. Attridge, Stickland Siding, Cape Colony, South Africa, 455
- Apiary of Mr. Hans Matthes, Breukelen, Holland, 176
- Apiary of Mr. F. W. Spratling, Haconby, Lincs, 485
- PROMINENT BEE-KEEPERS:—
- Mr. T. B. Blow, 261
- Monsieur U. Gubler, 161
- Mr. I. Hopkins, 491
- Dr. Ul. Kramer, 321
- Mr. D. M. Macdonald, 191
- Dr. C. C. Miller, 221
- Lieut.-Colonel H. J. O. Walker, 111
- Mr. Wm. Woodley, 441

THE
British Bee Journal

No. 1385. Vol. XXXVII. N.S. 993.] JANUARY 7, 1909.

[Published Weekly.]

OUR JOURNAL AND ITS WORK.

In commencing another year's work of advancing, to the best of our ability, the interests of British bee-keeping, we may be allowed to allude with pardonable pride to the thirty-sixth volume of the **BRITISH BEE JOURNAL**, now completed, in proof that it has fully sustained its character as representing all that is best in the craft. We may also aver without fear of contradiction that the **B.B.J.** is unique in many respects. The only weekly bee-journal in the world, it stands practically alone in keeping its readers acquainted with the progress made in both hemispheres with regard to the practice and science of bee-keeping. There is scarcely a corner of the civilised world to which our little paper does not find its way, being sent regularly to readers in Australasia, United States and South America, Canada, to China, Japan, Asiatic Russia, South and East Africa, practically all the European countries, and to many subscribers in far-off India.

For copiousness the index issued last week exceeds any previous one, and therein will be found enumerated the cream of what has been said and done in the bee-world both at home and abroad. No other journal has kept its readers so fully informed on the subject of foul brood, the investigations of the most advanced scientists being reported, and the latest books in all languages written by them being carefully reviewed. It is highly gratifying, on the other hand, to observe that Continental journals quote extracts and copy whole articles from our pages more frequently than from any other paper, showing that the **B.B.J.** is appreciated abroad as much as, or perhaps more than, at home.

So much for the past. With regard to the future, we shall not spare any effort tending to keep the paper up-to-date, and in response to many requests we have made arrangements to include among the special features of the new volume for 1909 a series of portraits of "Prominent Bee-keepers of the Day," thus affording to readers an opportunity of seeing the faces of those with whom they are familiar through their writings only. We hope to include most of the best scientific and practical bee-men, well-known in-

ventors and manufacturers of bee-keepers' requisites, and even those editors of bee-journals not too modest to appear in print. At the same time it is not intended to discontinue the "Homes of the Honey-bee" pictures, which feature of bee-journalism originated in the **B.B.J.**, and, we are glad to say, has been copied by most other bee-papers.

On the whole, the work of the year now ended, as chronicled in our pages, has been satisfactory, and the outlook is very promising. The Board of Agriculture is favourably disposed towards the industry, and to the parent Association which acts as its representative, and if the recommendation of the Parliamentary Committee appointed by the Government some time ago to investigate the condition of agriculture is carried out by affording financial assistance to the bee-industry, the work of the **B.B.K.A.** will be extended in various directions, to the great advantage of the pursuit.

In conclusion, we thank our contributors for the valuable assistance they have rendered during the past year, and our readers for the cordial expressions of goodwill and encouragement contained in almost every letter received. In return, we wish health, happiness, and prosperity throughout this year to all engaged in the craft.

THE EDITORS.

REVIEWS.

Die Rassenzucht der Schweizer Imker. By U. Kramer.—This excellent book was reviewed in **B.B.J.** for July 23 last, and we are requested to mention that the publisher is Paul Waetzel, Freiburg i. B., Germany, from whom it can be obtained for 3s. 2d., post free.

Hawaiian Honey. By D. L. Van Dine and Alice R. Thompson (Bulletin No. 17, Hawaii Agricultural Experiment Station. Published by the U.S. Department of Agriculture, Washington, D.C.).—This bulletin treats of the sources and characteristics of Hawaiian honeys, and mentions the different types in commerce. We are informed that the investigations have been carried out because Mr. Van Dine was informed by bee-keepers that Hawaiian honey was not favourably received on the mainland and in the London market. The investigations show

that while one type of honey does depart widely from the present official definition of honey, it is from a source and character little understood up to the present time. Hawaiian honeys consist of two distinct types: (1) A floral product, which compares favourably with the official definition of honey and is derived from the flowers of *algeroba* (*Prosopis juliflora*); and (2) a honey-dew product very decidedly abnormal in its chemical composition. Between the two types, and partaking of some of the characters of each, are natural honeys that are the result of some of the bees in a hive visiting flowers where floral nectar is gathered and others visiting sugar-cane where honey-dew is collected. The nectar and honey-dew are deposited together in the comb, and the character of the product is determined by the relative proportion of the two collected and stored by the bees, so that Hawaiian honeys show every gradation from the pure floral product to that derived wholly from honey-dew. The total production of honey in 1907 is stated to have been 600 tons, and of this 200 tons was *algeroba* honey, and 400 tons either distinctly honey-dew or honey-dew and floral honey with decided honey-dew characteristics. *Algeroba* honey is nearly water-white in colour, of a delicate flavour, and solidifies soon after extraction. There are other flowers, but the honey from them is lost in the much larger amount derived from *algeroba* and honey-dew when produced on a commercial scale. The second part of the bulletin treats of the chemical composition of Hawaiian honeys and their analysis.

Correspondence.

The Editors do not hold themselves responsible for the opinions expressed by correspondents. No notice will be taken of anonymous communications, and correspondents are requested to write on one side of the paper only, and give their real names and addresses, not necessarily for publication, but as a guarantee of good faith. Illustrations should be drawn on separate pieces of paper. We do not undertake to return rejected communications.

Communications relating to the literary department, reports of Associations, Shows, Meetings, Echoes, Queries, Books for Review, &c., must be addressed only to "THE EDITORS of the 'British Bee Journal,' 8, Henrietta-street, Covent Garden, London, W.C." All Business Communications relating to advertisements, &c., must be addressed to "THE MANAGER, 'British Bee Journal' Office, 8, Henrietta-street, Covent Garden, London, W.C."

AMONG THE BEES.

[7335.] *Intermixture of Bees.*—Recent experiences lead me to the conclusion that bees from neighbouring hives intermix far more than is generally supposed. When all colonies are headed by queens of the same race—either blacks, Italians,

or any other—this passes without notice. My blacks, however, found their way in small numbers into hives headed by yellows, and yellows in considerable numbers intermix with the other bees in the same line, even in colonies at considerable distances. The habit, it appears to me, begins at an early age. When taking their first flight bees circle considerably in front of hives, and in home-coming are not too discriminating in returning to that in which they were reared. It is a well-known fact that young bees are made free of any hive. While guards spy strangers, and generally resent their intrusion—sometimes *à la mort*—they give a free pass at times to a loaded bee returning from foraging, and *always* to bees of tender age, come from where they may. I noticed this fact first in watching the peculiar conduct of very young bees of a Cyprio-Carniolan stock. They seemed to leave their hives before they were quite fit to take wing properly, so when they had circled for a time they mixed promiscuously with other bees, and with perfect abandon rested thankfully on any flight-board, while they treated any hive as their future home. Consequently, three on one side and two on the other of their natal home had a very considerable sprinkling of these bees. Subsequent observations during the last few seasons have confirmed me in the belief that this practice of intermixing is far from an uncommon one in all races.

Driven Bees.—Please, Mr. Sinfield, point out *one* single "error" in my contribution (7210), and I will withdraw it, and, moreover, beg your pardon. In your letter (7314) you fail to confute any statement I made. You make some counter-statements, that is all, and you end by practically endorsing my valuation of a driven lot of bees, merely making it 15s. instead of my 16s. I have no objections to accepting the lower sum as a typical one. Still, I repeat, my figures were precise and definite in regard to the four lots originally used to illustrate my point. If they cost me the sum named—as they did—why should I quote a lower price? The reasoning appears to me lame. "Working out figures approximately would appear to me like 'manipulating' them." Somehow, Mr. Sinfield's letter reads as if I had endeavoured to wrong him or "complained." Not at all. My article distinctly recorded, "All the four lots *are doing well*," and, from first to last, nothing personal was included. This writer, Mr. Crawshaw, and one or two others have written as if I had condemned "condemned bees," and several contributors have put on record that they do well with them. I don't now, and never did, seek to prove the contrary. All I desired was to show that there are degrees of com-

parison. Driven bees are good, medium swarms are better, and good and early swarms are *best*. I said in my article, "Of all things in an apiary, empty hives are the most unproductive." I would repeat and emphasise this, and would further counsel any with such on hand at the end of the season, after swarms cannot be got, to obtain a lot of driven bees in the all but full confidence that they will pay handsomely the following season. I have acted on this advice for years and given it to hosts of inquirers, as many who deal in driven bees well know.

"*Cappings of Comb*."—Our friend who wields the uncapping knife must not conclude that I do not read his lucubrations because I have passed them by unnoticed for so long. On page 397 he says, "I do not quite follow your figures and reasonings." That is so. Under similar circumstances I give such matter a second reading, and generally get the needed light. Personally, on re-reading my article on "Swarms *v.* Driven Bees," I discover no ambiguity. Now, please, pass on to page 438. I never said driven bees are of "little value." My whole reasoning went to deduce that early swarms are *immediately* productive, whereas we have to wait about a year for profit from driven bees; in other words, they are unproductive the first season. That is all.

Queen-introduction.—Our friend is *unorthodox*. I performed the operation at *dusk* in the "orthodox" fashion. He would do it apparently in the dark. Even then I question whether the queen would behave just as she did. But, dear "L. S. C.," don't you know that about the close of June we have no *darkness* up here?

Trifles (page 414).—I thought bees were creatures, not creators. *Another*: You are simply assuming that they were "properly capped." *Yet another*: You in Yorkshire surely don't put all your eggs in one basket, nor all your honey in one package! We don't here. We are in this "up-to-date."

A Swell Affair.—I fail to see the point. If there is any joke, it lies so deep down that it would take a "surgical operation" to make it perceptible. "Like a tale of little meaning, though the words are there."

Gleanings.—"There are two ways of reading a book: the butterfly way and the bee way. The butterfly lights a little while here and a little while there, hurrying away before it has got rightly down on it; but the bee settles down and won't rise until it sucks all the honey out of the flower." (From "Laird Nicoll's Kitchen.")

"Birds and flowers were a perfect hobby with the old man, and I may add bees, for his garden was like a miniature

stack-yard, with its multitude of bees' skeps." (Ditto.)

"First my wife died, and that was no' the worst, for then I lost my old sow. I was real fond of that sow, I was. I believe her died out o' spite, 'cause I whispered the death of my wife to the bees an' forgot her. 'Pinion held to the old Kentish notion of whispering news of death to the stock as if it were a doctrine of the church." ("Running Horse Inn.")

1. "'Fine day, Mrs. Quilliam.' 'It was doing a fine day, ma'am, but the bees is coming home,' said Tom." 2. "Black Tom was varying the exercise of pounding rock sugar for his bees with breaking his playful wit on the women." 3. "Take your overcoat, then, for the clover is closing." 4. "The voices were smothered for a moment, as the buzzing is when the bees enter the hive." 5. "She is sweet as clover with the humbees humming over it." 6. "They are coming like bees a-swarming." ("The Manxman.") — D. M. M., Banff.

DIRECT INTRODUCTION OF QUEENS.

[7336.] A new generation of beekeepers has arisen, and the **BRITISH BEE JOURNAL** has come under fresh management since I first offered this plan of introduction without caging, in the early eighties of last century, when considerable controversy was raised over the question in the pages of this old-established journal. It was in 1883 I first disclosed the fact that a queen could be more certainly introduced to a colony if kept quite alone for a few minutes previously; but it was not until the publication of my 1886 pamphlet that I laid down the rule of thirty minutes' solitary confinement without food, recently referred to by "D. M. M." as the "orthodox" period of probation. But to be quite orthodox, as Mr. Crawshaw (page 439) reminded your readers, the queen should be inserted at dusk. A queen will rarely fly so late, or, if she did, would scarcely find her way to the hive already prepared for her. I frequently advise to leave the operation so late that a lamp is necessary.

"D. M. M.'s" experience (7224, page 391) is by no means a solitary one, as correspondents have sometimes reported a similar adventure, though in other cases, unfortunately, queens have flown, never to be caught again. There is, of course, nothing remarkable in a queenless stock accepting a "probation" queen at sight, nor is there any reason why she herself, naturally returning to the same spot, should not notice the excited state of the queenless bees, and that commotion just then intensified by the recent disturbance. The remarkable thing would

indeed have been if she had not made her home with that stock.

A queen that flies from a cage need seldom be lost, as, unless a very strong wind is blowing, her habit is, as with workers, to return to the starting-point, and if the hive is left uncovered she is almost sure to go in with the bees; or, if the owner is quick enough, he may catch her as she circles around in gradually narrowing range as she becomes tired. This fact should be comforting to the novice, who might otherwise be worrying about his silver, which he imagines to be suddenly melting away.

But queens should be handled carefully, or, better, not handled at all, if possible. I at first advised the use of the "safety" matchbox for holding the queen alone, and then placing it carefully under the quilt with the farther end pushed out about half an inch at the last moment; the box inverted, and the opening of course over the space between two frames. I soon found my tubular queen-cage better adapted to the purpose. I could carry several queens around



CARRYING QUEENS IN TUBULAR CAGES.

on the tips of my fingers, as shown in the illustration, and, after smoking under the quilt of each queenless hive or nucleus, the cage with its queen was just laid between two combs resting upon the sealed food on either side, and the quilt rearranged before the queen had a chance to go astray, if so inclined.

When first introducing this tubular

cage to the notice of bee-keepers, I showed how virgin queens could be inserted by pressing the open end into thin foundation, thus cutting out a circular piece and stopping the opening; when, strange to relate, the confined queen treated this wax covering exactly as she had done the capping over her original cradle, biting a circular opening in the same manner within a few hours.

I recently explained how the same cage could be used by pushing the open end directly into the stores so as to keep the queen in as long as desired, and I may say it is most suitable for inserting virgin queens; but one of the best features in connection with this cage is that a queen may be removed from the comb when required, or from a mailing cage, without handling her. The open end is carefully placed over the queen, and soon she is running up the tube, when it is lifted and the finger placed over the opening. In this way I have frequently picked up a fertile queen from her own hive, and placed her immediately into another hive, at the same moment removing the queen from the latter. It is all done quietly, without undue fright, and the bees and queen are almost unaware of the change, if indeed at all.

Of course, this "immediate" introduction will not answer with queens arriving in a mail cage. The bees in the same apiary are in similar condition, and the queens thus exchanged would be in prime order; but, nevertheless, this will not always ensure a successful union if the queen is picked up with the fingers—a bad practice at any time.

I am often asked if there is any danger in keeping a queen alone longer than the orthodox half-hour prescribed by me, as sometimes it is not convenient to introduce just at the expiration of that period. A queen may certainly be alone without food for an hour with safety, but it is not advisable to extend beyond this double period of probation, though I will not say that a queen can be permanently injured if she be alone—and warm—for five or six hours. A fertile queen may remain unfed and alone in a temperate atmosphere for twelve hours and more, and still be alive and, after feeding, lively, but not very serviceable.

A virgin queen must have a good feed the moment she hatches, or when mature and not allowed to escape from her cell is fed by the workers, otherwise she will soon die; but she may thereafter be treated to sixty minutes' solitary confinement before being given to a nucleus; but the half-hour is sufficient.—SAMUEL SIMMONS, Heathfield, Sussex.

(Correspondence continued on page 6.)

Obituary.

WM. HETHERINGTON HARRIS, B.A., B.SC.

It is with the sincerest sorrow that we have to announce the death of Mr. W. H. Harris, B.A., B.Sc., which took place at his residence, The Shrubbery, Hayes End, Middlesex. Mr. Harris had been in a delicate state of health for a considerable time, but became very ill on December 10, being stricken with a paralytic seizure, which left him speechless and in a semi-conscious state, from which he

nineteenth year took his B.A. degree at the London University. Although he had a personal predilection for the medical profession, Mr. Harris loyally gave up the idea of following this inclination in order to assist his father, whose health at that time was failing. Being fond of natural science, our late friend became a Fellow of the Geological Society, and the Albert Institute at Windsor naturally found in him an ardent supporter. In June, 1859, Mr. Harris married the eldest daughter of the Rev. John Stoughton, D.D., of Kensington, and a few years afterwards



THE LATE WILLIAM HETHERINGTON HARRIS, B.A., B.SC.

never recovered, and he passed away on the morning of Sunday, December 13.

The late William Hetherington Harris was born on August 14, 1838, at Abingdon, Berkshire, where his father, Mr. W. R. Harris, had a private school. The family removed to Windsor when he was quite a child, and his father established Clewer House School, which ultimately became one of the most successful institutions of its kind in the neighbourhood. Mr. Harris was himself educated there, although for a time he attended the London University School, and in his

took his B.Sc. degree. In 1870 his father retired from scholastic work, and Mr. Harris then took control, moving into the school-house, where he resided for thirteen years. But his health eventually failing, his medical adviser insisted upon his giving up altogether the arduous work in which he was engaged, and the family then removed to Ealing. He did a good deal of examination work during his fourteen years' residence at this place, and taught in a number of ladies' schools, being also lecturer at several colleges. It was again owing to urgent reasons of

health that these duties had to be abandoned, and the family then removed to Hayes. Although Mr. Harris had many and varied interests, as was to be expected of one possessed of his learning and culture, the keynote to his character may be gathered from the fact that he placed his work in connection with the British and Foreign Bible Society before all his other public duties. He was a member of the parent committee of that society for seventeen years, and was also chairman of the organisation committee.

Mr. Harris took considerable interest in rural pursuits, bee-keeping being a special hobby of his. In 1884 he wrote "The Honey Bee: Its Nature, Homes, and Products," published by the Religious Tract Society, and in 1890 he was elected on the Council of the B.B.K.A., of which he has ever since been a valued member. He was also a member of the Board of Examiners, and gave valuable assistance in connection therewith, although for some time unable to attend the meetings owing to his delicate state of health. When present, his remarks were always listened to with marked attention, and, owing to his sound judgment and experience in educational matters, carried considerable weight. His booklet on "Bees and Bee-keeping" has been widely circulated by the B.B.K.A. A regular reader of this journal, he was a frequent contributor to its pages, and was also chairman of the Middlesex B.K.A.

Mr. Harris was frequently invited to lecture in connection with the bee-industry, one of his appointments being that of lecturer on bee-keeping at Lady Warwick's College, Reading. He also undertook a deal of examination work, and was at one time a presiding examiner at Mason's College, Birmingham, and for the College of Preceptors. It was perhaps natural that he should interest his neighbours in the uncommon pursuit of bee-keeping, and his efforts in this direction resulted in the formation of a village bee-club, with Mr. Harris as the moving spirit and guide. At regular intervals he had the members of the club at his house and gave them "talks" on bees and explanations connected with their hobby.

Coming of old Puritan stock on both sides of his family, it was also to be expected that Mr. Harris would take a prominent place as a Nonconformist in religious work; we therefore are not surprised to find him an elder of Providence Presbyterian Church at Uxbridge. Kind and considerate in all things, he was ever ready to help, and, being the most genial of men, his circle of friends was a very wide one. Staunch in his friendships, he was held in the deepest esteem for his own sterling qualities and fine character. Per-

sonally, we feel the loss of a friend with whom we have been in close touch for many years, and having many interests in common; indeed, we quite recently had a most sympathetic letter from him.

There are three sons and three daughters, together with their mother, left to mourn the loss of a worthy husband and father, and we are sure all our readers will join us in sympathy with them in their bereavement.

(Correspondence continued from page 4.)

BROOD-DISEASES OF BEES.

MUMMIFIED FOUL BROOD.

[7337.] We were able to verify the presence of *mummified brood* (see B.B.J. of November 7, 1907, page 442) in several of our hives last year, more particularly in those colonies which were raising large quantities of drones; the brood, being more or less forsaken by the workers, was considerably affected just at the time that the flow of nectar was beginning to fail. No remedy was tried, as we knew of none, except that we removed pieces of comb containing the affected brood. The disease disappeared entirely by the month of August.

With regard to the other disease which was present in our hives, and which we submitted to you for your opinion (described on the same page as that alluded to above), we have nothing to report of a definite nature, and are no nearer than we were before as to the cause. Fortunately, it did not trouble us much last year, so that we have not had the material to send you for examination. We think it must be attributed to the brood being badly or insufficiently fed by the bees, owing to unfavourable atmospheric conditions. Unwholesome food and scarcity of water and pollen are certainly primordial causes. At a certain time during the great drought, when water was put in their food, the malady diminished, and the same thing happened as soon as the bees found pollen, which was previously absent, or nearly so, in the hives having the disease. Syrup medicated with a too strong dose of formic acid also aggravated the trouble, which at once diminished when the combs in which this medicated syrup was stored were removed. In any case, as both yourself and Dr. Burri told us, this disease is not a bacterial one. We have utilised all the frames of comb which have contained diseased larvæ, and not in a single case has the disease broken out again. Three colonies from one of our most affected apiaries, transported to another, are doing wonderfully well, and have not shown a single diseased larva during all the season. Crowding the bees on as few combs as possible,

feeding abundantly, and placing pieces of naphthaline in the hives are the means that have generally succeeded in hastening the cure. Pea-flour has no effect when natural pollen fails. Syrup medicated with formic acid in the proportions recommended caused the same symptoms to appear last year, probably owing to the percentage of the acid in the solution being greater than that stated by the dealer who supplied it to us. After the bees had rapidly stored the medicated syrup they became ill, and some of the colonies were changed the disease was at once arrested and disappeared. — P. ODIER, Nyon, Switzerland.

PURE RASPBERRY HONEY

AND RAPID GRANULATION.

[7338.] I read in B.B.J. for December 17 (7315, page 506) a question asked respecting honey gathered from raspberry blooms in the Blairgowrie district granulating very quickly. In reply let me say I have an apiary of seven colonies at the English Fruit Preserving Company's Fruit Farm, Stocksbridge, near Sheffield, where there are grown, amongst various other fruit-bearing plants, about twenty-six acres of raspberry canes. And ever since my bees have been located there my experience has been much the same as that of our friend in Blairgowrie, although I work only for extracted honey. I have seen on not a few occasions when a jar could be inverted within fourteen days of its being filled, and it would not run out, being granulated quite solid. Name enclosed for reference.—W. B., Wankley, Sheffield, December 31.

A CHRISTMAS DREAM.

[7339.] It was the eve of Christmas the bee-man sat in his chair by the fire asleep, while at his feet lay scattered the literature with which he had sought to while away the long hours of enforced inactivity. Cowan, Edwardes, Maeterlinck were for the nonce forgotten, and his thoughts had taken wing and soared away in a beautiful dream of days long gone by.

And the friendships old and the early loves
Come back with a Sabbath sound as of doves
In quiet neighbourhoods.

In fancy he sat once more under the shade of the old laburnum tree, golden with its robe of summer beauty, listening to the music of the brook, which bickered noisily over its pebbly bed to join the placid waters of the river. From the meadows came the scent of new-mown hay, which mingled with that delicious indescribable aroma only to be enjoyed

amid the prosperous dwellings of the busy honey-bee. Around him stood the ancient domes of straw, each topped with its neat, well-cut rod of good old turf, and teeming with their thronging multitudes of strenuous toilers. The singing thousands in the air made music so beloved of all genuine bee-men.

A slumberous sound, a sound that brings
The feelings of a dream,
As of innumerable wings,
As, when a bell no longer swings,
Faint the hollow murmur rings
O'er meadow, lake, and stream.

But hark! Another sound breaks in upon his dream—a sound so shrill and clear, made more realistic by the accompaniment of some tangling instrument, which starts the dreamer into instant activity. A swarm! No; it is only the carol-singers bringing again the old-time message of "Peace on earth and goodwill to men."

When this appears in print the merry time of Christmas and the old year will have gone, and that the New Year may bring many blessings and much happiness to our Editors, their contributors, and readers of the JOURNAL, and to all bee-men, is the first wish of the writer.—G. W. AVERY, Heads Nook, Carlisle, December 26.

EXPERTS' CERTIFICATES.

[7340.] There are many lovers of the honey-bee like myself who would like to go in for experts' certificates. In the county reports one gets an idea of what knowledge is required for these examinations, but no idea of the kind of questions that are likely to be asked. I should therefore be much obliged—and I am sure many other readers of the B.B.J. and *Record* feel the same—if from time to time some idea of the questions likely to be asked were printed in your pages. Even if one does not intend sitting for the certificate, it would be a certain test of one's knowledge of the affairs of *Apis mellifica*.

I have during these holidays been reading "Wax Craft," and it is honestly astonishing what little I knew in a general way of *Cera flava*, though for years I have, as an analytical chemist, tested this for the many adulterants, &c. Wishing the B.B.J. and *Record* a prosperous 1909, I send name, &c.—ARTHROPODA, Aberdare.

[Intending candidates for the B.B.K.A. certificates can have a syllabus of examinations on application to the secretary, Mr. Edwin H. Young, 12, Hanover Square, W. The particular questions asked are largely optional on the part of the examiner, whose object is to test the general knowledge of the candidate with regard to bee-keeping.—Eds.]

SWARMS AND DRIVEN BEES.

[734H.] I am astonished to see in B.B.J. of December 17 (page 506) Mr. T. D. Sinfield declaring that establishing bees from driven stocks is the cheapest and surest way of obtaining good stocks. Is it? Would it not rather be a safer, surer, and more money-making way to invest the 15s. mentioned as the cost of driven bees in a 4-lb. or 5-lb. swarm, in the first week in June? I ask this because this swarm, besides providing itself with sufficient stores for winter, would in any ordinary summer yield 15s. worth of sections as a free gift, as against driven bees costing 15s. I am not taking any account of heather districts. My remarks merely refer to the ordinary bee-keeper located in a clover or sainfoin district, where the harvest is usually over by the last week in July. Nor am I expressing an opinion either for or against driven bees; they are excellent as a means of bringing fresh blood into the apiary by strengthening or by re-queening weak stocks, or for establishing new ones if to be had gratis. I myself rescued forty-eight lots from the sulphur-pit this last season, all of which have been used as stated above.—C. CALVERT, Cheltenham, December 30.

THE SEASON IN NORTH CORNWALL.

[7342.] Although the spring was wet and cold with us up to the latter end of May, the bees were, with a little stimulating, in good form by the time white clover bloomed. On June 1 I lived a fine swarm on ten sheets of foundation. Finding this drawn out in a few days, I put on a rack of sections, which they at once started to work on, so I gave more room to prevent swarming. By the end of the season this swarm yielded me 102 lb. of honey in comb, which I think is a record "take" for this district; in fact, I have never heard of an established stock yielding so much in North Cornwall, where we have to rely entirely on white clover for surplus. I may say just when the forage was at its best in the beginning of July we had about ten days of wet weather, which kept the bees idle at home, so the yield was not so good as if the weather had remained fine. My average "take" from my sixteen stocks has been seventy-five sections per hive.

We see a good deal in the B.B.J. about uniting bees, which to some is rather tedious, and I suppose each man claims his own method as being the best. I have a little plan of uniting which I claim to be as good as, if not better than, any I have yet read of. It is as follows:—If it is desired to unite a driven lot with a weak stock, place a sheet of fine perforated zinc above the frames of the

stock, and set the skep of driven bees on the zinc, wrapping all up warmly. I usually do this in the evening, and next day about the same hour I draw out a slide made to cover a hole about 3 in. square in the centre of the zinc. I have invariably found that by the following evening all the bees have gone below and united peaceably. Of course, one of the queens is removed before uniting. I have united driven bees with queenless stocks by the same method, and never knew it to fail. I find that the little tit has a good appetite for bees, and have thought of catching some of them by using birdlime. I wonder if any of the readers of the B.B.J. have ever caught them in this way; if so, how does the plan answer? I close by wishing all bee-keepers a happy and prosperous New Year. Name sent for reference.—BEE-KEEPER, Cornwall, December 28.

DR. MAASSEN'S BOOK ON FOUL BROOD.

[7343.] If your two correspondents who inquire in this week's issue about Dr. Maassen's book on "Faul-brut" have not yet obtained their copies, I should be pleased to procure them for them if they will write to me. Not knowing the size of the book and cost of carriage, I have fixed the price for the present at 2s. each copy, post free. The work is, of course, in the German language.—W. FRANK, 12, Red Lion Square, Holborn, W.C., January 1.

PROPHETS AND PROFITS.

[7344.] This is the usual season to make up balances, &c., and this year I expect the balances will be very varied to members of our craft. It is amusing to read of the strong feeling excited by the revelation of the profit secured from the Scotch heather harvest. But I am led to ask: Does friend "D. M. M." really think these returns hold good for more than a small area of the British Isles? Who that has seen bees "humming home" across the scented heather, or the seething, frantic crush at the hive during a good clover or sainfoin season, can doubt his written word that "Honey is Money"? Unfortunately, we of the Midland shires know not of these harvests, nor of the natural corollary, "big profits," yet have I kept bees in a very poor locality and touched profit. However, there is something more to be gained from bee-keeping than "siller." A cool place in a ripe old orchard on a hot June day, and the busy, contented hum of myriad workers, make one a bee-keeper for ever.

Coming back to the prosaics of the balance-sheet, the season of 1908 has not been a good one with me. Stocks were

slow in responding to spring treatment, and cold rain spoiled both limes and clover, and returns, therefore, are almost as low as those of the previous bad year. Nothing daunted, I look forward to the year 1909 for compensation, and also trust it may prove a prosperous one to the Editors and readers of the B.B.J.—THOS. E. ATKINS, Leire, Lutterworth.

CITY BEES IN SCOTLAND.

[7345.] My bees did well in 1908, considering that they work in a city. A swarm yielded forty-six good sections of flower honey and a few pounds from the heather. My other hives were pilfered in forwarding bee-craft by starting two observatory-hives for exhibition purposes. One of them was staged in the Scottish Exhibition held during the year, and did very well, exciting much interest among visitors. It occupied a good position in the "Nature-study" section. We had during the time the bees were on view to remove a frame of brood to prevent swarming, but when they got fairly started—which the wintry weather at end of April and early in May made very difficult—the bees worked diligently and thrived exceedingly well. The other observatory was taken to the Newcastle Show, and, owing to an accident, had an unfortunate experience there. The bees of both hives were eventually united successfully by removing both queens, as described in the B.B.J. some months ago.—J. W. MOIR, Edinburgh, December 21.

WOMEN'S AGRICULTURAL UNION.

[7346.] In consequence of the success of the produce stall held at our late annual meeting in November, 1908, we are proposing to hold sales of produce monthly from January to June (inclusive), and again in September and October, 1909. This is to enable our members to sell their goods and obtain orders. These sales will be open to members only. Any of your readers wishing to join the Women's Agricultural and Horticultural International Union, with a view to benefit by these sales, should communicate with the secretary, 64, Lower Sloane Street, S.W., at an early date. The sales will be held on the third Wednesdays of the months specified, the first being held on January 20.

We also propose to organise a public dinner for women farmers and gardeners and their friends, to be held in February next. The secretary will be glad to hear from any ladies interested in agriculture or horticulture who will like to be present on this occasion as soon as possible. Gentlemen admitted as guests.—(Signed) GERALDINE M. BARRY, EDITH L. CHAMBERLAIN, M. BRYANT SOWERBY, Show Sub-Committee.

Queries and Replies.

[3858.] *Queen Cast Out in January.*—1. I send in small box a dead queen and a few bees, and as a reader of the B.B.J. I should be glad if you could tell me the reason why the queen of one of my stocks was cast out along with thirty or forty workers on Saturday, January 2. I re-queened the stock on November 11, and three days later removed the cage, as the queen had left it and gone below. I have not disturbed the hive since. 2. Can you also say if the dead queen has been "balled," or has it died a natural death, or is there any disease in the hive? 3. Would it be advisable to re-queen the stock in spring, or should I unite the bees to another lot? I may say the bees covered about four frames when I closed them down for the winter. Thanking you for a reply, I send name, &c., and sign—A NOVICE, Settle.

REPLY.—1. It is a vagarious and not infrequent incident of bee-life that queens several weeks after being safely introduced to an alien stock are killed and cast out for no reason whatever that can be seen. 2. The queen sent shows no sign of "balling," and is both fully developed and fertile. 3. As the bees only covered four frames when packed down in November, we should unite them to another stock rather than re-queen the colony.

[3859.] *Utilising Vacant Ground for Bee-flowers.*—1. I have got four hives standing on a piece of ground measuring about 20 by 25 yards. This was well dug over last autumn, but nothing has been planted in it, and I shall be glad if you will tell me whether a piece of ground this size will be of any appreciable advantage for growing bee-plants on. 2. I was attracted by the account of crimson clover (*T. incarnatum*) in Roots' "A B C and X Y Z," and should be obliged if you can tell me if it will do well in England. I shall also be grateful for suggestions of any other profitable plants requiring little attention. Appearance is an object. I send name, and sign—MEDICO, Basford, Notts, January 4.

REPLY.—1. The general rule among bee-keepers is to devote any bit of spare ground they may have in the apiary to such flowers as yield either honey or pollen (the latter for preference) at an earlier date than the main bee-forage is yielding anything to the bees. By this means breeding is stimulated, and stocks made strong in bees ready to take immediate advantage of the main honey-flow when it comes. At the same time, the resources of your neighbourhood must be taken into account, because if the natural foliage is good it is almost a waste of money to plant for bees. Apart from the early

forage named above for stimulating, we advise using the ground for a good breadth of mignonette and borage, which would occupy your bees profitably on days when more distant forage was not available. 2. Crimson clover yields honey of uniform quality: it is about on a par with buck-wheat, and neither is satisfactory where honey for later use is worked for.

WEATHER REPORT.

WESTBOURNE, SUSSEX.

December, 1908.

Rainfall, 4.39 in.	Minimum temperature, 13° on 30th.
Heaviest fall, .88 in. on 29th.	Minimum on grass, 11° on 30th.
Ram fell on 20 days.	Frosty nights, 8.
Above average, 1.67 in.	Mean maximum, 44.8.
Sunshine, 44.9 hours.	Mean minimum, 35.1.
Brightest day, 11th, 5.3 hours.	Mean temperature, 39.9.
Sunless days, 15.	Above average, 1.8.
Below average, 13 hours.	Maximum barometer, 30.426 on 31st.
Maximum temperature, 53° on 10th and 13th.	Minimum barometer, 28.782 on 11th.

L. B. BIRKETT.

WEATHER REPORT

FOR THE YEAR 1908.

WESTBOURNE, SUSSEX.

Rainfall, 26.72 in.	Maximum temperature, 82° on June 4th.
Heaviest fall, 1.63 in. on Oct. 18th.	Minimum temperature, 13° on Dec. 30th.
Rain fell on 163 days (average, 176).	Minimum on grass, 11° on Dec. 30th.
Below average, 2.42 in.	Frosty nights, 60 (average, 71).
Sunshine, 1,895.6 hours.	Mean temperature, 49.8.
Brightest day, June 29th, 15.3 hours.	Above average, 1.5.
Sunless days, 47 (average, 60).	Maximum barometer, 30.770 on Feb. 7th.
Above average, 64.4 hours.	Minimum barometer, 28.782 on Dec. 11th.

L. B. BIRKETT.

DECEMBER RAINFALL.

Total fall, 3.73 in.
Heaviest fall in 24 hours, .63 in. on 15th.
Rain fell on 26 days.

TOTAL RAINFALL FOR YEAR 1908.

Total fall, 35.03 in.
Heaviest fall in 24 hours, 2.50 in. on July 15.
Rain fell on 204 days.
W. HEAD, Brillley, Herefordshire.

PRESS CUTTINGS.

THE MISSING WORD.

With curtains closed, beside the glowing fire
read of roses and a turquoise sea;
next door a child whose fingers never tire
drums out "The Honeysuckle and the Bee."
East wind or North, to make the blizzard
sunny,

roses are mine, and bees that gather honey.

—Geo. R. SIMS, in the *Referee*.

HONEYED SWEETNESS.

The secretary of the well-known bee-keepers' association says that the young lady members soon get married. Then these young bee-keepers naturally look forward to the honeymoon.—*London Opinion*.

Notices to Correspondents.

G. E. HORWOOD (Broad Campden).—*The Commonwealth Bee-keeper*.—There is no agent in this country for the paper named to our knowledge. It was at one time the official organ of the Victorian Apiarists' Association, and is now incorporated with the *Australasian Bee-keeper*, and is published monthly by Pender Bros., Ltd., West Maitland, N.S.W., price 5s. per year.

H. G. C. (East Finchley).—*Making the "W. B. C." Hive*.—By carefully following the directions given in the "Note-book" you cannot go wrong, as the measurements on all essential points were corrected by a leading firm who make the hive in large numbers every year. The measurements of parts marked on your sketch-plan are not very important.

E. J. T. (Gowdall).—*Mead-making*.—We should have been glad to give our opinion on your "seven-year-old mead," but, owing to insecure packing, all that reached us was fragments of the broken pint-bottle, drained perfectly dry in transit. Thanks for your good wishes, and we will be glad to have your method of mead-making later on.

Honey Samples.

P. R. B. (Birmingham).—With regard to the two samples of granulated honey sent, No. 1 is of good flavour and is mainly from clover; it has, however, a disagreeable odour, derived probably from some nectar-yielding weed, that detracts from its quality very much. No. 2 is from mixed sources; it is coarse in grain and only of medium flavour.

E. CUTTS (Lincoln).—Sample of honey (?) sent is quite unfit for anything but making blacking of. We should hardly like to use it as bee-food. The rust at bottom edge of extractor will do no harm, but should, of course, be removed before using.

Editorial, Notices, &c.

REVIEWS OF FOREIGN BEE-JOURNALS.

By "Nemo."

Rearing and Introducing Queens.—Adrien Getaz, a Swiss bee-keeper established in the State of Tennessee, writes in the *Bulletin de la Société Romande d'Apiculture* on queen-rearing, not on a commercial scale for sale, but for the bee-keeper who wishes to rear his own queens. He says every bee-keeper worthy of the name should do this, for the professional queen-breeder is not in a position to produce such good ones. The latter has no means of knowing which are his best colonies, because he is obliged to be continually taking their combs of brood in order to form nuclei, or to strengthen colonies containing queen-cells; and it is therefore impossible for him to say which hive would have given the best results in the production of honey. It also often happens that pressing orders compel breeders to force the production of queens by making their bees rear more queen-cells than they can conveniently look after. The process M. Getaz recommends is quite simple. The queen is removed from the colony chosen for rearing queens, and combs of brood from other stocks are added from time to time to keep the colony strong. A comb containing eggs laid by the selected queen is also introduced in the centre, and in this comb rectangular openings are cut, care being taken that the cells immediately above contain eggs. The openings must be large enough for the bees to get round the queen-cells in order to fashion them properly. When the cells have been sealed over for four or five days, they are cut out and placed in cages. They must not be put in the cages too soon, because the bees generally make the coverings of considerable thickness at first, and thin them down after a few days. The cages are suspended between two combs by means of a hooked wire. They must be at least one and a half inches apart, otherwise when the young queens emerge they exhaust themselves in the vain effort to get out to destroy each other.

M. Getaz next describes a simple method of introducing these virgin queens, as follows:—The queen is removed from the hive to which it is intended to introduce a virgin, and two days later one of the cages containing a young queen is plunged in a glass of water so that she is thoroughly drenched; the cage is then opened, and the queen allowed to run into the hive. The cold

bath has two effects on the queen. In the first place, the introduction frequently ends in failure, if the queen is in a bad temper at the time and acts foolishly towards her new subjects. A cold bath, however, causes this whim to disappear. Next—and what is more important—was the fact that sometimes when introducing the queen, instead of running into the hive at once she would take wing and be lost. It was the danger from this that induced M. Getaz to resort to this method. A drenched queen cannot fly away, and has about as piteous a look as a drenched hen. It is quite unnecessary to trouble with preparing nucleus-hives for the fecundation of queens when this plan is followed. Professional queen-breeders are obliged to use nuclei owing to the large number of queens they have to rear, but for the ordinary bee-keeper it is needless.

Water for Bees.—It has been supposed by some that bees visit manure-heaps in the spring for the purpose of obtaining the salts contained in the liquid usually found about such places. A French chemist even went to the trouble of analysing this liquid, and published the proportions of the different salts found therein in order that bee-keepers could prepare a similar liquid to give their bees, free from the natural objection to such disagreeable sources. A correspondent in *L'Apiculteur* relates the experiments he has conducted in order to decide this question. He arranged several drinking-places, some supplied with cold water, others with water kept warm, and others again with the liquid obtained from manure-heaps. He was thus able to satisfy himself that it was warm water that the bees required in spring, it being found that the bees visited the pans of warm water in large numbers, very few going to the other pans. Moreover, the bees filled themselves with warm water much more rapidly than did the others. It thus became clear that the bees sought warmth, which is known to be a very important factor in breeding during the spring months.

Referring to this in the *Schweizerische Bienenzeitung*, M. Spühler, who has repeated the same experiments, confirms the conclusions arrived at, and enumerates the advantages of warm-water drinking-fountains as follows:—1. They save the lives of many bees, because, finding warm water near the apiary, they are spared long and often perilous journeys in search of water owing to the cold winds in spring. 2. They economise the time, husband the strength, and thus prolong the life of the bees. 3. They increase the ardour and activity of the whole apiary. 4. They are more efficient than a feeder on the hive. 5 (and lastly). They avoid

the trouble made by neighbours who complain of being molested by bees in search of liquids.

Distinguishing Pure Honey from the Artificial Product.—According to the *Leipziger Bienenzeitung*, Dr. Fiehe, of Strassburg, has found a method of distinguishing pure honey from that produced artificially. In the inversion of cane sugar with acids it appears that by-products occur, which by decomposition of the levulose can be traced back. These substances, treated with a solution of resorcin in concentrated hydrochloric acid, give quite a characteristic colour reaction (red). Pure honeys do not show this reaction.

HONEY IMPORTS.

The value of honey imported into the United Kingdom during the month of December, 1908, was £3,782.—From a return furnished to the BRITISH BEE JOURNAL by the Statistical Office, H.M. Customs.

Correspondence.

The Editors do not hold themselves responsible for the opinions expressed by correspondents. No notice will be taken of anonymous communications, and correspondents are requested to write on one side of the paper only, and give their real names and addresses, not necessarily for publication, but as a guarantee of good faith. Illustrations should be drawn on separate pieces of paper. We do not undertake to return rejected communications.

NOTES BY THE WAY.

[7347.] With the New Year we again renew our resolve to make it the record year of our pilgrimage through life, each in his little corner striving to make himself and his surroundings brighter and happier. In this direction bee-keepers are ever ready to lend a helping hand to a beginner in the craft when needed. A few practical hints to the novice may spare him not only a considerable outlay in cash, but valuable time, for when one makes a start in a minor industry such as ours the experienced bee-keeper, if so inclined, can, without loss to himself, save the beginner much labour when acquiring his first knowledge of the industry, and thus prove to his neighbour that there is still a brotherhood among bee-men. Members of our craft can therefore meet the New Year with confidence and zest, seeing that *our* journal, as we gather from our Editors' address in last week's issue, is sent to all parts of the world. As a sub-

ject suitable for discussion in these winter months, may I suggest "Wax-rendering and Preparing the Same for the Show-bench"? A review of past times will disclose the fact that our successful wax-exhibitors have time after time received first honours on the show-bench, and I would therefore ask: Cannot some of these (or, better still, all) give their methods of clarifying wax? I mention no names, though many of them are well remembered as pioneers in wax-craft. To such I appeal, and trust they will enlighten our new recruits, so that the latter may not have to undergo that long floundering in attempts to reach even mediocrity on the show-bench.

Handling Queens.—I am very pleased to see the communication of our old and valued contributor Mr. S. Simmins on queen-introduction in last week's issue. His caution as to handling queens I can fully endorse. In fact, I very rarely handle a queen either by wings or between thumb and finger, though I flatter myself I can handle things gently and carefully, having in my early days made watch "movements" needing the use of a pair of tweezers; but a queen-bee being, in my opinion, more delicate still, I generally touch her only with a feather, allowing her to walk on the feather; then she at once is placed where required or into the cage. A white wing-feather is the best for the purpose in my hands.

Planting Bee-flowers.—I think your correspondent "Medico, Basford" (Query No. 3859, page 9), when he is visiting his patients, will find that there is a fairly good breadth of crimson clover (*T. incarnatum*) grown about Basford for early green forage for horses. It comes in early, and when weather is warm it gives a flow of very nice light-colour honey when grown on clay soils [We must repeat our personal opinion of this honey as given last week, notwithstanding Mr. Woodley's view.—Eds.], but for small plots in the garden I think arabis or wallflowers would be more suitable. There is one thing in favour of crimson clover—*i.e.*, when the flowering period is passing over it will make good food for the horse. But it is too late to sow for the coming spring; it is sown by farmers in August or early September for what they call "green-meet" for the horses.—W. WOODLEY, Beedon, Newbury.

SEASONABLE OCCUPATIONS.

TAKING TIME BY THE FORELOCK.

[7348.] When bees have been snugly packed for the winter, many bee-keepers are prone to lay by all appliances pertaining to the craft until the renewed activity of their pets in spring reminds

them of much-needed preparation for the approaching season. The heavy work of swarming-time or during a rapid honey-flow can be materially lightened, and profits increased, by having everything needed ready in its place when wanted for use. The present long dark evenings are the very best in which to overtake some of this work, especially if the bee-keeper has in his household sympathetic minds and willing hands. Procrastination in matters apicultural is a common failing and the cause of much waste of valuable time and honey, which means a money loss to many. When the time comes to open the hives, probably the smoker which was put out of action last season is hastily sought out. Probable result: angry bees, still more angry manipulator, imperfect examination, queen "balled," stock or stocks temporarily checked or permanently ruined. With a good smoker but unsuitable fuel similar happenings are also probable. Proper fuel is of such importance in the busy man's apiary that a sufficient quantity should be prepared now to last the whole season. Waste brown-paper is to be had in every household, or old cloth which can be turned to profitable account as fuel for the smoker. The paper should be well soaked in saltpetre and water: one teaspoonful of saltpetre to a pint of water. Thoroughly dry it, and roll up in small bundles or cartridges to fit the smoker, neatly tied with string, when lay them aside till wanted. This sort of fuel will burn slowly, give a good volume of smoke, and never go out till all is consumed. Probably the first articles found necessary to use are feeders, and no time must be lost in overhauling and repairing the old, and making or purchasing new. Remember that dealers are willing to give large discounts to those who order early; avoid the rush at the eleventh hour, when everything is wanted at once. In the same way, home-made appliances should be started now, or they will have to be hurried over when time can ill be spared. The time-honoured pickle-bottle and bit of muslin is hard to beat as a feeder, and should be made ready now. Quilts also need to be renewed occasionally, and should be seen to. Our women-folk can often make us a free gift of remnants of calico, old carpets, &c. What can be sadder than to see, as I have, stocks of bees covered with filthy and vile-smelling guano bags, where the bee-keeper could have had good clean quilts by asking for them at the proper time? Repairs to bee-veils should be attended to in time. Perhaps some kindly-disposed feminine member of the household only waits for a hint to help the mere man bee-keeper by making him a new veil. This can soon be done with a yard of

Brussels net, costing about 1s., a piece of elastic, and some tape. In fact, a multitude of little things need doing, and all go to make up "the daily round, the common task." of the bee-man. If any hives are to be moved to a new site, this should be done when the bees are confined indoors. The hives should be moved as quietly as possible, and do not forget to place some conspicuous object on the flight-board when the bees leave the hive for the first time, which will cause them to notice their new stand, and so find their way back easily. The worst of the winter may be to come yet, and if there is the least doubt about any hive-roofs being waterproof, examine them after rain and see to repairs at once where necessary. Of all the sins of omission the careless bee-man is guilty of, that of allowing his poor bees to cluster in despair under a wet blanket for days or weeks is one of the worst. Hungry mice may also be seeking food and a warm shelter, and hive-entrances must be made proof against them. When seeking to keep out these pests at this season, do not make the mistake of actually shutting them in, as has been done. Whenever passing the hives, keep an eye on all entrances, and have the orthodox piece of hooked wire ready for freeing the entrances of dead bees. Passing on to things of still greater importance which need to be done during the winter-time, I would briefly mention wax-rendering (see new book, "Wax Craft," by T. W. Cowan), cleaning of all appliances, making and repairing hives, fitting up frames with foundation wired in, making up sections and fitting with foundation, and laying plans for the future management of the apiary. This may seem looking a long way ahead, but the up-to-date bee-keeper cannot afford to do his work in haphazard fashion at the last moment. He must be in advance of requirements. Each day brings its work, and laggards who let things slide because their bees are quiet and making no show of work will end with nothing in the shape of honey or profit. *Ex nihilo nihil fit.*—G. W. AVERY, Heads Nook, Carlisle, January 11.

"DIVISIBLE" BROOD-CHAMBERS.

[7349.] All bee-keepers will be indebted to Mr. Kidd for his explanation of the working of the "Divisible" brood-chamber hive in B.B.J. of December 10 last (page 495), because I am sure there are a great number of bee-men who did not know of the existence of such a hive, and if it has done nothing else it will have made them think. Personally, I have not tried the hive, but in theory it seems to me to go

a long way to solve the problem of better results from the heather. I believe Mr. Kidd and Dr. Ede have been largely instrumental in bringing this hive before the notice of Northern bee-keepers; but, as "the proof of the pudding is in the eating," we shall have to wait and see if results justify their efforts on its behalf. It is, therefore, to be hoped that their experiment will prove a success and be a benefit to all. I have long held the opinion that in order to get a larger return of this "golden honey" harvest our present methods will have to be altered. We in the North practically hold the market for heather honey in England, and each year the demand for it grows greater. I also agree with Mr. Kidd, but in another way, that the B.B.K.A. should give more attention to Northern bee-keeping. It seems to me that we want some enthusiasm put into the business. Why cannot we have the benefit of county council lectures on bee-keeping? I think the last series of lectures under the Durham County Council was given some eleven years ago by Mr. Wm. Crisp, of Eaglescliffe, whose interesting lectures were the means of starting a large number of new bee-keepers. But for some reason the lectures were discontinued, and have remained so up to the present time. Could not the B.B.K.A. use their influence over our county councils to again hold these lectures on bee-keeping, because it is a very important branch of agriculture, besides being an interesting and profitable hobby if followed on right lines.

The past autumn having been mild and open, I resolved to take a peep into a few hives that I knew previously to be full of stores, to see how they were holding out, and I was surprised at the amount of stores consumed. It therefore behoves every bee-keeper to be on the watch and keep a cake of candy in reserve over feed-holes, otherwise a lot of stocks will be lost during the next three months if stores run short.

When snow is on the ground many bees can be saved by using a "tunnel" on the alighting-board from the entrance. It is simply a piece of board about 4 in. long by 3 in. wide, to which is nailed a strip of wood $\frac{3}{4}$ in. square, on the long sides. This is then fastened to the alighting-board, and prevents the sun from shining directly into the entrance; if otherwise, a lot of bees would fly and be blinded by the dazzling snow, and fall and perish. The "tunnel" can be removed if thought necessary when snow is gone.

In conclusion, may I ask, will readers be favoured with photos of prominent contributors to B.B.J., as suggested by several correspondents?—W. S. WATSON, Southview, Wolsingham, Co. Durham.

ABOUT DRIVEN BEES.

[7350.] A few weeks ago I promised a further communication on dealing with driven bees. Mr. Crawshaw, "D. M. M.," Mr. Sinfield, and others have recently touched upon this topic, and in contributing my views I will bear in mind the needs of those B.B.J. readers whose knowledge and experience of driven bees are limited. Those who know all about the subject can, therefore, pass over what follows as not being intended for them. Driven bees are so called because they are driven out of straw skeps during August and September, the honey and wax being appropriated by the skeppist. Early in the season the usual price is 1s. 3d. per lb., but later on it is often as low as 1s., and even 10d., per lb. Some bee-keepers advertise driven bees for sale at so much per lot, without any specified weight; but by this method the purchaser is entirely at the mercy of the seller. I have heard of lots sold in this way which actually worked out at 2s. 6d. per lb. Even when sold by weight, not one lot in fifty will arrive full weight, especially if they have been long on the road. If the purchaser gets $4\frac{1}{2}$ lb. or $4\frac{3}{4}$ lb. of bees on arrival for a 5-lb. lot he should be satisfied; there is sure to be a slight loss in weight by honey consumed and evaporation *en route*.

One of the best methods of sending them is in a large flat-top skep with a hole in the top. Fasten a piece of perforated zinc inside and outside this hole, with two pieces of thick wood for the skep to rest upon, so that a current of air will pass through the skep when resting on the ground. When covered with cheese-cloth, these skeps arranged in this way will easily hold 5 lb. or 6 lb. of bees, and the carriage will not amount to more than 10d. or 11d.; but when sent in a heavy wooden box the carriage frequently amounts to 1s. 10d. or 2s., or even more. Bee-men who deal in driven bees prefer purchasers to send packages, and skeps are more easily handled; while for the benefit of ignorant railway porters the label requires a notice, "Don't cover up these bees. Let them have plenty of air." The most important item in a lot of driven bees is, of course, the queen which survives. Two, three, or four queens are usually driven into one lot; but this method is so happy-go-lucky that the poorest queen might survive. To guard against this it will pay the purchaser to send a queen-cage, self-addressed and stamped, with 6d. or 1s. extra for the trouble, and ask that the queen from the skep which had the most honey and bees and a young queen should be preserved in the driving and sent on by post. This done, she can be introduced

after the lot has been hived for a day, the one sent along with the driven bees being killed.

I suggest this plan because unless a young and vigorous queen survives, the driven bees may turn out disappointing, and I do not know of any more reliable plan than the foregoing for preserving the best queens.

After hiving driven bees it is quite a common occurrence for them to swarm out, especially on a bright day or if two queens are still alive. I have known a lot swarm out three times in two days, and many lots disappear entirely. A strip of excluder-zinc at the entrance for two or three days will prevent this. Supposing you have a 5-lb. lot late in August or early in September, six or seven frames of foundation—close spaced for a few days—will be sufficient. Do not give worked-out comb along with foundation, or they will not touch the latter. If you have some of each, let the bees work out the foundation first, and then add the combs. The bees should be fed gently and regularly for ten days or a fortnight with the idea of getting them to collect some pollen and rear a lot of brood. Change the outside frames nearer the centre to make them work out the foundation better. After about a fortnight of slow feeding, feed rapidly with all you are going to give them: they will take down 5 lb. or 6 lb. of syrup in a night. In selecting and preparing the food for driven bees the greatest care is required; anything will do for spring feeding, but for winter the *best* is cheapest—white cane sugar at the rate of 2 lb. to 1 pint of water. To avoid burning syrup, which will kill bees in cold weather (many lots of driven bees have been killed with burnt syrup), it is, in my opinion, far best to adopt the cold process: simply mix the sugar with the water and stir well occasionally. If possible, add 1 lb. of honey from a healthy hive to every 10 lb. or 14 lb. of syrup, and add six to ten drops of "Little's Soluble Phenyle" to each quart of syrup. Do not be persuaded to use brown cane sugar, and if you do so be careful not to use more than one-third brown cane to two-thirds of white cane.

If you have other colonies, and can spare a comb containing plenty of pollen, place this at one side of the brood-nest ready for early spring breeding. With regard to the question of cost, let us say 5 lb. of bees at 1s. a lb., 5s.; carriage, empty 6d., full 10d.; extra cost of saving special queen, 7d.; 21 lb. of white cane sugar at 22s. per cwt., 4s. 1d.; 2 lb. of honey at 6d., 1s. Total, 12s.

To conclude, I may say the main points are: 1. Be sure and have a young and vigorous queen. 2. Endeavour to rear a big batch of young bees. 3. Feed up

rapidly before the cold weather comes on, so that the bees can seal their stores (unsealed stores attract moisture in November and December, and cause the hive to become damp and cold). 4. Extra care in seeing that food is of the best and not burnt. 5. If hived on foundation, do not attempt with less than 5 lb. of bees: if worked-out comb 4 lb., and if you can give sealed stores 3 lb. of bees will do.

Much more might be said, especially in utilising driven bees at the heather, if you can get them in time. Readers will please observe that I have not touched upon driving bees, but only after they have been driven. The most frequent causes of failure are burnt syrup, a poor queen, unsealed stores, and not sufficient bees.—JOHN SILVER, Croydon.

CAPPINGS OF COMB.

BY L. S. CRAWSHAW, NORTON, MALTON.

A cursory Examination (page 487, line 25).—I have been present at one of these. The owner casually inspected the entrance before administering the oath of examination, when two or three zealous doorkeepers sailed forth and fourth—with assailed him. At least, or at most, I could only discover four stings, though the victim swore mightily they were forty, he felt so strongly about it! Then he stood back, and testified steadily for several minutes to the delight of the still unexamined hive! *Cursory* in deed as well as in word! When later I opened it I found that the queen still had her fingers in her ears!

Jordan in Flood (pages 488, 489).—Phew! What a breath-taking storm! Words flow so freely and so fast that it is a mercy the column containing them is broken, or the stream of "fair" comment might seem a waterspout and overflow the so-pressed channel of the B.B.J. Talk of Liberty! This play of words is surely licence, and ought to be censored. For of all bad habits this of punning is the worst of misfits, and, looked at fairly, the wearer might suitably seek to hide himself in the sheepskins of the forefathers whose propriety he questions. As a fitting punishment, I would, if I had my rule, give him fits—of course, after prudently taking his measure! I might hesitate before crossing this Jordan, lest, tempted by a dryness of remark, I should get out of my depth, never to return to resume even the primitive garb which I am accused of leaving behind!

Hive-roofs (page 489).—I can understand that a user of the "Cowan" hive might find zinc less objectionable than I should do, for these hives are more substantial than most, and the roof is almost flat. But, even so, I could not tolerate

the zinc, and I fail to see its advantage over calico. It is heavy, expensive, and unpleasant to handle. But perhaps I have said enough about its disadvantages! I am asked by a correspondent how to fix the calico. This I do with very thin glue, practically sizing the calico into place. When ready for painting it is closely attached to the wood, and all edges are folded neatly under the eaves, and held by small galvanised tacks.

European Statistics (page 491).—Palpably there is an error in the Danish return, and the average per hive might perhaps read correctly as a tenth of the amount given. But why is Switzerland omitted from the return?

Bees on Bicycles (page 495).—Fifty miles in four and a half hours with such a load is a very creditable journey, though from the photograph I hardly wonder that the rider did not dismount oftener than necessary! But the weight strikes me as excessive. My own packages weigh $1\frac{1}{2}$ lb. each, and four of these packed behind the saddle carry eight driven lots.

Northern Conference (page 496).—This idea surely need not be dropped without further discussion. It would seem to depend more upon the energy of the North than the initiative of the South. Will someone show cause why we should not have a gathering of this kind, where Northern bee-men who cannot easily get to London may become acquainted?

The Mother Hive (page 498).—As an admirer of Kipling's purposeful work, I am grateful to "Cryp" for drawing attention to this story. Having read it, I should like to recommend it for thoughtful perusal by all bee-keepers. Hear ye the parable of the wax-moth.

Matrimony and Martyrdom (page 501).—We have it on recent authority that honey is money, but the "connection by marriage" has not been so advertised before, I think. It is a bold, bad editor that dares to take the responsibility of putting the excluder-zinc on such an advertisement. Think what it may mean to apiculture if a marriage be arranged, with bee-keeping as its selective cause! How far on the way may not the pre-disposed young bee-keepers progress in the future? And the B.B.J. the humble agent of it all!

Bee-stings (page 501).—In this locality the supply is usually far in advance of the demand! May we lend you a few, Philadelphia College?

European Statistics (page 503).—Mr. Woodley will find the honey produced "between" England and Italy under the heading of France! But, seriously, does England produce 25,000 tons? And how is this estimated? Multiply half a ton

of honey by 50,000 known bee-keepers and you have it at once.

Winter Entrance (page 516).—This practice of upper entrance is worth notice for experiment.

Wax-extractors (page 516).—I have never spoken "slightly" of the "solar," and am glad to hear this eulogy of it. All my best wax has been obtained from a home-made "solar." But I have not found it so satisfactory for old combs. Possibly the difference may be due to locality again. I have only used it in a rainy portion of Wharfedale, whilst Mr. King is situate in sunny Hastings. A "solar" is the best thing for a beginner, who seldom has sufficient comb for other methods. But I would remind Mr. King that an old hand may have wax for refinement during the winter months, when a "solar" is of no use at all. As to "mess," there should not be any; "smell" costs nothing; and "firing" should be paid for by the extra wax.

Differing Opinions (page 517).—I do not like this advice to cut heather honey out of brood-combs. I would prefer to have it in the sections, and saleable at the first time of asking, as is the case with the "Divisible" hive in question.

Mice (page 517).—I consider queen-excluder too small for winter entrance. It hinders expulsion of dead bees, and is liable to clog. Better to use woven wire of larger mesh, or we might have the manufacturers supplying us with mouse-excluder zinc.

The New Year (page 1).—By the time these lines have been cast in the pleasant place of the printer's foundry we shall be well round the turn of the New Year, but not perhaps too far to wish all and sundry every good thing for the season which is still in the womb of Time. Now is the day of preparation for it. Have you got all you need at least on order? Let "do it now" be your good resolution for the New Year! But, whether your bees are successful or not, may you have such happiness from them in 1909 as I believe is only known to true bee-keepers.

THE SELBORNE SOCIETY.

The Selborne Society, whose president is the Right Hon. Lord Avebury, D.C.L., F.R.S., has revived the old title of its magazine, which will henceforth be called the *Selborne Magazine* (and *Nature Notes*), and will be published by Messrs. George Philip and Son, Ltd., of 32, Fleet Street, E.C. All communications with regard to the society should be addressed to the Honorary General Secretary of the Selborne Society, 20, Hanover Square, London, as heretofore.

NOVELTIES FOR 1909.

SIMMINS'S UNCAPPING APPARATUS.

Regarding this important novelty, the inventor says:—"Most producers of extracted honey will be glad to know of the introduction of this genuinely practical

which have raised angular edges, terminating in very sharp points which nothing can resist. These cutting edges being raised above the general surface, and bevelled at the back, the comb touches no other part, and, therefore, there is no suction. Moreover, there is no dragging or choking at the rear angles, for while



Spring Guides are added if required; these rise to one inch above the cutters, and within the main guides at each end.

invention. Both sides of the comb are uncapped at one time, the weight of the comb of honey being in itself sufficient to carry out the operation.

the cutters are disconnected, each alternate larger cutter follows, in part, behind those broken joints, and consequently behind each of the smaller intervening

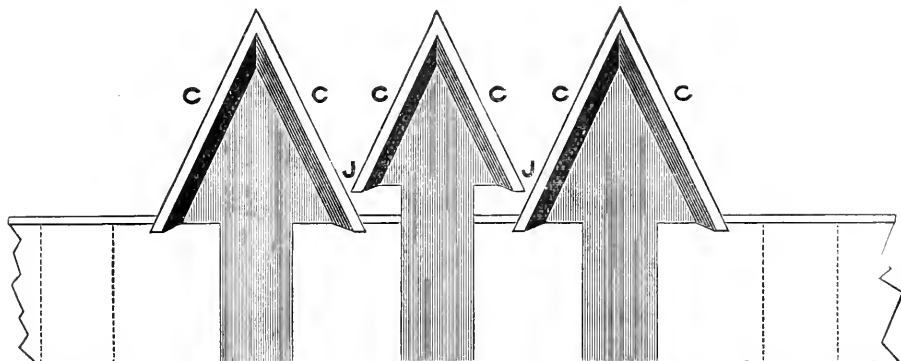

C, RAISED CUTTING EDGES. J, BROKEN JOINT SHOWING HOW ONE CUTTER CLEARS BEHIND THE NEXT.

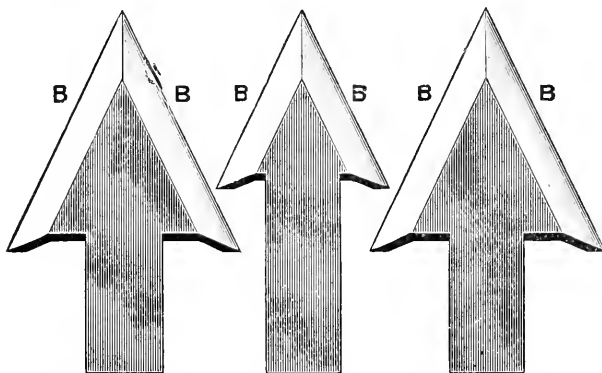

BACKS OF CUTTERS SHOWING B, THE BEVELLED EDGES, AND EXACT RELATIVE SITUATIONS.

The illustrations will give a fair idea of the general construction. There are two parallel bars of sectional cutters,

In its primary or simple form the apparatus, as illustrated, is used over an uncapping can, and one, two, or more

parallel sets can be fixed for use over the same receptacle.

"In starting the comb, let the frame hang easily plumb from the two hands, with one corner lower than the other, and just within the guide at that end. This enables the operator to more quickly find the guide at the other end, when he at once pushes the comb down between the multiple cutters, always taking care to keep the frame in a vertical position until it is well into the guides. Practice soon makes the process quite simple, and the whole operation takes less

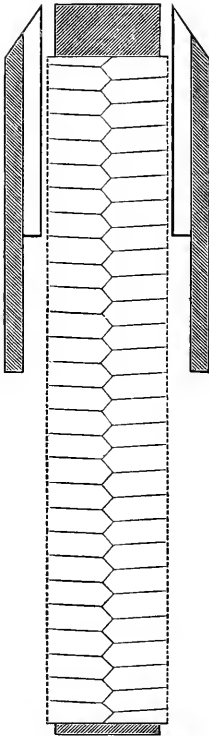

CROSS-SECTION OF THE UNCAPPED COMB, TOUCHING THE CUTTERS ONLY AT THE RAISED EDGES—AVOIDING SUCTION.

time than is required to give the above directions.

"The apparatus is gauged for British bee-keepers to take either the 14 in. by 8½ in. Association frame, or the 5½ in. by 14 in. extracting frame, without removing the metal ends. The comb may also be cut to any desired thickness from one inch and over, simply by small plates or washers being inserted inside of the bars of cutters at each end.

"The No. 1 uncapping can is in three sections—the upper section containing the uncapping apparatus; the next section is the strainer, and will hold a considerable

quantity of cappings before it need be emptied, which is an easy matter, with the top section also being removable; the

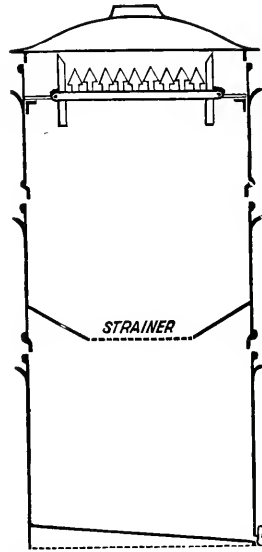

CROSS-SECTION OF NO. 1 UNCAPPER.

No. 1—The Practical Uncapper, with strainer and honey tank.

lower part is the honey tank with the usual gate. No. 2 has a heating apparatus which disposes of the wax forth-

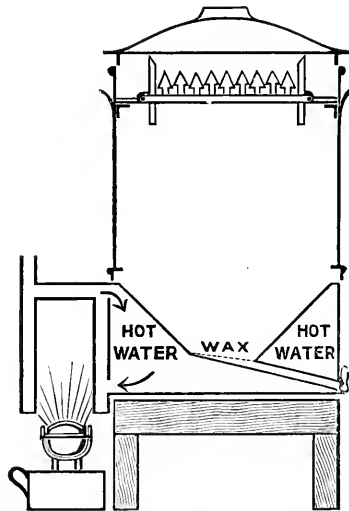

No. 2—The Practical Uncapper, with circulating heater for disposing of the cappings at same time.

with." The invention is protected in Great Britain, America, and other countries.

Queries and Replies.

[3860.] *Out-apiaries near to Dwellings.*—I should be much obliged for a reply through the B.B.J. to the following questions:—I am thinking of buying a piece of land 100 ft. long and 50 ft. wide, and having a fence 6 ft. high all round. There is one house, 20 ft. from the outside of the fence. My intention is to use this land, which is 200 ft. away from where I live, as an out-apiary, and in view of this I ask: 1. How many hives could I keep safely on this piece of ground, and not be a nuisance in any way to the people in that house? 2. As I wish to increase my stocks in the spring, would you recommend me to make artificial swarms or let the bees swarm naturally? 3. Why is it some honey granulates much more quickly than others, when it is all taken from the hives at about the same time? I have some which has not granulated yet—indeed is only now commencing with a few spots—and it has been kept during the coldest weather in a cold place, while some is granulated solid. 4. Can you give me a recipe for honey sweets?—S. WINTER, Maidenhead.

REPLY.—1. There is a certain amount of risk in keeping bees near to dwelling-houses that cannot be avoided. Our correspondent, however, could usefully inform himself on this point by reading the account of a case of a similar nature to his own which was tried about two years ago, and fully reported in our pages at the time. It occupied three numbers of the B.B.J., which can be had from the office for 4½d., post free. 2. Artificial swarming would be most suitable for your purpose. 3. There is something in the nature of honey from particular sources which causes it to granulate rapidly; that from mustard grown for seed, for instance, usually becomes solid in about ten days or less after removal from the hives. Seasons or climatic conditions also have considerable influence on granulation. 4. A recipe for this appeared in the B.B.J. of April 30 last, which can be had for 1½d., post free.

[3861.] *Superfluous Drone-comb.*—Last summer I hived a swarm of bees on ten frames, with foundation one-third of the depth of frame, and on looking them over before sending them to the moors in the autumn, I found the bees had only made worker-cells half-way down the frames, the lower half of nearly all the frames being drone-cells. I therefore ask:—1. What had I better do with them in the spring? Shall I cut out the drone-cells and fill up the space with worker-foundation, or put in frames with full

sheets of foundation? There was, as might be expected, an abnormal number of drones in this hive. 2. I would like your opinion on the enclosed sample of soft candy. It is slightly harder than the original, as it had been left exposed in a damp warehouse, and was placed on the oven top to dry. I send name for reference.—OSSEY, Northallerton, January 5.

REPLY.—1. We should by all means cut out the drone-comb, and substitute worker-cell foundation, or the same trouble with superfluous drones will occur again this year. 2. The candy is not properly boiled, nor does it appear to have been kept well stirred while cooling off. You do not say what recipe it was made from, but—as made—when the moisture dries out it will become quite hard.

[3862.] *Dead Bees Cast Out in January.*—I should be exceedingly obliged for your opinion on enclosed bees. On January 1, when mild weather succeeded severe frost, I noticed a large number of bees flying, and the alighting-board covered with dead and dying bees. Some of the latter were cast out while still alive, and a few appeared to be covered with small yellow spots resembling pollen-grains. The stock was well protected, and had ample stores in October when packed down. Thanking you in anticipation, I send name for reference.—QUERCUS, Birmingham, January 5.

REPLY.—We find no indication of the "yellow spots" mentioned on any of the half-dozen dead bees sent. They appear just like the usual dead bees cast out of hives whenever a warm day in winter allows the bees to fly and carry out the aged bees which have died since the season of 1908 closed.

[3863.] *Queen-wasps Active in January.*—Evidences are not wanting of the topsy-turvy state of the season this winter, but I think this will "take the cake." Being out this morning at 8 in one of the streets of this town—which nestles in one of the deep, narrow valleys of Glamorganshire—I found on the pavement a large wasp struggling through the dirt. I stopped, picked it up, placed it in an old envelope, and conveyed it home. I now enclose it for your inspection, with the query: Is it a queen-wasp?—J. L., Penrhwi-ceiber, near Pontypridd, S. Wales, January 4.

REPLY.—Without being favoured with a sight of the insect in question—the box in which it had been imprisoned containing nothing but a piece of loaf sugar—we have no hesitation in saying that the insect was a queen-wasp. This is certain, as the workers all die off in the autumn. You made a mistake in labelling the paper round the matchbox "Live Bee"

and not covering the ends of the inner box, but leaving it pierced with holes to let air in! Some mischievous P.O. official had released the bee (?), no doubt, for fun.

[3864.] *Queen-rearing without Using Cell-cups.*—Please do not smile at my ignorance. I feel utterly unable to follow the advice I find in some bee-books about "spooning a little royal jelly into a cup, then lifting a young larva on to the jelly," &c. Will you please tell me this: If about midsummer next year I were to put two frames of hatching bees at the side of a hive, separating them from the colony by a partition of excluder-zinc; then at midday next day confine the bees on the two frames, with a bee-proof partition of wire gauze, for some six hours; then put in a frame of hatching eggs between the other two frames, removing the wire partition next day, might I reasonably expect to find queen-cells on that frame ten days after? Would the absence of royal jelly and prepared cups destroy my hopes?—MEL ROSÆ.

REPLY. — Any departure from the methods adopted by those who have perfected the system of queen-rearing in artificially-made cell-cups is about certain to result in failure; therefore any opinion we might offer with regard to your proposed plan would only be speculative, while having no faith in it. You might try it, but it would very much surprise us if it did not end in failure.

[3865.] *Faulty Spring Management.*—As a beginner in the craft of bee-keeping, I should be much obliged for your opinion on a few matters. But first let me say I have read Mr. Cowan's "Guide Book" (1897 edition), and am also a reader of the B.B.J. My queries are as follow:—1. I have a stock of bees wintering on nine frames of comb; as the latter is very dark in colour (dark brown), I am wondering if it is through age. I ask because the hive and bees were presented to me, so I do not know how old the combs are. Do you advise me to give them frames fitted with sheets of new comb-foundation to build out in the spring, or let them continue with what they have? 2. What kind of protection should I adopt for my hives, as they are situated on top of a hill, and the wind is so strong as to almost blow them over? 3. Can I obtain Lees' "Improved" frames as described in the fourteenth edition of "The Bee-keepers' Guide Book" (Fig. 42)? A reply to these queries through the B.B.J. will greatly oblige. I send name for reference. — A BEGINNER, Hindhead, Surrey, January 9.

REPLY.—1. If the combs are straight and in good condition, the fact of their

being dark brown in colour is no great fault, and it would be very bad practice to destroy them in spring in order to have new combs built. Not only so, but it would mean the destruction of more or less brood and throwing the bees back for a month or more. 2. The best protection for hives in exposed situations is to drive a stout stake into the ground at the hive side, and from this attach, by a stout cord, a couple of bricks, which when hung across the roof will secure the latter and prevent the hive from being blown over. 3. Messrs. Lee and Son do not now make the frame you mention.

Notices to Correspondents.

Letters or queries asking for addresses of manufacturers or correspondents, or where appliances can be purchased, or replies giving such information, can only be inserted as advertisements. The space devoted to letters, queries, and replies is meant for the general good of bee-keepers, and not for advertisements. We wish our correspondents to bear in mind that, as it is necessary for us to go to press in advance of the date of issue, queries cannot always be replied to in the issue immediately following the receipt of their communications.

J. REEVES (Coventry).—*Coloured Plates of Bees.*—You can obtain a beautiful coloured plate of queen and worker-bees by sending 2d. to Mr. F. W. L. Sladen, Ripple Court Apiary, near Dover, for his catalogue.

WORKER-BEE (Surrey).—*Raw Cane-sugar for Spring Feeding.*—We do not advise the use of moist Barbados sugar (given dry) for feeding bees at any time. Yellow crystals of pure cane-sugar may be given as spring food in syrup-making; but for winter and also for candy-making refined cane-sugar only should be used.

J. PARKER (Bishop Auckland).—*Lantern-slides for Bee-lectures.*—1. The slides of the B.B.K.A. can be hired for lectures on application to Mr. E. H. Young, Secretary B.B.K.A., 12, Hanover Square, London. If you are a member of the Durham County B.K.A. the slides are lent at half the rate charged to non-members. 2. As a lecturer on "the honey-bee" from the scientific side of the craft, we strongly advise you to read "The Honey-Bee: Its Natural History, Anatomy, and Physiology," by T. W. Cowan, as advertised in our pages. In it the eyes of bees—queen, worker, and drone—are fully described and their wonders explained.

*. * Several important letters, &c., are in type, and will appear next week.

Editorial, Notices, &c.

CONTROLLING SWARMING.

Allusion has been frequently made in our pages to the work carried on by Swiss bee-keepers with a view to improving the native bee and reducing its swarming propensity. The method followed in order to obtain this result is to select colonies having the characteristics it was desired to perpetuate, and eliminating those tending the other way, and by patient labour in this direction they have succeeded in producing good-tempered bees, hardy, industrious, and at the same time so little inclined to swarm as to become practically non-swarmers; and the bee-keepers of Switzerland are so completely satisfied with the general result that they will not even allow Italian bees to be advertised in their bee-paper. Mr. E. R. Root, who was sceptical about the advantages obtained, said in *Gleanings* that if the bees so rarely swarm it must be owing to some special conditions of the climate and pasturage. A colony, he goes on to say, will not swarm if the honey-flow is rapid and abundant, but is sure to do so if the bees gather nectar only in small quantities before the main honey-flow. He thought that if the Swiss bees were brought to the United States they would swarm as much as others, and will not believe anything to the contrary unless M. Kramer can prove that swarming does not exceed 2 or 3 per cent. On the other hand, if the Swiss authority named can show such a result, he (Mr. Root) hopes to procure one of such queens, however black she might be. M. Kramer promptly took up the challenge, and replied in the *Schweizerische Bienenzeitung*. He says one must first consider the race of bees, and Italians, which are almost exclusively cultivated in America, are more hot-blooded, and consequently more inclined to swarm, than black bees. In proof of this assertion he says that formerly when Italian blood was found in most apiaries in Switzerland a common complaint among bee-keepers was the trouble caused by excessive swarming, but since they have eliminated this foreign blood their bees swarm very moderately indeed, and all those who now cultivate only the native race produced by proper selection can testify to the fact. In furtherance of this assertion M. Kramer cites several examples, as follow:—An apiary of seventy colonies only gave one swarm in 1907; the previous year not a single hive swarmed, notwithstanding the small and protracted honey-flow. In 1907—desiring swarms—forty different breeders did their utmost to force the selected colonies to swarm,

and two-thirds remained proof against all excitement. Eleven apiaries, containing an aggregate of 280 colonies, did not produce a single swarm; and from 1,544 colonies treated on the improved plan only ninety swarms could be obtained, equal to 6 per cent. In ten years the half-score of colonies belonging to M. Kramer himself only gave one swarm. These figures require no comment and prove the possibility of obtaining an almost non-swarming race of bees. It is, however, useless expecting to control Italians, their temperament being altogether opposed to it. On the other hand, it seems clear that Swiss bee-keepers have secured a most advantageous characteristic in their native bees which has enabled them to perfect their system of artificial swarming. M. Kramer says for eleven years past bee-keepers have been anxiously asking how to prevent swarming, and the experience detailed above must be the reply.

Pastor Straüli wrote to us some time ago mentioning the fact that there was so much difficulty in getting swarms that many bee-keepers had to import from a distance those they required for increase. It is, therefore, quite certain that by proper selection a native race can be improved to the all-round advantage of the honey-producer.

REVIEWS.

A Year's Work in an Out-apiary. By G. M. Doolittle. (Published by the A. I. Root Company, Medina, Ohio, U.S.A. Price 2s. 6d., at B.B.J. office.)—It is recognised that there is a limit to the number of bees that can be kept in a certain district; hence it is the custom in some places to have, in addition to the home-apiary, a number of out-apiaries. The author of this work is well known as a successful bee-keeper, who is above all things practical, and who usually imparts his knowledge in a chatty, pleasant manner. Mr. Doolittle is also the author of "Scientific Queen-rearing," and is deservedly regarded as an authority whose writings command attention. This new book of his is written particularly for those desiring to keep bees in out-apiaries, and, although intended for the specialist, is none the less useful to the ordinary bee-keeper or the amateur who keeps only a few hives. He does not go into the rudiments of bee-keeping, leaving this to be obtained from guide-books, but enters into the business at once, and tells the reader in plain language, and as briefly as possible for a full understanding of the plan, just what was done at the twelve different visits he made to his out-apiary in one year, and the results obtained. He calls it the non-swarming-sec-

tion-honey-producing principle, and shows in the sixty-one pages how he has obtained an average of 114½ lb. of honey per colony in a poor season, while effectually controlling swarming. This last-named feature will, no doubt, be recognised as of the utmost importance in an apiary only occasionally visited. The book is fully illustrated, and will not only interest, but impart valuable information to, the reader, and is sure to be found useful in his every-day work in the apiary.

Beiträge zur Naturgeschichte der Honigbiene. By Dr. A. Fleischmann. (Published by Theod. Weippl, Klosterneuburg, in parts at 75 pf. (9d.) each.)—We have received Parts 2 and 3 of the above work by Dr. Fleischmann, who is Professor of Comparative Anatomy at the Royal University, Erlangen. In Part 2 there are full descriptions of the stomach, mouth, breathing system, heart, nervous system, structure of the wax-secreting glands, together with the ovaries and sting; while in Part 3 the drone organs are fully described. The development of the cells controlling sex is also discussed and illustrated in Part 3. The descriptions in every case are clear and concise, and there is a profusion of illustrations, most of which have been prepared with great care by Dr. Fleischmann himself. To give an idea of the liberality with which the beautiful engravings are introduced, we need only mention that although Part 3 ends at page 96, there are no fewer than 152 figures. When finished, this book will be a valuable and indispensable addition to our literature on the subject. The work will be complete in from five to six parts, but single parts are not obtainable.

Correspondence.

The Editors do not hold themselves responsible for the opinions expressed by correspondents. No notice will be taken of anonymous communications, and correspondents are requested to write on one side of the paper only, and give their real names and addresses, not necessarily for publication, but as a guarantee of good faith. Illustrations should be drawn on separate pieces of paper. We do not undertake to return rejected communications.

. In order to facilitate reference, Correspondents, when speaking of any letter or query previously inserted, will oblige by mentioning the number of the letter, as well as the page on which it appears.

AMONG THE BEES.

WINTER "VESTIBULES" ON HIVES.

[7351.] A review of these may be interesting at this season of the year, and I glean the particulars from various sources.

1. A simple *windbreak* may be easily made. Select a board about 15 in. in length and 6 in. or 9 in. wide. Bevel the

top and bottom edges so that it will lie on bottom-board and rest evenly close to hive-front. Cut, 5 in. or 6 in. apart, two small entrances opening in at an angle on each side of the regular entrance, at about one-third from each end. As the board leaves side-openings, these and the outer entrances afford ample ventilation, while the board acts as a windbreak and excludes strong light.

2. A very common appliance in this country, roughly on the same lines as above, is a wide *shade-board*, placed one end on the ground, right in front of flight-board, the other end lying against the hive-front. Drifting snow and chilling winds are diverted and hindered from going right forward to the entrance, bees are not attracted by occasional bright blinks of sunshine, and cheated out when weather is too inclement for pleasure or comfort.

3. The "*Silver*" device, illustrated among the "Novelties for 1907," is a three-sided figure, wide next the hive-front, narrowing towards front of flight-board, and placed covered side up right against the hive-face in front of the true entrance. It is claimed that this simple device keeps the bees indoors in early spring when the snow is on the ground, and by shading the entrance on cold days the bees are not tempted to take flights, thus hindering spring dwindling. The cost is trifling, and it will last a lifetime.

4. A *protected entrance* may be made as follows: A board can be screwed on to the flight-board, about 1 in. in front of the regular entrance, and rising 3 in. or 4 in. Fasten another board an inch or more in front of this, reaching down only within 1 in. of flight-board, with a top covering both. Bees then go in at the false entrance, climb up first board, then down, and in at the true entrance. This most effectively shuts out the light and prevents the wind from blowing into the hive. The only drawback would be that the bees could not easily eject their dead or clean out offensive débris.

5. A *protector* on the same principle, however, could be carried out by placing the boards horizontally, at the same time getting over the foregoing difficulty. The bees on leaving the brood-nest would travel round the obstructing board and pace along the other side until they came to the true entrance. In returning they would find no serious obstacle in making for the home-nest.

6. Hives of the "W. B. C." type could have an *adjustable entrance* in the inner body-box, temporarily affording the bees an exit only near each side. Light would thus be shut out, and bees would be hindered from seeking the outer air in times

of storm. While the usual entrance, with the two inner ones, would afford ample ventilation, cold winds and drifting fine, powdery snow would not so readily find admittance. This could be varied by having a central inside entrance and one or two outside ones near either side of the flight-board. It must be remembered very little traffic takes place from and to the hive while these temporary checks are in use.

7. It has been suggested that a *double hive-bottom* might be provided for winter use. There would be a very wide front entrance, bees would move forward almost to the back of lower bottom board, and discover the real entrance in the top board. This could be small or large according to the taste of the bee-keeper. It is claimed for such an arrangement that cold draughts in early spring would be rigidly excluded. The bees would not be lured out during cold sunshiny days to get chilled and die. Robbing is prevented by the robbers being bewildered. No fear need be felt of either entrance being clogged with dead bees. A high authority gives it as his opinion that this arrangement is "very simple, cheap, and excellent." As it is to be tested we may hear more of this system at some future time.

8. Two American devices may be given. First, the "*Halter*" *storm-door* (somewhat similar in character to No. 1 given above) is simply a board as long as breadth of hive leaned up against the front, shutting out the direct rays of light, and making it possible for the bees to pass in and out at any time by two small V cuts on each side of entrance, about one-third from each end. Mr. Halter's theory is that "if the light is shut out there will not be much flying on the part of the bees on bright sunny days, yet having an atmosphere too cool to allow them to fly out and get chilled." The idea is being tested at Messrs. Root's yards somewhat extensively this winter, and we are promised that results will be published at some future time.

9. The second American invention is far more complicated. It is known as the "*Weber*" *entrance controller*, and was illustrated and described in *Gleanings*, page 96, January 15, 1903: "The controller consists of a general scheme for gradually contracting the entrance, allowing daylight to penetrate in moderate weather, when the bees can fly without being chilled to death; and later, when chilly or cold weather comes on, it permits of the closing of the entrance in such a way as to let in the air, and yet shut out the light." The "closing" is not intended for any long period.

10. The *Claustral device* is now well

known in this country, having been illustrated and described more than once in our pages. It appears to me the most effective of any I have ever seen described. As the patent has now been withdrawn, it can be made and applied by any bee-keeper at a small cost. In addition to the fact that bees can be confined to the hive without detriment for lengthy periods in winter and early spring, it is claimed for "clustering" that it checks robbing, hives can be moved short distances without loss of bees, it enables artificial swarms to be made with ease and safety, colonies are easily equalised, and in case of disease the hives could be made isolating hospitals for safe treatment of the affected colonies.—D. M. M., Banff.

THE PAST TWO HEATHER SEASONS.

[7352.] The disastrous year 1907 is so far behind us as to remain but an unpleasant memory to heather bee-men; indeed, at one time during the last year I thought that 1908 was going to be even worse than its predecessor. But as it is mainly with the heather crop of those two years that I purpose dealing by way of comparison, let me say that from July 14 to the end of that month was the only few days of bee-weather we had in 1907, and when I removed my bees to the moors in the middle of August it was in the hope that good weather would favour us, and so our labour make amends for the earlier disappointment. Certainly the warm weather came, but too late to be of any use, and at the end of September I brought home only wrecks of good stocks to build up for the winter. However, a liberal supply of syrup made them all right, and they were in good condition in the early spring. Unfortunately, the wretched cold winds of April played havoc with the bees, and when it was again warm enough to examine the hives I found that four of my eleven stocks had died out, while the remaining seven were each about equal in strength to a small nucleus colony. By careful attention I kept them all going, and two were ready for sections by mid-June. At that time the weather was favourable, but the clover yielded very little surplus, and when the field-beans and mustard had done flowering no summer forage remained. A swarm I bought in mid-June gave me six decent 1-lb. sections, and these, along with about a dozen from each of the hives I had supered, made up my whole summer harvest, my only remaining chance being the heather. It was now about time to get ready for the moors. This job was begun on the evening of August 11, and all was ready for our annual drive of twenty-four miles in

time to reach the moors by 3.30 next morning. We worked hard, and after some uphill labour reached our destination; then, after fixing up stands and setting the hives level, the bees were let loose, quilts neatly arranged, and all made snug. This done, we got some much-needed rest and refreshment, after which I returned at 10 a.m. to have a look at the hives and see how all was going on, after despatching my assistant homeward with the wagon. I was agreeably surprised to find the bees hard at work on the heather-bloom growing profusely around; then, making my way to the nearest station, I soon got home, satisfied that if the weather kept right the heather-honey crop would be a good one. Ten days later I made another trip to the moors, and found that what had been racks of empty sections fitted with starters were now mostly filled with beautiful honey, while some of the stocks were needing more surplus room. Highly pleased at what I saw, I left, and in three days was back with more sections. Unfortunately, however, the weather then broke, and little more was done for the next fortnight, when I brought the hives home. It is hard to say what the result would have been had good weather continued for a couple of weeks longer, but on removing the surplus it was plain that my most sanguine expectations were exceeded. From the best hive I took forty-four sections of first-grade heather-honey, and the worst, which was no better than a six-frame nucleus, yielded 10 lb. of beautiful honey in a super, and left far more in the brood-chamber than was required for winter stores. Thus in the fourteen days of good weather at the moors my eight unpromising colonies yielded an average of 50 lb. per stock. This result should be a reply to such of your readers as question the advantages of taking bees a long distance—or even at all—to the moors; but I go further, and say I would not miss the pleasure of my annual trip to the heather for a good deal; nor would I forgo the preference my own household has for heather-honey over that from clover, as shown by the share of the spoil for household use, being about fifty sections. I had still for sale about 350 lb. of surplus, but in a few days it was all sold retail locally, and at 1s. 3d. per lb. for sections and pressed honey alike. My customers have a decided preference for pressed honey, which is not common, and it sells in the proportion of six to one compared with comb-honey. This being so, of course I do my best to meet their wishes in this respect; but with regard to selling my crop, I can only say that had it been as large again it would have been all sold. When I came to balance accounts for the years 1907 and 1908, the considerable debit balance carried forward was far more

than cleared off. I also increased my stock by four additional hives; the latter I made myself, but frames and foundation had to be provided, and the bees fed, all of which costs money.

I have been much interested in the account of Mr. J. M. Ellis's management of the bees for the heather as given in the B.B.J. of December 31, but his apiary is, I presume, located on the moors, which should be worth a good 10 lb. of honey per hive any year. My plan in past years has been to unite two stocks in each hive taken to the moors, making each have ten frames of brood. This year I had to reduce them all to seven or eight frames of hatching-brood, and each had a young prolific queen, but that did not prevent the bees from putting far too much honey in the brood-chamber; yet my bees never came home from the heather in better condition than they did last year. My future plans will be laid as before, and if I do always half as well as in 1908, moor-going will amply repay me. Some of your correspondents complain that it is difficult to hear of heather-honey for sale in some parts; this is not to be wondered at when bee-men do not now trouble about heather-going for some reason. In 1887 I counted 200 stocks on the moor that I visit; in 1900 there were only half that number, and this year I only counted twenty-four. Some have gone elsewhere, but the greater part have joined the great majority, and none of their sons have taken their place. Out of a family of seven sons I am the only one who would care to touch a hive of bees with a 20-ft. pole, yet they, like myself, had all to do their share of watching swarms, &c., when they were young. It is seventy years since my father and grandfather first went to that moor, and got record crops of honey from it. Now we are looking forward to 1909, and that it may be as good as the moors as was 1908 is my New Year's wish to all members of the craft, not forgetting hearty New Year's greetings to our Editors.—J. C. A., Grangemouth.

ODDS AND ENDS ABOUT BEES, ETC.

WAX-RENDERING.

[7353.] This subject of wax-rendering came up for discussion in the B.B.J. during last August and September, and I see Mr. King has returned to the same on December 24 (page 516). May I now say the ages of combs ought to be definitely ascertained by marking with a soft pencil—blue for preference—the date of insertion on the end of the frame, thus: 5/6/08, or simply 6/08? Mr. Crawshaw once asked if it was an ascertained fact that old combs yielded more wax than new ones (I am quoting from memory). Pre-

sumably ten sheets of foundation weigh 20 oz.=2 oz. each. I do not understand this to mean 2 oz. of wax. Yet Mr. Farmer obtains $2\frac{1}{10}$ oz. of wax per comb—a clear gain of 1 oz. on ten frames, but only from young combs of one and two years of age. Mr. Harrison, in B.B.J. of September 3 (page 356), says that from thirty old combs he obtained *over* 4 lb. of wax. This is rather indefinite as to age and quantity. It may mean anything up to 5 lb., but I will assume that he means the turn of the scales=4 lb. 1 oz.= $2\frac{1}{5}$ oz. per comb. This is a slight improvement on Mr. Farmer's result. But on the same page (7205) "A. H., Wavendon," takes the cake for profit. Each old comb (age, please) yields from 2 oz. to 3 oz. of wax, without mess, &c. I am at a loss how to strike an average. Shall I say $2\frac{1}{2}$ oz. per comb? These three results are: Mr. Farmer, gain $\frac{1}{10}$ oz. per comb; Mr. Harrison, $\frac{1}{5}$ oz. ditto; "A. H., Wavendon," $\frac{1}{2}$ oz. ditto. These are most satisfactory returns, and should somewhat assure Mr. Crawshaw of a positive answer to his question.

Mr. Arnold King (B.B.J., December 24, 1908, page 516) gives his average at $1\frac{1}{5}$ oz. per comb by the solar extractor from *really old* combs, no cost being involved. I should like to know how many combs Mr. King extracted, and how many hours were devoted to watching, stirring, &c. I have tried my hand with the "solar," but I am certain I could not have managed the contents of ten frames between March and September without giving up my occupation to attend to the contrivance—home-made and *therefore the best*. Mr. King also obtained $1\frac{1}{5}$ oz. per comb by boiling, &c., and $1\frac{1}{5}$ oz. per comb by solar extractor in two carefully conducted experiments with really old combs. These results are not quite satisfactory. Why in ordinary solar extraction he should average $1\frac{1}{5}$ oz. per comb and in a careful experiment with combs of the same designation only $1\frac{2}{5}$ oz. per comb is quite disappointing. On page 336 (B.B.J., August 20, 1908) Mr. King questions the utility of the method I advocated. I shall now describe a case of wax-rendering, with time employed and the result. On Saturday, December 18, the scullery boiler (25 gallons) had been in use, so I had one and a half pailfuls of water put in and brought to the boil. Meantime I had got ten standard frames of comb, known to be over three years old by their dates. They had the pollen cleaned out in autumn, and had been stored, but I thought they might be usefully employed in an experiment. The ten combs weighed 4 lb., there being no pollen in them. I broke them up and dropped the pieces into the boiling water, and stirred a little with a stick. All the embedded wires sank to the bottom. The combs were

melted and strained in *ten* minutes, and yielded $18\frac{1}{2}$ oz. of wax. I had no mess of any kind either on my clothes or the floor. The cocoons, of which the residue consisted, were all separate. I submitted a wet and a dry sample to our Editors, who said: "Both packets were as completely free from wax as they well could be." Mr. King and I are in the same boat. Although I have $\frac{1}{2}$ oz. more wax per ten frames than he, yet we both come far short of Messrs. Farmer, Harrison, and "A. H." However, I think I ought to be awarded the palm for expedition and accuracy as to the age of the old frames. Future wax work, combined with a diligent study of Mr. Cowan's book on "Wax Craft," may raise Mr. King and myself to the same eminent position held by your correspondent "A. H., Wavendon, Bucks."—D. V., Dunaskin.

BEE-KEEPERS' ASSOCIATIONS AND EXPERTS' CERTIFICATES IN SOUTH AFRICA.

[7354.] The communication headed "The Bee-industry in South Africa," on page 472 of your issue dated November 26, came as a surprise to me. When I first heard of a few gentlemen in Johannesburg and neighbourhood forming themselves into an association and appropriating the name "South African Bee-keepers' Association," I could not refrain from ejaculating "What assurance!" Fancy a few men, with perhaps one bee-keeper (I do not include owners of bees who have to engage a bee-keeper to attend to them) amongst them, setting themselves up to dictate to all South Africa from the Cape to the Zambesi! I know there are a few old bee-keepers in Cape Colony who are really experienced in the management of bees. Seeing the letters in your journal regarding the granting of experts' certificates evidently caused a flutter in the dovecot, and in order to prop themselves up in the position they have assumed they "refrained from joining in the discussion until" they were "in a position to inform this gentleman ["Cape Bee-keeper, Douglas"] what had been done by the South African Bee-keepers' Association in this direction." Finding that someone was anxious to secure an expert's certificate through the British Bee-keepers' Association, and scenting danger, they coolly appoint two gentlemen to examine candidates and to issue experts' certificates.

The qualifications of the first-named gentleman are not given. He is simply stated to be "Senior Expert." How did he come to adopt the high-sounding title? Does he hold an expert's certificate granted after passing the stiff examination required by the B.B.K.A.? The second gentleman's recommendation is

that he is a practical bee-keeper and a member of the central committee; but this does not justify his being put forward as an examiner with power to issue experts' certificates. There are thousands of practical bee-keepers at home who could not pass the tests for your third-class expert certificate. What guarantee, therefore, is there that the gentlemen referred to are qualified? I fail to see any. It is unnecessary to point out to British bee-keepers the absurdity of these gentlemen posing as experts and issuing diplomas if they have no other qualifications than those given. We do not want self-appointed experts. Experts must have something behind them to prove that they are what they profess to be. We want the industry to be started on a good foundation. We require men holding certificates of proficiency issued by recognised authorities. Did we get our doctors in South Africa by a few quacks setting themselves up as medical men qualified to issue diplomas? Certainly not. They have to hold diplomas from European sources, and this is what we want, and must have, in our experts if we wish apiculture to make headway, and there is no certificate issued which guarantees the qualifications of the holders as does that of the B.B.K.A.

With reference to your correspondent's remark *re* British hives and manufacturers, would it not be advisable for this gentleman to know more about these matters before he takes the manufacturers to task? I have had dealings with them, and twenty years ago could always get what I wanted; and it is the same today. I only know of one gentleman in Johannesburg who sells British hives, and he is an agent selling one maker's hives only. He is undoubtedly making a good thing out of it; in fact, the prices charged are enough to kill apiculture instead of putting it "on a firm footing in this sub-continent."

With regard to standard sizes of hives, if the dealer in question does not have his hives made to his own measurements *it is his own fault*, as many manufacturers will make hives to customers' own specifications. Put the saddle on the right horse, and do not shout so much about the British manufacturers. This is an old cry in many lines when sellers want to push a line of inferior foreign goods and thereby secure bigger profits.—S. HASTINGS, Johannesburg, December 20.

[Without entering into the question of the "qualifications" of the gentlemen named as examiners, it should be plain to all concerned that the value of a certificate depends upon the weight of the authority attached to it. The British Bee-keepers' Association is the recognised body representing the bee-industry of Great Britain and her Colonies.

Therefore it would probably only need that an association in South Africa should apply for affiliation to the parent body, and fulfil the conditions attached, in order to stand on an equality with county associations at home, and have examiners qualified as holders of their certificates in any part of the world.—EDS.]

DOCTORS AND BEES.

[7355.] Will you allow me to represent to your bee-keeping readers two, to them, very important facts? 1. In consequence of a valuable paper by Professor Ainley Walker, of Oxford, in the *British Medical Journal*, in October last, on the value of bee-stinging in cases of rheumatism, it was followed by two papers from me proving Professor Walker's contention. 2. Since then I have been overwhelmed by correspondence from England, Wales, and Scotland asking where to get the bees. I took the liberty of telling my correspondents that if they sent a stamped envelope to the office of the *BRITISH BEE JOURNAL*, probably you could advise them of a bee-keeper near each writer's residence. I hope you will pardon me if I acted wrongly. Many doctors have since written that no bee-keeper will open his hives in the winter, so they are unable to obtain a supply when it is most needed in our cold, moist climate. I suggested to a bee-keeper to erect a wooden hut over one hive, and heat it for a couple of hours by a duplex lamp before opening the hive. He has done so, and is thus able to supply me with bees whenever I want them. Bee-keepers will find this a new and fruitful source of profit in the winter, earning them more money than the selling of honey in the autumn, and they will have the sincere pleasure of lessening the sum of human pain and poverty—for who suffers more than the poor farm labourer from rheumatism? If bee-keepers will not do what I suggest the doctors will have to turn bee-keepers in order to provide these marvellous insects, which, for rheumatic affections, have proved more useful than any medicine yet discovered.—E. T. BURTON, M.D., Birmingham, January 14.

[Our correspondent is evidently not aware that our attention was directed to Professor Ainley Walker's paper by several readers of the *B.B.J.*, and that, recognising its value to all persons subject to rheumatism and to bee-keepers especially, we reprinted it in our issue of December 3 last and three following numbers. Subsequently, there has been correspondence on the subject and discussion thereon by bee-keepers who have derived unquestionable benefit from the action of bee-stings received in the ordinary way in the manipulation of live bees regularly. The difficulty of obtaining bees for

the purpose in question has, however, not been mentioned at all, it being well known that there would be little or no trouble in obtaining a few live bees at any season of the year from any expert who could have access to a hive. At the same time we gladly give insertion to Dr. Burton's request, and shall probably be able to name some bee-keeper willing to give away a few live bees, without having recourse to the rather cruel expedient referred to for the purpose of making profit therefrom.—EDS.]

DRIVEN BEES VERSUS SWARMS.

[7356.] May I add a line to what has already been said about driven bees? In "D. M. M.'s" first contribution to the subject in B.B.J. of September 17 last year (page 372) I do not consider that a fair comparison is drawn between driven bees and swarms, because he is located in a much later district than most of us, and his—what may be termed—"record" swarm must have gathered a good deal of honey from the heather, whereas a June swarm here in Worcestershire would do little more than establish itself for winter if hived on foundation. Not only so, but, as "D. M. M." tells us, his swarm was hived on built-out combs. Ought not some allowance to be made for that? We have no heather here, and after the clover is cut (last year on July 15) there is no surplus to be had; therefore by the time a June swarm has filled ten frames with brood and honey there is no bee-forage left. On the other hand, with driven bees taken on August 20 I have built up a stock ready for super work on winter beans by May 20 of the following year, and from a stock made up thus, costing me a total of 10s. (no carriage to pay), I have taken 54 lb. of extracted honey. In other words, what a June swarm will do here in the year it is hived I have been able to do with a driven lot by feeding with syrup.—THOS. ROUSE, Tenbury, Worcester.

WAX-RENDERING.

[7357.] Referring to the letter of Mr. Arnold King, which appears on page 516 of the B.B.J. of December 24, will you allow me once again to point out that for small or medium quantities of combs for wax-rendering nothing beats the kitchen oven, and for large quantities a baker's heat-registering oven? The wax is obtained quite as clear and bright and as aromatic as from the solar extractor. There is positively no mess whatever. But why render combs at all? I extract and clean out pollen from even skep-combs, and after fitting and wiring such into standard frames, they answer perfectly for hiving driven bees on or for enlarging nuclei. I have tried all the various devices for

extracting wax, accounts of which have appeared in the B.B.J. during the last thirteen or fourteen years, including the solar extractor (for which we do not get enough sun here to depend on), and have discarded all for the kitchen oven. It should, however, be stated that an oven heating from the top is necessary, when it becomes practically identical with the solar extractor, with the addition of its being under perfect control. The only precaution needed is that the heat should not exceed 200 deg. Fahr.—i.e., slightly under the heat of boiling water.

Swarms and Driven Bees.—Regarding the comparative merits of these, it should not be forgotten that locality makes a lot of difference. But, given a fair lot of driven bees in mid-August, fed daily for twelve days, then every third or fourth day for a fortnight, they will by that time well cover eight or ten frames and seal their stores, and are then equal to one of the best stocks. That, at least, is my experience here in North Bucks. It must be an exceptionally early and good swarm that will then do half as well the same season as a driven lot. As to cost, say bees are worth 5s.—carriage according to distance—sugar for feeding 4s., and eight empty combs 8s. I should not consider the game worth the candle to hive driven bees on foundation only.—A. H., Wavendon, North Bucks.

PLANTING TREES FOR BEES.

[7358.] It being known that unemployed men are to be given the work of planting a large number of trees in our local streets and parks, &c., I wrote urging our Council (the Leyton Urban District) to select those useful for bee-keeping, and supplied the names of suitable ones, pointing out also that it need cost no more to comply with the request I made. Their answer is distinctly discouraging to bee-keepers, and I send it for publication as likely to interest any B.B.J. reader who might be thinking of settling in this neighbourhood. I should add that bee-forage is by no means abundant in the district, and now that this opportunity is neglected by the authorities, I do not see much chance of improvement. I send full name and address for reference.—A. B. H., Leytonstone.

"Town Hall, Leyton, E.,

"December 16, 1908.

"DEAR SIR,—Your letter of the 12th inst. as to trees has been placed before my committee, and they have instructed me to inform you that, whilst in sympathy with your industry, they are unable to accede to your request.—Yours faithfully,
WILLIAM DAWSON."

[Without knowing what trees were mentioned in your request or how many varie-

ties were named, it is difficult to understand how the authorities referred to could be "in sympathy" with the bee-industry and yet refuse any help in the direction asked for. We print below a "cutting" from the *Standard* of the 18th ult., which is comforting to bee-keepers in so far as it shows that, in the London district, trees are being extensively planted, and that the lime and plane (or sycamore) are most commonly used for the purpose. We need hardly say that, while not so good as the lime as bee-forage, the plane tree yields a good deal of honey in the early spring, when food from the outside is so helpful to bees in stimulating brood-rearing.—Eds.]

TREES IN ENGLISH TOWNS.

Norwich, whose Town Council has decided to order 14,500 trees for plantation in the streets and public spaces, is not by any means the only English town in which special attention is paid to this means of adding to the beauty and healthfulness of centres of population. Perhaps London itself is best provided of all places in this respect. The London County Council, indeed, maintains its own nurseries, and large tracts of ground at Avery Hill are reserved for rearing young trees, whose ultimate destinations lie in the various parks and public gardens of the metropolis.

The provision of trees in this manner is not a particularly expensive one. Indeed, the business has before now been turned to good account. Not very long ago work was found in Kensington for many of the unemployed, who were engaged upon the planting of young trees along certain streets.

The trees most commonly in demand are lime and plane trees. In the provinces, as is probably the case with Norwich, trees are almost invariably procured from local nurseries and plantations.

WAX-EXTRACTING — MOVING BEES.

[7359.] Referring to the question of wax-rendering, may I be allowed to say the thanks of B.B.J. readers are due to Mr. A. King for his interesting communication in your issue of December 24 (page 516)? If his solar extractor is in any way different from the ordinary article, many readers besides myself would like a description of it. Then about moving bees, as I have a quantity of stocks to move this year, the letter of "J. R., Starbeck" (page 523 of your issue of December 31), is opportune. The idea of a zinc covering in lieu of the usual strip of wood is a good one, and if the auger-holes were covered in like manner summer ventilation would be improved, if the ap-

paratus were left *in situ*. But your correspondent does not say how he prevents comb-sway, which, after all, is the most important consideration. If he has any device other than the usual screwed batten on frame-top, your readers in general, and myself in particular, would be glad to hear of it.—THOS. E. ATKINS, Lutterworth.

BEEES AND AEROPLANES.

We are going to take the air.

[7360.] Your esteemed correspondent Mr. Crawshaw would do well to consider the question of aeroplanes with regard to bee-keeping. If he would in his pleasant way show us how useful they will be for capturing decamping swarms or bringing home driven bees, the meeting of the "Aeroplane Club" noticed in yesterday's papers will not have been in vain.—THE WRITER OF "HONEY AND HEALTH," January 15.

Queries and Replies.

[3866.] *Bee-keeping in Suburban Gardens.*—As a novice who thinks of starting bee-keeping this spring with a single hive, I shall be very glad to have your advice on a few points, if you will be kind enough to give it. My garden is small, one of several all adjoining, and running down to a field at the back. I am away all day, and there is no one at home who would be able to take my place as regards the bees. I am also away for most of August with the Volunteers and on holiday. Now that you know my limitations do you think I could start as a bee-keeper with reasonable hopes of success? I may say the neighbours on either side have children, so do you think the bees would be likely to get me into trouble by stinging or robbing? The garden is about 20 ft. wide and 70 ft. long, and gets plenty of sun, and is well sheltered from the north. I should propose placing the hive at the far end, facing south-west. As regards forage, I think there should be a fair amount, as we are fairly countrified here, and there are some orchards not far off, and of course plenty of gardens. I do not know of any other hives in the immediate neighbourhood. I propose starting with a "W. B. C." hive and a swarm of English bees, and working for section-honey. The copy of the "Guide Book" which I bought has proved most interesting, and now I want to supplement my reading by practice. I am sorry to trouble you with these questions, but feel sure you will understand that I do not want to lay out £2 or £3 unless there is

a reasonable chance of some return. If I am going in for a hive I suppose it would be as well to place my order for a hive and swarm within the next few weeks. I read the B.B.J. regularly, and find it most interesting. The mass of information and varied opinions are, however, rather confusing to a novice like myself. Wishing the Editors a happy and prosperous New Year. Full name sent for reference.—C. W. W., Blackheath, January 9.

REPLY.—There are many instances of a few hives being kept about 20 ft. from dwelling-houses without any trouble being caused to neighbours, but very much depends on the bee-keeper himself and his management. The position you have chosen, at bottom of your not over-long garden and facing an open field, is the best, and, without being quite free from an element of risk, it is worth trying. We fear most from your absence from home during August, that being the time when supers are ready for removal, after which comes the danger of "robbing" being started. Under all the circumstances detailed above, we think you may venture to write to Mr. J. Chandler (whose apiary is near you in Kidbrooke Lane, Blackheath) asking if he has time to see you and have a talk on your proposed start. A photo of Mr. Chandler's apiary appeared in our issue of December 12, 1907, where the owner is seen hiving a swarm in his orchard; and, being a practical bee-keeper, his advice will be helpful to you.

[3867.] *A Bee-cemetery.*—On January 1—a warm day after a short spell of frost and snow—I found a heap of dead bees, mostly young, lying at the entrance of one of my hives. I swept off the lot—from 300 to 500, I suppose—and left them under the alighting-board. Three days later they had all disappeared, but at the foot of two apple trees, distant 12 ft. and 33 ft. respectively from the hive, I found the ground thickly covered with dead bodies. Is this a usual thing to happen?—H. RICHARDSON, Marlborough, Wilts, January 6.

REPLY.—The most likely explanation we can offer is to suppose that the dead bees had been carried off by bee-eating birds to trees where they could pick out the edible portions of the dead bees while comfortably perching in the branches, and let the remaining parts fall to the ground below. The fact of the respective "cemeteries" selected being some distance apart suggests the idea that several birds have been seeking food at the same time, and have chosen different feeding-places.

[3868.] *Are Lecturers Reliable?*—Having read both the B.B.J. and the B.K. Record for some time, and having

at present two hives of bees doing well, thanks to your excellent papers, I went to hear a lecture on January 12 on bee-life in winter, and it is a few remarks made by the lecturer that I would like you to explain for the benefit of an interested novice. He stated the queen-bee only left the hive once in her lifetime; that was on taking her mating trip. He also said that the queen laid three classes of eggs, which eggs produced three distinct kinds of bees, viz., queens, drones, and workers. I tried to question the accuracy of this, but, being only a young novice, my questions were ignored. As you have given sound advice so often, I ask you to kindly oblige the grandson of an old bee-keeper with regard to the above matter. Trusting the new year will see the B.B.J. more prosperous and useful than ever, I send name, &c., for reference and sign—DOUBTFUL, Manchester, January 13.

REPLY.—We should like to know who the lecturer in question is, because of its being possible that our personal knowledge of the gentleman may make us feel sure that you have not quite understood his way of putting well-known facts with regard to bee-life. For instance, it is a fact that the queen never (or "hardly ever") leaves the hive after fecundation *except when accompanying a first swarm*. Again, the queen lays two kinds of eggs (not three, as stated), but those of one kind will, under different treatment and care, produce queens or workers, so that three kinds of bees, viz., queens, drones, and workers, are produced from two kinds of eggs. See "Guide Book" (page 9).

[3869.] *Is Re-queening Always Advisable?*—I have twelve stocks of bees, and wish to raise queens this year to re-queen them. Will it be advisable to re-queen all as soon as possible in the spring before the honey-flow, which is about the end of June, or should I do it after the flow? I wish to get as much honey as possible. Your advice will be greatly esteemed by—LIVE AND LEARN, Pitsea, January 14.

REPLY.—Unless there is some tangible reason for re-queening the whole of your twelve stocks, it is a risky thing to do when the main object mentioned is securing as much honey as possible. Are the present queens worn out, or aged, or unprolific? If so, there are good reasons for re-queening, but not otherwise. In other words, if the queens are really at fault, the earlier good prolific young ones are introduced the better. Bear in mind that last season was so bad in many places that the strongest stocks failed to store any surplus, though crowded with bees, at the time honey should have been plentiful. If the queens are not to blame we

should defer replacing them by others till the main honey-flow is over.

[3570.] *Faulty Slow-feeders for Bees.*—I am in trouble with regard to "bee-feeders." I can get a rapid one to work all right, but cannot get a satisfactory slow-feeder to give good results. All I can get hold of are of the tin-cap inverted type, and I find them useless for the purpose required. Can you kindly through the first issue of the B.B.J. after receipt of this letter give me any idea as to where I can buy a satisfactory article which will work properly, and also mention the selling price of same, if you can, as I wish to get one of these feeders without unnecessary delay? There are several bee-keepers here who experience the same difficulty as myself.—ERNEST J. WHITE, Pretoria Station, Transvaal, December 21.

REPLY.—The fault you complain of is entirely owing to bad workmanship on the part of the maker. If properly made, only so many of the small holes as are open to the bees can be got at at one time, but when the syrup runs out from a single hole into a badly-fitting space between the cap and stand the bees can feed all round the space, and it becomes a "rapid-feeder," as stated. We advise you to try a glass pickle-bottle, and fill it full of syrup, then cover the mouth with thick *twilled calico* stretched tightly across. This will allow the syrup to damp the under-surface of the calico, and the bees will only be able to take the food very slowly indeed.

[3871.] *Responsibility for Loss of Bees.*—As a constant reader of the B.B.J. I should feel indebted to you for your advice in the following circumstances:—About the end of September last I sent to Yorkshire for a box of driven bees, value 5s. The "waybill" for same arrived on Saturday, October 2, but box did not arrive till Monday, when bees were nearly all dead! I took delivery of box, and did what I could to revive the surviving bees by feeding and warmth, but they were too far gone. I then wrote to the seller asking what steps he proposed to take, and advising him to claim from railway company from his end. However, he disclaimed responsibility, saying the bees were all right when sent off; but, on the other hand, I say he has not fulfilled his contract with me to supply me with a box of live bees. Will you therefore kindly give me your opinion as to with whom the responsibility for claiming rests? I may say I have claimed, and the railway company disclaims liability, as bees are carried at owner's risk rate. I send name for reference.—BRIG, Bridge of Allan, N.B., January 8.

REPLY.—If the bees are already paid for, we fear you will have much trouble

in recovering from seller, seeing that you are located in Scotland, he in England. Under the circumstances, we should suggest a friendly compromise, each party losing one-half. On the other hand, and with regard to the railway company's liability, our opinion is that they can refuse to accept liability (unless gross carelessness in transit can be proved) when goods are carried at "owner's risk" rate.

[3872.] *Starting Bee-keeping.*—I. As I am a reader of the B.B.J. weekly, could you tell me why I had no swarms last summer from five stocks, all in frame-hives? 2. How can I prevent swarms; and, if prevented, would it benefit me to follow that plan? 3. How can I tell whether the queen is a good or a bad one; and, if a bad one, how to get rid of it and introduce a new one? I send name for reference.—A BEGINNER, Ware, Herts, January 15.

REPLY.—You can make no headway in bee-keeping if the contents of the B.B.J. alone are relied on for all your information about the craft. You should at once invest 1s. 6d. and postage in a copy of the "Guide Book," which is indispensable to your chance of success. Every query enumerated above is fully answered in the book, along with details of every item of work involved in bee-management under all sorts of conditions.

Notices to Correspondents.

Letters or queries asking for addresses of manufacturers or correspondents, or where appliances can be purchased, or replies giving such information, can only be inserted as advertisements. The space devoted to letters, queries, and replies is meant for the general good of bee-keepers, and not for advertisements. We wish our correspondents to bear in mind that, as it is necessary for us to go to press in advance of the date of issue, queries cannot always be replied to in the issue immediately following the receipt of their communications.

D. H. DAVIES (Glamorgan).—*Bee-keeping as a Business.*—1. Your best course will be to write to the Secretary of the Glamorgan Bee-keepers' Association, Mr. W. Richards, The Red House, Gabalfa, Cardiff, who will, no doubt, be glad to enrol you as a member, and advise you with regard to the best course for you to take under the circumstances named in your letter. 2. We shall take no steps with regard to the proposed advertisement till you have written to Mr. Richards, as they may possibly not be required.

C. C. WILLIAMS (Hawkhurst).—*The "Wells" System.*—1. This system is not suitable for use by any but experienced bee-keepers, and even these are by no means unanimous in its favour. 2. The Hon. Secretary of the Surrey B.K.A. is Mr. F. B. White, Marden House, Redhill.

Editorial, Notices, &c.

BRITISH BEE-KEEPERS' ASSOCIATION

The monthly meeting of the Council was held at 105, Jermyn Street, S.W., on Thursday, 21st inst., Mr. T. W. Cowan in the chair. There were also present Colonel Walker, Messrs. R. T. Andrews, T. Bevan, W. Broughton Carr, J. B. Lamb, W. F. Reid, G. H. Skevington, Ernest Walker, and the Secretary. Apologies for enforced absence were received from Rev. H. R. N. Ellison, Mr. E. Gareke, Mr. J. P. Phillips, Mr. A. G. Pugh, and Mr. W. Richards.

The minutes of the previous meeting were read and confirmed.

The following new members were elected, viz.:—Mr. W. Gordon Adam, Hillcrest Apiary, Elgin; Mr. John Cunningham, Stetchworth, near Newmarket, Cambs; Miss Leila Dawnay, West Heslerton Hall, York; Rev. A. D. Downes-Shaw, Kettlestone Rectory, Fakenham; Mr. W. J. Owers, 20, Boston Road, Hanwell; Mr. F. Scarlett, Furze Lawns, Three Cross, Wimborne, Dorset; Mr. Albert Ed Smith, 30, Rosebank Road, Hanwell, W.; Mr. Edward Todd, 9, Drummond Street, Inverness; Mr. Ernest Watson, 26, Holywell Hill, St. Albans.

Mr. Cowan feelingly referred to the great loss sustained by the Association by the death of Mr. W. H. Harris, whose efforts on behalf of the Society, more especially in its educational work, were so freely and satisfactorily rendered. It was unanimously resolved to send a letter of condolence with the family and relatives.

The Finance Committee's report was presented by Mr. Cowan, and formally adopted. It gave particulars of receipts and expenditure to date.

A report of the Examination Committee was received, and a recommendation that a high standard of efficiency in the second and first grades be maintained was generally approved.

It was reported that Colonel Walker had kindly presented to the library Vols. 17 and 18 of the BRITISH BEE JOURNAL, and that Vol. 22 had been given by another member. As Vols. 4, 11 to 16, 19 to 21, and 23 onwards are required to complete the set, it is hoped that some members or readers may be able kindly to assist by the gift of one or more of the volumes.

The next meeting of the Council will be held on Thursday, February 18.

THE DISCOVERY OF THE ORIGIN OF BEESWAX.

AN IMPORTANT CHAPTER IN THE HISTORY OF BEE-KEEPING.

By Lieut.-Colonel H. J. O. Walker.

In Mr. Cowan's new book, *Wax Craft*, which every bee-keeper should possess, the discovery of the origin of beeswax is but briefly considered, as was unavoidable in so concise a work. It is now my purpose, if I may be allowed the necessary space, to go fully into this subject, one which very few bee-men have had the leisure, opportunity, or perhaps the inclination to investigate. To the best of my belief the facts have never yet been properly collected and brought to light.

A brief study of Aristotle's *History of Animals* suffices to show that in his time the ideas of learned men on the production of honey-comb were very vague. Some three hundred years later, at the beginning of the Christian era, Pliny, the assiduous compiler, sums up in one brief sentence the knowledge of his day: "They [bees] make wax of the flowers of all trees and growing plants except Rumex and Echinopus [dock and goosefoot]." *Nat. Hist.*, xi. 8.

As far as can be gathered from MSS. and printed books hitherto available, no further progress was made until the beginning of the seventeenth century, when Charles Butler, the father of English bee-keepers, and at that time student at Magdalen College, Oxford, published *The Feminine Monarchie, a Treatise concerning Bees and the due ordering of them* (Oxford, 1609). He was the first to state definitely that wax had no connection with pollen, but was carried by the bees—he knew not how—in the form of little scales which, after mastication, they moulded into comb. "How much wax they bring at once, doth appeare by the new swarmes whose first weekes worke is spent chiefly in building combs: wherein they are so earnest that it falleth out with them as it is in the proverbe, *The more hast the worse speede*. For many of their burdens do fall from them before they can fasten them to the combs. You may then see great store of them upon the stoole by the skirts of the hive, like unto the white scales which fal from young birds feathers. And therefore some have imagined that they also are scales which the yong Bees do likewise shed from their wings. But put you some of those parcells together with warme fingers, and you will quickly be resolved of that doubt." (Ch. vi., par. 6.) "The wax they gather with their fangs: which being kept soft with the heat of their little bodies, of the aire, and of their hives is easily wrought into combs. . . . You may behold them

working on the edges of their combs, and having blowne their liquid and soft wax out of their mouths . . . fasten and fashion it with their fanges and forefeet." (Pars. 4 and 5.)

The next step forward was made by Martin John, a physician of Lauban, a town in the Prussian province of Silesia. He certainly discovered that the wax scales were to be found in the abdominal pockets of the worker-bee: whether his discovery went farther or not cannot so easily be decided. His treatise was entitled *Ein neu Bienen-Büchel in welchem gehandelt wird vom Nutz des Honigs und Waxes, Wartung und Schnitt der Bienen im Frühling, Hülfsmitteln zum Schwärmen, Wartung der Bienen im Sommer, im Winter, von den Feinden, Krankheiten und Cur derselben, vom Eintragen und Auszfliegen, zu bereitung des Honigs und Reinigung des Waxes. Welches aus langer Erfahrung zusammen getragen und auff Begehren guter Freunde in Druck gegeben.* Martin John, Lauban, bey Michael Deuschländern, 1684. Zittau, druckts Michael Hartmann. [A new bee-book, treating of the profit of honey and wax, the care of bees and how to cut out their combs in spring, helps to swarming, the care of bees in summer and winter, their enemies their diseases, and the cure of them, their bringing in and flying forth, the preparation of honey and the cleaning of wax; put together after long experience, and by the desire of good friends printed.]

According to Baron v. Berlepsch, *Die Biene*, second edition, 1869, a second edition of John's treatise was published at Freyberg in 1691, but I have not, in many years' inquiry, been able to hear of a copy of either edition in any Continental library. The title as quoted above is from a review by Rosenkranz in Johann Riem's periodical publication, *Neue Sammlung vermischter ökonomischer Schriften*, Dresden, 1797; Theil XI, pp. 221-28. It is also given as *Ein Bienen-Büchel . . .* in Matuschka's *Beyträge zur Kenntniss der Bienen . . .* Züllichau, 1805. Vol. 2, pp. 9 and 10.

Fortunately for the purpose of our inquiry, Dr. Heydenreich, in his *Meine Erfahrungen und Meinungen*, Mittenberg and Leipzig, 1796, supplies the following important passage, taken verbally, as he tells us, from p. 55 of John's book:—"Das Wachs tragen sie am Bauche im Panzer, allda machen sie kleine Kücklein, stecken ihr ein 6 oder mehr gegen beyde Seiten in die Panzerglieder, die sind geformt wie Körnlein von Rotterich oder Binglekraut. Sind aber klein, dass wenn man ihrer gleich 5 oder 6 zusammendrückt, ist kaum ein Kaulichen als ein Corianderkorn, aber schön klar, wie rein Wax und ganz schmeidig. . . . Manch

alt Bienenwärter hats seine Tage nicht gesehen, ich aber habe es gesehen und zusammen gedrückt." [The wax they carry on their belly in their coat of mail; there they make little cakes; of these they tuck six or more on both sides into the joints of the armour. They are shaped like little grains of Rotterich or dog's mercury, but are small, so that if you press together even as many as five or six it forms a pellet hardly as big as a coriander seed. It is quite clear, like pure wax, and quite mouldable. . . . Many an old bee-master has not in all his days seen (these scales), but I have seen them and pressed them together.]

Rosenkranz, in his review mentioned above, paraphrases as follows:—"Das Wachs tragen sie am Bauche im Panzer, wo 6 und mehrere Scheibchen auf beyden Seiten in den Gliedern stecken." [They carry the wax on their belly in the coat of mail, where six or more little discs adhere in the joints on both sides.] He continues:—"Der V. . . . weiss aber nicht woher sie es bekommen so wenig wie das Vorwachs, das sie an den Füssen heimtragen. Weil sie aber vieles Wachs bringen, wenn sie gute Honigerndte haben, so mutmasst er, dass sie beydes besammen finden." [The author does not know where they get it any more than where they get the propolis,* which they bring home on their feet. But as they bring in much wax when honey is plentiful, he concludes that they find them both together.] Here Riem adds an editorial note:—"The author discovered that wax was sweated out, only he knew not how."

Matuschka, in his above-mentioned *Beyträge*, Vol. 2, p. 18, paraphrases the passage into "where six or more little discs are present (stehen)," and draws the same conclusion as Riem.

At the risk of wearying my readers I have now given them an opportunity of forming their own opinions as to the extent of John's discovery. Mine is that even if my translation of the uncouth old German is at fault, there is no reason, with due regard to the full context as supplied by Rosenkranz, to credit John with the belief that wax exuded from within the workers' bodies into the pockets. He discovered the scales in position, but, like Butler, he believed that the substance from which they were moulded was found ready-made outside the hive. I may mention that Riem's knowledge of John's book was evidently derived solely from the review, and that Matuschka was bent on proving that the knowledge of his day was no advance on that of the bee-masters that preceded it.

* The usual dictionary meaning. John could not have meant pollen; so acute an observer must have often noticed the bees gathering it.

Let us turn aside for a moment to consider the views as to the origin of wax entertained by contemporary men of science:—Swammerdam, 1637-85; G. F. Maraldi, 1655-1729; and Réaumur, 1653-1757. Swammerdam believed that it was in some way or other prepared by the bees from pollen, but whether by the admixture of their saliva, or of digested honey, or of the fatty and poisonous liquor of their sting he was unable to determine. His treatise on bees, though finished in 1673, was not published until 1737-38, when it appeared as part of his *Biblia Naturæ* in Dutch and Latin. Hence Maraldi, whose *Observations sur les Abeilles* appeared in the *Mémoires de l'Académie Royale de Sciences*, Paris, 1712 (Vol. 14, pp. 299-335), wrote independently of Swammerdam. Taking it for granted that the pollen stored in cells must be the source of wax, he says (p. 321):—"Before employing this wax [the bee-bread] in comb-making the bees must in some way prepare it," and there he leaves the matter, making no further conjecture. So deeply interested was Réaumur in the honey-bee that he devoted to it the preface and greater part of the fifth quarto volume of his *Mémoires pour servir à l'Histoire des Insectes* (Paris, 1740). Though he refers many times to wax and its origin, his opinion is nowhere more clearly given than on p. xxv of the preface, from which I quote:—"The conversion of the raw wax [pollen] into real wax is not so simple; it is analogous to the conversion of our food into chyle—that is to say, wax is made in the intestines of the bees and in one of their stomachs, for they have two. Very sure observations have shown us that the bees eat the raw wax: after digestion they return by the way of their mouth the true wax that they have extracted from it, resembling both in form and consistence a clear and sometimes frothy broth."

Science, then, for want of practical knowledge, was still unenlightened. Hornbostel, who will shortly make his appearance, conjectures that "had Swammerdam and Réaumur only discovered the plates of wax in the compartments they would quickly have perceived how they arise." It was not likely that much should be known of Martin John, but Butler's treatise had been translated into Latin, *Monarchia Famina* (London, 1673*), and in that form was alluded to by Réaumur (Vol. 5, p. 233); hence it is at first sight astonishing that the description contained in it of the wax scales should have escaped his attention. On reference, however, to the translation it will be found that the passages relating to

them were shorn away by Richardson, who calmly remarks in his preface, "Many embellishments [ornamenta pleraque et emblemata] have I for the sake of brevity deducted."

Four years later than Réaumur's fifth volume, the Rev. John Thorley, of Chipping Norton, Oxon, on pp. 135-36 of his *Melissologia, or the Female Monarchy* (London, 1744), written upon forty years' observation and experience, stated that, having noticed something unusual in the appearance of a bee returning to the hive, he had seized her, and found "no less than six plates of solid wax upon the belly, within the plaits," and another time as many as eight. Like his predecessors, he left the matter there, concluding that the bees gathered the wax somewhere outside.

In the same year there appeared in the *Hamburger vermischte Bibliothek*, a miscellaneous magazine published at Hamburg (Vol. 2, pp. 45-62), an article entitled "Neue Entdeckung wie das Wachs von den Bienen kömmt [New discovery of how wax comes from the Bees], imparted by Melittus Theobastus." Seven years later it became known that the author was the Rev. Hermann Christian Hornbostel, Hauptpastor of St. Nicolai, in Hamburg, when he wrote the article, but formerly Pfarrer at Dörvera, in the district or township of Lüneburg, Hanover, where "nearly twenty years ago" he kept bees and, as it may be assumed, made his discovery.

Hornbostel's article, written in a clear and modest style, is throughout extremely interesting. After explaining how pollen is collected and that it is in no way akin to wax, he shows how, if sought for at proper times and under certain conditions, wax scales are to be found in pockets on the abdomen of the worker, and fragments of them bitten into by the jaws of the workers when building comb may be seen on the floors of hives; he then gives good reasons why the scales cannot have been inserted from without into the pockets, but must originate in the body of the bee and find their own way into the compartments. "This," says he (pp. 60-61), "is my opinion: The wax particles are mixed with the honey that has been collected from the flowers, and by digestion of this (mixture) such a decomposition takes place inside the bees [durch die Verdauung aber geschieht in den Bienen eine solche Auflösung derselben] that they can separate (the wax) as a fluid substance from the chyle by means of the vessels (*vasa secretoria*) that serve thereto, from which it is conducted into the compartments through little passages or ducts. This secreting process takes place by degrees, until the scales have become so thick that the bees can grasp

* According to Réaumur, the date was 1671, but I am convinced that this is an error.

them with the little claws on their feet, and take them out and use them in the manner mentioned above. This explanation seems to me the most natural and the simplest." And, in a note: "Should anyone entertain the opinion that from the bee-bread also particles can be secreted into wax, I have no desire to contradict him. Yet I believe that the substance of wax exists only in the honey, because it is just when the bees are gathering honey daily, or are being plentifully fed, that they work hard and that you find the wax scales."

In the bee-keepers' world at large Hornbostel's magazine article probably made no great stir. Johann A. Overbeck, another clergyman in the district of Lüneburg, gave him full credit, under the word "Wax," in his bee-keeper's dictionary, *Glossarium melitturgicum oder Bienen-wörterbuch* (Bremen, 1765). A few years later, however, we find François X. Duchet, Chaplain of Remaufens, in the Canton of Fribourg, Switzerland, publishing his *Culture des Abeilles* (Vevey, 1771), in which, as a long conversation between a bee-keeper and his friend, he makes known his "discovery" (see preface) on the origin of wax, and, without casting any reflection on the author, I can best describe this treatise as an elaboration of what we have already learned from Hornbostel.*

(Concluded next week.)

Correspondence.

The Editors do not hold themselves responsible for the opinions expressed by correspondents. No notice will be taken of anonymous communications, and correspondents are requested to write on one side of the paper only, and give their real names and addresses, not necessarily for publication, but as a guarantee of good faith. Illustrations should be drawn on separate pieces of paper. We do not undertake to return rejected communications.

NOTES BY THE WAY.

[7361.] Mice may be excluded from hives by simply driving a wire nail in the end of one of the sliding pieces of wood which form the entrance. If mice infest the apiary and are found trying to gain an entrance to hives, place a few traps on a piece of board under the hive-stands, baited with a tempting morsel, and the

* Hagen, in his *Bibliotheca entomologica*, Leipzig, 1862, Vol. 1, p. 186, dates Duchet's treatise, Fribourg, 1761, and terms the edition I have described the second. The preface, together with other circumstances connected with the work, render this practically impossible. He had not himself seen the book, and his informant was probably deceived by its having appeared at the same time in Fribourg and Vevey, and, making a mistake in the date of one issue, concluded that there were two separate editions. A. de Keller's *Bibliografia di Apicoltura*, as usual in the absence of original information, follows Hagen.

chances are that you will soon be rid of the mice.

Queen-rearing.—May I suggest to your correspondent "Mel Rosæ"—whose query appears on page 20—that he should try rearing queens from his *best* colonies without the trouble of "spooning a little royal jelly" or handling larvæ if he will only prepare a comb of eggs and give it to the bees, who will do all the necessary work of preparing queen-cells, royal jelly, &c., and rearing queens, in my opinion, equal, if not superior, to those raised by the modern methods recently introduced.

Simmins's Uncapping Machine.—Are we to understand that the uncapper is worked cold, or is there any means of heating the knives? If used cold, would it not damage the combs of honey considerably by "reeving" them instead of removing a clean-cut slice, as the hot uncapping-knife does?

Wax-extracting.—The amount of wax obtained from old combs must necessarily vary according to the age of the combs, as it also will according to the thickness of the foundation on which the combs were built. More wax would certainly be got from foundation of six or seven sheets to the pound than where it runs nine sheets to the pound. Then from combs of one or two years' use, as on Mr. Farmer's system of renewing combs frequently, I should expect to get quite 3 oz. of wax per comb by my method of artificial heat and solar extractor combined, described in former "Notes." Of course, I do not follow the let-alone method, as when I start the job I am generally about the premises, and can supply more fuel to the stove and put more combs in as required.

It will soon be time to start hive-making and repairing those now untenanted, also to examine the stored combs for wax-moth larvæ, and do anything necessary to prepare for next season's work. An extra cake of candy may be given where wanted any day on which the bees are flying, with as little disturbance as possible to the bees.—W. WOODLEY, Beedon, Newbury.

THE FRAME-HIVE IN ITALY.

[7362.] I am exceedingly obliged to you for the trouble you have taken in sending me such complete and interesting information in your letter of December 2 respecting the adaptability of your hives to the climate of Italy.

I should like you to know that at the National Bee Congress held at Ravenna in 1904 the inferiority of our standard hive with small frames, introduced from Germany (20 cms. by 25.5 cms. = 7 $\frac{1}{2}$ in. by 10 $\frac{1}{4}$ in.), was unanimously acknowledged, and preference was given to a hive with

larger frames of the "Dadant" type. This type, embodied in my hive "Italia," which we have now used for some years, has brood-frames with a surface 27 cms. by 42 cms. ($10\frac{5}{8}$ in. by $16\frac{1}{2}$ in.) and super-frames of 13.5 cms. by 42 cms. ($5\frac{5}{16}$ in. by $16\frac{1}{2}$ in.). I am sure you will be glad to hear of this new direction which we have given to Italian apiculture.

I take this opportunity of begging you to make known to your English colleagues that we Italians are most grateful to your noble nation for the new proof of self-sacrifice and affection shown by the brave English Navy in the recent great earthquake which has befallen us.

With my sincere regards.—S. MONTAGNO, Professor of Apiculture at Ancona, Circolo Comisio Agraria, Rome, Jan. 20.

ROSS-SHIRE NOTES.

MANAGEMENT OF AN OUT-APIARY.

[7363.] Mr. Doolittle's system of managing an out-apiary, referred to in the review of his new book in last week's B.B.J., is of more than ordinary interest to comb-honey producers. In brief, this is a modification of the "shook" swarm method, but instead of being swarmed on "starters" just as the flow comes on, the entire working force is shaken on to full combs of honey some time before clover begins to yield. At the same time section supers are given, and quickly filled with honey displaced in making room for the queen in the full frames below. This simple procedure effectually climinates the swarming fever, supplanting it by the storing impulse, which once begun is carried on with unabated vigour until the honey-flow ends. In carrying out this plan the removed bee-less brood is tiered up three or four stories high above backward colonies, such as are too weak to work in sections. The great mass of hatching brood turns the weakling into a powerful colony, filling with honey the tiered-up combs, which are then laid by for use in the following season.

In my own practice I get the best results from autumn expansion, using a double-story hive from September to June, thus giving ample room for brood and stores. As honey comes in the brood-nest is reduced to a single tier of selected combs of brood, the removed portion being put on an extracting colony, and finally replaced on the original stock after supers are off. This always works well. The "Doolittle" method may be even better; indeed, my one trial of it last season was in every way a success.

A small colony in a hive doubled with shallow-frames above those of standard size, on examination in early June, showed brood in the upper story only,

the standard frames below being almost full of honey. I shook every bee out of the shallow-frame super, replacing it by a rack of combed sections. These were filled as if by magic, and I had an early "take" of fine heather-blend honey.

Heather Honey in June!—Well, those brood-combs were about filled with the moorland product, and a prolific queen forcing the pace compelled its storage in the sections. I mean to try the plan again this summer, with the view of securing some of the precious nectar that was lost to me through brood-nest storage at the moors.

"*Object, Surmisable.*"—It is to be hoped that my "brither" Scot will not let the sequel to his advertisement remain a matter of surmise. I have personally, although mistakenly, been accused of making this bold bid for matrimonial fortune. The idea, however, is decidedly good, and opens up great possibilities in the way of bringing together kindred spirits, their natural affection accentuated by mutual love for the honey-bee. We have an itinerant grass-widower calling here occasionally who is aroused to something like madness by inquiries after his missing wife's welfare. "Women," he says, "are an invention of the Evil One, and were sent into the world to torment men"! Fortunately, I cannot speak from experience in this matter, but should think there could no worse fate befall a true bee-keeper than to be tied for life to a woman who shared not his love for the inmates of the hive.—J. M. ELLIS, Ussie Valley, January 25.

VITALITY OF BEES.

[7364.] I wish to ask a very ridiculous question in all seriousness:

"How long does a bee live after it is dead?"

Sunday, January 3, was a bright sunny day with us, and my bees, obviously rejoicing in a little freedom after the cooping up under fog and snow, took full advantage of the change. Before sunset a sudden cold snap set in, and I was not surprised to see a fair number of bees drop to earth short of their hives and "turn up their toes." A short time afterwards, the recollection of an experience previously with wasp,—which I will tell you about before I close—caused me to leave a comfortable chair, get a garden lamp, and collect a dozen of the bees from the cold, damp earth on which they lay, and carry them into the house. To all appearance they were as dead as stones, but I spread them out on a handkerchief before the fire, and in seven minutes they were all crawling about and some preparing to fly. I took them to

the garden wrapped up in the handkerchief, and on opening it five took wing. I returned to the fire, and in another five minutes had the remainder in flying order. This was perhaps not very remarkable, as the bees had not been on the ground more than two to three hours; but now for the sequel.

I pondered the matter over that night, and early next morning I went out and got some more of these bees, which had then been lying on damp and, later, frosty earth for seventeen or eighteen hours. These also revived under steady warmth. I then went out and covered some more of the fallen bees with perforated zinc, so that I might be sure of their identity, intending to continue the experiment night and morning until I had determined the limit of their vitality, but, unfortunately, found at night that during the day some insects had entirely eaten out the insides of all the fallen bees, leaving nothing but empty shells, and the conclusion of the experiment has had to be postponed.

Now it is possible that the extraordinary vitality revealed by these experiments may have a practical bearing on bee-culture. Personally, I intend to establish a bee-hospital, consisting of a box with perforated zinc sides, and at any time I see a lot of bees caught in another cold snap I shall shovel them all in and warm them up until they hum like a top. Its effect upon winter and spring dwindling may or may not be of some importance. Finally, here is the experience with wasps which suggested the above experiments, and which may possibly interest your readers as Nature-lovers:—On a hot August day I was boating, and at tea-time found the attentions of the wasps in the cabin so annoying that, to induce them to keep outside, I put a jar about a quarter full of jam on the cabin roof. The jam was already spoiled by the presence of several drowned wasps in it. The trap answered so well that, on clearing up, the jam was packed full of wasps. Instead of heaving the jar overboard, I put it into a locker, and twenty-four hours later, when returning, moored at the same spot, and, finding wasps again troublesome, I turned out the whole mass of jam and dead wasps into a big saucer, and put it on the cabin roof again. Half an hour later, when clearing up, I found a crowd of wasps on and about the saucer, but to my astonishment those I had regarded as dear departed ones were commencing to come round under the strenuous assistance of the latest arrivals. For quite two hours I watched the newcomers stand the drowned wasps on their heads, turn them round, clean their wings and legs, until finally every single one in what had been a mass of about a hundred wasps sub-

merged for at least twenty-four hours took wing, apparently as fit as ever! Were the rescuers moved by philanthropy or jam, or both? In any case, I return to the question I asked at the commencement of this letter. I send name, &c., for reference.—L., East Yorks, January 8.

[It is a well-established fact that bees, when they become chilled through falling to the ground when attempting to re-enter their hives in cold weather, may remain outside till next day in a state of suspended animation, and die outright; but will, if thoroughly warmed up indoors, recover and fly off home as if nothing had happened.—Eds.]

WINTER BEE-WORK.

[7365.] There is at this season a good deal of work in connection with the apiary which may profitably employ the bee-keeper while the bees are in the dormant state. Too many are apt to postpone little jobs till the honey-flow comes, when there is a rush for things wanted, and they have to be hurriedly got ready in the "slap-dash" fashion which is so trying to the temper of the bee-keeper. A most necessary job—if not already done—is to see that roofs are made watertight, which can be done by one of the many methods described in the "Guide Book" and in the B.B.J., as suits individual tastes. All empty hives should be thoroughly cleaned in hot water, with soap and dilute carbolic solution added, after which they must be painted outside; if this is done now, it gives the paint time to dry thoroughly. The annoyance of mice getting into hives is easily prevented by fastening a piece of excluder-zinc over entrances, or by setting baited traps near the hives so troubled. Meanwhile, the bees should be disturbed as little as possible, except when stores are suspected of shortage, in which case a cake of soft candy must be given at once. If coverings are damp, replace them with dry ones. A very annoying thing is not having plenty of dummy-boards when wanted, which should fit spare hives; the remedy is obvious. Section-racks should be scraped clean of brace-comb and propolis. Spare frames, when fitted with foundation, should be hung up by the "lugs," as they are in the hive; if laid flat on the workbench or elsewhere something is almost sure to be put on top, causing the foundation to be broken or twisted out of shape. It is a very bad plan to have hives without legs or stands placed on the ground. For those without legs a stand can be made from two stout pieces of timber long enough to accommodate all legless hives—with spare room for extra ones—and nailed to four posts driven into the ground—two at each end. But loose stands are

best. Finally, after having seen to these few small details the bee-keeper should make up his mind *now* what he intends to do during the coming season, and thus save himself endless annoyance when the busy time comes.—W. S. WARSON, B.B.K.A. Expert, Wolsingham, Co. Durham.

THE QUEEN-BEE'S STING.

[7366.] May I raise the question as to whether the sting of the queen is used as an ovipositor or not? It is common with writers to state that it is so used, but there evidently is a doubt in the minds of those who have examined the abdomen of the queen by the microscope. Mr. Cowan says: "Between this (the vagina) and the last abdominal plate are situated the sting and the poison glands, which are placed between the vagina and the chyle-stomach" (*vide* "The Honey-bee," page 137). Also (page 74) he shows that Dewitz and Vogel and others point out that the sting is anatomically analogous to the ovipositor, but at the same time is different. If the sting lies outside the vagina, how can it be used as an ovipositor? Again, very few, after examining by means of a powerful lens the structure of the sting, will agree that the sting can act as an oviduct.

Mr. Tiekner Edwardes, in his excellent book "The Lore of the Honey-bee," states (page 172) that the sting, aided by its accompanying palpi, acts as a "guide" to the egg, and that the egg is glued into position in the cell by a secretion from the gland which in the worker secretes the poison injected into the wound. Surely, if this were so, the gland in the queen would of necessity be far more bulky than it is, so as to provide the large supply called for in the height of the laying season.

On examining a comb with new-laid eggs, it will be seen that the eggs are almost central in the cell. Now the sting being curved downwards, if it were used as a guide, it would direct the egg to the lower angle of the cell, certainly not up to the centre, and it seems almost impossible for the egg to be placed where it is usually seen if the curved sting is the guide.—A. D. DOWNES-SHAW, Fakenham, January 15.

[Attention is drawn to the analogy of the bee's sting to an ovipositor in "The Honey-bee," by T. W. Cowan (page 74). The German scientists Dewitz, Vogel, and others—among them Mr. R. A. Grimshaw, who wrote on the subject in the B.B.J. in 1888—have pointed out that the bee's sting is not only analogous to an ovipositor, but is actually used for this purpose by the queen-bee. This view has not met with general acceptance, and the question has apparently dropped out of notice.—Eds.]

HEREDITY IN BEES.

[7367.] While enclosing my half-yearly subscription for the B.B.J., allow me to express my appreciation of same. Although seasons, climate, conditions, &c., are entirely different from what you have got in the dear old homeland, yet your journal contains much valuable information for this country. Reverting to those pugnacious bees I wrote you about some time ago, I have been informed by a former owner of the farm that they used to run amok, if we may so term it, at regular intervals. Suddenly, and without apparent cause, they would pour out of the hive and attack everything about the place, everybody being compelled to remain indoors till after sundown.

Is it a usual trait in your northern bees for queens from the same mother to vary very much in colour? Sometimes in the one batch of cells I get queens from very light in colour to almost jet-black, the workers from the light queens keeping consistently to a light colour, while those from the dark queens grow darker as they get older till almost quite black. So far, I may add, I have found the blacks superior in every respect; but, while not vicious, they are not quite as easy to handle as the light-coloured bees. Perhaps Mr. Crawshaw, who has been giving us some very interesting pars. on parthenogenesis, can throw some light on this "dark subject."

I have just had a queen hatched out and laying worker-eggs in nineteen days from the time the cell was started. Is this time not unusually short? [Not abnormally short for your warm climate.—Eds.] As I removed the queen to get cells started, which I gave to a nucleus twenty-four hours later, there is no uncertainty about the time.

I send name as before, and sign—**HIBERNIAN**, Natal, South Africa, January 2.

[We can promise our correspondent and all interested in the subject of parthenogenesis—along with that of heredity in bees—that a considerable amount of "light" will be thrown on that very abstruse question in our pages within the next week or two.—Eds.]

SWARMS VERSUS DRIVEN BEES.

[7368.] May I be allowed to point out, in reply to "D. M. M., Banff," in B.B.J. of January 7 (page 2), that it is an error for him to compare the value of swarms against driven bees the same years as when purchased? I contend that it is impossible for him to know that "in a double sense driven bees are dearer," as he states on page 373 of B.B.J. of Sep-

tember 17 last year, until the results of the following season are obtained. The value of driven bees may be proved in the spring in comparing them with early swarms. The former have a queen in her prime along with a host of late-hatched workers to help her in making up a strong colony in time for the honey-flow, whereas the swarm has a queen in her second season at least, and is thus naturally at a disadvantage in comparison. Driven bees are generally purchased with a view to enlarge one's apiary or to strengthen weak stocks, or else to fill empty hives, which would otherwise be awaiting the early swarm. The second error I would point out is to count cost of carriage when comparing values, especially so when in "D. M. M.'s" case the carriage was increased from 3s. 3d. for two lots by 5s. because the bees arrived too late to catch the usual carrier. I have numerous customers who call at my place for their driven lots, and several others not far away to whom I send at a cost of 3d. per lot; so it will be seen how misleading it is when comparing values to include cost of carriage. I certainly agree that if swarms are obtainable in May or first week in June they are the best in establishing stocks; but when the end of the following season arrives the result will prove that the same weight of driven bees will give good value in comparison. Swarms that give good results in the season when obtained generally fail the following year. I have never met a customer for driven bees who expected a good result from his purchase from me before the following season.—T. D. SINFIELD, Luton.

WAX-RENDERING.

[7369.] Allow me to thank your correspondent "D. V., Dunaskin," for his further contribution to the above subject on page 24 of last week's B.B.J. The apparent discrepancy in my quantities to which he refers is easily explained, and should perhaps have been more plainly stated in the first case. The point in question was the relative efficiency of "solar" and "water" extraction on *old* combs. I, therefore, for that particular experiment, selected the ten oldest and most pollen-clogged combs in all my lot, which accounts for the yield being smaller than the average. In reply to his queries, let me say I melted down 120 frame-combs last season, besides combs from a lot of skeps, and in so doing spent *no* time in watching, *no* stirring, and, may I add, *no* soaking, *no* breaking up into little bits, *no* straining, *no* smell in the house, and *no* cleaning of copper and utensils. I simply cut out the combs—each in three pieces as a rule—place them in the ex-

tractor, turn the latter more direct to the sun whenever I happen to go near it (or ask anyone else who may be about to do so), and then remove the residue when convenient, but preferably while still warm, when it comes away much more easily.

Now, in turn, if we are critically inclined we may see some little variations in "D. V.'s" letters. For instance, on page 25 we have ten minutes given as the total time for ten combs (I confess that Old Sol cannot melt a comb in a minute even on the hottest day), but in the B.B.J. of August 13 last (page 324) we have, *in addition*, soaking, spraying, and a second boiling and straining, to say nothing of cleaning up. It was *all* this I had in mind when expressing my doubts of the results being worth the trouble to a man whose time is valuable.

I also thank Mr. Atkins for his kind appreciation, and will, with your approval, take an early opportunity of describing my extractor, which is not quite like any other I have seen.—A. ARNOLD KING, Hastings. January 21.

AMERICAN AND COLONIAL PAPERS.

EXTRACTS AND COMMENTS.

By D. M. Macdonald, Banff.

A Real Philanthropist.—At the late convention a Mr. Manley appeared, and, according to "A. I. R." in *Gleanings*, showed how he appeared like an angel in disguise, clearing out all remains of foul brood by scouring the country and purchasing, to his own and their owners' profit, all the remnants of "blasted hopes" in the form of hives and their contents lately tenanted by diseased bees. "He goes a step further, and suggests it would pay any bee-keeper to melt up his combs, especially the brood-combs, every four or five years, and fill the new frames with new sheets of wired foundation." I rather think such a plan is systematically practised at the Roots' own yard, even when there is no foul brood manifestly present, and on page 1366 the editor endorses it. If in a foul-brood area I would highly approve of it. By the way, the editor makes the, to us on this side, peculiar assertion: "This convention was remarkable in that there was no bitterness or personalities indulged in, either on the floor or between sessions."

Tall.—Mr. Hotterman, recording the flight of two swarms over Lakes Erie and Ontario, says: "They would have to travel forty-six miles over water," and "This swarm would have crossed the lake from the United States, a distance of over fifty miles." I make no comment, but my one-word heading.

Optimistic.—"If we could control mating (and we shall be able to do it some day), and if somebody else will reduce the length of the corolla of the red-clover tubes (and we believe it will be accomplished some day), we shall make available thousands of tons of nectar that are now being wasted." This dream of Mr. Ernest Root is a consummation devoutly to be desired. Anyone who has sucked the corolla of the red clover (and what boy has not?) knows it is very rich in a nectar sweet and pleasant to the taste, and apparently easily available but for the length of the tube.

Again!—"The old-fashioned (or American) foul brood is easily held in check by an intelligent bee-keeper; but the black (or European) foul brood is an entirely different disease. It spreads more rapidly and seems to resist in some cases the most intelligent methods of cure." This is bewildering! I sigh for the time when a common language will be spoken by bee-keepers, at least those who use the English tongue.

A Wire Cap over Hives.—Mr. Beuhne, in recording particulars of his late travels in the *Australian Bee-keeper*, attributes the gentleness of the Roots' bees to the use of the above. "This trait of gentleness is in a great measure due to the use of a wire-cloth cage which is put over any hive which is opened for more than a few seconds. It is large enough to leave room for the operator, and he, as well as the hive, is unmolested by outside bees."

Small Nuclei.—"These have proven very satisfactory," says *Gleanings*, "although some of the experts are beginning to feel that it may be perhaps cheaper, after all, to use nuclei on full-sized combs and frames, thus saving the expense of odd-sized hives and fixtures." Mr. W. H. Lewis, of Texas, a veteran queen-rearer, reports that, "taking the whole season through, there is really less labour by employing three-frame nuclei of the regular size. Such nuclei take care of themselves right along, month after month." This is a useful hint for any meditating starting queen-rearing during the coming season.

"Not Worth Patenting."—The editor of *Gleanings* once wrote these wise words: "We would not give one cent for a patent on any kind of feeder, because there are too many good unpatented feeders, so that anyone who gets out a patent on a feeder is wasting his good money for nothing. We do not know of one feeder that has earned its owner a cent." Are not patent hives also much in the same category?

Queries and Replies.

[3873.] *Re-queening Every Two Years.*—I should be obliged if you would kindly answer the following query in the B.B.J.:—A bee-keeper has fifteen colonies of bees, and desires to re-queen each stock every two years; moreover, his wish is to re-queen them all at the same time and in the most economical way. So far as my knowledge of bee-keeping goes, I do not see how this could be profitably done by forming nuclei. The only method that seems advisable to my mind is to remove the old queens and give each stock a ripe queen-cell. This would, of course, be done in the early spring. If this method was resorted to, how long would you advise a stock to be without a queen before introducing a ripe queen-cell? Would you advise this method of re-queening, or can you suggest a better plan? Your comments will be appreciated. I send name for reference. —ROBIN HOOD, Bristol, January 16.

REPLY.—A full and adequate reply to your query will be found on page 11 of our issue of January 14, wherein M. Adrien Gotaz describes with lucidity his method of rearing and introducing queens. Our correspondent will find the plan there given simple in carrying out and safe in results.

[3874.] *Persistent Swarming.*—The query I am about to ask will, I fear, display my ignorance, but after taking the B.B.J. for nearly two years I have not seen a similar case answered. Last season one of my stocks on twelve standard frames swarmed five times, though I ran them back each time and cut out queen-cells; but after all this upset they gathered 50 lb. of surplus and ample stores to winter on. Is that a fair average, or would they have gathered more if they had not swarmed so repeatedly? I may say this is a fairly good district, with plenty of fruit-bloom and clover. After reading Query 3863 in B.B.J. of January 14 (page 19), I thought the following incident might be of some interest to your readers:—On January 10 I had occasion to get up at 4 a.m. to attend to someone who was ill, and after putting on my bedroom slippers, which I had been wearing up to 11.30 the previous evening, I felt something prick my foot, and on pulling my slipper off double quick I found a worker-wasp busy stinging my instep.—A BEGINNER, Middlesex, January 15.

REPLY.—We should call 50 lb. of surplus and abundant stores for winter a very fair average for so variable a season as that of last year, but it is also plain that the time lost by the bees through

their persistent attempts to swarm must have made an appreciable effect in reducing the ingathering, when every good bee-day means so much in a short season. Referring to the wasp incident mentioned, we think it would be a small queen, as the workers all die off the same year, only queens surviving till the following spring.

[3875.] *Bees on Railway Embankments*.—1. I shall esteem it a kindness if you will kindly tell me through the B.B.J. whether, if I can obtain standings for hives on the side of the railway line, the vibration of passing trains would be injurious to the success of bee-keeping. 2. What is the usual charge per hive for permission to place hives in ordinary fields? 3. Is the ordinary "fog" which usually arises near a river injurious to bees? I am asking the above questions because of being unable to rent a small field anywhere in this neighbourhood. Name, &c., sent for reference.—NUCKET, Heytesbury, January 21.

REPLY.—1. Bees have been, and are being, profitably located on railway embankments, but at a distance away from stations, where they might easily create trouble at times among passengers. 2. There is no "usual charge" for the privilege of allowing hives to stand in fields or in orchards tenanted by farmers, such matters being settled by arrangement according to the value to the farmer of the particular piece of land to be given up to the bees. It must be borne in mind that the hives would require to be fenced off to keep horses or cattle from being liable to injury from the bees, along with other details that would need taking into consideration in a matter of that kind. 3. No.

[3876.] *Crewe as a Bee-district—Moving Bees*.—1. Can you tell me what kind of district the neighbourhood of Crewe, in Cheshire, is, considered from a bee-keeper's point of view? A friend who has given up his house in this county (Hampshire) thinks of sending his stocks by rail to that part of the kingdom. 2. Would it be possible for the bees to travel in the frame-hives, and, if so, at what season would they run least risk? Name sent for reference. Advice on the above would be exceedingly welcome to TEST VALLEY, January 16.

REPLY.—1. Our personal knowledge of Crewe is limited, but we should not expect that district to be comparable with Hampshire for bee-foreage. We shall, however, be glad if any readers who can speak with knowledge will send a line of reply to help our correspondent. 2. Bees will travel safely in frame-hives if packed for transit as directed in the "Guide Book" (pages 116 to 120).

Notices to Correspondents.

Letters or queries asking for addresses of manufacturers or correspondents, or where appliances can be purchased, or replies giving such information, can only be inserted as advertisements. The space devoted to letters, queries, and replies is meant for the general good of bee-keepers, and not for advertisements. We wish our correspondents to bear in mind that, as it is necessary for us to go to press in advance of the date of issue, queries cannot always be replied to in the issue immediately following the receipt of their communications.

** We invite attention to the honey competition to be held at Preston in February in connection with the annual meeting and *conversazione* of the Lancashire B.K.A. Full details of the competition appear on page v. of our advertisement column, the entries for which close on Saturday next, the 30th inst.

THOS. HUGHES (N. Wales).—*Official Pamphlets on Bee-keeping*.—The publication you mention will no doubt be one issued by the Department of Agriculture for Ireland, and may be obtained by writing to the office of the Department, Dublin.

J. R. TRUSS (Ufford).—*Trifolium incarnatum for Bee-foreage*.—It is generally accepted by those who have had practical experience of crimson clover (*T. incarnatum*) that the nectar from it is darker than, and inferior in flavour to, white-clover honey; we therefore venture to suggest that the honey to which he refers has been largely mixed with that from a late-blooming crop of the latter.

R. G. W. (Wrexham).—*Moths in Hives*.—The "grubs" sent are the larvæ of the small moth that usually harbour in the saw-cut of top-bars. They are not the genuine wax-moth (*Galleria cereana*), and far less harmful in hives.

Honey Samples.

E. A. F. (Woolwich).—The flavour of sample (granulated) is fairly good, but, being dark in colour, the quality is deteriorated for table use, being suggestive of "honey-dew" when in liquid form, and we do not find the unpleasant characteristic flavour which always spoils good honey when mixed with honey-dew.

R. A. W. (Stroud).—Sample is mainly from white clover, and the quality is good. You are fortunate in the season's crop remaining in liquid condition so long as it has. Most bee-keepers are complaining of the early granulation of the crop of 1908.

** Several important letters, &c., are in type, but held over from pressure on our space.

Editorial, Notices, &c.

REVIEWS OF FOREIGN BEE-JOURNALS.

By "Nemo."

Utilisation of Wax Residues.—L. Pinel mentions in *L'Apiculture Nouvelle* a visit he paid to a manufactory of tapers and refined cakes of wax used for making candles, all the machinery for which was worked by steam and devised by the owner. This ingenious proprietor purchases from dealers in honey and wax all the wax residues he can get hold of, which they obtain in the old-fashioned manner of extracting honey and wax. In a special apparatus, also contrived by him, the refuse is melted with heated benzine, and he thus extracts from the residue an average of 10 per cent. in weight of pure wax. The refuse, after being dried, is ground to powder, and sold to manure merchants. The extracted wax, which is in small flakes, is placed on large sheets and exposed to the sun for the purpose of being bleached. In this way a considerable quantity of wax is obtained, the residue serves a useful purpose as manure, and in addition adds to the profit.

Bee-keeping in Egypt.—A. Schröder, in the *Illustrierte Monatsblätter*, referring to the absence of bees in Upper Egypt, says it is owing to there being no flowers or bee-pasture of any sort. In Lower Egypt, also, in the neighbourhood of Cairo, very few bees are kept, and it was only after considerable search he succeeded in finding a real bee-keeper in the village of Esbesat. As a curious matter of fact, he says the bee is frequently seen on ancient monuments, so that it must have been more in evidence formerly than at the present time.

Interesting Judgment.—Several journals report that a bee-keeper named Quiquerez, of Grand Fontaine (Jura Bernois), who was accused of adulterating honey, has been fined 200 francs and costs, which it is stated were heavy. The accused pleaded in vain that the inferior quality of the honey sold by him was due to the food he gave the bees. The judge said the mere fact that the bees were fed in a manner to increase the quantity of honey to the detriment of the quality constituted a fraud. It would be well if all persons employing such a dishonest method of increasing their honey-crop could be severely punished.

A Curious Custom.—In the *Illustrierte Monatsblätter* Pastor Adamic mentions a curious custom which prevails in several of the Slav countries. Newly-married couples, after leaving the church, go with the invited friends to the house of the bride's parents. Her mother receives

them at the entrance, welcomes them, and then pours into the palm of one hand of both bride and bridegroom a spoonful of honey. The husband then licks up the honey from the hand of his wife, and the latter repeats the operation with the hand of her husband.

Nut Honey-cake.—M. Bourgeois gives the following recipe in the *Bulletin d'Apiculture Romande*:—1. Take 100 gr. ($3\frac{1}{2}$ oz.) of nuts, well skinned and pounded; 300 gr. ($10\frac{1}{2}$ oz.) of liquid honey; six eggs, the whites of which must be beaten to a froth; 100 gr. ($3\frac{1}{2}$ oz.) of sifted flour. 2. First mix the yolks of the eggs with the honey so as to well incorporate them. 3. Add while stirring, little by little, the flour, then the nut, and lastly the beaten egg-froth. 4. Butter a mould, place in it the paste, and bake in a slow oven for half an hour.

Common Black Race of Bees.—M. Douxchamps says in *Le Rucher Belge* that the bee-keeper using frame-hives is seeking a quiet race of bees, hardy, good workers, and not inclined to swarm, while at the same time they should be prolific. These qualities have been secured in the native black bee by adapting it to new and progressive methods and by selection, which was opposed by those who practised the old methods of bee-keeping in consequence of the destruction of bees involved. M. Douxchamps maintains that the black bee has been wrongfully discredited, and goes on to say that in every apiary a great difference will be noticed in the work done by colonies standing side by side. While some are always strong and rapid honey-gatherers, others seeming to work as hard produce comparatively very little surplus honey. Moreover, the same result will happen every year. Good and bad qualities are found in all races, and it is therefore necessary to suppress mediocrity and encourage improvement by selection of the best colonies in the apiary, and breeding from them.

Calorimetric Method of Wax Analysis.—M. A. Corvisy writes in the *Bulletin de la Société de Chimie de France* to say that beeswax, no matter from where obtained, has a combustion-heat which varies within very narrow limits. The average heat given off in the calorimetric bulb for 1 gramme of wax is about 10,300 cal., and the extremes one way or the other vary very little from this average, whereas the combustion-heat of ceresin and paraffin registers about 11,300 cal. It therefore follows that for 1 per cent. of paraffin added to beeswax the heat is raised by 9 cal., and this, in fact, is what has been found in artificial mixtures of wax and paraffin. The calorimeter will therefore enable one to find the usual adulterations of wax with sufficient accuracy for general practice.

WORCESTERSHIRE B.K.A.

ANNUAL MEETING.

The annual meeting of the above association was held at the Church House, Worcester, on January 23, about forty members assembling in the Trinity Hall, the Rev. Canon Coventry, president, in the chair.

The hon. secretary read the report of the committee, which stated that very satisfactory progress had been made during the year, and the treasurer announced a balance in hand of £6 6s. 5d. and a very considerable increase in membership. The Rev. Canon Coventry was re-elected President, and the names of the Rev. E. Davenport, Mr. G. E. Wilson, and Mr. Eyres Monsell were added to the list of vice-presidents.

Messrs. A. R. Moreton and J. P. Phillips were reappointed treasurer and secretary respectively, as were the committee, which was increased by the addition of Misses Johnson, Dudman, and Turner, and Mr. J. Price.

Prize medals and certificates were presented to Messrs. G. Richings, S. E. Hunt, and C. H. Haynes. Mr. C. K. Coutts had secured the second-class expert certificate of the B.B.K.A., and Mr. E. Loxley the third-class.

As the "Royal" Show of 1909 would be held in June at Gloucester, members would have a better opportunity of visiting the Honey Section, meeting well-known bee-keepers, and competing for prizes.

The report and balance-sheet were unanimously adopted.

After taking tea in the Guesten Hall, members and friends numbering over 100 reassembled to hear a lecture on "Bees in Relation to Fruit and Flowers" by Mr. W. Herrod.

The lecturer explained the process of fertilisation by the help of coloured lantern-slides, and enlarged on the evils of incomplete fertilisation of fruits through a lack of sufficient bees, showing on the screen deformed apples and pears to illustrate this. His remarks on the superior quality of apples which result from fertilisation by pollen to another variety of the same fruit created much interest, many members being engaged in fruit-growing in the Evesham and Pershore districts. After the characteristics of the chief bee-flowers, with their comparative values for nectar and pollen, had been discussed, many questions were asked and answered.

The President corroborated from his own experience Mr. Herrod's remarks on the importance of cross-fertilisation for the production of fine fruit, and moved a vote of thanks to him, which was heartily carried.—JOHN P. PHILLIPS, hon. secretary.

THE DISCOVERY OF THE ORIGIN OF BEESWAX.

By Lieut.-Colonel H. J. O. Walker.

(Concluded from page 34.)

Another notable bee-master, Adam Gottlob Schirach (1724-73), must now be mentioned, and at the same time it may be well to say something more about his contemporary and rival Johann Riem. Both these men incidentally helped to keep alive the memory of Hornbostel. Schirach was pastor at Klein-Bautzen, a village near Bautzen, a town about thirty miles from Dresden and at that time the capital of the Margraviate of Upper Lusatia. He is best known as having been the first to work out and put into general practice an improved system of making artificial swarms, based upon the discovery that to enable a colony to raise a fresh queen the presence of a three-days-old worker-larva was sufficient. What chiefly concerns us here is that in 1766 he founded the famous Oberlausitz Bienengesellschaft (Upper Lusatian B.K.A.), on whose lists were soon enrolled as members, honorary members, and correspondents a band of enthusiastic bee-keepers and men of science such as never before had been gathered together, and for many reasons can never exist again. Among them was Charles Bonnet (1720-93), the celebrated naturalist and philosopher of Genthod, near Geneva, who had distinguished himself some twenty-five years previously by working out the life-history of aphides and establishing their generation by parthenogenesis. He had also determined by experiment that insects breathe through openings in their outer coverings, now known as spiracles or stigmata.

As a deduction from Schirach's discovery it became at once obvious that no especial royal eggs were laid by the queen-bee, but that from one and the same egg could be produced either queen or worker, the latter being therefore not sexless as commonly supposed but a female—a startling innovation which was at once assailed on many sides, and found a vigorous and persistent opponent in Johann Riem (1730-1807)*. Originally an apothecary at Lauter, in the Palatinate of the Rhine, this man had yielded to the

* In a paper prepared for the golden jubilee of the Pfälzischen Bienenzüchter-Verein, and entitled *Zur Geschichte der Natur- und Bienenzüchtung* . . . Rehbörn, 1907. Herr Ph. Reidenbach, Editor of the *Pfälzer Bienenzeitung*, states that there were two famous bee-men in the Palatinate, both named Johann Riem, and born in the same year, 1739. I feel sure that a study of Matuschka's *Beiträge*, in which Riem's career is enviously detailed, and of the Dresden Riem's later publications, in which his own earlier works are constantly quoted, would convince Herr Reidenbach that Apotheker Johann Riem in Kaisers-Lautern and Kommissionsrat Johann Riem who died at Dresden in 1807 were one and the same person.

fascinations of bee-keeping, to which pursuit, both as a hobby and in official positions, his life was thenceforward devoted. About 1768 he founded at Kaiserslautern, in the Palatinate, an association on the same lines as Schirach's, and in some measure its rival. He made various observations and experiments, publishing the conclusions he drew from them. Many of these were erroneous, and if we except his having demonstrated the existence of fertile workers, not much remains to his credit as an observer. An indefatigable writer on agricultural subjects and bee-keeping, he was a sharp thorn in the side of poor Schirach, to whose writings and theories, even long after his death, he constantly applied a minute and pungent criticism, sometimes well founded, but often itself in error.

The question of royal or non-royal eggs became more and more embittered until, by actual or tacit agreement, each side referred it for decision to the philosopher of Genthod, and at the same time, though not so much as a matter of dispute, that of the secretion of wax scales. *Wilhelmi*, Pastor in Diesa, Schirach's brother-in-law, and, on his death in 1773, his successor as secretary to the Oberlausitz Association, was his representative. The correspondence, with other interesting matter, may be read in *Blassière's Histoire Naturelle de la Reine des Abeilles* (Amsterdam, 1771 and 1787), which also contains a translation of Schirach's treatise on artificial swarming and part of Riem's correspondence with Bonnet. The whole matter is also fully dealt with in the fifth volume of the latter writer's works (Neuchâtel, 1781).

Bonnet received the arguments of either party in the spirit of polite scepticism which forms part of the equipment—one might almost term it the armour—of the man of science, and could not be induced to accept the new doctrine until Schirach by repeated experiments had furnished irresistible proof. As regards the secretion of wax he remained obdurate, refusing to believe that his great master Réaumur could have been mistaken. In face of this attitude *Wilhelmi* soon weakened, and went so far as to suggest that, after all, the scales might be shavings formed in the rings of the worker's abdomen while it was being used in shaping the comb-cells. Riem could not say that he himself had seen the wax scales, and, being pressed for evidence, fell back on Thorlev, Hornbostel, and a member of the Oberlausitz Association named Beckman, Pastor in Mecklenburg. Called to his assistance, Duchet, on October 27, 1772, sent Bonnet a copy of his above-mentioned treatise of the preceding year. It lies before me as I write: "C. Bonnet" neatly inscribed on the title-page, and on the fly-leaf "Donné par

l'Auteur"—a much-prized possession. But the philosopher was growing weary, and on the score of failing eyesight and pressure of his own work now closed discussion. Science remained unconvinced.

A question of some importance in connection with the Oberlausitz Association has still to be considered. In his first letter to Bonnet (*Blassière's Hist. Nat. de la Reine des Abeilles*, first edition, p. 164) *Wilhelmi* describes the secretion of wax as "one of the new discoveries that the society has made." It would have been more ingenuous to give the credit to Hornbostel, now four years defunct, whose article in the Hamburg magazine was well known to the members of the association, having been the subject of the first paper, apparently by the editor (Schirach), in the "Oberlausitz Abhandlungen und Erfahrungen" (Transactions) (Dresden, 1766). But in reality, as may be gathered from the author's preliminary, dated 1770, in Schirach's treatise as translated by *Blassière*, and as has been already shown as regards *Wilhelmi* in his correspondence with Bonnet, neither of these two firmly believed in Hornbostel's theory.

Who, then, was the member of the Oberlausitz Association who had discovered the wax scales? All the modern writers who, to my knowledge, have dealt with this discovery attribute it to an unnamed Lusatian peasant, an idea which I believe I have succeeded in tracing to *Huber's Nouvelles Observations sur les Abeilles* (Paris, 1814), Vol. 2, p. 38, where he states that "un cultivateur de Luzace, dont le nom n'est pas parvenu jusqu'à nous, fit la découverte," it being evident from the next page that he was merely referring to *Wilhelmi's* above-quoted report to Bonnet. In the English translations subsequent to 1814 (Edinburgh, 1821, &c.) the passage is rendered: "A Lusatian cultivator whose name has not reached us"; but the translator was too timid. *Huber* certainly meant "un cultivateur d'abeilles," an apiculturist, not a tiller of the ground. This bee-keeper might or might not be a peasant; he was a member of the Oberlausitz Association, which was all that *Huber* knew.

Having, as I believe, dislodged the unnamed peasant, I have pleasure in introducing *Johann Urban, Hoch-Reichsgräfl. Förster in Thräne*,* as the member whom *Wilhelmi* had in mind, my authority being a note on p. 4 of the above-mentioned article by Schirach in the "Oberlausitz Abhandlungen und Erfahrungen" (Dresden, 1766), pp. 3-20:—"Bevestigung der Hornbostelischen vortreflichen physikäl-

* *Thräne* is probably the village now known as *Threna*, between *Frohburg* and *Regis*, in the Duchy of *Altenburg*. The appellation *Hoch-Reichsgräfllich* implies that *Urban* was in the service of a Count of the German Empire who owned an estate there.

sehen Erfahrung, dass die Bienen das Wachs ausschwitzen. . . ." It runs:—"But what a humiliation for those boastful men of science [Maraldi and Réaumur] when I mention quite incidentally that this same discovery had been made long years before by a new member, one John Urban, a forester from Thräne, whom we enrolled at our last St. John's meeting. Unaware that we already knew of this genuine fact, he disclosed it to us, and as a proof at once fetched a bee, and without any difficulty showed us the little white leaves underneath their scales. Thus truth often remains hidden in mysterious bee-fathers!" The last name but one on the list of members for 1767 is Johann Urban, H. R. Förster in Thräne.

Where on our roll of honour should the new member have a place? Schirach's high-flown phrases must be taken with some reserve, for, though a pious and worthy man, he was an inaccurate writer. In the article from which I have been quoting he gives a very misleading account of the opinions held by Maraldi and Réaumur, and in a paper read to his association on June 24, 1767, of which a translation is given by Blassière—*Hist. Nat.*, p. 64—we find:—"Some writers hold that the drones are females; such are Butler, Purchas, and Bradley," whereas each and all of the three distinctly asserted that the drones were males. Granted that, as I believe was the case. Schirach knew little of French or English, still a fairly careful writer would never have made such mistakes. Leaving my readers, as before, to form their own opinion, I place Johann Urban alongside of Thorley. He may have known more, but there is no evidence adequate to prove it.

For the next quarter of a century the question of the origin of wax attracted little attention until, on February 23, 1792, John Hunter, the great English surgeon and anatomist, submitted to the Royal Society his "Observations on Bees," published in their "Philosophical Transactions" for that year (Vol. 82, pp. 128-95), in which he described his discovering the wax scales on the workers in his glass hive, and asserted that they were an "oily secretion." There can be no doubt that, as far as Hunter was concerned, the discovery was original.

In the following year François Huber (1750-1831), the blind Swiss naturalist, whose romantic love of bees, together with the many useful experiments that he carried out by means of his leaf hive, soon made him famous, and must always render his memory dear to every bee-keeper, took up the subject. Under the friendly advice of Bonnet, with whom he had been in frequent correspondence since 1789, he had worked as set forth in his *Nouvelles Observations sur les Abeilles*

(Geneva, 1792). The next year Bonnet died, and Huber, after a short period of discouragement, felt himself free to investigate subjects which during his mentor's lifetime had been considered as closed to discussion, and the most interesting being the origin of wax, it was to this inquiry that he turned.

No mention of Hornbostel, or even of Huber's fellow-countryman Duchet, will be found in the second volume of the *Nouvelles Observations* (second edition, Paris, 1814), in which we learn (p. 40) how Huber and his son Pierre, now assisting him, were "much astonished to find under the bees' rings plates of a substance apparently analogous to wax." He knew of the correspondence between Wilhelmi and others and Bonnet—even mentions Wilhelmi's letter and the Oberlausitz Transactions—but practically ignores all. Whether as the result of his infirmity or from a desire to work independently, it was Huber's way to set aside or refrain from ascertaining the investigations of his predecessors*: it would not be difficult to show that all his discoveries had been anticipated. But whereas the discoveries of others had been little more than conjectures—though founded often enough on the experience of practical bee-keepers—every question of bee-life that Huber took up he proved by methods so truly scientific that with only a few trifling exceptions his conclusions have never been disputed. So was it with wax; he proved beyond all cavil that it was a secretion arising from the digestion of honey or some saccharine substitute, and that it could be produced independently of the presence of pollen. At the same time he determined how in other ways the latter substance was an absolute necessity in the economy of the hive. Science at last was satisfied.

I have done my best to be accurate and impartial in this important and, as I hope it will be found, interesting chapter in the history of bee-keeping. With a view to further publication, criticism from any quarter will be welcome, and especially from those whose acquaintance with the peculiarities of old German enables them to estimate the extent of Martin John's discovery. For bibliographical reasons I shall be very grateful to anyone who will make known to me the existence of a copy of his book.

The following chronological summary of my conclusions may be found useful:—

1609.—Charles Butler, of Magdalen College, Oxford, in his treatise *The Feminine Monarchie*, describes the wax scales, and how after mastication they are made into comb.

1684.—Martin John, physician of Lau-

* He does mention Hunter's paper, and points out that his investigations were incomplete.

ban, Silesia, Prussia, in *Ein neu Bienen-Büchel* (Lauban and Zittau), points out that they are carried in the wax pockets of the bees.

1744.—The Rev. John Thorley, of Chipping Norton, Oxfordshire, mentions the same in *Melisseologia, or the Female Monarchy* (London).

1744.—Hermann Christian Hornbostel, Haupt-Pastor in Hamburg, describes the wax scales, and accurately suggests their origin, development, and use (*Hamburger vermischte Bibliothek*, Vol. 2, pp. 45-62).

1767.—Johann Urban, Hoch-Reichs-gräfl. Förster in Thräne, shows the wax scales in position at a meeting of the Oberlausitz Bienengesellschaft.

1771.—François X. Duchet, Chaplain of Remaufens, Canton of Fribourg, Switzerland, repeats with elaboration in his treatise, *Culture des Abeilles*, the substance of Hornbostel's article as an original discovery.

1792.—John Hunter, surgeon and anatomist, announces to the Royal Society, in his *Observations on Bees* ("Philos. Trans.," Vol. 82, pp. 128-95), that he has discovered the wax scales in position, and considers them to be an oily secretion.

1793.—François Huber, the Swiss naturalist, assisted by his son Pierre, discovers the wax scales, and demonstrates scientifically their origin, development, and use in comb-building (*Nouvelles Observations sur les Abeilles*, Vol. 2, Paris, 1814).

the wit of man to manipulate so that all will gather alike, even under very similar circumstances and apparent strength of numbers.

To secure the very best results the management should have begun about six months ago. "Spring" stimulation should have been attended to in autumn! At that period a great proportion of incoming honey or syrup given to the bees is turned into young, healthy workers, all life and energy, to prove later the most valuable asset in the apiary, because these are the bees whose active vitality assures safe wintering and safe "springing" as nothing else can. Their animal heat is unimpaired, their health is robust, and their powers of industry at their best, and hence they live to carry on the labours of the hive through the trying time of late spring and early summer. The colony strong in young bees when winter-packed is, other things being equal, the one most certain to be strong in spring, and, indeed, all the summer long.

Mere numbers alone, however, cannot assure us the best returns when clover fields are white or heather hills are purple, because several secondary dominating influences may intervene. The queen in early spring may be over-stimulated, and consequently her laying power may contract too early. The colony may attain the crest of the wave at too early a date, and with diminished numbers may have to face the full flow. The bees for some cause may determine to supersede their queen at an inauspicious period. Or the bees may take it into their heads to swarm, and thus break up the full force of workers simultaneously with the prime rush of nectar. Again, an undue number of the workers may be too young to act efficiently as foragers, they may be too old to do the best work, or they may have an extra proportion of brood to tend and care for when they should be out gathering. Certain strains are so excitable that they waste too much of their energy in agitation and needless worry, while it is an undoubted fact that other strains loaf about too much, or are too late in going actively to work, or they strike work too early in the day. Others expend a large amount of superfluous energy in building wasteful brace-combs, in daubing useless quantities of propolis where it is not required, or for unaccountable reasons rearing hosts of drones to the detriment of the colony and the waste of valuable nectar spent in rearing and feeding this unnecessary and redundant mass of males. Further, colonies which may appear strongest may not be so in reality, as excitement, with much flying to and fro, may often be mistaken for industry and steady, active work.

Correspondence.

The Editors do not hold themselves responsible for the opinions expressed by correspondents. No notice will be taken of anonymous communications, and correspondents are requested to write on one side of the paper only, and give their real names and addresses, not necessarily for publication, but as a guarantee of good faith. Illustrations should be drawn on separate pieces of paper. We do not undertake to return rejected communications.

*** In order to facilitate reference, Correspondents, when speaking of any letter or query previously inserted, will oblige by mentioning the number of the letter, as well as the page on which it appears.*

AMONG THE BEES.

THE STOCKS LIKELY TO YIELD PROFIT.

[7370.] The active bee-season of 1909 is about to dawn upon us, and it behoves every bee-keeper at an early date to take stock of his colonies, and diagnose which of them are likely to be valuable assets. In general, the observant bee-keeper may assign each of them, as examined, a position in one or other of three classes—first, second, or third. Hope buoys him up to think that in process of time all the three, under his fostering care, may be brought into line, and this, in general, he can secure under proper management. Yet, while the pursuit endures, it will pass

when results are a mere nothing. Such nervousness should be cured by depositing the queen, as the strain yields neither a strong force nor a rich return of surplus honey. In this, as in other lines, steady industry, quiet and unassuming, tells at the end of the season, and leaves bounce and show far behind.

Other weak points in a seemingly strong lot of bees may be noted. Certain strains cap badly. For comb honey these queens should be deposed, and the stock headed by a queen from a well-known mother whose progeny give prime results. Other lots cap thin, or hurry on the capping before the honey is fully ripe, yielding thin, watery, weeping comb honey. These should never be tolerated in any apiary. Some of the nervous strains, dreading perhaps that the inflow is ended, on the temporary cessation of the flow for a day or two, hurry up the completion of sections, and scamp their work by sealing before the comb touches the bottom of section. It may be scarcely necessary to repeat that colonies headed by old, failing queens—good, it may be, in spring and early summer—go under at too early a date and fail to pay well. New blood in the apiary tells, directly and indirectly. In-breeding produces a lassitude and want of energy in even fairly successful stocks; therefore a change of strain is required to rectify the wrong. Longevity and a strong constitution in the bees prove more efficient than extraordinary prolificness in the queen, and here I think is where our natives carry the palm "in this locality," because they unquestionably possess these traits in a marked degree when compared with the generality of foreign races.—D. M. M., Banff.

NOTES FROM NORTH HERTS.

[7371.] Referring to the question of zinc *v.* calico in B.B.J. of January 14 (page 15), I agree with Mr. Crawshaw as to the disadvantages of zinc for roof-covering, and although it may pass muster when fixed by a professional hive-maker, the efforts of amateurs who leave jagged edges, outstanding tacks, and sharp corners, which are apt to become decorated with "pieces" of the expert whose duty it is to manipulate roofs, are far from pleasant. Calico is much more satisfactory, and if thin paint is used instead of thin glue it is not necessary to wait before giving another coat of paint.

Non-swarming Bees.—The possibility of improving the honey-bee by judicious selection is well shown in the editorial on page 21 by the results obtained in Switzerland. The bees operated on appear to have been hybrids, as M. Kramer speaks of the elimination of the Italian

blood; but I have no doubt that the result would have been the same if no attempt to do so had been made. In selecting the non-swarmlers without reference to their colour, the climatic conditions would bring about a return to the colour most suited to the district. My view is that the dark colour of the bee, with its power of absorbing heat, is an advantage in cold and densely-wooded countries, whilst the light colour is an advantage in southern, open countries. In southern countries swarming is encouraged by Nature, but in the northern the inveterate swarmlers are killed off by the winter and spring. When we reclaim bees from a state of Nature, the altered factors in the bees' environment have an effect for good or ill, and co-operative selection will be certain to perpetuate those qualities that are desirable from the bee-keeper's standpoint, irrespective of the colour of the race. The introduction of Italian blood in Switzerland before selection commenced was probably advantageous in breaking up race stability, and thus giving variable material on which to work.—G. W. BULLAMORE, Expert B.B.K.A., Albury, Herts.

CRUELTY IN MISMANAGEMENT.

PLEA FOR THE SUPPRESSION OF FOUL BROOD.

[7372.] Much unnecessary cruelty is sometimes inflicted on the little insect which some of us have learned to regard as almost sacred by a section of those who aspire to the ranks of skilled bee-masters. A study of the history of this "oldest craft under the sun" leads to the conclusion that among the honoured names in the apicultural world the most successful are those who have taken to the craft purely for the love of living things in general and bees in particular. A strong illustration of the truth of this fact is to be found in a narrative by the veteran A. I. Root of his first meeting with Dr. C. C. Miller. He graphically describes the incident, and how the Doctor declared his intention to give up a large salary in order to live the simple life among the bees. It may be said that in order to attain success in any line of business one must love it, which is no doubt true to a certain extent; while those who take up bee-keeping solely as a business may be said to love the calling just in proportion to the profit it brings. It is among this class of bee-keepers in this country that most of the cruelty to bees is perpetrated. Without intending to be deliberately cruel, with them "honey is money" and the bees mere honey-making machines. Fifty per cent. of such bee-keepers are absolute failures. Of the other half, some in mechanical fashion treat their bees

well, but the majority carry on a system of cruelty varying in degree according to individual temperament or the vagaries of climate. I need not enumerate the known phases of cruelty beyond such as maiming and killing bees during hasty and ill-timed manipulations, allowing whole colonies to die of hunger, or the wanton slaughter of the sulphur-pit. Bee-keeping of this order never gets beyond the menial drudgery necessary to obtain a certain amount of money-value from the labours of the bee. The crushing of pulp of a little body may be a trifling thing to some, and the operator may tell us that bees were created for the use of man, who has no time to waste in trying to avert so trifling a mishap. This may be, but I ask: Did the Creator make the bees simply for the use of man alone? Are their life and work not a page in that Book that he who runs may read with profit to himself, and thus be led to study and love the tiny bee that is so helpful to man, while learning to love still more the Creator of all things great and small?

While on this subject I wish to enter a protest against the cruelty of neglecting bees suffering from foul brood, or causing the spread of this scourge among our apiaries. In a village I know well foul brood was rampant a few years ago, but by united effort on the part of bee-keepers and the assistance of an expert, who rendered willing help, the dreaded pest was stamped out. Then a bee-keeper from a distance settled in the village, bringing with him some bees which a neighbour found to be diseased. He tried to persuade the owner to let him remove the diseased combs and give the bees clean hives and new foundation, in order to avoid spreading the disease among the hives in the village. But the warning was scoffed at, and the rotten, spore-laden combs were set out in the garden for the bees to get the honey, and so save the owner the trouble of feeding. When I say there were at least 100 colonies in the locality, fifty of them almost within a stone's throw, the effect of this man's action can be imagined. Needless to recall the loss and damage which followed, but I wish to point to the cruelty inflicted by it on the poor bees by such practices. It is much to be regretted that there is no law to suppress and punish such offences, and I trust that the time is not distant when we shall have an Act passed to protect bee-keepers against those who so far forget their duty towards their neighbours and knowingly inflict unnecessary suffering on their bees. I may be accused of making too much of this question of cruelty to the bees, but there is room, I hope, for some sentiment in the bee-man's life, and it makes for that happiness which I, too, "believe is only known to

true bee-keepers." I plead for "humanity to the industrious little labourer, the honey-bee." Increased care in this respect will always bring its reward in an increase of profit and, what is quite as valuable, increased pleasure in the pursuit of the craft. As a parting word on the question of a Foul Brood Bill, let me say I am not lightly advocating this. Compulsion is an ugly word. Persuasion is much to be preferred, but we always have had, and always will have, those whom no amount of reasoning will move. They exist in every walk of life, they make our laws necessary, and they alone need fear them. Is it not time to ask all bee-keepers to show a more united front on this long-discussed problem? Surely the future benefit of bee-keeping is of infinitely more moment than some present temporary inconvenience, which may never after all exist in the working of a well-planned measure administered by capable hands.—G. W. AVERY, Heads Nook, January 16.

BEEES IN SUBURBAN GARDENS.

[7373.] The interesting inquiry of "C. W. W." on page 28 and your full reply on page 29 leave little to be said, but as one who for many years has successfully kept bees "within city walls" I will, with your permission, add a few rules. The experience of keeping bees amongst the chimney-pots has taught me several things which should be borne in mind by all who intend to start bee-keeping in suburban gardens, among which I will venture to name a few. First, I say, obtain a copy of the "Guide Book" and read it carefully. May I take this opportunity of saying what a help it is to us appliance dealers to have a standard work like the one named, to which we can refer all who have a thirst for knowledge; whilst to those who desire to go a step further "The Honey-bee" is grand, to learn which is indeed a liberal education in apiculture. Second, follow the most excellent advice you give in reply to "C. W. W." and have a bee-keeping friend to show how to carry out the various operations and to fully explain the reason why; having wisely decided on the "W. B. C." hive, how necessary it is to buy all additional hives same make and size; and to explain that shallow-frames for extracting are easier for a novice to obtain than finished sections, &c. Third, get a gentle strain of bees. This is very important, and then when neighbours make remarks about danger to children being stung, &c., speak gently to them. Personally, I make it a rule, when the honey harvest is on, to fill a few small jars (small empty stone jars which have contained cream are especially

suitable) and distribute them amongst the nearest neighbours and those whose gardens I have walked over in pursuit of swarms, and find it has a wonderfully soothing effect. Fourth, obtain the help of the womenfolk of your own home. A penny per pound profit on each jar of honey sold helps to hide from view the speck-stains on clothes hung out to dry, which in the somewhat limited garden may occur in the spring, and also helps to brighten the sight and hearing when swarming may take place, and to nerve them to shake a swarm into a skep and then leave them in a shady position until master (?) returns in the evening. Fifth, do not go "Volunteering" all through the month of August. The writer, like every true Englishman, would if necessary die in defence of his hearth and home; but as a believer in the "brotherhood of man" and that "reign of peace" which has yet to dawn, I would suggest apportioning a week for "training" and three weeks for the bees.

In conclusion, bee-keeping in towns is profitable, as from an apiary of six hives, kept within seven minutes' walk of the far-famed Nottingham Market Place, over 2 cwt. of honey has been taken in one season.

As it is the "stickers" who help forward our lovable craft, I always tell inquirers that in bee-keeping there is some amount of work, a large amount of waiting, a fair amount of energy and perseverance, together with intelligent observation, needed; but these combined with a favourable season, and results like the above-mentioned may easily be attained in the suburban gardens of our highly favoured land.—THOS. N. HARRISON, Yew Tree House, Carrington, Nottingham.

CAPPINGS OF COMB.

BY L. S. CRAWSHAW, NORTON, MALTON.

Lucubrations (No. 1385, page 3).—That is rather a long word for "Cappings"! But let us get to the root of the matter. *Lux*, light; *kubos*, a cube; *ratio*, reason—"a thing squared by the light of reason"! Thank you, "D. M. M." I had no idea you thought so highly of these "fruits of study." A suspicion of your sincerity is more than lulled by this, I must admit, somewhat hybrid derivation! Now, as to your own reasoning, I did attempt to follow your mathematical figure through the fog, but it ran into so many places that it appeared only to disappear, apparently by skipping a step or two in its progression, and we were divided in a moment. But I think that I criticised fairly in No. 1371, for it seems to me that average and common figures should be taken. Thus, in theory

at least, driven lots and swarms should be subject to the same carriage charges to make fair comparison. Quite apart from this, the mistake which you, sir, and some other recent correspondents appear to me to make is in the regarding of the "season" for driven bees as synchronous with the calendar year of purchase. Surely their season is, speaking generally, the following year, and driven bees are, after all, only a swarm bought very early. But in that earliness lies their value, for by the time the "swarm in June" comes to hand the driven lot should be an established stock, ready to throw a swarm of its own. Please smoke that in your pipe "Among the Bees," "D. M. M.," and let us know if the interest upon the outlay is not good, even though the initial cost were equal, which I do not admit.

Queen-introduction (page 3).—Your point is a fair one, "D. M. M." I had overlooked the fact that your "night in June" is lighter than ours. But is not that the greater reason for care? After all, the instruction as to "dusk" would be written with a Southern understanding of the word. Here I am quite willing to leave you in the hands of Mr. Simmins, who comes to the rescue on the same page, possibly without special regard to your Northern Light. I would, however, say that I have been in higher latitudes than your own, where even at midsummer it would be possible to designate the light "dusk." But I again fail to follow you, or rather to see the difference between us, "D. M. M." when you question whether the queen would have behaved as she did had she been inserted in the "dark," or—shall we say?—sufficient dusk. Surely we agree that she would *not* have behaved the same—that is, she would not have flown—which was just the point I tried to make.

Bees as Creators (page 3).—Very literally, perhaps, bees do not create, but I prefer to think it pedantry to insist upon this when faced by their wonderful architecture, the very building materials of which are of their own secretion. Secret chambers these, surely! After all, what do we know of creation, or of the elements of which Nothing consists? Even to-day, when we harness the primeval forces and wonderingly gauge the relations of electrons in the atoms, mysteries are solved in a word, although it may be that our easily-uttered title of Creator belittles the Great Fashioner of things as we see them.

Trifles (page 3).—I fear you miss the point, "D. M. M." This was intended as a gently ironical reference to Dr. Kueck's theories, to which, you force me to confess, I do not yet adhere! *Another trifle*: Yes; I did suppose the lids to be on the jars. Were they not?

Even if hided without wads, I should not expect "show honey" to escape! *Yct another*: I don't understand. Be charitable! Do you mean that you have a lot of casks, and the public tasted another before it burst? But you are wrong about our eggs. We put them all in one basket this time of year, more's the pity! There, "D. M. M.," I have given you the cream of my trifles; will you help yourself to the sound Marsala below?

A Swell Affair (page 3).—This must really be the last, "D. M. M." I will admit that there is no point, or at least it is without parts or magnitude. I thought there was one before I tried to drive it home, and blunted it. I must try the claymore next time. But you are right, for I have consulted the best authorities, and I am assured that it is physiologically impossible for the sting to become buried in the swelling process. Now, had I ever been stung, I should have known a little thing like that!

A "Rod" of Turf (page 7).—I cannot but think that this should read "sod," for a rod of turf, however "well cut," is rather a lot for the capping of one skep, as the miscreant who thus summarily enlarges borders would find, could Mr. Avery have the practical instruction of him in how many rods go to the making of an acher!

Warmed Water (page 11).—The drinking-fountain should, of course, always be placed in a sunny, sheltered spot, and it has previously been conjectured that bees visit the manure-heap in early spring for the sake of the warmer fluid. These experiments would seem to prove it, although, to be quite conclusive, the manurial liquid should also have been supplied warm. I see no reason to doubt, however, for if the liquid were essential to brood-rearing it would be sought all the year round. I would therefore suggest that the hot-bed be made of annual use. Dig a pit, fill in with litter, and embed the drinking-pan in the top of the heap, and thus automatically provide the bees with warm water. The spring midden may thus prove of value not only up to and in mid-spring, when bees begin to neglect the spring of the midden.

Queries and Replies.

[3877.] *Queen-rearing*.—I am delighted with "Nemo's" account of M. Adrien Getaz's plan for rearing queens. It is just what I want. I have a good stock that did well last year, and I purpose using the eggs in a somewhat weaker hive. 1. Please say if a quadrangular hole below

the selected eggs of 1 in. from top to bottom by $\frac{3}{4}$ in. across would be about the best size? And would it be well to fill it up, by and by, with a bit of worker-foundation, or would you let the bees build drone-comb there? 2. What are the best seeds to sow on railway cuttings, without getting special permission? A few gorse or whin seeds dropped here and there, or broom, would readily grow, I suppose. They would be beautiful to look at and useful for bees, and I presume one could easily get permission, if that were better. But far, far more might be made of our railway cuttings. 3. When using "Divisible" brood-chambers, how would it do to use two $5\frac{3}{4}$ -in. (instead of 6-in.) supers for the brood-chamber, placed on a 2-in. eke? This would enable us to work with our common $5\frac{1}{2}$ -in. shallow-frames and our existing hives. I hope to try this in the coming season.—JOHN W. MOIR, Edinburgh.

REPLY.—1. The proposed size will do. You need not trouble about how the "hole" is filled up. 2. There is nothing better than white-clover seed, if the aim is to utilise vacant railway embankments. Gorse or whin, we fear, would not be allowed. 3. The size of chamber used in "Divisible" hives is simply one of choice, but most bee-keepers who try the plan as an experiment would no doubt utilise the appliances they already possess.

[3878.] *Keeping Bees on Allotments*.—Being a novice and wishing to start bee-keeping, I should like your advice on the following points:—Having an allotment on the outskirts of the town, with nothing beyond but fields, &c., I thought of starting one or two hives. Not knowing anyone having any near, there would be the whole of the allotments—which are a few acres in extent—then the fields beyond. I should like to know the best book to get for the beginner and the best time to start, also if you think this is a good place for my experiment, or whether it is necessary to live in the country altogether to get anything like a result. I may say that I have read your journal, but feel that I want something more for a beginner. I shall still continue to take the B.B.J., as no doubt it will be useful at some future time. I should be away from them from 8 o'clock in the morning till 6.30 in the evening, except about half-hour midday. Would this make any difference with results? I could spend most week-ends there. I am sending full name and address, and hope you will use the *nom-de-plume*.—HOPEFUL, Leicester.

REPLY.—As a rule, we cannot say that an allotment garden is a good place for a beginner to start keeping bees in. There are too many allotment-holders crowded

in a small space, who are always digging and hoeing their plots, and who naturally object to anything that interferes with them when at work, as bees will occasionally do unless managed by an experienced bee-man. You had better inquire how the allotment-holders will regard your proposal before making a start, as it might be an endless source of trouble otherwise. The best book to have is the "Guide Book," and you will be better able to judge of the prospects of your start after reading it carefully.

[3879.] *Drone or Worker Cells for Supers?*—I am thinking of fitting up a dozen supers with foundation, and have heard that drone-foundation is preferable to brood for supers, as the drone-cells hold more honey and are much better for extracting. 1. Which do you recommend, please, and do you think it necessary to have shallow-frames wired? 2. When queen-cells are put in cages to hatch out, according to the directions in "Guide Book" I understand that after the queen has hatched out of her cell she can remain in the cage for any length of time—in fact, until she is required to re-queen a colony. If this is so, do the other bees feed her, or should she be supplied with food by the bee-keeper? Your reply will be appreciated by—S. W. LONG, Bristol.

REPLY.—It is largely a matter of choice, some bee-keepers preferring sections built on worker-cell foundation as being more attractive than when that with drone-cell base is used. For shallow-frame supers worked for extracted honey the drone-cell foundation is more largely used for obvious reasons, as larger cells hold more honey than small ones. 2. You have misread the directions in "Guide Book." The resultant queen must leave the hive for mating, or she is useless.

[3880.] *White Patches in Granulated Honey.*—I have now sold nearly half a ton of honey through an advertisement in your valuable journals, and would much appreciate an expression of your opinion on the cause of the white crystals collecting on the sides of my jars, as shown in sample enclosed. My bees are on a farm surrounded each year by several hundred acres of white clover. Some people object to the colour of the sample, although I think the flavour is very good. Name sent for reference.—T. W., Colchester.

REPLY.—The white patch at one side of the jar in sample is probably the result of a minute air-globule being formed while filling the jar when the honey was in liquid condition, and failing to rise to the surface. To remedy this the stream of liquid honey should fall into the centre, so that it will spread out to the glass equally on all sides, and allow no air-globules to form at the sides. It is no

real defect in granulated honey, though an eyesore to the purchaser. The flavour of your sample is good, and its deep golden colour is almost no detriment.

Notices to Correspondents.

Letters or queries asking for addresses of manufacturers or correspondents, or where appliances can be purchased, or replies giving such information, can only be inserted as advertisements. The space devoted to letters, queries, and replies is meant for the general good of bee-keepers, and not for advertisements. We wish our correspondents to bear in mind that, as it is necessary for us to go to press in advance of the date of issue, queries cannot always be replied to in the issue immediately following the receipt of their communications.

A. A. H. (Hants).—*Bees and Bee-keeping in India.*—We are making inquiries on the subject you mention, and hope to give the needful particulars in our next issue.

LEX WREX (Wrexham).—*Honey Lost in Transit.*—We have never before heard of the whole contents of a 14-lb. tin of honey being lost in transit and only the empty tin being delivered to buyer by the railway company. As the honey was sent at "owner's risk" rate, the point seems to be which of the two railway companies who handled the tin is liable, seeing that one or the other would never—as carriers—accept an empty tin. If the seller repudiates liability, it appears clearly a case for a county court judge to decide.

F. N. (Littlehampton).—*Joining the B.B.K.A.*—If you send particulars—as per your business letterhead received—to Mr. E. H. Young, Secretary B.B.K.A., 12, Hanover Square, London, your name will be submitted for membership at the next meeting, to be held on the 18th inst.

F. SITWELL (Northumberland).—*Drones in January.*—The fact of live drones being seen in hives in January is strong presumptive evidence of queenlessness, but a single dead drone cast out at this season may possibly be an odd one found by the scavenger bees in some corner of the hive, where it has sought refuge at the ordinary "drone-killing" time. We have known an instance of this having occurred.

Honey Sample.

R. E. (Amlwch, N. Wales).—The objectionable odour and flavour of sample probably come from the weed commonly known as "wild parsley," which is sometimes freely visited by bees.

. *Several important letters, &c., are in type, but held over from pressure on our space.*

Editorial, Notices, &c.

RESPECTING PARTHENOGENESIS.

Some time ago Mr. Crawshaw asked our esteemed correspondent Dr. Kuckuck certain questions respecting parthenogenesis; we therefore deem it only right to allow the Doctor to answer them on page 54 of this issue, but we must at the outset admit our inability to view the question in the same light as he does, nor do we see that the arguments brought forward by Dr. Kuckuck show that parthenogenesis in bees is a myth. Our Russian friend bases his arguments on a certain theory, and, though a scientist, it is evident that he is not a practical bee-keeper. Many of his statements are directly opposed to our own observations, extending over more than forty years, combined with practical microscopical work during that time. Bearing all this in mind, it will be our endeavour to

numerous as those that are pure, it follows that the impure dominants by inbreeding produce as offspring pure dominants, impure dominants, and recessives in the proportion of 1:2:1, and this holds good in all impure dominants, no matter in what generation they are bred. Not only so, but it explains the reason why in the second and subsequent generations black drones are found. The same phenomenon would occur if black were the dominant characteristic, but in a reversed ratio. There may also be present or absent in one or the other factors which have an important action in producing variation or reversion. It is quite consistent with the fact that drone-eggs are not fertilised at all, and that in consequence drones have a grandfather but no father. In other words, they inherit through their mother the characteristics of their male grandparent. Dr. Kuckuck, in his arguments, entirely ignores the impure dominants which have so important a bearing on the progeny,

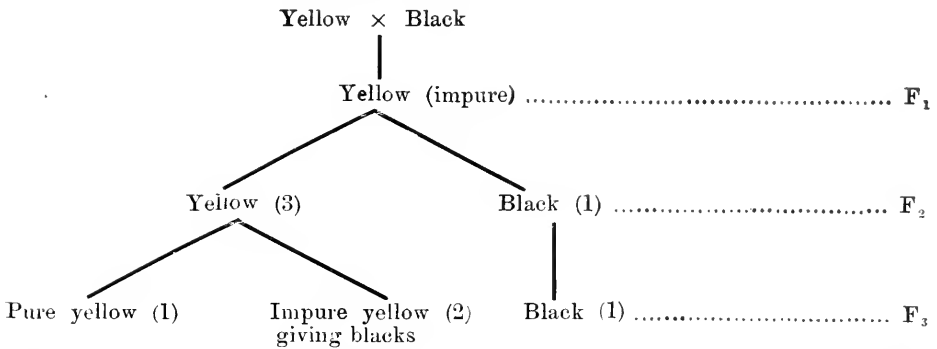

criticise his answers in as few words as possible:—

1. That black drones appear in a certain number of cases is not astonishing, and need not necessarily be attributed to the fertilisation of the male egg. A pure yellow queen mated with a black drone will produce pure yellow drones. But the female offspring of this queen—which would, of course, be impure—will produce a certain number of both yellow and black bees, the drones inheriting the black blood from their grandfather. Now, according to the Mendelian law, supposing that we take the yellow as being the dominant characteristic, the dominants which come in the F_2 (= 2nd filial) generation are of two kinds—pure and impure. In this case black would be *recessive*, and Mendel has shown that pure dominants and recessives always breed true. On the other hand, impure dominants always give dominants and recessives in the proportion of 3 to 1. The above diagram will explain more clearly the results of crossing.

As the impure dominants are twice as

so that his deductions are not convincing. Nor does he mention the fact that, although Siebold found spermatozoa in female eggs, he never in a single instance discovered them in drone-eggs, which statement we have personally been able to verify with the microscope. A. Petrunkevitch also, with the aid of more recent improvements in instruments and perfected methods, has been enabled to confirm Siebold's researches, for he never found spermatozoa in drone-eggs, laid either by queens or workers, whereas they were found in female eggs, and in some cases as many as seven in a single egg had penetrated the micropyle. ("Die Richtungskörper und ihr Schicksal im befruchteten und unbefruchteten Bienenerei," Zool. Jahrb., band 14, 1901, p. 578.)

2. The supposition that worker-bees are incapable of being fertilised was first advanced by Dzierzon in his "Theorie und Praxis des neuen Bienenfreundes," 1849, p. 106. Siebold had already in 1843 ("Zeitschrift für die Entomol.," bd. IV., p. 375) corroborated Mademoiselle

Jurine's anatomical discovery that worker-bees were females with aborted sexual organs. By careful dissection the imperfectly-developed ovarian tubes may be seen in all workers, connected with an undeveloped oviduct. Siebold says: "The external sexual organs, as well as the seminal receptacle, remain abortive in these egg-laying workers, for which reason they are not in a condition to copulate and receive the fertilising semen." ("True Parthenogenesis in Moths and Bees," 1858, p. 59.) It is, however, quite true that Herr Kremer found an instance of a worker which had paired with a drone, and a translation of his letter appeared in the B.B.J. for 1883, p. 213, under the title "Incredible, and yet True." But it does not follow that the worker in question was fecundated because of this mating. Indeed, from the anatomical structure of the organs we know it would be impossible. It therefore becomes clear that this is an abnormal case, attributable probably to an act of violence on the part of an ardent drone. Observant bee-keepers will have constantly noticed that, when excited, drones will eagerly follow worker-bees, or even each other, but no bee-keeper has ever found workers so pursued returning to the hive with the signs of impregnation attached to their bodies, though frequent opportunities occur of seeing that young queens do. It is strange that Dr. Kuckuck should base his theory upon this single abnormal case, seeing that the instance he mentions, which occurred six months later, was not a case of pairing at all, but clearly an act of violence, as shown by the drone-organ not being in the vagina at all. Dr. Krancher, to whom reference is made, alludes to the Kremer case first mentioned; and at the page named, in describing the ovaries of a worker and stating that fecundation was impossible, he says: "Of course, the fact that a worker has recently been found paired with a drone is interesting and wonderful, but it is an exception to our perfectly correct rule, and only tends to confirm the same still more strongly." ("Die dreierlei Bienenweisen," 1884, p. 22.)

So far, then, Dzierzon's prophecy has not been disproved, for during the number of years over which our personal observations extend we have never met with a fecundated worker, notwithstanding the fact of our having examined the ovaries of many fertile workers captured in the act of laying. With Cyprian bees this was an easy task, for large numbers of fertile workers appeared immediately a queen was lost, even at times when there were no drones. Certainly their ovaries were never perfectly developed, nor did

they ever contain any trace of spermatozoa. This fact is too well established to be shaken by such an abnormal case as the one mentioned above. It frequently happens that a large number of Cyprian workers become fertile, so that if they all depended on pairing, the colony would be in a constant state of excitement; but, on the contrary, we have always found that such colonies are not more excited than others. Indeed, it is only by careful watching that fertile workers may be observed being tended and fed by other bees, and by seeing them lay, that one can recognise them. Vogel also recognised the fact that the ovaries of workers were undeveloped, and that they were incapable of fecundation. ("Die Honigbiene," 1880, p. 38.)

Dr. Kuckuck says: "For the storage of spermatozoa a spermatheca is not necessary," giving as a reason for his statement the fact of vertebrates not having one. The comparison, however, is, to our mind, not fair, and should only have been made with other insects which possess a spermatheca. According to Dr. K. Eiseherich, ants have a spermatheca, which is only once filled with spermatozoa in the life of the insect, which lasts between nine and ten years, during which time they remain alive and active. ("Die Ameise," 1906, p. 30.) There is no proof that queens are fecundated repeatedly in the same season; therefore statements made to the contrary, in face of well-established facts, have little value. That Leuckart ("Zur Kenntniss der Generationswechsel und die Parthenogenesis bei den Insecten," 1858) found three mated young queens with spermatozoa in the oviducts instead of in the spermatheca is not astonishing, because we know that at first they are driven into the oviducts, and only when the pressure on the vagina is released does the contraction of the muscles of the oviducts drive the sperm into the receptacle, not casually "by rapid movements," as Dr. Kuckuck wishes us to believe, but certainly. Leuckart and others also found here a muscular mechanism used for this purpose. (F. R. Cheshire, "The Apparatus for Differentiating the Sexes in Bees and Wasps," Jour. Royal Micros. Soc., Ser. II., Vol. V., 1885.—Dr. von Butteler-Reepen, *Bienenwirtschaftliches Centralblatt*, Nos. 19 and 21, 1905.) E. Bresslau has more lately also described this apparatus, thus corroborating previous researches. ("Der Samenblasengang der Bienenkönigin," *Zool. Anzeig.*, 29, 1905, pp. 299-323.) By referring to "The Honey-bee" (T. W. Cowan, 1904, pp. 139-140) a better understanding of this will be obtained, as it would occupy too much space here to give a full description. But

that the spermatozoa do find their way into the spermatheca we have had ample means of verifying, so that the secretory fluid in this is no obstacle, as Dr. Kuckuck assumes.

3. It cannot be doubted that stimulating food furnished by workers increases the vital power of the queen, but it is this vitality that nourishes the spermatozoa during her life, for there must be constant nutrition and oxidation in order to sustain to the last the freshness possessed when first introduced into the spermatheca. We know that spermatozoa obtained from a dead queen are no longer active, whereas in an old queen even the few remaining are still alive when the receptacle is nearly empty.

4. So far as we know, Berlepsch ("Die Biene," 1873, p. 62, *Bienenzeitung*, 1856, p. 220) had never seen a queen mated later than thirty-six days from birth, and Dzierzon (*Bienenzeitung*, 1859, p. 274) mentions five weeks, but does not say if the queen proved fertile after that time. Berlepsch alludes to the only case known of a queen mating at forty-six days, related by Otto Hemmann (*Bienenzeitung*, 1861, p. 146). It is unfortunate that Dr. Kuckuck should again select an isolated and exceptional case like this in support of his theory. Observant bee-keepers know that, as a rule, queens unmated when four to five weeks old are, for certain anatomical reasons, incapable of becoming fertilised, and are no longer attractive to the drone. A young queen shows no desire to leave the hive during the first five or six days of her life, although there may be plenty of drones about. Also when the weather is unfavourable she stays quietly at home, and is not noticed by the drones. But after this time, if drones are on the wing and the queen is prevented from leaving the hive, she becomes much agitated, and continues to endeavour to get out until the drones are all at home again. There is no doubt a period when the queen becomes decreasingly attractive to the drone, and, as with other animals, so with bees, this period may vary. We have incontrovertible evidence that a virgin queen will lay eggs, and that drones only are the result. Dr. Kuckuck's deductions are so contrary to experience that we cannot accept his theory that "every egg-laying female, whether queen or fertile worker, is infallibly mated."

5. There is no doubt that the feeding of the queen stimulates her egg-producing powers, but as a virgin she is capable of laying eggs without this stimulation which produce only drones, and in this respect she is similar to a fertile worker.

(Concluded next week.)

DERBYSHIRE BEE-KEEPERS' ASSOCIATION.

ANNUAL MEETING.

The twenty-eighth annual general meeting of the Derbyshire Bee-keepers' Association was held on Saturday, January 30, at 2.30 p.m., at Smith's Café, Derby, among those present being Mr. R. Giles (chairman), Mr. Pallett (vice-chairman), the Hon. F. Strutt, J.P. (hon. treasurer), Mr. R. H. Coltman (secretary), Miss F. Leicester, Miss M. A. Coltman, Mrs. Sowter, Mrs. Bakewell, Mrs. North, Mrs. Pearman, Messrs. J. Stone, D. Wilson, D. Wilson, jun., P. W. Lewis, J. Pearman, B. Abell, G. Walden, R. Calderbank, W. Allen, J. Rowland, R. North, S. Durose, A. J. Mountser, J. Sowter, J. Bakewell, C. Clarke, W. Henson, J. T. Wood, G. Straw, G. L. Bakewell, A. H. Hanson, T. Harrison, and J. Winson. Mr. Geo. Hayes, hon. secretary Notts Bee-keepers' Association, was also present.

The Chairman said he rose with great regret to have to again announce the death of one of their old friends and one of their foremost and most useful members. He referred to the late Mr. Powlson, who for many years had served on the committee, and had been one of their hon. auditors. He moved that an expression of their deep sympathy be forwarded to Mrs. Powlson. Mr. Pearman, in seconding the resolution, said that he regretted the death of their old friend. He was sure that no one who came in contact with their late friend could do otherwise than respect his straightforward and just character. The resolution was then put and carried.

The minutes of the last annual meeting having been read and confirmed, the Secretary presented his annual report and statement of accounts, which showed a credit balance of £3 4s. 6d. on the year's work.

The Chairman, in moving the adoption of the report and statement of accounts, said he was pleased to see the healthy state of their balance-sheet.

The Secretary gave the result of the experts' spring tours, which showed that bee-keepers owning fifty-five skeps and 940 bar-frame hives had been visited.

The experts reported a very indifferent honey season generally, though in some cases members had had very good "takes." Generally speaking, however, the average was 10 lb. to 20 lb. per hive.

Proposed by Mr. Giles, seconded by Mr. Pallett, that a vote of thanks be accorded to the County Council for their grant of £50 towards the expenses of lectures, expert work, &c. The Duke of Devonshire was elected President on the proposal of Mr. Giles, seconded by Mr.

Durose. Vice-Presidents re-elected, with the addition of F. N. Smith, Esq., the Earl of Kerry, M.P., and Sir J. B. Dale. Mr. R. Giles and Mr. G. T. Pallett re-elected chairman and vice-chairman respectively. The committee re-elected *en bloc*, excepting Mr. Powlson (deceased). R. H. Ashton, Esq., and G. H. Strutt, Esq., re-elected C.C. representatives. The Hon. F. Strutt, J.P., re-elected hon. treasurer. Messrs. T. W. Jones and P. W. Lewis elected hon. auditors. Messrs. Pallett and Coltman re-elected delegates to the B.B.K.A. meetings. Messrs. North, Rowland, and Durose re-elected experts. Mr. R. H. Coltman re-elected lecturer and secretary.

A vote of thanks to the chairman terminated the afternoon meeting, and the members and some friends then partook of tea in an adjoining room, after which Mrs. Nanna Eke and Mr. Pearman, jun., contributed songs, and Mr. D. Wilson, sen., gave two recitations. In addition to the musical entertainment, a lecture was given by Mr. Geo. Hayes, hon. secretary Notts B.K.A., on the "Anatomy and Life-History of the Bee," illustrated by a fine set of lantern-slides, which was greatly appreciated, a hearty vote of thanks being accorded to Mr. Hayes for his services.—R. H. COLTMAN, Secretary.

Correspondence.

The Editors do not hold themselves responsible for the opinions expressed by correspondents. No notice will be taken of anonymous communications, and correspondents are requested to write on one side of the paper only, and give their real names and addresses, not necessarily for publication, but as a guarantee of good faith. Illustrations should be drawn on separate pieces of paper. We do not undertake to return rejected communications.

RESPECTING PARTHENOGENESIS.

[7374.] While sincerely thanking your correspondent Mr. L. S. Crawshaw for the interest he has taken in my work, I have much pleasure in replying to the questions he puts with regard to parthenogenesis on page 396 of your issue for October 1, 1908.

1. Mr. Sladen writes me on October 17, 1908, as follows:—"The golden bees are derived from hybridisation with dark stock"; that is to say, according to the Mendelian law, in the golden hybrid queens and in their eggs yellow characters are dominant, the dark ones latent. If the drones came from unfertilised eggs they ought to have the yellow characters dominant and the dark ones latent, as do the unfertilised eggs of their mother the hybrid golden queen; consequently, these drones should be—like their mother

—golden-coloured hybrids, and not dark, as they were in the six cases quoted by "Humble Bee." (See B.B.J., April 23, 1908, page 164.) Such yellow hybrid females, according to the Mendelian law (Rules I. and III.), can only produce dark offspring when the latent dark characters in the eggs become dominant after having been increased in number and in energy by dominant dark characters of the fertilising spermatozoa of a dark (or dark hybrid) male bee. Thus the dark characters of the latent female and dominant male prevail over the single female dominant yellow characters in the fertilised egg, producing therefore dark progeny. According to the Mendelian law, the dark drones referred to in the B.B.J. of 1908 (page 164), produced by six golden hybrid queens, show that the drone-eggs of the golden queens mentioned were fertilised by spermatozoa containing dominant dark characters, which, by still further increasing the eggs' latent dark characters, made them dominant, resulting in dark young drones. These six cases of golden hybrid queens producing dark drones, according to the Mendelian law, incontestably prove that drones can be produced from fertilised eggs only. Professor Corren's experiments on plants ("Geschlechtsvererbung," 1907, Nov., Leipzig) have confirmed the results of my experimental studies on animals (published in 1905 in "Comptes-Rendus de la Société de Biologie," page 415, "Sur le déterminisme du sexe"), that sex is transmitted always and only by inheritance. The drone, therefore, can only inherit his sex from a male, and this fact alone is an infallible proof of his descent from the male bee by which the drone's mother was fertilised.

2. In 1899 Dr. A. Petrunkevitch expressed the opinion that workers are incapable of being mated; but his view has never yet been tested and proved by practical experiment, but is simply accepted without inquiry by everyone. ("Zoolog. Jahrbücher," Band 14, Heft 4, Anmerkung 2, page 576.) This supposition was first advanced in 1854 by Siebold, who ignored the manner of copulation of insects, and had never seen worker-bees in the act of mating with drones. Nor did Siebold ever make any attempt to prove his supposition practically, and so zoologists simply took for granted the accuracy of this *verbum magistri* (mere word of the authority) till 1883, when Herr Kremer published in *Bienenzeitung*, No. 19, p. 229, the first case of a worker-bee which he found in union with a drone. (Kremer, "New Discovery Concerning Bee-theory—Incredible, yet True": "Neue Entdeckung in betreff der Bienen-theorie—unglaublich und doch wahr.") Paul Schönfeld, the well-known German bee-keeper, scientist, and

author, then made a thorough anatomical examination of this case of mating between a worker and drone, and published his observations in 1884 in *Bienenzeitung*, No. 1, p. 4, under the title "Can Worker-bees be Mated?" ("Sind Arbeitsbienen begattungsfähig?"), answering this question affirmatively. Dzierzon, whose hypothesis of fatherless sons, named by Siebold "Parthenogenesis," or virginal procreation, was annulled by the fact of workers mating, declared that this was a unique event, and not likely to occur again. (*Bienenzeitung*, 1884, No. 1, pp. 4-6, Dzierzon: "Vermag die jüngst beobachtete Verhängung einer Arbeitsbiene mit einer Drohne meine Theorie zu erschüttern?") But six months later Schönfeld examined another and similar case, and published his new observation, entitled "A Second Couple" ("Ein zweites Pärchen," *Bienenzeitung*, 1884, No. 14). By this second instance of worker-mating Dzierzon's prophecy was proved to be wrong, and Dzierzon was reduced to silence. Since that time worker-mating has been frequently observed (Dr. O. Krancher, "Die dreierlei Bienenwesen," 1884, p. 22, Leipzig; F. Pérez, "Sur la prétendue Parthénogénèse chez les Halictes," Bordeaux, 1895; B.B.J., 1907, p. 197. "drones excitedly disputing on an embarrassed worker-bee"), but the majority of bee-keepers were either unaware of it or ignored it. The original supposition of Siebold is therefore still repeated. The illustrious German bee-keeper and author F. W. Vogel says: "Respecting sexual organs, there is no distinct difference between a queen-bee and a worker. In Egyptian bee-colonies I have seen workers having perfectly developed sexual organs." (A. von Rauschenfels, "Atlas für Bienenzucht," Berlin, 1901, Tafel XXIII.) Workers are sometimes even as large as queens, so that such oversized workers might easily deceive an inexperienced eye. (B.B.J., 1908, p. 329. "L. M., Halesowen.") Workers, therefore, as well as queens mate with drones, and in the worker's sexual organs there is no obstacle to copulation, as is practically shown by the above-mentioned cases observed by Kremer, Schönfeld, and others. For storage of spermatozoa a "spermatheca" is not necessary. The vertebrates, having no "spermatheca," keep sperm active in their oviducts for several weeks, and even for six months (in the female bat). (O. Hertwig, "Lehrbuch der Entwicklungslehre der Wirbeltiere," 1902, p. 208.) In the bee there is no necessity for storing sperm, because female bees are fecundated not once for all their life, as was believed, but repeatedly in the same season, as François Huber ("Nouvelles observations sur les Abeilles,"

1814), Dzierzon ("Theorie und Praxis," 1849, p. 106, and *Bienenzeitung*, 1853, p. 41, and l.c., 1861, p. 14), and other bee-keepers have said. (*Leipziger Bienenzeitung*, 1904, p. 107; l.c., 1905, No. 12, p. 178; *Bienenwirtschaftliches Centralblatt*, 1907, pp. 133 and 195.) Professor R. Leuckart found in three young mated queens no sperm at all in the secretory gland, or so-called "spermatheca," but only in the oviducts—a proof that the so-called "spermatheca" is not a sperm magazine, but that spermatozoa, by their rapid movements, little by little often penetrate this gland. This secretory gland could only be reckoned to be a sperm-reservoir if the sperm were discharged by the drone directly into it and not exclusively into the oviducts. The drone is quite unable to discharge sperm into that gland ("spermatheca") situated far from the oviducts, because there is no space for the sperm in this gland, filled as it is with secretory fluid.

3. The digested and stimulating food furnished by workers increases the vital power of the fertile female bee and of her eggs in the ovary, being in direct connection with her nervous system, but the spermatozoa not in nervous connection with the fecundated female, and only vegetating in her, keep their vital power obtained in their producer, the drone. For instance, in a fertile female bee not fed by workers eggs mature no longer, and the female ceases egg-laying, but the spermatozoa in her oviducts do not alter or perish, because this female, after having been fed again by workers, produces normal brood (both male and female). (B.B.J., 1907, p. 342:—"After a few hours, as the queen no longer receives the digested and stimulating food produced by the workers, she becomes very small, and after twenty-four hours is no larger than a virgin queen, and is incapable of recommencing egg-laying until she has passed some days in a colony.")

4. Berlepsch and Dzierzon have had queens seven weeks old mated: a proof that a three or four weeks old queen ("drone-breeder") is still attractive to the drone, and should, if she were indeed a virgin, after having been mated, produce normal worker-brood: but she never does, because she is already mated, and a subsequent mating cannot alter the sex of the brood of this weak female. *Every egg-laying female, whether queen or fertile worker, is infallibly mated*, because an unmated female is never fed by workers, and without this digested and stimulating food she is incapable of laying eggs, as instanced by the queen isolated in a queen-cage ceasing egg-laying and only recommencing when liberated, and has passed some days in the colony, where she

is again fed by workers. (B.B.J., 1907, p. 342. and *Leipziger Bienenzeitung*, 1904, p. 68.) Consequently, there is no virgin egg-layer in a bee-colony.

5. A queen is incapable of laying eggs immediately upon emerging from her cell, because, whilst a virgin, she is not fed by workers, and without the stimulating food furnished by them, even if mated, no female bee is capable of egg-laying, as shown above (Item 4). Consequently, *the unmated queen defers egg-laying because whilst a virgin she is not fed by workers*, and even if mated she will not begin ovipositing if unfed by the workers, when isolated in a queen-cage.—DR. MARTIN KUCKUCK, Bordighera, Italy.

(Concluded next week.)

NOTES BY THE WAY.

[7375.] Now that we are well into February we must begin to plan out our bee-work for the coming spring. In the first place, with regard to hives, those already on hand, whether old or new, should be prepared for use by being painted with three coats of good oil-paint. See that the wood dummies fit well, and if too loose take a strip of felt on the ends. In dealing with old hives, see that every crevice is properly cleared of propolis and dirt, then scrub every part thoroughly with hot water and a good soap, such as "Lifebuoy," or "Izal." When the hive is dry, paint the inside with a strong mixture of "Izal" and water, working it well into the corners, after which the outside should be painted as described above. These hive-cleanings should on no account be neglected, even when there is no foul brood in the neighbourhood, as prevention is better than cure. It is best to burn old frames as useless, or if required for use again they must first be boiled in strong soda and water in the washing copper and dried in the open air, and as most of the frames now in use take apart easily they can be boiled without much difficulty. All old quilts should be burnt without question. As an antiseptic, I prefer "Izal" to carbolic acid for use among the bees; the odour is not so obnoxious to them and it is not poisonous.

Vitality in Bees.—Vitality in bees is remarkable. Several years ago some bees of mine were chilled by a sharp shower and partially drowned at the drinking-place; a severe frost followed, and next morning found the bees encased in ice. I took the piece of ice off the tin containing water and tea-leaves, placed it on a piece of flannel, and laid it in front of the kitchen fire. A few minutes later there were signs of returning animation, and a bell-glass was placed over the reviving bees to prevent them from flying to the window. Most of these bees even-

tually recovered, and flew home as though nothing had happened.

American Methods.—Our American friends hope either to rear bees with longer tongues or grow red clover with shorter honey-tubes, but when the desired end is reached I do not think we shall improve our output in quality if the honey gathered by humble-bees is a fair sample of red clover honey. In my youthful days I rifled many nests of humble-bees, and the honey was always very strong in flavour. Another thing which our go-ahead friends are seeing through is the small-frame nucleus-hive. Taking the season through and in all its bearings, they are coming to the conclusion that ordinary-sized frames are the best for queen-rearing.

Provide water for your bees in some warm corner of your garden conveniently near your hives. "How to keep a supply of warm water and a warm foothold," vide "Cappings," page 49.—W. WOODLEY, Beedon, Newbury.

MODERN HIVE-CONSTRUCTION.

SOME PRACTICAL HINTS THEREON.

[7376.] In offering the following hints on modern hive-making for the consideration of your readers, my chief aim is to place the business on a surer and more practical basis than has hitherto prevailed. Hive-making, in common with all other crafts, has advanced by successive cumulative improvements due to many experimenters. If, therefore, one would construct a modern frame-hive which shall embody not only the best-known practical features as regards manipulative facility and the well-being of the bees, but also those which relate more particularly to the technical workmanship of the hive, he must previously have made a thorough study of the whole business. Imitating the bees, then, let us build on a "good foundation." Obviously, the first thing to be considered—after deciding on the type of hive to be made—is the kind of wood to be used in making. Several kinds of wood have at various times been recommended by correspondents in the B.B.J., notably yellow pine, yellow deal, and American white-wood; and the prospective hive-maker will not go far wrong if he uses either of the two first-named. American white-wood, on the contrary, is liable to shrink, swell, crack, and warp more than the others, and, consequently, must, in my opinion, be condemned for the purpose we have in view.

Yellow pine (*Pinus strobus*) is a soft, comparatively non-resinous wood, showing a silky lustre under a sharp tool; it is easily worked, but has hard, dark-coloured

knots of generally circular outline, which are sometimes quite loose and liable to drop out. It is very suitable for hive-making, and is the one chiefly used by professional hive-makers. Yellow deal (*Pinus sylvestris*) is a somewhat harder and more resinous timber than the first-named, with a rather pronounced "grain." When of good quality, it is not greatly inferior to yellow pine for hive-making. It will be seen from the above description that the two varieties named are distinct timbers (a fact well known to all wood-workers), and not, as has been stated by correspondents in the B.B.J., one and the same wood. Taking all things into consideration, I prefer yellow pine. Having decided on the kind of wood to be used, I may be allowed to examine critically a typical modern frame-hive—the "W. B. C." for instance—in order to become better acquainted with its essential features, and see what I recommend my readers to avoid and what to adopt in its general construction. Premising that this hive is, in its main principles, a modification of the "Cowan" hive, we will begin with the *Stand*. There is no better stand known to me than the four-legged or table stand of the "W. B. C." hive. The height usually adopted by hive-makers is 8 in. To my mind, however, 12 in. is preferable, as it not only keeps the floor and alighting-board farther from the damp ground in winter, but raises the body-box to a more convenient height for manipulation.

Floor-board.—This is usually made of $\frac{1}{2}$ -in. wood, with tongued and grooved joints, sunk entrance, and flush with the outside faces of the bearers (usually termed "runners," a most unsuitable name); but, by allowing the floor to project $\frac{1}{2}$ in. over the bearers on each side, the need for "hand-holes" in the latter is dispensed with, and the ends of floor-boards are less likely to be split in the nailing.

Body-box.—The size given for this is $16\frac{3}{4}$ in. in width and $17\frac{1}{16}$ in. from front to back, both *outside* measurements. Now, the latter measurement is obviously incorrect; it is, in fact, the *inside*, not the *outside*, size at top. The top-bar of the "Association" frame is generally cut 17 in. "bare," therefore $17\frac{1}{16}$ in. bare is right for the *internal* measurement between the "end-closing" strips, which, by confining the "end-shake" of the top-bars, regulate the distance of frame-ends from sides of hive. The *outside* measurement at top depends on the thickness of these "end-closing" strips; $\frac{1}{4}$ in. is a suitable size, and this makes the *outside* dimension of body-box, lengthwise of frames, $17\frac{1}{2}$ in. full. Now as regards the width. Ten frames (fitted with "W. B. C."

ends), plus two $\frac{3}{16}$ in. spacing-strips, occupy exactly 15 in. Taking the sides of body-box as $\frac{1}{2}$ in. thick, this width ($16\frac{3}{4}$ in.) gives room for a dummy $\frac{3}{4}$ in. bare thick. This, in my opinion, is a "scant" measurement, because the frames will be more easily handled by making the body-box a little wider, and using a thicker dummy to fill up the extra space. This dummy can be made the required thickness in the following way:—Tack on to an ordinary standard frame a thin board $\frac{3}{16}$ in. thick one side; the other side, of similar thickness, may be made movable, with a bee-way at top, enabling the dummy to be used as a candy-feeder. The dummy will then be $1\frac{1}{4}$ in. thick, yet reasonably light, and when removed from the hive will afford plenty of room for manipulating the frames. I lay stress on facility of manipulation, it being a necessity in a large apiary.

The Dummy.—Most hive-manufacturers make the dummy close-fitting at sides, even if they allow a bee-space at the bottom. Considering the dummy as a "space-maker," however, this is, I think, a great mistake. The dummy should hang clear all round like the frames. Made as described above, its function is that of a space-maker only, and no compact ten-frame body-box can even approach perfection without it. The close-fitting division-board, on the contrary, is for quite another purpose, sufficiently explained by its name. Every first-class hive should contain one of each of the above forms; and practical bee-keepers located where propolis is plentiful will appreciate this arrangement.

Loose Side-slips.—These are used to increase the distance between outside comb-faces and the hive-walls, but, in my opinion, they can be advantageously dispensed with altogether by fixing small blocks of wood of the same thickness ($\frac{3}{16}$ in.) in the corners of the body-box, and also on the ends of top-bars of division-boards and space-makers.

Bee-space behind Dummy.—This I consider desirable, as it allows the bees access for the purpose of keeping the space in rear clear of wax-moth grubs. When less than a bee-space is allowed—as is generally the case, except in "Combination" hives—the crevice affords a safe harbour for these pests.

Adopting the foregoing dimensions, we have a body-box $17\frac{1}{2}$ in. square, which may be used so that the frames can hang parallel with, or at right angles to, the entrance. The depth of body-box is given as 9 in., allowing $\frac{1}{2}$ in. under the frames. This is quite correct, but the committee of the B.B.K.A. who devised the "standard frame" miscalculated in

this matter, inasmuch as the 9-in. boards which they evidently had in view will not be quite that width when planed up, and this, together with further shrinkage, will reduce the space under frames to $\frac{3}{8}$ in. or even less. To get the full $\frac{1}{2}$ in. under frames we must use 11-in. boards, cutting the sides of body-box a full $9\frac{1}{16}$ in. off the saw.

Space between Cases.—The sizes of the inner and outer case of the "W. B. C." hive allow about $\frac{3}{4}$ in. between them, and this is about the space adopted by myself in the first double-cased hives I made; but I now allow 1 in. clear, and find it better because of allowing quilts to be more easily tucked down between, thus conserving the heat of the supers.—S. P. SOAL, Rochford, Essex.

(Concluded next week.)

KEEPING BEES NEAR RAILWAYS.

[7377.] In your "Queries and Replies" column (January 28, page 40) I see you advise keeping bees on railway embankments. My experience is quite different. My apiary is situated quite 100 yards from the railway, and I intend moving my hives further away before another season. Every train that passes in the flying season kills hundreds of bees, and spring dwindling is nothing compared with it. My attention was first called to the case by a platelayer, and afterwards I saw it for myself. The passing train draws the bees after it, and they fall to the ground, and very few ever rise again. I should say the slaughter would be greater closer to the railway than my hives are situated. I intended writing to you a few weeks ago when an inquirer was wanting information as to the advisability of keeping bees in such a position, but had not the time.—A. SUNLEY, South Milford.

[We are glad to have your experience of keeping bees near a railway, but we have known several cases in which no harm resulted from the proximity. In one of our "Homes of the Honey-bee" there is shown the extensive apiary of Mr. W. Crisp (see B.B.J., September 2, 1897), which he successfully managed quite close to a railway-line.—Eds.]

KEEPING BEES ON ALLOTMENTS.

[7378.] It would perhaps interest "Hopeful, Leicester" (3878), to know that I have been very successful with bees kept on an allotment, in spite of the disadvantages you rightly point out, with the addition of being in a very poor district. The field is divided into small plots 10 rods each, with a path between each plot, and I have counted as many as fifty people working within a stone's

throw of the hives. I took this allotment with the express purpose of keeping bees there, and I am glad to record the fact no one has yet been stung, although several take their families for a week-end to the farm, as they are pleased to call it. One gentleman objected to my hives at first, so I politely asked him to help me to take them away again, but he declined. However, he is so far reconciled that I am fitting him and two other allotment-holders up with hives of bees this spring. With one exception, every man on the allotments has taken an interest in my bees, and it has given me real pleasure to tell them some of the wonders of the hive. Perhaps your querist "Hopeful" would like a few hints. With pleasure I offer the following: 1. Read very carefully the "Guide Book." 2. Obtain a quiet strain of bees. Native brown are best; Italians the worst. 3. Keep the hives at least 6 ft. apart, and have a row of runner beans on each side of allotment at back of hives (I have some well-grown raspberry canes trained on wires, and find they make a nice screen, useful and ornamental). 4. Plant permanent crops immediately in front of hives (strawberries or fruit bushes), leaving bees a clear flight, and do your weeding, watering, &c., in early morning or late evening. 5. Do not open hives just to show your friends, or at any other time unless necessary. Never open them in windy weather or when people are near. 6. Do not use a smoker; a carbolic cloth is by far the best. Hot smoke puffed into an overheated hive sometimes makes bees cross for days. 7. Last, but not the least important, try to find a practical bee-keeper in your neighbourhood. A beginner can learn more in the art of manipulation in a few minutes in this way than can be acquired in hours of book-reading.

If "Hopeful" will follow these few hints he will not have much trouble on the allotments, but will be able to sign himself "Successful."—SARGANT, Merton.

[7379.] I am prompted to write a few lines in reply to the query of "Hopeful" (3878). I also am an allotment-holder, and keep bees. My allotment is 8 rods, and it is five years since I took it over. I planted a thorn hedge all round, which has now grown to the height of 5 ft. My hives (six in number) are arranged in the centre of the allotment in two groups of three each. In front of one group I grow sweet peas 8 ft. from the hives. Eight feet from the other three hives I have arranged lattice-work 8 ft. high, covered with wire-netting. This arrangement keeps the bees up—i.e., immediately they leave the hives they rise; by so doing

they do not come in contact with any person passing or working in the next allotment. I have only heard of two cases of stinging of my fellow allotment-holders. I avoid manipulation as much as possible when persons are working near. When swarms are out and settle on my mates' peas, &c., I take them with as little damage as possible, and make all breakages good. In addition, to my immediate neighbours I give a pot of honey when the harvest is over.—MOORLANDER, Leek.

SURMISABLE.

[7380.] It is none of my business to dictate to the respected Editors of the B.B.J., but after the benediction of such illustrious contributors as Messrs. Crawshaw and Ellis (B.B.J., pages 16 and 35), which the above editorial has elicited, would it not be advisable for them to accept such advertisements, which inevitably would prove a great boon to many young men and maidens of the craft? It is too premature for "Scot" to give the sequel to his advertisement, but should my "Brither Scot" desire two hearts to beat in unison I would advise him to try the same expedient. Let him arise, and come out from the "Vale of Ussie," and ascend to the summit of "connubial felicity"! It is not everyone who is a member of a Bee-keepers' Association—"whereby the young ladies soon get married." Should this meet the eye of one estimable young lady who subscribed herself "Heather," I may state that I replied to two letters received from her, which replies were returned to me by the postal authorities as being contrary to their rules to deliver such letters without a paper from the sender signifying that the party receiving the letters is the correct one. Will "Heather" please come out of her hiding and send her name and address in full, as it is not beyond the bounds of possibility that she may yet become the *fiancée* of your humble contributor—Scot.

AMERICAN AND COLONIAL PAPERS.

EXTRACTS AND COMMENTS.

By D. M. Macdonald, Banff.

Longevity.—According to the editor of *Gleanings*, "Constitution, strength, longevity play quite an important part with our bees. Don't we all know of colonies with a fair amount of bees and a sufficiently prolific queen that will but little more than hold their own during a season, while others no more populous will build up beyond our most sanguine expectations? The last will increase while the first will barely keep up their strength. How can we account for it,

except by crediting the one with far greater vigour and longevity?" That is exactly what gives the blacks the pull in this "locality." The yellower races, prolific as they are, show an amount of nervousness and excitability sufficient to wear them out too quickly, while the cool temperature and equable "pulse" of the darker bees add days or weeks to the life of each worker.

In Far-away Hawaii.—The honey industry is carried on by syndicates. One Japanese company owns 4,000 colonies, and the American Sugar Company has about 12,000, so that it appears they are the most extensive bee-keepers in the world. Honey appears to be of low grade and largely aphidian, yet vast quantities are got from mesquite—highly valued as a honey-plant in Texas. Although the price realised is very low, these big concerns find its production very profitable.

Queens.—"Together with prolificness and great honey-gathering qualities should go perfect comb-building in the sections, white cappings of the combs, little inclination to build brace-combs in either brood-nest or supers, and the bees should not daub everything over with propolis. It is a fact greatly to be deplored that this most important branch of apiculture is the most neglected of all."

Gloves.—I never wore them when manipulating bees, and never will; but I will look on their use with more tolerance after reading the following from Miss Wilson in *A.B.J.*: "Gloves are not worn by the sisters entirely as a protection from stings. At least, more of them care for gloves as a protection against propolis than as a protection against stings. A woman probably becomes immune to stings as quickly as a man; but she does not so quickly become immune, if she ever does, to the unpleasant feeling of having soiled or rough hands." By the way, I find the best effacer of this tenacious adherent is *mud*. A fair flow of water, falling some two feet, is available. If the hands are "soaped" by the rough mud and cleansed under this flow it clears the propolis off expeditiously, and generally most effectively.

What a Doctor Says.—"One point worthy of being brought out prominently is the advantage of honey as a vehicle or adjuvant for carrying other medicines. At present, syrup, aromatic elixirs, alcohol, and glycerine are used; but these are more expensive, and have little or no medicinal value. For children or invalids, where sugar is denied, honey proves highly beneficial. There are very few cases of illness where honey would not benefit."—Dr. M. E. Macmanes in *American Bee Journal*.

WEATHER REPORT.

WESTBOURNE, SUSSEX.

January, 1909.

Rainfall, 1.21 in.	Minimum temperature, 23° on 28th.
Heaviest fall, .28 in. on 14th.	Minimum on grass, 16° on 28th.
Rain fell on 14 days.	Frosty nights, 15.
Below average, 1.35 in.	Mean maximum, 43.7.
Sunshine, 72.5 hours.	Mean minimum, 33.6.
Brightest days, 15th and 20th, 5.8 hours.	Mean temperature, 38.3.
Sunless days, 9.	Above average, 1.3.
Above average, 3.7 hours.	Maximum barometer, 30.706 on 4th.
Maximum temperature, 50° on 11th, 14th, and 17th.	Minimum barometer, 29.259 on 11th.
	L. B. J. BIRKETT.

JANUARY RAINFALL.

Total fall, 1.70 in.

Heaviest fall in 24 hours, .37 in. on 14th.

Rain fell on 17 days.

W. HEAD, Brilley, Herefordshire.

Queries and Replies.

[3881.] *Transferring Bees.*—I shall be much obliged if you can give me advice through your very valuable and interesting paper the B.B.J. in the following matter:—1. I have four stocks of bees in old skeps, which I failed to get transferred into frame-hives last summer, although I was successful with several others transferred at the same time. I can get plenty of frames of honey and frames of empty comb out of the ones I successfully transferred last year, and I propose to put these into empty hives, then drive the bees out of the skeps into these new hives. I intend doing this the first fine day we have, and before there is any brood in the skeps. If this plan can be successfully carried out, it will suit me better than having to transfer in the usual manner. 2. I also have one skep being robbed to-day (being mild). Can I check this, please? Thanking you in anticipation.—CHEVIOT, Beal, February 5.

REPLY.—1. You can very well drive the bees and introduce them on to the frames of comb, as you propose, when the weather is fine and warm. You had better, however, defer it until next month, and any pieces of comb containing brood could be cut out and tied into frames until brood hatches out. 2. Put a handful of grass at the entrance, and thus reduce the space. Or the carbolic cloth placed on alighting-board sometimes has the same effect.

[3882.] *Bees Fertilising Fruit Blossoms.*—When arranging for bees to fer-

tilise the blossoms of tomatoes and other fruits growing in houses, is it advisable to have an entrance from the hive into the houses as well as into the open? Being a constant reader of B.B.J., I shall feel obliged if you will kindly answer this question.—JOHN GEDGE, Penryn.

REPLY.—If the lights and doors of the houses are opened, no other entrance will be required, as the bees will easily find their way in on fine days.

Notices to Correspondents.

WEST HERTS.—*Candy-making.*—Sample of candy is too hard for use as bee-food. It appears to have been insufficiently boiled. You should try Brother Columban's recipe (see page 195 of "Guide Book"); if instructions are carefully followed the result will be a candy smooth in grain, which will remain soft for a very long time.

J. G. H. (Exeter).—*Bees in Hollow Tree.*—Removing bees from a hollow tree is a somewhat difficult task for a novice, though simple enough to one accustomed to handling bees. Write to the hon. secretary of the Devon Bee-keepers' Association, Mr. R. W. Furse, Woodbury, R.S.O., Devon, as he might be able to ask a local bee-keeper to assist you. It would be an advantage to you if you joined the county association.

GREENON (Chesterfield).—*Stock Found Dead in February.*—Queen is apparently infertile. If bees only covered four frames when packed down for winter it is not surprising to find that they have succumbed. Also stores were evidently short, and with an infertile queen there was no chance of their coming safely through the winter. Several cases have been mentioned in our columns of bees transferring eggs by correspondents who have had the same experience as your friend.

Honey Samples.

NOVICE (Truro).—Honey is of fairly good colour and flavour, but is thin in consistency, and has evidently been extracted in an unripe state, which causes it not to granulate.

N. Y. Z. (Taunton).—Honey is good in colour and flavour; it has been gathered mainly from clover. It is just starting to granulate, as shown by the granules floating in it. Well-ripened honey usually granulates, non-granulation being caused by its being taken from the hive in an unripe condition.

Suspected Combs.

KEELSON (Keswick).—There is no trace of brood in either sample of comb sent—indeed, one sample has never been bred in.

Editorial, Notices, &c.

Obituary.

MR. W. BROUGHTON CARR.

It is our sad duty to record the death of our esteemed friend and collaborator Mr. Carr, who has so long been connected with this journal and the *Record*.

Mr. W. Broughton Carr was born in

bers' Information for the People," and was fascinated with the idea of becoming a bee-keeper himself. He then read all he could about bees in the works of such men as Huber, Bevan, Woodbury, and Langstroth, which resulted ultimately in his becoming a successful bee-keeper. Later he removed to Higher Bebington, where he kept from twenty to forty stocks of bees. He tried various hives, finally adopting one of his own design, now



THE LATE W. BROUGHTON CARR.

February, 1836, and was therefore just seventy-three years of age. In 1851 he was apprenticed to the trade of copper-plate engraving in Liverpool, and carried on business in that city for twenty-six years. He married in 1861, and two years afterwards took up his residence in Cheshire, where he engaged in gardening and other rural pursuits. In 1866 he first became interested in bees through reading an article in "Cham-

known as the "W. B. C." hive. Mr. Carr advocated the shallow-frame for extracted-honey production, which is now in universal use, in preference to the deeper frame used formerly. He also introduced the metal ends which are now used in all British hives, and are known as the "W. B. C." ends. He was a frequent exhibitor at shows before joining the staff of the *BEE JOURNAL* in 1890, always taking prizes,

and was one of the original founders of the Lancashire and Cheshire Bee-keepers' Association in 1882. At the Indian and Colonial Exhibition in London he staged and superintended the county exhibit of the association, the largest portion of the honey being produced by Mr. Carr's own bees. As a practical manipulator there were few his equals, and it was always a treat to hear his counsels to beginners. He was a member of the Council of the B.B.K.A. since 1890, and was a regular attendant at the meetings, always doing his best for the furtherance of the interests of the Association. Owing to his wide experience he was in frequent request as a judge and examiner, and the Association has lost a valuable member whom it will find hard to replace.

Mr. Carr was a writer for many years before he became associated with the B.B.J. He contributed to the *Journal of Horticulture* even before the B.B.J. was established, and took an active part in the literary work connected with the *Record*—which subsequently came under his sole charge—from the time it was started in 1882. Much of Mr. Carr's valuable time was given up unselfishly to the promotion of bee-keeping, and he considered no sacrifice too great if he could assist a beginner or impart further knowledge to one genuinely seeking it. The BEE JOURNAL offices have been the rendezvous of bee-keepers from all parts of the world, and no one has ever been sent away without receiving the best advice and counsel that Mr. Carr could impart. It was his uprightness and high moral character that induced us to single him out and to associate him with ourselves in editing the BRITISH BEE JOURNAL, to amalgamate the, at that time, monthly *Adviser* with the *Record*, and to place the latter specially under Mr. Carr's direction. He carried out his trust with notable ability, and his sound practical knowledge and evenness of temper were seen alike in his own articles and in his replies to inquiries. When our advice was sought respecting the re-writing of the article on the "Bee" for the new edition of the "Encyclopædia Britannica," it was with much pleasure that we selected Mr. Carr for the work, which he carried out efficiently.

It is not too much to say that there were very few men in England who knew more about bees than Mr. Carr, and his loss is one that will be universally felt, for he was one of the kindest, most generous, and most just of men. Being so closely associated with him for so many years, we were well able to appreciate his high character, and personally we feel the loss as that of a valued friend and fellow-worker.

Mr. Carr was taken ill on Sunday, Feb-

ruary 7, with an attack of bronchial asthma, from which he did not rally, and expired on Thursday, February 11. We little thought that the letter he wrote to us on the 6th would be the last, but so it was destined to be. We have only good words for a good man, and of him it can truly be said: "The end of this man was peace." Mr. Carr is no longer with us, but his works remain, and his influence will be felt for a long time.

There are four sons and four daughters to mourn the loss of one who was as exemplary in his family life as he was in every other relation he sustained, and we are sure all our readers will join us in sympathy with them in their bereavement.

The funeral took place quietly on Monday, the 15th inst., at Lewisham Cemetery, Ladywell, S.E. Among those present, in addition to the members of the family, were Mrs. W. Herrod, Messrs. Stephen Abbott and S. Abbott, jun., W. Boxwell, H. W. Brice, P. J. Cowan, E. W. Eales, Robert Lee, W. F. Reid, W. McNeil Stewart, E. H. Taylor, and Major Fair.

Several members of the Council of the B.B.K.A. and other prominent bee-keepers wrote expressing regret at their inability to attend, owing to the short notice.

Since the news of Mr. Carr's death became known, we have received numerous letters of condolence, which show the esteem in which he was held by the general body of bee-keepers.

RESPECTING PARTHENOGENESIS.

(Concluded from page 53.)

6. Cradle mistakes are the exception and not the rule. We have known such cases as those mentioned by Dr. Kueckuck, but they can generally be accounted for by some defect in the queen. Only as recently as last summer we had a queen sent to us which was laying drone-eggs along with those which produced workers, and on dissection we found that the spermatheca contained so few spermatozoa as to show that the eggs could only occasionally be fertilised; therefore it was not astonishing to find drones under such circumstances. We have ourselves seen, at the apiary of Dr. Bianchetti in Italy, a queen that laid worker-eggs in drone-cells, because there were no others available, but there was not a single drone present in the hive. (B.B.J., 1886, p. 581.) For experimental purposes the swarm was first placed on the combs; the queen was for some time disinclined to lay, but at last she began ovipositing, thus clearly showing that the welfare of the stock had determined her action.

7. A queen normally mated deposits eggs regularly in worker or drone cells

according to the season and the needs of the colony, and has also the faculty of giving or withholding at will the spermatozoa at the time the egg is laid. The queen-breeder knows that if a frame of worker-comb is introduced into the centre of the brood-nest a good, healthy queen will fill every cell with worker-eggs. So, also, if drones are desired and drone-comb is introduced every cell will be filled with drone-brood. This is common practice; there is no element of chance about it, and it must be done intelligently by the queen. If the sex were determined in the haphazard way suggested by Dr. Kuckuck it would cause the greatest confusion in the hive and do away with all regulation of the sexes. Experience disproves such a supposition, and shows that even if there is drone-comb in a hive, a queen will not lay eggs therein until the need for drones is felt.

8. This is contrary to our experience, for we have had late-reared queens commence laying when there were no longer any drones about and before their appearance in spring. We had such a case last year, the queen having hatched at the end of October. Although not mated when we examined the hive at the beginning of March, there were already regular patches of drone-brood in worker-comb. There was no question about there being no drones, as they had all been killed off long before our final inspection of the hives at the end of the year. Colonies which lose their queens may retain their drones longer than others, but ordinarily they do not do so, and if queens are reared after the drones are slaughtered there is no possibility of their having any except those reared within the hive, as in the case stated above. By early stimulation, however, it is well known to queen-breeders that drones can be obtained as early even as March.

9. Dr. Kuckuck here seems to ignore the difference between the laying of a queen and that of a fertile worker, which is explained sufficiently clearly in all guide-books to enable one safely to distinguish between them. Therefore the experiment proposed by Mr. Crawshaw would only corroborate what has been proved before. There is also no proof that a virgin queen not fed by workers is incapable of laying, and we have never known a colony with a normal young queen to have fertile workers laying eggs. As a rule, fertile workers only appear after a hive becomes queenless. H. Ritter's observations do not coincide with our own, and as he himself admits that he is a "novice" he has probably not had the opportunity of observing what older bee-keepers have seen.

10. Professor R. Leuckart found sper-

matozoa in the oviducts immediately after impregnation, but not after they had been stored in the spermatheca, as we have already shown to be the case; a reference to "The Honey-bee," page 140, will make this clear. We have dissected and examined with the best objectives a large number of aged queens that had become drone-breeders, and have never found any trace of spermatozoa in the oviducts, when the receptacle contained simply a clear fluid. On the other hand, we have never seen a normal laying queen with this fluid clear. The sex-characters are determined by giving or withholding the fertilising element. The egg inheriting the male germ from its grandparent is sufficiently vitalised in the ovary to yield a drone, which is therefore produced parthenogenetically by the omission of the fusion of the sperm-cell with the egg-cell, but in order to produce a female bee this fusion is absolutely necessary (see B.B.J., 1908, page 304).

It is certain that the strongest and most robust drones have the best chance of mating with a queen, as fertilisation always takes place outside the hive, and the intelligent bee-keeper will keep not only strong and vigorous drones, but equally strong and vigorous queens, knowing full well that only such will produce the best workers. Finally, then, we are sorry at being unable to agree with our correspondent's deductions, his theory being based upon a generalisation of the laws laid down by scientists on observations made on other organisms without any evidence that they apply to bees; and they certainly do not agree with practice. Parthenogenesis is so well established, not only in bees but in other animals, that it will require more convincing arguments than those brought before us by Dr. Kuckuck to cause a change of opinion, and they will have to be supported by weightier evidence than we have hitherto had.

REVIEWS OF FOREIGN BEE-JOURNALS.

By "Nemo."

Franco-British Congress of Bee-keepers.—M. Sevalle, secretary-general of the Société Centrale d'Apiculture, gives quite a long and interesting account occupying four pages in *L'Apiculteur* of the above-named congress, and speaks highly of the reception given by the British Bee-keepers' Association to himself and others attending it. The interest taken in the congress was shown by the large numbers present, while the fact that Lord Avebury opened the proceedings in an address tracing the scientific progress made in the knowledge of the bee added greatly to the pleasure. After alluding to the important subjects brought before

the congress, M. Sevalle observes that a number of persons, including several ladies, joined in the discussions. He seems to have been impressed by the fact that the Board of Agriculture and Fisheries, the British Colonies of Australia—including South Australia, Queensland, Victoria, and Western Australia—New Zealand, and others sent representatives who were in attendance during the whole of the proceedings, and took an active part in the discussions. He mentions that honey in Australia is cheaper than sugar, and that modern methods of bee-culture in that colony are well developed. M. Sevalle also notices that the papers and discussions were followed with the greatest attention during the whole day, and considers the success marvellous considering that the time for arranging the proceedings of the congress was so short, and compliments the English by saying that they possess in a high degree the quality of neglecting nothing that tends to ensure success. M. Sevalle also alludes to the pleasant excursion made the next day to Mr. Herrod's apiary, where he saw how bee-keeping is carried on in this country. Besides seeing hives supered in which bees were storing surplus for future extraction, and in sections, queen-rearing on an extensive scale was also witnessed, both Mr. Sladen's methods and the American baby-nuclei being in operation. The lecture tent erected for the occasion was quite a novelty to our Continental friends, and this practical method of giving instruction was much admired. This excursion left a marked impression on M. Sevalle's mind of what can be done by skill, consistency, and respect for property and for law, which exist to the highest degree in England, and have enabled her people to extend their industry throughout the world. This practical spirit is found in commerce, for without prohibitive tariffs the Englishman has been able to defend himself against sophisticated products and foreign materials, it being sufficient to obtain a few convictions for selling adulterated honey to put a stop to its importation. M. Sevalle thanks the chairman of the Council of the B.B.K.A. and his fellow-workers for the interesting things he was able to see. It is evident, he says, that English bee-keeping is not carried on in the same way as in France. It is much more scientific. This he attributes to the English character, and also to the fact that we have not got bee-keepers managing 500 to 1,000 hives, as they have in France. He concludes by expressing a hope that the Franco-British entente may be favourable to the commerce of the two countries, and says that he carried away with him a most agreeable souvenir of his visit.

Correspondence.

The Editors do not hold themselves responsible for the opinions expressed by correspondents. No notice will be taken of anonymous communications, and correspondents are requested to write on one side of the paper only, and give their real names and addresses, not necessarily for publication, but as a guarantee of good faith. Illustrations should be drawn on separate pieces of paper. We do not undertake to return rejected communications.

RESPECTING PARTHENOGENESIS.

(Concluded from page 56.)

[7381.] 6. Cradle mistakes occur often. Herr Bohm (Finkenkrug, Germany) found the larvæ of a drone and of a worker occupying the same cell. (*Leipziger Bienenzeitung*, 1908, p. 44, "Zwillinge.") In the *Bienenwirtschaftliches Centralblatt*, 1908, p. 293, we read that in apparently normal conditions queens are sometimes found laying female eggs in drone-cells, and not seldom in normal hives queens lay worker-eggs in drone-cells in complete ranks in the midst of drone-brood. Herr Alfonsus (Vienna) also found that queens sometimes lay drone-eggs in worker-cells in the midst of worker-brood. (*Leipziger Bienenzeitung*, 1908, p. 116, "Eine wichtige Beobachtung.")

7. The male egg can as easily be succeeded by one which produces a worker-bee as by an egg from which a drone will emerge, the mother-bee not having it in her power to control the sex of the eggs she lays according to her will. In other words, the fertile female expels from her oviducts the ripe eggs contained in her ovaries one after another, unconscious of their sex or other characters, just as a woman gives birth to a child without any foreknowledge of its sex. At the moment of fertilisation of the egg the sex is determined by the predominance of the male sperm-nucleus energy, or of the female egg-nucleus energy, in the fecundated egg. (M. Kuckuck, "Sur le déterminisme du sexe," *Société de Biologie*, 1905, p. 416.) The eggs and the spermatozoa in a fertile female have not all the same vital power. The vigorous egg, therefore, fertilised by the weak or less powerful spermatozoon, produces a female embryo; whilst a following egg, if by chance weak and fecundated by a powerful spermatozoon, will produce a male; so that we have the mother-bee laying alternately worker and drone eggs, not of her own free will, but actually without knowing it.

8. Workers in the autumn are slow to feed a late-reared queen, which becomes a drone-breeder in the following spring, because of her not being mated in the preceding autumn. Not only so, but workers never feed an unmated female bee. In the spring, however, the young queen mates, and is then fed by workers,

and this enables her to lay eggs which produce only drones, as do the eggs of all tardily-mated female bees, incapable of producing female brood because weakened by not having been fed by workers for a long time. In the early spring there are always drones, Mr. T. C. Roberts (Maidstone) having had a queen mated early in March (see B.B.J. of 1907, p. 157). H. Ritter, K. Günther, Fey, and others have stated that in every season there are some drones (even in hives with abundant stores), and that with queens hatched in the early spring drones are also hatched. (H. Ritter, *Deutsche Illustrierte Bienenzeitung*, 1904, p. 119; *Leipziger Bienenzeitung*, 1905, p. 46; *Bienenwirtschaftliches Centralblatt*, 1907, p. 62; *Leipziger Bienenzeitung*, 1906, p. 159.)

9. If a virgin queen were confined in a droneless hive, the fertile workers—as they usually do in hives with a virgin queen or in queenless colonies, even in colonies headed by young normal queens (*Deutsche Illustrierte Bienenzeitung*, 1908, No. 8, "Potsdamer Imkerverein," Bekanntmachungen)—would lay drone-eggs, which could be readily accepted as the brood of the virgin queen. The experiment proposed by Mr. Crawshaw, therefore, is absolutely worthless because of the uncertainty of its results. As shown in Item 4, a female bee is never fed by workers before being fecundated, but if not fed by workers she is absolutely incapable of egg-laying. A virgin queen, therefore, confined in a really droneless hive can never lay eggs. H. Ritter, Cassel, Germany (Hermann Ritter is the well-known author of the work "Der Bien und ich," "The Bee-colony and I," 1903, Leipzig; many other publications on bee-practice in *Deutsche Illustrierte Bienenzeitung* and *Die Biene* are from him), an intelligent bee-keeper and trustworthy observer, has seen young virgin queens totally isolated from the moment of their emergence from their cells: never has such an isolated virgin laid an egg the whole season. Ritter, moreover, wrote me (August 16, 1907) as follows:—"In this year I have had two queenless hives: in both there were fertile workers, but only after drones had been flying some days. In queenless hives I have never yet found eggs before there were drones."

10. Nobody has yet shown that an aged queen, laying eggs capable of development, had no sperm in her oviducts. But in the secretory gland, called "spermatheca," there are not always found spermatozoa, as Professor R. Leuckart has shown when only seeing the clear fluid in the secretory gland ("spermatheca"); whilst both oviducts were crowded with sperm. (R. Leuckart, "Zur Kenntniss des

Generationswechsels," 1858, and T. W. Cowan, "Honey-bee.") This fact proves the so-called "spermatheca" to be a mere secretory gland, which spermatozoa now and then penetrate. This gland is not a magazine for the sperm, and the character of its fluid, whether clear or opaque, does not enable one to judge if the female has sperm in her oviducts or not. The sperm must be looked for in the oviducts with a very powerful microscope (Zeiss apochromatic objective and compensating ocular).

If the aged queens could produce drones without sperm, the unfertilised egg must contain the characters of the male sex and the spermatozoon those of the female, and if this be so all bee-keepers desiring an abundance of worker-brood ought to keep only lusty drones furnished with powerful spermatozoa possessing strong female characters, and very weak (sickly, badly-fed) queens producing powerless eggs containing weak male characters, easily suppressed by the opposite character of the fertilising spermatozoon. But the experienced bee-keeper is aware that only young, vigorous queens produce worker-brood plentifully; while, on the other hand, weak, sickly, and badly-fed queens, though mated early, produce only drones—that is to say, the vigorous fertilised egg, in which the sperm-nucleus cannot become sovereign or dominant, produces a female; while the powerless egg, in which the spermatozoon easily overcomes the other, produces a male. Consequently, as already said, the unfertilised egg contains the characters of the female, and the spermatozoon those of the male. The spermatozoon, therefore, is indispensable for a drone-egg, and every drone-breeder, young or old, whether queen or worker, has spermatozoa, because a drone-breeder produces individuals with male sex-characters contained only in spermatozoa, not in eggs, as shown above. (See Item 1. Correns, "Geschlechtsvererbung," and Kuckuck, "Sur le déterminisme du sexe.") The aged drone-breeding queen, therefore, has spermatozoa, the male characters of which become dominant over the female characters in the powerless eggs of the aged mother-bee, and thus the egg develops into a male (drone).

FINAL RESULTS.

1. *The egg-laying rule of a female bee is:*—Before mating, a female bee is not fed by workers; before having been fed by workers she is incapable of egg-laying; all the egg-layers, therefore, if queens or fertile workers, are mated.

2. Fecundation by spermatozoa containing male sex-characters is indispensable for drone-eggs; drone-breeders, therefore,

whether queens or fertile workers, if young or aged, contain spermatozoa.

3. Consequently, in a bee-colony all egg-layers having mated, and all eggs capable of development having been fertilised, there is no parthenogenesis.—DR. MARTIN KUCKUCK, Bordighera, Italy.

AMONG THE BEES.

WITH THE CRITICS.

[7382.] The rôle of critic is not much in my line, so I rarely adopt it, and then with reluctance; but one or two references in last year's volume were marginally crossed when read for future comment. On page 95 Mr. Herrod deals with exhibits at leading shows. With nine-tenths of what he says there I am in entire agreement, but paragraphs 7, 10, and 11 contain unpalatable references to Scotch bee-men which I should like better had they been eliminated. If the writer considers them typical Scotch exhibitors, then I have not a word to say; but if not, it would have been well if it had been so stated. I am not blind to my countrymen's faults, but I can say with confidence that I never encountered such a *rara avis* as either of the three specimens.

On page 464 I read regretfully: "But my friend was a 'Scotsman,' and I did not believe him." Who "Smoke" may be I neither know nor care, but his words, shot from behind the hedge of anonymity, are, if I read them aright with their face meaning, scandalous and ungentlemanly, while the consequential inference is absurd and un-English. Such an aspersion, levelled at so large a proportion of BRITISH BEE JOURNAL readers, should never have appeared in our pages, and now that attention has been called to it, it should be withdrawn. We are all British bee-keepers, and all sectional differences are to be deplored.

Faire Tales, and Prophets.—Contributions 7305 and 7344 may serve as pegs to hang a par. on. The writer of the first will kindly sound the terminal letter in my opening word mute—if that is not an Irish "bull." One hundred and fifty years ago a Scotch writer, Maxwell, set down the average *profits* of the hive at 20s., but he naively adds: "I choose to be moderate, that my readers may be agreeably disappointed." So that we may safely estimate the real profits at a higher figure. Bonner, fifty years later, not only derived "pleasures manifold" from his bees, but found them "very profitable"; indeed, he adds: "No concern in rural economy is more profitable than bees." He practically agrees with Maxwell in setting down the average per hive as 30s. Skip nearly another fifty years,

and we find Pettigrew using higher figures—over 40s. So it will be seen I have only followed the lead of a long line of "ancestors" in stating that a "net profit of from £1 to £2 is almost a certainty." The "pleasures manifold" show that my countrymen have an eye to more than "siller." The writer of 7344 may say these are Scotch estimates; therefore let me add a very few brief extracts from writers over the Border. Just three hundred years ago (in 1609) Butler wrote: "Bees yield great profit with small cost." Lawson (1638) states: "Bees, beside the pleasure, yield a great profit." I could quote scores of such opinions from ancient writers, and these were the bad days of the old straw skep! Thirty years ago, just at the dawn of modern methods, John Hunter estimates "a good stock should yield 35s.—a very large profit on the capital employed." Lastly, Mr. Cowan, in the "Guide Book," emphatically states that "apiculture, conducted on modern methods, is admittedly one of the most profitable of rural industries." So, dear friends, ancient and modern authorities, Scotch and English, are unanimous in agreeing that honey is money.

Lucubrations (page 48).—Why should there be any suspicion of my sincerity because I used this word? It requires no derivative legerdemain to make it palatable, surely. A lucubration is "that which is produced by meditation in retirement," which is an almost exact equivalent of Mr. Crawshaw's own words in introducing "Cappings"—"an unofficial comment," as the "fruits of study" on what appears weekly in the BEE JOURNAL. My own estimate places the major part of what now comes from Malton on a higher plane.

1. I think there is no difference of opinion as to the general success of the "direct method" of queen-introduction. Readers may remember in this specific case I confessed I acted "hastily." All the same, I felt pleased with the interesting result which followed, as it was worth a little blundering over. I still think that, under the circumstances, the queen would have acted just as she did, irrespective of the exact shade of light or darkness prevailing.

2. The swarm under review had nothing to make a queen out of. *Ex nihilo nihil fit*. To assert they could create one out of nothing would be highly pedantic, in spite of my high appreciation of their "creative" powers.

3. Note the words were "properly capped," which is a distinction with a difference. The pages of the JOURNAL record the story, but the honey was not mine. Neither was the cask; it was American, and the tale came to me through *Gleanings*. I do not "grow"

sour honey. Fixing either of the two specimens of honey on me tastes not as "cream," but as the sourest of sour milk, and run from the bottom of the receptacle where it is said to be thinnest.

4. The last paragraph on "A Swell Affair" reminds me of the "Bohrer Theory." The venerable Doctor (see *American Bee Journal*, page 17) holds firmly that *cappings of comb* are coated and impregnated with formic acid!

"Errors."—Mr. T. D. Sinfield thinks it an "error" (page 37), Mr. Crawshaw (page 48) a "mistake," for me "to compare the value of swarms with driven bees the same year when they are purchased." I have no hesitation in saying, without "smoking a pipe" over the matter—an indulgence I eschew—I wholly and entirely dissent from the findings in the last half of par. 1 on page 48. My ideas are diametrically opposed to those of both gentlemen on this question.

My reiterated assertion is: Early swarms are immediately productive; driven bees lie fallow for a whole year. That, surely, cannot be gainsaid. My initial outlay in the one case yields, *the same season*, 100 per cent.; the driven bees yield no percentage. That is so very plain that I should think he who runs may read. There is no "fog," no "ellipse," no "skipping," nor do I acknowledge that there ever was. The second year the driven bees, possibly, do yield, say, 100 per cent.; but the swarm "synchronously" yields its second return. Do not let us quibble over the exact amount, but it must in general be *double* for the two seasons what the driven lot yields for one. That is all my argument in a nutshell!

Mr. Sinfield seeks to pin a second "error" on me, but fails. My original figures remain, although I have offered to accept his estimate of 15s. against mine of 16s. He is quite justified, from his point of view, in stating that driven bees can be got free of carriage. They can, and at times even gratis, but that is a side question. Two facts, however, militate against the contention that the initial value put on driven bees is unfair. First, he himself estimates the average cost as 15s.; and, second, he admits in his last contribution, quite frankly, that "swarms got in May or early June are *best*," which was, and is, exactly my own conclusion.—D. M. M., Banff.

VITALITY OF BEES.

[7383.] I am much obliged for reply to my question *re* a drone being found in January. There is no doubt that it was a drone which had hidden itself away in some corner when the massacre took place,

for the wings on one side were off and the others badly damaged; but is not the following rather unusual? Having read the article on "Vitality of Bees" (7364, January 28, page 35), out of curiosity I put him near a stove, and he began to show signs of vitality and tried to crawl! How had he kept alive all the months since the massacre of his fellows? The workers would not let him get food. Would the supply he had on him when attacked last him such a long time? Have any experiments ever been made in this direction? I, and I dare say many others, would be interested to know.

The hive was my strongest and best colony at autumn inspection, with a 1908 queen reared after a swarm had left. I have inspected dead bodies daily since finding the drone, but have not found another.—F. SITWELL, Northumberland, February 8.

MODERN HIVE-CONSTRUCTION.

SOME PRACTICAL HINTS THEREON.

(Continued from page 58.)

[7384.] *Joints*.—The joints which may be used for outer-cases and "lifts" are the plain nailed joint, the rabbeted, and the dovetailed. The plain nailed joint was formerly most used in hive-making, and is best adapted to the average skill of the amateur hive-maker. The rabbeted joint is, however, much better; but the wood must be of sufficient thickness to get a reasonable bearing. With this joint the minimum thickness of sides of outer-case and lifts should be $\frac{5}{8}$ in., and the front and back boards may be $\frac{1}{2}$ in. A rabbet should be cut on ends of "sides" $\frac{3}{8}$ in. *on* by $\frac{1}{2}$ in. *deep*, and the joints put together with thick white-lead paint, and nailed both ways. This is, in my opinion, the *best* method of jointing the outer-cases of hives. The dovetailed joint is excellent in cabinet-making, being neat, strong, and, when well made and glued, quite independent of nails. I do not, however, consider it a suitable joint for hives, exposed as they are to all weathers.

The Use of Plinths.—I feel confident that if a question were asked on this point the answer would be in the negative by those who once try the plan of construction I advocate, which entirely obviates the need of such attachments. Beginning with the main outer-case: instead of making this to stand on the floor all round, the *front* only stands across the entrance-blocks—*i.e.*, the blocks of wood which form the sunk entrance in floor-board—while the sides and back drop over the floor $\frac{1}{2}$ in., all lower edges except the front being throated or grooved (a groove about $\frac{1}{2}$ in. wide by $\frac{1}{2}$ in. deep will suffice). Small fillets of wood, $\frac{1}{2}$ in.

by $\frac{3}{8}$ in., are nailed to inner lower edges of sides and back, $\frac{1}{2}$ in. up from edge and level with the lower edge of front, which is cut $\frac{1}{2}$ in. narrower than the remaining sides. The $\frac{3}{8}$ -in. edges of fillets, of course, rest on the floor. Before nailing these fillets on, however, it is important to see that lower edges of the outer-case are clear of "twist." The surface of floor, also, must be planed. The body-box, being, as already stated, $17\frac{1}{2}$ in. square and 1 in. clear between cases, requires that the *inside* dimensions of outer-case be $19\frac{1}{2}$ in. by $19\frac{1}{2}$ in., while the width of front board is $9\frac{1}{2}$ in., the back and side boards being $9\frac{5}{8}$ in.; thickness of sides (to be rabbeted) $\frac{5}{8}$ in., and of front and back $\frac{1}{2}$ in. The floor-board is cut $19\frac{7}{16}$ in. wide: this being lengthwise of the grain, the floor-boards will swell very little in this direction, but, with regard to the front and back, the floor may swell $\frac{1}{8}$ in. or even more, and it is necessary, in order to prevent the consequent forward movement of the entrance-blocks from jamming the entrance-slides fast in their grooves, to cut the front edges of these blocks a full $\frac{1}{8}$ in. short of being flush with front face of outer-case.

Porch.—It will be noticed that the cheeks of porch in the original "W. B. C." hive are placed flush with the sides of outer-case, and also with the roof of porch. I hope I shall be forgiven by the designer when I style this a rather shocking piece of hive-architecture. To look really well the cheeks should always be "set in" a little (say, the thickness of outer-case sides, or $\frac{5}{8}$ in.). The top of porch may then come flush at ends with outer-case sides, and will thus project over the cheeks $\frac{5}{8}$ in. It should also project over the top front edges of cheeks, otherwise it gives the whole porch a mean appearance. Some of your readers may possibly say that this is hypercriticism. Agreed; but it is just these small touches which in the aggregate constitute what we call style as exemplified in any piece of workmanship.

Lifts.—These are made to drop over each other $\frac{1}{2}$ in. It is, however, plain that if they were made with square upright sides, similar to main outer-case, the roof would require to be fully 2 in. larger each way than the size needed to fit the latter. To avoid this awkward increase in size, the lifts are made smaller at the top each way by twice the thickness of wood plus $\frac{1}{8}$ in. "clearance." In other words, the ends are cut to such a bevel that the top surfaces of lifts are exactly the same size as top of outer-case. The roof will then fit all three equally well, and there is absolutely no projection (except porch) to retain wet or hinder its running freely away. The

lifts are, of course, filleted $\frac{1}{2}$ in. from lower edges in the same way as the outer-case, and the edges throated.—S. P. SOAL, Rochford, Essex.

(Concluded next week.)

HONEY IMPORTS.

The value of honey imported into the United Kingdom during the month of January, 1909, was £1,899.—From a return furnished to the BRITISH BEE JOURNAL by the Statistical Office, H.M. Customs.

CAPPINGS OF COMB.

BY L. S. CRAWSHAW, NORTON, MALTON.

Better Queens (No. 1386, page 11).—Adrien Getaz has some reason in his arguments, for it is to be feared that his strictures apply to many queen-breeders who are simply rearers of queens. But his contention falls to the ground in the case of breeders who are also honey-producers, and who select by practical test. I have aforesaid strongly maintained that production and selection must be intimately allied, either in the person of the breeder or through a considerable apiarist who will continually test the natural output of the stock—that is, without undue manipulation.

Entrance Screens (page 14).—Some alighting-boards will not support a tunnel. This difficulty may be cured, and additional stability obtained, by allowing the $\frac{3}{8}$ -in. sides to project into the entrance. A drawback with such devices is that bees sometimes fail to easily find the entrance again, and in the delay become chilled and lost. Good results are claimed for a northward facing of the hives, when the sunlit-snow-trouble largely disappears. Of course, the hives should not be exposed to the force of the North Wind, or a screen may still be necessary to bar the door to Boreas.

Cost of Driven Bees (page 14).—Mr. Silver's reckoning of carriage is hardly fair when he compares a skep with a "heavy box." Actual weights would have been better stated. Now, it is a poor skep that does not weigh 4 lb., and there is no need for a box to weigh more than 6 lb. at the outside. But, supposing it to do so, is not this to be balanced by the fact that a skep must be, as he recognises later, returned empty at the expense of the purchaser, whilst a cheap grocery-box may be retained? Fairly reckoned, I do not think that the skep will show the advantage claimed for it.

Feeding Driven Bees (page 15).—Is it not a mistake to advise beginners to buy late lots of driven bees with the idea of their drawing-out foundation and storing syrup? Drawn-combs, at least, should be supplied, and unless these are available

late driven lots should be let alone, or in the hands of a novice winter losses will make them cost, on an average, much more than spring swarms. But I am strongly of opinion that they should be put upon combs fully stored, containing pollen if possible. Such extra combs may be obtained by profitably employing strong stocks upon the work when there is little or no honey-flow on, and the labour of producing them under such more favourable conditions is less rather than more.

Postman, What of the Wasp? (page 19).—One might as well send by post a live larva of *Cossus ligniperda*, the Goat Moth, as an "active queen-wasp" in a pierced matchbox! In all possibility, as an inspection of its front teeth would confirm, it bit its way out of the box, and perhaps through the post as well! At any rate, any P.O. official who was hunting for a match would more than find it in a very waxy *Vespa*! And if he expected safety, he might be excused any sudden expression of belief that he had struck Lucifer!

Controlling Swarming (page 21).—I am quite ready to believe in the Swiss claim, although I did not think it would come so soon. Nature herself has already done the bulk of the work in limiting, if not in reducing, the propensity in her evolution of some varieties of the provident type. For the race has not always been to the swift, nor in necessity to the swarm, but "time and chance happeneth to them all." Yet I find myself unconvinced of the desirability of eliminating the characteristic. True it is that we can control some of the malign influences which would militate against a non-swarming race; but the trait is of value, even if only for the purposes of increase, and should not be discarded, unless it can be unquestionably demonstrated that lessened swarming and increased honey-production go hand in hand; that is, unless the non-swarming stock is more profitable than swarming stock and swarm combined, under equally good management. It is interesting to note that Mr. E. R. Root—who is a gleaner of good things and a careful winnow of grain, although not entirely sheathed in what Colonel Walker smilingly calls the scientific armour of polite scepticism—does not credit the accomplishment; and there is reason for reserve, for whilst the Swiss data are impressive, climate may break down the attained trait, so that tests in the U.S. must be the practical means of proving the claim to E.R.R.

Old Combs (page 25).—Why does not "D. V." reckon the 2-oz. weight of a sheet of foundation to be wax? Is not the wax practically pure? Or at least purer than wax from the first rendering of combs? Impurity may account for

some gain in weight, which in two of the cases mentioned by "D. V." varies from 5 to 8½ per cent. There is no question, in my mind, that old combs contain more actual wax than new ones, for wax is added from time to time; but much of it is lost by imperfect methods of rendering, owing to absorption by pollen and cocoons. In the third case quoted the pollen was removed before rendering, and I am sure that removal of pollen, which has been my way, in common with "D. V.," for some years, is a good way, and results in an increased recovery of better wax.

NOVELTIES FOR 1909.

THE "HUNTER" DECAPPING INSTRUMENT.

Mr. D. Hunter, Craighead, Abington, N.B., sends us a sample of a little appliance which he wishes to introduce to the notice of bee-keepers as a "novelty for 1909." He describes it as follows:—"This article is used for scratching capped honey-comb, so as to stimulate breeding. It is made of steel, the dimensions being: handle, 4 in.; head, 1½ in.; teeth, ⅓ in. long and the same distance

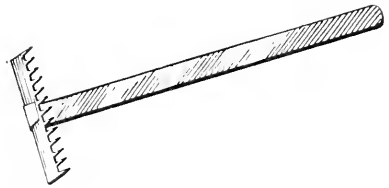

apart." The inventor has used a similar home-made one in his apiaries for a year or two, and found it so useful that he had it perfected, and wishes it made known for the general benefit of bee-keepers. For efficiency and despatch it is far and away in advance of any primitive method hitherto adopted in manipulating hives, and it can be had, postage paid, for the modest sum of 6d.

Queries and Replies.

[3883.] *Moving Bees to an Out-apiary.*
—I intend moving my hives to an out-apiary, and I shall stand them in a row, with the entrances facing north. There will be a 6-ft. closely boarded fence on the north in front of hives, and I should like to know: 1. How can I stand the hives in front of the fence so that the bees will have a free flight? 2. Later on I should like to stand a second row at the back of the first. How far ought the second row to stand from the first row? 3. What is the latest date this spring that I can move the hives? 4. In looking to see if bees are short of stores, if I find there are no cells capped over in the top of standard frames, as far as I can see without lifting

them out, ought I to give a cake of candy? Or would there be honey in cells lower down? Do bees use the top cells first? Your advice will be greatly esteemed by—DOUBTFUL, Maidenhead.

REPLY.—I. Six feet would be ample, but less would do if you are cramped for room. 2. If the hives are to face in the same direction, you should have at least 6 ft. to enable you to work comfortably at the front row without disturbance to the flight of the bees in second row. 3. If your out-apiary is situated at a distance of two miles or more, you can move the hives at any time, selecting fine weather, so that the bees could have a flight on their arrival at their destination. 4. Bees generally use the top cells last, and the cluster moves from one end of the frames to the other, so that if you find the top cells empty along the whole length of combs you should give the bees candy.

[3884.] *Queen-rearing Hive*.—In reference to Fig. 93, page 130, in the "Guide Book," will you please tell me if the queen-rearing compartment on the right of the illustration is next to the entrance or at the back of the hive? I take it that the frames run the same way as the entrance? Thanking you in anticipation.—G. E. HORWOOD, Gloucestershire.

REPLY.—The frames run parallel with the entrance, which would be to the left of illustration. The queen-rearing compartment is at the back.

[3885.] *A Beginner's Queries*.—I intend purchasing a stock of bees in a skep and transferring them to a frame-hive, and as I am only a novice I should like a word of advice on the following points:—1. Would it be right if hive was fitted with full sheets of brood-foundation? 2. Would an entrance of 6 in. by $\frac{3}{4}$ in. and two brass cone escapes be sufficient ventilation? 3. Is it wise to fill in airspace with frames of straw; also to have dummies of straw (insides to be lined with wood) for warmth? 4. Is the seaside considered too cold for bees? I should be pleased to hear of other seaside bee-keepers' experiences. I enclose name for reference, and sign—J. H., Whitley Bay.

REPLY.—1. Yes; you will find full instructions for doing this given in the "Guide Book" (page 149). 2. Such an entrance would be too small for a strong colony in summer, and should be at least 13 in. long. The cones are used in the ends of roofs, and are sufficient for the purpose for which they are intended. In hot weather the outer cases are wedged up if more ventilation is required. 3. It will do no harm, and if the straw is well protected from wet would be an advantage in cold districts. 4. There are a great many successful bee-keepers living near the seaside, even farther north than you do.

[3886.] *Covering Roofs with Calico*.—Would you kindly inform me how to prepare calico for hive-roofs? If it keeps out damp and wet, it may serve the purpose as well as zinc, which I have hitherto used. Name sent for reference.—J. A. C., Lanarkshire, February 15.

REPLY.—First give the roof a good coat of thick paint, and while wet stretch the calico over it, securing it with tacks on the under edges of boards. When the paint is dry, apply a coat of thinner paint on the calico. This should be followed by a second or finishing coat.

Notices to Correspondents.

BROODY (Epsom).—*Young Bee Cast Out of Hive*.—The "bee" sent is an undeveloped worker with aborted wings caused through want of warmth when developing. It is not unusual to find brood in early February. Stocks in good condition with plenty of food commence breeding in the latter part of January as a rule.

J. B. (Wilts).—*Bees Dying*.—The bees sent were suffering from abdominal distension, no doubt caused by the spells of cold weather we have had.

W. H. (Yorks).—*Race of Bees Inactive*.—If you think your bees are not energetic owing to the strain being a mixture, you might try some of the pure native bees advertised from time to time in this journal, either by getting swarms or introducing fresh queens.

BEGINNER (Stratford).—The bees sent have apparently died for want of food, and have become chilled on leaving their hive.

R. HASTINGS (Kingswood).—*Pea-flour Candy*.—Very good indeed.

J. M. BEST (St. Austell).—It is equal to 286 deg. Fahr.

M. McLAREN (near Oxford).—*Membership of B.B.K.A.*—There must be some mistake about your membership of the B.B.K.A., as this Association does not send out an expert to visit members' apiaries or collect subscriptions. Apparently you refer to the expert of some county association. We suggest that you should ascertain from the subscription receipt the name of the association, and write to the secretary. We are pleased to hear of your success in carrying out the instructions in "Guide Book."

Suspected Comb.

WELSH DRONE (Montgomeryshire).—The piece of old comb contains only mouldy pollen.

* * * Several important letters, &c., are in type, but held over from pressure on our space.

Editorial, Notices, &c.

BRITISH BEE-KEEPERS' ASSOCIATION

The monthly meeting of the Council was held on Thursday, 18th inst., at 105, Jermyn Street, S.W., Mr. T. W. Cowan in the chair. There were also present Miss Gayton, Messrs. R. T. Andrews, T. Bevan, J. B. Lamb, W. F. Reid, G. Skevington, Ernest Walker, and the Secretary.

The minutes of the previous meeting having been read and adopted, Mr. Cowan said it was his mournful duty to formally announce the sad death of Mr. W. Broughton Carr, who had been a member of the Council for a period of nineteen years, during the whole of which time his activities had been exerted on behalf of the good of bee-keeping and the welfare of the Association. His loss would be deeply felt, and was much to be deplored. He moved a resolution of sympathy with the relatives. Mr. W. F. Reid, vice-chairman, who attended the funeral as representative of the Council, seconded the motion, which was approved. Letters were received from Dr. Elliot, Mr. A. G. Pugh, Mr. F. B. White, and a number of others expressing appreciation of the late Mr. W. B. Carr's services to the Association, and wishing to be associated with their colleagues in the resolution of regret at his decease.

A letter was also read from Mr. Sladen suggesting that, with the object of perpetuating the memory of Mr. Carr, a fund be opened under the name of the "W. B. Carr Memorial Fund." This suggestion met with cordial approval, and was unanimously adopted on the motion of Mr. Reid, seconded by Mr. Walker. The sum collected to be placed to the permanent fund of the B.B.K.A., and the interest to be applied periodically in the offer of special prizes, or in such other way as may from time to time best serve the interests of bee-keeping. Contributions may be forwarded either to the Editor, BRITISH BEE JOURNAL, 8, Henrietta Street, Covent Garden, W.C., or to the Secretary, B.B.K.A., 12, Hanover Square, W., and will be acknowledged in these columns. The following contributions were announced:—

	£	s.	d.
Mr. T. W. Cowan.....	5	5	0
Mr. F. W. L. Sladen.....	5	5	0
Mr. Ernest Walker.....	1	1	0
	£11	11	0

The following new members were elected, viz.:—Mr. G. W. Avery, Croft House, Heads Nook, Carlisle; Mr. Alfred Francis Bryan, Holmwood School, Bexhill-on-Sea; Mr. C. L. M. Eales, Dilkusha, Wallington, Surrey (life member);

Mr. Thomas James Gibbs, 3, Fremantle Road, Cotham, Bristol.

Mr. Cowan presented the Finance Committee's report, giving particulars of receipts and payments to date, which was adopted.

The first-class examination was fixed for May 14 and 15 in various districts as required.

It was resolved that a *Conversazione* of members be held on Thursday, March 18, the following subjects being selected for discussion:—"Feeding Bees," "Working for Increase," and "Production of Sections."

Mr. Reid brought forward a proposal that an endeavour be made to arrange for an exhibition of apiarian appliances at the coming exhibition at Shepherd's Bush. He kindly promised to make inquiries of the Executive Committee in regard to the matter, and to report at a future meeting.

The next meeting of the Council will be held on Thursday, March 18.

CUMBERLAND B.K.A.

ANNUAL MEETING.

The annual meeting of the above association was held on Saturday, January 23, at 2.45 p.m., at Tolson's Restaurant, Station Street, Cockermouth. The Rev. Canon H. D. Rawsley, Keswick, presided. Among others present were Messrs. J. T. Campbell, John Dallas, A. Inkpen, David S. Scott, Isaac Lowes, William McMaster, John Musgrave, and William Henderson, Cockermouth; James Wakefield and T. Hunter, Papcastle; J. G. Black, J. W. Jackson, Brigham; Geo. Ismay, Fletcher-town; James Henry, Egremont; Messrs. Stephenson, Great Clifton; William Copesey, Seaton; Douglas Boueh, John Vicars, J. S. Dixon, J. Minshaw, Little Clifton; and G. W. Avery, hon. secretary and treasurer. Letters of apology for non-attendance were read from the Rev. B. G. R. Hale, Edenhall; Frank E. Marshall, J.P., C.C., Keswick; A. J. Hutchinson, Millom; John Atkinson, jun., Newbiggin; and W. R. Bennett, Calthwaite.

The chairman expressed his great satisfaction at the excellent attendance, and congratulated the members on the continued interest shown in the work of the association. The minutes of the last annual meetings were read and confirmed, and the hon. secretary read the report for 1908 and presented the statement of accounts, which showed a balance of £5 0s. 7d. in favour of the association. Mr. John Vicars moved the adoption of the report and statement of accounts, and expressed his satisfaction at the sound financial condition of the association. The chairman

in seconding said this was very satisfactory, considering the past two seasons had been so bad for Cumberland bee-keepers, and he hoped a better time was coming and that next season would put everybody in good heart. Their very best thanks were due to their secretary and treasurer.

Lord Muncaster was re-elected president, and the names of Lady Borwick, of Eden Lacy, Robert Slack, Esq., Derwent Hill, James Thompson, Esq., Brayton, and John Vicars Esq., Eskdale, were added to the list of vice-presidents. Mr. G. W. Avery was re-appointed hon. secretary and treasurer, and Mr. Arthur B. Bell hon. auditor. The local hon. secretaries were re-elected as last year, and the executive committee also remains the same as in 1908.

It was decided to try again to hold a good honey show in the county, which, owing to the poor season, had to be abandoned last year. The meeting passed a resolution in favour of the show being held in September, and the secretary was asked to convene a meeting at an early date to consider arrangements. The dates of council meetings for 1909 were left to be fixed by the hon. secretary, as found to be convenient. The locality for next annual meeting was left to be decided later. Votes of thanks to the chairman, to the education committee, the hon. auditor, the experts and lecturers, and local hon. secretaries brought a successful meeting to a close.

A pleasant discussion on Taking bees to the moors, on Foul Brood, the Work of the Experts, and several other interesting topics took place after the meeting.—G. W. AVERY, Hon. Secretary.

REVIEWS.

Mineral Waxes: Their Preparation and Uses. By Rudolf Gregorius. (London: Messrs. Scott, Greenwood, and Sons. 6s. net.)—Although the mineral wax industry is of comparatively recent date, it has made such rapid progress in less than forty years that it now ranks among the great industries. Paraffin was known and in frequent use forty years earlier, but its employment on a large scale coincides with the commencement of the ozokerite industry. It is therefore not difficult to understand why general knowledge should be scanty on the subject of ozokerite, ceresine, and paraffin in comparison with other industrial products, and this book treats of these materials, so extensively used in technology, in a thorough manner, showing their methods of preparation, properties, and even adulterations. The work is divided into five chapters, which treat of ozokerite and ceresine, paraffin, mineral (montan) wax, various appliances for extracting,

distilling, and refining, as well as the various technical uses to which these waxes can be applied. The introduction of mineral waxes showed them to be dangerous rivals to beeswax, and the consumption of this for candle-making declined; but for several reasons beeswax still holds its own and maintains its high price. Among the uses of some of the mineral waxes we find on page 174 a description under the heading of "Ceresine Honeycomb," and we are there told how artificial comb is made of ceresine; either alone or mixed with a little beeswax or carnauba wax, and that it has for some years been a very profitable article of manufacture. The writer does not tell us that bee-keepers look upon such comb-foundation (which of course is what is meant by honeycomb in this case) as adulterated, avoid it, and for certain reasons use only that which is guaranteed by the manufacturer to be made of pure beeswax. It is a pity that such instructions should be given in a book of this sort, as there are no doubt unscrupulous persons who would avail themselves of them. We find even that ceresine is subject to adulteration, and that extraneous substances are added to satisfy a demand for cheaper grades. The book contains 240 pages, is well illustrated, and treats the subject in a thoroughly technical manner.

The Food of Some British Birds. By Robert Newstead, M.Sc., &c. (London: Board of Agriculture and Fisheries. Price 4d.)—This is a supplement to the December number of the *Journal of the Board of Agriculture*, and in its eighty-seven pages contains a report on the food of some British birds by Mr. R. Newstead, of the Liverpool School of Tropical Medicine. A thorough investigation of the subject is being carried out by a committee of the British Association for the Advancement of Science, appointed in the autumn of 1908, and the Board of Agriculture have decided to work in conjunction with this committee. This report has the defect of all study and observation of any one individual, from its being local in its character. Although Mr. Newstead is a well-known naturalist, his notes are only from the county of Cheshire, with some observations made in Gloucestershire, excellent in themselves; but the conclusions arrived at in Cheshire will not hold good for the rest of England, and this is clearly seen in perusing the report. It is a pity also that so many birds well known to be harmless should have been destroyed in order to examine the contents of their stomachs. As an instance, we would mention that the stomachs of three bitterns were examined. It is hardly worth while killing birds which are not numerous, and from which

very fact the injury they can do is but infinitesimal. We notice that reference is made to the blue tit and the great tit eating the hive-bee, but Mr. Newstead has not been able to ascertain if these birds capture living examples. On page 31 he relates that his brother, Mr. A. Newstead, who keeps a large apiary in Cheshire, has seen these birds feeding on dead bees, but never on any of the live ones. The red-backed shrike, which is looked upon by bee-keepers in some districts as an enemy of hive-bees, these being found impaled on thorns in the immediate neighbourhood of the hives, is only mentioned as eating humble-bees. Very much more observation is needed in different districts before any useful conclusions can be arrived at as to whether certain birds are beneficial or injurious, and the promiscuous destruction of birds should not be encouraged, and that of rare species should be decidedly prohibited.

Die Mendelschen Vererbungsgesetze. By Professor Dr. Erich von Tschermak. (Vienna: Verein für Verbreitung naturwissenschaftlicher Kenntnisse.)—The author of this pamphlet on the Mendelian law of succession has for some time studied and written on the subject, and has been the means of bringing it prominently to the front. The scientific world is now giving full recognition to this new law, and at Cambridge a Professorship of Biology was founded last year with the express object of inquiring into the physiology of heredity and variation. There is no discovery in the principles of heredity that may compare with it since "The Origin of Species" appeared, and it is of infinitely more practical importance than that work. No one has yet been able to find any formula to express Mendel's law, which seems to touch the mystery of heredity, but some of its results may be foreseen with absolute precision. The law teaches that when pure stocks or strains are crossed it is found that certain qualities remain indestructible, and appear uncontaminated in a definite proportion of the offspring of all generations after the first.

Gregor Mendel, who was born of Austro-Silesian peasants in 1822, became a priest and ultimately Abbot of Brünn. He was a man of wide and varied interests, and became interested in the problems of hybridisation, and the results of his classic experiments on the common pea appeared as a paper in the Proceedings of the Natural History Society of Brünn under the title of "Experiments in Plant Hybridisation." He is also known to have carried out experiments on bees, but the record of them appears to have been lost. For thirty-five years Mendel's work remained unknown, and hybridisers were working in the dark

with inconclusive results. Of late years doubts have been cast on the all-sufficiency of natural selection in the production of new species, which was regarded as a settled question when "The Origin of Species" appeared. Interest in these matters was revived by a few biologists in 1900, who found that a clue to the principles of heredity was supplied by Mendel's discoveries nearly forty years before. Much has already been done, but there is every indication that through Mendel's law we are likely to have important discoveries in the breeding of animals and plants, and even in the improvement of bees.

The Methods and Scope of Genetics. By W. Bateson, M.A., F.R.S. (Cambridge: The University Press. Price 1s. 6d. net.)—This is an inaugural lecture given by Mr. Bateson, who is the first Professor of Biology in the University of Cambridge. The object of endowment of the professorship was for the promotion of inquiries into the physiology of heredity and variation, a study now spoken of as "genetics." The term is new, and although the problems are among the oldest which have puzzled the human mind, the methods by which they may be successfully investigated are also of recent invention. In this study we start from a common fact generally familiar, that all the ordinary animals and plants began their individual life by the union of two cells, known as *gametes*, or "marrying" cells. The diversity of form which is characteristic of the animal and plant world must be somehow represented in these gametes, since it is they which bring into each organism all that it contains, and a certain fact is that all the powers, physical and mental, are contributed by one or by both of the two germ-cells which were united in fertilisation and gave it existence. Each gamete is supplied with certain ingredients or factors, which may be either the same in both male and female, or different. If the factors are the same, the resulting organism is called *pure-bred* for that ingredient, and if dissimilar the resulting organism is *cross-bred*. If both parent gametes bring in a certain quality, all the daughter gametes have it, but if neither brought it in then none of the daughter gametes have it. If it came from only one side, then on an average it will be present in half and absent from the other half. This phenomenon, which is called segregation, is the essence of Mendel's discovery.

We have only briefly alluded to the substance of the lecture on genetics contained in this book of forty-nine pages, and would only add that anything Professor Bateson writes on the subject of heredity always commands the attention

of those interested in the matter. He is the author of a work entitled *Mendel's Principles of Heredity*, a new edition of which is now in preparation, and will be generally welcomed.

THE LATE W. BROUGHTON CARR.

Since the announcement of the death of Mr. W. Broughton Carr, which appeared in the B.B.J. last week, we have received a large number of letters expressing the sorrow that is so universally felt at his loss. It is only necessary for us to give a few extracts, which will show the high esteem in which he was held.

A very old contributor says of him: "A sterling, straightforward man, who well deserves his rest. Yet I would rather think of him making a fresh start than resting. A fresh start in a brighter and happier world, with all sorts of interesting pursuits, and amongst them bee-keeping. Nor is it possible to think of Mr. Carr—I mean his individuality, not his nearly worn-out body—with no bees to look after and think about."

Another writes: "It is terrible losing him, for indeed he was so good to me. I looked to him as I would a father. I want to remember him as I saw him last, full of life."

"In Mr. Carr's death the bee-world has sustained a severe loss, and it will be difficult to fill his place."

"One does not, I feel, easily lose a right-hand or an old and trusted friend like Mr. Carr, who was affectionately known as 'W.B.C.' even to those who never saw him."

"The whole bee-world will mourn the close of a long and honourable career, during which the B.B.J. was conducted with a combination of honesty, dignity, and authority which is rare in present-day journalism."

"Although I had not often the pleasure of meeting Mr. Carr, I soon learnt to value his company, his kindness of heart, and willingness to help one, endearing him to many besides myself."

"He will be much missed by all who knew him, and a great loss to the bee-keeping industry of this country."

"To bee-keepers the world over, myself included, this is a serious loss."

"Though the loss is great, it must be a great consolation to you to feel that he was so widely and so genuinely beloved."

"The BEE JOURNAL and *Record* will miss very much his guiding hand, and we his genial friendship."

"We shall miss in many ways and at various places his genial, kindly, and ever-ready help and advice; though we are sure he will not be forgotten for a long time, for his works will live after him."

"Ablen pens than mine will no doubt pay tribute to his talent and many estimable

qualities. but I should like to express my gratitude to you as his brother Editor for all the help and counsel I have received from Mr. Carr—firstly, as a novice bee-keeper, through the columns of the B.B.J.; secondly, as a junior member of the Council of the B.B.K.A.; and, lastly, for many hints on judging and other matters from time to time."

We could multiply these extracts and fill our paper, but we think the above will be sufficient to show the great esteem in which our friend was held.

It will be seen from the report of the meeting of the Council that the B.B.K.A. was represented at the funeral by the vice-chairman, Mr. W. F. Reid, and Mr. P. J. Cowan represented the B.B.J. It was decided to raise a fund with the object of perpetuating Mr. Carr's memory, and we have no doubt so meritorious an object will be supported by liberal subscriptions so as to put the Association in a position to benefit the industry, which was always Mr. Carr's desire.

It is impossible for us to answer all the letters that we have received, therefore we take this opportunity of thanking the writers for their kind words of sympathy and appreciation, for which we are most grateful.

We have received the following letter, which we take the opportunity of inserting here:—

DEAR SIR,—Will you allow me, on behalf of my sisters, brothers, and myself, to gratefully thank readers of the B.B.J. for the many kind letters of condolence and sympathy we have received? It is a great consolation to us to know that our late father's efforts in the interests of bee-keeping have met with so much appreciation. His love and enthusiasm for the bees were intense, and he gave unreservedly the benefit of his experience to any of his fellow-apiarists who consulted him. It was a never-failing source of pleasure to him to meet with bee-keepers when attending honey shows in different parts of the country; he was always glad to see them and hear about their bees. The character of the bee was reflected in some measure in his nature. He led a simple, natural life; he worked hard—"for the joy of working"; he passed away in peace, his work done.—GEORGE R. CARR, Finchley, February 20.

"W. B. C."

Oh, tell the bees! For he, their friend, is gone,
Who loved to see them spread o'er flow'ry leas;
Full snugly hived them till the summer shone;
Contrived to save them from the fatal squeeze
When merchant-clustered frames are moved; anon
Snatched millions from the grip of fell disease.
And now their friend is gone! Oh, tell the bees!

G. G. D.

Correspondence.

The Editor does not hold himself responsible for the opinions expressed by correspondents. No notice will be taken of anonymous communications, and correspondents are requested to write on one side of the paper only, and give their real names and addresses, not necessarily for publication, but as a guarantee of good faith. Illustrations should be drawn on separate pieces of paper. We do not undertake to return rejected communications.

NOTES BY THE WAY.

[7385.] Bee-keeping has lost in the death of our dear friend Mr. W. Broughton Carr its chief "standard-bearer." For many years he has taken the practical guidance of the two British bee-journals, those ties which bind bee-keepers together in a bond of brotherhood by the interchange of opinions on the topics most to the fore, and those of us who have been acquainted with him during his long period of supervision know the honest and impartial way in which he endeavoured, for the best interests of bee-keeping, to make the B.B.J. and *Record* of practical utility to the whole craft. And now that death has deprived us of his wise counsels and practical knowledge, the burden of the work will fall on our Senior Editor, Mr. Cowan, until a worthy successor can be found to fill the place of our late friend.

Keeping Bees on Allotments.—To bee-keepers on allotments I would recommend black currant bushes as a good shelter at the back and sides of the hives, and they also make good alighting-places for swarms. If manipulations are carried out in the evening and a good-tempered strain of bees is kept, very little, if any, annoyance will be caused to owners of adjoining plots. A bee-keeper who is continually meddling with his bees will stir up the worst traits in their characters, and thus cause them to become a nuisance to anyone working near. The evergreen privet will in a short time make a good wind-break for both winter and summer, though I consider black currant bushes preferable, as one has the fruit in addition to the honey crop.

No time should be lost in putting the apiary into trim condition for the coming season. At present the arrangement of the hives may be attended to, and this should be done with the least possible disturbance to the bees. If the rearrangement requires the removal of hives a few yards distant, it is best to accomplish this by moving them about a yard per day on fine days when the bees are flying.

Hive-roofs requiring painting should be removed to a shed for the purpose, and a makeshift put in place till the paint is hard. If hives are painted while bees are flying, many will be lost on the wet paint.

The body of the hives can be painted in the afternoon on a dry, sunny day after the bees have ceased flying; but entrances should be closed with a strip of perforated zinc and left so for the night. In the morning the paint will be quite dry, and no danger to the bees will result. If the weather continues fine, with warm, sunny days, an old skep or two containing shavings with a little pea-flour sprinkled on them may be placed with advantage in a sunny spot near the hives; a little early pollen will help to start brood-rearing. I placed some skeps containing artificial pollen (half flour and half pea-flour) near my sheltered watering-places on Saturday last, and in half an hour several bees were collecting it in their pollen-baskets, while hundreds were hurrying to and from the tins of spent tea-leaves after the water they contained.—W. WOODLEY, Beedon, Newbury.

CUMBERLAND BEE-KEEPING.

[7386.] The enterprise and determination of the hardy dwellers among the fells have never been brought more prominently into light than during the last two seasons, when the bee-keeping section have had to face a steady and persistent run of ill-luck. Several times during the summers of 1907-08 has a bountiful reward seemed almost theirs, when a sudden change of weather has dashed all hopes, and left the unfortunate bee-keeper with empty racks and in too many cases starving bees. Anxiety for the future is plainly evident in the "crack" wherever two or three bee-men gather together, and the chances and possibilities of the coming season are discussed. The C.B.K.A., powerful as it is in numbers, has, as was only to be expected, felt the pinch of two such adverse seasons; but over seventy recruits have come to swell the ranks, and only a good season in 1909 is wanted to again boom our craft among the lakes and mountains. Modern methods are now universal, and the old-fashioned skeppist is a *rara avis* seldom met with. In many very high altitudes bees are to be found, notably at Boot, where among some of the highest mountains in England quite a number of bee-keepers are located. It is worthy of note, *en passant*, that in such high places, where practically no honey-flow comes except in the autumn, the strains of bees, some of which have existed for a long number of years, must be very hardy. During the time previous to the advent of modern methods and appliances only the very hardy could survive, and a strain of bees has been built up which is second to none in any country. I believe, from what I have noticed in all parts of the county, that the native bee which has

existed here from time immemorial is the very best. We have not been immune to the craze for a more beautiful bee, but the goldens have been found wanting and are being got rid of. Seekers after new and hardy strains need not send to the Alps for them; they are to be had at home. There is a growing desire among the bee-keepers themselves for more intercourse with followers of the craft in other parts of the country, and the suggestion has been thrown out in the columns of the B.B.J. that a Northern conference should be held. Nothing can keep alive enthusiasm among any class like the assembling together at intervals for interchange of ideas, and this meeting of Northern bee-men is a consummation devoutly to be wished. We cannot, however, expect the B.B.K.A. to take this in hand, but if a few Northern enthusiasts would put their heads together I am sure the meeting could soon be an accomplished fact, and would no doubt lead to others of a similar kind. Those interested might let us hear their opinions.—G. W. AVERY, Heads Nook, Carlisle.

MODERN HIVE-CONSTRUCTION.

SOME PRACTICAL HINTS THEREON.

(Concluded from page 68.)

[7387.] *Roof*.—"What shall we cover our leaking roofs with?" is an oft-repeated query in the B.B.J., and in reply we have correspondents recommending zinc, painted calico, and even tarred felt at various times, but if your readers will take advice from me and make their hive-roofs according to the following directions, I can assure them they will have no need to use any amendments of previously bad workmanship. These complaints of leaking roofs can only arise from one or both of the following causes: Either the wood is defective, or the roof is constructionally at fault. Bearing this in mind, it is most important that the roof-boards shall be absolutely free from knots or shakes. A scarcely discernible "shake" will extend and open out when exposed to sun and rain; and yet it is more than probable that a slight "shake" will be entirely ignored by the average professional hive-maker. The consequence is we have leaky roofs. We may then, I venture to think, consider the fact of more or less defective hive-roofs being sent out by manufacturers as proved. It will be seen that for a roof to cover the size of outer-case given boards about 12 in. wide will be needed, and, apart from the cost of such boards for this purpose, we must bear in mind the fact that 12 in. wide boards will swell and shrink three times as much as those one-third the

width. It is well known to wood-workers that swelling and shrinking will tend to develop cracks in a board; and when we know that slightly defective wood is sent out by hive-makers it must be an improvement to use three narrow boards in lieu of a single wide one for each side of the gable. All six boards used should be "throated" on under side of the lower edge, and, what is most important, yet seldom or never done by hive-manufacturers, the surfaces in contact, including the groove, should be well painted with white-lead paint before nailing together. The under side of ridge-piece should also be treated with paint in the same way. These precautions will stop the capillary attraction induced by the contact of two surfaces at the laps, and there will be no need to make the grooved edge of each board stand clear of the surface of next lower board.

It will be noted that I have given special attention to the construction of the roof, and experience of roofs made in the same way enables me to guarantee that a roof so made, with specially selected wood, will remain waterproof for many years.

Surplus-chambers.—Dealing first with the shallow-frame supers, these will, of course, be made of similar size as body-box, viz., 17½ in. square, and, if eight wide frames are used, will, like the latter, require a dummy to fill the surplus space. This should be made in much the same manner as the one used in body-box.

Section Racks or Boxes.—The hanging-frame section-box designed by the late Mr. Carr is the one generally staged with the "W. B. C." hive at shows, but it does not follow that it is the one generally adopted by bee-keepers. There are, indeed, in my opinion, several objections to it: 1. Its cost. 2. The fact that in use the frames are so firmly cemented together with propolis as to need a knife to separate them. 3. Since the advent of the super-clearer, almost the only advantage these frames possess is that they prevent the daubing of the wood of sections with propolis. But the edges, and especially the "insets," are even more propolised than in the ordinary close-fitting rack owing to the fact that such edges are never quite flush with the corresponding edges of the frames. The section-rack I prefer is one generally used in this country, but mine is better made than most. It has the usual wood slats at bottom (a full ¼ in. thick), and of such a width that three sections abreast will just drop in, with the least possible "play." This is the neatest adjustment in the whole hive, requiring close measurement; but, when properly done, it ensures squareness of sections. It is better to make the sides of

rack stand a little above sections, so that, when tiering-up, the weight is supported on the rack-sides. All racks should be made long enough to hold twenty-four sections when dividers are removed. This will be found convenient when estimating the number of finished sections after cleaning and grading.

In conclusion, I may remark that the "W. B. C." hive has been selected merely as a typical double-cased hive, and many of the foregoing suggested improvements are applicable and equally badly needed in most modern hives. I feel confident that the improvements advocated are not merely theoretical but real, and will be admitted as such by practical bee-men who are also skilled hive-makers. I trust, therefore, that my suggestions will be found helpful, not destructive, being the outcome of some twenty-five years' experience with bees and as a hive-maker.—S. P. SoAL, Rochford, Essex.

THE LATE W. BROUGHTON CARR.

[7388.] Will you permit me to say with what unfeigned regret I have seen the presentment of Mr. Carr's kindly and honest face in this week's JOURNAL as an illustration to your obituary notice, and at the same time to thank you for your deeply sympathetic writing in that notice? As a regular reader of over twenty years I have taken the liberty of mentally setting down many of its pages to his pen, and once, in your absence from England, felt very grateful for very kind words, which I took to be his, with regard to myself.

Never in my bee-keeping experience have I been prouder than in the great and unlooked-for pleasure of being bracketed with Mr. Carr in the work of judging at Gloucester next June. It is a keen disappointment that on that occasion I can have the pleasure neither of meeting him once more nor of working under his guidance.

Will you please accept a respectful expression of deep sympathy with yourself, on whom the blow must fall heavily, as you lose at once a faithful friend and trusted coadjutor?—S. JORDAN, Bristol, February 19.

HONEY IN ITALIAN RIVIERA HOTELS

[7389.] I should be very much obliged to you if you could kindly tell me if the stuff contained in the little bottle I send you is bee-honey or an artificial product. Bordighera is almost a British colony of Riviera guests. Here there are an English church, a British Vice-Consulate (Edward E. Berry), an English Bor-

dighera journal. British supply stores (Mr. Chas. R. Collingwood), with all British provisions *except British honey*.

In the hotels all English guests (mostly invalids) are forced to consume an unwholesome artificial honey, while pure bee-honey would be to them a real remedy. Why should British bee-keepers not send their honey to Bordighera (securing in this way perhaps the honey-market on all the Riviera, where there are very many British guests), and let us have here wholesome pure honey? Therefore, will you kindly tell me if this stuff which I send you is really artificial honey, as I suppose it to be (there is no aroma at all!), that I could tell it to the British guests here and recommend them pure British honey?—DR. MARTIN KUCKUCK, Physician, Bordighera, Riviera di Ponente, Italy.

[The sample sent is evidently an artificial product, perfectly clear and transparent, but entirely devoid of aroma, nor has it the characteristic taste of honey obtained from orange-blossoms. It has probably a small quantity of honey added to it, but not sufficient to impart the flavour of honey.—ED.]

TOTAL HONEY IMPORTS

FOR THE YEAR 1908.

	value	£
January	656
February	1,434
March	3,053
April	4,156
May	2,490
June	3,753
July	3,835
August	3,570
September	1,781
October	1,743
November	1,516
December	3,782
Total ...		£31,769

AMERICAN AND COLONIAL PAPERS.

EXTRACTS AND COMMENTS.

By D. M. Macdonald, Banff.

From "Gleanings."—The heavy-weights are to be curbed in, and "all the department writers in future confined to one page." This is as it should be. As a rule, an article, on almost any conceivable subject, can be effectively dealt with in this space. I have preached that doctrine before, and practise what I preach. Long-winded articles are a mistake, while needless verbosity does more harm than good.

White clover is engaging the attention of quite a number of American bee-men.

Drougths, if very severe, burn clover up on light soils, but it is the "alternate freezing and thawing during spring" which heaves it out of the soil from which we suffer most on this side. But neither ill creates a clover "famine."

Wide winter spacing is not favoured. "We tested some colonies with regular spacing and others with wider spacing side by side, and could see no difference; anyone who has followed our wintering knows that we have been generally quite successful."

The editor, Mr. E. Root, and a departmental editor, Mr. L. Scholl, rather favour the idea that "shaking" does good by imparting added energy. The first considers "there is more in shaking than many are inclined to believe"; while the latter adds, "Many times I have claimed to squeeze just a little more honey" by stirring up the bees to greater activity.

Telling the age of a queen is, in general, no light or easy task. Dr. Miller says: "An old queen is darker and more shiny, owing to loss of plumage. She moves with less vigour, more slowly and feebly, than a young queen, and at times even misses her footing." J. E. Crane adds the one descriptive word "dull"; when old, queens have a dull, faded look.

From "Review."—The author and inventor of "shaking" endeavours to show cause for the faith that is in him in a second article, the gist of which is contained in the following sentence: "In all my manipulations I try to keep the fact before me that a *thorough shaking* never fails to bring a colony into the same psychological condition that characterises a newly hived swarm." If this is secured by this process, there is something in the system, for at no other time is such intense energy displayed than during the first few weeks in the new home.

An interesting point is made by Mr. Hershisher in the comparison he institutes between wholesaling and retailing, where he strenuously advises bottling honey "for the distributor's ware-room, the retailer's shelves, and the table of the consumer. In this there is the probability of almost, if not quite, duplicating the profit."

A writer winters his nuclei in thin boxes "snugged" up close together. "Place them after breeding is over on heavy combs into narrow cases holding from three to five combs each, setting these boxes close together in blocks of eight, and packing round the outside."

The editor gives us an interesting glimpse of his inner life, and in a reminiscent mood calls up several scenes of the time long gone by. The photo of Mr. Hutchinson and his grand-children tells a story without words, and the model apiary shown in the frontispiece is one of the neatest reproductions of American hives

I have ever seen, and illustrates the high *ideal* which its owner would fain realise.

From the "Journal."—The ladies might try the following honey cure: "Rub the hands with vinegar and corn-meal, then wipe, and rub in a few drops of honey and water mixed, not enough to be sticky. Keep it up, and be rewarded with white hands."

Mr. Laws (not Lewis, please), of Texas, after years of experience of Cyprians and Holylanders on a large scale, has decided to clear them out and discard all but the Italian race. We in this country did the same pretty well nigh twenty years ago with both races.

Mr. Dadant, *the* advocate of large hives, makes this confession: "The size of the hive alone is not sufficient to abolish swarming, but the system followed, joined to greater comfort of the bees, gives as safe a system of honey-production as can be had under any circumstances." Mr. Doolittle, a few pages after, reviewing different kinds of hives for comb honey, concludes: "I finally adopted the ten-frame 'Langstroth' hive as the right size for out-apiary work."

I am not well up in matters connected with extracting, working as I do for section honey, but I have often puzzled over the reason for working the knife *up* while uncapping, when a downward stroke would appear to be more effective. Quite recently several on the other side have preached and practised this idea. The advocates of the downward stroke are emphatic over its advantages.

From Canada.—At the recent convention "almost all, if not all, the inspectors stated that they had found more disease than they expected. One inspector had found 41 per cent. of the apiaries he visited diseased." This is a very serious indictment. It would almost read to me as if the system followed has a weak point, and, personally, I hold strongly the fault lies in the fact that simple *shaking* is depended on as a cure. We in this country would never trust to this alone. Every hive where the disease is even suspected should be thoroughly cleaned and conscientiously disinfected before being again used.

Canada is to have an apicultural station to conduct experiments and carry on investigations. Either sex can have a course of study in apiculture, and learn the practical management of bees. This is under the *agis* of the Government.

From Australia.—The editor of the *Bulletin* has difficulties to encounter we would never dream of. "Lad nearly ran over a mountain black snake, but he killed it. Same afternoon he killed one six feet long at the door." Honey is quoted: Choice, 3½d.; ordinary, 3d.; and

dark, slow sale, at 2½d. Beeswax brings from 1s. 2d. to 1s. 3d. occasionally. Queens are expensive over there, judging by the following samples:—Italian queens, untested, 5s.; tested, 15s. (Beuhne); Cyprians, untested, 5s.; select breeders, 15s. (Reid); four others quote the same prices.

NOVELTIES FOR 1909.

THE "CARVER" SECTION-GLAZING MACHINE.

The inventor, Mr. John Carver, Victoria Avenue, Wellington, Salop, in describing the above interesting novelty, writes as follows:—"The machine was brought out as long ago as 1905, and was first shown at the Dairy Show in that year, securing a first prize. It was very favourably reported upon both by the judges and also in the columns of the B.B.J. (see page 414, October 19, 1905);

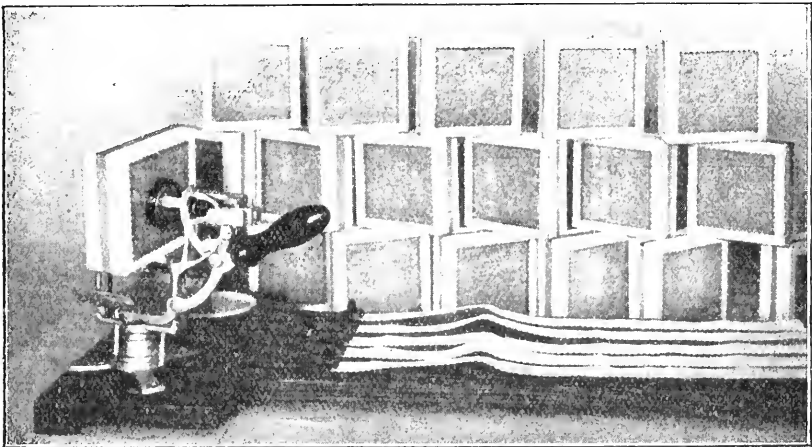

"CARVER" SECTION-GLAZING MACHINE.

but has never been put on the market, and is now introduced to public notice at the request of many bee-keepers who saw it at the Dairy Show and at Shrewsbury Show in 1908, when it was awarded a bronze medal. The machine has been used by the inventor ever since, and several improvements have been made, so that it is now as perfect as possible. Its merits are cleanliness, rapidity, and perfect work; many hundreds of sections can be glazed in a day, and the work is a pleasure instead of a labour. The section, with glasses, is placed on the stand and the lever released, which allows the section to revolve in any direction. It will answer for any kind of sections, and is quite simple to manipulate. The first lot of one hundred machines will be ready in April, and the price being only 12s. 6d. brings this useful and time-saving appliance within the reach of all bee-keepers."

Queries and Replies.

[3887.] *Bees Leaving Hive.*—Can you throw any light on a curious experience I had last Tuesday morning? At about 10.20 a swarm came out of one of my hives and settled on a bush about 20 yards away. Everything pointed to its being a "hunger" swarm, particularly as the bees were very pugnacious. I hived the bees into a skep, but before returning them I opened the hive. I was amazed to find three combs nearly full of honey, and the lump of candy ("Guide Book" recipe), weighing about 2 lb., was quite untouched; also on the centre comb was a small patch of healthy uncapped brood, about 1½ in. across. About ½ pint of bees remained in the hive. The queen (English black) was hatched last summer, the hive ("W. B. C.") is dry and clean, and

the quilts ample, dry, and warm. When packed down last autumn the bees covered six frames; wintering passages were placed along the tops of the frames, and the candy placed over the cluster. I returned the swarm (it weighed 3 lb. 5 oz.), seeing the queen in the process, but the same afternoon they came out again! This time I put them into an empty hive on drawn-out empty combs, placing in the centre the frame containing brood, and a new piece of candy on top of frames. Now they appear satisfied, and remain indoors. Will you tell me: 1. Did I act correctly? 2. Had I better destroy the three combs of honey? 3. Can you explain this, to me, extraordinary occurrence? I have naphthaline in all my hives, and have never had a trace of foul brood, dysentery, &c.—ROYAL NAVY.

REPLY.—1. Yes; you have acted correctly. 2. There is no reason why you

should destroy the honey. Melt the combs, dilute the honey with water, boil it, and use it for feeding the bees. 3. It is difficult to explain the reason for bees leaving their hive in this way. There was evidently something that displeased them. It might be mice getting in, as we have known bees to leave their hives when much troubled with mice.

[3888.] *Using Old Brood-combs.*—Kindly give your opinion through the B.B.J. upon using old brood-combs for surplus-honey work—cutting away the lower portion of frames and combs and converting them into shallow-frames. Will it affect the honey in any way?—GLAMORGAN, Penarth, February 19.

REPLY.—Old brood-combs should not be used for storing surplus honey, as they contain not only the cocoons of several generations, but also the larval excrements. Honey stored in such combs is never perfectly clear, owing to minute particles of refuse matter floating in it, which are easily discernible with a microscope. Comb-foundation is so cheap and so much better from sanitary considerations that it is not worth troubling to keep old combs.

Notices to Correspondents.

BEGINNER (Ilkeston).—*Medicated Candy.*

—The crystals of sugar are not properly dissolved, and would be no use to the bees. Melt it up again, adding the proportion of water recommended.

E. M. M. (near St. Asaph).—*Sample of Candy.*—The candy is too hard and granulated, and was not sufficiently boiled.

ANXIOUS ONE (Bath).—*Re-queening Hive.*—You must get rid of any combs infested with wax-moth. You can introduce a new queen as soon as one is procurable in spring, generally in April. You will find advertisements in the JOURNAL when breeders are ready to supply queens.

ONE INTERESTED (South Devon).—*Old Combs in Skeps.*—1. After two or three years the combs become dark and get black with age. 2. Sections can be prepared now. 3. There is no objection to sections made ready in autumn if clean. 4. Queen-excluder is generally used, and does not interfere with bees at work. 5. There is no objection to golden-syrup tins being used, provided they are clean.

J. CHAPMAN (Belfast).—*Wax-rendering.*—Yours is a very good sample of wax, and can easily be refined to make it fit for any show-bench. The following method is given in "Wax Craft":—"Put the wax, broken into small pieces, into a tinned copper or enamelled iron vessel with

water, adding to every gallon 1½ oz. of sulphuric acid. Heat this, and stir the mass constantly with a wooden stick in order that the wax may be thoroughly blended with the water. Then keep it for two hours at a temperature of 158 deg. Fahr., when the firing can be stopped, the vessel closely covered over, and the mass allowed to cool very slowly. When cold, the cake of wax is removed and the impurities scraped off the bottom; after which the cake is melted again, and can be poured into moulds." The show schedules generally specify the quantity of wax required in each cake, either 1 lb., 2 lb., or 3 lb.

DOUBTFUL (Maidenhead).—*Working on the Non-swarming Principle.*—1. No doubt you would be able to obtain the combs required by advertising for what you want, and whether it would pay you to do so would depend upon the price you give for them, but as such combs are not ordinary marketable goods, the price would vary according to the amount of honey, &c., in them. Failing these, you could try drawn-out combs and feeding as you propose. 2. You cannot make sure of your bees settling on raspberry-trees if there are other trees or shrubs close by. 3. North or north-east. 4. Grip hold of the queen while she is on the comb by the thorax between your finger and thumb, then slide them up off the thorax, pressing them together at the same time, which will give you a hold of the wings. Then take hold of her with the other hand by the thorax under the wings, which will now stand up in a convenient position for clipping.

T. H. SUMNER (Henley).—*Queen-rearing.*—1. The queen has had three days to lay in the comb introduced in brood-nest before she is removed; consequently there would be plenty of eggs for utilising in the queen-cells, which are commenced as soon as the queen is taken away. 2. Yes, the jar with linen over the mouth will do very well. 3. There are other privileges, but you would not be entitled to two visits from an expert. Write to Mr. E. H. Young, 12, Hanover Square, London, W., for particulars as to membership of the B.B.K.A.

Honey Sample.

TWO BEES (Anston).—Sample of honey is very good in flavour and aroma, its only fault being that it has granulated with rather a coarse grain. If it had been stirred occasionally when granulating it would have been smooth and more pleasant to the palate.

* * * Several important letters, &c., are in type, but held over from pressure on our space.

Editorial, Notices, &c.

REVIEWS OF FOREIGN BEE-JOURNALS.

By "Nemo."

Queen-rearing in England and Death's-head Moth.—For some time past Pastor Straüli has been writing a series of articles in the *Deutsche Illustrierte Bienenzeitung* on Mr. Sladen's methods of queen-rearing, the articles being illustrated with engravings of the appliances used and shown in his book on "Queen-rearing in England." These methods are considered much more suited to European conditions than the baby-nucleus plan adopted by some breeders in America, and with them better and more vigorous queens can be raised. At the end of his last article Pastor Straüli relates some recent personal experiences with the death's-head moth which have enabled him clearly to see the way in which it forces itself into a hive. It appears that during a hot and sultry evening in July last his bees were hanging out in large clusters. As it was getting dark he approached close to one hive with the intention of examining it and giving air by enlarging the entrance next day. While so engaged he saw a death's-head moth fly to the doorway and at once enter the hive, and he promptly lowered the entrance-slide so that the moth could not pass out again. Almost immediately a second moth arrived, and made desperate attempts to enter the same hive, and while so doing he was able to secure the insect. He says it appears that the bees are unable to sting these moths. Dr. Krancher adds a note to say that in 1889 he described and illustrated the death's-head moth in *Deutscher Bienenfreund*, and mentioned that he had obtained from a lady bee-keeper in Italy within twelve months no fewer than 250 death's-head moths, all of which had been taken out of her hives. Finally, her apiary of twenty stocks was completely destroyed by them, and the lady gave up bee-keeping in consequence. We have also seen the depredation caused by these moths in the South of Europe, and the way bees try to protect themselves from their inroads. M. Bertrand, in his "Conduite du Rucher," illustrates a barricade extending the whole length of the entrance made by bees to protect themselves from the same moths. This barricade is both ingenious and effective: it consists of pillars made of propolis and wax, leaving openings large enough for bees to enter by, but too small for the moths to pass through, thus affording another instance of the intelligence of bees in adapting themselves to circumstances.

Necessity for a Large Number of Drones.—Adrien Getaz, writing in the *Bulletin de la Société d'Apiculture Romande*, says that when he first commenced queen-rearing he took much trouble in preventing the production of drones of inferior race. Finally, he came to the conclusion that this was time wasted, and recommends the following as a better way. If the bee-keeper desires to have pure Italians, he should purchase and introduce an Italian queen. This done, he can during the season remove all queens in the apiary, and replace them by daughters raised from this Italian mother. It is a matter of no consequence what drones they mate with. Their worker offspring will not be pure, but the drones produced during this and the following year will be pure Italian. In the third year all queens, with one exception, must be replaced by daughters of the original Italian queen, which has, of course, been preserved for this purpose. They will mate with drones from the queens raised the previous year, and will consequently produce pure workers and drones. The same process can be carried out with the choice queens that have been raised. M. Getaz states that American breeders who make a speciality of rearing "golden queens" go further, and suppress one by one all drones not having sufficient "gold" about them. The resulting progeny has, however, often more golden colour than good qualities. To ensure proper fertilisation M. Getaz firmly believes in the absolute necessity of a large number of drones in an apiary and, in consequence, strongly deprecates the suppression of drone-comb.

Planting Trees for Bee-pasturage.—For some time past public authorities on the Continent, when planting trees for shade and ornament, have studied the wants of bee-keepers by using such as are also useful in producing nectar plentifully. In this country, also, Mr. E. D. Till, a member of the B.B.K.A. Council, has done good work in the same direction by inducing authorities to plant such trees, and his introduction of "Arbor Day" has been mentioned in our pages from time to time. In *Le Rucher Belge* M. Douxchamps recommends that such trees be planted in November, the ground being then in just the right condition, and labour is cheaper than in the spring. As certain plants sought by bees in pasture-land have disappeared through the cultivation of fields, M. Douxchamps deems it to be of the greatest importance to apiculture that nectar-yielding trees and shrubs should be planted. Where the authorities have not yet undertaken such planting, it is recommended that bee-keeping societies should bring the matter to their notice. Several works on the subject, written by

Continental scientists, have appeared. Professor Burvenich is the author of a very complete work on nectar-yielding shrubs, and M. J. de Soignies has published a treatise on planting trees along roadsides with a view to benefiting apiculture. In 1900 M. F. Brunerie, Chief of the Department of Practical Agriculture at the Agricultural College of Fontaine, at the Congress in Paris presented a full report on the best methods of providing bee-pasturage in countries where there is a scarcity, and tree-planting was amongst the methods advocated.

Adulteration of Honey in Germany.—It is well known that for a long time honey has been adulterated in Germany to a very large extent, and many artificial products are sold under various names. Not only has glucose been used, but the more modern invert sugar, which consists of chemically-prepared levulose, has been substituted for honey, or mixed with it. This invert sugar passes under different names, such as "fruit sugar," "nectarin," &c. We read in the *Practischer Wegweiser* that at a meeting of bee-keepers M. Frohloff, who manufactures in Hamburg large quantities yearly of Dr. Follenius's invert sugar, now called "nectarin," brought up the question of honey adulteration. Among several questions he asked: "If a member of an association knew that another member was selling adulterated or foreign honey labelled as German honey, should he not inform the committee or bring the matter before the meeting of the Society?" To which the reply was a unanimous "Yes." Another question was: "Should a bee-paper insert advertisements of artificial honey, thus inducing bee-keepers to purchase adulterated products?" To this there came an equally unanimous "No." M. Frohloff thereupon accused a number of well-known bee-keepers who were selling foreign honey and advertising it as their own. He also mentioned several cases of adulterated honey being sold in large quantities. In one of these a large establishment at Visselhövede was accused of selling honey at 56 to 57 marks per 100 lb., and that last year this firm had sent no less than thirty-eight double wagons of this product to Cologne. Samples were submitted by M. Frohloff to analysis, and it was found to consist of 50 per cent. of buttermilk, 40 per cent. of sugar, and 10 per cent. of honey. He also gave the analysis of a number of other samples from different parts of Germany, which showed more or less adulteration. The result of this accusation was that the director of the Visselhövede establishment publicly denied the charge of adulteration, and in reply M. Frohloff not only repeated it, but challenged the latter to take action against him. Action was in due course

taken, M. Frohloff being prosecuted for libel. The whole of the proceedings are fully reported in the *Practischer Wegweiser*, and it was satisfactorily proved that the report arose out of a conversation in which it was stated that some villagers had made up a mixture with the ingredients named in the above analysis and called it honey, but that the honey of the Visselhövede firm was pure and had nothing whatever to do with buttermilk. The judge was very severe in his summing-up of the case, and inflicted a fine on M. Frohloff of 800 marks or imprisonment for eighty days. He also characterised the statement as most reckless, and calculated to make one almost believe that it was done for the purpose of increasing the sale of M. Frohloff's own products. In another case the same defendant was fined 25 marks or five days' imprisonment. Several other cases were adjourned.

A curious result of this trial is that the Visselhövede firm advertised for samples of honey on the market to be sent to them for analysis, stating that so much honey was now adulterated with invert sugar that honest honey-sellers were at a disadvantage. The offer was to test the samples in their own laboratory free of charge. A great many samples were sent in, the larger number of them being found adulterated. Indeed, from those purchased in towns only a single sample was found to be pure. It is quite time, therefore, that steps were taken to protect the public against such fraud, and it is satisfactory to know that chemists have now discovered how to detect chemically-prepared invert sugar when used as an adulterant of honey.

Honey Tea a Useful Stimulant.—In recommending this as a certain and most efficient remedy for a weak stomach, Abbé Delaigues says in *L'Union Apicole*:—To a cup of liquid add a pinch of either sage or juniper, or a mixture of the two, according to the flavour preferred. Make the tea in the usual way and sweeten with honey instead of sugar.

Tunisian Honey-cake.—The following recipe is given by M. Bourgeois in *L'Abeille de l'Aisne*:—Honey, 1 kg. 500 gr. (3 lb. 5 oz.); tartaric acid, 10 gr. (5.6 dr.); bicarbonate of soda, 8 gr. (123.4 grains). The last two must be dissolved separately in a little water. Rum, one liqueur glass; wheaten flour, 1 kg. 500 gr. to 2 kg. (3 lb. 5 oz. to 2 lb. 4 oz.); chopped almonds, 250 gr. (9 oz.); powdered coriander and aniseed, of each a teaspoonful. Dissolve the honey in a water-bath, and add the rum, coriander, and aniseed. Put the flour on the table for kneading, hollowing it out in centre, and add the bicarbonate of soda, then the honey, mix the lot, and lastly add the almonds and

tartaric acid. Knead until all is well incorporated and the paste no longer sticky. Pieces of this paste about the size of a walnut are rolled between the palms of the hands, and placed on a buttered metal baking-plate. The whole of the paste must be made up first, and the cakes are then baked for one hour in a moderately hot oven.

GLAMORGAN B.K.A.

ANNUAL MEETING.

The annual meeting of the above association was held at the Neath Town Hall on Saturday, February 13, at four o'clock, under the presidency of County Alderman Jordan. The attendance was a good and representative one.

The chairman said he rejoiced to find the association in such a healthy condition, doing its work with a determined will and in a very satisfactory manner. This was reflected in the County Council's present action, which raised the grant for the current year to £100. There was, he said, no possible doubt as to the wonderful food value of honey, and to his mind the cottager could very palpably augment his earnings by keeping a few hives of bees carefully looked after.

The report of the executive committee was again a satisfactory document. The Cardiff Show had been a big success in every way, and although the competition in the open classes was very close, local men won the first prizes, proving the unrivalled excellence of Glamorgan bee-pasturage.

In his report the touring expert stated that he had given twenty lectures and travelled twice through the county. Great progress is being made, and foul brood is regularly decreasing. He had paid 434 visits and examined 1,703 hives.

The balance-sheet, too, was not a melancholy item. The income of £153 7s. 7½d. left a credit balance of £17 17s. 5d. Donations had been sent to five shows.

Both report and balance-sheet were passed *nem. con.*

Votes of thanks were passed to the County Council for the grant of £75 and to the Cardiff Horticultural Society for a donation of £4 4s., tents, tabling, &c. The customary votes were passed to the retiring officers, and the following elections made:—President, the Earl of Plymouth; auditor, Mr. John Jenkins, chartered accountant; treasurer, Mr. F. A. Hibbert; secretary (for the eighth consecutive year), Mr. William Richards, who was voted an honorarium of £12 as a token of the appreciation felt for his arduous labours. An executive committee, one member for each of the twelve centres into which the county is divided, was then appointed.

A vote of condolence to the Earl and Countess of Plymouth, whose heir met with an untimely death in India, was carried in silence. It was resolved that the executive committee be empowered to elect local hon. secretaries. The meeting with one voice desired the extension of the Irish Foul Brood Act to England and Wales.

Alderman Jordan then distributed certificates to the third-class experts. Six of the eight examined by Mr. S. Jordan passed through the test. Refreshments were afterwards served, and the proceedings closed with a lantern lecture by the Rev. H. Morgan, B.A. — WILLIAM RICHARDS, Hon. Secretary.

DEVON B.K.A.

ANNUAL MEETING.

At the eleventh annual meeting in connection with the Devon Bee-keepers' Association, held at the Exeter Guildhall on January 22, Colonel Walker (Budleigh Salterton) presided, and among those present were Miss Salmon (Okehampton), and Messrs. S. King and J. Raymond (Tiverton), E. Blackmore (Bradninch), H. Patey (Chillington, Kingsbridge), S. Baldwin (Cowley), Southcott (Newton Poppleford), T. H. Burgess, F. P. Smith, and A. S. Parrish (Exeter), E. C. Shoemack (Starcross), W. H. B. Catford (Axminster), and the hon. secretary, Mr. R. W. Furse (Woodbury).

The annual report of the council of the association was presented. The council expressed regret at the death of Mr. R. H. Wood, of Sidmouth, a vice-president. Some members had left the county during the past year, others had given up bee-keeping on account of old age and infirmity, while some had failed to pay their subscriptions for last year. Thus, starting the year with 264 members, thirty-five had removed and twenty-five new members had joined the association, making a total of 254. While the accounts showed a still larger balance than last year, this was more than accounted for by the fact that, to the council's regret, they were unable to secure a suitable location for the honey show, consequently no show was held and no expense was incurred under this head. The journal had been issued regularly to members during the year, and members have been visited by an expert, whose reports showed a remarkable decrease in the number of apiaries affected with foul brood, showing that, thanks to the good instruction given in the past and the painstaking efforts of bee-keepers to grapple with this scourge, it has, in many places, been got under. Remark was also made on the generally improved appearance of apiaries. The season had proved

to be only a partial one; many did well, while others put it on record as their worst year. The scarcity of the previous year kept the honey market in a healthy state, and the little honey that remained on hand would no doubt be disposed of before next season.

The cash account showed a balance in hand of £12 19s. 1d.

The chairman, in moving the adoption of the report, said it was no great matter that the association had lost ten members during the year; it was of much more consequence that the association had been able to do some good.

Mr. Smith, in seconding, said he was looking to the Seale-Hayne College to spread a knowledge of bee-keeping.

The chairman said he thought the college would form a starting-point for the spread of the industry in Devon. He was glad to know that the agricultural department was taking a far greater interest in bee-keeping than it had ever done any time since he had been associated with the industry.

The report was adopted.

Sir T. D. Acland, Bart., was re-elected president; the vice-presidents were re-elected, the name of Captain Morrison Bell, M.P., being added to fill the vacancy caused by the death of Mr. Wood. Messrs. Shoemack and Raymond were appointed members of the executive council, in the places of Miss Hale, of Northtawton, and Mr. F. J. Goss, of Sidmouth, who retired. The hon. treasurer (Miss Pittis, of Uplyme) and hon. secretary (Mr. R. W. Furse, of Woodbury) were re-elected, and thanked for their past services. A vote of thanks was passed to the Mayor for the use of the Guildhall.—R. W. FURSE, Hon. Secretary.

Correspondence.

The Editor does not hold himself responsible for the opinions expressed by correspondents. No notice will be taken of anonymous communications, and correspondents are requested to write on one side of the paper only, and give their real names and addresses, not necessarily for publication, but as a guarantee of good faith. Illustrations should be drawn on separate pieces of paper. We do not undertake to return rejected communications.

AMONG THE BEES.

MY BEE-GARDEN IN EARLY SPRING.

[7390.] The area of my garden is far too circumscribed to satisfy either myself or my bees, and both they and I wander as far as their powers of flight enable them to roam during these charming days of early spring, when the soft, balmy, vernal airs entice them from their winter home to search far and near for

the first sips of nectar, or the no less valuable "bee-bread" found on those early flowers of spring. All this extended area is my bee-garden, and my bees levy a tax on every flower. February is the threshold of the year, and with it comes at least the first dream of change from winter's frosts and snows. What a delight the past four days have been—18th, 19th, 20th, 21st! I got my first *coltsfoot* yesterday, snowdrops have been fairly abundant for a week, daisies have been plentiful for some time, the whin or gorse has been delightfully yellow and bloomed less or more from November on, the spear points of the crocus are coming up in impressive array, the little yellow point of the primrose is just peeping from among the crisp young leaves, the anemone shows at least in embryo, garden primroses, polyanthuses, and cowslips are exhibiting slight promises of future glory. Trees and bushes are displaying, perhaps prematurely, the swollen bud which later will develop into leaf, leafstalk, or young tendril. The lark a week ago began its merry liting up "at heaven's gate"; the thrush and blackbird have not burst out into full song, but a few trilling notes are poured out occasionally; the crested lapping has appeared, and chants its somewhat wailing double note; and the twittering and chirping of many birds prove that they are even now meditating setting up housekeeping. All evidences of spring!

Now, or at an early date during spring, I am anticipating bees will profit by one or other or all of the following plants and flowers:—

Helleborus niger (*Christmas Rose*).—Coming as it does at a time of the year when blooms are rare, this commonplace flower becomes valuable. Propagate by division of the clumps. They grow freely in any garden soil, and if planted in different aspects the bloom may be prolonged. The beautiful white or pinkish-white flowers tempt the bees.

Primrose (*Primula vulgaris* and *vernis*).—These, in all their garden varieties as well as in the wild form, are lovely spring flowers, and should be grown in quantity. They give a fair amount of both pollen and honey, especially the cowslip. In some parts of the country many acres of our woodlands are perfect sheets of gold with the bloom of the common yellow primrose.

Arabis alpina (*Snow in Summer*).—A crowded bed of this lovely little flower is true to the name by which the plant is commonly known, and during spring I know of few flowers more heartily appreciated by the bees. It can be propagated from cuttings or from seed, and in either way is easily established, and rapidly spreads extensively.

Gorse or Whin.—It is reported that Linnaeus, the celebrated botanist, offered up a prayer of grateful thanks the first time he saw an extensive stretch of this lovely yellow flower. It is a profuse bloomer, and is in almost perpetual flower. At present the stretches of golden gorse form a superb sight.

Wallflower.—Easily grown from seed sown in early summer, and then transplanted in autumn, this lovely flower should be in every garden. Few plants are more pleasant and fragrant, and not many are more beloved of the bees than a bed of single wallflower.

Coltsfoot (Tussilago farfara).—This is our earliest pollen-bearing flower. It blooms profusely on chalky or limy soils in February and March. The flower looks like a small dandelion, and blooms before the leaves develop. On a sunny day a stretch of them is a very busy and harmonious sight and sound, the hum of multitudes of bees making a right pleasant melody in a bee-man's ears.

Butterbur (Tussilago petastis) somewhat resembles its kin, the coltsfoot, in the habit of growth, but the flowers and leaves are very much larger. The flowers are of a pale flesh colour, and are much sought after by bees. It is not uncommon in flower-gardens, but is rather rank in growth and appearance for rearing near small or delicate-growing flowers. It suits the shrubbery or waste ground better, but it is well worth cultivating there.

Snowdrop (Galanthus).—This favourite flower is too well known to need any description. Bulbs are to be purchased cheaply during October and November, and if planted then they will flower the following February and March. They look better and flower better when grown on a grass lawn than when planted in rows on the open soil. During February this year every drooping head had a little crowd of bees round it on a fine day. At the time no other flowers were blooming.

Crocus vernus.—Nothing is easier grown than this flower. Purchase bulbs at the end of autumn, say a hundred each of white, yellow, and blue, and plant them anywhere. Nothing more delightful can be seen in any garden than a large mixed bed of these charming flowers. They are simply loaded with bees on a fine day, and to see these indefatigable workers loading up their pollen-baskets is, to me, one of the chief joys of early spring.

Barberry.—This flowers in favourable positions in early spring. They show a rich profusion of flowers, and bees located near where they are grown plentifully have a good time of it if weather is favour-

able. Bushes are easily established, grow in almost any kind of soil, and are to be had cheap from any nurseryman. While they yield only a small supply of honey, they afford much pollen.

Hazel Catkins.—Some years ago a wordy war went on for some time over the value of the hazel as a pollen-yielder. One side maintained it was worthless, while the other side set it down as useful. One kind is good, another is not; but as willows bloom freely about the same time, and bees prefer them for good reasons, the hazel catkins are often neglected. The tree grows in profusion in some places.

Willows.—Fortunate is the man who has his apiary near a profusion of willows. In early spring I know of no other plant or flower which so stimulates bee-breeding as the pussy willows. Standing listening to the merry hum of bees on a gathering of these is a perfect delight. In a good year the supply of nectar is copious. For pollen it is A 1.

Sycamore.—Perhaps the quality of this honey is not first-class, but its stimulating effect on the bees is all that can be desired, as the quantity supplied is very considerable. For pollen, too, its peculiar winged flowers are very useful. Following the willow, it comes in very handy as a natural brood-rearer.—D. M. M., Banff.

BEE-STINGS AND RHEUMATISM.

[7391.] I think you will receive from the wife of a friend of mine a letter on the bee-sting cure. I have advised her to write to you, knowing that you are always ready to afford any information you can either from personal knowledge or through the medium of the B.B.J. I also write to you in case she may not be able to put the matter clearly before you. She wrote to me about three weeks ago telling me that her husband, who suffers badly from sciatica or rheumatism, wished to try the bee-sting cure; that his medical attendant had commenced with eight stings, which appeared to have had no effect; and could I assist her in any way? I at once sent her copies of the B.B.J. of December last in which appear the results of the inquiries on the subject instituted by Dr. Ainley Walker, Professor of Pathology, &c., at Oxford. I drew her attention to one of the deductions drawn by the professor which appeared to apply to her husband's case, viz., "that in the case of a rheumatic patient no appreciable result from the stings is felt at first"; also, that Dr. Terc, quoted by the professor as having studied the subject and having had practical experience in its treatment, affirms that "every case, whether simple or complicated, can be cured. It requires only perseverance and

intelligence on the part of the patient." He might have added "on the part of the doctor" as well. Acting on the above, the medical gentleman has continued the treatment, having administered seventy-one stings up to date—eight, thirteen, fifteen, sixteen, nineteen—but the patient is no better, and in addition to the rheumatic pains he has had the prolonged agony of over an hour on the last application of nineteen stings; also, there is no cessation from the constant itching, which gives him no rest day or night, except with the help of bromide, which the doctor has given him to obtain sleep. Notwithstanding all this, my friend, who was with me just now, says he is prepared to go on with the treatment, provided he knows that the application is correct. His doctor, not having had any experience in the treatment, is of course at a disadvantage, being in doubt on the following points:—(1) How many stings each time? (2) Increasing in number; if so, to what extent? or (3) similar number each time? (4) Application daily, or with an intermission of one or more days? or (5) application when the itching caused by previous dose ceases? (6) How to be applied, singly, or all together in a glass as in cupping? (7) Does time of year affect bee-sting virus, because in winter the bees are old and their vitality appears low? (8) Does patient's state of health, in addition to the rheumatism, affect the working of the cure, supposing patient is a great smoker and has suffered from nicotine poisoning? My friend and I will be glad of any information or advice you can give us. One method suggests itself—writing to Dr. Terc; but we do not know his address. I forget whether Dr. Walker mentioned it, and I have not my B.B.J. to refer to.

Perhaps you would insert the questions I have sent you in the B.B.J. with the view of obtaining answers from someone who has had practical experience on the subject. Being a thorough believer in the bee-sting cure, I am anxious that it shall not become discredited through any failure from the want of knowledge in the application of the same.—STANLEY EDWARDS, Hawkhurst, Kent, February 10.

[We have a letter from Dr. Terc on this subject, which will appear later.—ED.]

BEEES FERTILISING FRUIT-BLOSSOMS.

[7392.] I have for some weeks been going to write to your paper to inquire about one or two small matters. On reading Query 3882 and the reply thereto in B.B.J. of February 11, I thought I would do so at once, as I

think open lights and doors of glass-houses are deadly traps for bees, which are willing to benefit the owner of the peach-house in return for the pollen they gather and hope to take home. Bees will find their way into a peach-house by the lights and doors if left open, but do not so easily find their way out. The majority find themselves on the wall-plate between the rafters, and after battling and trying to find release, tire and die. Now, to remedy this, I advise all gardeners and others who have peach-houses with glass fitting close on wall-plate just to cut a notch in each pane, and the little bee as she runs to and fro will escape, to return as soon as unloaded. Bees as a rule do not follow the blooms of the tomato.

I find the painter's lamp used for burning off paint a good implement for burning out corners of hives that have had foul brood in them.—ONE INTERESTED, South Devon, February 17.

CARE IN MANIPULATIONS VERSUS CRUELTY IN MISMANAGEMENT.

[7393.] Referring to Mr. G. W. Avery's admirable article in the B.B.J. of February 4 (7372), I for one am pleased that he has taken up the cudgels on behalf of our beloved honey-bee. I think we cannot lay too much stress on the fact that a great deal of the energy of some of the most prosperous colonies is lost through hasty and ill-timed manipulations, as well as the fact that even in this most enlightened age of ours a great deal of wanton destruction is caused by the sulphur-pit, to which may be added the colonies which die owing to the owners neglecting to provide them at the proper time with a few pounds of well-made syrup. I wish also to support Mr. Avery in his protest against the cruelty of allowing bees to suffer from foul brood, and causing this scourge to spread among our apiaries. Some time ago I took one of my hives to pastures new, and unfortunately stationed it near another apiary, the existence of which was unknown to me. During the honey-flow in mid-August, in order to compare results, of course I took the best stock I had. All went well for a few days, until late one evening I noticed many bees flying, and then found that they had discovered a skep in the neighbouring apiary, the bees of which had died of foul brood. The combs were simply rotten, spore-laden, and filthy, and the skep had previously been put out in the garden for the bees in the apiary to clean out to save the trouble of feeding, and also to increase (?), as the owner remarked, his crop of ling honey. I offered to burn the contents of

the skep and treat and liberally feed the remaining ones, but he would not agree to any of my requests. "No," said he, "not any part must or shall be destroyed." Result, needless to say, was disappointing in the extreme, for instead of an increased crop I had a decreasing, diseased population, and it took considerable time to repair the loss and damage, with no finished sections to compensate me for the trouble of taking them over nine miles of heavy country to where the ling was all that a bee-keeper could desire. It is only necessary to say that by the following spring my obstinate neighbour had lost his other colonies by their having contracted foul brood. I heartily agree with our friend Mr. Avery, and doubtless many others will say that the bee-keeping fraternity should combine to make a united stand and place in the forefront at every opportunity that it is now time we had a law to suppress and punish such offences as the one mentioned above. I trust the time is not far distant when an Act will be passed to protect bee-keepers from those who neglect to do unto others as they would be done by, and knowingly inflict unnecessary pain and suffering on our little friends the honey-bees.—J. W. EGGLESTONE, Bishop Auckland.

RESPECTING PARTHENOGENESIS.

[7394.] Referring to Dr. Martin Kuckuck's theory in opposition to parthenogenesis, if I am not mistaken (I have mislaid the copy of the B.B.J. with it in), Mr. L. S. Crawshaw, in his "Cappings" early last year, mentioned a case in his apiary of a queen, supposed to be a drone-breeder, found on examination later to have commenced laying worker-eggs. Possibly you may be able to confirm this.

In reference to Mr. Sladen's bees, I have two stocks of his strain, which have apparently run out, and in consequence of the queens having mated with native drones, the progeny are ordinary looking black bees, a vicious cross, but excellent honey-gatherers. It is questionable whether it is possible to keep the original strains pure unless all native drones are trapped and Italian drones are reared in their thousands. I believe the "British Golden" bees can only be obtained in this way. It cannot be denied that when native queens are crossed with Italian drones the resulting bees are far superior to the native race.—Tom Cox, Yardley.

MODERN HIVE-CONSTRUCTION.

[7395.] I have been much interested in the series of articles on above, now concluded, and I have only one amendment

to offer—viz., on page 57, in speaking of the body-box, Mr. Soal says the measurement given from front to back ($17\frac{1}{16}$ in. outside measure) is "obviously wrong," and in this one point I differ from him. The measure $17\frac{1}{16}$ in. is obviously the right one, as the sketch below will show. To begin with, I always groove my side boards $\frac{1}{4}$ in. deep, with the inside edges of the grooves $1\frac{1}{4}$ in. from edge to edge. This fixes the position of the end boards without any bother when nailing up. Having nailed up the two sides and ends, it is an easy matter to find the width of the strip to fill in space between end board and the closing-in piece, as it fills up the space between the outside of the end board and the end of the side boards,

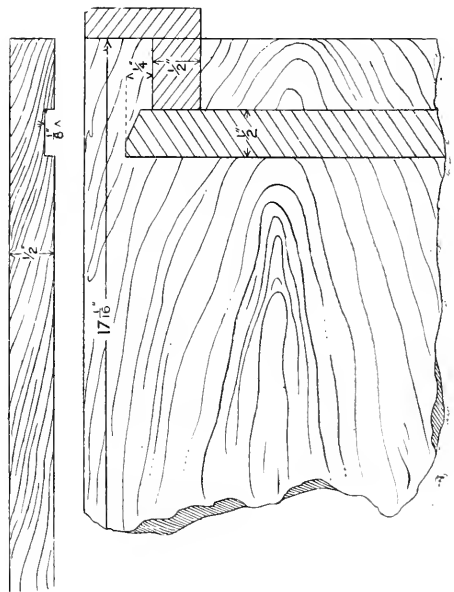

and if a little too wide can be reduced after fixing, with a stroke of the plane. This cannot be done with Mr. Soal's method, as the ends of the side boards project to the extent of the thickness of the closing-in piece. The closing-in piece is cut the full measure of the width of body-box, and nailed on to the ends of the side boards. As the side boards would always be thicker than the closing-in piece, this is correct practice, and not a case of nailing the whole on to the part. I have used both plans, and in turning out a quantity the plan now described is far and away ahead of the other method for accuracy and speed of production. In my sketch I show $\frac{1}{4}$ in. (bee-space) below the ends of the frames, which is an advantage in two ways—saves crushing bees and renders the frames much more easily grasped for lifting out.—D. S. TAYLOR, Grasmere, Ilminster.

CAPPINGS OF COMB.

BY L. S. CRAWSHAW, NORTON, MALTON.

A Querist Flight of Fancy (page 28).—The solution of Mr. Hope's conundrum, so airily launched at me, must, it is plain, be to make the flying-machine in the likeness of a queen-bee, and rub it with queen-bees to give it the correct scent, when vagrant swarms and driven bees will no doubt follow it home! Then, too, aeroplanes will be a transporting delight to the bee-keeper, if they will but enable him to easily reach his many castles in the air! This flighty query is not perhaps unconnected with the afforestation of highways (*sic*) and the consideration in council of suitable trees, a striking "cutting" of which appears on the same page of the B.B.J. They are, as it were, in leaf together! There can be little doubt that the refusal of the Leyton Fathers to plant planes is due to their expectation of the district being so used as dumping-ground for seedlings of *Aero-pseudo-platanus* that they will soon be sick o' more! They are not likely to invest in deciduous property of this kind, if they have expectations, however shadowy, of such coming down to them in heirships! And however desirable that they should decide to leave planes for the shade of posterity, one can do no more than egg them on, for at present the flying-machine is only in the hatching, or "rousing ovation," stage; but if these roosting-places for fledgling aviators are being reared, as stated by a *Standard* tree authority, at "Aviary" Hill by the L.C.C., and if the suggested Queen-of-the-Air design be largely adopted, then every B.K.A. (Societies for Bee-kidnapping Aeroplanists) must instal an avipositor for the use of its descendants! I would bring this suggestion to the notice of the Council in question in the furtherance of their presumed interests but that I fear it would be fruitless to sow good and early seed of the kind upon Leytonstonny ground!

The Discovery of the Origin of Beeswax (pages 31 and 42).—We are much indebted to Colonel Walker for enabling those of us, who lack the time, or the ability, or the access to records, to climb this interesting ladder of chronology. His contribution should prove not only a welcome addition to the libraries of all bibliographers of the honey-bee, but may incidentally set a further seal upon our *entente cordiale* with the Worshipful Company of Wax Chandlers. Not the least interesting reflection is upon the way in which so many of these old-time masters seem to have been just upon the point of making the discovery—to have, as it were, knocked at the portal and then left it without waiting for the opening. In-

terested and careful observers though they might be, their minds were either obscured by old-time beliefs or they lacked the "sesame" of scientific method to open the door to their inductive speculation. And the truth is more wonderful than the wildest guesses of any of these early investigators.

The Ideal Solar Extractor (page 38).—This, when I can find time to finish it, will be mounted on the top of a vertical spindle working in ball bearings. It will be hinged at the foot to give an adjustable angle, and will have side and top reflectors. It will be rotated automatically once in twenty-four hours by clockwork.

Calico Roofing (page 46).—The reason that I size the calico to the roof, as already detailed, is that an exceedingly neat job may be made by this process. The roof is ready for the filling coat of gold size and oil by the following day, and the delay is more than compensated. I should be glad for anyone used to the paint process to try this far cleaner method of fixing and priming the calico.

Colour and Climate (page 46).—Mr. Bullamore's speculations on this subject would seem to be those of a somewhat hastily formed judgment. They hardly seem to be borne out by the colour of various races of bees, some of which in semi-tropical countries are even darker than our own. Generally speaking, too, it will be found that in the colder regions there is in animals a tendency to white as a protective coloration, and this colour is best adapted to prevent radiation of heat. It would, indeed, be ideal human wear in wintry weather, although we appear to appreciate it only as a defence against the heat of summer. I have no doubt that but for the fact of its conspicuity it would be more generally fashionable in the animal world. Mr. Bullamore's view is apparently based upon a comparison of yellow and black bees; but colour must be a very small factor in the struggle, or we might well ask how it is that the yellow wasp is enabled to live so much more strenuous a life. It must be that she is a happy combination of the two colours, and that the yellow saves her life from the heat of the summer sun, whilst the black enables her to absorb the heat of the "long and dreary winter"!

Cruelty (page 47).—If there was one thing in manipulation which roused Mr. Carr's just anger, it was the heedless crushing of the little people. Some of us will never be able to forget him, whilst to-day we can only remember him in tears; and if we could raise to him one special memorial of the heart it would be, I think, to adopt and to urge an increased care and gentleness in dealing with the little toilers, who are, for aught we know, equally loved by the Eternal Father.

Parthenogenesis (page 54).—1. If Dr. Kuckuck's contention—that a drone is the result of the dominant male principle of the father—were true, union between a pure yellow queen and a pure black drone should produce black drones, or drones showing colour-signs of the crossing. Which is, as pointed out by Mr. Cowan, not the case.

2. If queens are fecundated repeatedly, how account for the fact that a yellow-yellow queen continues to breed true to colour in a black bee district? Again, yellow fertile workers similarly situated should give colour indications in their offspring; at the same time, it should be borne in mind that they themselves are usually darker than their queen sisters.

(Page 55, col. 2).—The secretory fluid in the spermatheca would prevent an immediate entry of the spermatozoa, but this fluid may later be displaced by a regular and shoal-of-fish-like entry of the germs into the sac during the period between mating and laying. Comparison with vertebrates is certainly inconclusive. For instance, no amount of such reasoning can explain the miracle of worker-production.

4. It cannot, I think, be established that "an unmated female is never fed by workers." A virgin queen confined by the bees to her cell is certainly fed by them. Parthenogenesis must, of necessity, claim that the bees feed a virgin drone-layer, and consequently that the feeding of fertile workers does not establish their mating.

6. With a normal queen, I have so far only found "drones in worker-cells" where drone-comb was artificially restricted, or where the queen was excluded from drone-comb specially prepared by the bees in a super.

7. This admission by Dr. Kuckuck appears to weaken his case. For if the sex depends upon the possession or lack of maternal vigour, and this in turn rests upon stimulation, alternation of sex would seem impossible in face of the rapidity of production. If the sex control were other than part of a voluntary mechanical process, a rest period would appear to be imperative.

9. Admitting from the opposite point of view the uncertainty of this experiment, I would further suggest that if a virgin queen were imprisoned in a droneless hive from birth, and were later observed to lay eggs, and these eggs produced drones, parthenogenesis is established, even though fertile workers were in the hive.

10. This ironical argument as to the desirability of sickly queens is hardly worthy of Dr. Kuckuck's ability. Even if worker-brood could thus be produced with certainty, an "abundance" would not even theoretically be possible.

Queries and Replies.

[3889.] *Bees in Central Africa.*—I was staying with a friend—the Rev. D. L. Jones, of Cavendish, Suffolk—the other day, and he quite awakened my interest in bees. My home is just south of Lake Tanganyika, Central Africa, and it might be possible to do something there with native bees, if I could be guided in the matter. Mr. Jones thought I could not do better than consult you. We are in lat. $9\frac{1}{2}$ S. and 5,500 ft. above sea-level. A wet season, November to April; 35 in. to 50 in. of rain; temperature, maximum 76 deg. to 86 deg., minimum 45 deg. to 58 deg. The wild bee builds in trees and rocks, but we can seldom get good clean honey. White ants and red (driver) ants might be enemies of a hive, I fear. We can make woodwork locally, if I could procure sketches. I wonder if the wax foundations could stand the long, hot journey—ten weeks by post—and if the zinc excluders would be right size for our bees. Pardon my troubling you.—W. JORAN ROBERTSON, Wakefield.

REPLY.—There would be no difficulty in keeping bees at such an altitude and in such a climate as yours, which we should judge from what you say must be very similar to that of California. You could commence by trying the native bees, and if you find they do not succeed in hives, bees could be got from the Transvaal, or even from Cape Colony or Natal. You will find full instructions, accompanied by illustrations, for making hives in "The British Bee-keeper's Note-book." Foundation is exported from here to South Africa, so could be sent to you without difficulty from Cape Town. You can only tell if the perforations in excluder-zinc are the right size by trying them with your native bees.

[3890.] *Wash for Fruit Trees.*—Will you kindly advise me on the following points? 1. Is there a fruit-tree wash which is harmless to bees? We have lately come to live in this neighbourhood, and have an orchard and excellent garden for the bees, but we find the fruit trees would be better for a wash to rid them of vegetable and animal parasites, though we do not wish to use anything that might be harmful to our bees. 2. Could I, on a warm fine day, take some perforated zinc off the hives, and put on top of calico quilts cakes of candy under the other quilts? I know it is a bad plan to disturb bees at this time of year, but I am afraid they may be getting short of food. The zinc is still on the hives because we moved here late last autumn. The bees travelled safely, and the weather being very bad after we arrived, I took the zinc off the entrances and put the quilts on

over the perforated zinc on the frames. I have taken the BEE JOURNAL since I started bee-keeping, and have gathered much useful information. I packed the bees according to instructions given in the "Guide Book," as I do everything else connected with them. When we lived at Kenley I belonged to the Croydon B.K.A., and was awarded second prize and very highly commended for my honey last autumn at the local show. 3. Is there an association here in Woking, also what sort of place is it for bees? I may say, in conclusion, my husband and I manage our bees with the help of the "Guide Book" without any other assistance, and we find them a most interesting and profitable hobby.—M. G. BRETT, Woking.

REPLY.—1. The caustic alkali wash, which can be used this month with good effect on trees, is quite harmless. It is made in the following manner: Dissolve 1 lb. of commercial caustic soda in water, also 1 lb. of pearl ash in water. Mix the two solutions, add sufficient water to make up to ten gallons. This liquid is sprayed over the trees, and destroys moss, lichen, and eggs of insect pests which infest the crevices. Care must be taken in using it not to let it get on the hands or clothes. 2. You can do it on a fine day when bees are flying, but you could cut a hole in the calico quilt and place a cake of candy over it, so that the bees could get at it through the excluder-zinc, as this would disturb them less. 3. There is no association that we know of in Woking, but there is the Surrey Bee-keepers' Association for the whole county (secretary, Mr. F. B. White, Marden House, Redhill). There are several bee-keepers in your neighbourhood who are able to obtain honey.

[3891.] *Re-queening Hives*.—I am quite a novice. Would you please tell me: 1. Whether if I re-queen my thirteen hives this spring by the "Adrien Getaz" method I shall be able to get them in good condition for the white clover honey-flow, as white clover is the main crop in this locality, and I shall have access to a big stretch in the coming season? 2. As my bees are rather vicious, would it be best to buy early in the spring a nucleus-hive of Italians to rear drones from? 3. What sort of cages are used to hatch queens in by the above method? I send name for reference.—CALPE, Lincoln.

REPLY.—1. It depends entirely upon when the clover honey-flow in your district commences. If you can get drones hatched in April, you can follow the instructions given by M. Getaz, and place a comb containing eggs laid by a selected queen in the centre of the hive destined for queen-rearing. The queen may be fertilised in from three to five days after leaving the cell, although this period is sometimes considerably delayed. Usually

the queen begins to lay two days after fertilisation. Therefore the time required to obtain a fertile queen in the hive, from the time the queen-cells are commenced, is three to four weeks. 2. For rearing drones early you must have a strong colony: a nucleus will not do at all for this purpose. Try queen-rearing with the ordinary bees, and get the pure race if you can. Select your strongest and quietest stock for this purpose. If you desire Italian bees, it would be best to get an Italian queen as early in the season as possible, introduce her to one of your best colonies, and use her for queen-rearing. 3. The cage described and illustrated on page 131 of "Guide Book" is suited for this purpose.

Notices to Correspondents.

A. Z. A. (Barnes, S.W.).—*Spring Bee-work*.—1. Bees can be transferred into clean frame-hives on a fine day early in April. 2. If the bees are working well, and carrying in both honey and pollen, there is no reason for opening the hives to examine them after the inspection in spring. You can ascertain when they are ready for supering by just turning up the quilt without disturbing the bees. If you see that the edges of the cells are white, it is a sign that fresh wax is being added to them, and this is just the time for putting on supers. 3. The best time for re-queening is in June and July, as bees are more numerous during these months. You should, however, ascertain if the bees have already superseded the old queen, as this is of frequent occurrence.

ERNEST E. WILLIAMS (Wimbledon).—*Superfluous Drones*.—If you prick the drone-cells in order to kill the inmates, the workers would have the trouble of removing the dead larvæ. Moreover, any dead brood not removed is likely to decompose and render the hive unhealthy. Much the better plan is to remove the superfluous drone-comb with brood, and replace it with comb containing worker-cells.

J. D. TICKLE (Yorks).—*Moving Bees*.—1. The hives can easily be moved the distance you mention. You will find full instructions as to packing and moving bees in "Guide Book," pages 116-120. 2. C. T. Overton, Crawley, Sussex.

Suspected Comb.

W. H. W. (Bedfordshire).—The piece of comb sent is affected with foul brood. As the stock is dead, burn all combs, frames, &c., and disinfect the hive thoroughly at once before the season starts, or your other stocks may become affected.

* Several important letters, &c., are in type, but held over from pressure on our space.

Editorial, Notices, &c.

REVIEW.

Recherches Expérimentales sur les Chenilles de Galleria Mellonella. By S. Metalnikov. (Paris: A. Schultz. Price 15fr. 50c.—12s. 4d.)—All who have occupied themselves with bee-keeping know of the depredations committed by the wax-moth in a hive. This moth, variously known as *Galleria cerella*, *cereana*, or *mellonella*, has never been much studied, and no one has treated on the anatomy and physiology of this insect, although in respect of this study it is of special interest. As a matter of fact, the larva of the wax-moth is the only animal that feeds on wax—that is to say, a substance which is unable to nourish any other creature. M. Metalnikov has for some time carefully studied the insect, and in this monograph gives a very complete account of his observations on the nutrition and excretion of the larva of this moth. As a perfect insect *Galleria mellonella* does not live long. After pairing, the female lays her eggs in crevices of wax or wood within the hive. In from eight to ten days the grubs emerge from the eggs, and at once commence to run in search of food. They grow very rapidly, and in three weeks attain their full development. On leaving the egg the larva immediately begins to construct a tubular shelter of particles of wax and of silk, spun from a special opening on the lower surface of the head. As the larva grows it enlarges this shelter, and gradually forms a gallery, which passes through the combs and on their surface. This gallery, which is composed of silken webs, serves to protect the larva from the stings of bees, for, being soft, it has no other means of defence. The larva creeps backwards and forwards in the gallery, and never leaves it until it is ready to spin its cocoon. It then makes its way to near the entrance, and surrounds itself with a cocoon, which it fastens to the sides of the hive, and while doing so ceases eating. Frequently several cocoons are congregated together so as to form a compact mass. The winged insect emerges in from ten to eighteen days, according to the temperature. M. Metalnikov has during his experiments succeeded in reducing the chrysalis period to seven days, when the temperature reached 39 deg. to 40 deg. C. (102.2 deg. to 104 deg. Fahr.). The transformations from the egg to the perfect insect therefore take from six to seven weeks (the development of the egg takes from eight to ten days; that of the larva takes from twenty-one to twenty-five days; while the development of the

chrysalis takes from ten to twenty-five days).

The experiments on nutrition showed that the larva fed on the broken-down combs that contained larval skins, excrement of bees, and other nitrogenous matters. Réaumur had already noticed that, failing wax, the larvæ could adapt themselves to other food, and found in his cupboard those of *Galleria* feeding on the bindings of books, dry leaves, and their own excrements. The experiments of M. Bogdanoff (1902) showed that artificially reared larvæ supplied with chemically pure wax, although they lived and went through complete metamorphosis, did not gain in weight or size. Metalnikov has also found that those fed on nitrogenous matters only, extracted from the wax or other substances, died very soon, so that beeswax is seemingly a most indispensable element in their food. He also found that if the proper amount of the nitrogenous element failed the larvæ will even devour their companions. He also ascertained that one of the two constituents of wax—cerine and myricene—was sufficient to keep the larvæ in health, and either seemed equally effective in this respect.

M. Metalnikov mentions that there is another smaller moth which sometimes causes trouble. This is the *Achroia grisella*, which can be distinguished from *Galleria* by its wings, which are of an ashy-grey colour, the head being yellow. The larvæ, which are very similar in appearance to the larger ones, and also feed on wax, can be readily distinguished. The larvæ of *Achroia* cover their galleries so closely with their black excrements that it is impossible to see through the envelope of tissue; while the *Galleria*, on the contrary, do not attach the débris in any large quantities, so that the galleries are always transparent. Another easy way of distinguishing between the two is by touching them. If the larva of *Galleria* is irritated with the finger or some other object, it at once tries to flee, either forwards or backwards. On the contrary, on the least touch *Achroia* remains immovable and simulates death for some seconds, after which it starts off until touched again. Probably bees are deceived by this ruse, and do not in consequence attack this larva.

The work contains a full account of the structure and functions of the digestive organs, the Malpighian tubes, also experiments with injections of colouring matter, and the phagocytes. Interesting series of experiments were made to determine to what extent the immunity of the larvæ to various pathogenic microbes was due to phagocytosis. Fresh cultures were used of *Bacillus subtilis*, *Staphylococcus aureus* and *albus*, *B. Fridlandri*, and many others, but no mention is made of any

trials having been made with foul brood bacilli. The results are given, and are summed up as showing three different cases: 1. Phagocytosis absent or very feeble. In this case the larva dies with surprising rapidity. 2. Phagocytosis exists, but the phagocytes were not strong enough to digest the microbes. In this case the larva survived a longer time, but ultimately succumbed to the disease. 3. Phagocytosis strong, and destruction of the microbes within the phagocytes. In this case the larva easily overcame the disease, and normal transformations took place.

This paper, the most complete on the subject ever published, is fully illustrated, and there are in addition five double-page plates, the last one being coloured. It appears in the "Archives de Zoologie Expérimentale," Series IV., Vol. VIII. (1908), pages 489-588, but is complete in itself and is published separately.

BEE-STINGS AND RHEUMATISM.

In view of the number of inquiries we have had respecting the cure of rheumatism by means of bee-stings, since the articles of Dr. E. W. Ainley Walker appeared in our JOURNAL, the following communication, which we have received from Dr. Terc, will be of special interest. Dr. Terc has now had thirty years' experience with this method of cure, is the recognised authority on the subject, and his success has been remarkable. We hope that sufferers will find the answers to the many questions put to us respecting this treatment, and that they will benefit by the information furnished by Dr. Terc.

DEAR SIR,—I send you with this letter two enclosures, which will give you a sufficiently good introduction to my bee-sting cure. As soon as my health will allow, I shall write down everything I have learnt about the influence of bee-poison on rheumatism, and if my work is accepted by a medical paper I shall send you a copy. If medical publications should refuse it, which is quite possible in Austria and Germany, I will then leave it for a bee-journal to give it publicity.

The bee-stings *help undoubtedly* (with mathematical certainty) *in all cases of real rheumatism*, including very bad cases, but the body of the patient should not be reduced to such a state that he can no longer bear the reaction of the bee-stings, and he should not yet be in the last extremity. I formerly undertook even such cases, which were incurable, and this has proved harmful to me in my practice. Slight and recent attacks are cured easily and quickly, very often by means

only of a few bee-stings. *The longer the illness lasts* and the more serious and advanced it is (chronic rheumatism of the muscles can be very obstinate), the more bee-stings are necessary. For instance, a sufferer who had rheumatism for eight years and whose complaint, in spite of the application of different remedies, returned every winter and continued for months, and showed itself even in the summer, received in the year 1907 about 6,000 bee-stings, and in 1908, when there was a slight attack in the autumn, about 1,200 more stings. The first and second winter after the applications he remained quite well.

I apply each bee with the hand. If I cannot apply the bees to the patient taken direct from the combs they are on, I drive them by means of a feather (which I usually employ) from the comb into a small box provided with air-holes and containing some honey, and which is capable of holding up to 300 or more bees. I take this home, and then set free a number of bees near a closed, not very high window, which is not darkened at the upper part. I then take a bee quickly, very often one in each hand, in such a way that it cannot sting me (catching it by the middle and hinder part of its body), and apply it to the suffering part of the patient. By being pressed the bee always stings, and the poison-bag presses its contents into the wound made by the sting. If one catches the bee slowly and clumsily, and presses it near a window, it empties its poison-bag on the window-pane, and the skin gets very little of it. The poison must penetrate at least into the mucous layer of the cuticle. The sting should therefore be made to enter perpendicularly.

I let the sting remain in the wound as long as the muscles of the poison-bag move—that is to say, as long as the sting penetrates through it: then I withdraw the sting with a pair of tweezers, or sometimes (when in a hurry) with the longest finger-nail, which must be scrupulously clean. The place to be operated on must have been previously washed with a corrosive sublimate solution of 1 in 1,000, and dried with a piece of wadding. The place stung must not be touched for a few days until the sting-channel is healed. When the person is strong and healthy the sting-channel seldom or never gets inflamed, even if the sting-lancet remains in it or if slight hæmorrhage occurs in and around the wound. When the person is more or less delicate or comes from a family which is inclined to tuberculosis, and is stung repeatedly in the same place, or if he has been treated with diseased bees, and the sting-wounds have been infected through them, little pus

tules form in the tissue-cells of the inner skin and give rise to more or less developed sores. Such very unpleasant and regrettable cases happened to me twice, and did me much harm, as they were used against me and my cure by my colleagues, and gave rise to the statement that the body was being "poisoned" with the bee-poison.

With some precautions this can be avoided, and in later years I have had no such cases. Although no one has died from these abscesses, a continuance of the treatment becomes very unpleasant to both patient and operator.

I examine the condition of the patient thoroughly, and do not apply the cure at all when other incurable or dangerous maladies complicate the rheumatism. It requires of course a certain amount of practice to determine the exact conditions.

In each case I commence with one or at most three bees (in the first operation), and wait for the reaction. It has happened with persons seriously ill that after a bee-sting they fainted and showed other serious symptoms, although no one has died in consequence of these.

I may say here that a death which was attributed to *one* bee-sting happened by chance, and was brought about by other causes, and this death would have occurred even without the bee-sting, which in this case was only an unrelated, casual accompaniment, as, for instance, excitement caused by too much consumption of alcohol, &c.

If there is no reaction, two or three more bees can be applied the same day, and on the next three to five bees. According to my experience, in most cases, when healthy persons are stung by bees, a strong, well-developed swelling will occur after the first sting, and the inflammation lasts for two or three days, but in the case of rheumatic persons there is no swelling, and then the patient must really be suffering from rheumatism. It occurs in cases of gonorrhoeal rheumatism, uric gout, syphilitic pains, &c., and I therefore frequently make use of the bee-sting for differential diagnosis of such cases. If at the beginning the swelling does not take place (and such cases should not be mistaken with slight inflammations of the skin which soon disappear, which are only local reactions showing that the skin is very sensitive, and delay the continuation of the cure for one or two days at the utmost), then the cure should be continued and the number of bee-stings increased daily by five to ten or more.

An inexperienced medical man should, however, be careful. I have sometimes applied 100 to 150 bee-stings daily. The first occurrence of the large swelling is

always a favourable sign, but very often this only appears gradually. These swellings may sometimes be accompanied by symptoms of intoxication, which, however, soon disappear, and the cure is then continued until complete recovery, even if thousands of bee-stings are necessary. The characteristic swelling occurs in slight cases after a few stings only, and in grave cases only after from 100 or 200 to 500 or even 1,000 stings. You will find more particulars in the enclosed pamphlets. The bee-stings are to be applied to the extremities in which the fewest veins and lymph-glands are found. One is not so restricted in case of the trunk, but the back is less sensitive to pain than the chest. The best way is to make the applications daily, and in any case not to leave long intervals, one to two days at utmost being sufficient, because the healing of rheumatism is connected with the saturation of the body with bee-poison. As the bee-poison has a local and general influence, I apply the bees, if possible, to the diseased places. The relief, which lasts only a few hours, is often so great that the patients long for a repetition of the stings. If, as indicated above, the fresh sting-channels are avoided, the bees can be applied frequently one after the other on the same parts—knee, elbow, or hand, &c.—because these parts become less sensitive the more the bees are applied. It is only when, through a too long application of bees, the skin becomes less susceptible to the poison that other places must be selected. Sometimes, after the first stings, violent itching occurs, which, however, generally passes off and does not recur. If the irritation is too painful, the skin should be washed a few hours after the sting has been applied with vinegar, or, what is better, with alcohol, and sprinkled with amyloform. Smoking, which in itself is a nicotine poisoning, will not exercise any influence on the bee-poison—at least I have never observed any injurious influence. I forbid, however, during the cure the consumption of alcoholic drinks, because alcohol is a strong counteracting influence to all organic poisons (for instance, snake-poison, which, according to Professor Langer, strongly resembles bee-poison). It is, therefore, best to avoid alcohol altogether during the cure. Whilst a complete bee-sting cure—which should be continued until complete immunity from bee-poison is secured—means a certain immunity from rheumatism for ten to twenty-five years, I notice that in the case of heavy drinkers the immunity disappears quickly, and rheumatism reappears.

The irritation of the skin should not stop the continuation of the cure.

I begin the cure in the spring, when

the temperature somewhat exceeds 50 deg. Fahr., or at least reaches that point. The opening of bee-hives at a lower temperature is dangerous, owing to the brood already present, and which might become chilled and die. I stop late in the autumn, because there is no danger from this cause then. It must also be emphasised that the bees, which were exposed to a temperature of less than 50 deg. Fahr., after coming into a warmer temperature, suffer from the disturbance and have diarrhoea, and easily infect the sting-channel. They must therefore be handled very skilfully and carefully.

To be able to continue the cures in the winter, it would be necessary to keep very strong colonies (strengthened by uniting them) in a cellar at about 32 deg. up to 41 deg. Fahr. at most. From these, bees could then be taken for poor people. The rich could be freed from their rheumatism in Egypt and other southern countries also by means of bee-stings, as the application could be made better and more thoroughly in such climates. Our season lasts from March up to the end of November. In urgent cases I have also applied bees in winter, if it was a mild one.

I hope I have made clear to you the most important matters in connection with the application of bee-stings.

To undertake this cure, the practitioner must have a certain amount of assurance, experience, and full confidence in the good results of the bee-poison, while the patient must have absolute confidence in his physician.

In this way, and without being presumptuous, I would say that I have obtained splendid results, and have even completely cured in four years with about 15,000 bee-stings a case of arthritis deformans (Miss Josefine Gondof) which had existed for two years, and was very pronounced. The patient was able to leave her bed after the first three months. The further treatment was only combating the slight relapses, which, of course, I expected with this phase of rheumatism, which, however, is not regarded as rheumatism by many authors.

I also enclose—not for the sake of myself, but for the sake of the cause—extracts from two letters of thanks which recently appeared in the *Gratz Tagespost*, and are quite true:—

Only sympathy with fellow-sufferers induces me publicly to thank, in spite of his prohibition, the Marburg physician, Dr. Terc.

As far back as 1880 he freed me, through the application of over 5,000 bee-stings, from an obstinate rheumatism of the shoulder joint. I remained cured for twenty-five years. In the year 1906 the rheumatism gradually reappeared, and became so violent that I had to stay in bed for nine months.

Owing to my advanced age (sixty-four years) I was rather disinclined to undergo the bee-sting cure; but after all other treatments had been tried

in vain, and the pains became more and more severe, and I became very much reduced in strength, I underwent in the spring the much-dreaded cure. The result was that I left my bed in three weeks, and now, after having completed the cure, I am quite well again.—(Signed) ANTONIE SKRABE, Poultry Dealer, Marburg.

Full of satisfaction and gratefulness, we thank with all our hearts Dr. Terc, of Marburg, for the successful treatment of our eighteen-year-old son, Charles Suptka, who has been suffering from rheumatism of the joints for eight years, and in spite of having used for many years thermo-baths, and undergone various other treatments, always grew worse, and would have succumbed to the malady had he not been cured by the successful application of Dr. Terc's bee-sting remedy. Out of sympathy with all sufferers from rheumatism, we can recommend thoroughly the application of the bee-sting cure. — (Signed) CHRISTOF and FRANCISKA SUPTKA and Son CHARLES.

You are at liberty to use this communication in any way you please, and with best wishes I remain,—DR. TERC, Marburg, February 15.

[The pamphlets referred to by our correspondent are: "Ueber eine merkwürdige Beziehung des Bienenstiches zum Rheumatismus"; this is an article which appeared in *Wiener Medizinische Presse*, No. 35, 1888, describing in technical terms twenty-three different cases of cures; and "Der Bienenstich als Heilmittel gegen den Rheumatismus," a report in the *Steirische Bienenvater* of an address given by Dr. Terc at a meeting of the B.K. Society on February 11, 1904. Also "Das Bienengift in der Heilkunde," from the same journal of May 1, 1907, which was reviewed in B.B.J. of November 7, 1907, page 441.—Ed.]

W. B. CARR MEMORIAL FUND.

Amount already acknow-	£	s.	d.
ledged	11	11	0
Lieut.-Col. H. J. O. Walker	2	2	0
C. T. B. and K. T. B.....	1	1	0
L. S. Crawshaw	1	1	0
Rev. R. M. Lamb.....	0	5	0
	£16 0 0		

Donations may be sent to Editor, B.B.J. Office, or to Secretary, British Bee-keepers' Association, 12, Hanover Square, London, W.

NOTTS B.K.A.
ANNUAL MEETING.

Despite the terrible weather there was a considerable attendance of members at the annual meeting of the Notts Bee-keepers' Association, which was held at the People's Hall, Heathcote Street, Nottingham, on March 6. Mr. Harry Wyles, of Cropwell Butler, presided, and among those present were Messrs. W. S. Ellis, W. H. Windle, W. Darrington, R. J. Turner, G. Smithurst, G. E. Puttergill, J. Bickley, H. Vessey, J. C. Wadsworth, A. H. Hill, W. C. Moulton, H. Dickman,

W. P. Meadows, G. Hayes (secretary), Dr. Willoughby, Mrs. Hayes, Mrs. Turner, and Miss Pugh.

The annual report recorded continued prosperity and an increased membership, the latter having advanced from 207 to 269 during the year. Reference was made to the deaths of Mr. P. Scattergood, who had been connected with the association since its inception in 1884; of Viscount St. Vincent, who, a practical bee-keeper and president of the association, had helped them in many ways; and of Mr. S. W. Marriott, a veteran bee-keeper and valued colleague. The report touched upon the shows held in the district, and the lectures given under the auspices of the association in various villages. No fewer than 225 apiaries had been visited, and 698 stocks examined. Only 4 per cent. were found with foul brood. Arrangements had been made for the annual show to be held with the Mansfield Horticultural Society this year.

The financial statement showed an income of £100 9s. 7d., including £4 4s. 10d. brought forward. The expenses were £85 15s. 2d., leaving a credit balance of £14 14s. 5d.

Speaking on the report and balance-sheet, the chairman expressed pleasure at the highly satisfactory position of the association, and remarked that bee-keeping exercised a refining influence on the lives of those who were engaged in the industry.

The report and balance-sheet were adopted.

The Duchess of Portland, who has been president of the association for the past two years, was re-elected; Mr. George Hayes was re-elected secretary and treasurer; Mr. W. Darrington was re-elected auditor. Messrs. Hayes and Pugh were re-elected representatives to meetings of the British Bee-keepers' Association in London.

The committee was appointed as follows:—Dr. T. S. Elliot, Messrs. W. Adams, T. N. Harrison, A. G. Pugh, G. E. Puttergill, W. Darrington, G. Smithurst, H. Dickman, G. White, F. G. Vessey, J. C. Wadsworth (Newark), G. Marshall (Norwell), J. Bickley (Chilwell), and W. H. Hoyte (Nottingham).

During the meeting two competitions were held, the first for the best single 1-lb. bottle of granulated honey of any year and the best bottle of liquid honey. Mr. A. G. Pugh secured the premier award in both classes, whilst Mr. H. Wood and Mr. T. Marshall obtained the second prizes in each class respectively. In the evening the medals, pendants, and certificates won at the annual show were distributed, and some interesting discussions and papers of interest to bee-keepers followed.—Geo. HAYES, Secretary.

HONEY IMPORTS.

The value of honey imported into the United Kingdom during the month of February, 1909, was £1,767.—From a return furnished to the BRITISH BEE JOURNAL by the Statistical Office, H.M. Customs.

Correspondence.

The Editor does not hold himself responsible for the opinions expressed by correspondents. No notice will be taken of anonymous communications, and correspondents are requested to write on one side of the paper only, and give their real names and addresses, not necessarily for publication, but as a guarantee of good faith. Illustrations should be drawn on separate pieces of paper. We do not undertake to return rejected communications.

NOTES BY THE WAY.

[7396.] The month of March has not come in with rough winds, but the climatic conditions are suggestive of the polar bear rather than the lamb. Last week ended in a blizzard that nearly equalled in severity the great blizzard of 1881, and to-day (8th) the snow is nearly melted, the sun is shining, and the bees are humming. I have just been round the apiary, and at every hive save one the bees are taking a cleansing flight; many are also visiting the water-troughs, showing that breeding has commenced and the season of 1909 is opening, therefore bee-keepers must also arouse themselves lest procrastination be their undoing.

To Beginners.—Having brought your stocks safely through the winter, do not let them starve now; a cake of soft candy or a frame of honey should be given with as little disturbance to the bees as possible. Do not open hives to see how large the patches of brood are; rather be guided by the activity of the bees in carrying in pollen on sunny days.

Orders for hives and appliances should be placed early, but spring-cleaning may be left until next month, for if bees were properly attended to last autumn April will be quite early enough to disturb them.

I am sorry to see that our Canadian brethren, in spite of their large staff of inspectors, do not appear to reduce the foul brood pest within their borders. For many years they have had Foul Brood Acts of even drastic powers, yet they have to acknowledge the fact that a large percentage of their apiaries are still affected with the pest. There appears at present little chance of the inspectors finding their posts sinecures.

Many of our American cousins pin their faith to the rousing effects of

"shaking" their bees, practical men believing that bees will gather honey faster if "shook up." A writer affirms that an indolent colony will, after being shaken off the combs in front of the hive, start work at once in the supers with the vim of a new natural swarm. Has anyone in this country tried anything of the kind?

Glazed Sections.—I hope that Mr. Carver's section-glazing machine may help to improve the sale of comb honey, and induce British bee-keepers to take the trouble to glaze their sections before putting them on the market. If comb honey was always glazed before marketing I believe there would be a far greater demand for it than at present. Glazing not only protects the comb from damage, but preserves the honey from dust and fly-marks, which so often mar the appearance of unglazed sections seen in shop windows. It also protects the honey from absorbing bad or noxious flavours from other strong-smelling foods placed near it. I work for section honey principally, and invariably glaze every section sent out, finding that tradesmen prefer handling them when prepared in this way. Buying the glass and paper in large quantities will effect a saving, as both will keep indefinitely in a clean place; while the outlay is very small, and that glazed sections will bring 1s. per dozen more than unglazed is the experience of—W. WOODLEY, Beedon, Newbury.

COLOUR-INHERITANCE IN BEES AND MENDEL'S LAW.

[7397.] The lucid explanation of some of the remarkable effects of Mendel's law of inheritance in the B.B.J. editorial of February 11 induces me to offer a few notes on colour-inheritance in bees which may be of interest to observers during the coming season.

In the honey-bee the golden (or yellow) and black colours of the integument seem to be the only pair of "allelomorphic" characters, either member of which can be readily recognised. My experience in breeding "British Golden" bees shows that neither golden nor black is "dominant," but that the "heterozygote" is of an intermediate colour. Nevertheless the fact that golden queens bred from a parentage producing some golden and some intermediate females gave a larger proportion of intermediates (to goldens) than did golden queens bred from a parentage producing only goldens points to the possibility that some of the former golden queens may have been heterozygous, and therefore that the golden colour may sometimes be dominant. Irregular dominance like this has been observed in the cases of a few animals and plants.

An alternative explanation to that of irregular dominance is that golden females may sometimes be produced in a parthenogenetic manner. If this explanation were true, queens and workers might be expected to inherit less from their fathers than from their mothers, and therefore the fact that no golden bees have been produced in the nearest apiaries to Ripple Court Apiary lends strength to it. Professor Bateson, the well-known authority on Mendel's law, says: "There are a few examples of offspring coming true to the maternal type which rest on perfectly sound evidence. In these cases we are evidently concerned with some distinct phenomenon of parthenogenesis, stimulated apparently by fertilisation, but as to the nuclear processes concerned we know nothing" ("Progressus Rei Botanicae," 1st Band, 1906, page 400).

Two years ago Professor Bateson was kind enough to write me on the subject of heredity in bees. After disclaiming any special knowledge of bees, he said: "If, as I assume is true, the male bees are parthenogenetic, the sons of queen A (though she was fertilised by drone B) will be pure A. But the sons of queen A B may be expected to be in equal numbers A's and B's. Nevertheless, as according to modern ideas (*e.g.*, Castle) all spermatozoa of males are bearing 'femaleness' (which I assume is a working hypothesis), something very unusual is occurring in the distribution of the sex character itself, so we may perhaps expect some unusual disturbance of the normal distribution of other characters among the sexes."

Unfortunately the study of heredity in bees is rendered difficult by our inability to mate a queen with a particular drone. As regards colour-inheritance, we at present know little beyond the fact that segregation of golden and black does occur. I have had several striking examples of this from intermediate-coloured "British Golden" queens, which I believe were mated by golden or bright intermediate drones; they each gave some golden, some intermediate, and some black workers.

The study of the laws of inheritance of golden and black colour seems to be the most promising quarter from which light is now likely to be shed on heredity in bees. Fresh knowledge about heredity in bees may be of the greatest value, as it has been in the past, in helping to unravel the general problem of heredity, which is one of the most fascinating lines of inquiry of the present day.—F. W. L. SLADEN, Ripple Court Apiary, Dover.

[As the study of heredity and variation, now called genetics, is a new one, there are several terms used in the above in-

teresting communication which may not be familiar to all our readers. *Gametes* are the male or female cells. A cell formed by the fusion of a male with a female cell is spoken of as a *zygote*. *Heterozygote* is a zygote formed by the union of two dissimilar gametes. Mendel conceived pairs of unit characters in cases where the heterozygote did not resemble the dominant, but had a character peculiar to itself. Such pairs of unit characters are now called *allelomorphic* pairs. We hope these few explanations will be useful in assisting some of our readers to better understand Mr. Sladen's letter.—ED.]

THE FOOD OF SOME BRITISH BIRDS.

[7398.] I have just read the review (page 72 of the B.B.J.) of the paper on the subject of "The Food of Some British Birds," issued by the Board of Agriculture and Fisheries, and beg respectfully to take exception to the statement made therein that "it is a pity also that so many birds well known to be harmless should have been destroyed in order to examine the contents of their stomachs." If your reviewer will do me the favour to read page 2 he will find that I have distinctly stated that "in nearly all cases the birds were presented to the Grosvenor Museum, Chester, and as they passed through my hands for preservation post-mortem examinations were made and the stomach contents carefully examined and tabulated." Had I taken the course invariably adopted in similar institutions I should have ordered the carcasses to be cremated or thrown into the refuse heap. But because I chose to investigate the nature of the food contents of the stomachs my critic has been short-sighted enough to express anger and accuse me of the promiscuous destruction of birds. I am not a pachyderm, but thick-skinned enough to tolerate the reviewer's grumble; at the same time I must protest against being unjustly branded as a foe to our feathered friends.—ROBT. NEWSTEAD, Liverpool School of Tropical Medicine, February 26.

THE "W. B. C." HIVE.

[7399.] An esteemed writer to the B.B.J. (page 201, May 21, 1908) made out a strong case against appliance dealers making the above hive, and asks—What is a "W. B. C." hive?

On behalf of some of the appliance dealers, and writing from a humble yet independent position (being neither a buyer nor a seller of hives), I should like to say that there is a great improvement in the workmanship of hives exhibited at the "Royal" Show now compared with

those shown ten or eleven years ago. Those staged at the "Royal" when held at Birmingham in 1898, with the exception of the first-prize exhibit and one or two others, were a discredit to the makers. What a contrast at the "Royal" in 1907, when it was a pleasure to look at the whole of the hives staged, all being well made with good material.

The best hive in my opinion is a "W. B. C." made from the instructions given in the "Guide Book," having four English oak legs with 1-in. and ½-in. floorboards, outer case and lifts well dovetailed, nailed, and put together, with paint at the joints, with the simple method for clearing supers of all the bees (introduced by "D. M. M., Banff") included. Also, in addition, the claustral porch, which can be made by almost any amateur; the materials alone need not cost sixpence more than an ordinary porch. I can assure anyone contemplating having the claustral porch that there are other distinct advantages than those mentioned in the "Guide Book."

This is my ideal, and one I should like to see adopted as the standard hive, to the advantage of makers, buyers, experts on tour, our little friends the bees, and a fitting memorial to the late "W. B. C."—DAVID HANCOX, Deddington, Oxon.

THE LATE W. BROUGHTON CARR.

[7400.] It was with deep regret I learned of the passing away of our mutual friend Mr. Carr. I never met him, although we both looked forward to such an event taking place soon; but now it never can. I feel I have lost a friend, and indeed in our written intercourse for over a dozen years the word had its full meaning and its best. Of all things I think he was a man of peace. The sharp word that engenders strife he shunned using; the quiet word that made for friendship he delighted in.

The success of the *Journal* and *Record* was very dear to him, and he delighted in all that went to enhance their value. His gentle guiding hand will be missed at the helm, and his untiring good nature will be a feature difficult to replace.

Mr. Carr's ripe experience commanded high respect, while his extended knowledge of every phase of bee-keeping must have materially lightened your onerous duties in conducting both papers.

About the close of last year he wrote saying he was much the better for his trip to the North, but about a month ago he mentioned having a cold which was difficult to shake off. That was his last letter to me, and now, "after life's fitful fever, he sleeps well," having served his generation well and long. Let me

express my sympathy and condolence with you in the loss of your friend and colleague.—D. M. MACDONALD, Banff.

[7401.] While sending enclosed order for books, I should like at the same time to add a few words in order to express my deep sympathy for the very sad loss you have recently sustained in the death of your much-valued friend the late Mr. W. Broughton Carr, which sad news I was very sorry to see in your journal. I can quite understand what a severe loss this is to the Bee World in England, for all who love bees must feel how much they owe to the life and work of so noble and great a man. My deep esteem is only that of an unknown unit of the outside public, but I find something profoundly attractive in a character such as his, and I hope some day to be able to give some practical expression to this feeling by helping to make the "W. B. C." hive better known to Italian apiculturists.—M. D. FLEISCHMANN, Villino Milano, Anzio, near Rome.

QUEEN-REARING IN BABY-NUCLEI.

[7402.] Of late I have noticed some criticism of small nuclei (baby mating-boxes, if you please) from certain quarters to the effect that these small mating-nuclei are being given up by many as too much trouble to look after, and that strong three and five frame nucleus colonies are preferred.

The criticism of this economical small mating-box plan of queen-fertilisation, you have perhaps noted, comes mainly from large honey-producers—from men who own from 300 to 500 colonies of bees. For such large producers the strong nuclei may be more satisfactory—but look at the number of bees and the quantity of extra bee-material required! Simply out of the question with the one owning perhaps but twenty colonies.

The large producer will think nothing of breaking twenty-five colonies into full-framed nuclei both for increase and queen-rearing; but what is the little fellow with a queen trade to do? Can he afford to sacrifice even ten of his full colonies in this fashion? No; he must economise, he must not use so many bees in his mating-nuclei, or he will not have strong colonies enough left to supply him with queen-cells, drones, and extra bees for his queen-raising operations.

Those who have most sweepingly condemned small mating-nuclei overlook the fact that there are thousands of bee-keepers who do not own twenty-five full colonies each in all, yet have a desire to rear a few queens for their own use and have a few to sell. To such, it must be

admitted, the small baby-nucleus plan is a boon: it is economical, efficient, satisfactory, and possible to the small producer.

Small mating-nuclei are not so much bother after all when expense is considered. All that is required is regular feeding of thin sugar syrup once a week or so when honey is not coming in; that is all.

The twin mating-boxes are provided with convenient feeders, and the task of giving each box a cupful of syrup once a week is not a great one, is it now?—E. L. PRATT, Swarthmore, Pa., U.S.A.

KEEPING BEES NEAR RAILWAYS.

[7403.] I cannot allow Mr. A. Sunley's letter (7377, page 58, February 11) to pass without comment. I should advise him to move his bees miles away from their present position, otherwise, if there are many trains passing his apiary, he will soon find he has none to move, especially as he says every train that passes kills hundreds of bees.

Now, I am fully satisfied that there are better places in which to keep bees than railway embankments, but at the same time I must candidly say I believe Mr. Sunley is only joking. You will see, Sir, by the enclosed photo that my bees are much nearer the railway than Mr. Sunley's, and I have never observed any loss in this direction, although I am as keen an observer of bees in flight as most men. I may add that trains are continually passing here night and day, and my bees suffer no ill therefrom. I ran three hives only for honey in 1906, and obtained honey as follows:—No. 1, 137 lb.; No. 2, 112 lb.; and No. 3, which was a swarm, gave 40 lb., so that the trains did not do my bees much harm.

The hives shown in photograph sent were all swept away by the storm of February 22, 1908 (twenty-five in all), but I hope to have them all stocked again, and placed much nearer the railway than 100 yards. Will Mr. Sunley please say what effect motor-cars and aeroplanes have on his bees?—WORKER.

[It is quite a common practice on the Continent to keep bees near the railways, and the railway authorities give every encouragement for doing so by offering prizes. They also arrange for courses of lectures and instruction in bee-keeping to be given from time to time to any officials who like to take advantage of them. We regret that photo is not clear enough for reproduction.—ED.]

NOVELTIES FOR 1909.

THE "SILVER" REVERSIBLE FLOORBOARD.

Mr. E. H. Taylor, of Welwyn, is introducing in his 1909 catalogue a new reversible floorboard, which was inaugurated

two years ago by Mr. J. Silver, of Croydon. Last year Messrs. James Lee and Son, Ltd., exhibited a hive with a floorboard of this description at the Newcastle Show, obtaining a first prize. We understand that Mr. Silver suggested to Messrs. Lee and Son and Mr. Taylor this idea, and last spring ordered some hives fitted with this floorboard from both the above firms for the Isle of Wight. Mrs. Seadon has adopted a similar floorboard for a new pattern hive she is bringing out.

The floorboard on one side is of the ordinary flat type, and on reversing it has a 3-in. air-space for wintering or for

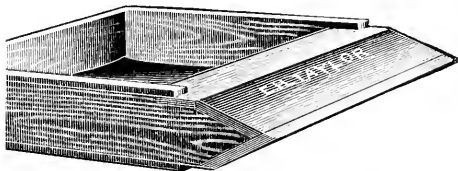

giving extra ventilation in hot weather to prevent swarming, while for moving stocks to the heather or to an out-apiary, or sending by rail, it is simple and all that is required for safe transit, with the advantage that the flat floor can rest on straw or other soft material. A queen-excluder below the brood-nest in summer will prevent comb-building. In actual working, however, it is found that with a full-width entrance and plenty of room in supers very few stocks will build comb below.

WEATHER REPORT.

WESTBOURNE, SUSSEX,
February, 1909.

Rainfall, .32 in.	Minimum on grass,
Heaviest fall, 10 in.	18° on 23rd.
on 9th and 10th.	Frosty nights, 21.
Rain fell on 7 days.	Mean maximum, 42.7.
Below average, 1.59 in.	Mean minimum, 30.3.
Sunshine, 112.3 hours.	Mean temperature,
Brightest day, 22nd,	36.5.
9.1 hours.	Below average, 1.6.
Sunless days, 4.	Maximum barometer,
Above average, 29.2	30.449 on 22nd.
hours.	Minimum barometer,
Maximum tempera-	29.403 on 10th.
ture, 53° on 3rd.	
Minimum tempera-	
ture, 23° on 14th.	
and 23rd.	

L. B. BIRKETT.

FEBRUARY RAINFALL.

Total fall, .78 in.
Heaviest fall in 24 hours, .39 in. on 9th.
Rain fell on 7 days.
Below average, .97 in. for the month.
W. HEAD, Brilley, Herefordshire.

Queries and Replies.

[3892.] *New Edition of "Guide Book" and "Claustral" Hive.*—I am just starting bee-keeping, having owned one colony for twelve months, and only commenced taking the B.B.J. last January. I have the "Guide Book" (sixteenth edition), but cannot find answers to the following questions:—1. Is there any added matter in the nineteenth edition of "Guide Book"? 2. What is the advantage, if any, of having the frames at right angles instead of parallel to entrance? 3. What is about right size of carrying-box for driven bees for use on bicycle? 4. In what back number of B.B.J. has the "claustral" device appeared with dimensions? 5. Which is the best and simplest way of transferring bees from frame-hives to new frame-hives without using old combs? 6. Is foundation-making machinery manufactured in England, and by what firms? Kindly reply through B.B.J. Thanking you in anticipation, &c. —CERA, Marsh Gibbon, Bucks.

REPLY.—1. The sixteenth edition of "Guide Book" appeared in 1900, and since that time the advance made in bee-keeping has been so great that the book has been twice revised. The nineteenth edition was almost entirely rewritten, new illustrations were introduced, and an entirely new set of tone-blocks engraved. Modern methods of queen-rearing are described, and all the latest discoveries respecting diseases of bees are fully treated, there being nine additional pages in this chapter alone. The work has been enlarged to 226 pages, and is more profusely illustrated than any previous edition. 2. Better ventilation between the combs, and less liability of dead bees obstructing the entrance, than with frames running parallel to it. 3. On a bicycle bees are better carried in skeps, as being lighter for the purpose (see "Guide Book," page 155). If boxes are used they should not be any larger, and should be made of very thin material. 4. In B.B.J. of February 16, 1905 (page 71), and it is also illustrated and described in "Guide Book" on page 50. 5. Prepare a hive with frames fitted with comb-foundation, place it on the stand occupied by the old hive, then take each frame separately and shake the bees off into the new hive. It would facilitate matters if you found the queen and placed the comb with her in the centre of new hive, and then shook the other bees on to the frames, as they would take more readily to the hive if this were done. When you have got all the bees off the combs, cover up with quilts, and proceed to feed slowly. Any bees adhering to the old hive can be brushed off on to the

alighting-board in front of new hive. 6. We know of no manufacturer of such machinery in this country.

[3893.] *Doubling for Extracted Honey.*—*Re the query in B.B.J.* of February 25 (page 80, No. 3888) on using old brood-combs: 1. Is it not impossible, in working for extracted honey on the "doubling" system, to avoid extracting from combs in which brood has been reared? 2. In many cases when the hive is doubled the queen does not go up and use the second chamber for egg-laying; and so, within a month from the date of doubling, this chamber is almost clogged with honey. 3. The suggestion in the "Guide Book" that the two brood-chambers may be kept exclusively for breeding and a couple of shallow-boxes added for extracting from would get over the difficulty if one could be sure of the queen utilising the upper brood-box. 4. Many writers and books (the "Guide Book" included) recommend doubling a hive (having first placed excluder-zinc over the lower chamber), and then using the upper chamber for extracting from as soon as the brood has hatched out. This system is undoubtedly very largely practised by bee-keepers. An editorial opinion on this very important subject would be of great interest to many readers.—A READER OF BOTH B.B.J. AND B.K.R., Belfast.

REPLY.—1. If you intend doubling for the purpose of preventing the bees from swarming, you would have to extract from combs that had been bred in. The extracted honey, however, would contain some of the impurities from the cells, and the more frequently the comb had been bred in the more of these impurities there would be. This method of doubling is generally adopted as an expedient to prevent swarming. 2. With very strong colonies—and only such should be used—we have never found any difficulty in getting a good, prolific queen to use both chambers for brood. 3. The method mentioned in the "Guide Book" (page 62) refers to using two body-boxes for brood, and similar ones with standard frames above them for extracting from, not shallow-boxes. 4. As stated above, this is resorted to in order to prevent swarming, but without doubt clean combs used exclusively for storing yield the clearest honey.

Notices to Correspondents.

ALONE (King's Lynn).—*Bees Dying in Winter.*—1. Bees cannot move about searching for food in the winter months, but will sometimes die of famine with food only a few inches away. From your description it is probable that cold has

been the cause of your bees dying. In skeps frequently a small cluster of bees is unable to generate sufficient heat to sustain life. We hear of cases similar to yours every winter. 2. The pieces of the insect sent are those of a female humble-bee which had got into the hive. 3. We do not know where in this country you can get the wire caps to place over hives when manipulating, described on page 39, as these are made in the United States of America, but you will find the description of a small tent used for the same purpose on page 163 of "Guide Book," and which from the illustration you could easily make yourself.

J. M. M. (Eccleshall).—*Soft Candy.*—There must be something wrong in the way you make the candy if it does not set. Large quantities have been made from this recipe, and we use no other. If you are careful in carrying out the instructions as given on page 195 of "Guide Book" you ought to succeed.

W. DUNMALL (Wadhurst).—*Granulated Honey in Sections.*—Cut the granulated comb honey into small pieces and put them into a vessel, which must be stood in a pan of water. Place a couple of sticks on the bottom of the pan, so that the water will surround the inner vessel. Heat to a temperature of about 150 deg. Fahr. until the honey is dissolved. On cooling, the wax will float on the top and can be removed in a solid cake.

D. McINTYRE (Blairgowrie).—*Painting Hives.*—You can have them white, as you propose, but should paint the porch and alighting-boards of alternate hives different shades of colour so that the bees may readily distinguish their own hives.

F. J. NORRIS (Rugeley).—Thanks for Press-cutting. It is evidently a printer's error, and should read: "150 lb. of honey being taken from a single stock."

Suspected Combs.

PANDORA DE BRISTOL.—Your bees have succumbed to foul brood, as the small patch of brood on the comb sent is badly affected. The comb is old and black with sealed honey at one end, and at the top of the other end there was a small cluster of bees with their heads in the cells, indicating that they had died of starvation. The cluster of bees was evidently too small to keep itself warm enough to reach the food.

H. F. (North Hants).—Comb is affected with foul brood, now almost dried up. Burn frames and combs at once.

ALARMED (Haslemere).—Comb is affected with foul brood. (See reply to "H. F.")

*** Several important letters, &c., are in type, but held over from pressure on our space.

Editorial, Notices, &c.

DISEASE OF BEES IN THE ISLE OF WIGHT.

We have received from the Board of Agriculture and Fisheries the further report, just issued, on the bee-disease which has devastated the apiaries of bee-keepers in the Isle of Wight. It will be remembered that in 1907 Mr. A. D. Imms, B.A., of Cambridge, was sent down to the island by the Board, and reported the results of his microscopical investigations (see B.B.J., 1907, page 281), and since then the matter has been under the investigation of Dr. W. Malden, M.A., of the Pathological Laboratory, Cambridge, who has taken up the bacteriological side of the subject, in which he has been assisted by Dr. G. S. Graham Smith.

Dr. Malden visited the Isle of Wight in May, 1908, and got all the information he could gather from bee-keepers on the spot. After describing the symptoms, he says the mortality caused by the disease is much more noticeable during the summer than during the winter months, the end of May and June being the months in which the disease is most rapidly fatal.

In his anatomical investigations Dr. Malden does not entirely agree with Mr. Imms, for he found that in healthy bees, taken from a hive after a few days of bad weather, the colon was distended to quite the same extent as in many of those diseased. Bees from the same healthy stock, caught as they returned on a fine day, showed an almost empty colon, a fact that Mr. Imms seems to have overlooked. The observations show that the distension of the colon cannot be regarded as a condition peculiar to the disease, and Dr. Malden thinks it only a secondary effect of it. Having failed to discover by dissection any definite and characteristic changes by which the disease could be diagnosed, Dr. Malden carefully examined the separate organs by means of stained and unstained microscopical preparations. He found no changes in any of the organs until he examined the chyle stomach, which in many cases showed marked changes in section. In the normal bee the cells of the lining membrane are well defined, but in diseased bees many of the cells appeared swollen and ill-defined, and detached cells appeared in the lumen of the gut in increased numbers in advanced cases; whilst those which remained in position were vacuolated, irregular in shape, and had irregularly staining nuclei. In the most advanced cases the lumen was filled with desquamated cells and granular material.

Bacteriological examination showed the blood, tracheæ, salivary glands, and other parts to be free from bacteria—evidence that the disease is not accompanied by a general bacterial infection. A large number of bacteria were found in the colon, but on attempting to differentiate the organisms by cultures on several media, and thus isolating the different species, they were all seen to be in both diseased and healthy specimens. Dr. Malden finally directed his attention to the contents of the chyle stomach of healthy and diseased bees, and here he was able to distinguish in the latter certain plague-like bacilli which were not present in healthy specimens, and these organisms he is led to believe are the cause of the disease. In stained film preparations the bacillus appears as a short, round-ended, thick organism, with darkly staining ends and lightly staining central bands (polar staining), and closely resembles *B. pestis* in general appearance. He therefore proposes to name it *Bacillus pestiformis apis*. A single infection experiment was made with a culture of this bacillus. A healthy stock of bees was placed in a hive in a greenhouse, all openings being closed with muslin and the bees fed on syrup. When they had become accustomed to this treatment, broth cultures of the bacillus were mixed with the syrup. Within a few days considerable numbers of bees had died, and the bacilli were found in their chyle stomachs, which also showed the fragile condition found in naturally infected bees.

In the summary of his report Dr. Malden says that many difficulties presented themselves in the investigation of the disease, as bees sent in small numbers for investigation travel badly, a large proportion being dead on arrival, and as putrefactive changes set in rapidly the bees are rendered useless for examination. It was also impossible to obtain specimens for considerable periods, owing to the apparent temporary cessation of the epidemic. For this reason at a later period a stock of diseased bees was obtained, the hive placed in a muslin cage, and the bees fed on syrup, and the experiments were made with bees from this colony.

The characteristic features of the disease are a more or less rapid mortality amongst the bees, disinclination to work, some distension of the abdomen, frequently dislocation of the wings, and, later, inability to fly. The disease can only be recognised by observing the general conditions of the stock. Anatomically the bees show a fragile condition of the chyle stomach, all other organs being normal. Bacteriologically plague-like bacilli were frequently encountered in the chyle stomach, and they

were not found either in the brood of diseased hives or in the chyle stomachs of healthy bees. Dr. Malden, therefore, regards them as the cause of the disease. He admits, however, that he has not fully established their relationship to the disease, and until some satisfactory cultivation methods have been discovered the bacteriological diagnosis of this organism must in most cases remain in doubt, for organisms simulating it in morphology probably exist.

The actual cause of death of the bees is uncertain, but it is probably due to malnutrition, possibly combined with the absorption of a specific poison and of the products of decomposition in the colon. There is some evidence to show that foragers and robbers of infected hives are first attacked, and communicate the disease to other members of the hive. Entering by the mouth, the infection may be spread by means of the contents of the honey stomach. Whatever may be the precise means by which infection is carried, the adult bees alone are affected, and there seems evidence to show that after a short period of time neither the combs nor the honey are infective. As remedial measures cannot be relied on, and as the area affected is small, Dr. Malden recommends the complete destruction of all the diseased stocks on the island, and that any overlooked at first should be destroyed as soon as the disease is detected. This would not entail very serious loss, as the number of such stocks is limited, and an outbreak of the disease almost invariably ends in the complete destruction of the hive. Dr. Malden intends, if the opportunity occurs, to continue these investigations this year. The complete report is published in the February number of the *Journal of the Board of Agriculture*.

HERTFORD AND DISTRICT B.K.A. ANNUAL MEETING.

The annual meeting of the Hertford, Ware, and District Bee-keepers' Association was held on Wednesday, February 3, in the Shire Hall, Hertford, when Mr. R. T. Andrews presided over a good attendance. The secretary (Mr. F. P. Howard) presented the third annual report, which showed that satisfactory progress had been made during the year. The amount received in subscriptions was £2 0s. 6d. more than for 1907, and ten new members had joined. The balance-sheet showed a sum due to the treasurer (Mr. R. T. Andrews) of £1 6s. 7d. Mr. Lindsell and Mr. Willmott were added to the committee, which was re-elected with the exception of Mr. Noyce.

The association's expert (Mr. W. Gee)

presented his report, which showed that he had made sixty visits to members during the year, and also demonstrated at several flower shows with live bees. As regards the honey-crop, he considered 1908 was the best for five years, several members having taken double the quantity that they had ever done before, in spite of the fact that owing to bad weather the limes yielded practically nothing, and these trees are looked to for a great part of the surplus in this locality. At the conclusion of the meeting the county council's lecturer, Mr. Herrod, gave a very interesting lecture, illustrated with lantern slides. Thanks to the lecturer and chairman concluded the meeting.—(*Communicated.*)

Correspondence.

The Editor does not hold himself responsible for the opinions expressed by correspondents. No notice will be taken of anonymous communications, and correspondents are requested to write on one side of the paper only, and give their real names and addresses, not necessarily for publication, but as a guarantee of good faith. Illustrations should be drawn on separate pieces of paper. We do not undertake to return rejected communications.

AMONG THE BEES.

"USEFUL HINTS."

[7404.] *The Wax-cake.*—At times, if the wax-cake is left for a time in the vessel in which it has been melted, it will adhere so firmly to the sides on cooling that there will be a difficulty in withdrawing it. In such a case turn the article upside down, pour boiling water over it, and this will heat it to the extent that the cake will come freely away. On the principle that prevention is better than cure, it may be useful to know that if the pan is well rubbed with soap or coated with soapsuds the cake will not adhere. To prevent the cake from cracking while cooling place the pan in a larger one filled with hot water, when the wax will cool slowly and uniformly. When melting brood-combs the refuse is easily scraped off the bottom of the cake if this is done while it is still hot. For small quantities of clean wax (scraps of foundation, virgin comb, cappings, &c.), a good plan is to place in an earthenware dish in kitchen oven before going to bed. The wax melts nicely and cools gradually, with the result that a clean compact cake can be turned out in the morning.

Rain-water serves best for wax-rendering. Many believe in using a little salt dissolved in the water, while for brood-combs some sulphuric acid secures a brighter shade of wax. Some purchasers, however, stipulate that it must be rendered without the use of acids. Combs

crumbled down before melting give better returns, and if all pollen is first syringed out more wax will be obtained. All combs previously bred in should be rendered by themselves, and not mixed with fresh comb. Bad foul-broody combs should be dealt with apart from all others.

Queens. — "Scientific Queen-Rearing" gives a simple plan for re-queening: "Hatch a young queen in an upper story, divided from the brood by excluder-zinc, and shake her with the rest of the bees below, or in front of the entrance, when she will certainly supersede the old queen." The plan is well worth trying.

The newer way of re-queening is to take out the old queen and cage the new one both at the same operation; and some of the forward school consider it is not a benefit but a detriment to delay introduction for one or two days. Certainly a long interregnum is far from desirable, as the bees, after perhaps a day or a day and a half, ascertain the loss of the mother-bee, and forthwith take steps to create another. With some delay in inserting the fresh queen they may begin to recognise something in the hive as an embryo successor, and so proceed to maltreat the valuable alien you introduce.

The novice is apt to make the "Good Candy," for use in queen-cage during transit in post, too thin. It may appear as if it could take in no more of the fine icing sugar; but try it, and you will find that it will assimilate a little more. Often when the beginner thinks it hard and dry he will find next morning that it has turned quite soft. During the past season I received two queens, the one dead, the other dying from this cause. The excessive heat experienced at the time had melted the candy quite soft, turning it almost into a liquid, with the result that the bees were daubed and coated all over with the deliquescent mess.

In Early Spring.—If, on making a momentary examination in very early spring by simply peeping under quilt, it is known or suspected that the colony is short of stores the best "cure" is to get a fat comb from your reserve store, and, gently drawing back the other combs towards the dummy side of the hive as quietly as possible and with no disturbance of the bees, place this comb of stores, previously slightly scratched, close up to the cluster. Then you can go to sleep in peace, confident you have done your best for that lot of bees.

Candy overhead is often recommended, and it is a good substitute for honey, but only a substitute. It is an "emergency" food at the best. In the early part of the season it has a rousing effect on the bees. It stirs them up and agitates them, imparting to their thoughts a desire to go

out in search of water, and in this way it compels them to leave the hive when weather may not be favourable. If syrup has to be fed, under compulsion, at an early period in spring, I would prefer to feed a known strong stock, and then give one or two of the stored combs to a weakling. About the end of April is the best time to buy stocks of bees, as they have then safely passed the wintering stage and the still more critical period of spring, when so many colonies go under. There is something, too, in the excitement brought about by shifting them which stirs them up, and, once imbibing copious draughts of the life-giving nectar, they get into the way of shifting honey near their brood. The queen is thus roused up to additional egg-laying, and the energy required to feed the larvæ stirs up the entire community to active work.

Hints to Beginners.—Even before investing in hives get as extended a knowledge of apiculture as possible. Read, read, read! Get as many bee-books as you can lay your hands on by purchase, or loan, or from a library. Lay a good theoretical foundation from these. For everything of the newest and up to date, however, search the bee-journals weekly or monthly. More detail on definite points will be found there, and for what you do not find or do not know—ask, and it shall be given you. A special department in the *B.B.J.* and the *Record* is set aside for this very purpose in the "Queries and Replies" columns.

Wherever you can, visit shows to see honey displayed in its best and most taking form, which in itself is an education. Wherever tent or other demonstrations are going on, journey far to see them: they are well worth it. In a few minutes you may acquire a large amount of knowledge, which might take you months' or even years' plodding to become master of. If possible, spend some time in the apiary of a man of experience who has a good practical knowledge of bees and bee-keeping. Even better, put yourself under the tuition of an expert. Go slow, Mr. Novice! Acquire a knowledge of bees and their ways before you invest in many hives. Let the number increase as your knowledge does, and so you will become a bee-keeper in deed as well as in name.—D. M. M., Banff.

BEE-KEEPING IN LIGURIA.

[7405.] We were very sorry to learn of the death of Mr. Carr, a great loss to you, as he had become a friend and valuable assistant in your work, whom it will be very difficult to replace. You have our sympathy, for it will be tiring for you to harness yourself alone to your two jour-

nals until such time as you can find a capable man for the work. It requires an expert bee-master to conduct your journals, and I hope you will be able to find one qualified to do so. The extracts in the B.B.J. from the letters of sympathy which you have received are very touching; so also is the letter of Mr. Carr's son.

I have carefully read Dr. Kuckuck's article and the criticisms which you were obliged to make on it. You reply point by point, and your arguments based on evidence are irrefutable. They must certainly have interested and enlightened your readers. I myself was particularly interested, but you will not have converted the writer with whom you have to deal. As you truly say, he bases his arguments on altogether exceptional cases, and in this reminds me of Giotto Ulivi, who inundated me with registered pamphlets on the same subject, which he requested should appear in the *Revue Internationale d'Apiculture*. Twenty-seven years ago I remember seeing in M. Sartori's apiary in Milan—where, of course, only Italian bees are kept—black drones among the yellow ones.

It is much warmer here than in Switzerland, and there are seldom more than one or two degrees of frost, which occurs only at night, but on the other hand we frequently have cold winds, and snow appears on the summits of the neighbouring mountains. Ospedaletti is considered the warmest and most sheltered part of the Riviera, but this has not prevented me from catching cold on our arriving here. We are in a walled country: there are walls to support the railway along the seashore, walls for the road above, walls for the promenades, hotels, gardens, and fields. The culture of flowers—principally roses—reminds one of the walled vineyards on the shores of Lake Lemman. A few olive trees still remain, but as these are no longer remunerative they are gradually being cut down, and the fields are planted with rose trees. There are a good many orange and lemon trees, but the oranges are acid. Lemons sell for twenty centimes (2d.) a dozen, and passers-by are permitted to pick up those that have fallen from the trees. The principal native trees and shrubs, in addition to the olive, are the carob, mastic tree, Spanish broom, figs, and pines. Among the few flowers blossoming at present there is a pretty yellow oxalis (*O. cernua*), which is a native of Sicily, and some say of South Africa. There are also a good many bushes of rosemary, cistus, and shrubby heaths. The vegetation in the gardens and promenades is sub-tropical: Chamærops, phoenix, agaves, aloes, Japan medlars, prickly pears (*Opuntia*), yuccas, eucalyptus, acacias (now covered with lovely flowers), and a good many other shrubs.

There is a large flower market here, for flowers are the chief industry of the country. They are sent abroad in baskets made of split reeds (*Arundo donax*, in Italian called *canucie*). Roses on stalks a foot long are sold for from 3 fr. to 50 fr. (2s. 6d. to £2) a hundred according to the season and the state of the weather. One day when we visited the market we could buy them at 3 fr., and the next day they cost 50 fr., the enhanced price being due to a frost on the higher ground. An amiable Englishman whose acquaintance we made through Dr. Olivier has started gardening, and, being a bachelor, makes a living at it. He has a head gardener and several men under him. A few days ago he told me that during the last three months he had sold upwards of 10,000 fr. (£400) worth of roses. He also works at the planting, budding, pruning, and irrigating.

The entomologist who called the yellow bee *Apis ligustica* was unfortunately inspired. From Ventimiglia to Spezzia—that is, in nearly the whole of Liguria, except in a few apiaries where probably swarms have been imported from other regions—the bees are just as black as ours, which seems to show that they have come by way of the seashore from Provence in the west. You have to pass over the mountains to the north in order to find bees with yellow bands. The Englishman whom I have mentioned wanted to have bees, but was told that it was impossible to keep them in that district. The reason for this was explained to me by an extensive bee-keeper of San Remo (five kilometres from here). He said that in September there are large numbers of death's-head moths, which consume all the stores in hives which are not sufficiently protected against their depredations. In my walks I have seen few bees on the flowers of the *Eupatorium* now blooming in the gardens.

I found a small shop in the principal street of San Remo devoted exclusively to the sale of honey, which really had a very attractive appearance. There was displayed extracted honey in large cans and in differently-shaped glass jars, also comb-honey in circular sections made of glass, about 10 centimetres (4 in.) in diameter and 47 millimetres (1½ in.) in thickness, very neatly and tastefully put up with attractive labels. Asking for an interview with the producer of these sections, he was soon fetched, and said that he knew my name through my writings, and he received me very cordially. He told me that he uses a modification of the "Dadant" hive, and with his associates manages several hundreds of colonies which pass the winter near San Remo, and at the proper season are transported by rail to the north of the mountain to

Vievola, which is at an altitude of 1,000 metres (3,280 ft.). Down here near the sea the principal honey-harvest is in April and May, and that for winter provision is in October, November, and half of December.

The principal harvest at Vievola is from the middle of May to the middle of August, and if there happens to be rain during this month the honey-flow is prolonged. The hives are taken by train to Vievola about May 15, and brought back to the neighbourhood of San Remo at the beginning of October. The bees with frames are transferred into small light cases for the journey. Swarming at San Remo takes place between March 25 and May 15, and at Vievola from the middle of May to June. As M. Oreggio, the bee-keeper referred to, is associated with several others, different types of hives are in use, but he himself prefers the "Dandant-Blatt."

I have mentioned that he sells his honey in circular sections, and these he calls "honey-moons" (*luna di miele*). The glass containing the honey-comb is in the form of a ring, and when the bees have filled it M. Oreggio covers both sides with a perfectly transparent pellicle resembling celluloid. These pellicles are kept in place by two slender nickel-plated rings, and the section is then put into a prettily-decorated tin box, the whole presenting a very neat appearance. M. Oreggio thinks that he is the only one who produces round sections, and the idea occurred to him because he has for a friend a glass-maker, who has gone to great trouble in making them according to his fancy. To get them filled six are fitted into each frame, and in order to encourage the bees to work in them pieces of comb containing honey are put in the intervening spaces. I will see if I can send you some specimens. Wheat, barley, and potatoes are the principal crops cultivated at Vievola. The native flora consists principally of thyme and lavender, and there are no trees. The honey is not very white, but the flavour is excellent.—ED. BERTRAND, Ospedaletti, Liguria.

BEEES AND POLLEN.

[7406.] The bee-man's interest in his bees is revived at this season by the sight of loads of pollen being carried in in daily increasing quantities. Naturally he watches for the first signs of this, and probably makes a note of the date on which he first sees a bee struggling home under its load. The particular hive which begins to gather first, and the source from which the supply comes, may also be recorded. In a large apiary there is generally a considerable period—sometimes

weeks—between the time of starting pollen-gathering among the various hives. The keeping of a record reveals the fact that the earliest to show activity in pollen-gathering are not always the best when the honey-flow comes. As an illustration of this I will give some notes I made seven years ago with reference to two hives I had then standing together in my apiary, and which were daily under my observation. One of the two hives in question was headed by an Italian queen introduced early in the previous autumn, while the other contained a colony of natives. Their condition was about equal when packed for winter, both seemed to winter well, and on the first Sunday in March, between 11 a.m. and 12, over thirty Italians carried a load of pea-meal from a box placed near the hives, but not a single native bee from the other hive returned with any kind of pollen, very few being abroad. On the next Sunday morning, in the same hour, over 100 Italians returned with pollen partly from the pea-meal box and partly from crocus blooms; while their black neighbours had only seventeen loads of entirely crocus pollen to their credit. A wet, cold week stopped progress, and on the following Sunday, which was dull and cold, only a few Italians visited the meal box, no natives being out. On the next Sunday, which was very fine, large numbers were abroad from both hives, and between 11 a.m. and 12, about twice as many Italians as blacks returned laden with pollen, which was now entirely from willow and dandelion. On the first Sunday in May, at the same hour, the natives were carrying in a larger quantity than the Italians, their numbers having now increased so much that a correct count was not possible. Drones were also noticed on this day leaving the hive of natives. On May 20 the natives sent out a swarm quite unexpectedly, which was duly lived on the parent stand. On June 5 this swarm was given a rack of sections, and on July 14 they were given a second, while on this same date the Italian stock swarmed, having only just begun work on the centre of their first rack of sections.

I have followed the history of these two stocks far enough to show the difference in rate of progress in stocks under practically equal conditions of management and climate. The moral is that it is a mistake to force the pace too much early in spring, as spring dwindling is caused by some strains of bees wearing themselves to death, as it were, trying to raise large numbers of young too soon, when the hive population will not stand the early drain thus made upon it. Italians are especially prone to this suicidal trait, especially in our northern climate.

During the last seven years the dates on which I have observed the first loads of pollen being carried home have varied between February 15 and April 9. In this locality the first is always from the crocus, which is followed by the willow and dandelion, the willow being by far the best of our spring pollen-bearers. At the time of writing not a single load have I seen carried in this spring, although hundreds of bees are bearing water whenever the weather has been fine enough for them to venture out. In my next I hope to describe a method I have adopted of supplying warm water to the bees, which I believe will prove very beneficial. In the meantime I shall be most grateful if any bee-keepers who are sufficiently interested will drop me a card noting the date of first pollen-gathering and from what source in their own particular district, for comparison with my own.

The spring so far in Cumberland has been very trying to bee-life, and the month of March appeared in the traditional lion-like mood, the fells at the time of writing being covered with a white mantle, and a biting east wind is blowing.—G. W. AVERY, Heads Nook.

FOREIGN BOOKS ON BEE-KEEPING.

[7407.] Questions are often forthcoming as to what works dealing with apiculture should be found on an enthusiast's bookshelf. I shall be glad if you would publish such a list for the benefit of your numerous readers. I am aware of the large number which are advertised in your columns, but I see few German, French, or American books mentioned which are authoritative volumes.

If you could quote prices and names of booksellers the value of this list would be enhanced.

Apiculture is making rapid strides in South Africa, and—I regret to say it—American goods are benefiting to a far greater extent than those of British manufacture, mostly for the reasons set out in my last letter which found a place in your correspondence columns.—GEORGE S. OETTLÉ, South African Bee-keepers' Association, Johannesburg, Transvaal.

[In addition to those advertised in the B.B.J. the following is a list of the best German, French, and American books:—

German, to be obtained of Ed. Freyhoff, Oranienburg, Germany:—Alfonusus, *Lehrbuch der Bienenzucht*, 10.30 marks; Berlepsch, *Bienenzucht*, 2.60 marks; Cowan, *Führer d. eng. Bienenzüchter*, 2.20 marks; Cowan, *Die Honigbiene*, 2.20 marks; Gerstung, *Der Bien u. seine Zucht*, 3.80 marks; Kramer, *Rassenzucht Schweizer Imker*, 3 marks; Kramer und Theiler, *Schweizer Bienenvater*, 3.20

marks; Preuss, *Meine Betriebsweise u. ihre Erfolge*, 2.50 marks; Vogel, F. W., *Die Honigbiene*, 10.30 marks.

French, to be obtained at the office of *L'Apiculteur*, 28, Rue Serpente, Paris:—Collin (Abbé), *Guide du propriétaire d'abeilles*, 3 fr.; De Layens, *Cours complet d'Apiculture*, 4.50 fr.; Clément, *Apiculture moderne*, 2.40 fr.; Gouttefangeas, *Ruche claustrante*, 3.50 fr.; Hommel, *L'Apiculture*, 5.50 fr.; Halleux, *Le livre de l'apiculteur belge*, 3 fr.; Girard, *Manuel d'apiculture*, 6 fr.

The following from R. Burkhardt, 2, Place du Molard, Geneva:—Bertrand, Ed., *Conduite du rucher*, 2.50 fr.; Cowan, *Guide de l'apiculteur anglais*, 2.50 fr.; Dadant, *L'Abeille et la ruche* (Langstroth), 7.50 fr.

American:—(From A. I. Root Company, Medina, Ohio, U.S.A.), *Doolittle, Scientific Queen-rearing*, 75 cents; Quinby, *Mysteries of Bee-keeping*, \$1; (from G. W. York and Co., 118, West Jackson Boulevard, Chicago), *Miller, Forty Years among the Bees*, \$1; *Cook, Bee-keepers' Guide*, \$1.20; (from Dadant and Son, Hamilton, Illinois), *Langstroth on the Honey-bee*, revised by C. P. Dadant, \$1.20; (from W. Z. Hutchinson, Flint, Michigan), *Advanced Bee-culture*, \$1.20.—ED.]

BEEES AND CUCUMBERS.

HIVE-ROOFS.

[7408.] In a good deal that I have read on the fertilisation of blooms by bees and other insects, there seems to be some confusion of two sides of the question, viz., fruit-growing and seed-growing. Experiments are recorded where a limb or a whole tree is netted to exclude insects, the result being no *fruit*, and apparently in support of this theory clover is treated in the same way, but in this case the conclusion arrived at refers to *seed*. It is not suggested that clover heads do not grow. Although it seems to be well established that apples, pears, and especially stone fruits, unless fertilised or cross-fertilised, will not bear fruit, or if insufficiently fertilised the fruit will be imperfectly developed or deformed, I contend that it is a mistake to conclude from this that all trees and plants require similar fertilisation. With cucumbers, for instance, it is quite the reverse. If the blossoms are allowed to become fertilised the fruit is clubbed, bitter, and unfit to eat, but will, on the other hand, contain seeds, while those unfertilised are long, straight specimens, and contain no seed. In this country cucumber growers for market keep their houses or frames closed in order to exclude bees, and also pick off all male flowers they may see. I do not know what variety they grow in the United States, or

what they do with their cucumbers, but (I feel rather diffident in mentioning this) Mr. Root, on page 222 of "A B C and X Y Z," quotes the editor of the *Rural New Yorker*:—"In those great greenhouses near Boston, where early cucumbers are grown, it is always necessary to have one or two hives of bees inside to fertilise the flowers. No bees, no cucumbers, unless men go round with a brush and dust the pollen from one flower to another." It is mentioned further down the column that they grow them for the early market and get fancy prices, so it is not a question of seed-growing. If seed could not be grown without the help of bees, of course "no bees, no cucumbers" would be correct. On the next page is an illustration described as "Cucumber Blossom with a Bee on it: Caught in the Act." The last four words are suspicious, and seem to convey more than they are intended to, as I know growers who always chase a stray bee which happens to get into their house until they have caught it.

Hive-roofs.—Linoleum makes a capital covering for hives, and will last ten years or more. Waste pieces left after covering the floor cost little. One piece is perhaps best, but is not absolutely necessary, for if the pieces are cut straight, the joints fitted closely together, tacked down, and all round the edge (not turned over), the linoleum being kept right side up, the paint will fill up the crevices. This makes a perfectly flat and smooth roof, from which the water runs off readily. A flat or half-span roof is best, and as a finish a strip of zinc along the front can be tacked over the linoleum, and another along the back tacked under the linoleum would be better. Old oilcloth is not satisfactory.

Another good covering could be made of tailors' old pattern-cards. These are made of stiff paper covered with linen. Three strips cover a hive top; overlapped, turned over the edge, tacked all round, and painted, they make a waterproof roof. You can obtain them from your tailor when the last season's patterns are out of date.—W. DOLEMAN, Keyworth.

[We can assure our correspondent that the description given in the book mentioned is quite correct, for we have ourselves seen such cucumber houses. The methods of growing are different in the two countries. In America seedless cucumbers are not esteemed as they are here. In fact, one rarely sees the English type of cucumber in that country, those grown there being much shorter, thicker, and always contain seeds. They do not become clubbed or bitter, and if gathered at the proper time, before the seeds become hard, are far more delicious than our seedless ones.—ED.]

REVERSIBLE FLOORBOARDS.

[7409.] With reference to "Novelties for 1909" (pages 98-99), we beg to contradict the statement that we are "adopting a similar floorboard," and are rather of the opinion that this sentence should be reversed. This idea was first brought out by the late S. J. Baldwin some fifteen years (or more) ago, and used in connection with his "Common-sense" hive and his well-known "No. 10 Bridgewater" hive, and it is these ideas which we are embodying in our "New Pattern" hive.

Further, one reads: "A queen-excluder below the brood-nest." Mr. Silver, having seen our idea, has possibly changed his mind, as he used small frames underneath the brood-nest last season *without queen-excluders*.—MRS. SEADON, The S. J. Baldwin Apiary, Bromley.

[The above letter was accompanied by a catalogue dated several years back, in which the "S. J. Baldwin" reversible floorboard is illustrated and described, and we willingly insert the correction.—ED.]

BEE-STINGS AND RHEUMATISM.

[7410.] Before your readers who are not qualified practitioners of medicine commence treating people with bee-stings for rheumatism, it would be wise for them to obtain the opinion of a medical man as to the safety of doing so in each case. It is not generally known outside the medical profession that there is no disease in which, sooner or later, heart disease develops itself more than in rheumatism. The acute pain and shock from even one bee-sting might produce suddenly fatal results, and then would come a coroner's inquest, with, possibly, a claim for heavy damages against the innocent and ignorant practitioner.

In cases of heart-trouble medical men would produce local anaesthesia, and thus diminish the tendency to shock, and even then the nature of the anaesthetic could only be decided by a qualified practitioner. I send suitable cases to a bee-expert for the stinging, but I first satisfy myself as to the suitability of the case.—E. T. BURTON, M.D., Birmingham, March 9.

THE CHRISTMAS ROSE.

[7411.] With the pen of a ready writer "D. M. M.," on page 84, makes every bee-keeper take up the words of the poet and say, "Twere glorious in the dawning of those days to be alive; but to be young was very heaven indeed." In referring to *Helleborus niger* (Christmas rose) I notice what appears to me to be a slight mistake. "D. M. M." says: "Propagate by division of the clumps. They grow

freely in any soil; if planted in different aspects the bloom may be prolonged."

My experience has been that this plant is one of the most difficult to grow, that division of the clumps should only be made in September, and that only in deeply prepared soil (roots have been traced 3 ft. or more deep), planted in partial shade, and protected with glass during the winter months. Can the words of the song which says, "Youthful hearts will find for ever roses underneath the snow," be an actual reality.

Nearly all bee-keepers are gardeners, hence my writing you upon this point.—THOS. N. HARRISON, Carrington, Notts.

BEST POSITION FOR HIVES.

[7412.] Referring to the correspondence in recent issues of B.B.J. about the best position for hives to be placed in, I should like to say that my attention was called the other day to some very old cottages (about 100 years old) at Hale End, Chingford, where very large numbers of a wild bee (believed to be the mason bee) are to be seen emerging from spaces in the walls. Although all the walls are equally porous and similar in construction, the bees are only to be found on the south-east side, which seems to prove that, the selection being left to themselves, they certainly prefer that aspect, and not facing north, as some of your correspondents suggested.—A. B. H., Leytonstone.

THICK V. THIN COMBS.

[7413.] A little more than a year ago we had a controversy in your columns as to the respective merits of thick and thin combs in working for extracted honey. May I ask anyone who tried both systems last season to give us the results of their experience in the JOURNAL, and especially if it was found that the honey from the thick combs was of less density than that from the thinner ones?—NONDESCRIPT.

CAPPINGS OF COMB.

BY L. S. CRAWSHAW, NORTON, MALTON.

Autumn Expansion (page 35).—What happens to the "extracting stock"? Presuming it to consist of three standard tiers—for brood, extraction, and expansion respectively—then of how many tiers does it consist after the two upper ones are removed? In other words, does "J. M. E." "expand" this stock also? And, if so, how are the stored combs obtained? Is the expansion tier divided between the comb honey and the extracting stocks?

Driven Bees (page 38).—Mr. Sinfield says that a swarm compares disadvantageously with a driven lot of the previous year, because its queen is in her second season. But is not the driven queen also in her second season? Certainly she may be young, but as she has already produced "late-hatched workers," and presumably did some work prior to the driving, we must be careful not to claim for her an undue advantage, or "D. M. M." will come over the Border!

Bees near Railways (page 58).—This detriment of the deadly suction of passing trains is new to me, and, though I can credit it, I do not see why the bees should fail to rise again. Has Mr. Sunley observed individual bees sufficiently long to be quite sure of his facts? The only remedy I can suggest is to post a warning notice, with a copy of the local timetable, in front of the hives! The objection may, however, not apply to station locations on lines where expresses do not run. Apparently we shall soon be unable to keep bees near the high road on account of the increasing number of fast cars, and all the hives of bumbledom will be clamouring for speed limits! That is, unless we wait patiently for the draughtless, dustless, scentless car, or until evolution has taught the bee the ways of Jagannâtha! I wonder whether *A. mellifica* var. *Londiniensis* has, in its transviations amongst the plane and lime trees, picked up any motor dodges! If so, Messrs. Abbott might advertise "Daily Mirror queens, used to traffic, easy to drive, well-coached yellow and black bodies, holders world's record automatic cell-charging, &c."

Bees on Allotments (page 58).—These letters contain most helpful advice. There are, however, even quieter bees than the native variety—to wit, Carniolans—and there are much worse-tempered bees than Italians. Some strains of Italians are very quiet, but difficulties soon arise with the inevitable crossing. All things considered, the advice to keep natives is thoroughly sound.

Love, Honour, and "Abeille" (page 59).—I feel sure, could we but know it, that "Scot" must be the possessor of some most interesting and engaging qualities, not the least of which is perhaps his own sense of humour. And, as Jerome says of another "Scotch wooing," he has "a truthfu' tongue." He has already been so frank that we may surely hope that one day both "Scot" and "Heather" will "come out of hiding" and allow us to express the interest we feel, when this *affaire de cœur* shall have left its present state of "abeillance" and the result is no longer "surmisible."

A Good Price (adv't.).—5s. 3d. per lb.!

At least, that is what "one 4-lb. tin of honey," or for that matter of anything else, costs at a guinea the tin! One would certainly expect to have a "fine flavour" at the price; but it is to be feared that such an advt. may mislead some poor deluded market-seeker who fails to refer to the succeeding number of the B.B.J. for the correct explanation.

Anonymity (page 66).—"Shot from behind" has ever carried disgrace with it, and the disgrace should oft-times attach to the shooter. If one regard them at all, a certain smarting of the eye would seem consequent on words of "smoke," "shot from behind a hedge of anonymity," although they may only suggest "the crackling of thorns under the pot." But pot-shots of this kind are to be deplored, and I cannot see why *noms de plume* should be adopted by so many correspondents. If ashamed of their opinions, why utter them? And if unashamed of their name, why not use it? If that oft-used title "Brother Bee-keeper" be more than a mere phrase, let us act like brothers; and if we desire a brother's privilege of plain speech, let us as brothers look one another fairly in the face.

Prophets of Old (page 66).—"Small profits, quick returns" is an old saw which will still cut wood even in these days of "hen roosts," although its teeth may be somewhat blunted by contact with tax. According to a simple ancestral progression, "D. M. M." should have added another half-sovereign to his own prophetic return, which was evidently not for income-tax purposes! Thus: Maxwell, 20s.; Bonner, 30s.; Pettigrew, 40s.; Macdonald, 50s.! There is little doubt that at times this last figure of note—or, if you will, of half a note, the £5 variety—may be attained with a concurrence of the best conditions. The best modern management would warrant an even higher figure but for the fact that times, and perhaps seasons, have changed since "the bad days of the old straw skep," owing to the introduction of other cheaper sugars and mineral waxes.

(Continued next week.)

Queries and Replies.

[3894.] *Selling Honey in Bulk*.—As a reader of the B.B.J. I take the liberty of writing to you about my bees and the disposal of honey. Last year I had three stocks in frame-hives. The bees were up on the shallow-frames the first week in May doing splendidly, but I could not stop them from swarming. I did not put any

excluder-zinc on, unfortunately, so the queen went up, and laid in several of the combs. However, I made about £3 by selling the honey. Since then I have purchased eight frame-hives, six being filled with good stocks of bees and one of driven bees, so I have ten stocks in all. I sent my honey last year to a customer in Liverpool, who gave me 5d. per lb. and paid carriage; but he can only do with a limited quantity. Now, Sir, I want your advice. Do you think I should have trouble in selling extracted honey in bulk at 5d. to 6d. per lb.? It is splendid light honey. I am only about five miles from Mr. Dunn-Gardner, of Fordham Abbey, and I should think this district is quite equal to his for bee-forage. There are acres of fruit trees, turnip, kohlrabi, and swede, all grown for seed, and many acres of sainfoin—in fact, as an old bee-keeper told me who visits the place, it is one of the best districts in England for bees. Thanking you in anticipation. —OTHO MORLEY, Mildenhall.

REPLY.—If the honey is good, you would have no difficulty in selling it in bulk at 5½d. to 6½d. a pound by advertising it in this journal.

[3895.] *Making a Rapid Extractor*.—Last July I commenced reading your valuable JOURNAL and also got the "Guide Book," and in a very short time afterwards began bee-keeping by purchasing a stock first week in August before the honey was extracted from it. I then made a "Cowan" hive from instructions in the "Guide Book," put a lot of driven bees into it, and fed them up on 25 lb. of cane-sugar made into syrup according to the recipe given. Now I intend making a "Cowan" rapid extractor such as the one shown on cover of "The Bee-keeper's Practical Note-book." I should be very pleased if you could give me a few particulars together with the chief measurements. I look forward to every Friday, for the JOURNAL is very interesting reading, but occasionally a writer comes along who is not content to let bees do all the stinging.—HAFREN, North Wales.

REPLY.—The rapid extractor, better shown in "Guide Book" (page 79), has a tinned-iron cylinder 21 in. in diameter and 28 in. high. The bottom is coned, and on the top of the cone is a socket, between which and the gearing at top the framework carrying the cages revolves. The vertical frame is of malleable iron, 19 in. wide and 18 in. high. The two horizontal bars form squares, 17 in., and are made of flat wrought iron. The cages swing on pivots and are fitted into a skeleton framework of wrought iron. They are 14 in. high, 9½ in. wide, and 2 in. deep, of tinned-wire netting fixed to

tin sides, and are made so that they can be taken to pieces for cleaning. The gearing at the top should be procured from a manufacturer, as for smooth running it requires careful fitting and adjustment. All ironwork is either tinned or nickelled. The illustration is sufficiently clear to enable you to understand the details, and it would be well if you were able to see such an extractor before commencing to make one.

[3896.] *British Honey Market.*—The letter of Dr. Kuckuck in B.B.J. of February 25 (page 77) regarding the non-existence of British (United Kingdom?) honey in Bordighera has aroused my interest, and I have written to the gentleman whose name he gives. 1. As it is only comparatively recently that I have seen your paper, could you tell me in your next issue where I could look up or get information as to the honey-industry here or how the honey is marketed? 2. Could you also explain why honey to the value of £31,769 was imported in 1908? 3. How does English—*i.e.*, United Kingdom—honey compare in quality with Continental? Any information on the above that you could give me would be much appreciated.—W. FRANK, 12, Red Lion Square, London, W.C.

REPLY.—1. You will get a good deal of information on the British honey market in this month's *Record* (page 33). Information respecting the industry can only be obtained by looking through the back volumes of B.B.J., and the methods of marketing honey in this country are described in the "Guide Book" (pages 88-93). 2. Because the supply of the home product is not equal to the demand. 3. Although there is honey on the Continent of Europe equal to our own, there is none superior to it, owing to our climate and extensive clover pasturage, and much of the foreign honey is adulterated with glucose. Jamaica and Chili honey, sold here in large quantities, are far inferior both in flavour and aroma.

Notices to Correspondents.

J. B. S. (Crewe).—*Hives near Road.*—There is always a risk in having hives within 15 ft. of a road, unless there is a fence between the hives and the road sufficiently high to cause the bees to fly over it. Such a fence should be 8 ft. or 9 ft. high. A 6 ft. fence on the opposite side of the road would be very little protection.

C. BRADFIELD (Glasgow).—*Bee-keeping in British Columbia.*—There are a good many bee-keepers in British Columbia, especially in the fruit-growing districts, and there is a ready sale for the honey produced. We are sending you copies of the *Canadian Bee Journal* for inspection, but we know of no bee journal in British Columbia. The Minister of Agriculture, Victoria, British

Columbia, would give you any information you may desire as to the best districts.

APIS (Coventry).—*Transferring Bees.*—If your bees are on ten shallow frames in a shallow super, you can place this above a hive fitted with frames containing comb foundation, and the bees will transfer themselves. When you find the queen laying in the new combs you can put excluder zinc between hive and super.

A. D. BETTS (Camberley).—*Pollen-mould.*—There are no books on the subject of pollen-mould. The mould is a species of *Mucor*, order *Phycomycetes*, such as is found on fruits, bread, potatoes, &c. Another belongs to the Yeast-fungi or *Saccharomycetes*, and is probably *S. mycoderma*.

J. SILVER (Croydon).—*Languid and Crawling Bees.*—If you will describe the method of treatment which you have found successful for the benefit of bee-keepers, we shall be pleased to give it publicity in our pages, so that it may be tested this season.

E. M. M. (St. Asaph).—*Soft Bee-candy.*—The sample of candy is just right at present, but if kept long it may go hard, as it is *very* slightly underboiled.

J. DABBS (Birmingham).—*Candy-making.*—We kept your sample for three days, and find it too hard for bee-food.

E. C. C. (Leeds).—*Paper Honey-pots.*—We believe they are very satisfactory in use. Mono-Service Vessels Co., 42, Percival Street, Goswell Road, London, E.C., are the makers.

NOVICE (Dublin).—*Crossbred Bees.*—It is too soon to examine your hive yet, and you had better defer it until the end of the month or beginning of April. If the bees are not carrying pollen into this hive while they are doing so in the other, we should certainly suspect queenlessness. The bees were perfectly flat when received, but are evidently crossbred, which accounts for the slight yellow bands.

P. F. HILL (Derby).—There is a Derbyshire Bee-Keepers' Association. The secretary, Mr. R. H. Coltman, 49, Station Street, Burton-on-Trent, would give you the name of the nearest local secretary, who would supply you with the information you ask for.

Suspected Combs.

G. (Royston, Herts).—1. The comb sent contains foul brood of the virulent type. The liquid you allude to must have dried up, as excepting the rotten masses in the cells the comb was quite dry. 2. The second piece of brood-comb was full of wax-moth, and is in too bad a condition to state with certainty the cause why the brood had died a year ago. The channels made by the wax-moth would suggest that this was the cause; but all such combs, with dead brood, should be burned as soon as found. The powdery matter is the refuse caused by the mites feeding on the dead carcasses in the cells.

S. HUDDLE (Kent).—The bees have died with their heads in the cells, the usual sign of starvation. There was no honey or brood in the comb sent. Mr. J. C. Roberts is the Hon. Sec. of the Mid-Kent Bee-Keepers' Association, 91, Holland Road, Maidstone.

W. H. SALTER (Devon).—There is no brood of any sort in the comb sent, and only mouldy pollen in the cells.

G. CAREY (Kent).—1. There is no sign of foul brood in comb sent. 2. The common English bee. 3. The cause of death is evidently starvation, and most of the bees have died with their heads in the cells. Refer to answer to "Alone" on page 100, B.B.J. for March 11.

* * * Several important letters, &c., are in type, but held over from pressure on our space.

Editorial, Notices, &c.

PROMINENT BEE-KEEPERS.

LIEUT.-COLONEL H. J. O. WALKER.

In accordance with a promise made at the beginning of the year, we have much pleasure in commencing our series of portraits of "Prominent Bee-keepers," and thus afford our readers an opportunity of seeing the faces of those with whom they have become familiar through their writings. This week we present the por-

trait of an old and valued contributor to the JOURNAL, for Colonel H. J. O. Walker is well known to our readers, and his carefully considered articles are always interesting and instructive. Born in 1843, Colonel Walker was educated at Rugby and at the Royal Military Academy, Woolwich. He served in the Garrison, Field, and Horse Artillery at home and abroad from 1864 to 1887 in Canada, East and West Indies, &c. It is always interesting to know what first induced anyone to take up bee-keeping, and

we cannot do better than give in Colonel Walker's own words his reply to our inquiry for information. He says:—
"From boyhood bees had much attracted me, and while serving I used to examine microscopically such varieties as I came across. It was Cheshire's fascinating book 'Bees and Bee-keeping,' published in 1886, that first caused me to think of keeping them, especially as I soon had the advantage of making the author's acquaintance. Hence on settling down near Budleigh Salterton, on the south coast of Devon, I lost no time in starting a small apiary of two colonies in

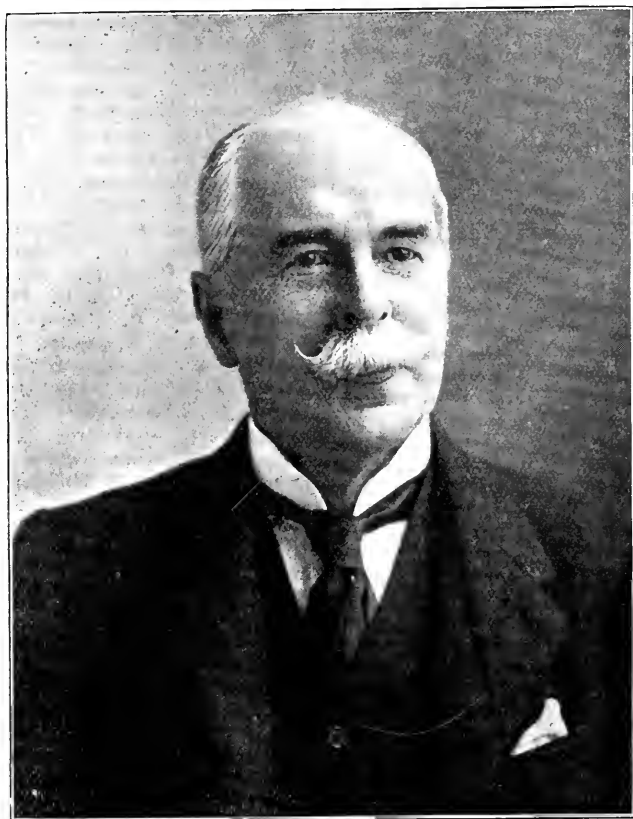

LIEUT.-COLONEL H. J. O. WALKER.

long 'Combination' hives, a pattern still quite to my liking. The next year brought me a neighbour's present of two more colonies and the experience of foul brood—perhaps a blessing in disguise, for I learnt how to deal with it. Four years later, when I had as many hives as I could manage, and matters might have been more serious, disease showed itself again, and this time I was the master. Mr. Bacillus was nipped in the bud, and never since have I been troubled.

"I take pleasure in stating that such

ability as I may possess in bee-management was learnt in the first place from the 'British Bee-keeper's Guide Book,' and perhaps still more from a careful study of the advice so patiently given to inquirers week after week in the B.B.J. by Mr. W. Broughton Carr, the skilful bee-master whose loss I shall constantly deplore. It was from him, too, that I got my first instructions in honey-judging.

"In 1898, on the revival of the present Devon Bee-keepers' Association, I was elected president, and acted as chairman of the council for seven years. As a vice-president I continue to lend a helping hand when necessary. The want of experts who could work officially for the association induced some of us to qualify, and in due course I obtained a second-class certificate. There is no saying to what height my ambition might not have soared had I not accepted an invitation to join the council of the B.B.K.A., since when I have felt a natural diffidence in coming before my colleagues as a candidate.

"Weakened a few years ago by a serious illness which makes me unable to face hot summer sunshine, I now keep only some half-dozen hives and a skep or two for examination of third-class experts. Such spare time as magisterial and political duties and the calls of country life leave available I devote to observation and the literary side of bee-keeping. With the happy possessor of a good observatory-hive and about 600 of the best bee-books time goes by only too quickly. Out of doors I take great interest in my garden and in the propagation of rare shrubs and plants such as grow freely in our genial southern air.

"The best of all hobbies is bee-keeping. Nothing binds more closely together men of all conditions. Amongst the many sources of happiness for which I am grateful none gives me more pleasure than a chat with a brother bee-keeper, and I hope that to the end of my little span I may be able to fill my ears on sunny mornings with the merry hum of *Apis mellifica*."

BRITISH BEE-KEEPERS' ASSOCIATION

A meeting of the Council was held on Thursday, March 18, at 105, Jermyn Street, S.W., Mr. T. W. Cowan presiding.

The minutes of the previous meeting were read and confirmed.

The following new members were elected, viz.: Mr. G. H. Garratt, Kano, Nantwich Road, Crewe; Mr. G. W. Judge, Tay Villas, Hawley, Dartford; Mr. Raymond C. Osborne, 54, Strafford Road, Barnet; Mr. James Pearman, Penny Long Lane, Derby; Mr. Arnold Richards,

Thurlby, Grosvenor Avenue, Wallington; Mr. Eldred Robert Ridgers, The Doon, Billericay, Essex; Mr. John Silver, Croydon Grove, Croydon.

The report of the Finance Committee was presented by the chairman, and approved.

Mr. Cowan was unanimously re-elected as chairman of the Council for the ensuing year, and Mr. W. F. Reid similarly re-elected as vice-chairman.

The remaining business was deferred to the next meeting of the Council, which was fixed for Thursday, April 15.

ANNUAL MEETING.

The annual general meeting of members was held at 105, Jermyn Street, S.W., on Thursday, March 18, Mr. T. W. Cowan, F.G.S., in the chair. There were also present Mrs. E. E. Ford, Mrs. J. C. Mason, Miss E. Scott-Walker, General Sir Stanley Edwardes, Messrs. R. T. Andrews, T. Bevan, W. Boxwell, R. Brown, L. S. Crawshaw, J. G. Dalzell, C. L. Eales, H. Edwards, E. Garcke, L. L. Goffin, W. Vivian Hatch, W. Herrod, G. W. Judge, H. Jonas, J. B. Lamb, R. Lee, J. C. Mason, W. P. Meadows, W. J. Owen, A. G. Pugh, W. F. Reid, A. Richards, G. H. Skevington, G. H. Sander, L. McN. Stewart, F. W. L. Sladen, A. E. Smith, H. J. Upton, E. Walker, E. Watson, and E. H. Young.

Apologies for enforced absence were read from Miss Gayton, Colonel Walker, Rev. W. E. Burkitt, Rev. H. Ellison, Messrs. G. W. Avery, J. Grimwood, G. Hayes, E. Walker, and F. B. White.

The minutes of the previous meeting were read and confirmed.

Mr. Cowan made feeling reference to the losses the Association had sustained by the deaths, a short time since, of Mr. W. H. Harris and, more recently, of Mr. W. Broughton Carr, both of whom had taken leading parts in the work connected with the Association's examinations. Mr. Carr had attended the meetings regularly and was an exemplary member of the Council, frequently persisting in doing the work even during illnesses. He moved a vote of condolence with the relatives, which was seconded by Mr. Reid and carried unanimously.

The Chairman, in formally moving the adoption of the report and balance-sheet, referred to the unsatisfactory condition of the finances. New members elected during the year about sufficed to fill the gaps caused by deaths and withdrawals. There had been some loss on the shows, which were not so well supported as previously. The number of candidates for examination equalled those of recent years, and in regard to the insurance

scheme the claims had been small compared with 1907.

The motion was seconded by Mr. R. Brown, supported by Mr. Pugh, and carried.

On the motion of Mr. G. H. Sander, seconded by Mr. C. L. M. Eales, thanks were accorded to the retiring Council and officers for their services during the year.

Mr. Cowan moved a vote of thanks to the Royal Society for the Prevention of Cruelty to Animals for the use of their board-room for meetings, which was seconded by Mr. Reid, and approved.

The president of the Wax Chandlers' Company and Sir James Whitehead were formally re-elected as president and vice-president respectively for the year 1909, on the motion of Mr. Reid, seconded by Mr. Lamb.

Mr. Reid also proposed the re-election of the other vice-presidents, hon. and corresponding members (to whom was added the name of Dr. Kramer, president of the German-Swiss B.K.A.), the motion being seconded by Sir Stanley Edwardes and carried unanimously.

Mr. J. Willard was re-elected as hon. auditor, and Mr. Otto Hehner as analyst, on the proposition of Sir Stanley Edwardes, seconded by Mr. Andrews.

A discussion took place in regard to the election of the new Council, there being six nominations for four vacancies, and a list of the attendances during the past year was asked for and given. The Chairman and Mr. Crawshaw both expressed the opinion that the true value of a member of Council could not be fixed by the number of meetings he or she had been able to attend. It was eventually resolved, on the motion of Mr. Meadows, seconded by Mr. Brown, "That as it has not been possible to print on the notice convening the meeting, as required by Rule VIII., the names of those members to be proposed for election on the Council, the retiring members of the Council be re-elected, and that at their next meeting the Council shall fill the four existing vacancies from the members who have already been proposed."

Mr. G. H. Skevington moved, pursuant to notice, "That no person interested in the sale of bees or appliances, either directly or indirectly, or having relations holding shares in the trade, shall be eligible to take an active part in the Association or act in the capacity of judge or examiner at the county shows."

This was seconded by Mr. Edwards, and after some discussion it was resolved, on the motion of Mr. Bevan, seconded by Mr. Watson, to proceed to the next business.

A vote of thanks to the chairman terminated the proceedings.

After an interval for light refreshments the members reassembled for the usual conversazione, which will be reported in our next issue.

NORTHANTS B.K.A.

ANNUAL MEETING.

The annual meeting of this association was held on Saturday, March 6, in All Saints' Schoolroom, Northampton. Mr. H. Collins presided over an average attendance, which included Messrs. Willmott, Billson, Askew, Kennedy, Timms, Osborn, Arlidge, Talbutt, Manning, Old, Norman, W. H. Chambers, &c.

In the report the committee had pleasure in stating that the accounts showed a cash balance of £15 7s. in favour of the association. The season of 1908 was an improvement on the previous year, but in this county was not a good one for the majority of bee-keepers. Very few large "takes" had been reported, but some very fine honey was harvested, which had again been well to the front at the large shows in London. The annual show was again held, by kind permission of the Corporation, in the Museum, Abington Park. About 200 exhibits were staged, from upwards of sixty-five exhibitors, making the largest and finest display ever held by the association. By the kind invitation of the president (Mr. C. W. Phipps), the officials and exhibitors were invited to tea, the guests including Canon Jones, Sir Henry Randall, &c. Mr. Herrod gave a talk on "Queen-rearing," which was listened to with great attention, many questions being asked, and answered by the lecturer.

The committee had pleasure in reporting a substantial increase in the subscriptions, and in stating that Mr. T. A. Roberts had been successful in securing the first-class diploma of the B.B.K. Association, and Mr. Parker the third-class. By the death of Mr. James Francis the association had lost one of its oldest members, who was also one of the officials for many years.

Mr. Roberts proposed, and Mr. Billson seconded, that the report and accounts as laid before the meeting be adopted, which was carried.

A vote of thanks was passed to the retiring officials, and the officials were then elected for 1909 as follow:—President, committee to appoint; vice-presidents, Earl Spencer, K.G., the Lady Knightley, Mr. H. Manfield, J.P., M.P., Mr. James Manfield, J.P., and Mr. C. W. Phipps; hon. secretary, Mr. R. Hefford, Sunnyside, Kingsthorpe, Northampton; hon. steward, Mr. R. Brawn; hon. treasurer, Mr. G. E. Atkins; hon. district secretaries and committee, Messrs. J. R. Truss, W. Manning, F. J. Old, C. J. Burnett,

F. Beale, A. Hiscock, C. E. Billson, H. Collins, G. Page, J. Bubb, W. Osborn, W. Orland, G. Odell, and L. Andrews.

The meeting closed with thanks to the chairman for presiding.—R. HEFFORD, Hon. Sec.

SUFFOLK B.K.A.

ANNUAL MEETING.

The first annual meeting of the above association took place on March 4 at Ipswich, when a good number of members and friends attended. The Rev. G. T. Carpenter (chairman) being too unwell to attend, Mr. J. B. Chevallier, J.P., presided. The report and balance-sheet were read and adopted. The chairman in his remarks said the association had made a very good start, and he thought the work had been carried out in a satisfactory manner. There was a slight excess of expenditure over receipts, which could not very well be avoided in starting a new county association. He (the chairman) looked forward to a successful future. The membership had increased considerably and included a number of new vice-presidents. Lectures on bee-keeping had been given through the support of the county councils, which created a keener interest in the industry. Prizes for honey were awarded at local shows, and a prize given for the best-kept and best-managed apiary to the Rev. D. L. Jones. Of the 2,323 hives and skeps examined by the county expert during the year, only forty-nine were found to be infected with foul brood. The season for honey proved exceptionally good in many districts.

The Earl of Stradbroke was unanimously re-elected president, and the new vice-presidents elected were Lady Barker, General Sir R. B. Lane, K.C.M.G., Colonel Barrington Baker, Colonel F. Pocklington, Colonel H. Corry, Major Meller, and G. H. Garrett, Esq. Mrs. E. P. Ridley has again consented to act as treasurer. Mr. A. W. Salmon was re-elected secretary. A sub-committee was formed to arrange a social gathering to take place in the coming autumn, when competition and exhibition classes would be held. The meeting concluded with the usual votes of thanks.—A. W. SALMON, Hon. Sec.

REVIEWS.

How to Keep Bees. By Anna Botsford Comstock, B.S. (New York: Doubleday, Page, and Co.; London: BRITISH BEE JOURNAL Office. Price 5s. net).—This book describes the knowledge gained in a small apiary, and has been prepared especially to meet the needs of the beginner in bee-keeping. It is not intended to be a complete treatise for the

professional bee-keeper, but to serve as an introduction to the recognised manuals now occupying the field. It is a charmingly-written book describing clearly in detail the necessary outfit, first steps, and methods. Mrs. Comstock's well-known literary ability has combined with her enthusiasm for the subject to produce a very interesting volume. The author is also a very expert engraver and is favourably known for her illustrations of butterflies and insects, which are fine specimens of engraving. There are 228 pages in this volume and thirty-two full pages of photographic illustrations, and the book is very well got up. We hope those who read it may find, as the author did, that "bee-keeping is a simple and delightful business, which can be carried on in a modest way without a great amount of special training."

Lawns. By W. J. Stevens, F.R.H.S. (London: Agricultural and Horticultural Association. Price 1d.).—How to make a lawn, how to repair one, how to keep it in a condition of velvety perfection are the subjects dealt with in this readable little handbook by a practical expert. The booklet is No. 19 of the popular "One & All" series, edited by Edward Owen Greening, F.R.H.S., a series now nearly reaching an issue of a million copies annually. The present number is as interesting as its predecessors, partly on account of the clear details and directions given, partly by reason of the numerous illustrations on every page, and last, but not least, because of an article by the famous Tom Hearne, of Lord's, who contributes an essay on "Cricket and Tennis Grounds" which gives welcome hints derived from special experience.

W. B. CARR MEMORIAL FUND.

	Amount already acknowledged	£	s.	d.
Sannyer Atkin	5	5	0
Northants B.K.A.	2	2	0
W. Boxwell	2	2	0
W. F. Reid	1	1	0
M. Rothwell	1	1	0
General Edwardes	1	1	0
Rev. H. Ellison	1	1	0
R. T. Andrews	1	0	0
C. H. Bocoek	0	10	6
C. L. M. Eales	0	10	6
Miss Hall	0	10	6
Miss Gayton	0	10	0
R. Brown and Son	0	10	0
G. Tudor Williams	0	7	6
T. Bevan	0	5	0
O. R. Frankenstein	0	5	0
J. W. Moir	0	5	0
J. Pearman	0	5	0
Mrs. E. E. Ford	0	2	6

£34 14 6

Donations may be sent to Editor, B.B.J. Office, or to Secretary, British Bee-keepers' Association, 12, Hanover Square, London, W.

Correspondence.

The Editor does not hold himself responsible for the opinions expressed by correspondents. No notice will be taken of anonymous communications, and correspondents are requested to write on one side of the paper only, and give their real names and addresses, not necessarily for publication, but as a guarantee of good faith. Illustrations should be drawn on separate pieces of paper. We do not undertake to return rejected communications.

NOTES FROM NORTH HERTS.

COLOUR AND CLIMATE.

[7414.] Mr. Crawshaw's views on the above subject (B.B.J., March 4, page 88) are delightfully clear, but there are facts that do not agree with his theory. Bees are insects, and the usual rule with regard to insects in general is that they become darker as one goes north. In explanation of this Lord Walsingham, who went somewhat fully into the subject, says: "Insects require rapidly to take advantage of transient gleams of sunshine during the short summer season, and may be content to sink into a dormant condition so soon as they have secured the reproduction of their species; only to be revived in some instances by a return of exceptionally favourable conditions." This theory is discussed by Professor Poulton, who remarks: "The most important support to the hypothesis is found in an experiment made by Lord Walsingham, in which several Lepidoptera of different colours were placed on a surface of snow exposed to bright sunshine: in half an hour the snow beneath the darker insects showed distinct signs of melting, but no effects were seen beneath the others. The differences were further brought out in the course of two hours, when the darkest insect of the lot, a black geometer, the Chimney-Sweeper, had decidedly won the downward race among them."

Mr. Crawshaw's opinion is that what is good for the bee is good for the wasp, and that therefore the theory is false. Now, I think the view is very generally held among biologists that the black-and-yellow banding of the wasp is an example of "warning coloration." It acts as a danger-signal to insect-eaters, and darker colouring would not only bring forth the queen-wasp before food was obtainable, but would also prove fatal to a considerable number of them from the attacks of birds. It is quite possible that the yellow bands have a "warning" significance in *Apis*, and may originally have been common to all the members of that family.

In some districts, however, the advantage derived from a power of absorbing heat was greater than that derived from the yellow colouring, and would account for the modification. I know perfectly well that our own bee is not the sole example of this change of colour; but in other cases a careful examination of the local conditions would probably reveal some factor that had contributed to the change. It is known that in some varieties of insects proximity to the sea coast is associated with a darkened colour, and this may be a possible explanation of the colour of some honey-bees. *Apis unicolor* of Madagascar is said to be quite black, and is thought by Professor Cook to be merely a variety of *mellifica*. A writer in the B.B.J. of 1886 states that the native bee of Madagascar inhabits dense forest or jungle, and I suggest that this may render necessary the increased power of heat-absorption. In other varieties, such as Carniolans and Tunisians, altitude might be adduced as an explanation. If the alteration in colour is without physiological value, it should still be possible to find a cause for the change.

It is curious that there seems an entire absence of facts to support Mr. Crawshaw's theory that, but for its conspicuousness, white would be the fashionable colour in the animal world for both winter and summer wear. The negro can work, without being affected, under a tropical sun that would scorch and blister a white man. There is evidence, too, that animals differ in sensitiveness to the action of the sun between those portions of the skin covered with white hair and other parts. White would appear to be the colour least generally useful, and, although common among Arctic birds and mammals, its principal value would seem to be for the purpose of concealment. That it is not a climatic necessity is shown by the exceptions where food-supply or escape from enemies would not be helped by a white colour. The sable in its rich brown fur can withstand the rigours of a Siberian winter; the raven is found as far north as any bird, and remains black.—G. W. BULLAMORE, Albury, Herts.

HIVE-CONSTRUCTION.

[7415.] Mr. Soal's useful articles on hive-construction which have appeared in recent numbers of the BEE JOURNAL will no doubt appeal more to the amateur than to the professional manufacturer of hives, who, one would suppose, is hardly likely to depart from his own stereotyped models. On this supposition, therefore, I venture, as an amateur, to make a few criticisms which otherwise I would not presume to do.

Mr. Soal puts his finger right on the weak spot in most of the "manufactured" hives when on page 57 he says, "This is a scant measurement." Perhaps it is the natural result of close competition that everything should be cut down to the irreducible minimum; but the amateur has no reason for copying this skimping policy, for to him a few inches of wood more or less means nothing in the outlay, but may mean infinitely much in subsequent ease and comfort.

The Body-box.—I notice that Mr. Soal advocates making this "a little wider." Exactly so. A body-box which just holds ten frames and a dummy—and "scant measurement" at that—is an article to make a bonfire with. Why not have plenty of room? No doubt it will be urged that making hives larger means making them heavier and more embroussed to move about. If moving about means occasionally shifting the position there is nothing in the argument; if it means moving to the moors in autumn, then I ask, What proportion of hives in actual use are ever moved in this way? I venture to think that more than 90 per cent. of our hives are practical fixtures.

Anyone who has experienced the many advantages of using hives which are large enough to take fourteen frames, even if ten or eleven frames are never exceeded, would, I feel certain, never go back to a ten-frame hive.

Which way the frames shall hang will probably always remain a debated point. Personally, I have no hesitation in giving it in favour of hanging them parallel with the entrance. The only valid argument I have ever heard against this position is the greater difficulty of ventilating in hot weather. This objection is entirely overcome by using a dummy at the back which is a full $\frac{3}{4}$ in. short of the floorboard, and by constructing ventilators in the floorboard itself as far *behind* the dummy as may be. Such openings in the floorboard are covered on the upper side with perforated zinc, and can be closed or opened at will from below by a sliding wooden shutter. The $\frac{3}{4}$ -in. bee-space below the dummy can be closed when desired by a loose strip of wood 1 in. thick. Besides allowing of enlarged brood-nest if desired, this additional space behind the dummy is an unspeakable comfort: bees can be fed there; combs and sections can be placed there to be cleaned up; the innumerable occasions when in manipulating one requires to hang a frame of bees somewhere for a few minutes are perfectly met by this convenient space. It also constitutes a ready-made "claustral" chamber, and can be used as such. Let me therefore urge anyone who is on the point of building a hive seriously to consider this point of size.

Lifts and Plinths.—From an amateur carpenter's point of view I do not agree with Mr. Soal in condemning plinths, or in substituting for them his plan of making the lifts taper so as to be smaller at top than bottom. It is much easier to cut pieces of wood rectangular than to cut them on the bevel, and if plinths are properly made and put on they are as perfect as they are simple. I have seen many "bought" hives in which the plinths consisted of miserably narrow strips of wood, cut with a square edge both top and bottom, and not even projecting so much as the "scant" $\frac{1}{2}$ in. which Mr. Soal allows as overlap. The plinth should be not less than $2\frac{1}{2}$ in. wide, the top and bottom edges being bevelled off so that rain cannot lodge on the top and shall drip off the lower edge without being drawn back to the hive sides. The plinths should be well covered with paint on the contact side, and nailed on while wet. They should project a full $1\frac{1}{4}$ in. below the sides.

Roofs.—Why these are so generally made "ridge"-shaped passes my comprehension altogether. It is no wonder, as Mr. Soal says, that the oft-repeated query in the B.B.J. is, "What shall we cover our leaking roofs with?" A ridge roof is a much more ambitious piece of carpentering for the amateur than a flat one, and I contend is not half so convenient. The latter serves as a convenient table when at work, and may be used as a "hiving-beard." Instead of nailing slats over the seams, it is better to cover the roof with either zinc, thin galvanised iron rather cheaper), painted calico, or—best of all—"Willesden" waterproof paper (or the canvas, which is rather stronger). Whatever material is used should be ultimately painted. I have such roofs covered with "Willesden" paper which have been in use nine or ten years and are perfectly good and waterproof to-day.—G. S. N., Godstone.

APICULTURAL NOTES.

DRIVEN BEES.

[7416.] Bee-keeping has indeed sustained a great loss by the passing away of our old and esteemed friend Mr. W. Broughton Carr, and I am sure that I am voicing the feeling of every bee-keeper in Huntingdonshire who knew him either personally or through the JOURNAL when I say that the news of his death was received with the deepest feelings of sorrow and regret. Those of us who knew him personally or have been brought in close contact with him knew something of the difficult position he had to fill, and I am sure that all have recognised and will acknowledge the tact and great ability

with which he discharged the duties entrusted to him. His name will be honoured in years to come, and he will ever be remembered with the most sincere respect and gratitude.

We have had a somewhat long and cold winter, frost more or less continuing during the whole of February. But fortunately there have been just enough mild days to enable the bees to take the necessary cleansing flights, and they appear to be coming through the winter well. The slight examinations made have revealed the pleasing fact that most stocks have plenty of stores and are strong in bees as far as can be ascertained by turning up the corner of the quilts. I find the best time to make this perfunctory examination at this early period is on a fairly cold day when the bees are clustering closely and not likely to take wing. The necessary examination under these conditions can be made in a few seconds, and no harm follows. If an inspection is attempted on a mild day the bees become excited and run about the combs, which makes it almost impossible to ascertain conditions without causing undue disturbance, which should of course be avoided, especially at this early date. When the time comes for a thorough examination mild days should be chosen.

A great deal has been said of late about driven bees and the profitableness or otherwise with which they can be handled. I have had a long and varied experience in the matter, and am not at all sure that, taking everything into consideration, building up stocks with driven bees is the cheapest and best way of increasing an apiary, even if bees can be had for only the trouble of driving them. In fact, I have troubled very little about driven bees for some years past, except when I have had some spare stored combs on which to put them and the owners of the bees have asked me to take them up. Even then I have done it more to oblige the bee-keeper than from any particular desire on my part to have the bees. The experienced bee-keeper has other and better ways of obtaining increase. I have on several occasions built up stocks by giving driven bees comb-foundation and feeding for several weeks. It was a pleasing sight to see bees entering hives in the autumn laden with pollen and to notice the large patches of evenly-sealed brood and hatching bees on the combs. While preparing such stocks for winter there appeared to be no more, but rather fewer, bees than there were at the time they were driven from the skep. This seems to show that young bees had only been raised to take the places of those worn out in rearing them. I doubt whether bees raised late in the autumn, which have to go into winter quarters almost before they have

been able to leave the hive, are as fitted to stand the rigours of a long and trying winter as those that are of a more matured age, or have equal stamina. As Nature demands a period of rest, it is only reasonable to expect that a queen which by artificial means has been induced to continue laying several weeks later than she otherwise would have done will be correspondingly late in commencing to lay the following season. For these reasons I have for some time now discontinued any attempt to encourage late breeding, except under exceptional conditions and circumstances.—ALLEN SHARP, Brampton, Hunts.

[Although we agree with our esteemed correspondent respecting bees driven late in the autumn and having old queens, we have known those driven in August, headed by a young and prolific queen, supplied with built-out combs, and fed liberally, raise young bees in sufficient numbers to become the earliest and lustiest workers in the spring, and thus to compare favourably with May swarms.—Ed.]

MODERN HIVE-CONSTRUCTION.

[7417.] May I be allowed to correct a slight misconception of Mr. D. S. Taylor (B.B.J., March 4, page 87) with regard to my statement that $17\frac{1}{16}$ in. is the inside, *not* the outside, measurement of a "W. B. C." body-box from front to back *at top*? It matters not how the closing-in strips are nailed on; they still form an integral part of the body-box, and in measuring the length of the latter, when complete, their thickness must be taken into account. Mr. Taylor seems to be under the impression that I nail these closing-in strips *between* the ends of the side boards instead of *on* to them. This is not the case; in fact, my method of putting together the body-box seems to be identical with that so well described and illustrated by your correspondent, including the grooving of side boards and the space under frame-ends.

In conclusion, I hope now to have satisfied Mr. Taylor that we really agree on the one point in which we appeared to differ, and as he is a practical hive-maker I value his opinion accordingly.—SAML. P. SOAL, Rochford, Essex.

BEE-FLOWER SEED DISTRIBUTION.

[7418.] I am enclosing a packet of "Chapman honey-plant" seed as a specimen of those our association is distributing as an experiment this year to school-children through the medium of the masters and mistresses. If the experiment proves successful, we intend to go in for seed-distribution on a much

larger scale next year. This scheme might be carried out by other associations, who possibly have not thought of it. The schoolmasters are allowed to use their discretion in giving only to those who can be relied on to grow the seeds. We propose to offer small prizes for the best blooms or the greatest number of blooms, and think that while it may develop in the children a love for flowers, it will also help to fill our surplus-chambers and popularise the plant. We have commenced in a small way with about 600 packets of thirty seeds in each, and so far it has proved a success, the seeds being supplied gratuitously by one of our members. While on the subject of flowers, may I mention a few which are worthy of a place in every bee-keeper's garden—*Campanula pyramidalis*, *Veronica spicata*, Iceland poppies, and an ordinary parsnip left for seed when in bloom swarms with bees.—A. WAKERELL, Hon. Secretary Croydon and District B.K.A.

[This interesting example could well be followed, for although much has been done in the way of distributing seed, there is room for much more to be done. As far back as 1874 several pounds of placelia seed were given away to cottagers, and since then we have been the means of distributing gratuitously many pounds of *Echinops sphaerocephalus*, the plant our correspondent alludes to, being, we believe, the first to introduce the seed into this country. As president of an association which has distributed many thousand packets of seeds to school-children, we have also had the pleasure of giving away the prizes awarded for flowers grown from them. On the Continent the practice is quite common, and in some places railway officials are encouraged to sow such seeds along the embankments.—ED.]

CAPPINGS OF COMB.

BY L. S. CRAWSHAW, NORTON, MALTON.

Lubrication and Lubrication (page 66).—Really, "D. M. M." you are a hard taskmaster and a doughty foe. First it was lubrications and now it is "leger-demain." But there need be no "suspicion," as there is no intended slight (of hand), nor any eye-deceiving attack in juggler vein, meant to overcome superior strength by verbal *jiu-jitsu!* Nor is there "anything up the sleeve," which is indeed turned humerus-ly high the while this lubricating midnight oil is burnt. For since you compel me to be serious, I find the meaning of your word to be just as truly "study by the candle of the night": "dips" of bygone days, and into the dark and printed past. "Cappings" are admittedly such dips, and if they do not, it is to be feared, always illumine the way, they will not

be wasted, though the effort makes them wax a trifle warm, if when rendered they serve the sister-purpose of lubrication. And if I sometimes "lubricate" over long it is because, like the immortal Toddie, I like "to see the wheels go round"!

And now to counter your blows, or "give you best."

1. Yes; that makes your meaning clear. I ought to have known that you meant the queen *would* act the same. But on page 3, by a slip of the pen, you question whether she would.

2. To be quite fair, I hardly understood you to say "swarm," as the bees were being shaken out of sections (1908, page 414). But, in any case, I have explained that this had reference to a statement that drones are always present, and that fertilisation may take place in the hive (page 346, lines 12 and 34).

3. I hope no one imagined the cask was your own. I thought it was an empty fiction, which you had filled and used as a "butt."

4. Yes; I see the connection which you point out between "the sting in practice" and the "Böhrer theory," but if I remember aright the doctor holds the impregnation to be involuntary, and that the acid acts as a preservative, even though it affects some digestions adversely. So that if ever "Cappings" should not "go down" easily, I trust you will be thankful that it is nothing worse than good formic acid, to which you ought by now to be pretty well immune! And you know that in return you give "stinging" blows at least as good as you get! So the next time I feel particularly "vitriolic" I must write "Cappings" anonymously, and then you won't be so inclined to hit me back!

Driven Bees (page 67).—I fear that we cannot agree without a common basis. "D. M. M." insists that the calendar year shall define the limits of the season, whereas I maintain that the season is a contained and practical period. Thus, in his case, a lot of driven bees obtained on December 31 were last season's bees, whilst those of January 1 belong to this season! I should class both lots in theory as "between the seasons" and rank them with swarms of the same between-season, whether these occurred in the late summer after the flow, or, as usually, in the ensuing spring. For, according to his arguments, bees purchased after the honey-flow must be compared with those purchased before it, but there is no limit to this style of comparison if it be allowed. Thus, an even worse showing may be made by comparison with bees of two or three seasons before! I must also attempt to gainsay "that driven bees lie fallow for

a whole year." Apart from the real drift of the contention, I expect them to produce a swarm the following spring, or at least to compete on favourable terms with a prime swarm of what I, rightly or wrongly, term the same season. As to the unproductive outlay, what is it? Say, 15s. at 5 per cent.! Perhaps at no per cent. at all! So if you like to say 15s. 9d. for the driven bees, and 15s. for the swarm, then the interesting nineness must represent a number of solid slabs of brood in all stages. Fallow! As well might one say that autumn-sown seed is fallow and unproductive, and dearer than the same seed purchased in the spring, although it may sprout the sooner and give the better result.

A *De-capping Rake* (page 69).—This small tool may perhaps fill a useful purpose. If I might suggest any alteration I would punch a couple of small holes about 1 in. apart at the handle end. Then the tool might be nailed to a handle of wood, which, with a loop, would prevent loss and increase control of the tool. These tools should be very welcome to those who find it necessary from time to time to have a good scratch at "Cappings of Comb"!

"W. B. C." (page 74).

Ay, tell the bees! Tell all! tell all!

"Brownies, your friend is dead!"

Tap on the hives—the great—the small:

"Brownies, your friend is dead!"

Make the sad journey, tie on the crape:

"Brownies, your friend is dead!"

Each little habitat mournfully drape:

"Brownies, your friend is dead!"

Ay, tell the bees! Each one! each one!

"Brownies, your friend is dead!"

Sunk in the west is the light of his sun:

"Brownies, your friend is dead!"

He who so loved you is gone from your ken:

"Brownies, your friend is dead!"

No more to visit you, never again:

"Brownies, your friend is dead!"

Ay, tell the bees! Miss none! miss none!

"Brownies, your friend is dead!"

Tell to the hives that his work was well done:

"Brownies, your friend is dead!"

Close though you cluster in winter's long sleep,

"Brownies, your friend is dead!"

Can you not hear as above you we weep?

"Brownies, our friend is dead!"

TRADE CATALOGUES RECEIVED.

JAS. LEE AND SON (*Head office and motor-power works: Martineau Road, Highbury, London, N. Showroom: 10, Silver Street, Bury Street, High Holborn. Bee-farm: Fulbourn, Cambs.*).—This is a well-got-up illustrated price-list of hives

and appliances supplied by this well-known and old-established firm. Amongst the novelties we notice that they have introduced an improved form of claustral hive and a semi-observatory hive having a glass back, showing the ends of the frames, useful for ascertaining the strength of the colony without opening the hive.

E. L. AND H. C. JONES (*The Bee-keeper's Supply Stores, Monks' Acre, Andover*).—Messrs. Jones's price-list is well got up and nicely illustrated. They make a speciality of supplying stocks and swarms and neat colour-printed honey-tins, which present an attractive appearance, and are just the thing for creating a market for honey put up in them.

Queries and Replies.

[3897.] *Moving Bees to Clover Field*.—Would you kindly give me your opinion through the B.B.J. respecting the following? I reside in a village where there is plenty of bee-forage, but it is of a mixed character and lime trees are plentiful. I have three hives, and would like to take one of them to a clover field about a mile away. I would like some clover-honey if I could manage it, but am afraid it will be mixed with lime, blackberry, and wild mustard. The clover will be at its best in June and July, and the second crop in August and September. I should like to know if it would be worth while to try it.—H. B.

REPLY.—You would have to take your hive at least three miles away, and leave it there for a week or ten days, and then bring it back two miles to the clover-field. Even then, as you have so much pasturage round you, you could not be certain of getting all clover-honey. We do not think it would answer your purpose to do this, as the field at a mile from you is quite within reach of your bees, and they would visit it if they were not able to get nectar nearer home.

[3898.] *Quality of Honey Collected by Different Races of Bees*.—As a constant reader of the B.B.J. I should like to be enlightened through your columns on the following points, viz.: 1. Is there any truth in the statement that different races of bees show a tendency to gather different qualities and colours of honey? My reason for asking the above question is that I read the other day in a gardening paper that Italian bees will store light-coloured honey when natives, in the same apiary, will be storing honeydew. 2. In a cross between two races do the distinguishing characteristics of each race show as strongly as in the pure races? 3. How do Carniolans compare with other races in respect to my first question? 4. Is there any book published where the whole question of the performances of the different races and hybrids is gone into exhaustively? As there are so many conflicting opinions as to the qualities of different races, it would be satisfactory to read the detailed experiences of a competent bee-master over a number of years, in which he stated clearly the results obtained with the different bees in regard to quality and quantity of honey, hardness, temper, &c. If this information could be given in tabular form, with marginal notes describing the kind of weather in which the performances were carried out, it would no doubt be a pretty conclusive form of evidence of the value of the various races under varying conditions. I shall feel obliged if you can let me know (briefly if necessary) in an early

issue your opinion on above points.—CHARLES MACFARLANE, Glasgow, March 6.

REPLY.—1. We have had bees in the same apiary storing light honey while others were gathering dark, and this is not peculiar to any particular race, but depends upon the flowers visited by the bees. To mention a case in point, clover and buckwheat may be flowering at the same time. If the bees commence collecting from clover blossoms the honey will be light-coloured; while other bees, in the same apiary and of the same race, might start on buckwheat, and produce a dark-coloured honey. We have even had combs in the same supers of different colours due to the same cause. 2. As a general rule queens transmit working qualities and constitution, while disposition comes from the drone. A queen from a good-tempered and industrious colony, mated with a drone from a vicious colony, would produce bees having the characteristics of both strongly developed—that is, irritable, but good workers. 3. The same in this respect. 4. We know of no such book.

[3899.] *Transferring Bees*.—1. I should be much obliged if you would advise me what to do this year with my bees. I have one stock, bought last June, in a cheap bar-framed hive, not standard frames, the combs old and black. These bees did very well last year. Can they be transferred this spring to a good hive? As the frames are wrong size, I could not transfer them. 2. I have two weak lots in skeps, bought last October. Can these be united now in a new hive, or should they be united in one of the skeps and allowed to swarm, waiting for the autumn before transferring to a new hive? 3. Can you inform me of the address of the bee-association at Brighton?—BEGINNER, SUSSEX.

REPLY.—1. Place the hive on the top of another containing standard frames fitted with comb-foundation, and allow the bees to transfer themselves. When the queen has gone down and has commenced to lay in the new combs, place a sheet of excluder-zinc between the two hives. In twenty-one days all the brood will have hatched out of upper hive, which can then be removed. This should be done this spring. 2. They can be united when the weather is favourable in April in one of the skeps, and allowed to transfer themselves if strong enough to do so. 3. Mr. W. Edwards, hon. secretary, Sussex Bee-keepers' Association, Wilmington, Hassocks.

[3900.] *Removing Ekes*.—1. In early October I wintered bees in eight "W. B. C." hives with a 3-in. eke (for the first time) below brood-chamber in each. These ekes cannot be taken off without removing all the winter packing between inner and outer cases. Willow and other pollen is plentiful here in early spring, but there is no clover, and practically little bee-forage till end of June, and weather is generally cold and uncertain till end of May, so I always feed with syrup. How long will it be safe to leave these 3-in. ekes on without risk of bees beginning to fill them with comb? 2. In what position in each hive shall I give a frame of sealed honey retained from last season? 3. I am told that sections in racks *must* run parallel with frames below. My racks only fit body-box exactly when sections run at right angles to frames. Does it really matter? 4. When troubled with robbing would it injure bees to imprison them for three or four days by inserting strips of perforated zinc in doorways, and would this cause attacks to cease? In spite of all precautions I was greatly troubled last year, and I have no way of moving attacked hives to a distance, and have no dark cellar to put them into as advised in "Guide Book."—CHAS. DUNLAP, Arran, March 9.

REPLY.—1. Winter packing could be removed in April in your district, and the bees transferred to clean hives. The ekes can then be taken away.

as there is no object in retaining them after that time. Bees would not build combs beneath the frames until honey was coming in plentifully and the hive was crowded with bees. 2. Place it at the side of brood-chamber. 3. It matters very little which way the racks of sections are placed. 4. Yes; although closing the hive for a few hours will do no harm provided there is sufficient ventilation (see page 162, "Guide Book").

[3901.] *Bacillus Alvei*.—1. I should be pleased if you would inform me of a really good work on *B. alvei*. 2. What are the best culture media for the bacilli? Will glycerine, agar, blood serum, or glycerine peptone do? 3. What power of incubation in Hearson's incubator is necessary and what temperature? 4. Will methylene blue do as a staining medium or would you recommend a better and more distinctive one? 5. What part of the larva is mostly affected by the bacillus? Is it general or localised in any particular system? 6. Is there any method besides great heat that will destroy the spores of the dreaded disease? 7. Do you think an oil-immersion lens would be the best for spotting the organism, or what power would you advise? Trusting that my queries will not overtax your usual kindness.—G. TUDOR WILLIAMS, Aberdare.

REPLY.—1. *Bacillus alvei* is mentioned in most books on bacteriology; but if you could get "Foul Brood of Bees," by F. C. Harrison, Professor of Bacteriology, Ontario Department of Agriculture, Toronto, Canada, you would find in it the best information respecting this organism. 2. Grows on bouillon, agar, gelatine, and very slowly on blood serum. 3. You require a proper incubator constructed especially for this kind of research, and which can be regulated to the different degrees of temperature. *B. alvei* thrives best at 37 deg. C. 4. Yes; but the most satisfactory stain is methyl violet. 5. Principally the alimentary canal, but the bacilli are found generally throughout the blood. 6. The spores resist great extremes of temperature, and anything that will destroy them would be equally fatal to bees. 7. A $\frac{1}{2}$ in. oil-immersion objective is the one generally used for such work.

Notices to Correspondents.

PERPLEXED (Henley).—*Queen-rearing*.—It is not necessary to remove the eggs from worker-combs. See page 125, "Guide Book."

ANXIOUS.—*Queen-rearing Hive*.—If you will read the instructions carefully you will see that the bees make the queen-cells, and the bee-keeper only directs and assists them by enlarging the mouth of a cell containing an egg. You have nothing to do with transferring eggs in this case. All queen-rearing operations should be performed in suitable weather.

L. D. (Hants.).—*"Doolittle" System*.—You propose to take away combs partially filled with honey just at the time bees need it most, which is not a reasonable thing to do.

S. MARFLEET (Isle of Wight).—*Insurance*.—The cost for twelve hives would be 1s., and the premium must be sent with the form to Mr. E. H. Young, secretary B.B.K.A., 12, Hanover Square, London, W. The policy covers the period from March 25, 1909, to March 25, 1910.

Suspected Comb.

CYMR0 (Ruabon).—There is no foul brood in comb sent. The bees have died of starvation, which is seen by their position head downwards in the cells. There is a small patch of chilled brood, and it is evident that the cluster of bees was too small to generate sufficient heat to enable it to get round to the stores.

* * * Several important letters, &c., are in type, but held over from pressure on our space.

Editorial, Notices, &c.

BRITISH BEE-KEEPERS' ASSOCIATION

(Continued from page 113.)

CONVERSAZIONE.

At the conclusion of the meeting the members, after refreshments had been served, reassembled for the usual *conversazione*, when Mr. T. W. Cowan, on the motion of General Sir Stanley Edwardes, was unanimously voted to the chair.

Among those present were Mrs. E. C. Ford, Mrs. L. G. Hamilton, Mrs. Seadon, Misses L. M. Carr and E. Scott-Walker, Mr. and Mrs. J. C. Mason, Messrs. R. L. Andrews, Sannyer Atkin, W. F. Abbott, W. Boxwell, T. Bevan, Basil E. Buckwell, E. J. Burt, R. Brown, L. S. Crawshaw, J. D. Dalzell, C. L. Eales, H. Edwards, E. Garcke, L. L. Goffin, W. Herrod, G. W. Judge, J. B. Lamb, R. Lee, W. P. Meadows, W. J. Owen, A. E. Paul, A. G. Pugh, W. F. Reid, E. R. Ridgers, A. Richards, A. E. Smith, L. McNeil Stewart, G. H. Skevington, E. R. Seadon, J. Silver, G. H. Sander, H. J. Upton, E. Walker, A. Willmott, W. G. Wells, E. N. Watson, E. H. Young, and others.

The Chairman opened the proceedings by calling on Mr. Sladen to read his paper, entitled "Feeding Bees." It would be remembered that the subject was on the agenda for discussion at the last *conversazione* in October, but was postponed owing to the inability of Mr. Sladen to be present on that occasion.

Mr. Sladen: On the subject of feeding bees there is perhaps no question of greater general interest than whether we should feed to stimulate brood-rearing or not. There can be no doubt that feeding in favourable weather in spring, while as yet few honey-producing flowers are in bloom, increases brood-rearing. But in many localities and seasons, almost as soon as genial weather can be counted upon, sufficient fresh food is obtainable from the flowers. Feeding in cold, changeable weather, besides being ineffective, is harmful, stimulating the bees to unnatural activity, increasing wear-and-tear and the death-rate. Moreover, in cases where the gain from stimulative feeding is undoubted the practical bee-keeper may find that it vanishes when the cost of the feeding is taken into consideration. Nature may be helped; she cannot be driven. There is great difficulty, and no advantage, in breeding bees out of due time. This is a truth that the enthusiastic beginner needs especially to remember. Stimulative feeding is best employed during periods well on in spring, either following late frosts which

have kept vegetation back, or in which the weather, while not cold, is unfavourable enough to prevent honey-gathering. In exposed places on the coast and in the North, which are subject to cold winds throughout the spring, it is certainly better that the bees should depend for food on an abundance of sealed stores rather than on the feeding-bottle. Stimulative feeding *after* the honey-flow is a somewhat different question. In this case the *weather* is all that can be desired, but the effect of food in increasing brood-rearing is small, and much syrup is consumed with no other result than exciting the bees, whose energies we want to preserve for the winter and spring. Such feeding has, on the whole, even less to recommend it than spring feeding. One has to bear in mind that giving food to bees is more like giving physic than food to other animals. The less it is necessary the better. It must be done promptly and liberally at times—for instance, when starvation threatens; but on other occasions—for example, when the bees should be quiescent, or when the feeding is likely to induce robbing—it does more harm than good. In my own apiary the general practice of stimulative feeding is not followed, for I find that with an abundance of sealed stores and prolific young queens breeding extends as fast as weather permits, without any artificial aid whatever. In September, if any colony has not a plentiful enough supply of sealed honey to last it, if need be, until the following June, the deficiency is made up by rapid-feeding. In this way feeding with candy in winter and in early spring is altogether avoided. The best time to do the feeding is found to be during the third and fourth weeks in September. If done earlier more food is required, more being consumed.

Mr. Sander said he would like to know what Mr. Sladen thought of the advisability of feeding by uncapping in the spring in preference to giving food.

Mr. Sladen thought, as a general rule, bees did not require stimulating food in the spring. Even uncapping in spring was open to objection, as the food would be used more rapidly than it should be, and would not be converted into brood. The same quantity of brood would not be produced per pound of honey uncapped in unfavourable weather as under normal conditions. If the weather was favourable, the point raised came under the conditions in which he had explained that syrup would be an advantage.

Mr. Sander said that Mr. Sladen appeared to deprecate the state of affairs that would arise if things were left alone. It was generally accepted that the queen only laid sufficiently rapidly when honey

was coming in; therefore the ordinary bee-keeper wanted to stimulate the queen, so that she might produce more brood. He (the speaker) would be glad to know whether that principle, which seemed perfectly reasonable, was also deprecated by Mr. Sladen.

Mr. Sladen did not deprecate the principle, but thought it should be carried out with great caution. There were conditions in the spring under which it could not be adopted satisfactorily. In many apiaries in the North and on the coast it was not advisable to spring-feed. He had endeavoured in his paper to bring forward the different points for and against spring-feeding. (Mr. Sander replied that it seemed to him more "against" than "for.")

Mr. Lamb thought that in the matter of spring-feeding there was a definite scheme to be borne in mind. All tried, or should do, to get their stocks into the best possible condition at the date when they were required to gather honey. It was no good to have them ready in Middlesex before the first week in June, when the honey-flow started. He always tried to get his stocks prepared with sealed brood from back to front by the end of May. What was the use of having the bees ready earlier when there was nothing to be got? When he was younger he used to think it the correct thing to have plenty of bees early, but experience showed that he had to keep feeding them while they were unable to go out and gather nectar. His view was that bees should be fed when necessary to get them into the best condition on the eve of the honey-flow, and if that were carried out it was all that a practical bee-keeper need do.

Sir Stanley Edwardes quite agreed with what Mr. Sladen said with regard to feeding. He had always been accustomed to feed the bees according to the "Guide Book" recipe. Supposing when he looked into his hives presently, although he was under the impression they had plenty—for he gave them the usual food in the autumn—he found that they were very short of stores, he presumed he would be quite justified in giving them food, but not for stimulating, and he gathered from Mr. Lamb that it should not be administered till the month of May, so as to produce its effect in June, at the time of the honey-flow. If they had no stores, he took it for granted he must feed them, which could not be looked upon as stimulating them. He wanted to get information on that point, as it was very nearly time when an inspection should take place.

Mr. Crawshaw suggested that this was a subject upon which a diversity of opinion easily arose owing to difference of

conditions, such as the date of the honey-flow, the number of hives kept, the age of queens, and the qualities of the strain of bees. A small bee-keeper might perhaps do some useful "tinkering" which would be quite impracticable for the bee-farmer. A young queen would usually provide in the spring as much brood as her bees could reasonably care for, whilst the cost of such vigorous queens, even though purchased, was in the long run less than the labour of stimulating inferior queens; and the strain of bees was important, for some strains appeared to rear brood recklessly, others reluctantly, and to cease doing so at the least excuse. An acclimatised strain of bees was desirable, and such a strain should be ruthlessly subjected to selection. It did not pay to be constantly bolstering the weak. He believed in doing spring-feeding in the autumn, and at any time in good big "dollops." The objection to this in spring was that it might reach the supers, but late in summer it was capped over, and if spring-feeding were ever necessary he would prefer to give combs of such sealed food. But if the bees were right and rich in stores, the matter of stimulation might be very well left to them.

Mr. Brown thought the speakers had not taken into account that some stocks of bees would consume a great deal more honey than other stocks; therefore it did not follow that the amount of food which was abundant for one stock was equally so for another.

Mr. Sladen said the question appeared to be, "Shall we feed in the spring if there is a dearth of food in the hive?" That would be feeding to prevent starvation. Of course; but that was not his point. The question he raised was, "Shall we feed to stimulate brood-rearing, presuming the bees have been properly wintered?" They should go into winter quarters with about 30 lb. of stores, or at any rate plenty to keep them till the following June. If that was not done the colony was not properly fed, and they would have to be fed. The point at issue was as to stimulative feeding in spring or autumn, as, for instance, the giving of syrup every evening or twice a week. With plenty of food in the hive he thought not. That was the question. There was a difference of opinion among bee-keepers thereon.

Mr. Herrod said he had not heard Mr. Sladen mention anything about pollen.

Mr. Sladen said the bees began to gather natural pollen in his district very early in the spring. In Australia the bees could not rear brood for want of pollen, but in this country even in February they were able to get some pollen.

Mr. Silver said he had not heard the whole of Mr. Sladen's paper, but invited

him to give an opinion on the merits of candy or syrup for feeding in February and March. Take as an example: If in the second week in February, by way of extra caution, one looked under the quilts and saw the stocks on the verge of starvation, what would Mr. Sladen do? Would he give candy or syrup? Some people said that candy enticed bees out for water, when they perished in the cold.

Mr. Sladen replied that he had never had his bees in such a condition in February, which he should attribute to bad management, but in such a case he would recommend well-made soft candy. He would not like to give his bees syrup in February, and reiterated that they ought to be fed in the autumn with plenty of food, which they could store in their combs and seal over.

The Chairman, in closing the discussion, emphasised what had already been said, namely, that feeding depended on the district and condition of the bees. The rule was to feed them in autumn, but if the bee-keeper could manage to do without that, all the better. He (the Chairman) had succeeded in avoiding it for the last two years. He left the bees sufficient food in the autumn, and they commenced breeding in the spring as usual. He was able to keep them quite strong enough for that. At the same time he recognised that there were districts where stimulation in the spring was necessary; but he found, as already explained, that his own bees succeeded well without feeding at that time so long as they were provided with sufficient in the fall of the year. He preferred to leave them with honey enough in the combs, though of course he would give them syrup if there was not the necessary amount. Up to the present he had not examined his bees, and was not going to do so at all until the fine weather appeared, possibly at the end of the month; at the same time he was perfectly certain they had plenty of food. The queens were already laying. He knew that because he had seen the bees carrying in pollen. They were no doubt doing their best in a quiet way. If he wanted to stimulate them he would scrape the combs. In his district a large number of bees would be of no use at all early in the season. It was quite soon enough for them to be in evidence when the fruit trees were in bloom. A question had been asked about stimulating them. If the bees were not forward enough upon examination, which ought not to be made before the middle or end of March (they ought to be in such a condition as not to require feeding before), then there was bad management somewhere, especially if it was necessary to give candy in February. Directly candy was administered rapid breeding com-

menced, which disturbed and worried the bees; their inability to get out caused dysentery, or they suffered in some way sooner or later. They had had a very interesting paper and discussion, for which he desired on behalf of the meeting to thank Mr. Sladen.

Mr. Sladen said he would like to endorse the Chairman's remark that it was far better not to feed the bees at all if possible, and this could generally be secured by providing them with plenty of honey in the autumn. As regarded feeding in the spring, he thought May was the best month for it, or even June in bad seasons, while March and April were permissible under other circumstances and in special districts.

(Continued next week.)

LANCASHIRE B.K.A.

ANNUAL MEETING.

The annual general meeting of the above association was held at the Preston Scientific Society's Rooms, 119A, Fishergate, Preston, on Saturday, February 27 last. E. Lawrence, Esq., of Chorley, who occupied the chair, expressed the regret he felt, which was doubtless shared by all present, at the absence of Dr. Anderton, who had unfortunately met with an accident to his eye.

Before commencing the business, a vote of condolence with the relatives of the late Mr. W. Broughton Carr, who had so recently passed away, was carried in silence, after several of the older members had expressed their many pleasant recollections of him, and of his inception of, and association with, the old Lancashire and Cheshire Bee-keepers' Association. A similar vote to the relatives of the late Mr. Little, of Chester, was also passed.

Copies of the report of the committee being in the hands of all the members, it was taken as read. It showed that although there was a slight decrease in the membership, the association had again done good work.

The treasurer read the statement of accounts, which showed a balance in hand of £27 9s. He pointed out that although the balance was a good one, the association would possibly need it during the coming season, as a new bee-tent was required, and they had undertaken the entire financial responsibility of the honey department of the Lancaster Agricultural Society's show, with the intention of making it the county honey show in future. He hoped that members would do all they could to make the venture a success.

The chairman moved the adoption of the report and balance-sheet, and said he was pleased to see that the association was in such a flourishing condition.

Votes of thanks were passed to the committee, officers, and hon. auditor, also to the Preston Scientific Society and Mr. Heathcote, its secretary, for the use of the rooms and for his unfailing courtesy. It was resolved to ask R. Wilson, Esq., the Mayor of Lancaster, to be president for the year. The vice-presidents were re-elected *en bloc*, and several names were added to the list. The committee were re-elected, as were also Mr. F. Taylor as treasurer and librarian, Mr. J. N. Bold as secretary, and Mr. A. Wood, of Manchester, as auditor. Miss S. Wilson, of Lancaster, together with the librarian and auditor, were re-elected honorary members.

The committee afterwards met and unanimously re-elected Dr. Anderton their chairman for the ensuing year.

During the interval for tea Mr. W. Herrod, of Luton, undertook the duties of judging the exhibits in the honey competition. The prize hive, in the class for cottage members, this year presented by the treasurer (Mr. F. H. Taylor), was awarded to a member from the Hesketh Bank district. Prizes of medals and books were also awarded for honey and for wax.

After tea the members and their friends reassembled in the room, and Mr. Herrod gave a most helpful and practical lecture on "A Year's Work in the Apiary," illustrated by many splendid slides. Mr. Lawrence presiding and Mr. Heathcote manipulating the lantern. The members were not only delighted with the lecture, but also gratified beyond measure to see their old friend and expert Mr. Herrod again in the county.

A vote of thanks to the chairman, lecturer, and lanternist was passed with acclamation, and brought to a termination another most successful annual gathering.—J. N. BOLD, Hon. Sec.

Correspondence.

The Editor does not hold himself responsible for the opinions expressed by correspondents. No notice will be taken of anonymous communications, and correspondents are requested to write on one side of the paper only, and give their real names and addresses, not necessarily for publication, but as a guarantee of good faith. Illustrations should be drawn on separate pieces of paper. We do not undertake to return rejected communications.

**.* In order to facilitate reference, Correspondents, when speaking of any letter or query previously inserted, will oblige by mentioning the number of the letter, as well as the page on which it appears.*

BEE-KEEPING IN JAPAN.

[7419.] The enclosed photographs will be of interest to readers of the B.B.J., as showing one of the very few somewhat up-to-date apiaries of Japan. I have

always kept my eyes open, when going about Japan, for bee-hives; but they are very scarce indeed. Curiously enough, the only two modern ones I have seen in this part of Japan I discovered when out motoring. Of this I do a great deal, as far as the roads will let me, and it enables one to see much of the country, for, as one cannot safely go more than twelve to fifteen miles an hour, the speed is not too great to look about fairly well. The apiary of which I send photos is at Fushimi, which is the port of Kyoto; that is to say, one can get boats drawing 2 ft. up the thirty miles of river from the sea at Osaka, and it is most astonishing how much traffic is done over this very difficult navigation. From Fushimi quite a wonderful canal takes the boats on to Kyoto, lifting them about 150 ft. on an electrically actuated incline; then another far longer and higher incline takes the boats on Lake Biwa, going under the mountains in three tunnels, one nearly two miles long.

Fushimi is an ideal place for bee-keeping as far as Japan is concerned; an English bee-keeper would probably not continue there more than a year, for after May there is no crop to gather honey from anywhere. In April and May the rape-oil plant (*Brassica chinensis*) as a crop covers half the country, and its mass of yellow blossom is a wonderful sight, and it ought to afford a good harvest of honey. After that nothing for a crop, but enough to keep the bees alive. There are some flowers all the year round, and the climate is good enough to allow bees to gather something in nine out of the twelve months. The enemies of the bees are very numerous, and a constant watch has to be kept on the hives. The wax-moth is more destructive here than in any place I have seen; the dragon-flies hawk the bees, and many on the wing are lost thus, and often the queen. Then in the autumn hornets go to the alighting-boards, and often deplete the stocks for the winter. I have counted over a dozen bees taken by hornets within five minutes.

Then the bees themselves are not good gatherers. They are smaller than our bees, so much so that ordinary comb-foundation is not worked successfully. The owner of the apiary is Mr. S. Tomura, and he devotes all his time to it, but of course is satisfied with a very low yield per hive compared with England and America. He gets, however, a higher price—10d. to 1s. per lb.—for his run honey, which is put up in nice-stoppered bottles of Japanese make. Of comb-honey he produces none. His hives are small, and he says this is necessary in Japan, for the stocks are quite small—I have not seen one that would nearly fill an or-

dinary English hive. Everything is very neat and tidy about the apiary, and the office shown in the picture is used to store

I shall hope to see you this year, as I intend to come to England for some months. I have been try-

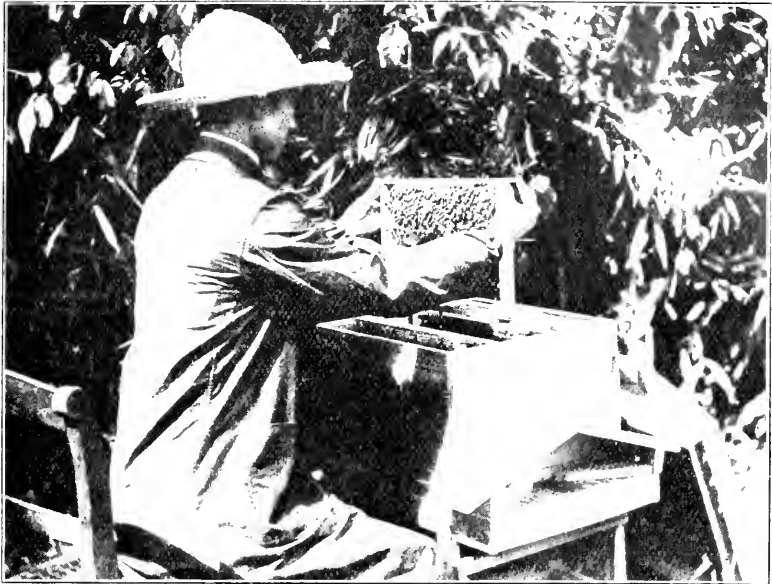

MANIPULATING A FRAME-HIVE IN JAPAN.

his frames, and in it is a very fair geared extractor of Japanese make, it having

ing to get some information for Colonel Walker, but have not been very



A JAPANESE APIARY.

been made to order by a local tinman. The tinmen, I may say, are very excellent workmen in Japan.

successful so far. With kindest regards.
—T. B. Blow, Shimo Kyoku, Kyoto, Japan.

SPRINGTIME.

WARM WATER SUPPLY FOR BEES.

This is the time of song.

From many a joyous throat,

Mute all the dull year long,

Soars Love's clear note.

[7420.] To-day, the first of spring, has been very mild, though dull. Yesterday and the day before were beautiful, ideal spring days, when bees revelled among the crocus blooms for hours, and the first pollen seen to be gathered by the bees this season was carried in. Cards kindly sent me from several counties all over England proclaim the season of 1909 to have begun, and the bees seem to have started everywhere on about the same date—March 19.

A supply of water is now necessary in order that brood-rearing may be pushed forward, and many bees will be lost during cold weather by becoming chilled when out in search of it. To avoid or lessen this loss of bee-life is very desirable, and this spring I am trying the effect of supplying water slightly warmed near the hives. For this purpose I have made use of an old chicken-rearer which is heated with a hot-water copper tank. The warm compartment under the tank intended for the chicks is filled with straw to conserve the heat, and over the tank itself a shallow tin is placed, and tightly packed round with warm material. The water for the bees is placed in this tin, and straw or cork dust is floated on the top to give them secure footing. This water is kept just slightly warmed by keeping the lamp in the rearer burning at a suitable height, the aim being to give only sufficient heat to prevent any chill to the bees coming there for water. The heat rising from the tank below serves this purpose admirably, while cold gusts of wind are kept out by the walls of the compartment rising above the level of the water-tin, and sudden showers are thrown off by the lid being kept half open. It is perhaps too early yet to estimate the result of this experiment, but I notice that the water-carriers have deserted several other sources in favour of the warm water, and are taking it very freely, although it is slightly medicated with naphthol beta, which must be a powerful factor in the prevention of foul brood. In the outer run of the same rearer is placed some shavings sprinkled with pea-meal, which is much frequented by the pollen-gatherers. A very pretty sight the apparatus makes with its busy crowd of workers, and it is an object of much interest to visitors to the apiary. Obviously the cost of supplying water in this way would be too heavy for small apiaries.—G. W. AVERY, Heads Nook.

HOW TO TEST FOUNDATION FOR STRENGTH.

[7421.] We read advertisements recommending different makes of foundation, each manufacturer emphasising the toughness and purity of his own make.

For purity one has to trust to the manufacturer, as it means a lot of trouble to most amateurs to get at the specific gravity of each sample, although it is easy enough to one who has the necessary appliances by him. The following test will, I think, tell us all that we require, though it will not give such accurate results as a testing machine, and should it catch the eye of a maker of these it will no doubt, raise a smile.

Before testing, the point which must be taken into consideration is the price per sheet (note, not per lb.), which, I think, varies in every case. My method in these cases has been to take a sheet as near as I could of the same price in each make—say, a nine-sheet to the lb. of one against an eight-sheet to the lb. of another—so as to get at a fair money value.

Cut a piece of exactly the same size (true and square) out of each sheet you propose to test, cutting it the same way of the cell-base in each case. Carefully plane a long strip of wood, about $\frac{3}{4}$ in. square. Cut this into pieces the same length as the width of the pieces of foundation you propose to test, remembering in testing that these are to hang the same way as the foundation does when placed in the frame.

Place two strips of wood opposite each other at the top edge of foundation (this being between them), and securely fasten them together by nails or fine screws at equal distances apart. Start at, say, $\frac{1}{2}$ in. from each end, and divide into from 1 in. to $1\frac{1}{4}$ in. spacing for these nails. Do the same at the bottom edge. In the centre of the bottom strips then bore a small hole with a $\frac{1}{16}$ in. drill. Pass a thin piece of string through this hole and attach a weight. I myself made the required number of little bags, and found it easy to get the same weight for each piece by using small shot, and to make sure of its being correct I weighed shot, bag, and bottom strips of wood.

In the centre of the top strips of wood, and at a point 1 in. each side of the centre line of foundation, $\frac{1}{16}$ in. holes were bored, string was passed through, forming a loop as shown in sketch. A large box was then prepared, and hooks placed so that the test pieces of foundation could swing clear of each other easily, and room was left for a thermometer alongside one of them.

The whole now presented an appearance like the sketch, and the box was placed in front of the kitchen range, so that each

piece received an equal amount of heat. Each sample of foundation was tested twice, the position of the pieces being varied the second time.

In one of the tests X foundation stretched $\frac{1}{8}$ in., and collapsed at 95 deg. Fahr. Y ditto stretched $\frac{1}{16}$ in., and collapsed at 100 deg. Fahr. Z ditto stretched nearly $\frac{1}{16}$ in., and collapsed at 110 deg. Fahr.

The above test shows X to be a very unsuitable piece of foundation, for two reasons: First, because of its great

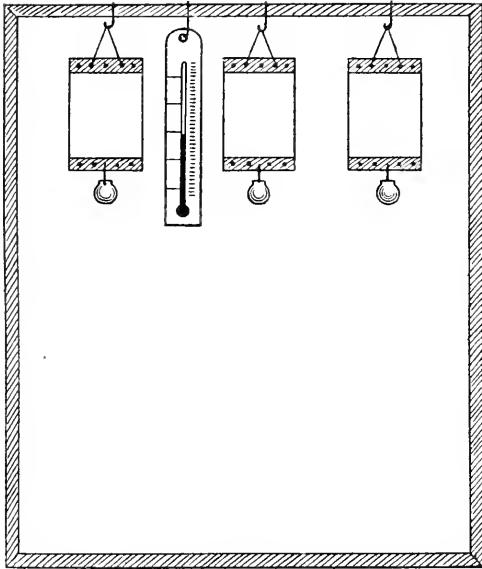

elongation, and, secondly, because of its early collapse. Y is much better, but when taken in comparison with Z for money value per sheet, then Z easily comes out first.

One point I have omitted, and that is that these test pieces should hang true.—G. THOMAS, Pwllerochan Rectory, Pembroke.

A FORETASTE OF SPRING!

[7422.] Your esteemed correspondent "D. M. M." gives us a very delightful foretaste of spring in a recent letter (7390). Would that the gracious weather of February's third week had continued; but, alas! I have to chronicle that the first week in March not only "came in like a lion," but like a lion in the very worst temper imaginable. Inches deep of snow, cold thaws that were almost worse than the severe frosts which followed, and slush and water ankle-deep, made up one of the most inclement first weeks of a proverbially boisterous month that I can call to mind. No wonder that Tom Hood

ridiculed the idea of a "gentle and balmy" spring—in England.

As for flowers and bees—well, the former may be *looked for* and the latter—let us hope—may be *found*, snug amongst the combs of a water-tight hive, or it will assuredly be the worse for them!

Speaking of the snow reminds one that it has also been *sung* by various bards, who have glorified its soft white purity. Yet is it the sign-manual of Death, not Life. Imagination can picture this world (in the far-distant ages) covered from Pole to Pole with an unbroken mantle of snow—a veritable shroud for the earth and all its countless inhabitants, whiter far than any woven by mortal hands for the dead.

But away with fog and frost and marrow-piercing winds! Give me the glorious warmth and all-vivifying sunshine of the summer season, when one comes in from garden or bees glowing hot, feeling as though one could "dabble" for an hour in that deliciously cool pump-water! Then, indeed, is life worth living.

But what is that remark of "D. M. M.'s" about the hazel and willow being in bloom together? Here, in South-east Essex, hazels are in bloom early in February, whereas the "palm" willow does not bloom till March or April, and the tree-willow not till about May. I notice that while the bees always make merry on the velvet buds of the willow tribe, I scarcely ever see a single bee on the hazel catkins, although I have hazel bushes growing quite near on two sides of the apiary.—SAML. P. SOAL, Rochford.

TRANSFERRING BEES.

[7423.] As your correspondent "A Beginner" (3899, page 120) seems to reside near Brighton, if he will call on me at 11, Park Crescent, Brighton, I shall be happy to show him practically how to perform the operations you advise. Indeed, I shall be always pleased to assist any novice you may refer to me. As I am a bee-keeper of over forty years' experience, and frequently give lectures and demonstrations, I am very often consulted by local aspirants.—B. LOMAX.

AMERICAN AND COLONIAL PAPERS.

EXTRACTS AND COMMENTS.

By D. M. Macdonald, Banff.

Eureka!—That, I think, is what Dr. Miller, of Marengo, should say at last. His record this year is 20,000 sections from 130 hives, or an average of 150 sections per colony. He tells in February *Review* how this has been done by a veteran of seventy-eight years, aided only

by Miss Wilson, who did at least half the work. Dr. Miller emphasises the importance of ample stores in spring, selection in breeding queens from the best storer, the value of bait sections in first supers given, and "equalising" in order to strengthen the weak and reduce the very strongest to control swarming, while his "tiering up" aided the same good cause. He has our heartiest congratulations on his success.

Sealing Air-tight.—"The tin lid of the honey tumbler may be made air-tight by the use of a paraffined paper disc cut large enough to project about $\frac{3}{16}$ in. beyond the edge of the top of the glass. This is placed on top while the honey is still hot, and the tin cover is forced down over it, thus tightly sealing it. Thus sealed I have carried them, paying no heed to keeping them right side up, and no leaking occurred." This tip of Mr. Hershiser's is worth knowing. He again advocates retailing in small packages, the demand being mainly for $\frac{1}{2}$ -lb. and 1-lb. packages, and he gives as the main reason that "city inhabitants have been forced into the custom of living from hand to mouth." Every kind of provision is made up in small packages, in order that the stores may the more conveniently overtake the safe and quick delivery of all provisions, including, of course, honey.

Finding a Queen.—Our Antipodean brethren, according to four writers of prize papers in December *Bee-keeper*, find it very hard work indeed to find a queen, especially a black queen. The shaking, riddling, bagging, and multiple manipulation of frames engaged in seem to be rather antiquated and cumbersome, while even the "copied American ideas" do not further matters to any great extent. I wish some of them would experiment with the following plan, and report if it is successful: Some time before searching for the queen place a queen-cage, lately vacated by its inmate, between the centre combs of a populous hive. On opening to find the queen, deal with only these two frames, and in nine times out of ten she will be found on one or other of them, generally in close proximity to the empty cage.

Eucalyptus Flavour.—How often have Australians denied the existence of this drawback to their otherwise excellent honey. Our Editors and contributors in the past have been attacked for even mentioning its existence. Now here comes Mr. Beuhne, one of themselves, admitting that it is no mere myth, but a very living reality. I have before me a copy of the *Australian Bee-keeper*—marginally marked by our late revered Junior Editor, almost the last piece of work he put his hands to—showing that on the Continent, in England, and America the "strong and

strange aroma," the "distinct and objectionable flavour," were readily detected. The unanimous finding seems to have been that the samples were fit only for "manufacturing purposes" and "unsuitable for table use." The honey was readily picked out by experts from amongst other samples, "in many instances by the sense of smell alone," while others who had no previous experience of it objected to the strong aroma.

Uses of Honey.—Lately I have repeatedly drawn attention to the virtues of honey, and I hope to go on doing it again and again, even although scepticism may be expressed in regard to some of the cures. The *American Bee Journal* claims for honey that its action on the teeth is not so injurious as that of sugar, it preserves fruit better than the other ingredient, it is excellent for throat and lung troubles, valuable in cases of croup and colds, it is soothing used externally, internally it is laxative and sedative, is a sovereign remedy—so physicians say—for bladder and kidney diseases. In summer drinks it stimulates without any injurious effect. Doctors over there, as well as in this country, believe in honey as a cure for influenza. I hope Editor York used it in his late severe attack of "la grippe" (page 38), and that it aided in securing a rapid recovery.

A Novelty.—With the object of making the exhibition more attractive and drawing out more bee-keepers, it is proposed to offer prizes at Toronto for demonstrations of extracting honey, uncapping combs, filling sections, and other bee-manipulations. At a recent town gathering there was a competition for framing, fixing in foundation, queen-cell dipping, and various operations, and the innovation proved one of the most interesting items on the card.

Queens Carrying Disease.—Inspector Newton, Canada, in his report states: "Three queens had been imported. Those three hives showed signs of disease, while no other hives in the yard did." Mr. Root, on the contrary, disbelieves in this, for in answer to a query he replies: "We seriously question whether it is possible to carry disease through a queen." In this country we would advise changing cages and doing away with attendants before introducing; but our ideas differ in more than one phase of this subject, as I note in *Canadian Bee Journal*. Mr. McEvoy explicitly states his belief that "empty hives that had foul brood in do not need any disinfecting in any way." Astonishing!

Storm Doors.—After testing various contrivances, *Gleanings* rather bans the use of these appliances, and goes the length of designating them *entrance-obstructors*. At the 'Roots' yards they

have reverted to the entrances 8 in. long by $\frac{3}{8}$ in. deep. I fervently wish the decision had been the other way. In a limited trial my experience rather favours the use of these appliances. I cannot subscribe to the statement that *chilled bees*, to any great or even appreciable extent, recover after lying on the cold ground for several days and nights, so that they "come to life" and re-enter the hive. Here, I fear, they die. If they are not snapped up by birds or mice, they disappear under the shelter of some vegetation never to fly again, unless weather turns very warm after the first day.

Spring Examination.—I have always thought this necessary manipulation of hives had a rousing and enervating effect on bees. It imparts energy, which sets the bees a-roaming in search of nectar and pollen. Here comes Mr. Scholl confirming my belief. "One is shaking energy into bees when in spring he goes through all colonies previous to the honey-flow scraping all the frames of bur-combs and propolis, taking all drone-comb out of the hive and replacing it with worker comb or foundation, and doing a dozen other things for the welfare of the queen and the colony. Do this in warm weather when the bees are booming, and watch results." Try it, please!

Queries and Replies.

[3902.] *Queen-rearing in Spring.*—I should be much obliged if you would answer the following questions for me in the next number of your valuable paper, from which I have received a great deal of help. I am only a beginner, and have now got nine stocks of English bees. I looked through my hives on Saturday, March 20, they seemed very strong, five or six frames being pretty well covered with bees in each hive. All the hives had some brood in them (I do not know about how much they should have at this time of year); but in two cases only could I find a little, just a patch on one side of one frame, about the size of the top of a breakfast-cup. Is it because the queens are too old? And, if so, would it be best to find the queen and kill her, and let the bees raise another from the brood they have? If I did this, should I get a queen sooner than if I bought one? It seems to me from the bee-catalogues I have that I cannot buy queens before the end of April, and that seems to me to be a great loss of valuable breeding-time. If my plan is not right, please tell me what I ought to do. Please excuse such a lot of questions; but I cannot find the information I want in the Association Handbook. Thanking you in anticipation.—S. M., Surbiton.

REPLY.—If there are plenty of bees and stores you need not trouble about the queens just yet, as there is time for the brood to increase. It is too early to allow the bees to raise a queen from the small patch of brood there is at present, as she would not be fertilised, for there are no drones about, and they are not likely to be plentiful for some time. Moreover, for rearing good queens, only very strong colonies crowded with bees should be used, and preparations for queen-rearing made

in April. You will find full particulars for doing so in the "Guide Book," pages 123 and 200; the Association Handbook is only an elementary book for cottagers, and does not deal with rearing queens. All you can do now is to see that your bees have plenty of honey in the combs, and if they are short of food they should be fed with syrup. Examine them later and ascertain their condition, and if, after studying the "Guide Book," you are in any difficulty, we shall be pleased to help you.

[3903.] *Bees Robbing by Agreement.*—Will you be good enough to advise me on the following condition? I have four stocks, of which one, by far the strongest in numbers, is headed by a "British Golden" queen mated with a native drone. During a few warm days in the middle of February I ascertained that all had sealed stores present, and I noticed that the yellow bees seemed very much interested in the entrance of the weakest black stock. I put a cloth soaked in carbolic acid solution (1 in 20) on the alighting-board, but the bees settled on it in swarms and drank it, apparently with gusto. True, I saw a considerable number later on who seemed to be in pain on the ground in front of their own hive, and then the bad weather came and put a stop to it all. During the present fine weather the same game seems to have started again. I have not seen any fighting, but there are several yellow bees who make a business of watching for blacks on the alighting-board and seizing upon them, and, after what looks like a very vigorous rub-down all over, allow them to enter the hive. I have not seen any blacks doing this, but have seen the yellow bees treating their own race in the same way at their own hive. When I examined the hive I found a few yellow bees apparently on good terms with the natives, but they were in nothing like the same proportion as in front of the hive. Does this mean that robbing is going on, and would it be advisable to change the positions of the hives? If so, should the queens be caged? The weak hive contained only enough bees to cover two frames, with a small patch of brood and queen. Is this too weak to do any good? All my hives have a considerable amount of stores left, and pea-flour is being carried into all of them. I send name for reference, and sign—MEDICO, Nottingham.

REPLY.—The yellow bees are no doubt robbing by agreement among the bees themselves. The robbed colony is evidently weak and without energy, and instead of offering resistance, the bees of the hive fraternise with the intruders. As the stock is so weak your best plan is to unite it with another.

[3904.] *Transferring Bees.*—Will you kindly let me know through your interesting B.B.J. the following? I have a straw skep with bees which have been in it for two or three years, and I want to replace it with a new one. Should I lift the old one above the new, and, if so, when would be the most suitable time to do so, now or later, and when could I take the old one away?—ANXIOUS, Cornwall.

REPLY.—Any time from April onwards you can place the skep on the top of a new one, and the bees will build downwards, occupying the lower hive in due time. Towards the end of the season the upper hive can be removed with its contents, as the queen will have utilised the lower hive for brood-rearing. We would, however, recommend you in preference to transfer the bees into a frame-hive instead of the skep, according to instructions in "Guide Book," page 150.

[3905.] *Stimulative Feeding.*—I shall be much obliged if you will inform me as to what I ought to do. 1. When should I begin to uncap the stores in my hives to induce the queen to start laying? 2. When should I begin stimulative feeding with

No. 5 recipe? 3. I have not yet opened my hives, as the winds have been rather keen in spite of the lovely weather we had at the earlier part of the week. I have been afraid of chilling any brood if there is any yet. My bees have started to bring in natural pollen from the crocus. 4. What is the lowest temperature in the shade which would be safe to open a hive at this time of the year and at what time of day? The hives have still plenty of candy. Hoping for an early reply.—CHARLES B. HEADLEY, Leicester.

REPLY.—1 and 2. Now is the proper time. 3. There is no necessity for opening hives except to lift the quilts and uncap some of the honey-cells within reach. When the weather is more favourable carry out the instructions on page 213 of "Guide Book" as to spring cleaning. 4. Between 50 and 60 deg. Fahr., if there is no cold wind. The operation should be performed between eleven and one o'clock on a bright sunny day and as rapidly as possible, taking care to keep the bees well covered down while examining the frames.

[3906.] *Queen Outside Hive.*—Can you kindly assist me with an explanation of the following puzzle? I have kept bees for many years past, and have had curious experiences with them, but never one like this. I have ten stocks, all strong and healthy, and when examining them on Sunday, March 7, I found on one hive a bunch of dead bees and queen under a sack, which had been put over the front of this hive on account of the snow. The hive contained a good deal of young brood nearly hatched, with abundance of stores, besides a cake of candy. The stock is strong, and there are apparently plenty of bees now. They did very well last year, but had drones rather late. If you could enlighten me in any way through your valuable B.B.J. I should be grateful. I take in the B.B.J. every week.—PUZZLED, Kent.

REPLY.—As the stock had drones late in the season the queens were probably also reared late. As we presume, from what you say about there being plenty of young brood in the hive, they must have a fertile queen, the one you found outside with the cluster of bees was a second queen, which had left the hive with a few bees during a warm day, and was not allowed to return.

[3907.] *Transferring and Re-queening.*—I should be much obliged if you will give me the following information: 1. *Re* transferring, in the "Guide Book" it says, "this completes the operation." Does this mean that lift and roof of hive should not be put on? 2. If I wish to re-queen would there be any objection to the following?—When I see a queen-cell built I propose to destroy the old queen, so that the young one, when hatched, may take her place. Thanking you in anticipation.—A. P., Sussex.

REPLY.—1. No; the lift should be put on and the packing filled round the skep, the roof being put on the top in the usual way, unless the skep is too large, in which case some other protection against rain must be provided. 2. None at all. This plan is frequently adopted to prevent after swarms (see page 24 of "Guide Book"). You must, however, make sure that the cell you propose to leave contains a queen.

Notices to Correspondents.

E. THOMAS (Cornwall).—*Bee-keeping in New Zealand.*—Bee-keeping is carried on successfully, but the country is thinly populated and the home market limited. The Department of Agriculture at Wellington have a model apiary at the Government Experimental Farm at Ruakura, under the supervision of an expert. The Govern-

ment takes a great interest in all pertaining to bee-keeping, and information as to the best districts would be supplied on your applying to the High Commissioner for New Zealand, Westminster Chambers, 13, Victoria Street, London, S.W.

J. C. (Bidston).—*Medicating Syrup.*—Pure naphthol beta is the proper thing to use for medicating bee-food. A 1s. packet will do for 145 lb. of sugar.

R. H. O. (Birmingham).—*Prevention of Swarming.*—As you have the "Guide Book" you will find full instructions as to prevention of swarming on page 21, new edition. We can add nothing to the information there given: If there is anything you do not understand write again, and we will try to explain.

J. M. W.—*Early Drones in Hive.*—In strong colonies preparing to swarm drones should be hatching out in April, and we have known them occasionally to hatch out in March.

H. M. GROVE (Bucks).—*Dysenteric Bees.*—From your description of the bees messing the hive all over, it would appear that they are suffering from dysentery. On the other hand, it may be the disease described on page 101 of B.B.J. for March 18, and we should require more particulars before deciding the question.

V. W. C. (Malvern).—*Queen-rearing.*—You will find full instructions for rearing and introducing queens in the "Guide Book," where the subject occupies twenty pages; it would therefore take too much space to give the details you require. You must use one of your strongest hives for producing the queens, and if you will read the review on Rearing and Introducing Queens by Adrien Getaz on page 11 of B.B.J., you will find instructions which, if carried out, will enable you to do what you want.

W. H. (Yorks).—*Raising Pure Queens.*—You can introduce a pure strain, and re-queen all your hives from it. If you will carefully read the review on page 11 of B.B.J., of the method recommended by Adrian Getaz, and carry out the instructions there given, you will have no difficulty in rearing a number of young black queens and have them fertilised by pure drones. In reading substitute the word "black" for "Italian." Of course you cannot ensure that they will all be pure, as the young queens may meet drones from another apiary; but if you have a large number of drones reared in your own hives you stand a good chance of having most of your queens fecundated by them.

Suspected Combs.

S. J. HUDDLE (Kent).—There is no evidence of foul brood in comb, which is old and black, with traces of wax-moth in it. Cells mostly contain old mouldy pollen due to damp, and a few scattered ones contain chilled brood and fully developed bees that have failed to hatch out from insufficiency of heat. The colony was weak, and from the half-formed queen-cells it is evident that it had become queenless, and had dwindled because there were no young bees to replace the old ones which had died.

G. M. H. (Notts).—The comb contains nothing but sealed honey and pollen, and there is no evidence of foul brood. The bees do not seem to have been strong enough to live through the winter, as those sent have no outward evidence of disease.

G. H. (Devon).—Comb is affected with foul brood in the advanced stage. Burn all frames, combs, and the dead bees, and thoroughly disinfect the hive without delay.

Several important letters, &c., are in type, but held over from pressure on our space.

Editorial, Notices, &c.

BRITISH BEE-KEEPERS' ASSOCIATION

CONVERSAZIONE.

(Continued from page 123.)

The Chairman called on Mr. Bevan to introduce the second subject on the agenda—namely, "Working for Increase."

Mr. Bevan:—The subject on which I am asked to address our friends present is one that every bee-keeper has to take in hand, and it is as well that he or she should make themselves acquainted with the various methods of increasing their number of stocks, so as to be able to do so with as little expense as possible. I do not purpose dealing with more than one method this evening, though there are of course various ways by which the bee-keeper can increase his stocks. The most usual way is—I am now addressing the working man who wishes to add something to his income by the keeping of a few stocks of bees; in fact, my remarks are intended to assist the beginner and are not in any sense addressed to the experts and bee-farmers whom I see in this room—by "natural swarms." No doubt this is an admirable arrangement of Nature to perpetuate the genus *Apis*. If this were not done, it is probable that the queens would die off from old age, and, there being no new brood, the adult bees would also die, and so become extinct. Here the bee-keeper steps in and assists Nature. The natural swarms may from a very strong colony consist of, say, one "top swarm" and one "cast"—that is, an increase of two stocks for the following year; but this is not always sufficient increase, therefore the successful apiarist adopts other methods in place of natural swarming, and the method which I think is an interesting, easy, and certain one is that known as "division." This I have carried out on several occasions, and I recommend any cottager who wishes "increase" to try it. The method I have adopted is as follows:—Select a strong stock headed by a young and vigorous queen, which stock should occupy in May ten to twelve standard frames. At the beginning of April and on through into May stimulate by giving a little warm syrup often and keeping the colony well covered with warm quilts; in this way the bees will by the last week in May or first week in June be preparing for swarming. They should be watched carefully, and note taken of the number of queen-cells formed; if there are not sufficient, say from eight to twelve, then an extra empty comb should be substituted for one already filled with either brood

or syrup. The queen will fill this with eggs, some of which will be put into royal cells and soon capped over. By keeping the hive full of bees to its utmost capacity and leaving no room for storing honey the swarm will in all probability come off by the first week in June. The usual signs will let you know this, and then everything should be in readiness to deal with them immediately. There is one remark necessary here, and that is, if the bee-keeper is likely to be away from home when the swarm is expected he may anticipate it by finding the queen and taking her with two frames of worker-bees out of the old hive, and placing her and the bees in another hive, adding two or three frames fitted with foundation and a bottle of syrup to comfort them. This is in place of allowing them to swarm naturally; but in either case the remainder of the stock should be dealt with as follows:—Open the hive the same evening as the swarm issues and examine the combs. There should be plenty of capped royal cells, which, if they are not already distributed on at least five different combs, should be cut out and placed on that number of combs, and again put back in the parent hive, and so arranged that each alternate comb has one or two capped royal cells upon it. Open out the combs and insert between every other one a piece of properly-fitting queen-excluder, always making sure that you have the queen-cells between each pair of excluders, and then close up again and leave alone until all the queens are hatched out. A few days after the division has taken place—this requires care in manipulating the whole at one time—it will be necessary to have prepared four hives or nucleus-boxes (I prefer the full-sized hives), bringing them as close as possible to the parent hive. Uncover one section at a time of the combs in hive, and transfer two of them with the virgin queen into each of the new hives, giving an extra comb of honey and brood from another colony, or foundation, with a bottle of syrup, repeating this to each section, which should make five new colonies in addition to the first one from the original colony. These will all become strong, the queens fertilised, everything will be prosperous, and in time for the bees to collect stores for themselves before the end of the season.

There is the one main point to be always borne in mind—that is, bee-keeping cannot be carried on successfully without the constant renewal of queens. Therefore the bee-keeper must at all times have a vigorous young queen at the head of each colony, and it is necessary that he should study the art of queen-raising, or he must purchase from a re-

liable dealer. There are various queries which will no doubt be asked, such as:—When is the proper time to carry out increase by division? This must always be at swarming time, when there is plenty of nectar coming in. What kind of bees are the most useful for rapid increase? I prefer Mr. Sladen's "Golden," or first-cross of Italians, but any good worker black bee may be used. Is not increase by division and by queen-raising a somewhat similar manipulation? Yes; spare queens will be available from the divided colony. These can be caged or put into nucleus-boxes for use later on. When making divisions, is it possible to get any surplus honey? No; unless your bees are in an exceptionally good locality—that is, where a long succession of honey-producing plants are within easy distance of the hives. It is astonishing how quickly these divisions build up and become strong colonies during the months of June and July. I do not recommend this method at any other season of the year.

Mr. J. B. Lamb said that beginners would ask, Who should decide when doctors disagree? As he had worked for years with Mr. Bevan on the committee of the Middlesex Bee-keepers' Association, he regretted to have to differ from him as to the advantages of the method of division of stocks advocated. Theoretically the plan was perfect, and if carried out in the warmest parts of July or August would probably prove successful; but with the changeable weather experienced as a rule in May and June he could not advise beginners to follow Mr. Bevan's plan of making one strong colony into five or six nucleus stocks. Some persons were under the impression that if two combs of brood and eggs were placed between combs of stores the bees would have the sense to cover equally the two combs of brood and eggs in order to keep them warm; but experienced bee-keepers knew that this was not the case. On a cold night the bees would form a cluster, and all brood and eggs outside the area covered by the bees would become chilled. A good way to ensure against chilled brood in forming nucleus stocks was to shake the bees from two or three other frames into the nucleus hive, which frames could afterwards be put into another stock; then these extra bees would make compensation for those that were sure to return to the position of the parent colony.

Mr. Bevan said he was not speaking of what he had read in books, and had never seen his method recommended, but gave his own experience of what he had done himself.

The Chairman said he would like to refer to a statement made by Mr. Pratt, of Swarthmore: "All methods of artificial increase necessitating the

separation of the queen from the brood either by means of excluder-zinc or by caging cause the death of at least one-third of the brood in the hive." That had never been his (the Chairman's) experience, and as it was a common practice he would like to know if others present had had the experience that if you made a division and separated the queen from the brood by excluder or otherwise a portion of the brood would perish.

Mr. Sladen asked if it was meant that the colony was broken up into several other colonies. If the new brood-nest was fairly compact there ought to be little or no loss of brood. Of course, one might expect some of the eggs laid on the outside of the brood-nest to get chilled and die. Cold nights were the trouble. If the colony were divided up into a great number, as Mr. Bevan suggested, he was afraid that the brood would run the risk of being chilled. Its advantage was that when cells were ripe there was no unsealed brood. Mr. Bevan's method was simpler than others; the point was, however, that he did not get the queens until they were hatched. He (the speaker) would have thought it difficult to secure the queens if they had time to get at large in each of those separate compartments. It seemed to him that if those ripe cells were caged it would be unnecessary to put in the divisions, and the nuclei could be made when the queens were about to hatch. He thought the method of utilising queens reared under the swarming impulse was much better for the beginner. Unless the bee-keeper had considerable experience, it was often found that a good many queens would go to waste in a colony that swarmed.

Mr. Lamb said he would like to know whether any members had tried the plan described in the BEE JOURNAL of stuffing hay or grass into the entrance of a hive containing a nucleus stock in order that numbers of the sealed brood might hatch out by the time the bees had made an exit through the hay or grass blocking the entrance. He understood Mr. Bevan to say that he divided the stock on the evening of the day it swarmed, when the stock would have plenty of sealed brood in it.

Mr. Bevan said he had found no difficulty in doing this, but the proper time to carry it out was the most difficult part of the business to decide.

Mr. Crawshaw said that he did not desire to pose as a judge between Mr. Bevan and Mr. Lamb, but he thought something might be said for each view. He personally preferred to make increase slowly, but at the same time five or six from one could be made, when conditions were right, by sacrifice of the honey. Such manipulation was usually done when

the hive was exceedingly populous, as at swarming-time, when there was undoubtedly a sufficiency of bees to cover that number of nuclei. If division were made a week or so after swarming there were no eggs or unsealed larvæ to chill, but the army of bees was much reduced. He would recommend the "Sladen" frame for such nuclei, as this involved a much more compact brood-nest with less liability to loss from chill. Surplus brood should be disposed elsewhere. One point upon which emphasis should be laid was that the old queen should remain upon the old stand when dividing; but most of these methods were fully dealt with in the "Guide Book." He thought it important that none of the virgin queens should have liberty to fly and mate before division of the nuclei. He used some excluder-cages which would hold a standard frame in the brood-nest. One form of this cage which could easily be home-made had been illustrated in the B.B.J. (1903, page 283).

Mr. Silver thought Mr. Bevan was to be congratulated on his plan of allowing the queens to hatch out, which dispensed with the method of caging queens. The queen would come to much greater perfection with the bees clustering close to the cell than if she were in a cage with no bees close to her. He (the speaker) had made one or two experiments by dividing two or three nuclei with excluders. In the course of his first experiment he thought he had made a valuable discovery. He had small frames, about half-size, and arranged some excluder-zinc so that the bees could go to this or that side and have communication. He put three young queens in these hives and the bees all agreed. What happened was that all those queens mated and were laying, although the bees communicated one with the other. As regarded the next experiment, it occurred to him that if he could do three, why not four, with entrances all round? All the queens came out one day; the next day he did not notice any of them out. He found that one of those four queens had been mated, after which the bees killed off the other three.

Mr. Bevan said he had found the same trouble, but his plan was not carried out in that way. Those queens evidently had access to one another, and then the first and strongest would get rid of the other three. But as long as they were kept caged in the divisions about eight or ten days after the swarming, and then taken out on the combs, they were virgin queens. The all-important point was not to let them get together. He had seen four queens outside the door, and in five minutes afterwards they were all killed. These facts could only be discovered by experience. The indispensable

condition was to keep them separate in the hive, and before they could get together see that they were lodged on the combs.

Mr. Silver remarked that the young queens would agree up to the time one became mated.

Mr. Bevan added that if the queens were not divided up at the right time the one in the front division of the hive would have an opportunity of getting mated, while the others could not. Let them be taken as virgin queens each into a separate hive, and let them be mated in the new hives. The number of bees could be regulated so as to be about equal in each hive.

The Chairman said the meeting was very much obliged to Mr. Bevan for introducing his subject, which was a highly important one for bee-keepers. He (the speaker) hoped that some of those present would try the method suggested and report on the result thereof. He feared the increase proposed, though excellent when successful, was rather too rapid to be safe for general adoption; he preferred a little quieter progression. To cut up one stock into six was pushing matters to an extreme; he would rather bring off one or two swarms from a hive during a season. Nevertheless, they were all indebted to Mr. Bevan for the trouble he had taken in bringing before them the bold tactics he had adopted so successfully.

(Continued next week.)

NOTICE.

ALTERATION OF DATE FOR B.B.K.A. COUNCIL MEETING.

For special reasons it has been found necessary to change the date of the April meeting of the Council of the British Bee-keepers' Association from Thursday, April 15, to Thursday, April 22, and notices for the latter date will be issued by the secretary in due course.

REVIEWS.

A French Garden in England. By Helen Nussey and Olive J. Cockerell (London: Stead's Publishing House. Price 1s. net).—Much has been written about French gardening, and no doubt a great many who have been captured by the statements made in the daily papers have gone in for it, with disappointing results. It is well known that the French are experts at intensive cultivation, and send us vegetables at times when we are not able to get British produce. But French gardening, like market-gardening of any kind, requires to be learnt, and experience can only be gained by years of practice. As much may be learnt by failures as by successes, and in this book we have set down the first year's experience of two ladies who, after one

year's training in French gardening under a real French gardener, started with a small capital and two acres of raw field. They relate in a pleasantly, chatty manner the mistakes they made, the difficulties they encountered, and how they managed to overcome them. Their experience will be useful to those who are thinking of embarking on a like project in the hope of making a living. The little book is charmingly written, and the pen-and-ink sketches add considerably to the interest. As the authors give the cost of everything, it is easy to see what capital is required to make a start, and we would recommend those contemplating doing so to read this book before they make the attempt, and those who have already started this style of gardening will be sure to find in it much that will be useful to them and so save costly experiments.

Le Livre de l'Apiculteur Belge. By Désiré Halleux. New edition (Spa, Belgium: Published by the author. Price 2 fr. 50 c.—2s.).—There is no date to this new edition of a manual by a well-known Belgian bee-keeper, formerly Professor of Apiculture in the agricultural school of Huy, president of the Bee-keepers' Federation of Condroz and Hesbaye, as well as director of the Ecole Moyenne at Spa. This volume of 383 pages is profusely illustrated, and as the author is a practical bee-keeper work in the apiary is lucidly explained. The book, which is a marvel of cheapness, is divided into two parts. The first, in five chapters, treats of bees and their products, and the second part refers to the culture of bees, ending with a description of the various uses of honey, wax, and propolis, with a chapter on bee-flora. This is the book which is included in our list of best French books on page 106 of B.B.J.

Obituary.

EUGENE L. PRATT.

We regret to have to announce the death from pneumonia of Mr. Eugene L. Pratt, of Swarthmore, Pennsylvania, U.S.A., which occurred suddenly on March 11 last. Mr. Pratt was well known as a breeder of queens, and the new methods introduced by him caused considerable discussion amongst bee-keepers. In 1889 he started the *Queen-breeders' Journal*, of which he was the editor, but as it did not turn out a success it was given up after six numbers only had appeared. In November of that year he commenced writing for the *American Apiculturist*, and became connected with H. Alley, who, previously manager, then became editor of that paper. During 1890 Mr. Pratt edited the "Queen-breeders' Department" of the *American*

Apiculturist, and afterwards wrote occasional articles, his connection with it and Mr. Alley ceasing on the collapse of this paper in 1893. He had a bee-farm at Marlborough, Mass., where he reared Carniolan queens, and later removed to Swarthmore, in Pennsylvania. Mr. Pratt wrote under the *nom-de-plume* of "Swarthmore," and he has for many years been a contributor to the B.B.J. As recently as March 11, the day of his death, a communication from him appeared on page 98, and we have another on parthenogenesis waiting for publication. Mr. Pratt was the author of several booklets, a series of which he was publishing. Those best known and the most useful are "Increase," "Baby Nuclei," "Commercial Queen-Rearing," "Simplified Queen-Rearing," and "Forcing the Breeding Queen to Lay Eggs in Artificial Queen-Cups." All these are specially devoted to rearing queens on the well-known "Swarthmore" plan, of which Mr. Pratt was the advocate. He also edited and published *The Swarthmore*, a weekly newspaper. In 1908 Mr. Pratt was engaged by the Austrian Bee-keepers' Society to give two days' demonstrations of American methods of queen-rearing in Vienna. This trip to Europe proved expensive, and Mr. Pratt was disappointed in not getting engagements to enable him to defray his expenses. He found that demonstrations in Europe were not a novelty, but that they formed part of the regular instruction given to students both in this country and on the Continent. We visited the Swarthmore apiary in 1905, and Mr. Pratt explained his appliances and methods of queen-rearing, and showed us some of the beautiful golden queens of which he made a speciality. We were very much interested in all we saw, and were particularly struck by the gentleness of the bees while under manipulation without smoke. Although many do not entirely agree with his methods, Mr. Pratt will always be remembered as one who did much towards improving queen-rearing, and in this way he has conferred on the industry a lasting benefit.

Correspondence.

The Editor does not hold himself responsible for the opinions expressed by correspondents. No notice will be taken of anonymous communications, and correspondents are requested to write on one side of the paper only, and give their real names and addresses, not necessarily for publication, but as a guarantee of good faith. Illustrations should be drawn on separate pieces of paper. We do not undertake to return rejected communications.

AMONG THE BEES.

[7424.] A Noct. "Claustal."—March during its entire course has been a very wintry month here. After a charming February came a sharp snowstorm, and

the leonine character of the month persisted until about the close, since which weather has continued stormy and unseasonable. The successive blizzards made tremendous snow-wreaths, and my hives were buried for fully three weeks. Then when the thaw came bees made frantic efforts to get out, enticed by the sunshine. To allow them to leave their hives meant almost certain death, so I proceeded to erect fortifications in advance of every hive with its front exposed to the bright rays of the sun, shining in a cloudless sky. Large bricks of snow were systematically erected wall-like in a curved line as a barrier to exclude the light. Even when shaded in this way the inmates of several hives—they had all considerable yellow blood in their veins—were most persistent in forcing a way out, so I had to place fresh porous snow in front of every entrance and arch a dome over the entire front, thus wholly excluding light. Here was a "claustral" chamber which provided a fair supply of air, excluded light effectively, and kept the bees prisoners, I trust voluntarily. With a thaw, however, the chamber soon crumbled, and had to be renewed each morning. Great care had to be taken not to jar the hive when erecting the structure, as this would have added to the prevailing agitation. The number of bees lost annually by this desire for an untimely flight tells heavily on the strength of colonies at the opening of an early flow, and it is well worth an effort to curb their misdirected ardour.

My "Slight Mistake"?—I have ventured to put the interrogation note after my heading because, notwithstanding what Mr. Harrison says (page 107, 7411), I am of the same opinion still as regards *Helleborus niger*, or Christmas Rose. Here are two authorities substantiating my statements. The Northern one says: "They grow freely in any garden soil. Propagate by division in autumn." True, he adds that the soil is best moist and the position shady; but he goes a point beyond what I did, because he states they "are very fit subjects for planting in open woods and among shrubs." My Southern authority supports me still further: "They are so excellent that they may with advantage be used in almost any position in which they may be desired in ordinary soil. Division." This is the ordinary kind. Mr. Harrison has possibly got hold of a tenderer kind, such as has been imported from Southern Europe. Their tap roots do push deep, but a gardener with care can overcome this drawback in transplanting. Is not a "rosy" view a healthy view?

Thick v. Thin Combs.—"Nondescript" (7413) refers to a recent discussion on this subject which took place in your pages

Mr. Townsend, the American champion for *thick* combs, deals with the subject in *American Bee Journal*, page 54, February issue, and a *résumé* of his contentions and conclusions may be of interest. The Rev. Mr. Lamb apparently found the wider spacing of $1\frac{3}{4}$ in. "sadly disappointing," working 100 frames, and believes in the narrower $1\frac{1}{2}$ -in. spacing. Mr. Townsend, with 1,000 upper stories, 8,000 frames, arrives at an exactly contrary conclusion. He thinks he has discovered a cause for the different results in the fact that Mr. Lamb did not *uncap deep*. "The remedy is simple: it is not wide or narrow spacing that determines the quality of the honey produced; it is the thickness of the empty extracting combs when given to the bees. See to it that they do not exceed *one inch* thick when given to be filled, and the result will be all right." This point appears to me to be most important. With $1\frac{3}{4}$ -in. combs, eight instead of ten to the super, uncap deep and leave the empty comb as near as possible 1 in. This seems to be the key to success with wide spacing. Mr. Lamb considers deep uncapping "wasteful." Mr. Townsend, after a score of years' experience, during which he has tested $1\frac{1}{2}$ in. against $1\frac{3}{4}$ in., assures us that this is not the case, and that there is *no loss* in the amount of surplus secured. That is important. So is his conclusion that the thicker comb is easiest uncapped. "The whole side of the comb can be uncapped with one stroke of the knife." The other, and most important, point of difference is the question of quality of honey. Mr. Townsend's finding is, "Just as good honey will be produced," but he emphasises that the system requires deep capping and restoring the empty combs to be refilled only 1 in. thick, eight to the ten-frame space. I think this is the essence of the article, and I hope it may prove useful and instructive to both parties. Mr. Townsend is a man of wide experience both in time and the large apiaries he works so successfully and extensively.

"*Lest we Forget.*"—Now, on the first fine day, take a momentary peep under the quilt and ascertain if the bees are alive, if they have sealed food, and estimate the relative strength of each stock, taking special notes of weaklings. Look carefully for damp coverings, and withdraw any such, replacing them by fresh dry ones. Place a few old newspapers over other wraps to conserve heat, now necessary for successful breeding. Examine for leaky roofs; melting snow will find an entrance at the smallest of these. The gutter from a running candle will come in handy for tiny ones. Run in hot, it makes a very effective temporary repair. Watch for signs of incipient robbing, and take steps to check its development. If

fine, provide watering-troughs and artificial pollen. In earlier districts, of course, the regular spring examination will have taken place.—D. M. M., Banff.

BRITISH HIVES IN NATAL.

[7425.] Being an old subscriber to the **BRITISH BEE JOURNAL**, I take the liberty of sending you two small samples of Natal honey, and would like your opinion of them. A friend and myself are, I think, the only ones here who keep to the "W. B. C." hive. It seems strange that our British makers do not push their goods out here. Some of them tell us that they have agents. Quite true, but the nearest, at Pretoria, is 500 miles away, and the hives cost about four times as much as home prices. The Yankees sell their hives in crates of five, and charge for the five by the crate 13s. 6d. each in the flat. That is why they are being used; but I do not like them. I have tried them, but wish for no more. I now make all my own hives. As soon as I can get a photo of my apiary I will send you one. Wishing you and the British bee-keepers at home a prosperous year.—B. WILSON, Natal, S. Africa.

[The honey marked B is far the better in colour, flavour, and consistency. A is thin and has a slightly acid taste. We shall be pleased to have the photo mentioned.—Ed.]

PROMINENT BEE-KEEPERS.

[7426.] Allow me this opportunity of congratulating you on commencing the portrait series of prominent bee-keepers, which has been looked forward to by some for weeks past now, and which will give to the readers of the bee-keeping fraternity an opportunity of seeing the faces of those with whom they have become familiar through their writings in the **B.B.J.** from time to time. I am sure it will be an education to many to read the first of the above series, which appeared in the **B.B.J.** for March 25, and which I hope will be a stimulus to the younger ones of the craft to go and do likewise. With my kindest regards and best wishes to you.—JOHN WATSON EGGLESTONE, Bishop Auckland.

KEEPING BEES NEAR RAILWAYS.

[7427.] In reply to "Worker" (**B.B.J.**, page 98) *re* keeping bees near railways, I can assure him I am not joking, and if he happens to be in this district during the summer I shall be pleased to show him the effect of the trains (as I am keeping a few of my hives in the old place).

Last spring count I had twelve colonies,

and after feeding to keep the queen laying until the apple came into bloom, I united into six. When the clover was beginning to bloom I had to reduce to three in order to super.

I do not think it was the fault of the queens or of the management, as I had three hives four miles away under practically the same treatment, and they were ready for supering fully a fortnight before the honey-flow; indeed, I had great difficulty in preventing them from swarming.

You will see the position of hives and the railway from enclosed sketch. The rails are above the level of the hives—in fact, just about the height a bee flies.

Perhaps "Worker" never has been in a train travelling at a good speed when a bee or wasp has come in at the open window.—A. SUNLEY, S. Milford.

[Sketch is not suitable for reproduction.—Ed.]

CHEAP EXTRACTOR AND WATER-HEATER.

[7428.] I want to submit to the kind criticism of my fellow bee-lovers a handy device for extracting a few combs of honey. It is simply a tinned tray 18 in. by 9½ in. and 2 in. deep, outside measurement, with a loose wire grating of ¼ in. mesh, supported by three bars ½ in. deep, soldered on, and four little corners in the tray. A couple of cords are put round the tin and knotted nicely at any necessary length, the uncapped comb is laid on the tinned-wire netting in the tray, and the whole swung vertically as fast as necessary.

I had kept a comb from last year to experiment with, and last week I extracted most of the honey, after warming it in the open kitchen oven. Of course, the honey was very thick; some of it clung to the wire netting like icicles or sweetmeats. I had to lengthen the cords twice till they were about 16½ in. from the tray to my knuckles. My arm from knuckles to shoulder is about 2 ft. 3½ in., so the tray was swinging round a circle of 44 in. radius and a circumference of 23 ft. I drove it at about sixty-two revolutions per minute. This gives a velocity of about 24 ft. per second, giving a tremendous centrifugal pressure. For extracting new honey 24 in. radius, or 12½ ft. circumference—swung about thirty or forty revolutions to the minute—should extract nicely.

Something similar must have been often used, but may be a little troublesome with thin honey. But it packs away in 340 cubic inches, while an ordinary extractor occupies about 15,000 cubic inches, and costs far more.

I have made a little watering-bottle, with facilities for heating the water, which I

mean to try this spring to stimulate early breeding. I enclose a very rough sketch thereof, but do not know if it can be put to any use.

The illustration will help to explain how it is made. The stand is of tin, and is 6 in. square and 5 in. high. Along the top edge $\frac{1}{2}$ in. is turned down inwards, leaving the corners standing up to keep the tray in position. On the top of this is placed the tray $5\frac{1}{2}$ in. square and $\frac{5}{8}$ in.

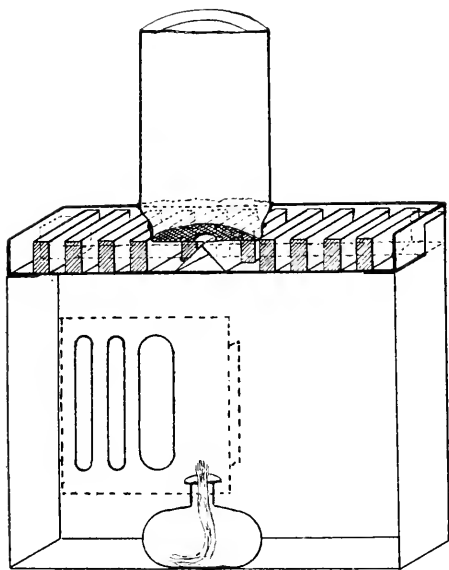

deep. The rack consists of eleven strips of hard wood $5\frac{1}{2}$ in. long, $\frac{1}{2}$ in. deep, and $\frac{3}{16}$ in. wide. In the centre the strips are cut away to allow the neck of the bottle to fit in, and for supporting this there is a strip of tin $5\frac{1}{2}$ in. long and $\frac{3}{4}$ in. broad, but $\frac{1}{4}$ in. is bent at right angles. One strip is placed at each end and one across the middle, and two $\frac{1}{2}$ -in. flat strips of tin $5\frac{1}{2}$ in. long are used to keep the short pieces of wood right. In this way there will be a little more than a quarter of an inch of warm water. The bottle, which is filled with warm water, is 2 in. across the mouth outside, and has a rag tied over it, having a $\frac{1}{2}$ -in. hole in the centre to let the water out more slowly when it is first turned over. There is a small spirit-lamp, which can be lighted through the $\frac{3}{4}$ -in. slit. The other two slits are $\frac{3}{8}$ in. wide, and there is a sliding door for either closing or diminishing these air-passages.—JOHN W. MOIR, Edinburgh.

[As an instance of how the same idea occurs to different persons, we would mention that our correspondent's extractor is identical with the first extractor made by the original inventor, Major von

Hruschka, and first explained by him at a meeting of German bee-keepers at Brünn in 1865. It was made and used just in the same way as suggested by our correspondent, but instead of the bottom being flat it was coned with a round outlet for the honey at the apex. It is described in the *Bienenzeitung* for 1865, and illustrated in "The Italian System of Bee-keeping," by A. J. Danyell, published in this country in 1876, and also in "L'Apicoltura in Italia," by Professor L. Sartori. It was called *smelatore a mano*, or hand-extractor, and one was exhibited at the Alexandra Palace in 1876. Such extractors have long been given up on account of the great labour involved in their manipulation. Abbott's "Little Wonder" extractor was an improvement on the *smelatore*, and took its place.—Ed.]

CAPPINGS OF COMB.

BY L. S. CRAWSHAW, NORTON, MALTON.

Matters Current and Under-current (page 75).—Now why does Mr. Woodley favour the shelter of the *black* over that of the *red* currant for his pacific purposes? Can it be on account of its luxurious growth, or is this another case of colour prejudice? Although in this case "black's de colour"! Bees themselves are currently reported to be "kittle cattle," and it may be that he considers red to affect a bee as unfortunately as a bull! Or does he recommend this fruity port in a storm from a partiality for home-made wine? If so, of course he would not look upon this when it is red with equal favour! But good wine is said to need no bush, so it is a surprise to find it in the meed of the hive! Not that it is altogether inappropriate, for the original sign of a tavern was 'ivy! Whence no doubt the well-known "living sign" of a hive of bees! But I fear lest I may wander from the shelter of the point, Protection to wit, which is much to the fore nowadays, and free trade winds may be tempered to the workers, even though breezes be welcome in reason. If reason and truth be lacking in a metaphoric gale, it must be due to the inspiring fact that we have just weathered another of the windy Marches of Time! Still, the proverbial madness of the March 'air is only "tempery," and the season of the shorn lamb is not yet. And it is by no means desirable that early young bees should have the wool blown off their backs, rather that they should keep it on, and with it their temper. But the planting of these bushes around the hives would surely defeat itself, for cross-currents make wry-bees, so that a short-tempered time would see these all developed into the fruitless flowering variety!

Roofs (page 76).—Whilst favouring a flat roof, I venture to suggest that the extra labour and cost of special treatment of selected wood is at least as much as that involved in the calico covering. Very few amateurs would make such a satisfactory job as Mr. Soal appears to think possible, whilst they could make a perfectly tight and good-looking roof-top out of, at the worst, poor, knotty, or checked boxes by the calico process. Of course, I am not recommending poor wood—only emphasising the possibilities of this method.

Honey Imports (page 77).—There is a remarkable rise in the December figure, which cannot be explained by the occurrence of Christmas, as this month is usually amongst the lowest. The present year also shows an increase, and the January return is nearly three times that of the corresponding month in 1908.

Bees Leaving Hive (page 79).—Another answer to this query is that the migration was due to internal dissension, probably of a suffragette nature. These ladies had apparently everything that a mere man imagined was necessary to their happiness, and yet they swarmed out, deserting home and brood in blind devotion to some wild goose chase. Ah, these votareesses, for what are their contentions not answerable? Or should that be “unanswerable”? But they are no doubt too busy with the supply of missing-links to the chains of circumstance to take heed of a few light railings! It is to be hoped that their tenets will not spread amongst the hives, or we shall have the drones demanding stings, imagining, no doubt, that what is sauce for the proper goose is sauce for the propaganda! But that is an *anser* of a different feather!

The Death's Head Moth (page 81).—The abandonment would seem to be a poor reply to the attacks of these moths. Surely it would have been possible to exclude them whilst giving access to the largest bees. Sphinx *Atropis* is very large, and the size of its thorax allows some latitude in the mesh of a wire guard. Such serious depredations could, I think, only take place in a district where its food-plant, the potato, was extensively cultivated.

Bees and Railways (page 98).—“Worker” criticises on the strength of his success under different conditions. Trains pass “Worker” “continually night and day,” so that the bees become thoroughly trained, as it were! But has “Worker” really observed the effect upon flying bees at night? He is so effectually screened behind his *nom-de-plume* that it is impossible to guess which railway serves him so well, and there is a “de'il o' difference i' such like.” For all we know,

he may be located on a South London line, where slow trains and fast night-flying bees would account for his success.

I.O.W. Disease (page 101).—This further report of the work of Drs. Malden and Smith, and the fact that investigation is to be continued when possible, is very satisfactory. Mr. Imms's report was unavoidably incomplete, and inconclusive in that he was unable to definitely indicate cause. Once it is established that the disease is related to a specific bacillus, we are a long way on the road to effective dealing with it. The general indications were largely those of infectious disease, but confused to some extent by the existence of healthy neighbouring stocks, and the fact that the honey appeared to be aseptic and the brood healthy. Perhaps the germs perish rapidly, or the bacilli are confined to cells in the chyle stomach, or it may be that diseased bees cease to contribute to the stores and to feed brood. The last would appear probable in view of the apparent reduction of muscular power, which may not be intrinsically symptomatic so much as due to pain. The inflamed and easily ruptured state of the membrane suggests a resemblance between this disease and enteric fever, if it should need a popular name. Let us hope it never will.

Superseding (page 103).—We have heard a good deal lately in various journals of the merits of shaking up the bees. It seems that the action has the same renovating effect as upon a feather pillow! Some would shake them up continually, and appear to claim that the more the bees are disturbed the better they like it, which is at least opposed to the old and gentle method. Just ring them up, or run in any odd time, and give them a good hard shake of the hand, and never mind whether they are pleased to see you or not! I wonder what effect this rattle-box treatment has upon their temper? Well, well! At least, there can be no merit in the process of “hard shaking” (*per se*) for supersedure purposes. Shall we say Shakeprocedure for short? And this “Doolittle” plan which “D. M. M.” gives would seem to be more easily completed by the simple removal of the excluder, without either exciting or knocking about the new young queen.

Hints to Beginners (page 103).—We are constantly in debt to such writers as “D. M. M.” and Mr. Woodley, who give us freely to drink of the fount of their practical experience. There is a well of condensed wisdom in “D. M. M.'s” counsel to beginners, as, indeed, there always is. Such beginners would do well to read and re-read his advice, and spare themselves the initial mistakes of so many who rush into bee-keeping. The difficulty

is to get such advice to those about to begin, and it should be passed on to them by friends who are readers of the B.B.J. Those who do see it would do well to ponder on the advice to "go slow." Have they not already made some mistakes which need not be repeated? Have they obtained the best advice as to bees and hives and all the other paraphernalia, or have they in their unconsidered enthusiasm simply adopted the nearest secondhand rubbish? The best advice of all to a beginner is to urge him to get a "Guide Book."

Bee-keeping in Liguria (page 104).—M. Bertrand is so well known all over the world of bee-keepers that a letter from his pen is of considerable interest, and that this is intrinsic the running reader may here see at a glance. "Scot," from whom we have heard lately, might make a note of the fact that Dr. Olivier is able to make a living "being a bachelor"! But such an evidently capable man would probably have no difficulty in whatsoever state it should please him to be. As to the district, San Remo and Vievola must be ideally allied. Imagine a combined honey-flow which runs from April to mid-December! The round sections, one of which was shown at the B.B.K.A. meeting, are most interesting. A little expensive perhaps, as they hold about $\frac{3}{4}$ lb. of honey, and retail, Mr. Cowan tells me, for about 2 francs.

Bees and Pollen (page 105).—The real reason, Mr. Avery, for the failure of this hive to win was not, I venture to suggest, due to the race, but, as anyone who reads the account may see, to the fact of their doing so much of their work on a Sunday!

Bees and Cucumbers (page 107).—It is too bad that poor bees should be chased around the greenhouse, and solely because they happen to be in the right frame to fertilize the fruit. It is gratifying to know that in America such a chase would be fruitless in more senses than one. We long ago learnt in "Reading without Tears" that every blossom has a bee in it, but this particular bee was evidently in search of the knowledge how to keep as cool as a blooming cucumber!

TRADE CATALOGUE RECEIVED.

MRS. SEADON (*The S. J. Baldwin Apiary, Bromley*).—The complete catalogue of hives and appliances supplied by the old-established firm of S. J. Baldwin, whose successor is Mrs. Seadon, includes the "Common-sense" hive having the reversible floorboard alluded to in B.B.J. on page 107. Also a new hive called the "Adaptable," which was exhibited and explained by Mr. Seadon at the conversazione of the B.B.K.A. on March 18 last.

The body of this hive is wedge-shaped, and therefore reintroduces the taper frame advocated by the late C. N. Abbott in 1875 (B.B.J., 1875, page 132), which was abandoned on the adoption of the standard frame. The floorboard is reversible, with an arrangement allowing a 3-in. space underneath the frames. There are two entrances, which can be used with the floorboard in the different positions. Catalogue post free on application. "The S. J. B. Hints on Bee-keeping," originally compiled by S. J. Baldwin, is now published separately, price 6d.

Queries and Replies.

[3908.] *Wax-moth in Combs*.—The enclosed piece of comb is taken from a standard frame which was removed from the brood-chamber of hive last summer. The comb has been stored away in a large tin trunk (where I keep appliances) in a warm, dry room. On taking it out the other day I found a portion to be in the condition of the enclosed. Will you please inform me: 1. If this is the wax-moth or what it is? 2. Why it should have appeared after the comb was stored away? 3. How can I avoid a repetition of this in future when combs are put aside? The stock was purchased by me in April last year, and though the combs are probably rather old the stock was a very healthy one, there being nothing to indicate the presence of anything foreign, as far as I could see, in the comb in question.—C. C. WILLIAMS, Barnes.

REPLY.—1. Yes; it is badly infected with wax-moth. 2. The eggs were deposited in the empty combs, and the grubs had hatched out after the combs were put away, and have been living on them since. 3. When removed, hang the combs in a hive, which must be placed on an empty one in which sulphur should be burnt. Make all tight by covering the top, and the joints should have paper pasted over them so as to keep in the fumes. This will destroy the moth and grubs. The hives with the combs can then be wrapped over with newspapers and stored away. This process should be repeated at intervals with all combs that are put away for future use, as moth will find access to the wax through the smallest opening.

[3909.] *Removing Bees from Trees*.—Would you kindly answer through the B.B.J. the following? 1. Could I start a hive with a stock of bees obtained from a tree? 2. When would be the best time to remove the bees and to transfer them to the hive? 3. Can you tell me the easiest way to get them out of the tree, which is about 18 in. diameter, with a fairly large opening? I intend to start bee-keeping this season, and have got the "B.B.K. Guide Book," from which I have obtained considerable information. — Novice, Michaelstone.

REPLY.—1. Yes; if the colony is a strong one, with plenty of bees. 2. Any time from the middle or end of this month. 3. Prepare a small colony of bees or a nucleus, and put it into an ordinary hive. Blow smoke into the nest, and construct a platform for the hive to stand on just below the hole in the tree. Over this place a "Porter" bee-escape in such a way that the bees can come out but not go back again. The hive is then placed with its entrance as near the bee-escape as possible. The bees in the tree, as fast as they come out, are unable to return, and find their way into the hive on the platform. In four or five weeks

there will be few bees left with the queen in the tree, and little brood, as none of the bees leaving the tree can ever return. Then the bee-escape is removed, and the few bees remaining are brimstoned. The bees, with the hive, are left on the platform, and they rob all the honey out of the old nest in the tree in the course of three or four days, and carry it into their hive. The hive is then removed and placed on its permanent stand. If the tree is near the apiary, of course the bees must not be allowed to clear out the honey from the nest, as it might set up robbing among the other bees. The hive would also have to be taken two miles away before being brought back to the apiary.

[3910.] *Dysenteric Bees.*—I should be pleased if you could answer me the following questions: 1. Would you advise me to use foundation in frames that have been stained with dysenteric excrements? 2. If I feed bees that have had dysentery with candy, must they be allowed to fly to discharge their excrement, or may I close them up to keep them warm?—YOUNG NOVICE, Southwram, near Halifax.

REPLY.—1. The best plan is to get rid of the soiled combs and frames, and as the latter are cheap it would be better to put foundation into new ones. 2. You must not close the entrance, because the bees must have the means of getting out on fine days to void their excrements. The attacked colony should have a clean hive and floorboard given to it, and should be well covered up and protected from cold, as directed in "Guide Book," page 171.

Notices to Correspondents.

T. A. EAGLES (Birmingham).—*Moving Bees.*—It is not safe to move the bees the distance you propose, and you must do so not more than 3 ft. each day, not reckoning those days on which the bees are not flying, or they must be taken a distance of two miles or more, and after having been left there ten days they can be brought back to the place you wish them to occupy.

J. H. (Whitley Bay).—*Beginner's Queries.*—1. It will not hurt the bees to paint the inside of hive, provided the paint is thoroughly dry and hard before they are put into it. 2. The subscription for membership of a bee-keepers' association varies from 2s. 6d. to 5s. and upwards a year. 3. Mr. J. C. Hedley, Woodburn, Stocksfield-on-Tyne, is the hon. secretary of the Northumberland B.K.A.

W. H. BRADBURY (Harrop Green).—*Dead Queen Cast Out.*—The appearance of the queen sent indicates "balling" rather than old age, and you should take the first opportunity on a fine day when bees are well on the wing to examine the hive and ascertain if they have another queen. NOVICE (Crewe).—*Surplus Stores in Hire.*—If you find there is not sufficient room for brood-rearing, you can remove some of the combs stored with syrup and substitute empty ones, and if the former are put in a dry place they can be kept for future use.

Suspected Combs.

S. H. (N. Devon).—The comb is affected with foul brood in an advanced stage, and the contents of the hive should be destroyed, as it would not be safe to use the combs even if you cut out the diseased brood. You must also disinfect the hive before using it again.

BEGINNER (Rochester).—Comb is quite new and has never been bred in, consequently there can be no foul brood in it. The suspicious cells contain pollen, some of it being hard and turning mouldy.

* Several important letters, &c., are in type, but held over from pressure on our space.

Special Prepaid Advertisements.

Twelve words and under, Sixpence; for every additional Three words or under, One Penny.

OFFERS WANTED IN HIVES FOR A 410 BORE GUN, in good order.—R. BANNISTER, The Brook, Brigg, Lincs. o 75

HANDY MAN, expert, seeks situation, thorough knowledge of Queen-rearing and working for honey; hive-maker, gardener, good knowledge of poultry.—"DENNETT," c/o B.J. Office. o 63

APIARIAN OPEN TO ENGAGEMENT, experienced in Queen-rearing and mailing, &c., also in working for Honey in clover or heather district; hive-maker; help gardener to fill up time if necessary.—"B.," c/o BEE JOURNAL. o 62

TO LET, good Cottage Garden and Greenhouse, &c., with detached villa, about 2 acres good growing land, one of the best Honey districts, with trade, and plenty of expert work; good cause.—TRADER, c/o Offices B.B.J. o 72

BEEES IN BAR-FRAME HIVES, good workers, 12 frames, 25s.; 10 frames, 20s.—BURGESS, Wenden, Saffron Walden. o 73

WANTED, last year's Swarm on ten frames, without Hive.—E. HILL, 29, Vicar-road, Wath-on-Dearne, near Rotherham. o 70

WILKES' CONVERTIBLE FEEDERS, 3 doz. secondhand, complete and in good condition, 10s. doz., free on rail; 1s. 4d. each, post free.—G. MANNING, Clapper-lane, Staplehurst, Kent. o 67

FOR SALE, Racks of Shallow Combs, also some Standards, guaranteed healthy, only used one and two seasons, frames in flat, foundation, section crates, &c., several stocks of Bees.—W. COPSEY, Expert, Seaton, Workington. o 66

HONEY.—3 cwt. Light, 2 cwt. Medium, at 56s. to clear; Extractor, geared, 15s.; 4 "W.B.C." Section Racks, 2s. each; Queen Excluders, 6d. each.—CHARTER, Tattingstone, Ipswich. o 65

REASON NO. 2 WHY TILLEY'S PATENT "WON'T LEAK" SECTIONS SHOULD BE USED BY ALL BEE-KEEPERS: They are better for the producer, seller, and consumer. Being hermetically sealed, they are less liable to granulate than honey-comb in any other form. Send address on post-card for particulars. Sample, post paid, 6d.—M. H. TILLEY, Bee Farm, Dorchester. o 68

3 STOCKS HEALTHY BEES, in nearly new Hives, two 1908 Queens, also nearly new Hive, 4 Section-racks, 4 Shallow Frames, boxes new, "Brice" Swarm-catcher, £3 10s. the lot. Owner removing from country (Dorset).—For particulars apply, HENRY ROWSWELL, 116, Mawson-row, Chiswick-lane, Chiswick. o 71

HIGH-CLASS MICROSCOPE, by well-known maker, two objectives, two eye-pieces, splendid condition, 60s., great bargain.—L. WAKEFIELD, Blackmore, Bromsgrove. o 76

130 LB. PURE LIGHT ENGLISH HONEY, in 4 tins, at 6d. per lb.—STRICKSON, Wansford, Northants. o 74

BARGAIN, £4 4s., or exchange for Bees value £6 6s., new Bicycle, pneumatic, roller lever, rim brakes, Crabbe three-speed gear; also sell motor cheap.—GORDON, Bassingbourn, Royston. o 69

FOR SALE, new Straw Skeps, 1s., 1s. 2d., 1s. 4d., and 1s. 6d. each, cash. Send for at once.—SEAMARK, Willingham, Cambs. o 64

150 LB. OF COMB FOUNDATION, made of pure beeswax, rather darker in colour than usual, guaranteed equal to any in use, not less than 7 lb. parcels at 1s. 8d. lb., post free.—ABBOTT BROTHERS, Southall, near London.

8 STRONG STOCKS OF BEES, in 10-frame Hives, 25s. each, guaranteed healthy.—C. RAYNER, West Bergholt, Colchester. o 78

Editorial, Notices, &c.

BRITISH BEE-KEEPERS' ASSOCIATION

CONVERSAZIONE.

(Continued from page 133.)

In the unavoidable absence of Mr. Woodley, who undertook to read a paper on "The Production of Comb Honey," the Chairman explained that Mr. Herrod had kindly consented to open that subject in his place.

Mr. Herrod said that once again he had been called upon to step into another person's shoes, as he had done many times before, and he felt he could hardly expect to do that justice to his theme with which Mr. Woodley or Mr. R. Brown would have treated it. The latter gentleman had made the production of comb honey, for sale as well as exhibition purposes, a speciality. He (the speaker) would not, however, pretend to go beyond what efficient bee-keepers knew. The first point that would naturally strike everyone as most important was whether comb or extracted honey paid the producer best. As to that, of course they must be guided by circumstances. When a bee-keeper supplied comb honey he parted with a valuable product—namely, beeswax. All knew that in the making of beeswax the bees consumed a large amount of stores, and the process told on their lives considerably; but the prime thing to consider, as he supposed everyone looked at the commercial side of the industry, was, "What is your market?" If your market was for comb honey, then it would be very foolish to try to force extracted honey on it, or *vice versa*. Plenty of bee-keepers did not consider the production of wax. Personally, he liked to produce extracted honey, as with the production of sections, &c., difficulties arose, especially to the novice: there was the difficulty of getting the bees into the supers, and also the prevention of swarming. One could very easily prevent swarming in working for extracted honey, and he had known an apiary of thirty colonies worked for five or six years for extracted honey without a single swarm. Directly sections were worked for swarming took place. When a bee-keeper began to work for comb honey he found that as the bees must be kept so warm there was a constant tendency to swarm. Some districts provided far better comb honey than others. For instance, where mustard was grown he would not advise the apiarist to produce sections, because mustard honey granulated quicker than almost any other. Another point was the strain of bees—a very important factor in working for sections. He was sure that Mr. Woodley and Mr. Brown, prob-

ably the best comb-honey producers in the country, had the right strain of bees for that purpose, and had given that matter their best attention. No doubt they had selected the best colonies in their apiaries specially for comb production. He had tried experiments, and had come to the conclusion that if good comb-producing bees were wanted, let them stick to British bees, which were far the best for that special purposes. Again, there was the question as to the use and the non-use of the excluder. He was for the use of it. (Expressions of dissent.) He quite expected that. There was no doubt the excluder did in some cases hinder the work of the bees, but, on the other hand, it was annoying when taking out sections to find the best-built ones full of brood. He hardly thought, however, that there was much hindrance in using the excluder if it were properly adjusted. Some bee-keepers put the slots of the excluder so as to run parallel with the frames, but if the slots were put at right angles instead the effect would be altogether different. Then there was a right and a wrong side to the excluder. In fixing it care should be taken to put the rough edge, caused by stamping out the slots, upwards; if turned the other way the bees could not pass through easily. Better still would be to take a piece of emery-cloth and smooth down the rough edges before making use of it. Should a bee-keeper not wish to use the excluder, let him place a quilt so that it reached within an inch of the outside of the brood-combs, and allow the bees to come up round this; but the simplest plan was undoubtedly to use excluder-zinc. Then as regarded the receptacle for the honey. In the case of heather honey it did not matter so much what kind of super was used. The Rev. Mr. Lamb, of Burton Pidsea, exhibited at the Dairy Show some years ago, and when the show was over he disposed of his heather honey by cutting it up into chunks, wrapping it in paper, and the purchasers carried it away in their pockets. He (Mr. Herrod) wondered how they would have fared had it been any other kind of honey; but heather honey was so gelatinous that it would hardly leave the combs. Then the day of boxes, bell glasses, and caps was over. Bell glasses were generally too large. If sold for table use, the objection was that the honey could not be used in small quantities; the moment the comb was cut it began to leak, and so spoiled the appearance of the remainder. Then with reference to the best rack to use. Undoubtedly the hanging section-rack was one of the best that could be devised. In the first place, it kept the sections perfectly clean. Secondly, they were held quite square—a great consideration. Again, it

allowed of movement; by this he meant that the bees usually began building their comb in the centre of the supers, and if they did not seem to be spreading themselves properly he moved the outside hanging frames to the centre. With the ordinary section-rack it was difficult to manage this without crushing bees. The novice was usually anxious to obtain honey as soon as possible to place on the teatable for friends. He had known them many times remove a single section for this purpose. This could easily be done with the hanging rack. One thing against it was its cost, which was more than that of the ordinary section-rack, and whether the extra expense was justified by results was for every bee-keeper to decide for himself. Now let them consider the ordinary section-rack. It generally held twenty-one sections, with following-board and spring block, and often with tin T girders, to which he objected very strongly. In the first place, T girders allowed of propolisation between the sections. Also, in carrying the racks full, more than once he had had the whole lot drop through the bottom simply because the girders were not strong enough to sustain the weight. Then also the sections were not held closely together on account of the piece of girder standing upright between each row, and if out of the square it was difficult to either glaze them or put them into cardboard cases. The section-rack he preferred had $\frac{7}{8}$ -in. slats running along the bottom to carry the sections, and the rack would cover the whole of the top of the brood-chamber. Some of those present no doubt knew the difficulty of using a rack built just to hold twenty-one sections; packing had to be used on one side or the other to prevent bees escaping from brood-chamber. They had to build out the side of the rack to cover the whole of the brood-chamber, and to keep the sections tight a following-board and spring were used at the side as well as the end. The style of rack he was advocating could be worked in conjunction with shallow frames on the same hive. With the ordinary rack, if a shallow-frame super were put above a section-rack both bees and heat could escape through the space left owing to the difference in size. If the section-rack was built out at the side it kept the sections perfectly square and forced them tightly together, so that there was no danger of propolisation. Care must be taken when using spring blocks to avoid the warping of the following-board. The point of the spring being kept towards the outside of rack would make the wooden part of block form a cleat across the following-board. Bee-keepers did not always go the best way to work in removing sections; the plan of

turning the rack upside down was the way to break a great many. Yet this often had to be done with the ordinary rack, and forcing out with the thumb caused greater damage still. As with the rack mentioned both side and end movement is possible, all this breaking is avoided. When sections were first put in the rack, it was a good plan to rub a little vaseline on the wooden slats to prevent propolisation.

The next point was the question of dividers. Should wood or zinc ones be used? There were drawbacks to wooden dividers, one being that they buckled very much. In the case of sections which were not as nicely built out as they ought to be, this buckling was generally found to be the cause of this fault. Another suggestion was, do not use dividers that require to be fitted in each individual section. He liked a divider that reached to the top of the section, as this prevented the extension of the few cells in the top row so often found. The thinner the divider used the better.

As to the best kind of sections there was a diversity of opinion. He, personally, preferred the two bee-way section rather than the four-way, fitting them with full sheets of foundation rather than starters. It appeared to him that a starter was the natural way for the bees to build their comb, but full sheets gave stronger comb and saved the bees much labour.

All bee-keepers knew how gently porters on the railway set down parcels and packages, especially those marked eggs, glass, or comb honey, and it was a common occurrence for sections to be broken in transit. Therefore, full sheets of foundation were necessary to get good, firm combs. A mistake was often made in putting the foundation right down to the bottom of the section; if they were to allow $\frac{1}{8}$ in. or $\frac{1}{4}$ in. from the bottom far better sections would be produced. As to the methods of folding sections, some people used a block, while others manipulated with the fingers. If they showed any tendency to snap when being folded just damp the V joints on the outside with a brush and hot water; do not pour the water into the joints. In getting bees into the sections a bait could be used. If a few sections from the previous year were saved, one of these could be used in each rack. In getting to the honey the bees would find their way through the excluder quickly, and having once got through would remain in the super if properly packed and draughts prevented. He remembered going to an apiary in the South of England in company with the late Mr. Carr. A bee-keeper having complained that he could not get his bees into the sections, Mr. Carr looked at them

and said, "They are never likely to go there as they are at present." He then put the quilt down along one side where a chink had been left, and in less than three-quarters of an hour the bees were working in the super. Their absence before was simply caused by the draught. In putting on a second rack always place it underneath the full one, as the less bees travelled on the face of the comb the better, because there were no doormats for their tiny feet, and the cappings were liable to be stained in consequence. Also if the partially filled rack was placed at the top of the hive the honey would ripen quicker, and the sections would be sealed over in much less time than otherwise. The bees would also go up to finish their work, and be attracted to the new super. Sections should be removed as soon as possible. If that was not done a thickening of the cappings followed. For travelling that was a benefit, but on the show-bench it was fatal. Otherwise beautiful sections were often spoilt in that way. When removing supers they should not puff a lot of smoke into the hive before putting on the "Porter" bee-escape. If this were done the bees perforated the cappings of sections, and so spoilt their appearance.

Very often he received honey for sale purposes which did not look nice, but which could be improved by bleaching; it should not be placed in the window, where the direct rays of the sun beat on it. If placed in a good light the colour of comb honey could be improved considerably. When removed from the hive sections should be cleaned from propolis, and then stowed in a dark, dust-proof, and warm place. In selling, he recommended them to dispose first of the honey obtained last. That sounded rather Irish, perhaps, but the honey obtained later in the season always granulated much quicker than that first produced. If honey came in freely, and the sections were built out quickly, they were always good ones.

Another suggestion was, do not keep putting on supers when the flow begins to decline. When supers are taken off, the unfinished sections should be put back in one rack, so that at the end of the season there would not be a lot of incomplete ones on hand. A further piece of advice he would give. Do not save the woodwork of the old sections to use over again. The audience would be astonished if he were to tell them of all he had seen in connection with this, even among people who might be expected to know better. He was not an appliance dealer, but nevertheless he advocated the use of new sections every time. He was quite disinterested in this matter, for he himself had not exhibited since 1901, and probably would not do so again; therefore he did not mind giving

away a little experience. Good sections could be obtained in several ways. One method was to have a die made just the size of a section, then to take a nice shallow frame, cut out the comb with the die, and place it into the section, letting the bees afterwards fasten it round. (Laughter.) He had never done that on his own behalf, but when working for somebody else he was obliged to do it. Most bee-keepers know that as the bees in a swarm are prepared for comb-building, they do the best and quickest work. Another way of getting sections was to hive a swarm on shallow frames with comb already drawn out, and a couple of section-racks above, and if honey was coming in freely the bees would be forced up into the sections, which they would soon fill and seal over. As to heather sections, where heather was obtained the bee-keeper who had the most drawn-out comb on hand was the man who was going to secure the most honey. He was afraid he had detained the audience at great length, but he was still conscious that the subject was by no means exhausted.

(Concluded next week.)

REVIEWS OF FOREIGN BEE-JOURNALS.

By "Nemo."

Pollen for Bees in Spring.—M. Gubler says in the *Bulletin de la Société Romande d'Apiculture* that the principal requirements of bees in spring are fresh pollen and water. As at this season the temperature is frequently very low, there is the risk of losing a large number of bees if they have to fetch water from a distance. A drinking-fountain should be placed near the hives in a sheltered place, and it is a great advantage if means are provided for keeping the water warm. Those who tried this plan last year are unanimous in saying that they not only lost fewer bees, but that the colonies developed much more rapidly. Bees obtain fresh pollen from hazel, alder, and arbor vitæ trees in spring when they are able to get out, but these blossoms are all over in February. As pollen is so abundant in these flowers M. Gubler recommends that it should be collected by shaking the branches with the catkins on them on to a sheet, and using the pollen thus collected for mixing with diluted honey, which, given to the bees in March, is a first-class stimulant.

Claustral Hive.—L. Roos gives us the results of another season's experience with claustral hives in *L'Apiculteur*. His claustral hives, although they swarmed, gave an average return of 18 kilos

(39½ lb.) per hive, while his ordinary hives, although one of them was doubled by uniting, only gave an average of 13 kilos to 14 kilos (28½ lb. to 31 lb.). He points out that the swarming of the bees considerably modified the results, which would have been more favourable had such swarming not taken place. The wide differences in the relative results are all in favour of claustration, and decided M. Roos to go in for it on a larger scale in 1907-8, resulting in equal success with that of the previous trials. He considered the wintering of the bees was remarkable for the small mortality among them compared with previous winters. He had hives closed from the middle of November to the middle of March in which hardly a hundred bees died. The writer's results help to confirm those obtained by M. Preuss, Abbé Eck, and Abbé Gouttefangéas. The last even goes so far as to say that before obtaining strong colonies it is first necessary to have the means of preserving alive all the inhabitants of a hive, and this means he obtains by claustration.

A Significant Warning.—According to the *Badische Landeszeitung*, at a general meeting of the Bee-keepers' Association of Baden it was decided to sever all connection with the Eribourg-in-Brisgau Society. The reason given by a contemporary is stated to be in consequence of certain bee-keepers feeding their bees with sugar-syrup on a large scale—a practice which was denounced by some of the members.

The late Ch. Zwilling.—The *Elsass-Lothringische Bienenzitung* records the death of the late secretary of the Alsace-Lorraine Bee Association. M. Charles Zwilling was born at Pfeffenhofen on July 7, 1832, and after studying at the normal school at Strassburg held several appointments as master, finally retiring on a pension from Mündolsheim in 1900. He took an active part in the formation of the society, and much of its prosperity was due to his unceasing work in its behalf. In 1874 M. Zwilling, with M. J. Dennler, became editors of the journal which they conducted together until his last illness. In 1875 he was nominated secretary, and owing to his eloquence was in great demand as a lecturer in French and German, thus bringing in constantly new adherents to the society. He also organised numerous exhibitions which were held in different towns in Alsace and Lorraine. The Government recognised his merits, and in 1883 he was decorated with the Order of the Crown (fourth class). On the twenty-fifth anniversary of his nomination as secretary the Government awarded him an honorary diploma. M. Zwilling published

in 1887 his *Guide Théorique et Pratique* and *Praktischer Wegweiser*, and by these and other publications he has rendered great services to apiculture.

La Revue Française d'Apiculture is a new monthly journal devoted to bee-keeping, which has just made its appearance in Marseilles. It is the official publication of the Société d'Apiculture des Bouches-du-Rhône, and is intended to supply bee-keepers of the South of France with a first-class technical paper. Its object will also be to develop, propagate, and popularise bee-keeping, to compare the methods of the North of France and foreign countries with those of the South, and to advance bee-keeping in general. The first number consists of thirty-two pages, and is well edited and printed, and we wish the venture every success. The subscription price is 6 francs a year.

Well-merited Distinction.—The University of Bern has conferred on M. U. Kramer, the President of the Verein Schweitzer Bienenfrenunde, a Doctor's degree *honoris causa*. Dr. Kramer has done a great deal in Switzerland for the advancement of the science of bee-keeping, and this distinction is well merited.

In Germany two well-known bee-keepers have also been rewarded—Herr Roth in Durlach has received the Order of the Crown (fourth class), and Pastor Gerstung, editor of *Die Deutsche Bienenzucht in Theorie und Praxis*, has been decorated with the Order of the Red Eagle (fourth class).

W. B. CARR MEMORIAL FUND.

	£	s.	d.
Amount already acknowledged	34	14	6
Lanes B.K.A.	1	1	0
Jas. Lee and Son	1	1	0
E. D. T.	1	1	0
Fredk. H. Taylor	0	5	0
W. McNally	0	5	0
T. W. White	0	5	0
Elvey E. Smith	0	2	6
	£38	15	0

LINCOLNSHIRE B.K.A.

ANNUAL MEETING.

The annual meeting of the Lincolnshire Bee-keepers' Association was held at the Louth Municipal Technical School on Saturday, March 27, and was well attended. Alderman H. D. Simpson presided.

The nineteenth annual report, for the year ended December 31, 1908, was presented, from which it appeared that the credit balance had been increased from £16 13s. 9d. to £23 11s. 8d. during the year.

In submitting the report the committee referred with the greatest regret to the great loss which the association had sustained by the death of Mr. G. J. Young, who had acted as chairman for many years; and to the resignation, under medical advice, of Mr. R. Godson, who had held the position of hon. sec. since the association was reorganised in 1889.

The season had been a fairly good one, as shown by reports received from different parts of the county. In some districts the yield had been much above the average, whilst in others scarcely any surplus was stored. In every case, however, the honey gathered was of excellent quality, and met with a ready sale.

Lord Willoughby de Eresby, M.P., had kindly consented to give a hive for competition at the County Show to be held at Louth in July, under the same conditions as that given by the late Baroness Burdett-Coutts. In conclusion the committee thanked all who had in any manner assisted in making the work of the association a success.

Alderman H. D. Simpson moved the adoption of the report and statement of accounts. Mr. B. McLeod seconded, and the proposition was carried unanimously.

The officers for the ensuing year were elected as follows:—President, Lord Willoughby de Eresby, M.P.; the retiring members of the active committee were reappointed, with the addition of Mr. F. H. K. Fisher (Ewerby), Mr. F. C. Cribb (Gainsboro'), Dr. Carlisle, and Dr. P. Sharp (Brant Broughton); chairman, Dr. Sharp; treasurer, Mr. Bentley; auditor, Mr. G. B. Walker; librarian, Mr. B. McLeod; secretary, Mr. J. H. Hadfield.

Alderman H. D. Simpson consented to give a hive for competition at the County Show.

Dr. Percy Sharp, of Brant Broughton delivered an interesting lecture on bees, which was illustrated by lantern slides.—J. HADFIELD, Hon. Sec.

LEICESTERSHIRE B.K.A.

ANNUAL MEETING.

The annual meeting of this association was held at Leicester on Saturday, April 3, under the presidency of Mr. G. O. Nicholson, of Market Harborough. The report stated that as to membership the results of the year were ahead of any yet recorded. Forty-five new members were enrolled, the total number now being 318, against 303 in the previous year. The balance-sheet showed that although there was only a slightly increased sum in hand, the position was satisfactory, especially when the two discouraging seasons for honey production were taken into consideration. A new district had

been opened out at Broughton Astley. The expert work had again been satisfactorily carried out, and the general health of the stocks was reported good. The finances showed a balance in hand of £3 11s. 3d., against £1 11s. 3d. last year. The report and financial statement were adopted, and officers elected for the year.

The council felt they could not conclude the summary of the year's work without referring with deepest regret to the death of Mr. W. Broughton Carr, by which the whole bee-world had sustained a severe loss.—(Communicated.)

Correspondence.

The Editor does not hold himself responsible for the opinions expressed by correspondents. No notice will be taken of anonymous communications, and correspondents are requested to write on one side of the paper only, and give their real names and addresses, not necessarily for publication, but as a guarantee of good faith. Illustrations should be drawn on separate pieces of paper. We do not undertake to return rejected communications.

NOTES BY THE WAY.

[7429.] The month of March will be remembered as the sunless month. That, at least, is the experience of dwellers in Wessex, there having been only two or three days during the month on which our unfortunate bees were able to take a cleansing flight, and no opportunity for gathering pollen or even the artificial substitute presented itself.

Now April has arrived, and though we are experiencing a cold nor-easter, it is accompanied by brilliant sunshine, which brings out the bees in crowds. The watering-places are brown with them, sucking the moisture from the tea-leaves placed there for their use. To give them a fillip in breeding I have fed them with thin syrup in shallow tins, using cut straw as a float to prevent the bees drowning. This I shall continue for a few days till natural sources are tempting them to the woods and fields. I saw the first dandelion on Saturday, April 3—very late for this hardy plant to show first blossoms.

Spring Cleaning.—A roll call proved all stocks alive, and as soon as there is a spell of suitable weather the apiary should undergo the annual spring cleaning. Hives so far I have only taken a peep at, and in some cases simply given a cake of soft candy, with no disturbance of the quilts at all, but most of the stocks are strong in bees to all outward appearance.

In addition to spring-cleaning the hives, clear up any old combs which may be on hand, melting them down into wax, and so prevent the growth of that pest, the wax-moth.

Shaking up the Bees seems still one of the topics under discussion across the ocean. It appears to me that a pair of drum-sticks would give them a good jarring, or the hive might be placed on a housemaid's cinder-sifter and gently rocked, especially if the combs are fixed both top and bottom. We may have our hives made with rockers instead of the usual legs, if we find that shaking increases the honey-gathering powers of the bees. I am not trying the shaking-up method myself, at least not this season. I'll bide a wee.

With large apiaries orders should be placed for goods at once where not already done, and I would commend the use of new 1909 super foundation for filling the sections. Any old foundation left over from last year may be used for the second or third racks on strong colonies, but to start the season use new extra thin "Weed." I prefer "British 'Weed'" myself, and each year proves the utility of using full sheets for sections. I use Abbott's little roller fixer, which fixes the foundation by warmth and pressure at the top of the section only; but by careful cutting, so that it touches the sides and hangs within $\frac{1}{4}$ in. of the bottom, we get excellently filled sections. Warmth is essential for supers if you wish to be successful in producing commercial sections.—W. WOODLEY, Beedon, Newbury.

BEEES AND POLLEN.

[7430.] My request for information as to the time of starting pollen-gathering and the source of the pollen collected has brought so many kind letters and postcards that it is impossible for me to reply to them, and I take the opportunity of expressing my thanks to the writers through the B.B.J. Much of this correspondence is very interesting, and I gather from it that this season the bees in Cumberland began work as early as those in counties in the extreme south of England and in Wales. The greatest surprise of all is that the correspondence disclosed the fact of pollen being gathered quite as early so far north as Elgin, in Scotland. The source of the early pollen seems to be the same all over England and Wales—namely, crocus, aconite, hazel, and palm-willow. In Scotland gorse is added to the list. Several writers have mentioned the snowdrop, but I believe this must be a mistake, as I have never in my long experience of bee-keeping seen a bee remain long enough on a snowdrop to collect either honey or pollen from it; and very rarely have I seen one visit this flower at all, even when no others were in bloom. Probably the district has an effect on the pollen-bearing properties of some plants, as the hazel is frequently mentioned, and although this is quite

plentiful here—some boughs of it from which the pollen could be shaken in little clouds overhang my hives—yet, after spending much time in watching, I have never seen a bee visit the blooms. This district is now studded all over with clumps of gold, the willows being in full bloom and much resorted to by the bees. I have just heard of a swarm at Gretna last Wednesday (7th). Probably this would be a "hunger swarm," as bees generally are a long way off swarming-point in the district.—G. W. AVERY, Heads Nook.

WARM WATER AND STIMULANTS.

[7431.] Warm water for the bees! It is a bright day in early spring; the bees are tempted by the sunshine to venture out, but cold blows the east wind over the Cumberland fells. The bees smell the cosy corner and the warm water; they cluster round it, a family party discussing last winter's experience, and one old bee, rubbing her antennæ against her mate, says (if bees talk slang): "I say, old girl, this is a bit of orl right," and they proceed to sip.

But, joking apart, there is a foundation of common-sense in Mr. Avery's idea. I have a theory—it may be incorrect, but many years' experience and observation confirm it—that foul brood is often germinated by impure water carried into the hive by foraging bees. The earliest stages of the disease are noticeable at a time when the egg just hatched has been fed a day or two on the pap of honey, pollen, and water prepared for it by the nurses. It is a putrid fever, commencing with disorder in the alimentary canal, and the tender digestive organs of the larvæ cannot resist the poison. Bees have a very depraved habit of visiting ditches, drains, and, in farmyards, even the foul pools by the manure heap for moisture; possibly the salic flavour has some attraction. But offer them something better to draw them to the *aqua pura*. Warmth will do it, sugar would be a further incentive, nor would they need a *tertium quid*.

I am interested in Mr. Sladen's paper on stimulative early feeding. But I do not observe in the discussion any remark as to a very frequent occurrence. When stocks are early pushed on by feeding, a few bright days tempt the bee-keeper, who is anxious to build up his stocks. He gives his bees as much food as they can take down, the brood-nest expands; but a blizzard such as we had last year sweeps over the country. Cold compels the bees to cluster again, the outer frames of brood get chilled, and the last state is worse than the first; and the moral is: If feed you must, commence with moderation, and do not overdo it. Yours sincerely in the craft.—J. SMALLWOOD, Hendon.

VISIT TO DR. C. C. MILLER.

[7432.] In October last Mrs. Schröder and myself made a trip to the United States, travelling by the Cunarder *Carpathia* to New York, and then towards the West, stopping a few days in Chicago. Being only about eighty miles from Marengo, where Dr. C. C. Miller, the well-known bee-keeper and author, resides, we decided to call upon him, and left Chicago by rail, reaching Marengo in about two hours. After lunch in a small, but clean-looking, restaurant, we went to Dr. Miller's residence, about four miles from Marengo, a very nice colonial house, surrounded by fields and bushes, with some outhouses, about a hundred yards from the main road. Notwithstanding the rainy weather, the place gave us a very

93 lb. from one hive has been the biggest "take" I ever had in my thirty-five years' experience with bees! Miss Wilson, Dr. Miller's sister-in-law, also a well-known bee-keeper and writer, assured us that she could clean over a thousand sections in a day!

In another house we met a nephew of the Doctor's, who was busy preparing crates. Here we saw how these were made, how the sections were folded up on a little appliance from the well-prepared and grooved sections in the flat, and how the comb-foundations were fastened in these sections. This operation was accomplished by the aid of an ingenious little machine containing a thin iron plate, heated by a candle, on which the foundation is placed inside the box, sticking fast



DR. C. C. MILLER IN HIS APIARY AT MARENGO, U.S.A.

pleasant impression, and very friendly was the reception of the old gentleman, whom we disturbed during his afternoon nap. After I had taken some photos of Dr. Miller and Mrs. Miller, of which I enclose copies, the Doctor showed us over his place. We saw the cleaning and crating of sections, of which he had secured over 19,000, mostly containing white clover honey. They were well filled and uniform in colour and finish. Dr. Miller stated that with a good honey-flow the bees do not stain or propolise the sections much, if these are put on at the right time, and confirmed the universally recognised fact that to get good crops bees must be ready just at the proper time—viz., strong colonies and young fertile queens. In our rocky country crops like these are unrealisable dreams—about

to the section as soon as the iron plate is withdrawn. The work goes on very rapidly, this being necessary considering that to prepare 19,000 sections the sticking has to be repeated 38,000 times, as the sections are provided with two strips of foundation, leaving a small space between them, which the bees work out into perfect comb. We saw many other implements, which, although of great interest to us, it is impossible to describe now.

Abruptly Dr. Miller asked me what had become of parthenogenesis and Dickel's theory. I replied that parthenogenesis was standing fast, notwithstanding the continued pretension that it was not true by Dickel, who up to the present has failed to give any proof of his hypothesis. "I kept that matter out of our bee-

papers," Dr. Miller replied, "and leave it to you on the other side to fight it out. We are progressing all right with our bee-keeping on the parthenogenesis principle, and when you have reached a satisfactory conclusion we shall at once take it up to the benefit of our industry."

Very pleased and satisfied with our call at Dr. Miller's, we returned to Chicago, and send our best greetings to this American Nestor of bee-keeping.

I cannot post these lines without referring to the death of Mr. W. Broughton Carr, whom I had the pleasure of meeting some years ago in the office of the BRITISH BEE JOURNAL.—ALEX SCHRÖDER, Trieste, Austria.

HIVE-CONSTRUCTION.

[7433.] I am delighted to find I am not alone in advocating hives to take twelve to fifteen frames, for—to me—a ten-frame hive is simply an aggravation. I have proved the fourteen-frame hive to answer to all the advantages claimed by "G. S. N., Godstone" (7415, page 115); but, as a practical joiner, I find it is just as easy to make outer cases bevelled or tapered as it is to make them rectangular, and results in a far more workman-like job. But I use 11-in. outer cases, which are better than so many shallow "lifts."

Which Way Should Frames Hang?—Most decidedly best results are obtained, in my opinion, by their hanging parallel with entrance. This position is also a great help in controlling swarming.

Roof-covering.—I should say that the worst covering is painted calico, for wood contracts and expands with the weather, but calico would not, the result being cracks.

No doubt I am like many another, to whom, when commencing bee-keeping, it seemed almost a crime to do anything not orthodox. But experiences vary and opinions differ with bee-keepers as with doctors.

Another point in favour of the fourteen or fifteen frame hive, with frames parallel with entrance, is we seldom winter the bees on more than eight frames; if these are placed at the back of hive, with the contracting or dummy board raised $\frac{1}{2}$ in., or with a hole bored in it the size of a wine-bottle cork, we then have a sort of front hall, which does away with the necessity (if any) of shading entrance when snow is on the ground. Also this front hall (backyard or ante-room) makes a first-class detention-chamber, and has all the advantages claimed for the "claustral" hive in a better form and without extra cost!

Driven Bees (7416, page 116).—It is quite easy to build up August driven bees

so that they will give off strong swarms by the following June. Yes, with 2-lb. to 3-lb. single lots too. If "swarm controlled" they will store three times or four times the surplus of the strongest June swarm. I take it the "bee-season" extends from the finish of surplus-storing—say August 10, 1908, to August 10, 1909. The actual out-of-pocket cost of single lots of driven bees, including feeding, is seldom over 7s. 6d., and if you "take them up" yourself the actual cost may be 3s. to 4s. only. Of course, I am only giving my own experience.—A. HARRIS, Wavendon, North Bucks.

[We must differ from our correspondent respecting his statement that painted calico is the worst covering for roofs, for if good unbleached calico is used, the roof made of seasoned wood and painted, the calico being put on the wet paint, there is no danger of cracks, which a very long experience with such roofs has proved. With respect to the "claustral" chamber, it appears that our correspondent has not thoroughly grasped the idea, or he would see that his plan does not embody the principal feature of the "claustral" hive, which is to obtain perfect darkness, without which the object desired is not attained. Comparative experiments on the Continent have now been carried on by expert bee-keepers for three years with the "claustral" hive and other hives with devices seeking to attain the same object, and it has been conclusively proved to be far superior to any other means of detaining bees. Where bees are kept in absolute darkness, and have no means of getting where they can see light, they remain quiet, consume less honey, and come out far stronger than any other colonies.—Ed.]

DEATH OF MRS. WOODBURY.

The recent announcement of the death, at an advanced age, of Mrs. Woodbury, formerly of Exeter, recalls to bee-keepers the memory of her late husband, Mr. T. W. Woodbury, who in his day did much to stimulate and popularise bee-keeping. Prevented by delicate health from taking a prominent part in the more strenuous affairs of life, Mr. Woodbury took up bee-keeping first as an amusement and afterwards in a serious and scientific spirit. He was the inventor of the "Woodbury" hive, and a voluminous writer on the subject beloved. His weekly articles in the *Journal of Horticulture*, over the signature "A Devonshire Bee-keeper," were full of the results of careful and accurate observation. He introduced the Italian bee (*Apis ligustica*) into England in 1859, and also later the Egyptian bee, but it proved so fierce that it had to be de-

stroyed. Though in this case unsuccessful, it resulted in an important addition to our knowledge of the life-history of these bees, and made him acquainted with Charles Darwin, who, in his "Animals and Plants under Domestication," vol. 1, p. 314, speaks of him as an excellent and thoroughly trustworthy observer. One of his last works was the superintendence of the manufacture of a hive in which a swarm of *Apis dorsata* should have been introduced into England from India's distant shore, the arrival and success of which was Mr. Woodbury's dearest wish. He was in correspondence with all the leading bee-keepers in England and Scotland, and it was through his letters in the *Journal of Horticulture* that we were first induced to begin bee-keeping. Mr. Woodbury's only surviving child is the wife of the Rev. H. Fulford, Fellow of Clare College, Cambridge, and Rector of Datchworth, Herts.

WEATHER REPORT.

WESTBOURNE, SUSSEX.
March, 1909.

Rainfall, 4.10 in.	Minimum on grass,
Heaviest fall, .75 in.	7° on 3rd.
on 6th.	Frosty nights, 14.
Rain fell on 26 days.	Mean maximum, 42.6.
Above average, 1.99 in.	Mean minimum, 34.4.
Sunshine, 95.7 hours.	Mean temperature,
Brightest day, 7th,	37.5.
8 hours.	Below average, 4.4.
Sunless days, 7.	Maximum barometer,
Below average, 48.7	29.960 on 12th.
hours.	Minimum barometer,
Maximum tempera-	29.119 on 7th.
ture, 54° on 29th.	
Minimum tempera-	
ture, 11° on 3rd.	

L. B. BIRKETT.

MARCH RAINFALL.

Total fall, 3.29 in.
Heaviest fall in 24 hours, .50 in. on 6th, from snow.
Rain fell on 22 days.
W. HEAD, Brilley, Herefordshire.

Queries and Replies.

[3911.] *Bee-keeping in South Australia.*—As I am anxious to know something definite regarding bee-keeping in South Australia, I should be greatly obliged for any information obtainable through the B.B.J. on bee-keeping and its prospects in that colony. Hoping you may find it convenient to make my wish known.—RUSNICUS, Hightgate, N.

REPLY.—There are many successful bee-keepers in South Australia, and bee-keeping is becoming an industry of considerable importance there; but the supply of honey at present is greater than the demand for it in the Commonwealth. The

Government, however, are endeavouring to create a market for it in Europe, although there is some difficulty in doing this owing to the flavour of the honey being too strong for the European palate. There is an enterprising bee-keepers' association in South Australia which has supplied the honey, and the Government has provided the funds for preparing and distributing samples. The Commercial Agent for the Colony has stated that one London firm had a standing order with the South Australian Bee-keepers' Association for seven tons of honey a month. You will find a report on the introduction of Australian honey into European markets by Mr. Beuhne, president of the Victorian Apianists' Association, in the *Record* for March and April, which may be useful to you.

[3912.] *Disinfecting Combs with Formalin.*—I should be much obliged if you would get me out of this difficulty. I see in the "Irish Bee Guide" that in using formalin for fumigating combs it says so much "solution in the box over the lamp"; then, again, I see in a catalogue "tablets to burn in box over lamp." I have a box about 9 cubic feet inside measurement, and thought of fitting it up to take standard and shallow frames, and should like to know how it is worked, with tablets or solution, and where to purchase same.—ROSA, near Kidderminster.

REPLY.—We presume your object is to disinfect combs affected with the germs of foul brood. We therefore recommend you to destroy such combs and not attempt to fumigate them with a view to their future use. There was a good deal of discussion in 1903 as to the value of formalin for the destruction of the germs of foul brood. Although a few bee-keepers who had subjected combs of honey and brood to the fumes of the gas in a tight box reported it a success, others found that combs treated in this way would communicate the disease the same as before. There has been considerable progress in our knowledge of disinfectants since 1903, and as this process was found unreliable it was given up some years ago. Experiments were made at the laboratory of the Department of Agriculture, Washington, by heating formalin in a closed vessel in communication with the hive in the way shown in the book alluded to, and the charging of the hive with gas was repeated at the end of two, four, six, and twenty hours. After twenty-four hours, in 90 per cent. of the cultures made *Bacillus alvei* was present, showing that fumigation in this way was useless. By using Novy's anaerobic jar (a very tight chamber) in which to put the diseased brood-combs, and subjecting them to fumigation under constant pressure for forty-eight hours, disinfection was obtained; but this method is of no practical use in the apiary, and any other would not be complete enough to make disinfection by fumigation sure. On the other hand, a 10 per cent. solution of formalin, in conjunction with naphthalene constantly present, and evaporating in the hive has been found useful in preventing the germs of foul brood vegetating, and in this way in time effecting a cure of the disease.

[3913.] *Covering for Hive-roofs.*—1. Will you kindly say in "Queries and Replies" what proportion of gold size and oil should be used for sizing calico to hive-roofs, as recommended by Mr. Crawshaw in "Cappings of Comb," March 4, page 88 of the B.B.J.? 2. Also, what oil should be used, linseed or boiled oil? 3. How much of the mixture would be required to dress the roofs of three hives? Thanking you in anticipation.—JIC, Wimborne.

REPLY.—1. Half and half. Note that this is a "filling" coat, to give the calico a good surface which will not rob the first coat of paint. The "sizing" is a separate process, and is really a gluing of the calico to the wood. Extensive trial makes it doubtful whether this gluing is really

as good as the old method of painting. It makes a neat and expeditious attachment, but is liable to soften at the edges unless thoroughly well painted over. 2. Boiled oil. 3. Probably a pint.—[L. S. C.]

[3914.] *Transferring Bees.*—I bought a stock of bees through your advertisement columns in February last, and on examining them a week or two ago found that, though the bees were strong and had plenty of food, the hive was in a very bad condition. The combs were old and black, they had not been wired, and, in consequence, several had broken down. I decided to transfer the stock to a new hive, and bought an Abbott's "W.B.C.," fitted with full sheets of foundation, &c. Acting on instructions in "Guide Book," I placed the old hive containing the bees on top of the new one, but cannot get the bees to use the new entrance. I closed the entrance of the old hive, but have been obliged to open it again, and would like to know: 1. Should I close the entrance of old hive or not? 2. When should I expect the queen to be down in the brood-chamber? The bees are crowded on to seven frames, and I am giving $\frac{1}{2}$ pint of warm syrup every night. I should like to express my appreciation of the help I have obtained from the B.B.J. and "Guide Book," and hope to be successful with my bees. Apple and plum trees are plentiful near my house, and the heather comes right up to the windows on one side, and covers the side of the mountain.—H. F., Pontypool.

REPLY.—The bees in the old hive, if only on seven frames, will not use the new one until the former is too crowded for them. As you have a "W.B.C." hive, it would be better to place the old hive on the floorboard of the former, put on the outer casing, and in this way accustom the bees to using the entrance. You can, after two or three days, transfer the combs and bees, provided they are on standard frames, into the new hive, discarding the worst combs and retaining those containing brood and some stores. Make up to six frames with those containing comb foundation, put in a division-board, and place the remaining frames of foundation in space outside. As the colony grows these can be gradually added. If you wish the bees to transfer themselves, put the new hive on the floorboard in place of the old one, which is then put on the top. In this case, as your colony is not strong, reduce the old hive to five frames, placing the brood in the centre. Remove the remaining frames, and put in a division-board. Place a division-board in the centre of the new hive, and cover five of the frames with a calico quilt or American cloth. Then place the old hive on the top so that the frames are just over each other. The space at the side of upper hive must be filled in with some warm material in such a way as to prevent bees from getting through. The quilt can then be put on the top of the frames, and the bees supplied with food. In due time the brood will hatch, and as the population increases and the queen finds the upper frames occupied, she will go below. When she has done so excluder-zinc may be put between the two hives and more space given below by moving the division-board, and the upper story can be further reduced by removing any empty combs. When all the brood in upper story is hatched out the old hive can be taken away. 1. Yes; close the entrance of old hive in carrying out the above instructions. 2. Only when the hive is crowded and the queen can no longer find empty cells in old combs.

[3915.] *Granulated Honey for Bee-food.*—1. Could you kindly inform me how to prepare granulated honey for bee-food? Is it better than sugar syrup? 2. I have some combs used last season. The cells contain pollen, which seems to have mildewed. Is it safe to give them to the bees? 3. Would it be safe to carry frames of brood taken

from an overcrowded hive a distance of a quarter of a mile to strengthen a weak colony? If so, what part of the day should the operation be undertaken? Thanking you in anticipation.—C. W. J., Wilts.

REPLY.—1. Cut out the portion of comb containing the granulated honey, and put it in a vessel, which must then be placed in a sauceman containing water. Place a couple of sticks on the bottom of the sauceman to keep the inner vessel from touching it. Add a small quantity of water to the honey, place the sauceman on the fire, and keep the water at a temperature of 160 deg. until the honey has all dissolved. The wax will float on the top, and can be removed when cold. The honey will then be fit for bee-food if naphthol beta solution is added to it. 2. Combs with mildewed pollen should not be given to bees. 3. This can only be done safely when the temperature is sufficiently high, and the combs should be placed in a well-covered box to keep the brood from getting chilled by wind. The warmest part of the day should be chosen for the operation.

Notices to Correspondents.

KING'S HEATH.—Bees have evidently died of starvation, though we cannot account for their wet, dirty condition.

M. C. M. K. (Sussex).—*Comb Foundation.*—The comb foundation is quite good, and can be used in supers.

R. HENSHAW.—*Irregular Laying Queen.*—The queen is full size, with ovaries well developed and spermatheca well filled with spermatozoa, and we can only account for her laying so irregularly to her having received some injury.

C. O. M. B. (Hampshire).—*Putting on Supers.*—It is too soon to put on sections, and as you say your bees only cover eight combs, you had better wait until your hive is a little more crowded. As soon as you see new wax being placed on the edges of the upper cells will be just the right time to put on the supers.

C. C. WILLIAMS (Barnes).—From your description, and the bees sent, there is no doubt that it is a case of starvation. The crystals of sugar in the heap show that the candy was not soft enough, and that there was not sufficient moisture to dissolve the sugar. Soft candy, properly made according to the recipe in "Guide Book," page 195 (new edition), will keep for a long time, but if insufficiently boiled becomes hard and crystallises.

INQUIRER (Glasgow).—Common worker-bees.

Suspected Combs.

R. S. M. (Strabane).—Combs are badly affected with foul brood, and you have done well to destroy the combs, &c., and disinfect hive.

A CARNARVONSHIRE READER.—Comb is affected with foul brood in advanced stage. Treat as instructed in "Guide Book."

C. E. (Northfield, Birmingham).—There is no brood at all in comb. The cells contain nothing but hard, mouldy pollen.

S. S. (Berkhamstead).—1. No foul brood in comb, merely mouldy pollen in cells. 2. Quite safe to use the honey for feeding. 3. If frames of foundation, put them at outside ends of brood-chambers. 4. The hive will be quite clean for use if treated as you describe.

H. B. K. (Cheshire).—The brood is chilled and there is no foul brood.

W. V. (Hants) and A. F. B. (Bexhill-on-Sea).—We regret to say sample of comb is affected with foul brood.

* Several important letters, &c., are in type, but held over from pressure on our space.

Editorial, Notices, &c.

BRITISH BEE-KEEPERS' ASSOCIATION

CONVERSAZIONE.

(Concluded from page 143.)

Mr. Brown said he could corroborate what Mr. Herrod had said about the selection of bees for comb-honey production. He produced 2,000 or more sections per annum. He advocated the good old English bees, or perhaps he might say "Brown's bees" (laughter and applause). Another recommendation with which he was in entire agreement was always to have a young queen. He never knew in his life any great success obtained with queens over a year old in producing sections. In his fruit-growing district he always utilised the fruit-

Herrod and Mr. Brown were Napoleons in the art of producing sections, and the discussion had brought out the difficulties all had experienced, and which were the common lot of beginners at the business. Probably everyone present had been asked at one time or another to inspect some beginner's hive and say why his bees would swarm and not go into the sections. What happened to a beginner usually was that he had some worked-out or partially-built sections which he had bought from a neighbour who had given up bee-keeping in disgust; he would then put in comb-foundation which had been on the hive the previous season and was perhaps polished over pretty well, and on top of that he would not cover it up round the edges of the sections, the result being that the rack was cold and the bees would not go up into it. The bees would prob-



M. OREGGIA'S HONEY-MOONS.

blossoms for building up stocks, barring raspberries, as the latter were late in blossoming, and he endeavoured to get surplus from them. With reference to Mr. Herrod's method of cutting comb-honey out of shallow frames with a template for production of sections, he had done this when there had been a great demand for them, but he would not advise bee-keepers to do so. He had never seen a section produced in this way for exhibition. The production of sections, he contended, was the best method of disposing of honey, if one was in a good district, forty sections per hive being equal to 60 lb. of extracted honey. There was a greater demand for comb than for extracted honey, and the small loss of wax, with full sheets of foundation, would only be 1 oz. in twenty-two sections—at any rate, that had been his experience.

Mr. Silver acknowledged that both Mr.

ably be strong with an inch or two of honey at the top of the standard frame. If they did not swarm, they would go on storing in the brood-nest without starting in the section-rack, and the novice, not being able to find the reason thereof, was inclined to think that bee-keeping was all tall talk and of no use whatever. Usually, on the very first chance that offered the disappointed man would sell his hive and give the whole business up in disgust. He was inclined to the opinion that to prevent that sort of thing happening they should strike out a new line altogether. They should recommend a 3-in. shallow frame to be fitted in a shallow super on the brood-nest just when the bees were beginning to get crowded. That was not enlarging the brood-nest too much at the period before the honey-flow began; and if they made the case to hold these frames 3 in., exactly the same size as the section-

rack, then the bees could go and occupy the whole brood-nest. If the zinc were put over these, then they would fill the brood-nest right to the top much better because of the little honey put in the shallow frames above. There would then be a strong hive, strong above the brood-nest, and then these shallow frames could be lifted and the sections put on underneath. When the bees took to the sections they could be put down at the bottom. He advocated this plan as being one that would enable the bee-keeper to have a strong stock, and allow of his getting bees into the sections.

The Chairman thought they had had a valuable discussion, and the audience might take Mr. Herrod's views as sound instruction, because he was a good producer of comb-honey, and also what Mr. Brown had said was useful information which all bee-keepers might well take away with them and study. One point alluded to was the cutting out of comb-honey to put into sections. Of course he could not recommend anyone to attempt that sort of thing for the show-bench. Any judge could tell at once whether comb had been cut out in that way; he would be a very bad judge indeed if he could not. He (the Chairman) did not think it necessary after what had been said for him to dilate further on the production of comb-honey, because all the various points had been dealt with already. He had just received from Italy, from a friend now staying at Ospedaletti, in the Riviera, M. Bertrand, who took an interest in the doings of the B.B.K.A., and was also one of its honorary members, some circular sections made of glass, which he (the Chairman) wished to show to those present. M. Bertrand happened to see these in a shop in San Remo and wished to be made acquainted with the producer of the sections. Having been introduced to him, the gentleman, M. Oreggia by name, said he knew M. Bertrand by his writings. The latter asked about the sections, and obtained specimens, which he sent on to the B.B.J. office. He (the Chairman) would pass a sample round, and they would see that it presented a very attractive appearance, and was indeed a beautiful piece of workmanship. The sections were glass rings 4 in. in diameter and $1\frac{1}{8}$ in. wide, and held, he should think, about $\frac{1}{2}$ lb. of honey, but might be made to hold more if completely filled out. Six of them were placed in a frame and the interstices filled with pieces of honey-comb in order to entice the bees to work in the sections. When completed, they were covered with pellicles of white gelatine (*gelatina bianca*), and nickel-plated rings were fitted over the edges. The sections were then wrapped up in nice pieces of paper, tied with a decorated

ribbon, and placed in an ornamental tin case. M. Oreggia, the originator of these sections, calls them *luna di miele* or honey-moons (laughter). He thought this a most ingenious method of producing sections. They were smaller than English ones and did not hold so much, but of course they must be looked upon as a luxury, as they could not be produced very cheaply. He believed the price was about 2 fr. each. The honey is rather dark, but is pleasant in flavour. The one shown (page 151) was a specimen that had come by post from Italy, and reached him the previous day. There was hardly any leakage. Those sections had travelled better than a great many that were sent by rail in this country, and were a credit to the packer. He thought the members present would all desire to thank Mr. Herrod as well as the other gentlemen who had contributed to the discussion.

The Chairman then announced that Mr. Seadon was present with a hive which he was desirous of showing to the meeting.

Mr. Seadon said that the body of the hive was wedge-shaped, and therefore did not take the standard frames, but its advantage was that as the taper frames were taken out the space increased and they could be returned with less danger of crushing bees. The stand was separate and the floorboard was made reversible with an arrangement for allowing a 3-in. space underneath the frames, but shut off by means of a zinc excluder, in this way forming a non-swarming hive. There were two entrances, one on a level with the frames and the other at the bottom of the 3-in. space. The excluder arrangement was not fixed, so that for wintering this open space could be left for the débris and dead bees to fall into. The hive was adapted for working sections or for extracting purposes.

A hearty vote of thanks to the Chairman, proposed by Mr. Pugh, brought the proceedings to a close.

CAMBS B.K.A.

ANNUAL MEETING.

It was decided at the annual meeting of the Cambs and Isle of Ely Bee-keepers' Association, held on March 27 in the rooms of the C.E.Y.M.S., St. Edward's Passage, to wind up the association and start a smaller one, with a more limited radius, to take its place. There was a small deficit amounting to £2 3s. 10 $\frac{1}{2}$ d., which was made up by the members present. The chair was occupied by Mr. C. J. Mapey, and amongst those present were Dr. Sidney Wood, the Rev. W. Ellison, Messrs. G. E. Rogers (hon. secretary), F. R. Ford, R. Brown (Somersham, Hunts), W. R. Billing, J. Short, A. Sharpe, A. E. Tollemache, E. Bailey, J.

Crabtree, E. Atkinson, J. Barnes (Burwell), G. Deller, A. Waller, C. Peacock, G. H. Skevington, Fairbank, G. Gordon, M. Cole, W. J. Wisbey, A. Barber, Mrs. White (Caxton), Mrs. and Miss Rogers.

The chairman explained the position of the association, saying they had been struggling on for some years. They had some ladies and gentlemen who had been loyal to the association, but, on the other hand, they had had members who were far from loyal. They had been members for their own individual benefit, and through them they had got into some difficulty. At their last meeting he made a statement that an association of that kind could hardly continue unless they had a gentleman as secretary who was willing to devote some considerable time to the work with no profit to himself. In Mr. Rogers they had had an excellent secretary, but unfortunately he had not had good health, and he had his own business to attend to.

The secretary read a statement of accounts from May 12, 1906, to March 25, 1909. From this it appeared that subscriptions amounted to £29 17s., donation from Mammoth Show £23 13s. 6d., grant from County Council £10, other receipts bringing up the total to £72 7s. 9d. Expenditure amounted to £74 11s. 7½d., leaving a balance due to the hon. secretary of £2 3s. 10½d.

The secretary added that educational work averaged 2s. 6d. per member, and it cost the association 5s. 5d. per member to provide what he paid 2s. 6d. for.

Dr. Wood proposed that they wind up the association. He said he was sorry to move such a resolution, but he did not see any other way of getting out of the slough they were in. It seemed to him that instead of being a society for the promotion of bee-culture they had a number of members who only belonged to the association for what they could get out of it. He did not want to belong to a society of that sort, and so he proposed that they wind it up. He should be pleased to pay his share of the balance due to the secretary.

Mr. Billing seconded, and the resolution was carried.

Mr. Brown proposed that their very best thanks be given to Mr. Rogers for his services to the association as hon. secretary.

Mr. Tollemache seconded the resolution, which was carried.

Mr. Rogers returned thanks, and said what he had done had been a labour of love. The only thing he regretted was that he had not had more time to give to the work.

Mr. Ford then proposed the formation of an association for Cambridge and county within a radius of twenty miles,

to be called "The Cambridge and District Bee-keepers' Association."

Mr. Crabtree seconded, and the resolution was carried unanimously.

Mr. Mapey was elected chairman, Mr. Skevington hon. secretary, and the Rev. W. Ellison, Messrs. Billing, Brown, and Ford the committee.

On the motion of Mr. Tollemache, a hearty vote of thanks was accorded the chairman and all the officers of the old association.

SOUTH AFRICAN B.K.A.

ANNUAL MEETING.

The annual meeting of the South African Bee-keepers' Association was held on Saturday afternoon, February 20, in Cullinan's Buildings, Johannesburg, S.A. In the absence of the chairman, Mr. H. W. Gittens occupied the chair. Owing to the continued bad weather the attendance was poor.

Mr. G. S. Oettlé, the hon. secretary, announced that the membership roll had increased from 113 to 165, 45 per cent. living in the Transvaal and the remainder in the other South African colonies. Although one or two had resigned since the commencement of the year, it was not thought that many would drop out of the ranks, as interest was deepening in apiculture, and the publication of the official organ was a great step in the right direction. The Government had been pleased to grant £100 to the association for use in developing the bee-industry in the Transvaal, and negotiations were in progress as to the best means of spending the money. The association had appointed an expert in each of the large colonies of South Africa: Mr. F. Sworder, Senior Expert, for the Transvaal, Miss Sillar for the O.R.C., Mr. H. L. Attridge for Cape Colony, and Miss Ritchie for Natal. An endeavour would be made to call experts together shortly to settle final details for experts' examinations. In view of the wider responsibilities assumed by the association, it had been deemed necessary to take further steps to safeguard the worth of the certificate, and to do nothing which would diminish its value in the eyes of the bee-keeping fraternity. The most pleasant item on record in the history of the association was the success of the depôts which were opened in Johannesburg, Pretoria, Germiston, and Bloemfontein; whilst it was hoped to augment the number as need arose by opening depôts in Boksburg, Krugersdorp, Kimberley, Durban, Maritzburg, Port Elizabeth, Cape Town, and other places. One result of the opening of these depôts had been to more than treble the sale of honey since the last meeting. Prices had also come down,

and yet the committee were not satisfied that all had been done to promote the sale of honey in South Africa. A special sub-committee was now sitting to consider the question, especially as experience had shown that the depot agents' rules, as imposed by the association, were too drastic. The question of foul brood had also engaged the attention of the association. All the South African Governments were legislating against the introduction of this pest.

The financial statement showed a balance in hand of £19 10s. 10d.

It was resolved to raise the subscription from 10s. to 12s. 6d., this to include free issue of the official organ of the association.

The following patrons and officers were elected:—Patron and patroness, their Excellencies the Earl and Countess of Selborne; president, Right Hon. General Louis Botha; vice-presidents, Sir Pieter Bam, Hon. J. Rissik (Minister of Lands), Hon. F. B. Smith (Director of Agriculture), Hon. A. G. Robertson, M.L.C., and the Directors of Agriculture of the other S.A. colonies; chairman, Mr. H. B. Papenfus; vice-chairman, Mr. H. J. Raubenheimer. A strong central committee was also appointed, and Mr. Oetlé was re-elected hon. secretary and treasurer.

The meeting closed with the usual votes of thanks.—GEO. OETLÉ, Hon. Secretary.

HONEY IMPORTS.

The value of honey imported into the United Kingdom during the month of March, 1909, was £3,135.—From a return furnished to the BRITISH BEE JOURNAL by the Statistical Office, H.M. Customs.

REVIEWS.

Modern Bienenzucht. By Edgar Gerstung (Osmanstedt: E. Gerstung).—A pamphlet of fifty pages and 101 illustrations. The writer gives a description of the hives and appliances used by Pastor Gerstung, who is the well-known writer of a number of books on bee-keeping and editor of *Die Deutsche Bienenzucht in Theorie und Praxis*. We are told that the apiary consists of 120 hives. There are two bee-houses, one containing sixty and the other thirty colonies, besides several twin hives. The first chapter discusses the way to become an expert bee-keeper and how to commence bee-keeping. The chapter on establishing an apiary could have been considerably shortened with advantage, there being too many hives described, and it is more fitted for a dealer's catalogue than for an instruction book. The advice respecting work

in the apiary during the different months of the year will be found useful to many, and can be read with profit, although no doubt some of the appliances described will appear to us very crude. There is a useful chapter on preparation of honey for the market, and a price list at the end of Pastor Gerstung's specialities and books.

Kalendar Ptschelovoda. By C. K. Krasnoparoff (Viatica: *Ptschelovodstvo*. Price 40 copecks—11d.).—This is a capital little bee-keepers' almanack, brought out by the editor of the Russian bee-journal *Ptschelovodstvo*. It contains a great deal of information and full instructions for work in the apiary. There are also many tables of useful statistics for bee-keepers, and at the end we find ruled pages for notes and observations, the plan of "The British Bee-keeper's Notebook" being followed. It is illustrated, contains 109 pages, and, being only 6 in. by 4 in., is a handy little book for the pocket.

One & All Gardening, 1909. Edited by Edward Owen Greening (London: Agricultural and Horticultural Association. Price 2d.).—The fourteenth issue of this well-known gardening annual is as full of interesting matter and pleasant illustrations as its popular predecessors. The 160 pages comprise articles on the vacant land movement by the editor, on the floral beautification of London, on French gardening, and on the effect of electricity on plant life. But these up-to-date articles form only a portion of a work full of variety and interest. A first issue of 100,000 copies marks the confidence of the publishers in the public demand.

Correspondence.

The Editor does not hold himself responsible for the opinions expressed by correspondents. No notice will be taken of anonymous communications, and correspondents are requested to write on one side of the paper only, and give their real names and addresses, not necessarily for publication, but as a guarantee of good faith. Illustrations should be drawn on separate pieces of paper. We do not undertake to return rejected communications.

AMONG THE BEES.

CHECKING SWARMING.

[7434.] The subject may be considered as prematurely brought on the carpet, but I do it now in order to call the attention of bee-keepers to two means of checking this nuisance during the coming active bee-season. Some claim for the dual system, whereby two or more queens are kept in one hive, not separated by excluder-zinc, that it checks swarming. Some go so far as to assert that no swarm will issue from a hive in this condition. I feel this is a statement which has yet to be proved, and

I trust many of our bee-keepers will test the truth of it and supply us with the results of their experiments.

Another assertion, not incontrovertibly certified, is that if a queen of the current year is introduced into a stock the bees will not swarm. Some of those who are searching after some new thing might depose an old queen just before any signs of swarming become patent, introduce an early-reared queen of 1909, and keep a sharp eye on what would follow. If it can only be proved that this is anything like an infallible rule, many bee-keepers would be glad to invest in a young queen rather than let a strong stock dissipate its energies by breaking up into two or more bodies. Old queens are undoubtedly a disturbing element, and bees, at times unsuitable for the apiarist's success, proceed to depose and supersede them at a sacrifice of valuable time. Young queens are as certainly indisposed to swarm as long as they get fair play for their ovipositing powers, and their progeny are allowed scope for their comb-building and honey-storing energies. But we want to get beyond this truism, and discover, if possible, if this re-queening will be followed invariably, or nearly so, by non-swarming results.

Flour in the Apiary.—When spring's first balmy airs induce the workers bent on plying their industrious hunting for the rich ambrosial nectar or the no less indispensable "bee-bread" when supplies are scant, rig out some old superannuated skep smelling of honey and the balsamic odour of propolis. Place therein some flour, and the bees, attracted by the perfume they love, will quickly concentrate their attention on what to them is an equivalent of the staff of life. Every larva as it hatches out requires a quantity of polliniferous food, and here it is ready to hand in the most accessible form. So load after load is carried into the interior of the hive to aid rapid breeding.

Whenever bees have to be united here is a cheap, effective, and ever-ready means of making the union peaceably. A handful of flour dusted over each lot, or gently powdered from a dredger, converts them for the time to the belief that they are one and the same. One odour prevails, they are of the same colour, or, perhaps, each is so busy pulling the mote out of her own eye that she has no time or opportunity to study that in her near neighbour's. Flour as a pacifier is well known and very highly appreciated in the apiary.

That hum of ill-natured declamation so inseparably connected with a robbing boom calls the attention of the bee-keeper to the fact that predatory warfare is going on. Dust the outflying bees with

flour and watch where the dusty ladies make for. Then "clauster" that hive, or otherwise deal with it, and you may nip the robbing spirit in the bud.

If a swarm comes out unseen, shift the skep into which it is placed somewhere apart. Take a small handful of bees, sprinkle them with flour liberally, and then let them fly. Each will wing its way to the old home-nest and so solve your problem for you quite simply.

Some "Don'ts."—Don't trouble to transfer combs from box-hives or straw skeps. Place the latter above the top bars of a frame-hive during May or June, and let the bees transfer themselves down below, and so save a mess and obtain better results. Don't trust all the history of your bees and bee-keeping to a treacherous memory. Have a card on or in every hive with its life-history recorded thereon. As an alternative, keep a record-book in the house for reference. Don't neglect to kill all wasps encountered during spring. Each one seen then is a queen, and destroying her will hinder the development of some hundreds during the summer. Don't try to acquire a knowledge of the practical work of bee-keeping without a text-book. It is a light to lighten you through the dark places and lead you on the way to success. Don't be content with a text-book alone: a good bee-paper is indispensable if you are to keep well up to date in all the later knowledge of the craft. Don't have an untidy apiary. If you can't quite, in one sense, judge a man by the coat that he wears, you can judge a bee-keeper by the appearance of his bee-garden. Don't forget to order appliances in good time before the full rush of the season comes on the dealers. You get goods timely forward, you have them generally cheaper, and there is no grumbling on either side. Don't forget to pay up in reasonable time when the period has expired for your *JOURNAL* or *Record*. Don't be afraid to ask advice from contributors, but ask the reply to appear in print. Don't expect long private replies.

Mild Winters.—Ancient bee-keepers firmly believed that a mild, open winter was more inimical to the preservation of bee-life than a cold one accompanied by much snow and severe frost. The first kind encouraged bees to fly too frequently, thus wasting tissue and consuming stores. Work, including excitement and much agitation, ages bees more than the actual days, weeks, or months of their existence. Long spells of cold, even with the temperature below zero, kept them close prisoners in the hives for lengthy periods, resulting in that calm repose which tends to lengthen out bee-life. Consequently, an open winter was followed by an undue

proportion of aged, worn-out bees. If this is so—and my own past experience and observation tally with it—I fear the coming spring will show spring dwindling. Right through October, November, December, and most of January bees were on the wing on an abnormal number of days owing to the prolonged fine, open weather. So many rollicking by-plays and so many distant excursions mean a heavy drain on the store cupboard. The undue excitement, too, led to repeated predatory raids amongst the hives, and the persistent attempts to enter where they had no right to intrude led to a good deal of strife and contention, with the result that more dead were left in front of several flight-boards than I cared to see. The number of evicted dead appears to me to be small, apart from these slaughtered marauders, but I noted an extra lot of comb-cappings thrown out of several, pointing to rearrangement of stores consequent on heavy consumption. Let me sound a warning note on this head. At the earliest possible opportunity examine as to the state of stores, and if there is anything wrong, remedy it. — D. M. M., Banff.

DR. MILLER ON WAX AND "WAX CRAFT."

[7435.] I am wondering whether there may not be a radical difference between American and English beeswax as to colour. Enclosed you will find a sample of very dirty wax from a virgin comb I happened to have. I should hardly say there was any yellow in it. It is possible that it may have been lying in the sun, so as to have had a chance to bleach, but I have had pounds of wax with no more tint of yellow in it, and I don't think I ever saw any with a yellow tint unless it had been a considerable time in the care of the bees.

I am surprised to find that with nothing but wax to write about a whole book can be written, and a book so interesting as "Wax Craft." There may be here and there a bee-keeper so well informed on the subject that he will be more or less familiar with the facts presented, but he will be the very one most anxious to add to his library a work crammed with facts to be found only scattered over so much ground, and even he will find a great deal that is new. The average bee-keeper will find in the book a lot of information that he can hardly afford to be without, and which he cannot obtain so cheaply in any other way.

I would be glad to be quoted as giving the foregoing opinion.—C. C. MILLER, Marengo, Illinois.

[The sample of wax our esteemed correspondent sends is very nearly white, and much paler than any beeswax obtained in

this country without bleaching. We thank him for the wish to have his appreciation of "Wax Craft" made known, and highly value his opinion.—ED.]

"ROUGH ON RATS." NUCLEI, AND QUEEN-REARING.

[7436.] Some time ago a correspondent asked how to kill rats. I once saw highly recommended for this purpose dry concentrated lye spread over anything they are fond of, and then placed somewhere so that they can eat it. We have found "Rough on Rats," a poison that can be bought at most chemists', very effective. We had a plague of them last year, and they even ate the endives and cut down the cabbages off their stumps.

The method of poisoning was the following:—Fed for three nights on bread covered with some rancid (strong-smelling) fat. Nothing given on fourth night. On the fifth night the poison was well mixed in the fat, and then spread thickly on the bread. Plenty was given, so that the rats ate sufficient to make a sure job of it, also that they might die quickly, as one naturally wishes them to suffer as little as possible; for if they do not eat sufficient to kill them the first time they may not touch it afterwards.

Repeat the operation again in a fortnight. Be sure to keep all domestic animals and birds away from the poison. We make a practice of burning any that is not eaten at night to avoid accidents. This is also very effective in clearing away mice, and we have never yet had any smell from dead vermin.

To prevent mice from entering hives, see that the entrance is exactly $\frac{5}{16}$ in. deep and no deeper. They can gnaw a $\frac{3}{8}$ in. deep entrance so that they can get in, but a $\frac{5}{16}$ in. beats them.

"D. M. M." inquires if the spider-plant will grow in this country.—Only in the hothouse.

Letter 7223, page 387, vol. xxxvi., refers to the work got out of nuclei. On June 13 we sent away a four-frame nucleus, and later had a letter from the owner saying they had built out into a fine colony. He had taken off one super, two more were to come off, and heather still to come. This was the best result we heard of last season from nuclei sent out by us. The owner, being an expert, no doubt got more out of them than a novice would have done. The queen was an extra good one.

Notes and questions frequently occur about the size of hives. Some of our hives here are about thirty years old, the size of frame being $16\frac{1}{2}$ in. long by $9\frac{1}{2}$ in. to 10 in. deep. These hives, with the proper management of deep frames, give as good, and we are inclined to think even better results than the standard-frame hive. We

have only six hives of this style in use now, as we have had to use the standard-frame hive owing to the larger hives requiring special-sized fixtures in the way of frames, foundation, excluders, section-racks, extractors, &c. This hive, we think, is a close relative of the "Dadant" hive, which has so many advocates in France. Shallow-frame hives from the three seasons' trial of them do not give very satisfactory results in wintering. This hive, theoretically, with its open communication right through the centre, should be the best hive for wintering, but results have been so far very disappointing. The frame we use in this hive is not close-ended.

In the article on "Reviews of Foreign Bee-Journals" (page 11) M. Adrien Getaz is made to say that professional queen-breeders are not in a position to know which colonies are their best honey-producers, and on that account do not produce such good queens as the amateur can do himself. We deny this so far as we are concerned, and we maintain that as breeders we are in a better position to produce superior queens to those that most amateurs can rear, and for the following reasons:—1. Our stocks are all run for honey. 2. No virgins are raised from queens that are less than one year old, and, that being so, we know exactly what each has done in the way of wintering, building up in spring, non-swarmling impulse, and honey-production. 3. We have a far larger number of stocks to select from than any amateur, and on that account have a larger choice of queens both for virgin-rearing and drone-rearing purposes. We can further state that we are very particular about the breeding of drones, and try (with what success we cannot be certain) to get our virgins mated to only selected drones. 4. Being honey-producers, we can note the advance made in honey-producing qualities and have not to depend on outside reports.

M. Getaz's method of virgin introduction requires water, which is not always exactly to one's hand. Daub the virgin in honey and place her amongst the bees on the comb. Try to get as little honey as possible on the thorax, as it would cover up the spiracles, and carefully watch to see that the bees do not seize her after cleaning the honey from her. These methods may do in a hurry, but we prefer caging (see "Guide Book"), as there is less risk incurred.

T. incarnatum gives a dark honey here on red sandstone soil.—G. THOMAS, Pwllcrochan Rectory, Pembroke.

[Our rectory was misunderstood M. Getaz's advice, which is given to the professional bee-keeper and not to the amateur. It is the bee-keeper who runs his apiary for profit that can derive the

greatest advantage from breeding his own queens.—ED.]

BEE-KEEPING IN SOUTH AUSTRALIA.

[7437.] Under your "Queries and Replies" I notice a correspondent is asking for particulars of the bee-keeping industry in South Australia.

I am prepared to supply him with the definite information he asks for on application to my office.—A. E. M. NORTON, Commercial Agent for the Government of South Australia, 28, Bishopsgate Street Within, London, E.C.

CAPPINGS OF COMB.

BY L. S. CRAWSHAW, NORTON, MALTON.

Hive-roofs (page 107).—Now is the right time, I suppose, to make a "ground-floor" purchase of shares in linoleum companies, for there is to be a boom. We are to begin a roofing of the hive, when we arrive at the end of the "hoofing"! For all the noble army of bee-keepers will rush to cover their floors so as to roof their hives with the waste pieces—as the Chinese, so it is said, used to burn their houses to bake their pigs! So away to toe the Lino before the rush begins, and write to-day to the Delaid Linoleum Co., for there is to be no more putting off of the putting on! But, really, if everyone is going to upset my calico-eulations in this flooring fashion, I shall, one of these wet days, ignore all other wreck-mendations, and invent a new hive-top, which I shall of course call "The Waterp Roof"!

Colour and Climate (page 115).—The uncapping knife has, I think, repaid its use by eliciting another fat comb from Mr. Bullamore, and I whet its slightly turned edge with pleasure before dipping it once more into the "hot water." Much has been learned in the quarter-century since Lord Walsingham gave his address to the Yorkshire Naturalists' Union, but I venture to suggest that his arguments do not fully bear the construction put upon them by Mr. Bullamore. They appear to refer to insects of a more ephemeral nature than the hive-bee with its astonishing economy, and to the reproduction of species by individuals of distinct sex-character. As to the "Chimney Sweeper," I have, in my early lepidopterous days, chased it under a sultry sun on the Cheddar Cliffs, and could have spared much surplus heat for its benefit had I known its need! Its breeding season is in July, and if darkness enables insects to seize brief rays of sunlight it is difficult to appreciate the climatic value of its blackness, which is complete but for the tiny wing-tips of white. Climate, however, cannot be the dominant cause of coloration, and as Mr. B. flies to other causes, I venture to remind him that

I said, "Colour must be a very small factor in the struggle" (page 88)—that is, the struggle for existence—from a climatic point of view. Otherwise, Mr. B. might reasonably fall foul of my instance of the wasp, to which I would add, with equal seriousness, the leopard, which no doubt also suffers from heat in spots! Then, too, I think that Mr. B. is mistaken in coupling "cold and densely-wooded countries" (page 46), and his instance of Madagascar does not help him if he regards its jungle as lacking heat! As a Roland for his Oliver, I would confront him with a Berkshire and a Yorkshire pig, and descendant learnedly of latitude, but that I consider his instance of the descendant of Ham unfortunate, for he quite fails to note the difference between clothing and skin. Black allows the rays to penetrate where white stops them and becomes hot. Therefore white clothing protects, and is most suitable wear in the tropics. Out of the direct heat rays thin black might, no doubt, best ensure coolth, by permitting radiation. So, too, thick white fur must best conserve the animal heat. I still think that, if climate were the dominant factor, white might be more general wear, but of course white is usually conspicuous, and therefore taboo where it would excite enemies or prey. But I am willing to agree that animals have little or no direct bearing upon this insect problem, though it will not, I think, help Mr. B. to make out his case for the climatic advantages of colour, if he takes for his instances the colourings of honey-bees. Further, and quite apart from the protective advantages of clothing or fur, I should have expected the heat value to the individual to be in proportion to the resistance offered to the passage of the rays, or, in other words, I should have thought the darkest insects, through which the heat rays pass most easily, to be the least able to take advantage of them.

Bee-keeping in Japan (page 124).—If Mr. Blow still sees the B.B.J., I wish he would tell us whether the Japanese wax-moth, to which he refers, is identical with either of the two species known to us. It is hardly any wonder that colonies are "small," having so many enemies, but there must be inherent tendency, perhaps fault, in the bees themselves, for with conditions which would seem to favour continuous breeding one would expect large colonies. The expectation does not perhaps allow for the eventual effect of such seasons, but I cannot help the thought that it might pay Mr. Tomura to import a different race.

Strength of Foundation (page 126).—In these interesting tests it would seem to be important that the sheets should be of the same weight. The price per pound

does not vary greatly, and the thicker sheet would obtain an undue advantage. If the method of selection by cost were employed—which method seems to be the same—it is not clear why the value per sheet should affect so considerably the Y and Z tests. The method of heating might be improved, for it is unlikely that each sheet gets equal heat, or that this is truly registered by the thermometer. A closed box would seem essential, and if this had a glass door and lamp-derived heat, the tests would, I think, be more reliable.

Australian Honey (page 128).—This verdict of the *Australian Bee-keeper*, presumably a competent authority, does not tally with the eulogiums expressed by those interested at the recent Franco-British Congress. I have just got some Australian honey which is not very objectionable, although it has a somewhat smoky flavour and is devoid of aroma and coarsely granulated. Flavour and aroma would seem to be commonly lacking in foreign honeys, which qualities, if ever present, would seem to have been lost in transit and the bottling process.

I seldom lose an opportunity of trying imported honeys, and I must say that I am astonished that they should hold their market here. Cheapness is clearly the cause, but there is no true comparison between these honeys and our clover-honey, not to mention the heather, which those of us who go to the moors know to be the king of honeys.

Obituary.

MR. GEORGE WELLS.

We are sorry to have to record the death of Mr. George Wells, of Eccles, Aylesford, after a long and painful illness extending over a period of six years. Mr. Wells was born at Goudhurst, Kent, and was seventy-three years of age. He was looked upon as the father of bee-keepers in the surrounding neighbourhood, and it was after a round of visits extending about thirty miles that he was seized with the attack of illness which proved fatal.

Mr. Wells was a regular contributor to the B.B.J., and came prominently before bee-keepers in 1892. He was the first to demonstrate the possibility of working with two queens in a hive, as he had done successfully for two years before that time. He made his method known through the B.B.J., and, interest being created, he attended a conversazione of the B.B.K.A., when, in plain and simple language, he fully described the system to an attentive audience. He introduced what is known as the "Wells" hive, which under his management produced very good results; but as it required considerable experience and skill in handling, it could

only be advantageously used by expert bee-keepers.

Mr. Wells was a foreman brickmaker, and since his retirement he devoted the whole of his time to bee-keeping, of which he was extremely fond, and acted as expert to Messrs. Wakefield Bros., of Maidstone. He was always ready with his sound, practical advice to bee-keepers or prospective keepers of bees. We visited the apiary with the late Mr. W. B. Carr in 1893, and were very pleased with the good bee-keeping evidenced in every hive which we inspected. Mr. Wells made no

pretension to acquaintance with the scientific side of the craft, but he knew just what to do and how to do it, and his bees were kept as orderly in their behaviour as was everything else we saw. As Mr. Wells had many inquiries about his system, he published a pamphlet in 1894, "On the Two-Queen System of Bee-keeping." He was appointed for two seasons lecturer on bee-keeping by the Durham C.C. Mr. Wells leaves a widow and

eleven sons and daughters to mourn the loss of a loving husband and father. Two sons and two daughters have been for many years living in South Africa.

Much has been written lately about utilising more than one queen in a hive, but bee-keepers must always remember that it was Mr. Wells who first demonstrated the possibility of doing so.

TRADE CATALOGUE RECEIVED.

E. J. BURTT (24, Stroud Road, Gloucester).—This is a neat illustrated catalogue of twenty-four pages. Mr. Burtt, besides supplying hives and appliances, makes a speciality of sending out hives in the flat, and also supplies bee-keepers with well-seasoned boards, cut and planed by machinery to sizes ready to make up into bee-hives. Catalogue free by post.

Queries and Replies.

[3916.] *Irregular Combs.*—I shall be glad of your advice about some irregular combs. Last year, owing to my adding frames with full sheets of foundation in the centre of the brood-nest before the others were sealed over, the bees drew some of the combs out much more than others. The result is that my two hives contain irregular combs.

1. What will be the best method to follow in order to get eventually both hives with regular combs? 2. Must I substitute new foundation for these; and, if so, what about the honey and brood they already contain? 3. Can I cut off the thick portions and leave them as they are? Of course, I see now that new frames ought to be added at the

outside; but I have only kept bees two years. 4. My bees are now situated in a large garden, facing S.E., with no shade. Would a blind similar to sunblinds for houses be sufficient shade? 5. Will it check them very much if they are moved into a paddock about a mile and a half away when the white clover is in bloom? There is no clover where they now are, but the paddock is surrounded by grass fields, and I thought it might pay to move the hives bodily. Thanking you in anticipation. — BEGINNER, Somerset.

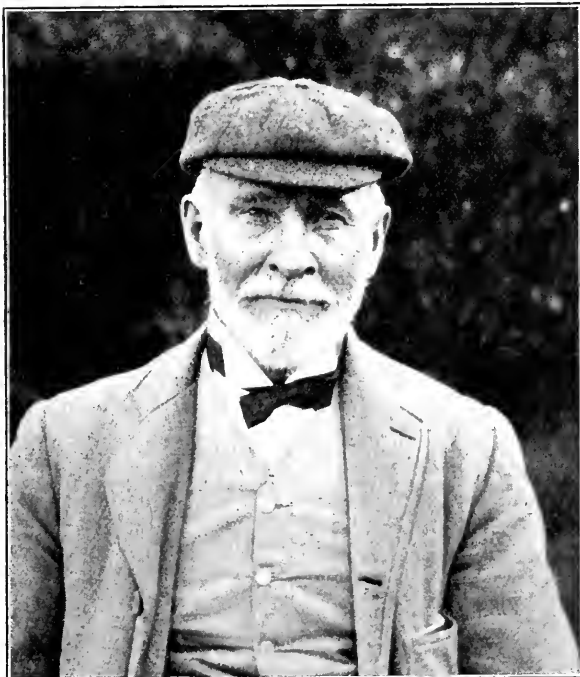

THE LATE MR. GEO. WELLS.

ing honey, your best plan will be to cut this down to the proper thickness. You must, however, only do this when bees are gathering nectar plentifully, and in a room away from the apiary, otherwise you would start robbing. 2. There is no need for this unless the above instructions cannot be carried out, in which case let us know, and we will give further instructions how to deal with the brood. 3. Yes. 4. Yes; it will do very well. 5. Bees should be moved at least two miles, or many would return to their old stand and be lost. It would only answer if there is no pasturage any nearer, and then only if clover is abundant and weather favourable for the secretion of the nectar.

[3917.] *Renewing Old Combs.*—Would you oblige by replying in the B.B.J. to the following?—1. Being desirous of replacing some of my old frames with new ones, which old ones should I remove; from the centre or sides? 2. Should I put in foundation or drawn-out combs? 3. When would the latest time be for doing the work and giving a general clean up?—BEGINNER, Salop.

REPLY.—1. Place new frames fitted with comb-foundation at the sides, and when the combs are

drawn out they can be moved to replace any comb you wish to do away with. 2. Drawn-out combs if you have them by you. 3. Any time now during a fine, warm day when there is no cold wind.

Notices to Correspondents.

REV. C. H. WHITFIELD (Newark-on-Trent).—*Bees Leaving Nucleus*.—The bees in the loft were evidently confined too long, and were suffering from a bad attack of dysentery. On their recovery the examination on April 7 probably caused the queen to be "balled," and on her being smothered she was thrown out of the hive, while the demoralised bees ran out on to the floor in search of her. Bees crawling on a dusty floor soon become covered with dust and die in consequence. Another cause may be disturbance of the bees by rats. From your description it does not seem to be a case of disease, but shows that the stock was prospering, and we can only suggest the above as probable reasons for the bees leaving the nucleus. It is not safe to keep bees in a closed loft, as they are liable to come out of the hive and crawl on the floor if there is no outlet for them straight from the hive into the open.

DUDLEY.—"Brice" *Observatory*.—1. Bees should be allowed to fly part of each day, for an hour or two, and should not be kept confined, exposed to light for four days, otherwise many will perish. 2. Yes, if it contains brood, and the queen of the hive is removed two days before the virgin queen is expected to emerge.

O. DAVIS (Gloucester).—*Disinfecting Hive*.—If you burn the hive inside and out and wash as you propose, it will be quite safe for future use. You cannot do better than treat the turf in the way you propose.

WOODBURN (ENGLAND).—*Bees Working in Glass-houses*.—1. If the houses are open and trees in full bloom, the reason that the bees do not go in is because they find plenty of pasturage outside. 2. Some put a hive inside, but in this way many bees are lost. 3. Syrup-feeding as you propose would entice them in, but it might also start robbing.

C. DEUGHTY (Darlaston).—*Transferring Bees*.—The bees will not go down into the frame-hive until the skep becomes crowded and the queen requires more room. You can leave them alone at present, and examine later by smoking the bees and lifting skep.

J. TOMLINSON (Buckley).—*Bees Building Queen-cells*.—They are either preparing to swarm or for superseding the queen. As there is drone-brood, there will be drones by the time they are wanted.

A. F. MACDUFF (London).—*Location for Bees*.—Tunbridge Wells and Crowborough are both good for bee-keeping.

Honey Samples.

C. F. MONEY (Horsham).—There is no trace of heather about the sample of honey. It is most probably from Jamaica, as it most resembles the honey from that country, which is sold extensively in this country at a very low price.

Suspected Combs.

ANXIOUS (Bedford).—Comb is affected with foul brood.

HOPEFUL (Northwood).—*Sour Brood*.—If a sour smell is noticed, in addition to the characteristics of foul brood, the same treatment should be adopted as for that disease. If the characteristics of foul brood are absent, replacing the old queen by a young one frequently stops the trouble, which sometimes also disappears during an abundant honey flow.

* Several important letters, &c., are in type, but held over from pressure on our space.

Special Prepaid Advertisements.

Twelve words and under, Sixpence; for every additional Three words or under, One Penny.

FOR SALE, 20 Stocks perfectly healthy 12-frame Hives, 19s.—STILES, BROS., Warminster. o 94

15 STRONG STOCKS BEES, in Bar-frame Hives, 17s. 6d. each.—E. DAVIS, Great Bookham, Surrey. o 93

FOR SALE, one English Queen Bee, one Hybrid, Sladen's Golden strain, both hatched late 1908, cheap; also six good secondhand "W.B.C." Hives, some new last season, very good, from 2s. to 10s., or would exchange for Bees without Queen.—H. CROWE, York House, Central-avenue, Wigston, Leicester. o 92

5 STOCKS OF BEES FOR SALE, in modern Frame Hives, all new since 1906, four cost 33s. each (three "W.B.C.'s"), with two Supers each, £5 the lot, or divide. Open to inspection. Cash or Deposit.—W. C. STONE, The Firs, Wellington, Somerset. o 91

SWARMS (NATURAL OR ARTIFICIAL).—Now booking Orders. List on application.—CHARTER, Tattingstone, Ipswich. o 91

WHAT OFFERS FOR SEVEN MODERN HIVES, FIVE GOOD STOCKS? Whole or separate.—MOULDEN, 37, Leys, Chipping Norton, Oxon. o 83

SWARMS.—Ten Wanted, May or early June (English). Will book promises of ones or twos.—Price and particulars to W. BAILEY, Newlands, The Avenue, Watford. o 87

"NEVER-SWARM" BEES, give double usual surplus, guaranteed healthy, six standard Frame Nuclei, 20s. each; booklet, "Never-Swarm System," 3d.; "Never-Swarm Hives," Detentionised, 22s. 6d.—HARRIS, Wavendon, Blechley, Bucks. o 86

READ THIS.—A complete 10-frame Hive, with Sections, Frames, and Metal Dividers, 9s. 6d.; fitted with full sheets of wired Foundation, 12s. 6d.; "W.B.C." first prize last year with two Lifts, Frames, and Sections, 15s.; fitted with full sheets Foundation, 18s.; all painted two coats; Our Feeders are a "knockout," 1s. 1d., post free. Swarms wanted; state price per lb.—THE SOUTH ERN BEE SUPPLY CO., Hellingly, Sussex. o 89

WANTED, two May Swarms of Black Bees, guaranteed healthy, with young Queen. Deposit.—Apply, MR. C. B. HEADLEY, Manor-road, Leicester. o 95

LOOK! "Little Wonder" Extractor, "Brice" Swarm Appliance, two Hives (Taylor's, at guinea and 15s. 6d.), two Racks, 1-lb. Sections, complete with Foundation, Clearer Board, with "Porter" Escape, 16 in. square Excluder, Regulated Bottle Feeder, "Webster" Fumigator, twelve Frames, built Combs, Veil, 30 lb. Honey-jars, screw caps. The lot £1, or offer.—BROWN, 34, Dour-street, Dover. o 96

WANTED, Stocks Bees on Frames and in straw Skeps.—POSTMASTER, Breachwood Green. o 97

FOR SALE, two splendid Stocks of Bees, in good Bar-framed Hives; also two Hives, with Frames and Comb, all newly painted; six Crates, with Sections; four Queen Excluders, new Smoker, £2 15s. Can be seen by appointment.—BROWN, 57, Spencer's-road, Crawley, Sussex. o 99

BEES' DELIGHT, "Chapman Honey Plant," one packet, one mother of thousands, free 6d.—LOUBET, Thameside, Weybridge. o 98

"CHAPMAN" HONEY PLANTS, 50 for 6d.; Seeds, 3d. a packet.—REEVES, 61, Hill-street, Coventry. p 5

QUEENS.—Six 1908 Natives, healthy, 5s. each.—O. KNIGHT, Epney, Stonchouse, Glos. p 4

Editorial, Notices, &c.

PROMINENT BEE-KEEPERS.

MONSIEUR ULR. GUBLER.

We have much pleasure in being able to introduce to our readers M. Gubler, the President of the Société Romande d'Apiculture.

The subject of our sketch was born in a

Grandchamp, and since 1876 he has had the direction of the orphanage at Belmont belonging to the city of Neuchâtel.

It was in 1862 that he came across Dzierzon's work, "Rationelle Bienenzucht," in a library, and could not put down the book until he had read it through. The subject interested him so much that he decided to get a hive of bees, and he found a colony in an abandoned apiary and commenced to care for it. The pro-



MONSIEUR U. GUBLER,

President of the Société Romande d'Apiculture.

small village near Frauenfeld, and studied at the normal school of Kreuzlingen, near Constance. Desiring to devote his life to the education of abandoned and unfortunate children, he passed six years of probation as under-master at the Bächtelen (school for poor and troublesome boys), near Berne. After this he was appointed director of the orphanage at

prietor, in letting him have this hive, said that the district was not a good one for keeping bees, being too near the lake, and stated that of the thirty hives which he had ten years before only this one remained. He also said that he had to feed them too much, as they did not collect enough honey to live upon. This, however, did not discourage M. Gubler,

who had acquired the bee-fever, and from day to day he became more interested in them, and after five years he found himself the owner of twenty prosperous colonies. Bee-keeping became a passion with him, and all his spare moments were passed in the apiary.

In 1888 he made the acquaintance of M. Bertrand, and soon perceived the advantage of the "Dadant" type of hive recommended by him. Careful observation carried on for ten years with ten "Dadant" and twenty "Bürki" hives proved that the former were better suited for that part of the country, the proof being obtained by careful and exact weighing. The results of these weighings, represented graphically in tables, at the end of the season, decided other bee-keepers to keep a hive on scales and register daily observations, so that now every section of the Society has its appointed observer who supplies the central station with the data for the annual report. The results of these interesting observations for the last 20 years have also been graphically depicted.

In 1890 M. Bertrand got M. Gubler to commence writing for the *Revue Internationale d'Apiculture*, and in 1903, when the state of health of the former caused him to relinquish the publishing of this journal, the Société Romande d'Apiculture decided to issue the *Bulletin*, and wisely confided the editorship to M. Gubler, who was also chosen as the president of the Society.

We have on several occasions visited M. Gubler at Belmont, and have admired his work, in which he is indefatigable. The hives are placed in all directions in the garden, which is not only full of fruit trees, but is surrounded by flourishing orchards, which supply this large establishment with fruit, while the bees furnish the honey. M. Gubler is devoted to his work and is much beloved by the inmates of the orphanage, who look upon him more as a father than a master. We trust he may live many more years to carry on his useful and beneficent work.

BRITISH BEE-KEEPERS' ASSOCIATION

The monthly meeting of the Council was held at 105, Jermyn Street, S.W., on Thursday, the 22nd inst., Mr. T. W. Cowan in the chair. There were also present Miss Gayton, Rev. H. R. N. Ellison, Messrs. R. T. Andrews, J. B. Lamb, W. F. Reid, G. H. Skevington, F. B. White, and the Secretary.

The minutes of the previous meeting were read and confirmed.

The following new members were elected, viz.:—Mr. C. J. Ashworth, Heytesbury, Wilts; Mr. W. G. Beach, 32, Pembury Road, Tonbridge; Mr. William J.

Bennison, 6, Bromley Common, Kent; Mr. J. Sydney Biss, L.D.S., The Barns, Bromham Road, Bedford; Mr. W. C. E. Brignall, Westward Ho, South Canvey, Canvey Isle, Essex; Miss L. M. Carr, 8, Henrietta Street, Covent Garden, W.C.; Mr. E. Lawrence Davis, 20, St. Peter's Green, Bedford; Mr. Henry George Gale, Dunley, near Whitechurch, Hants; Mr. Frank Nye, Oxford House, Littlehampton, Sussex; Mrs. Seadon, 23, Bromley Road, Bromley, Kent; Mr. Francis Sitwell, Yearle House, Wooler, Northumberland; Mr. S. C. Spooner, St. Nicholas-at-Wade, Birchington, Kent; Mr. Norris L. Toms, Hillview, Wood Street, Barnet; Mr. Wm. Tyrer, J.P., Rock House, Rainhill, Lancs.

The report of the Finance Committee was presented by the Rev. H. R. N. Ellison, and adopted.

An application was received from the B.D.F.A. for proposals in regard to the honey classes at the Dairy Show, but it was felt that in view of the present condition of the finances no grant could at present be made.

A committee, consisting of Messrs. T. W. Cowan, E. Garecke, J. B. Lamb, and W. F. Reid, was appointed to make a special appeal for funds to carry on the Association's work.

A letter was read from the Agricultural and Horticultural Committee of the Imperial International Exhibition *re* an educational exhibit by the B.B.K.A. After some discussion it was decided to reply that the Council thought such an exhibit might be practicable if it could be arranged without any cost to the Association for space, fitting up, or attendance.

The following four gentlemen were elected to fill vacancies on the Council, on the proposition of Mr. Cowan, seconded by Mr. Lamb:—Messrs. C. L. M. Eales, O. R. Frankenstein, Jas. Grimwood, and Arnold Richards.

The Finance Committee were appointed to consist of Rev. H. R. N. Ellison, Messrs. T. Bevan, C. L. M. Eales, E. Garecke, H. Jonas, J. B. Lamb, G. H. Skevington, and E. Walker, with the chairman and vice-chairman as *ex-officio* members.

Applications for examinations in Bedfordshire, Hampshire, Somersetshire, Derbyshire, Kent, and Worcestershire were received and dealt with.

A proposal for a meeting of bee-keepers in Gloucester during the "Royal" Show was approved.

Judges were nominated to officiate in the honey classes at the Grocers' Exhibition in September.

It was resolved to hold an examination for second-class expert certificates on November 12 and 13 next.

The next meeting of the Council will be held on Thursday, May 20.

SOMERSET B.K.A.

ANNUAL MEETING.

The annual meeting of the Somersetshire Bee-keepers' Association was held on Saturday, April 10, at the Cabot Café, Taunton. Mr. H. F. Jolly presided, and amongst those present were Miss Shepard, Mr. and Miss Weaver, Mr. and Mrs. G. Kirby, Mr. and Mrs. Eldred Walker, Messrs. J. W. Brewer, L. E. Snelgrove, W. Witheycombe, B. Boothroyd, H. J. Moore, H. Grist, W. Pritchett, Barrett, Gibbs, W. G. Kemp, W. Pierce, A. J. Parker, and S. Jordan.

The hon. secretary (Mr. L. E. Snelgrove) presented the report, which contained the following:—The committee have much pleasure in recording that the association made considerable progress during 1908. This is reflected in the balance-sheet, which shows a total cash turnover of £62 0s. 7d., as compared with £35 3s. 1½d. in the previous year. The cash balance in hand is £4, that of the last year having been £1 1s. 1d. The membership of the association shows a large increase. The new list will contain about 250 names, as compared with 170 in the previous year, an increase of over 40 per cent. A few members had dropped out, owing to their subscriptions having lapsed. It is hoped they will resume membership this year. Three new branches have been established. At Shepton Mallet Mr. H. Grist, as local hon. secretary, has organised a capital branch of nearly thirty members. Mr. B. Hutchings, as expert and local hon. secretary, has established what promises to be an even larger branch at Yeovil. At Glastonbury and Street the association has been fortunate in securing the services of a very capable expert in Mr. R. Sims. Mr. H. B. Clarke has taken up the duties of local hon. secretary, and there is every indication of a strong branch being formed. The experts examined 985 hives, of which eighty-one were diseased. Black brood was reported from two apiaries. A case of the distribution of foul brood through an auction sale of hives was reported from one district. The amount expended in expert work has been £20 15s. 5d., as compared with £11 7s. 9d. last year. Towards this amount a grant of £5 has been received from the Somerset County Council. A honey label has been issued, and some 2,700 sold. Reports of the honey season in different parts of the county vary from "very bad" to "very good." The quality of the honey, however, was generally good. The hon. secretary concluded his report by alluding to the great loss which the bee-keeping world had sustained by the death of Mr. W. Broughton Carr. His exceptional practical ability as a bee-

keeper and as Junior Editor of the BRITISH BEE JOURNAL, coupled with his simplicity of character and kindly disposition, endeared him to all, and universal sympathy is extended both to his family and to Mr. Cowan.

Mr. Boothroyd, in moving the adoption of the report and accounts, congratulated the society upon the highly satisfactory nature of the report. The money had been wisely expended.

Mr. Brewer seconded, and the Chairman supported, the resolution, which was unanimously approved.

The council place on record its highest appreciation of the able and laborious discharge of the duties of hon. secretary by Mr. L. E. Snelgrove, B.A., and congratulate him on having obtained the first-class diploma of the British Bee-keepers' Association.

The Chairman had offered a prize honey-pot for the greatest number of points obtained at the annual show held at Taunton, and this trophy he now handed to the winner, Mr. W. Pierce.

An invitation to hold the association's exhibition on the occasion of the North-East Somerset Farmers' Club show at Brislington on the last Wednesday in August was accepted.—L. E. Snelgrove, Hon. Secretary.

WARWICKSHIRE B.K.A.

ANNUAL MEETING.

The annual meeting of the Warwickshire Bee-keepers' Association was held at the Grand Hotel, Birmingham, on Thursday, April 1, the Rev. G. Sedgwick (Vicar of Sherborne, Warwick) presiding over a fairly large attendance.

The twenty-ninth annual report, which recorded the continual progress of the association and the accession of many new members, was adopted, on the motion of the chairman, who mentioned that the membership numbered 500.

The Marquis of Hertford was elected president of the association, in succession to the late Sir P. Albert Muntz. Mr. A. H. Foster was reappointed hon. treasurer; Mr. J. Lawrence Hawkes, hon. auditor; Mr. J. Noble Bower, hon. secretary; Mr. J. F. Ingerthorp, assistant secretary; Mr. G. Franklin, expert; and Mr. E. Franklin, assistant expert.

A lecture on "Queen Rearing" was afterwards delivered by Mr. W. Herrod.—(Communicated.)

KEIGHLEY AND CRAVEN B.K.A.

ANNUAL MEETING.

On Saturday, March 20, the first annual general meeting of the above association was held, under the presidency of Mr. Ben Snowden, of Cowling.

The report and balance-sheet were adopted, and showed the association to be in a satisfactory condition, the balance in hand being £2 9s. 4d. Mr. Jas. Groves was elected president, and Mr. A. Pollard treasurer. A committee representing each district was elected, with Mr. A. Lowcock, 6, South View Terrace, Silsden, as secretary. In the discussion which followed it was decided to deliver the *Bee-keepers' Record* to each member and to arrange a series of visits to different apiaries during the summer for instruction and criticism, and during the winter months to have papers read on apiculture.—A. Lowcock, Secretary.

"ROYAL COUNTIES" SHOW.

We have been asked to call our readers' attention to the forthcoming "Royal Counties" Show, to be held at Prospect Park, Reading, from June 8 to 11. The bee and honey department will be under the management of the Berks B.K.A., and numerous classes with liberal prizes have been arranged with the object of ensuring a good display of bee-produce. The entry fees have been reduced with the same object in view. The joint hon. secretaries, Messrs. D. W. Bishop Ackerman and H. Edwards, will be pleased to send a copy of the schedule to anyone interested, if applied to at 161, King's Road, Reading.

ARE WE RESPONSIBLE FOR DAMAGE OR INJURY DONE BY OUR BEES?

By E. A. C. Lloyd, Barrister-at-Law.

The question—Are we liable or not for any injury our bees may cause to our neighbours?—is one which many a bee-keeper must have asked himself from time to time. We all know that a dog is allowed his "first bite"; but the same cannot be said of a bee's sting, although in most cases the bee gets in its first sting whether it is allowed or not. How often do we read in the pages of this journal of bees raiding in great numbers houses in the proximity of their hives, attracted there no doubt by some sweet-smelling substance, or, maybe, prompted to go there by some instinct of their wonderful minds. It very often happens on such occasions as these that some member of the household upon whom they have forced their company suffers by being stung, and it might very well happen that should the bees alight in very great numbers upon a person unaccustomed to bees the consequences might be very serious indeed.

We all know that by the Common Law of England, if we keep a thing or an animal on our land which is of a dangerous

nature, and liable to do damage if it escapes, we keep such thing or animal at our peril, and, should it escape and do damage, we should be held liable for all damage which is the natural consequence of its escape.

For instance, if I store a very large quantity of water on my land in a reservoir, and it breaks the banks and floods my neighbours' lands, I shall be held liable; whether there was negligence on my part or not does not matter, and it will not excuse me to say that I took every possible precaution to prevent its escape.

The law classifies animals into two divisions, as follow:

1. Domestic or tame (*domita* or *mansuetæ naturæ*). This class includes cattle, sheep, pigs, poultry, cats, dogs, and all other animals which by habit or training live in association with man.

2. Wild (*feræ naturæ*). This class includes not only lions, tigers, eagles, and other such animals of an undoubtedly savage nature, but also deer, foxes, hares, rabbits, all kinds of game, fishes, pigeons, reptiles, and insects.

The law assumes in the case of domestic animals that they are not of a dangerous disposition, and not liable to attack mankind, and a person is therefore, in the absence of negligence, not liable for any injury they may do, unless the person is aware, or has knowledge of any mischievous propensity.

With regard to animals in the second class, animals *feræ naturæ*, the law says there is nothing unlawful in keeping such animals, but you do so at your peril, and the law will hold you responsible, independently of negligence, if they escape and do mischief.

This, then, seems to be the position of our bees. Whether it is the ordinary nature of hived bees to sting men or cattle seems doubtful on the authorities, though it is difficult to resist the fact that they very often do so. There seems to be no authoritative English decisions as to our position with regard to damage by bees, but the broad general principle seems to be that we are liable.

There was an interesting recent decision in the Irish Courts which seems to show that if you manage your bees badly and perform your operations at the hive clumsily, or keep bees in unreasonable numbers in an unreasonable place, you will be held liable for any damage which may result. In this case the parties resided on adjacent farms. The defendant, who was a farmer and acquainted with the management of bees and horses, placed and kept upwards of twenty hives at some distance from his own stables and farmyard, but at the back of the boundary fence between the plaintiff's

yard and his own. On the occasion in question the defendant was using a "smoker" on his hive for the purpose of removing honey. There was evidence that he knew, or ought to have known, that the plaintiff was likely to be tacking his horse at this very spot, and that the horse was there, but he did not warn the plaintiff or take any other precaution on his account. Numbers of bees swarmed upon the plaintiff and his horse, with the result that the horse, being stung by the bees, dragged the plaintiff and threw him violently against a wall, causing severe injury to his spine.

The jury found that the injuries were caused by the bees having stung the plaintiff and his horse; that they were kept on the defendant's land negligently and in unreasonable numbers, at an unreasonable place, and with appreciable danger to the inhabitants of the adjoining farm; and also that the bees were to the knowledge of the defendant of a dangerous and mischievous nature, and accustomed to sting mankind and domestic animals.

The broad general principle seems to be, then, that, if the animal in question falls within that class of animals which are *fera natura*, the man who keeps them must take the responsibility of keeping them safe.

We think that it can hardly be said that bees come within that class of animals known to be harmless by nature, for, as every bee-keeper knows, there exist bees which will attack mankind or domestic animals without the slightest provocation; on the other hand, there are bees which will suffer almost any amount of handling and will behave in a very domesticated and kindly way.

Apart from doing damage or injury, our bees may become a source of nuisance, which nuisance will be subject to removal at the hands of the persons affected. A recent decision on this point was decided at the Birmingham Assizes, in which two members of the county B.K.A. were concerned. In this case the defendant's hives, ten in number, were placed against a wall common to both parties, and within 20 ft. of the plaintiff's house. It appeared from the evidence that the bees invaded the plaintiff's house in such numbers and to such an extent as to become an annoyance to the plaintiff's wife and children. The plaintiff's bees were kept in a field 200 yards away from the house. The jury found that there was a nuisance, and recommended the removal of the hives to a spot 200 yards away.

It may be noted that such injury or damage or nuisance as was complained of in these cases would not be likely to happen in the case of the average bee-keeper with his two or three hives. But

it is clear that in the case of a bee-keeper whose hives number many a very real danger or nuisance may come about, and it would be safer, both in the interests of the public and in their own, for bee-keepers who keep many hives to keep them at a reasonable distance from places likely to be frequented by persons.

Correspondence.

The Editor does not hold himself responsible for the opinions expressed by correspondents. No notice will be taken of anonymous communications, and correspondents are requested to write on one side of the paper only, and give their real names and addresses, not necessarily for publication, but as a guarantee of good faith. Illustrations should be drawn on separate pieces of paper. We do not undertake to return rejected communications.

NOTES BY THE WAY.

[7438.] April has sustained its character of sunshine and showers. Abundant blossoms now cover the fruit trees, and no doubt we shall soon hear of new honey in the fruit districts of Worcester, Devon, and Kent (the Garden of England), though in our colder parts we must wait for the sainfoin and white clover in June before we put on supers. My earliest supering in the palmy days of my bee-keeping—the early eighties, when the good old-fashioned system of farming was in vogue, and we enjoyed a cycle of good honey seasons—was May 23.

Re 7430 (page 146), I may say that I have seen bees gathering pollen from the single snowdrops—never from the double or semi-double variety. This has been on good bee-days in March, and I can also endorse Mr. Avery *re* the hazel catkins. I have watched many times, but have never found bees gathering pollen from this source. I have seen them flying around the aspen tree catkins, but the distance was too great to find out if their baskets were filled with pollen.

Spring Stimulants.—Mr. Smallwood's last par. (page 146) is worth noting, especially by novices. Do not over-stimulate in early spring if you wish for success; aim at getting the bees ready for your own particular district's honey-flow. The best advice I can give is to know your district, then work accordingly. And right here let me lay down a proven axiom: "Always feed, or see that your bees have sufficient food, in the early autumn to carry the colony over till the following May for early districts, and till June for the later ones." These well-stored combs keep the bees in good heart. Depend upon it that the wise, foreseeing little creatures extend the brood-nest in springtime according to the amount of stores they have secured in the previous season.

Readers of the B.B.J. are much in-

debted to Mr. A. Schröder (page 147) for his interesting account of a visit to Dr. Miller and for the photo giving a glimpse of the Doctor's happy, smiling face.

For the season so close upon us *now* is the time to prepare, so that, given good bee-weather in June, we may secure a "big pot of honey." Do not put off any duty that should be done *now* till a more "convenient" season. Read your "Guide Book" or your own note-book, and turn over a new page for "Notes in 1909." Jot down for future reference any item found useful this year; it may save you work and cash in another season. If in a good district, you may top the list with the biggest yield per hive. This position is often held by the bee-keeper with only a few hives, and the same remark applies to the finest quality and best-filled sections. Often in years that are past have I seen the coveted "blue ribbon" adorning the output from a small apiary of two or three hives, while the owners of twenty to 200 hives had to take lower honours.—W. WOODLEY, Beedon, Newbury.

LAW RELATING TO BEES.

[7439.] From time to time you publish letters, evidently written by thoughtful, law-abiding citizens, describing their plan of proposed apiary, and asking if they may keep bees. Believing that many dwellers in the suburbs of our great cities will yet join our ranks, may I through the columns of your widely-read journal suggest that you briefly review the laws of our land relating to bees, and so strengthen the hands of inquirers? The simple position I take up is: My neighbour keeps pigeons; I bees. My neighbour and I both stand in the same position in the eye of the law, he having tamed pigeons, I bees, both of which are wild by nature, but, being tamed, they become our property by the law of the land. Swarming time is near at hand. What is our position in following and claiming swarms? Your valued opinion on these and many other points would be welcomed by—THOS. N. HARRISON, Carrington, Nottingham.

[An article by a barrister on the subject of "Ownership of Swarms" appeared in the B.B.J., September 17, 1908, page 372. Another article from the same pen appears on page 164.—Ed.]

SENDING HONEY BY RAIL.

[7440.] It has occurred to me that my experience in selling honey may be of interest to readers of the JOURNAL. I received an offer from a St. Leonards-on-Sea tradesman to purchase honey in sections at 8s. per dozen—the carriage to be defrayed by him—and also a request to

send it consigned as "farm produce." This offer I accepted, and sent three dozen sections securely packed and consigned according to his request. Shortly afterwards I received an intimation from the consignee that the honey had arrived damaged, which was only natural, as, in consequence of being wrongly consigned as farm produce, it did not receive the careful treatment that would have been accorded it if sent as "honey." The railway companies refused to pay for damages, as they claimed the goods were wrongly consigned. The purchaser also refused to pay me the full cost, and after considerable time had elapsed, and numerous letters passed between us, I managed to obtain a sovereign from him in lieu of £1 5s. 7d.

It may be of interest to other readers to know that honey should not be consigned as farm produce to save the buyer a few pence in the carriage.—A. T. SALMON, Okehampton.

OUR YOUNGEST LADY BEE-KEEPER.

[7441.] I have pleasure in sending you a photograph of one of the youngest bee-keepers in the world, my grandchild, Ethel Grace Seadon, who is in her eighth year. She goes into the bee-tent with her father and drives the bees while he gives his lecture, and is quite as skilful as a grown-up person in managing her little pets. She is to assist her father at the Beckenham Flower Show this summer, and her presence in the bee-tent, fearlessly handling the "dangerous insects" (as some people think them), is quite an object-lesson to spectators as showing how harmless bees are when properly managed.—MRS. SEADON, Bromley, Kent.

B.B.J. AS AN ADVERTISING MEDIUM

[7442.] Please do not repeat my advertisement, as I am getting completely swarmed with letters and visitors. I think it shows an awakening in the bee-keeping industry and says much for your paper as a medium for disposing of stock. The bees are all sold, and I shall be obliged if you would mention this in your next issue, as it is impossible for me to write to all inquirers under some hours' work and postage, and I cannot afford to do that. I have inquiries from Cumberland (north), Kent (south), Wales (west), and Norfolk (east). Thanking you in anticipation.—H. F. GRIMES, New Barnet, April 24.

PORTSMOUTH AS A BEE-DISTRICT.

[7443.] I wonder if any reader of your valuable paper can help me in finding a good bee-location near Portsmouth. I have two sons in the Navy stationed at the depot there, and want to get a place

near where I can profit by previous experience in gardening, fruit-growing, poultry-rearing, pig- and bee-keeping. If anyone can inform me of the resources of Hampshire, whether there are any districts where it is absolutely useless to try to keep bees or any that are distinctly favourable, I shall be very grateful. If I cannot secure a suitable site near Portsmouth, information as to any other part of Hampshire or the adjacent counties of Dorset, Wilts, Sussex, or Surrey will be appreciated by—R. E. TOWLER, 13, Glod-daeth Crescent, Llandudno.

AMERICAN AND COLONIAL PAPERS.

EXTRACTS AND COMMENTS.

By D. M. Macdonald, Banff.

Sunstroke.—"This is a new sickness to be added to the list of diseases or enemies

scarf pin emblematic of the bee." Messrs. Pender are to try the experiment "to get rid of that objectionable flavour." What of the volatile oils by the time this process is accomplished, and what of the aroma? If the flavour is driven out, what remains? Here we would say, these three distinguishing features eliminated, nothing worth naming *honey* would be left.

Bees and Fertilisation.—"In the island of Guadeloupe great stretches of cocoa and coffee plantations form an important industry. Before the introduction of the bees, although the plants blossomed profusely, they yielded little or no fruit. Now the returns are not only regular, but they have more than doubled." This feature of apiculture should be strongly impressed on the Department of Agriculture. During a late interview with representatives of the Department Mr. Cowan gave telling testimony in favour of the



THE YOUNGEST LADY BEE-KEEPER DRIVING BEES.

of bees," says the editor of the *Australasian Bee-keeper*, "but on January 3 and 4 the heat was so excessive that several bee-keepers noticed that the behaviour of their bees was such that they displayed symptoms of sunstroke. The bees would fly to the entrance, reel over, drop on the ground, give a few kicks, and die." Owing to the abnormal heat many hatching queens were lost, and in some cases honey melted in the hives and the bees were smothered.

Improving Honey Flavour.—A writer in the same paper believes the eucalyptus flavour may be eliminated from the honey by the simple process of blowing air through it. Indeed, he states that he thus "cured" honey once presented to the Governor, and "he was so highly pleased with the improved flavour that he presented the donor with a handsome gold

good done by *Apis mellifica* in improving the fruit yield.

A Strong Force.—Mr. Mendleson, one of the thousand colony men, states in *Gleanings*: "I allow the queens free access in the supers, at first, in order to get a big force of bees for the full flow of honey, but in the subsequent extractings I confine the queens to the first story by the use of the queen-excluder." This might be practised successfully in this country, as it would largely check swarming, give a powerful force, and save a good deal of worry and work to the busy man.

A Grand Combination.—"Clover, cattle, and bees make a grand combination," says a writer in *Review*. "The more cattle the easier it is to secure a breadth of clover. The farmer has the treasure, and the bees will gather it. With different kinds of clover, by careful management,

he will be able to prolong the honey-harvest several weeks. Suppose he sows a field of alsike, one of common June clover, another of mammoth, and still another of white Dutch, the blossoming season will be extended." Here is a good idea that many farming bee-keepers might profit by.

Absorbent Covers.—Mr. W. L. Coggsall, one of America's most extensive bee-keepers, puts in a plea for the use of these, and declares against the use of sealed ones: "First, a sealed cover holds all the heat or moisture the bees give off in the hive. This moisture goes to the top or ceiling, and if it is zero cold forms ice. I have seen it an inch thick. Brother bee-keepers, try both. I don't want ice inside my hives, so I vote for absorbents." Mr. Root, in a footnote to this, declares out and out for sealed covers; but from Mr. Coggsall's experience it is certain there are two opinions on the subject. Till lately I thought the sealed cover had it all its own way in America.

Size of Bees.—Mr. York in *A.B.J.* makes a good point on this subject in adopting an interesting Continental opinion. Bees are just like men; those under size often accomplish most. Some want larger bees. This does not mean necessarily increased crops. This German has been breeding from the best, and it so happens that his best bees are *under* the average in size.

A Great Industry.—The annual average value of honey gathered in the States is \$20,000,000, of beeswax about \$2,000,000. There are over 700,000 bee-keepers, and yet the annual importation of honey amounts to about 2,500,000 lb. and of beeswax about 700,000 lb.

An Unasked Question.—A novice asked Miss Wilson quite a number of elementary questions, and after painstakingly and patiently answering them she neatly and pertinently adds the following: "Now let me answer a question you haven't asked. Yes; it will be the most profitable investment you can make to buy a *bee-book*. You will learn more in one year with it than you would in ten without it." This advice should be pondered over by some of our querists. A careful study of the "Guide Book" would lessen the labours of our Replies to Queries Editor by one-half.

Bee Shows to Come.

A nominal charge of 2s. 6d. is made for notices (not exceeding 7 lines) in this column, 10 lines charged 3s. 6d., up to 15 lines 5s., which covers cost of insertion from order till date of show. Cash should accompany orders for insertion.

June 8 to 11, at Reading (Berkshire B.K.A.)—Show of Honey in connection with the Annual Exhibition of the Royal Counties Agricultural Society. Over £30 in prizes. Schedules from

D. W. Bishop-Ackerman, Hon. Sec., Berks. B.K.A., 161, King's Road, Reading. **Entries close May 14.**

June 22 to 26, at Gloucester (Royal Agricultural Society's Show).—Bee and Honey Section under the management of the B.B.K.A. Prizes arranged in groups of counties for Associations affiliated to the B.B.K.A. Schedules from E. H. Young, Secretary, B.B.K.A., 12, Hanover Square, London. **Entries close May 31.**

Queries and Replies.

[3918.] *Utilising Driven Bees.*—I should be very grateful for advice as to the following in B.B.J. :—I intend to buy cottagers' bees about the end of April, and propose to do as follows: Drive the bees from several skeps until I have about 6 lb. Shake the mixed lot into a bag made of a veil to carry on a bicycle (chap. xxxii., "Guide Book"). Throw the bees out of the bag in front of a hive prepared as in picture (page 106) The hive to have two frames of honey, taken from a stock this spring, the remaining frames holding foundation. 1. Is that all right as far as it goes? 2. What is the best time of day to start driving? It will take, I suppose, a couple of hours, as several skeps will have to be driven. I do not want to lose all the bees on the wing; but, if not hived on the same evening, I should be afraid of their being dead of hunger or cold before I got them in. 3. Is there much danger of buying a diseased stock without knowing it? I should be on the look-out, but have never seen foul brood. 4. Is there no chance of the bees flying away when thrown in front of the hive, considering that they will not be a natural swarm, and will presumably not have full honey-sacs? 5. Should the two frames of honey be placed in the middle of, or outside, the others, and should they be partly uncapped? 6. Should I stimulate with syrup, or would the honey answer the purpose? 7. How many frames would 6 lb. of bees require to begin with, the ultimate idea being section-honey? I only started bee-keeping last year—for interest rather than profit—and made rather a hash of it, getting very few sections and losing two out of three stocks.—C. V. M., Co. Clare.

REPLY.—1. Yes. 2. Late in the afternoon, when most of the bees are at home. You can hive them as late as you like, even when it is quite dark. They will, however, take no harm if kept until next day, for driven bees fill themselves with honey before they leave the hive and carry away sufficient to last them for a couple of days. They would not die of cold if the bag were hung up in a sheltered place so that the bees could cluster. 3. Yes. Before driving the bees, when the skep is turned up, give a few puffs of smoke to send the bees down amongst the combs, then push these apart so as to get a glimpse between; you can then get some idea of the condition of the combs. The coloured illustration facing page 173 will give you an idea what foul brood looks like. This, however, will not help you to diagnose it in the earlier stages, and you would have to take the risk, unless you kept each lot separate and examined the combs minutely after the bees are out of the skep. 4. Driven bees are in a similar condition to an artificial swarm, and can be handled in the same way (see page 152). 5. Outside, and the bees will uncup the honey as they want it. 6. The honey will do the stimulation. 7. At first give them all the frames, and if you find they do not occupy them take one or two out and close up with division-board, placing the superfluous ones to one side of it.

[3919.] *Utilising Partially-filled Sections.*—I should be much obliged if you would answer the following questions through the B.B.J. :—1. I have several sections left over from last year with one side containing sealed honey, while on the other

the wax is only partly drawn out. If I put these in the super this year with the other sections, will the bees go on filling them from where they left off, or ought I to have let them clean them out last autumn? 2. We are very much troubled by earwigs on this soil, and they get into the hives. Do you think it would prevent them if I tied rags steeped in tar or petroleum round the legs? 3. In preparing a hive for a swarm, is it advisable to put brood-foundation in all the frames in the body-box?—L. M. D., Yorkshire.

REPLY.—1. Yes, but it is always better to have them cleaned off in the autumn, as honey in the comb frequently granulates if kept too long. 2. The iron shoe shown on page 168 of "Guide Book" should be used, and if the cup is filled with paraffin no insects can crawl up into the hives. 3. Put brood-foundation in all the frames.

[3920.] *Transferring Bees.*—Your reply to "H. F." has answered some of the questions I was sending to the B.B.J., but as I am quite ignorant of bee-management, I venture to ask the following questions, and also to request you to send me a copy of the "Guide Book":—My hive is an old bar-framed hive. For two years I have put section-frames on the top, and taken 50 lb. of honey each year. Last year, as the hive was rotting, I took off the zinc excluder and tried to take out one of the ten frames. It broke, and the comb also broke, so I pushed the frame back, put on the excluder, and covered the hive for the winter. I want to get the bees into a new hive. 1. Must the new hive contain ten frames filled with foundation? 2. How shall I know that the brood in the upper and older hive is hatched out? 3. Will the bees leave the upper hive; if not, how can I confine them to the lower one? 4. If they leave the upper hive, will they leave any honey in the old frames, which were full when I covered up the hive in September last? If they do, ought I to remove it at once? 5. Is there any bee-expert living near Wisbech whose apiary I could visit?—W. O. L., Wisbech.

REPLY.—1. Yes (see "Guide Book," page 149). 2. By examining the combs. 3. After the bees have been working for a few weeks in the new hive, this should be examined to ascertain if the queen has gone down and if she has commenced to lay. When you are satisfied that she has done so, you can place excluder-zinc between the two hives, and when brood in upper hive is hatched out (which will be twenty-one days from the time that the queen took to the new hive), you can substitute a super-clearer (page 58, "Guide Book") for the excluder, and all the bees will go down into the new hive during the night, and the old hive can be removed the next day. 4. Yes, you can take the honey when the bees have left. 5. You should visit the apiary of Mr. R. Brown, Somersham.

[3921.] *Dealing with Mild Foul Brood.*—Would you kindly give me your advice through the B.B.J. respecting the following?—Last summer I had a very slight form of foul brood in my apiary of twenty hives. After burning the whole contents of two hives, I searched through the other eighteen, frame after frame, using naphthol beta, and wherever I found a doubtful cell I inserted small pellets of same, re-queening several colonies from driven bees. 1. Would it be advisable where plenty of stores are in hive to uncup same at intervals so as to make them clear right out, and then follow on with medicated syrup? 2. What quantity of naphthol beta should I use per hive during spring? 3. I have eighteen crates of folded sections that were on hives last summer. Would you advise burning sections and boiling crates, &c., before using again? 4. I have also sixty shallow frames with good clean combs. What would be the best way to treat them? Thanking you in anticipation.—FARMER, Wokingham.

REPLY.—1. Yes, but it would be better if you could remove all stores and feed with medicated syrup. 2. The proper proportion is 3 grs. to 1 lb. of sugar, but you had better follow the recipe given on page 197 of "Guide Book," new edition. 3. Yes, if they have been in contact with bees in hives having foul brood. 4. There is always a certain risk in using combs from infected hives, and we would melt them down and destroy the frames.

[3922.] *Water Supply and Examining Hives.*—Will you please answer the following queries in an early issue of B.B.J., and greatly oblige?—1. The sample of comb I send is taken from a stock of bees which died during the winter. Will you please let me know if this is foul brood, or why they became extinct? 2. As regards the supply of water at this time of the year, what position should the water be in with regard to the hives? Is it all the same to have the troughs, say, 6 ft. in front of the entrance, or should they be farther afield? 3. In some of the old-fashioned hives which I have the floorboard is not removable. I do not think that they have ever been cleaned out, and there seems to be a great lot of rubbish on the floorboard. Can I, at this time of year, move all the frames for a few minutes into a temporary box and clean out the hive without chilling the brood, or is the weather still too cold? 4. As regards autumn feeding, I gave my stocks syrup as per directions in a good bee-book last autumn. On examining some of the frames, I find it has apparently crystallised. Is this correct, or should it stay in the form of syrup? A small sample of this is also enclosed in box. 5. If the sample of comb is affected with foul brood, I suppose there is no chance that the other stocks have escaped the disease. If they, too, are infected, and I have to drive the bees, putting them all in fresh hives and destroying comb, brood, &c., I take it that there is no chance of getting any honey this season. Name and address sent for reference.—PAT MURPHY, Malloy, Ireland.

REPLY.—1. Comb is affected with foul brood of old standing, and is quite mouldy. 2. Six feet will do very well. 3. You can move the frames into a temporary box at any time on a fine, warm day when there is no wind to chill the brood. The temperature should not be lower than 65 deg. Fahr. 4. Syrup, properly made, should not crystallise, but the sample enclosed is granulated honey. 5. It does not necessarily follow that because one hive has died of foul brood all the others are also affected. You can only ascertain their condition by an examination, and a spring cleaning-up will give you an opportunity of doing this.

[3923.] *Working Supers on Skep and Frame-hive.*—I am a regular reader of your valuable journal, and your "Guide Book," which usually affords all the information I require, but shall be glad of an answer to the following:—I have two colonies of bees, one in a straw skep, the other in a ten-frame hive, on which I intend to put supers and try to prevent swarming. 1. On the skep I wish to place a new skep, and I would like to know how I can do this. 2. What does the new skep require inside, and what is there to guide me as to the time it must be put on? 3. What will guide me respecting frame-hive, which is a fairly strong colony, and I wish to put on section-racks? 4. I have three racks; will they be too many to put on? I may add that I am only a beginner in bee-keeping. An answer to the above will greatly oblige.—W. LEACH, Yorkshire.

REPLY.—1. We would recommend you to transfer the bees from the skep to a frame-hive in the way recommended on page 149 of "Guide Book." If, however, you wish to work a straw cap on the top of the old skep, you will have to cut a hole in the top of the latter, and if this is dome-shaped a

board with a hole in it will have to be fitted on and made secure. The cap is then placed on the board and covered over to keep it warm. 2. Nothing. When the skep appears to be full of bees it is time to put on cap—in your district end of April or the beginning of May. 3. When you see bees adding new wax to the edges of the upper cells along the top bar of frame, it is the proper time to put on supers. 4. Put on one first, and when the bees occupy this put on a second under the first, and then a third under the second. See page 58 of "Guide Book." Be sure to keep the racks well covered and warm.

Notices to Correspondents.

J. H. (Whitley Bay).—*Phenol Solution—Transferring Bees.*—This may be of any strength, and should not be used unless made up in the proper proportions. 1. You can examine them on any fine day. 2. It depends on the strength of the colony and amount of honey coming in, usually from one to four or five days. 3. Place supers on excluder-zinc; there is a bee-space under the sections or shallow frames already provided. 4. By knowing when she was hatched and by her appearance. 5. Hybrid bees vary in colour according to the intermixture of the races. Stocks crossed with Italians show traces of yellow, and sometimes have yellow bands.

JOHN WALKER (Broughtly Ferry).—*Bees Superseding Queens.*—The queen has been lost, and that is why a queen-cell has been built. If the other hive has no queen, one should be introduced, or the colony united with one having a queen.

W. H. (Yorks).—*Re-queening Apiary.*—You can do so, but you must bear in mind that you will have very few drones produced, the queens being young ones.

W. HAMPDEN (Bowden).—*Bee-nomenclature.*—The wild bee sent is *Andrena fulva*, one of the commonest and most beautiful of the British solitary bees. This species forms burrows in the ground, at the ends of which the eggs are deposited with sufficient pollen and honey to feed the larvae.—(F. W. L. S.)

Geo. B. PAINTER (Devon).—*Insurance.*—1. The premium is 1d. per hive, minimum premium 9d. If not a member of the B.B.K.A. or any affiliated association you would have to pay a registration fee of 6d. in addition. Proposal forms can be obtained from Mr. E. H. Young, Secretary B.B.K.A., 12, Ilanover Square, London, W. Policy covers from March 25, 1909, to March 25, 1910. 2. Excluders are not generally supplied with "beginners' outfits."

NOVICE (Maidenhead).—*Moving Bees.*—1. If you refer to "Guide Book," page 120, you will see that you must not move your bees now more than 2 ft. to 3 ft. each day, not reckoning those on which bees are not flying. 2. Place new frames at the back. 3. It is immaterial which way the frames hang. 4. Wooden hives are preferable. 5. You can transfer bees into clean hives at any time during a fine, warm day.

Suspected Combs.

T. H. (near Ilminster).—Comb shows that foul brood has been in the hive for some time. The larvae are almost dried up, leaving the dry, brown scale which shows that the disease is in the spore stage.

W. G. (Wilts.).—The comb is affected with sour brood.

A LOVER OF BEES (Margate).—The comb is very old and contains only honey and pollen. Most of the honey is granulated, and there is no brood of any sort in it.

LEWELLYN (Henllan).—Comb is affected with foul brood.

Special Prepaid Advertisements.

Twelve words and under, Sixpence; for every additional Three words or under, One Penny.

TO SAVE BEE-KEEPERS THE TROUBLE OF WRITING HIM, W. WOODLEY wishes to say all his swarms for the coming season are already booked.—Beeton, Newbury. p 32

PANSIES, Show and Fancy, 25 ls.; Daisies, Double, large flowered, Red or White, 50 ls.; carriage paid.—REITH, Davnies, Countesswells, Aberdeen. p 35

FOR SALE, SMALL COMPACT FARM, 10 miles from Cambridge, consisting of house, garden, orchard, stabling, styes, barn, and paddock, altogether 2½ acres, freehold.—"C. B.," c/o BEE JOURNAL Office. p 34

STOCK OF BEES, in "W.B.C." Hive, one extra "W.B.C." Hive, with Combs (zinc roofs), straw Skep, Ripener and Strainer, "Little Wonder" Extractor, small Honey Press, Excluders, Bottle-feeders, Shallow Frames, Veil, Smoker, &c., good condition, £3 10s.—ALFRED BAILEY, Town Top, Kirkheaton, Huddersfield. p 33

WANTED, "Bees and Bee-keeping," volume 2, by F. R. Cheshire.—Write, "F.," c/o BEE JOURNAL Office. p 31

LIGHT EXTRACTED HONEY, from own Apiary, in 28-lb. tins, 56s. cwt., carriage paid.—T. EVERETT, Soham, Cambs. p 30

FOR SALE, genuine Simmins' "Conqueror" Hive, good condition, Brood Box, to take Standard Frame, Supers fitted with Simmins' latest method of twin Frames, to take Divided Sections. Cost 50s.; will take 25s., or exchange for two early Swarms.—"ESSEX," c/o B.B.J. p 29

WANTED, Black Queen or Ripe Queen Cell, for Re-queening.—BURDEN, S. Farnboro'. p 28

100 STANDARD BROOD COMBS, worked 1908, wired, 8d. each.—CHARTER, Tattingstone, Ipswich. p 27

GOOD ROBUST FURZE PLANTS, for shelter, good for early Pollen, 1 ft.-2 ft. high, 6d. per dozen, 2s. 6d. per 100.—LEA, Var Trees, Dorchester. p 26

GUINEA EXTRACTOR, unused, slightly soiled, 15s. 6d.—BRICE'S APIARIES, Brigstock-road, Thornton Heath. p 25

BRICE'S QUEENS, for May delivery, limited number, sent with full instructions, 5s. 6d.—BRICE'S APIARIES, Brigstock-road, Thornton Heath. p 21

LIMNANTHES DOUGLASII, strong seedlings, 50 ls.—MISS F. B. MERCER, Sidmouth, Devon. p 24

HONEY EXTRACTOR FOR SALE, Lee's Improved "Cottage," catalogued 16s., as good as new; will take 10s., or offer.—JOSH. D. WATTS, Kildare, Lower Edmonton. p 23

FOR SALE, four healthy Stocks of Bees, in Bar-frame Hives.—Apply, MR. A. PAYNE, Low-street, Chingford. p 22

ENGLISH STOCKS, on Standard Frames, 1908 Queens, guaranteed healthy, 25s. each; cannot be beaten for Sections.—F. E. MATTHEWS, The Cofton Apiary, Northfield, Birmingham. p 20

3 CWT. DARK EXTRACTED HONEY, in 28 lb. tins, 40s. cwt., f.o.r.; sample, 3d.—HAWKES, Swaffham Prior, Cambs. p 19

4 STRONG STOCKS OF BEES, on Frames, no Hives, 15s. each.—L. W. MATTHEWS, Great Rollright, Oxon. p 17

14 REASONS WHY TILLEY'S IMPROVED PATENT "WON'T LEAK" SECTIONS SHOULD BE USED BY ALL BEE-KEEPERS, post free; sample and instructions, post paid 6d.; complete Super, with 9 2-lb. patent Sections, 4s. 6d., on rail; particulars of Tilley's registered Damp-proof Hive, painting not necessary, ready shortly. The outcome of upwards of forty years' practical Bee-keeping.—M. H. TILLEY, Bee Farm, Dorchester. p 16

Editorial, Notices, &c.

REVIEWS OF FOREIGN BEE-JOURNALS.

By "Nemo."

Comb-foundation Experiments.—It is a common saying that there is nothing new under the sun, and this saying is constantly verified with respect to so-called inventions of appliances connected with bee-keeping. In the Russian journal *Rousski Ptschelorodnoi Listok* there is a description of an invention by a M. Krutchkoff of comb-foundation with a cotton or linen base, for which it was claimed that bees would readily take to it and that it had advantages not possessed by wired frames. A. Meroschnitchenko sent for 3 lb. of this foundation, and relates his experience in *Ptschelorodnaya Sjissn*. He found in the first place that the sheets were very much thicker than the ordinary comb-foundation, so that it was not more economical in this respect. He then carried out the instructions for fixing it in the frames with great care. The foundation was stretched as tightly as possible within the frame and carefully nailed with fine tacks to the bars, and then clean molten wax was poured all round the edges on both sides. These frames were introduced into a fairly strong colony, and on examining them after two days it was found that the bees had commenced working out the cells, but had reduced them by six or seven in number in the rows, showing that the foundation was stretching. Lower down the sheets had badly bulged, just as they used to do when there was no wiring to the frames, and in many places the foundation was bitten through and the threads of cotton pulled out. One of these frames was removed and a wired frame of foundation inserted, with the result that the bees took to this at once and utilised the whole of it for brood and stores, and, abandoning the others, they began to destroy them. In order to save the colony the defective combs were ultimately removed. They do not appear to know in Russia about the experiments made in this country in 1878-9. Mr. Abbott wrote on page 217 of *B.B.J.* for March, 1879: "We have tried the introduction of sundry things in wax-guides, but have always found that where fibre existed the bees would tear it out." Mr. Raitt, who was the leading comb-foundation maker at that time, wrote in the same number of *B.B.J.*: "Cloth will not do, however. To be perfect, the sheets, after being dipped, 15 in. long, must be thick enough to stretch in rolling to 18 in. or 20 in., else the side-walls will be defective—that is one obstacle; the cloth would not stretch and

the wax would be pushed along its surface, marring the rolls in a fearful manner." He also wrote of trying samples of Japanese window-paper, thin vegetable parchment, and thin gutta-percha, all of which proved unsatisfactory. M. Dernoff, the editor of *Ptschelorodnaya Sjissn*, adds a footnote to say that he had had some foundation on paper sent him which also is objectionable on account of its thickness, and recommends wiring the frames as best in every respect. Foundation on paper was also tried in this country, and given up as unsatisfactory.

New Extractors?—Our Russian friends seem to be also groping in the dark with improvements in extractors, and, according to the same journal, are repeating the experiments made in this country more than thirty years ago. M. Unitski describes and illustrates what he calls a "new type extractor," in which the combs, instead of standing at right angles with the radii as in the ordinary machines, stand in the line of radii, and it is claimed that in this way both sides of the comb can be extracted at one operation. The cages are placed vertically on a horizontal spindle, which makes the machine very unwieldy. In the *B.B.J.* for 1874 (page 93) there is a description of such a machine, and there was another on the same principle, only horizontal, illustrated and described in *Deutsche Illustrierte Bienenzeitung* for 1887 (page 303). The objection to these machines is that to get the honey out it requires too great a velocity, which causes the combs to collapse, while the honey in the cells close to the spindle is not extracted at all. They are also larger and more complicated. After a large number of experiments this principle was given up, yet we find these extractors being introduced in these days as something new.

Foul Brood Cure.—A. Vibert describes in *L'Apiculture Nouvelle* how a client of his cures his colonies of foul brood. He places on the floorboard of the hives in which there is foul brood a receptacle containing ordinary commercial chloride of lime. By simple evaporation of this foul brood has disappeared in eight days, and he considers this a very simple and cheap method. The bees do not appear to be in the least inconvenienced by the odour of the chlorine which is given off. The remedy has been kept in the hives as a precautionary measure, and the colonies remain perfectly healthy.

Tree-planting for Bee-pasturage.—M. L. Dupuis, of Montreal (Canada), has an article in *L'Apiculture Nouvelle* on this subject. He points out that it is pollen that the bees require in the early spring for brood-rearing, and they visit for the purpose of collecting it willows, elms,

poplars, alders, aspens, and birch trees. Later there are the fruit trees and ornamental trees, such as chestnuts, acacias, and limes. He says in European countries which he has visited he noticed bee-keepers and others made a practice of planting in hedges and along the roads a large number of lime trees for ornament. The reason given for this was that the lime, which yields both pollen and nectar, blossoms in July, sometimes later, and its pollen comes in time so that bees can make their second provision, which is intended for the early brood in spring. The American lime renders the same service to bees as the European. The only difference is in the colour of the honey, the American being of a reddish colour, while the European is white with a very fine aroma. For this reason he recommends the planting of European lime trees along the Canadian roads. He also recommends the Spanish chestnut and acacia as equally valuable both for pollen and nectar, and says they should also be extensively planted.

The late Wilhelm Busche.—J. G. Beringer writes an appreciative article in the *Biennen-Fater* of Vienna on this humorous writer and illustrator, so well known to bee-keepers as the author of *Schnurrdiburr oder die Bienen*. This book was written in 1869, and there has been such a demand for it that the eleventh edition is now being sold at three marks. In 1870 the late Rev. W. C. Cotton happened to be in Cologne station waiting for a train, and employed his spare time in looking over the bookstall for something to read on his way to Aix-la-Chapelle, when this book met his eye. He did not know what *Schnurrdiburr* meant, but the second title *oder die Bienen* was intelligible and had attraction enough for him. He opened it and saw it was profusely illustrated with comical cuts. He paid his thaler and carried away his prize. The result was that he in 1872 produced "Buzz a Buzz; or, The Bees," in which the original cuts were reproduced, and the verses were written up to the pictures rather than translated from the German text. There was, however, nothing lost by it, for Mr. Cotton produced a book brimful of fun, the stories of the pig, the swarm, and the bear being particularly amusing. Probably the book is out of print now, but occasionally a copy can be obtained secondhand.

SURREY B.K.A.

ANNUAL MEETING.

There was a good attendance of members at the annual meeting of the Surrey Bee-keepers' Association, held at the County Hall, Kingston, on Saturday afternoon, April 24. Mr. William Welch, J.P., C.A., president, was in the chair, and those present included Messrs. E. B.

Jay, C.C., E. C. Morley, C.C., and R. S. Bond, C.C. (Surrey County Council representatives), A. Seth-Smith, W. F. Reid, W. Sole, W. E. Hamlin, H. Mann, F. G. Marshall, J. Kaehler, W. H. Weller, H. Letford, T. Earl, G. Hepburn, A. Dean, R. Rogers, A. T. Hedger, W. Clark, C. T. Overton, S. Moon, F. H. White, C. B. White, and F. B. White (hon. secretary and treasurer).

In moving the adoption of the report the chairman observed that, when the association held its first meeting in that room in 1894, they had about 150 members. Since then they had gone on prosperously both as regards numbers and finances, and their members now numbered 614. He urged on all to do their utmost to bring new members into the association. He knew things had not been very rosy the last twelve months, and some people might have decided to give up keeping bees. They must hope things would improve, and make every effort to get all bee-keepers to belong to what was a very useful society. The fact that 3,232 stocks were examined last year was sufficient indication that their experts were kept busy in looking round the hives and stocks of the members. In regard to foul brood, he remarked that the number of cases—ninety—was not nearly so large as in some previous years.

Mr. White, interposing, said they were 12 to 15 per cent. the first two years of the association, but they had reduced them to less than 3½ per cent.

Continuing, Mr. Welch paid a tribute to the work of Mr. White, and, referring to the balance-sheet, expressed the opinion that it was very satisfactory. He alluded to the publication in the *Surrey Advertiser* of a report of a new bee-disease, and said an opportunity for discussion would be given at the close of the general business.

Mr. Jay seconded the adoption of the report, which was carried unanimously.

Mr. Seth-Smith moved a vote of thanks to the Surrey Education Committee for the grant of £150 made for the purpose of carrying out certain educational work, and for the gratuitous use of rooms for the meeting of the association. The vote of thanks was unanimously accorded, and was acknowledged by Mr. Morley, who said that the Education Committee and the County Council were in most hearty sympathy with the association.

The executive council for the year were elected as follows:—Messrs. Archibald Seth-Smith, F. J. Bernau, G. B. Bisset, W. A. Dawson, C. H. J. Evershed, F. S. Fletcher, W. P. Gornal, G. C. Halahan, W. E. Hamlin, A. T. Hedger, John Kaehler, Joseph King, J. W. Lewis, A. H. Miller, W. F. Reid, W. Sole, E. J. Stevenson, E. Walker, A. Watkin,

T. H. E. Watts-Silvester, M.A., M.R.C.S., and F. B. White.

At the close of the general business, Mr. White, the hon. secretary of the association, said last year it was suggested that in the neighbourhood south of Guildford there were a great many cases of dead bees. Their expert, Mr. Overton, was instructed to spend a couple of days in the district and see what he could learn about these cases of suspected Isle of Wight disease, and reported that he found no trace of the disease in question, but that the death of the bees in the district was due to starvation and need of proper attention. Another of their experts had noticed instances of paralysis of bees, but when the honey-flow started these stocks recovered themselves. Then later he saw the letter in the *Surrey Advertiser*, and on inquiry he found that not only had the writer lost all his own bees, but that nearly all the bees in the district of Shalford, Bramley, and South Guildford had died out. The meeting ought to consider what steps should be taken to ascertain the cause, but he thought they would find that many were cases of neglect.

Mr. W. F. Reid, one of the hon. experts of the association, said it was rather difficult to say anything upon the chief point, which every bee-keeper wanted to know—viz., the remedy for that mysterious disease. That was the first thing they ought to consider. Mr. White was quite correct as to what he said about starvation, but without doubt there was a disease there which had all the symptoms of what was known abroad as "May disease," or what the Germans called "Maikrankheit." The Germans also called it "bee-mania," because the bees acted as though they did not know what they were doing. They came out of the hives, fluttered about with their wings, ran about, got on a stone or some piece of herbage, and then tried to fly, falling to the ground. As evening came on they would cluster together for warmth, and in the morning be found dead. He knew a member who lost nearly all his bees—nine or ten stocks—and in every case he had plenty of honey left in the hive, and there were no symptoms of starvation. When bees died of starvation they would generally find them with their heads in the cells, and nothing but the tails showing. They would also find round the queen a little cluster that had stuck to her to the last, and given to her the last trace of honey in their bags. They might be sure when the bees died of starvation they would find a large number of dead bodies. The instinct of the bee always caused it to leave the hive if it was going to die from old age or of any disease. Therefore if affected they would go outside to

die, so if bee-keepers found all the bees had disappeared it was rather a serious matter. As regarded the disease itself, the bee-paralysis, or May illness, was thoroughly well known on the Continent, where they suffered from it a great deal more than bee-keepers in this country. He did not think they need be afraid so long as it did not occur as an epidemic, as in the Isle of Wight. If it did so occur, then they would be in the same position as the bee-keepers on the island. They would lose their bees. But he suggested one thing. Many of these diseases cured themselves. There was no possibility of eliminating that disease or foul brood in their district unless they could protect themselves against the surrounding counties where bee-keepers were so very negligent.

Mr. Hedger having mentioned the loss of several stocks, both by himself and others, Mr. Overton said he did not think there was any new disease in the country, and people would not lose their bees if they gave them proper attention. He confirmed Mr. White's remarks as to the necessity of keeping the bees warm, and said they became lifeless at a temperature below 45 deg., and might then starve, even though there was plenty of food in the hive.

Mr. White said the experts, acting under instructions, would bring to him particulars where they found symptoms of any sort of disease. The members could rest assured that the council would do everything in their power, and take active measures to investigate the matter and advise the bee-keepers accordingly.

After several other members had spoken, the discussion was brought to a close. The meeting concluded with a vote of thanks to the chairman for presiding.—F. B. WHITE, Hon. Secretary.

Correspondence.

The Editor does not hold himself responsible for the opinions expressed by correspondents. No notice will be taken of anonymous communications, and correspondents are requested to write on one side of the paper only, and give their real names and addresses, not necessarily for publication, but as a guarantee of good faith. Illustrations should be drawn on separate pieces of paper. We do not undertake to return rejected communications.

AMONG THE BEES.

FILLING EMPTY HIVES.

[7444.] The problem faces us each successive season—What are we to do with our empty hives? For one reason or another out of many, these, like the poor, are always with us, and having them lying "fallow" does not tend to make bee-keeping pay. Empty

hives are uninteresting objects, and, moreover, they may prove sources of contagion, because neighbouring bees, which ought to be in quarantine owing to their hives containing the germs or spores of foul brood, are certain to find out these tempting sweets lying at hand ready for the taking, and thus a robbing boom may set in, demoralising the whole collection. For this and other reasons empty hives are a positive danger. Examine the contents of such hives, and if combs are foul or too old destroy or melt them down; if clean, fresh, and immune from disease, preserve them as a valuable asset. In either case, thoroughly cleanse and purify the hive (see Recipe No. 9, "Guide Book," page 198), and then close the entrance thoroughly against marauders.

Now for some half-dozen different ways of filling these empty hives in order that each may become a valuable asset during the current or following year. For Northern bee-men by far the best and most profitable investment is an early swarm of bees from the South, weighing from 4 lb. to 5 lb., and costing anything from 15s. to 20s., carriage and whole outlay inclusive. From an extended experience I can conscientiously state that these swarms invariably pay the first season, and, in the proportion of two to one, give a handsome return to their owners in the way of surplus. Even during the miserable season of 1907 my four English swarms gave me more *surplus* than any other four hives in my collection, and two neighbours secured fifteen and thirty-two heather sections, which they sold at 1s. 6d. each.

The plan of filling empty hives with home swarms is self-obvious, and needs no description from me. But some hints as to the best system of procedure may not be amiss. In general the swarm is returned if no increase is desired, to come out most likely repeatedly, on successive fine days. This is a wasteful system, and often defeats its own ends. Better accept the swarm, hiving it on the old stand on new frames. Remove the old stock to a contiguous site, and leave the bees there to hatch out a queen from one of the ripe cells. In a week or ten days she may be fertilised and laying. Meanwhile, the frames of brood are hatching out fast and adding to her numbers. The new stock has all the flying field bees added to it as well as those which went out with the swarm. To still further strengthen them shift the original stock to the other side of this stand, thus adding largely to the previous combined forces. This process still leaves a strong lot of young and just-hatching bees, sufficient to keep them all right if they are now shifted to a new site at some distance, while the field bees join those on the old stand. If the supers have been placed above these new frames,

with this strong army of bees, with nectar abundant and the weather favourable, surplus suffers little, if any. Here we have two stocks from one. But if we have many empty hives, and are desirous of filling them, we can, immediately after hiving the swarm on the old stand, remove the parent stock to some place apart, and leave it there for about a week or ten days, until all the brood is sealed and the queen-cells are quite ripe, when we can break up the nine or ten frames into three or four nuclei, each with one or more of the queen-cells just ready to hatch. With a good season, if the swarm has come off at an early date, each of these may be strengthened so that it is quite able to winter safely. With these recently-swarmed combs of brood hatching out daily a sufficient number of young bees will be found in each of these little lots, especially as the brood is all sealed, to keep them going. But to err on the safe side, the entrance can be stuffed with grass, moss, or dry leaves to keep all the bees prisoners for a day or two, when they will mark their location on issuing. Of course, if young queens, virgin or fertilised, are on hand, it expedites matters, and makes these small commonwealths more homelike, if one is given to each on its formation.

Various systems are given in the "Guide Book" (see pages 93-97) whereby increase can be made and hives filled, when desired, by forming nuclei and by nucleus swarming, and I need only refer readers to these pages, because I take it for granted that every bee-keeper worthy of the name possesses Mr. Cowan's excellent "Bee Guide," and is familiar with its contents.

The claustral system will come in conveniently in carrying out the next plan I shall describe for making increase. Presuming that you have a good spare queen, either reared by yourself, got from a friend, or purchased, go to six or seven of your strongest and most forward colonies and take out a frame from near the centre of each, and, if possible, have it a solid block of sealed brood. Place all these on a new stand in your claustrated hive, confining them of course for a couple of days. You may give them the queen at the same time, caging her, I think, for greater security, and setting her free when you open the entrance; or you may allow them that time to appreciate the fact that they are queenless, when they will accept her readily if introduced on the "direct" plan on the evening of the second day on terminating their claustration. Without a claustral hive a somewhat analogous plan may be followed. Shake a few bees from a frame taken from each of your strongest hives. Place them in a box covered with wire cloth in a dark

place for twenty-four hours. The plaintive sound they make shows they realise their queenless state, when you can easily and safely let a queen run in at some hole previously arranged for the purpose. At dusk secure the six or seven frames from as many hives, as recommended above, but without bees. Place these brood-frames in your removed hive, run in your bees from the box in which they have been confined, and everything will proceed as if they were an old-established stock.

Hives lying empty at the end of the season, or hives made empty by the junction of nuclei or the autumn uniting of weaklings, may be profitably filled with driven bees, as I and several other writers have lately fully described, so I need not reiterate what has been so lately enunciated. In the North, however, this cheap and convenient way of establishing stocks from local sources for next season's gathering is almost a thing of the past. Most aspirants in apiculture now deal with bees only in frame-hives, so that not only is the sulphur-pit a thing of bygone times, but even the newer and more humane system of driving and thus saving the bees bids fair soon to be a lost art.—D. M. M., Banff.

RANDOM NOTES.

[7445.] *Shaking Energy into Bees.*—Many methods have been resorted to by American bee-keepers to induce the maximum result from their bees, but this shaking business, so much commented upon in the bee-papers lately, seems the most curious of all. That it will make a too energetic colony more energetic still most of us know by sad experience. "Up, guards, and at 'em" has been the response to the shaking, and the result a flight and vigorous chase, with memories of defeat by the shaker. Once on a memorable day in June a bold aspirant to the name of "expert" knocked loudly at the gates of a citadel guarded by some energetic amazons. The response was prompt and pointed; the result a retreat to cover with unmistakable evidence of a "stern" chase. Shake some energy into our bees: this may do no harm; but to ascribe any big result in honey-gathering after may also be, let me say, "jumping to a conclusion."

"*Hunger Swarms.*"—I saw one of these the other day. The owner wondered why the whole of the bees had left the skep with the queen, and after turning up the skep I was able to show him their empty cupboard and explain their despairing flight from home. The poor little swarm was then returned to its combs with a feeder to go at, and the bees are no doubt now a contented, happy lot.

Flight of Queens.—On a single day a short time ago I saw two queens leave their hives and return during a merry flight of young bees. On the next day, which was very fine, I found a queen on the flight-board of one of my hives in a "ball" of bees. After releasing the queen I examined this and all the other hives, but found none queenless. Can there have been two queens in this hive over winter? The queen found outside was fertile, so was the queen in the hive, which was very strong.—G. W. AVERY, Heads Nook, Carlisle.

HIVE-ROOFS.

[7446.] So much has been said lately about coverings for hive-roofs that I should like to tell you which I think is the best. I go to the wheelwright's and get all the "smudge" I want (in an old tin) for nothing, except that I give my friend a little honey from time to time. I put a fair quantity of boiled oil with it, which makes it into a good dark paint. I then buy some brown calico at 4d. per yard, which I soak in water, and then wring it out as dry as I possibly can with my hands. I then give the roof a good coat of this "smudge," put on the calico, not too tightly, and tack down round the edge of roof with tin tacks. I then press the calico on closely with my hands, and give it a coat of "smudge" and a second coat in a day or two, also an additional coat every spring. No wet will go through this, and there is no cracking. A coastguardsman told a friend of mine that all canvas painted on board ship is first made wet with water before it is painted, and I have always followed this plan since hearing of it.

I trust we may have a better harvest this year than we have had here for the past two seasons. The bees in this district have advanced very rapidly the last few days, and are getting in good order for the honey-flow.—C. REED, Third-class Expert, Wickford, Essex.

["Smudge," alluded to above, is composed of odds and ends of paint and varnish of all sorts and colours, which is collected by wheelwrights and put into a tin and sold for rough work. Having a lot of varnish in it, it is almost as sticky as glue.—ED.]

SPRING AT LAST.

[7447.] Here in the Midlands our hopes run high. Although, the season is backward, that does not appear to be the case within the hives. Where the bees were left with plenty of natural stores the population is quite up to the average where disease is absent. This is prevalent in places, I am told, and always will be so

long as bee-keepers neglect the old adage that "prevention is better than cure." "What can't be cured must be endured" seems to be the more favoured one, ignoring the couplet:

If there's a remedy, find it;
If there is not, never mind it.

In this case there is a remedy, and that appears to be *vigilance* to commence with.

As I write I hear a continuous murmur of the bees in my garden, and as I walked around my borders a few minutes ago I found the flowers alive with the busy insects. There were hundreds in every patch of arabis, in every clump of aubrietia, in each plant of forget-me-not. The narcissus blooms seemed each to possess its own bee, and the Crown Imperial lilies were being absolutely quarrelled over, more waiting to go in as soon as others came out, the hellebores being treated in much the same way, while the

dark in colour—sometimes almost black—and bitter in taste. Is this practice the result of defective observation or have other bee-keepers had a similar experience?—J. McL., Kincardine.

[In some districts lime-trees produce honey of excellent quality, but there are many places where the trees become so covered with honey-dew as to render the honey very dark, and sometimes almost as black as ink. Of course in such districts it is better to remove all surplus before the lime-trees flower.—Ed.]

BEE-KEEPING IN HOLLAND.

[7449.] I have just returned from a holiday in Holland, and whilst there I paid a visit to Mr. Hans Matthes, whom I had the pleasure of meeting at the Confectioners' Trades Exhibition held at the Agricultural Hall last year, and whose

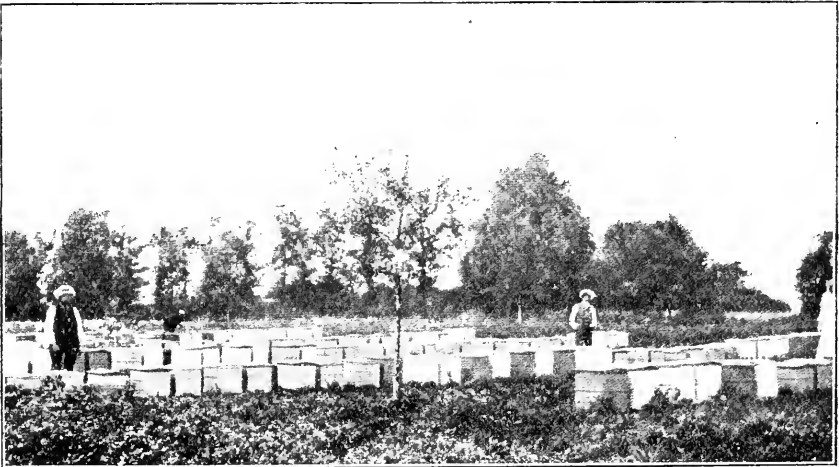

ONE OF MR. HANS MATTHES'S APIARIES, BREUKELEN, HOLLAND.

gooseberries and currants are one big hum.

Evidently there is something for the bees to do in the garden, even if the season be later than usual; and this promises well for our colonies if ready for the honey-flow.—M. S., St. Ives, Hunts.

• VALUE OF LIME-TREES.

[7448.] Having kept bees for over twenty years with great pleasure, though little pecuniary profit, I have been much surprised at the praise lavished upon the lime-tree as a honey-provider in recent issues of the BRITISH BEE JOURNAL. Curiously enough, the practice in this district has been to remove all surplus honey as soon as the lime blossoms appear, the belief being that honey from that source is only fit for winter stores, being very

stall of honey and appliances, &c., in the Netherlands department will doubtless be remembered by all bee-keepers who visited the exhibition.

Mr. Matthes lives in a charming house, artistically furnished in the old Dutch style, at the pleasant town of Breukelen, about twenty-five miles south of Amsterdam. His apiary consists of 400 colonies, wintered in long shelters, which protect the hives at the back, sides, and tops, leaving the fronts open. During the season the bees are taken first, in early summer, to the clover fields, thence to the buckwheat, and finally, in the autumn, to the heather. The last few seasons have been poor ones for honey in Holland.

Besides producing hives, honey, wax, foundation, &c., Mr. Matthes has just brought out a new preparation containing bee-products, called "Balsomena,"

which is a splendid emollient for chapped hands and rough skin. Mr. Matthes wishes me to make it known through the B.B.J. that he will be most pleased to see any of your readers who are visiting Holland.—H. G. CEILEY.

[The illustrations are from photographs given to us by Mr. Matthes when in London. One represents Mr. Matthes and his helpers in one of his apiaries and the other the straw skeps used on the heath. About May 15 Mr. Matthes goes with his colonies to Haarlem Lake, rich farm land where cabbage and mustard are cultivated for seed. About the middle of June white clover abounds in the pastures, but the main harvest is derived from buckwheat and heather, the former blooming in July and the latter from the beginning of August until the first or second week in September. The shelters mentioned by our correspondent are used in winter, and

St. Pancras, 11.30.—The collector looks at my ticket. There is a sparkle in his eye. A familiar broadening of the vowels catches my ear: "You are going to Kirkby Stephen. I come from thaar. Wish I were going to see awd folk. Shall do at holidays." Truly, homesickness is as prevalent amid the Westmorland hills as amid the Swiss mountains.

Comparatively uninteresting is the journey as far as Skipton. Then commences the ascent. Getting just a glimpse of Pendle Hill, that bold spur of the Pennine range, we reach the Ribble head, then higher and higher we mount, past gill, over beck and brig, scars, beetling hills grey with the storms of centuries, Nature's buttresses, and so on to where Eden takes its rise. Beautiful Eden, bright, sparkling, and salmon-laden, now sweeping in bold curve, brown in its pools, round some hawk-haunted cliff, now laughing over the

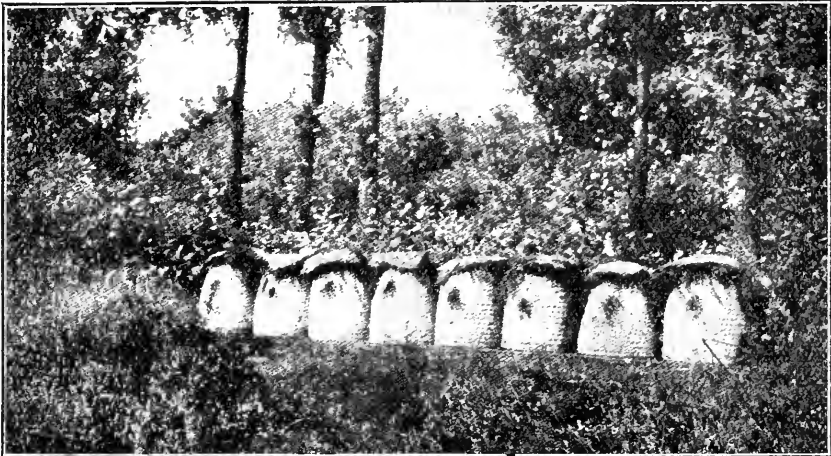

OLD-FASHIONED SKEPS ON A DUTCH HEATH.

are made so that they can be removed in parts. The photographs of the interior of the house which our correspondent encloses show that Mr. Matthes is a man of great taste.—Ed.]

MID PIKE AND FELL.

[7450.] "It is proposed to form a Bee-keepers' Association for Westmorland. Can you make the tour?" So ran the invitation from the secretary of the Cumberland Association. I am choked by the smoke of the Great City. I would get away from the noise, the endless come and go, the ceaseless turmoil. I long for the breeze blowing over the hills, for the

Land of brown heath and shaggy wood,
Land of the mountain and the flood;

for the note of the curlew, for the Bohemian life of the visitor of bee-hives.

stones, anon meandering through its rich valley, past Edenhall, where still reposes "the luck of Eden Hall"—we are now in the country sacred to Sir Walter Scott—through the dales of Armathwaite on to Carlisle, whose western wall it washes, and so to the Solway. Beautiful Eden!

I am writing more to amuse than to instruct, to relate incidents as they occur in my daily wandering which may interest our brethren. Yet sometimes I may convey a moral.

Thanks to those who had arranged my coming, work opened easily. A few of the local bee-keepers meet me in the evening, and I am able to show that it is possible to live in London and yet keep bees and know something of their ways.

My first visit is "ow'er theeer" to a man who has some local reputation. He invites me. "And where are your bees?" I ask.

"Up theer," is the reply, pointing heavenwards. On the roof are two skeps. A ladder is procured, and from this high vantage-ground I report to the terrestrials the condition of the stocks.

Over at the foot of yonder mountain, hard by that dark patch of heather, is an apiary. *En route* I persuaded a skeppist to join the association. He comes out to show me the road, but his dialect is a foreign language. I miss my way. A kindly waggoner puts me right. "O' bit thooll hev a gey clim." Picture me carrying my bicycle over two brows. It is not *all* cakes and ale. Then returning the same way, but crossing a brook,

Where ford there was none.

Yet the reward was there. I secured another member, and I slept soundly that night, as tired men do.

The bee-man in a neighbouring village strives to teach a lesson from his bees. He paints his hives to look like dwelling-houses. One is mottoed "We love our queen"; a second "Free Trade"; a third "Pure Honey"; and yet a fourth "The home of industry." Good titles, forsooth; but, alas! "We love our queen" had no queen, "Pure Honey" was empty, "The home of industry" was being robbed by its neighbours, and—worst of all—"Free Trade" was rotten—it had been wiped out by foul brood! What is there in a name?—J. SMALLWOOD.

W. B. CARR MEMORIAL FUND.

Amount already acknowledged	acknowledged	£	s.	d.
Abbott Bros.	2	2	0	
J. H.	0	1	0	
		£40	18	0

CAPPINGS OF COMB.

BY L. S. CRAWSHAW, NORTON, MALTON.

Early Pollen (page 127).—Mr. Soal, who recently gave us those admirable articles on hive-making, now flies from reason to rhyme in a poetical note on the spring. He criticises, not without reason, rime out of season, so that the spring has evidently stirred his pulses and warmed his blood. He questions "D. M. M." as to the hazel and willow blooming together, but a little latitude must be allowed in the answer, for this year, at least in this locality, they certainly did, and that in profusion. I had almost said that they blooming well did so, but feared lest the phrase should be misunderstood. The alders, too, were out with the hazel, which has, indeed, not yet quite finished blooming; and fruit-bloom is here and the sycamore just opening. By the way, does everyone know the tiny crimson, star-like flower which heralds

the hazel nut? This unobtrusive little blossom is usually unnoticed even by Bo-Peep eyes which spy the "lamb's-tails" hung out all over the bush.

Leaky Roofs (page 135).—This tip which "D. M. M." gives is worth reprinting in large type, THIS STYLE, for it is a CAPITAL idea. Small cracks may be most effectively stopped with hot candle-wax. Of course, such a cure is temporary, but there are times in the winter when a temporary cure of these rain-gutters is the only one feasible. Grafting wax would be even better, but a "guttering" candle is usually available, and the weak spot is cured in a crack! Would that we could all as easily stop our own small "capital" cracks, though it might mean taking the bread from professional menders of heads!

Bees Near Railways (page 136).—I should very much like to verify the facts of this case, and if Mr. Sunley would be pleased, I will call upon him by arrangement.

Extra-action (page 136).—There is no doubt that such an extractor is effective, but there are few bee-keepers who would care to do the work—unless they happen to be physical culturists, and would do it as a matter of course! Then they might find use for two, using them Indian-club fashion. The unfortunate factor is that honey extracts best in hot weather, when such exercise is at a discount.

Roll Call (page 145).—All stocks alive! Well done, sir! But one expects that sort of thing from a man of Mr. Woodley's experience. I have lost one stock only. It was a lot of bees driven in November, and of course they did not feed well. But I examined them too late in spring, or they might, I think, have been saved. As for the others, I have done no more than turn quilt corners and feed some light skeps. Pollen is hurrying into every doorway, so I am sure that all is well. It would be interesting to hear reports from others, for, in spite of the pessimists, the winter does not seem to have been unfavourable.

Snowdrops (page 146).—Mr. Avery may be interested to know that bees were constantly to be seen upon the single snowdrop in our garden this spring. I wish that I had noticed what they obtained. Our first snowdrop appeared on January 7, and it may be that the bees were only reassuring themselves that flowers really did exist in the outer world.

Hive-roofs (page 148).—It is quite evident that "A. H." has not tried the painted calico, or he would know that his objection is not well founded. The worst roof I possess—that is, the most hygroscopic—is that of a double hive, and as its length fluctuates, the calico follows or

wrinkles at the cross-joints, but remains perfectly sound and dry.

Checking Swarming (page 155).—It is a little difficult to obtain young queens early enough to introduce in time to stop swarming, for by the time they are fertile most hives have decided upon their programme for the year.

Polliniferous (page 155).—I wonder whether "D. M. M." really meant to use this word. I do hope that he will admit that he has been caught tripping this time! Polliniferous means pollen-bearing, and applies to the flower, but not to the pollen itself. By a stretch of scope it might include the floury skep, or the sheet into which M. Gubler would shake the catkins (page 143), and therefore the underlying pollen of the resultant heap! But this would not be polliniferous by the time the bees arrived at it. I think that "D. M. M." must use the word as one would say "splendiferous," but how would "pollenarious" meet the case?

Notes and Beams (page 155).—Surely this is a new application of the text, "D. M. M." The happily met insects beam upon their neighbours because of the mote in their eye. Yet their outlook may be reciprocal, for love begets love, as "like produces like," and, though I may be accused of treating the matter in a *light* sense, I would admit that it is usually the presence of the motes which enables us to see the beam. Probably you are right, "D. M. M.," although it is, I think, a moot point whether a bee would allow a speck to remain longer upon its antenna than upon its eye. I wonder which it cleans first. I rather fancy the antenna, although I am sure that it does not leave unbrushed for long its myriad eyelashes. For whilst bees will valet each other to the extent of brushing their clothes, they do not ever wipe each other's eyes. Can it be possible that the increased amity is due to a belief that they have just returned from a revel of pollen-gathering, and that this flowery revelation has discovered to them that they are all young again together? For it must be the younger bees, so gladly received in every hive, which occasionally get themselves all colour-coated with the radiant flower-life. Surely none but inexperienced and over-eager youngsters would get into such a mess when helping themselves to the sweets of life!

Bee Shows to Come.

June 8 to 11, at Reading (Berkshire B.K.A.).—Show of Honey in connection with the Annual Exhibition of the Royal Counties Agricultural Society. Over £30 in prizes. Schedules from D. W. Bishop-Ackerman, Hon. Sec., Berks. B.K.A., 161, King's Road, Reading. **Entries close May 14.**

June 22 to 26, at Gloucester (Royal Agricultural Society's Show).—Bee and Honey Section under the management of the B.B.K.A. Prizes arranged in groups of counties for Associations affiliated to the B.B.K.A. Schedules from E. H. Young, Secretary, B.B.K.A., 12, Hanover Square, London. **Entries close May 31.**

August 10 to 12, at Beverley.—Show of Honey, &c., in connection with the Royal Yorkshire Agricultural Society. Schedules and form of entry from John Maughan, Secretary, Blake Street, York. **Entries close July 3.**

Queries and Replies.

[3924.] *Using Partly-filled Sections*.—1. I have about twenty-five sections not properly filled left from last season, some of them not sealed over. Will the unsealed honey do any harm (it has not candied) if put back in the supers this coming season, or should I just put one or two in each rack for bait? 2. I introduced one of Penna's Italian queens to a native stock last autumn. She did well up to the final examination, and although I have not opened the hive this spring, the stock seems very strong. There are several bee-keepers in my district (which is midway between South Shields and Sunderland) who give a very poor account of Italians, as not being able to stand the winter. Will you say what you think of them as compared with hybrids for working, quietness, and hardness? 3. Will you say whether sea-air has anything to do with keeping down foul brood, as there has never been a case known in our district? Hoping for a reply through the B.B.J.—FORMIC, Sunderland.

REPLY.—1. If the honey in the unsealed cells has not fermented you can use the sections as bait to entice the bees into the supers. 2. Pure Italians are more prolific, more active, working earlier and later, and increase more rapidly than black bees. In cold districts and changeable climates these qualities are sometimes a drawback, and for such reasons these bees are frequently objected to. Pure Italians are also of a more amiable disposition and less inclined to sting. They winter as well as hybrids, the latter being excellent workers, but very vicious, and are more difficult to handle. 3. No, for it is as prevalent in some places near the coast as further inland.

[3925.] *Bees Ready for Supers*.—On looking through my hives I found the bees filling every cell in the brood-nest with honey, notwithstanding the fact that there is nothing in bloom except the palm willow and a few garden flowers. I put some 1-lb. cakes of candy on three stocks two days ago, and it is all gone, and the bees are filling the candy-boxes with comb and honey. I am afraid when the gooseberry-bloom comes out, as it will in about a week, there will be no room for the queen to lay. It states in Webster's book that when the bees begin to add new wax to the top of combs it is time to put on supers. Nearly all mine are doing this, but surely it is too soon to put on the supers. My hives are standing in forty acres of cherry-trees and about forty acres of white clover. Thanking you for any advice you can give me.—A KENT BEE-KEEPER, Egerton.

REPLY.—You should lose no time in putting on supers, as it is evident that your bees are ready for them, or they would not build comb and store honey in the candy-boxes. If there is not sufficient room for the queen to lay, remove some of the combs and extract the honey or give empty combs.

[3926.] *Telling the Age of Queen*.—1. I shall be grateful if anyone will describe how I am to tell the age of a queen, and whether she ought to be kept or replaced. I have kept bees badly for a good many years, but last year transferred

most of them into movable-frame hives. I am only just now beginning to handle them comfortably, and am quite at a loss about queens. 2. I have no use for run honey, but want as many sections as I can get. Last year a great many sections were spoilt by being joined to the tin separators; what was the cause of this?—M. E., Piccadilly, W.

REPLY.—1. A queen is getting old when her fertility begins to fail, which you can ascertain by examining the combs; but it is usual to remove queens after two seasons' work and to replace them with young ones. A note should be kept of the time when the queen was hatched, as there is no other way of determining the exact age with certainty. 2. The comb in sections is frequently joined to separators, if these are buckled and not perfectly flat; also if sections are left too long on the hive after completion, in which case the bees add wax on the face of the section and also on the tin separator. Another reason is not having the separators perfectly clean, and leaving small particles of wax on them. Comb-foundation not properly fitted, and the sections not being level, also add to the trouble.

[3927.] *Taxing Meadow in which Hives Stand.*—As there are two meadows by the side of the house I have just removed to, I propose keeping my bees in one; but a friend informs me I shall be liable to extra rate under agricultural tax. Can you say if this is so, as, should that be the case, I must place the hives in the garden?—ENTOMOLOGIST, Middlesex.

REPLY.—If a tenant or landlord lets ground, and receives rent for such a purpose, whereby the value of the field is increased, he would be liable to increase of rates.

Notices to Correspondents.

BEN-NUISS (Arran).—*Drones from Fertile Workers.*—Although anatomically they are similar in every respect to drones produced by normally fertilised queens, they are smaller, are not considered so good, and for this reason are generally avoided by breeders of queens.

LEX (Wrexham).—*Bee-nomenclature.*—The queen is an old one, and has been damaged on the thorax, there being a deep dent in it. One of the bees is a recently hatched drone and the other a worker.

R. S. F. CORNISHMAN.—*Bees not Taking Syrup.*—1. If the syrup is made correctly according to Recipe No 5, and the bees in the hive are strong and numerous, either they must be gathering nectar and do not need the food, or the feeder may be too cold and the sugar not pure. It is very unusual for bees to refuse syrup properly made, if it is warmed by the heat of the cluster of bees. 2. Transferring bees from skeps to frame-hives is fully described on page 150 of "Guide Book." 3. Prevention of swarming is described on page 21, and storifying or working two brood-chambers one above the other is explained on page 61.

EZRA BALL.—*Wax-moth.*—The comb sent is badly affected with wax-moth, and the larvae are those of the same moth. The eggs were laid in the combs before you wrapped them up and put them away (see reply to No. 3908, page 139). The brown matter in the cells is dark-coloured pollen. You will find a description and interesting particulars respecting the wax-moth on page 91 of B.B.J.

DOUBTFUL (Maidenhead).—*Pollen in Combs.*—1. The comb is dry and mouldy, and the hard pieces which the bees have turned out are pellets of pollen. 2. Although early, it is not unusual to find sealed queen-cells in strong colonies at the end of April.

C. G. (Durham).—*Feeders.*—With an inverted bottle-feeder the syrup does not drip continuously between the combs, but the bees get it through the holes in cover. A bottle-feeder is better for slow feeding at this time of the year than a float-feeder, because in cold weather the syrup is within reach of the cluster of bees and at the warmest part of the hive. With a float-feeder the bees have to leave the cluster, and if very cold, and the feeder not well covered to keep it warm, bees are not inclined to leave the warmth of their cluster to go after the food.

Suspected Combs.

A. A. M. C. (Oxon).—There are traces of foul brood recently started, and also some of the brood is chilled, so you have done right. Ten per cent. formaldehyde is what should be used. To your 40 per cent. formaldehyde add 3 parts water, which will make the solution 10 per cent. Put 1½ oz. of this solution into a tin tray, covered with wire gauze, on the floorboard of hive, and renew it every week until cured. Tin trays made to go under the lugs of frames will answer the same purpose, and can be filled by just lifting end of quilt.

Special Prepaid Advertisements.

Twelve words and under, Sixpence; for every additional Three words or under, One Penny.

MR. J. CARVER, WELLINGTON, regrets delay in delivery of "Section-glazing" Machines, which is due to manufacturers not having them ready within the time promised. All orders on hand will be filled this month.

FOR SALE, 4 strong, healthy Stocks, "W. B. C." Hives, with rack of Sections, 20s.; one in Claustral Hive, 25s.; also appliances.—MR. SHIELDS, Hildenborough, Kent. p 38

EXTRACTOR, as good as new, only used twice, geared with covers, 20s.; prime early Swarms, 15s.—W. SOLE, Expert, Stotfold, Baldock. p 36

PURE WHITE LEGHORNS, splendid layers, also Ducks, Aylesbury and Indian Runner, eggs, 12s. 6d.; Cross-bred Hens, 2s.—MISS SOLE, Stotfold, Baldock. p 37

WANTED, guaranteed strong healthy Stocks of Bees, in Skeps.—JARVIS, Coleford, Glos. p 46

FOR SALE, several Hives of Bees (property late T. S. Holdsworth).—Apply, MISS ETHEL HOLDSWORTH, Woodford House, Kirton Lindsey. p 53

WANTED, secondhand, 1 Observation Hive, 1 Trophy Stand, Show Cases for Comb Honey, all in good condition.—Particulars to C. HOLMES, Red-lane, Welshpool. p 43

YOUNG PROLIFIC NATIVE QUEEN, 4s. 6d., post free.—ALUN JONES, Wern, Rhosesmor, Flintshire. p 41

32ND YEAR.—Orders requested for Swarms and Queens, imported Italians, 7s. 6d.; British, 5s. 6d.—E. WOODHAM, Clavering, Newport, Essex. p 40

EXCHANGE LADY'S CYCLE FOR SWARMS OR STOCKS, IN SKEPS.—HERIOD, Apiary, Luton. p 42

FOR SALE, 2 strong Stocks Bees, in "W. B. C." Hives, guaranteed healthy, 25s. each.—W. J. IRVING, Galabank Apiary, North-street, Annan, N.B. p 54

STRONG TRANSPLANTED TOMATO PLANTS, Up-to-Dates and Laxton's Open Air, 1s. dozen.—F. W. GELDER, Sturton, Lincn. p 50

FINE CLOVER HONEY, in 1 lb. Screw-caps, 8s. 6d. dozen.—F. W. GELDER, Sturton, Lincn. p 51

LAD WANTED, to look for Swarms, out-apiary.—R., 91, Holland-road, Maidstone. p 47

Editorial, Notices, &c.

BRITISH BEE-KEEPERS' ASSOCIATION

We would call the attention of our readers to the appeal made by Mr. J. B. Lamb on page 183 for increase of funds of the B.B.K.A., which is necessary if the work hitherto carried on is to be continued. The demands upon the association's funds are increasing every year, and the ranks of those members passing away have to be filled, otherwise the work, instead of being extended, must be curtailed. By referring to the annual report it will be seen that the expenditure last year was greater than the income, so that the reserve fund stands in a less favourable condition than in the previous year, the excess of assets over liabilities now standing at £190 17s. 1d., as against £241 3s. 9d. a year ago. It does seem a pity that the Council, after making grants for the last thirty years, should be obliged to refuse giving prizes at such a show as that of the British Dairy Farmers' Association, which is held in London in October of each year, and which brings a good many bee-keepers to the metropolis for conference and discussion; but they do not see in what other way retrenchment can be made. The only alternative is to increase the number of subscribers. There are a great many interested in apiculture who have derived benefit directly or indirectly from the work of the association, and these should be amongst its subscribers. Without a large increase of funds it will be impossible to extend the scope of the society's operations, and it is therefore hoped that Mr. Lamb's appeal will meet with a hearty response.

"ROYAL" SHOW AT GLOUCESTER.

Though most of our readers are aware of the value of bee and honey shows from a commercial and educational standpoint, we would like to draw attention to the "Royal" Show, which is to be held at Gloucester in June, and to remind bee-keepers that entries close on May 31. The weather lately has been all that could be desired, and bees in many places are already busily at work in the supers. These facts and the good condition of the stocks, together with abundance of forage everywhere, should induce many bee-men to apply at once for schedules, and thus not only have a chance of winning a prize, but also help to promote the success of the most important bee and honey show of the year.

Schedules may be obtained of Mr. E. H. Young, Secretary B.B.K.A., 12, Hanover Square, London, W.

REVIEW.

Conduite du Rucher. By Ed. Bertrand (Geneva: R. Burkhardt. Price 2.50 fr. —2s.)—This is the tenth edition of this well-known book. Progress in bee-keeping during the last few years has been so rapid that an instruction-book becomes of little value in three or four years after it is published, if the bee-keeper wishes to keep pace with the times. Realising this, M. Bertrand has thoroughly revised this edition and brought it up to date. Amongst the alterations, we find the chapter on bee-diseases entirely rewritten in accordance with the latest researches of Dr. Maassen and others, and the modern methods of queen-rearing as practised in Switzerland have also been described. The popularity of this book is evidenced by the fact of its being translated into Italian, Russian, German, Dutch, Bulgarian, and Armenian, so that, with the exception of the "British Bee-keeper's Guide Book," it has been translated into more languages than any other work on bees. We congratulate M. Bertrand in bringing out this new edition, and can thoroughly recommend it as a reliable guide to the management of an apiary.

SUSSEX B.K.A.

ANNUAL MEETING.

Encouraging progress was reported at the annual meeting of the Sussex Beekeepers' Association, held on April 16 at the Royal Pavilion, Brighton, under the chairmanship of the Mayor of Hove, Alderman Captain A. B. S. Fraser.

The committee reported that the association had proved a success, the year 1908 having been finished with ninety-nine members and a cash account which would show a small amount to the good when all members had paid their subscriptions. Progress had not been sufficient at present to warrant their asking the County Councils for a grant towards a propaganda for the extension of the craft of bee-keeping in Sussex, but as soon as the membership list was somewhat increased it was intended to apply to them for help to enable the association to teach up-to-date methods in the practical keeping of bees and in the avoidance of the propagation of disease. It had been arranged that an exhibition of bees should be given by the association's expert, Mr. C. T. Overton, at the Tunbridge Wells and Hove shows this year. The report of the expert showed that a thorough examination and inspection of the stocks of members had been made, and much helpful information and advice given. As many as eighty-five bee-keepers were visited, representing 590 stocks, of which sixty-one were found dead

—a high rate which was common to the whole country. There were twenty-five cases of fowl brood.

The Mayor of Hove moved the adoption of the report, and congratulated the association upon the advance it had made since it was started about a year ago.

Mr. W. Edwards, the hon. secretary, briefly explained the items of the accounts, and stated that the association now numbered 119 members, and it was hoped to gain many others during the expert's visiting tour and as a result of the demonstration to be given at the Agricultural Show at Hove. The report was then adopted.

The Marquis of Abergavenny was re-elected president, and the Rev. D. L. Secretan vice-president. The committee were re-elected, with the addition of the Rev. J. J. Priestley. Mr. C. T. Overton was chosen as the association's expert, Mr. W. Edwards being re-elected hon. secretary, and heartily thanked for the valuable work he had done.

A vote of thanks to the Mayor for presiding ended the meeting.—(*Communicated.*)

ESSEX B.K.A. ANNUAL MEETING.

The twenty-ninth annual general meeting of the above association was held on Wednesday, April 7, at Devonshire House Hotel, Bishopsgate Street, London, E.C., at noon.

Mr. Howard Flanders, of Latchington, presided, and amongst those present were Messrs. Stanley Wilton, L. Belsham, G. T. Faunch, L. L. Goffin, A. W. Salmon, and Mesdames E. E. Ford and Amy Wilson.

The secretary, in presenting the annual report and balance-sheet, regretted that there had been a decline of two in the membership, whilst the financial aspect was not at all satisfactory, the past season having closed with a deficit of £3 11s. 7d. This had compelled the committee to advise the curtailment of expert visits to the cottager members, who in future would have a spring visit only, unless the presence of disease necessitated an autumn call as well. Two members had successfully passed the third-class examination for experts—viz., Mr. L. L. Goffin, of Wakes Colne, and Mr. G. R. Alder, jun., of Rawreth. Sincere regret was felt at the loss of the late Bishop of Colchester, who had been a vice-president of the association for many years; whilst by the death of Mr. W. Broughton Carr one had passed away whose loss was felt by every bee-keeper who had the pleasure of knowing him.

The officers were re-elected for the ensuing year, with the exception of the expert, Mr. A. Bagley, of Brightlingsea, being appointed for the season.

The meeting then closed with a hearty vote of thanks to the chairman for kindly presiding.—G. R. ALDER, Secretary.

HONEY IMPORTS.

The value of honey imported into the United Kingdom during the month of April, 1909, was £6,850.—From a return furnished to the BRITISH BEE JOURNAL by the Statistical Office, H.M. Customs.

Correspondence.

The Editor does not hold himself responsible for the opinions expressed by correspondents. No notice will be taken of anonymous communications, and correspondents are requested to write on one side of the paper only, and give their real names and addresses, not necessarily for publication, but as a guarantee of good faith. Illustrations should be drawn on separate pieces of paper. We do not undertake to return rejected communications.

NOTES BY THE WAY.

[7451.] "May, smiling May" has come in with a shining face, though with cold easterly winds, which have retarded in exposed positions the work of the bees. In warm, sheltered apiaries, with the fruit-bloom, the wild cherry and the sycamore trees, and myriad blooms of dandelions, making the fields appear as if covered with a cloth of gold, a good advance has been made by stocks, and in some parts we hear of supers being put on and strong stocks "hanging out"—i.e., clustering around the entrances of hives. When this has occurred in my own apiaries I have given an extra sheet of foundation, and my "Combination" hives, having fourteen or fifteen frames, give ample room to enlarge the brood-nest. Should favourable weather continue, these extra strong colonies can spare a comb of hatching brood to help the weaker ones to reach supering condition earlier than if left to their own unaided growth.

The mention of extra room brings to mind a point which I would strongly emphasise when addressing new recruits to the craft: Always use full sheets of foundation securely wired (I mean that the sheet should have the wire embedded in the foundation in the frame) for enlarging the brood-nest of established stocks. If starters only are given, the bees will in most instances build the comb *drone size*, and consequently produce a large quantity of drones. I lay stress on the embedded wire, as I have seen frames fitted with sheets of foundation and wire simply wound round them. The bee-keeper evidently thought it would keep the comb in the frame, which was all that

was necessary. Buy a "Guide Book" and learn how to wire frames properly, or ask the expert when he calls to show you how it should be done. In my opinion it would greatly enhance the value of lectures in the bee-tent if practical bee-work were explained and illustrated, instead of the everlasting driving which has been carried on for the last thirty years. I would rather teach beginners to start with a swarm in a new hive than to buy a stock in a skep and drum out the bees, practically making an artificial swarm, saving a part of the brood and sacrificing one stock to make another, which will need great care to make even a medium colony. A good swarm, if secured fairly early, will go right forward to success, and during its first season will pay for itself, and often for the hive as well.

Sending Honey by Rail.—I believe all the big railways carry honey only when the consignor signs a conveyance note absolving them if goods are damaged in transit; that, at least, is how I read my consignment notes. Fortunately, I rarely get honey damaged in transit, but I have had some bad smashes when buying sections from a distance. Bee-keepers will not pack carefully enough to stand the journey by rail. *I invariably send my honey by *goods train*, as the manner in which parcels of merchandise are bundled out, mixed up with passengers' luggage, on to the platform at a busy station will convince the most sceptical that it is unwise to send honey by passenger train.

Swarming.—A word to the wise may not be amiss in a closing note. Always dispatch swarms as early as possible after they are hived, if they have to travel a long distance (say 300 to 400 miles); but if only twenty to a hundred miles, by first train the next morning will do. See that they start well provided for the journey in a roomy box, with plenty of ventilation, and when receiving swarms always feed on arrival. If strainer-cloth is used for the swarm-box, syrup can be carefully sprinkled on the cloth or honey spread on it with a knife. Be sure that the hive stands quite level, and use your judgment as to the number of frames. A 3-lb. swarm should have six or seven, a 4-lb. swarm eight, and a 5-lb. swarm may have the full ten; or if super honey is wanted, put the bees on nine frames and super in a week or ten days, if weather continues good and honey is coming in freely.—W. WOODLEY, Beedon, Newbury.

BRITISH BEE-KEEPERS' ASSOCIATION

[7452.] Will you kindly allow me to draw the attention of those of your readers who are not already members of the British Bee-keepers' Association to the

good work which it has hitherto carried out, but which must now be curtailed if increased support is not forthcoming?

In your issue of April 29 attention was drawn to the fact that an application had been received by the association for proposals in regard to the honey classes at the next Dairy Show, but that the Council had felt that no grant could at present be made, in view of the condition of the finances, without entrenching upon invested capital, which they did not feel justified in doing.

As the association is entirely dependent for its income upon voluntary contributions, and as the sickle of Time has mown down many generous supporters—of which we have been reminded so frequently of late in your columns—the Council must, like all wise administrative bodies, cut the coat according to the cloth.

The value of the work hitherto carried out by the association from both the practical and educational points of view can hardly be over-estimated, and markets for honey and wax are frequently found by small bee-keepers who compete for the association's prizes at various exhibitions.

Moreover, applications for the certificates of proficiency in apiculture which are granted by the association have been very numerous in recent years, with the result that there has been an increase in the cost of examination work, in spite of the fact that all officials, with the exception of the secretary and the expert, give their services gratuitously.

I will not trespass upon your space by giving the numerous advantages which are enjoyed by those who subscribe the small sum of 5s. a year to the association. Full particulars of these can be obtained on application to the secretary, Mr. Edwin H. Young, 12, Hanover Square, W. But I wish to impress upon your readers the great value of individual effort at such a time as this, and will conclude by saying that if each one reading this appeal were either to subscribe or to obtain a new member the Council would be entirely relieved of the anxiety which they are now experiencing, and, instead of having to reduce the scope of the association's work, they would be enabled materially to extend it.—J. B. LAMB, Hon. Secretary to the Appeal Committee.

RANDOM NOTES.

[7453.] *Bees in a Tombstone.*—The other day I visited the church and churchyard of Irongray, on the banks of the Cairn, in the beautiful county of Kirkcubright. A pilgrim to the shrine of Helen Walker, the prototype of Sir Walter Scott's Jeanie Deans, who lies buried here, I was wandering in this romantic "God's acre" when I made a

unique discovery. The day was fine, the hum of bees made music over the silent dead, and on looking round I chanced upon a wonderful hive. This was in the inside of a huge tombstone, built of two massive slabs, crowned by an arch of stone with sides of stone also, and forming a cavity in the centre. Into this the swarm had found its way through a small aperture near the top, and on the day of my visit bees were coming and going in business-like fashion, indicating that the colony was in a progressive state. The tower of the church was evidently also the home of bees, as they were coming and going from several small openings in the masonry. I had no camera, and so regretfully left the spot without being able to take a snapshot of this curious hive.

I have recently seen a curious case of bees hatching a couple of larvæ in a cell. In the hive I am writing about there were two grubs in at least two-thirds of the cells on both sides of a couple of combs. All the other combs were full of sealed stores. In some cells there were as many as five eggs. Some of these twin larvæ would be at least three days old. I presume that when the cell no longer holds two one will be evicted by the bees.

In my last I wrote of "hunger swarms," and recently I have met several cases where the bees have deserted hives or skeps containing plenty of stores and brood also. The reason for this seems to be the presence of mice in the hives—animals which bees cannot endure. To keep out these pests is a very easy matter. Skeps may be set on a stand on to which mice may be prevented from climbing by nailing a wide piece of metal on top of the legs. With frame-hives the entrance should never be deep enough in winter or spring to admit a mouse.

The outlook in the North of England is promising. Although the condition of stocks in general is not so forward as we have seen them, yet the continuous succession of suitable forage which we have had, in weather which has been in the main favourable for the flying bees, ensures steady progress. Sycamore and wild cherry are plentiful here, and in bloom together.—G. W. AVERY, Heads Nook, Carlisle.

BEEES IN THE MIDLANDS.

[7454.] As we do not often have an account of the bees from this part of the country in your valuable B.B.J., I now venture to send a few notes which may interest your readers.

Though the weather was anything but favourable for the bees in March, on April 5, when making my first spring examination, I found my stocks much more forward than I had expected; brood-

rearing was advancing well, most stocks having three or four combs with a good patch of brood, and the work is still merrily going on. It must be a joy to all bee-lovers to see their pets coming in by the hundred with loads of pollen almost as heavy as themselves. I do not remember ever having seen bees work harder than they have this last fortnight. Reports from several local bee-keepers show stocks to have wintered fairly well, and they should (if weather continues favourable) be ready to take advantage of the honey-flow when it comes.

Bees Re-queening Themselves.—A rather curious instance of bees re-queening themselves came under my notice the other day. The stock in question is headed by an English queen reared in June, 1907, and last year did very well. When examining on April 5 I noticed that drones were being reared, and a number had even hatched out. This greatly surprised me, as most of my stocks had not commenced drone-rearing at all, not even an egg being laid. The queen was laying very well, there being four combs of brood, but on looking into the hive on Friday, April 16, I found the queen had ceased laying in the four combs containing brood; in fact, I quite thought she was dead, as there was hardly any unsealed brood, but on coming to the last comb against the side of the hive there was her majesty quietly laying, with just a small patch of brood, the bees having started about six queen-cells on the combs of the brood-nest proper. I shall now keep them under notice and see how it ends. The question is, Did the bees know that their queen was about to fail, and that so suddenly?

Wishing all brother bee-keepers a successful season in 1909.—F. E. MATTHEWS, Northfield.

THE W. B. CARR MEMORIAL FUND.

[7455.] I have been watching the list of donations to the "W. B. Carr Memorial Fund," and to-day what I expected to see some time ago has appeared, *i.e.*, a subscription of 1s. The fund should be much larger than it is, and there are thousands of bee-keepers in this country to whom the late Mr. Carr was of great help, either directly or indirectly. Coming into personal contact with him so much during the last ten years, I know that a great deal of what should have been his own leisure time was spent in helping with advice bee-keepers in every part of the British Isles.

The amount of the fund at present is insignificant compared with the work he did for those engaged in the craft, and it ought to total at least £100.

Probably bee-keepers have been waiting,

afraid to send their mite; but what I should like to see is a long, long list of those mites. In this way we can show our appreciation of the labours on our behalf of the good and kindly man who has left us. I am quite sure a great many will send a contribution when they know that the little they can spare shows their feeling as much as the larger sums contributed by those who can afford more. I would also point out that this money is going to be spent for the benefit of bee-keepers, not for an individual, and I am sure, could he have expressed a wish, Mr. Carr would have had it so. I have not yet sent a donation myself; but nevertheless my name will appear in due course. Let me appeal strongly to brother bee-keepers to show that they are not ungrateful, and let us have that fund swell very much and very quickly, so that a fitting memorial shall be established to the

and it looks as if it is likely to undo all the good of the previous month.

I am very glad of your opinion respecting Mr. Pratt's statement about the perishing of brood when separated from the queen during artificial increase, and am pleased to find that your experience is similar to our own. I hope we shall have the pleasure of seeing you in Switzerland this summer. — U. GÜBLER, Belmont, Switzerland.

ELECTRICAL SWARM ALARM.

[7457.] In this age of invention let us inaugurate the season of 1909 with some novelties in the bee-keeping line. We have flying machines, wireless telegraphy, and other useful inventions, but I propose to utilise the rushing of a swarm out of a hive to ring an electric bell, and thus give warning to the owner. A and B in illustration are gutta-percha-covered

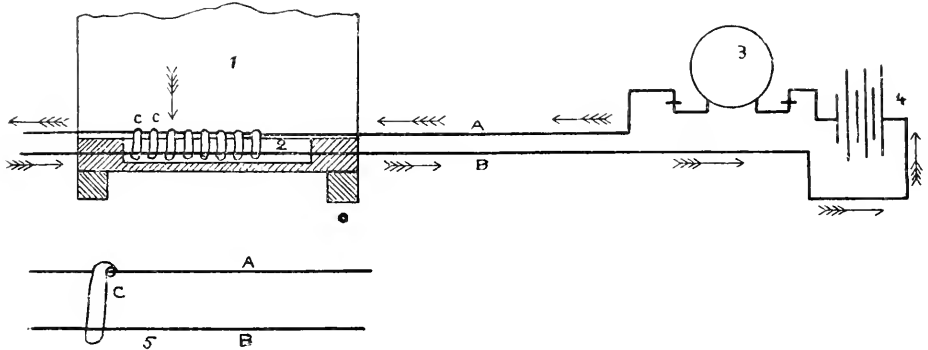

ELECTRICAL SWARM ALARM.

1. Hive. 2. Entrance. 3. Electric bell. 4. Battery. 5. Enlarged contact piece. A and B. Covered wires. C. Thin brass contact pieces. Arrow-points, direction of current flowing through the wires.

memory of him we all loved so well.— W. HERROD, Old Bedford Road, Luton, Beds.

BEEES IN SWITZERLAND.

[7456.] I sincerely thank you for your notice of me in the B.B.J., and feel it a great honour to be presented to your readers, as I am only trying to carry out what you masters of the science have taught. I am proud to think that you do not despise my modest efforts, and am thereby encouraged to persevere with them so long as I am given the strength to do so.

The past winter has been disastrous in many parts of Switzerland, and a great many colonies have been lost, more especially where there was a failure on the part of the bee-keeper to supply food in the autumn in cases where provisions failed. During the fine weather of April colonies developed well, but unfortunately May appears to be so far unfavourable,

copper wires, bare over the entrance to the hive. Attached to the wire A are thin brass contact pieces C, which hang loosely without touching wire B. As the bees rush out of the hive these contact pieces touch wire B, completing the circuit and ringing the bell. This arrangement is only applied to hives about to swarm, and at other times the contact pieces can be pushed to one side of the entrance so as to allow the bees free passage to the hive. While a swarm is rushing out the bell will ring continuously and thus give warning to the bee-keeper or his family in the house. The best place to put the bell would be in the kitchen, as it is sure to be heard by someone there. By continuing the wires any number of hives can be connected with the same circuit, and I think the device will be the means of saving many a swarm. There are eight contact pieces, and it will be noticed that the whole of the opening is not taken up with them, but a space is left on the right-hand side for the free passage of

bees. Sometimes bees will form chains in front of the entrance, but if they make an electrical circuit by means of their bodies the making and breaking of the contact with the bell would give them a slight shock, which would soon teach them to avoid the wires. I think this is the first time that electricity has been applied to such a purpose, and I can see the time coming when we shall be able to utilise it in many ways in connection with bees.—HENRY RATHBORNE, Trieste, Austria.

DISTANCE OF BEES' FLIGHT.

[7458.] I should be greatly obliged if you would kindly tell me what is the greatest known distance a bee has flown to gather honey. A friend of mine tells me that it is recorded that bees have travelled twelve miles—six miles each way.—P. W. BROWN, South Hackney, N.E.

[It is very difficult to fix with certainty the distance to which bees are able to fly, but some (under exceptionally favourable conditions), when food was scarce, have been observed as far as four or five miles away from the apiary. Such cases, however, are very rare, and it is doubtful if bees flying so far from home ever get back again. Messrs. Dadant have known strong colonies of bees to starve upon the hills in a year of drought while the Mississippi bottoms, less than four miles distant, were yielding a large crop. M. Kaden mentions in the *Bienenzeitung*, 1854, page 83, that a vessel, laden with sugar, anchored off Mayence was visited by the bees of the neighbourhood. One morning, when the bees were in full flight, the vessel sailed up the river, and for a while the bees continued to fly as before; but gradually the number diminished, and before the vessel had proceeded four miles all bees had ceased to follow. For practical purposes, any pasturage beyond two miles is of small value to the bee-keeper, as the bees will store very little, if any, surplus from it.—Ed.]

MOVING BEES.

[7459.] A few weeks ago I saw in your "Notices to Correspondents" (page 140) that the advice was given not to move hives at this time of the year, unless going a distance of quite three miles. During Easter week a friend and I moved a hive a distance of 150 yards, placing some sticks over the entrance when in its new position. We lost about a hundred bees by this removal. We again moved this hive and three others to a field about a mile and a half away, and placed the sticks in front of the entrances as before.

I am pleased to say that in each hive the bees are well at work, and as far as I can judge no bees have been lost but

those in the first removal.—WALTER G. HINDE, Bucks.

[Our correspondent has been fortunate in the conditions which have enabled him to move his bees without much loss. When bees make their first flight after their winter's confinement they may be seen circling in the air round the entrance and gradually increasing the circle, at the same time marking the locality and familiarising themselves with their surroundings. This done, they fly backwards and forwards without taking any notice of the prominent objects. If a hive is moved only a few feet, when once they are familiar with their surroundings there is at once confusion. Many bees return to the old spot and others get into some hive close by, which results in fighting and the loss of many bees. At such times the only safe method is to move the hives not more than 3 ft. each day when the bees are flying, so that they can catch sight of their own hive. If this is not possible, it is recommended to remove the bees two miles (not three miles, as stated by our correspondent, although this would do no harm). The bees, being confined to their hive and disturbed by the movement, would then on being liberated act in the same way as if they had been confined by the cold, and would mark their surroundings as carefully as when taking their first flight. We have known many bees to be lost when removed only a mile and a half, and therefore to be on the safe side always recommend a distance of two miles. It is quite different in winter, for after bees have been kept in their hives by cold for some time they take notice of their surroundings when they first fly out, so that moving them short distances at such times is not injurious.—Ed.]

HIVE-ROOFS.

[7460.] It may be of interest to readers of the B.B.J., especially to those who have had difficulty with leaky hive-roofs, to know that an efficient, cheap, and durable roof may be made with Delabole slates. I have had these roofs of my own construction over frame-hives and skeps for years, and I have never known them to leak or blow off. I shall be pleased to give details of same if desired, as they are a boon to those requiring a rainproof roof.—R. GROSE, Bodmin.

[We shall be pleased to have the particulars referred to by our correspondent.—Ed.]

NOVELTIES FOR 1909.

THE "FREE-WAY" QUEEN-EXCLUDER.

Mr. A. H. Wilkes, the inventor and patentee of the "Free-way" excluder which he exhibited at the B.B.K.A. Con-

versazione in October last year, has sent the following description of his appliance, which he considers will be found a great boon to bee-keepers. He says:—

"This excluder is designed to allow the maximum number of bees to pass through during a honey-flow, when they are working at high pressure, and it is most im-

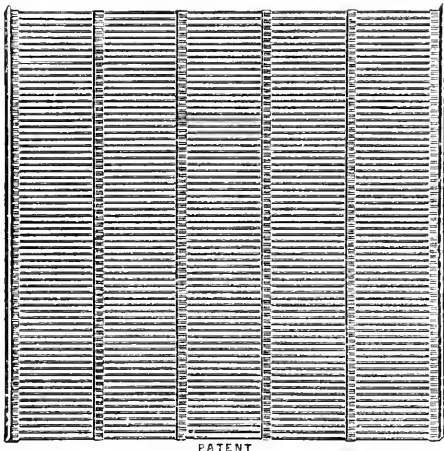

portant that their progress should not be checked. Being made of hard wire, it will allow 1,200 bees to pass through at one time in a ten-frame hive with $\frac{1}{8}$ -in. top bars, as against 800 in the zinc excluder. The ribbed strips sit on the top bars of frames, and the bees pass through the wires with scarcely any hindrance, as the burnished wires present a smooth, rounded surface to the bees, instead of a thin knife edge as in the zinc excluder: it will therefore be readily seen that a greater surplus of honey is the natural result. This excluder always sits flat on frames, and cannot buckle; neither can it be propolised down, as there are no flat surfaces, and the spaces are guaranteed to be the same width as those in the zinc excluder approved by the Editors of the B.B.J. Its use also checks the tendency to swarm, and certainly the bees take to this much more readily than the zinc one: in fact, they take to the 'Free-way' excluder as ducks take to water. After long and patient experiment, I have succeeded in making it of non-rusting material. The price for one 15 in. by 15 in. is only 1s. 6d., and this sum can be saved many times over in the first year by its use."

SUCCESSFUL APICULTURE.

LOCALITY AND SITE OF THE APIARY.

"What a glorious morning! Come along; let us go down to the apiary. . . ."

"That's good, all twelve stocks flying well. I wish the farmer had not cut this hedge so low."

"Why?"

"Because it gave the bees just the shelter they need. Yon range of low hills at the back protects them from the north wind, but this hedge gave them a near-home shelter, which saved many bees on the wing, and I noticed a difference after the hedge was cut."

"Well, cannot you move the apiary?"

"I do not want to do so, for, you see, this is a grazing-field never laid for hay, so there is no danger from mowing-machines. If a loose horse is stung it is up and away, but when attached to a mowing-machine it is quite another affair. We have only to cross this field to reach the highway, so that in taking our surplus honey home we have an easy run, and yet the bees are sufficiently far away from the highway in this quiet, snug corner. Then, again, the bees have a good free flight direct south, which is an important item when they come in laden and are flying low."

"Do you consider this a good locality for bee-keeping?"

"Only fairly so. We depend on the white clover and a few limes for our nectar. The ground here dries so rapidly that the grasses are soon burnt up; so that too dry or too wet a season is not a success. The better the farming in the district, the better the clover crop. Modern farming does not yield so bountiful a flow of nectar. The rotation of crops is: (1) Roots, (2) wheat, (3) barley or oats, with (4) red clover for a one-year ley. The two- and three-year leys with alsike and Dutch clover are not so popular, so that a really good location is not often met with."

THE EXAMINATION.

"Now let us get to work. Bring along the tool-box."

"Which do you want—carbolic cloths or smoker?"

"Bring both."

"Am I to put fresh carbolic on the cloths?"

"No. I only want them weak just to keep the bees down from the tops of the frame. I shall use the smoker to subdue them because at the first opening there is less unsealed honey, and it takes longer at this season of the year to compel the bees to break the sealed cells and fill themselves with honey. Bees with empty honey-sacs are liable to 'ball' the queen."

"Which smoker am I to light?"

"The small one, and, when lighting it, strike your match inside the cylinder, and hold it there with the waste over it till it is well alight; then push it lightly in, and you can be certain of a smoke. Never load a smoker too heavily."

"Shall I open No. 2 while you are opening No. 1?"

"Yes; if you are at work you will not be so much afraid of a bee stinging you."

"What am I to look for?"

"Well, the four chief points of a good colony are: A good queen; plenty of bees to cover the brood; abundant stores; and stocks well established on old combs. No. 1 colony possesses all four points. There are five combs of brood—which shows there is a good queen—and plenty of bees and stores; also there are no new thin combs."

"I thought new combs were best, and that the queen laid better in them?"

"That may be true later on during the heat of summer, but now, with cold, frosty nights, the cocoons left in the cells make a thicker midrib, which conserves the animal heat during the night, thus helping the colony in brood-rearing."

"But a diminished cell will make a smaller bee?"

"The cell does not grow less. Combs thirty years old produce as large bees as comb newly built from foundation. The midrib grows thicker, but the cell-walls are lengthened in proportion. Nor is the chitine of which the cocoons are composed insanitary, unless they are continuously damp."

"I have four combs of brood in No. 2, but do not see the queen."

"That does not matter. Look for her work—eggs or larvæ. I expect there is plenty of stores?"

"Yes."

"Well, take a good outside comb, and break the cells by pressing them in with the flat of your knife. Put it in the centre and close up the colony."

"I am putting this comb which comes next to the brood into the centre."

"No, don't shift that. You will find it full of fresh-gathered pollen from the crocuses and the palms. That is part of the brood-nest. Take another."

"I took that because I thought it would be warmer than the outside comb; but I will take the next."

"Don't forget to bruise the honey, because the bees will move it and place it just where they want it, leaving a nice clean comb where it gets all the warmth, and, with pollen and honey handy, they will go on feeding the queen and breed rapidly. . . ."

"Enter in your book five combs of brood."

"There are only four."

"That is so; but there will be five when we examine again in a fortnight, and our book will show what to expect then. Book No. 1 seven combs of brood. I have put two combs of bruised honey into this stock, one each side of the centre comb. Ah! No. 3 not so strong! Only three of brood. I usually find No. 1 the strongest in the spring. After the turn of the year bees mark their flight more

particularly than they have done previously. The flight in this apiary is usually towards the east; so that No. 1, being the first to the east end of the apiary, gains an accession of bees from the other colonies when coming home laden. We will let this stock alone, as it is no use stimulating a queen to lay and giving her extra room if there are not bees enough to cover her work. Book No. 3 three combs of brood. How is No. 4?"

"It has four combs of brood."

"Well, repeat No. 2, and close up quickly: the sky looks overcast. No. 5 a drone-breeder, but a fair number of bees."

"How can you tell that?"

"Well, look at these worker-cells lengthened out—that is to accommodate the drone-brood; and notice that all the bees are old ones, the nurses being nearly all gone."

"Are those brown cells foul brood?"

"Not necessarily. You see, the bees are losing their energy. There are no young bees to take their place, so the brood is neglected; but there is no ropiness. You can put the comb into a stock like No. 1 and they will clean it all out; but I do not consider the value of the comb worth the extra work entailed. Let us seek the queen. Here she is."

"Why, she is a smart, active queen!"

"Ah, that may be; but the old queen had clipped wings; this queen's wings are perfect. Queens do not all live to a ripe old age. The original queen was not a year old. This young one has been raised during winter, when her mating tour was impossible; therefore she has only the power to lay male eggs, which are produced parthenogenetically. She is of no value; so we will dispose of her. Hello! rain. Hurry up with No. 6."

"Three of brood!"

"Bring the flour-dredger, and we will join No. 5 to No. 6 sharp, and go home, for there is a big storm brewing. We can come down again next week, and see if this stock is right and examine the rest of the apiary."—JOSEPH GRAY, C.C. Lecturer.

Queries and Replies.

[3928.] *Queen-rearing.*—I should be much obliged if you will help me with advice as to rearing queens for my requirements. I started bee-keeping last July, and by purchase, &c., have now seven stocks. These have all wintered well, and now have plenty of stores and a lot of brood in every hive. As I do not know the age of any of the queens, I am anxious to rear some for present stocks and future swarms, &c., but cannot decide the best method to adopt. I have read the article in B.B.J., page 11, where M. Adrien Getaz describes his method of rearing and introducing queens without the need of forming nuclei, and I have also read the "Guide Book." 1. In each case I

am puzzled by the same thing: where queen-cells are placed in cages how long may the queens be kept there after hatching out? Page 131 of "Guide Book" says cages containing queens may remain in hive until wanted for insertion in nuclei. In this case I should like to substitute "future swarms, &c." for "nuclei," and cannot see how the queens can be kept in the cages for the possibly considerable period; how are they fed in the cages? 2. You will see by these queries that I am quite a novice, and as the different methods advised by different experts vary so, it is hard to decide on the best plan. If practicable, I should prefer not to form nuclei, but cannot see what to do with queens reared that are required for future, and not immediate, use 3. How many stocks should be re-queened this year? Thanking you in anticipation.—NOVICE, HANTS.

REPLY.—1. It is always better to introduce queen-cells to nuclei, but if queens are allowed to emerge in the cages, they should only be kept in them while the nuclei are being prepared. The shorter the time they remain in the cages the better, because such queens are not fed or cared for so well by the workers as those free among the bees, and they are never so readily accepted as those that hatch in the nuclei. In any case, it is not advisable to keep them in cages for more than two days. Newly-hatched queens are readily accepted, but the usual precautions must be taken in introducing older ones. 2. You can dispense with nuclei if you follow the plan recommended by A. Getaz on page 11, B.B.J. Remove the queen from the hive into which you wish to introduce a new one two days before you expect the queen in the cell to hatch, and on her emerging she can be given to the queenless hive. Queens for swarms will have to be kept in nuclei in readiness for the swarms when they appear. Queens for future use should only be kept in nuclei. 3. It is usual to re-queen one-half each year.

[3929.] *Suspected Combs—Baby Mating-boxes.*—

1. I note, from replies to various correspondents, that you cannot diagnose disease from drone-brood alone, and should be glad to know why this is. About three weeks ago I noticed a small drone issue from one of my hives, and so examined the hive, and found a small drone-breeding queen with few bees. The brood was badly diseased, and piles of immature drone-grubs lay on the floorboard. There were no smell and no "ropiness," while the position of the larvæ was fairly normal, but the colour inclined to brown; while in capped cells (some of which were indented and some punctured) the matter was watery. It seemed to me like a case combining some features of chilled, pickled, and foul brood. I sulphured the lot and burnt the combs, and should have sent a sample to ask your opinion had there been any worker-brood present. 2. In your issue of June 4, 1908, Mr. H. Potts (7130) mentions a small mating-box, with small frames, and says he removes them from the large frames and "attaches the top bars to them . . . by a simple arrangement," &c. I should very much like to know what this simple arrangement is, as I have tried to follow out his plan; but the method of easily and quickly attaching to top bars is important.—J. A. CLAXTON, Doncaster.

REPLY.—1. Because the disease is more frequent in worker-brood and drone-brood, often reared on the outside combs or edges, sometimes becomes chilled or starved and changes colour, and in the incipient stages may be mistaken for foul brood. 2. The standard frame Mr. Potts employs is 13½ in. by 7½ in. inside measurement. This takes four small frames, 6½ in. by 3½ in. outside measurement. If all four are used no attachment is necessary, as they completely fit the large frame. If only two small frames are used, they are attached to the top frame by means of staples ¾ in. long and ½ in. full between the two ends, □

so that when pushed in at the side they clip the top bar of small frame to the top bar of large one. When the small frames are wanted for the mating-boxes they are removed, and top hanging bars, 8½ in. long, have to be attached to them. These bars have staples driven in at the edge, which project ¼ in. below, are parallel with the under side of the bars, and are placed 5½ in. apart, so that the small frames when pushed in are kept at the proper distance from the ends, are clasped tight to the bars by the staples, and in this way form complete miniature frames, which can be placed in the mating-boxes.

[3930.] *Removing and Extracting Sections.*—As I am only an amateur, although I have kept bees for several years, there are some things I do not understand. I have the "British Bee-keeper's Guide Book" and take the B.B.J. weekly. I intend to increase my apiary, and to market the honey that I do not require. To do so I have made up my mind to buy a honey-extractor (to extract sections only) and an uncapping-knife. 1. Kindly advise me which would be the best extractor for sections and the price. 2. Is it necessary to get a ripener (which I see advertised) when honey is extracted, and can it not be bottled at once, or has it to stand to ripen? If it stood in extractor in a certain temperature for a time before bottling would that do? 3. Also, will you explain the use of the "Porter" bee-escape and super-clearer. How do you get bees out of rack quickly, seeing that they are so troublesome when removing the sections one by one? Please give replies in your most helpful paper.—LANCLOT RUTHERFORD, Tweedmouth.

REPLY.—1. If you intend going in for extracted honey you had better work with shallow-frame supers, as it will not answer your purpose to produce sections for extracting. Any of the extractors shown in "Guide Book" will do, and it is only a question of quality and the price you wish to pay. 2. You require a ripener, because the extractor will not hold enough honey, and it would have to stand idle for some days while the honey was settling and ripening in it. 3. The use of the "Porter" bee-escape and super-clearer is fully explained on pages 58, 59, and 61 of "Guide Book," and you will see that it is not necessary to take out sections one by one.

Bee Shows to Come.

June 8 to 11, at Reading (Berkshire B.K.A.)—Show of Honey in connection with the Annual Exhibition of the Royal Counties Agricultural Society. Over £30 in prizes. Schedules from D. W. Bishop-Ackerman, Hon. Sec., Berks B.K.A., 161, King's Road, Reading. **Entries close May 14.**

June 22 to 26, at Gloucester (Royal Agricultural Society's Show)—Bee and Honey Section under the management of the B.B.K.A. Prizes arranged in groups of counties for Associations affiliated to the B.B.K.A. Schedules from E. H. Young, Secretary, B.B.K.A., 12, Hanover Square, London. **Entries close May 31.**

July 15 and 16, at Louth.—Show of Honey, Hives, and Bee-appliances in connection with the Lincs Agricultural Society, Bee-department under management of the Lincs B.K.A. Schedules from J. Hadfield, Hon. Sec., Lincs B.K.A., Alford, Lincs. **Entries close June 11.**

August 4 and 5, at Abingdon Park, Northampton.—Honey Show of the Northants B.K.A. Special prizes for open classes, including one for single 1-lb. jar honey. (Entry free.) Prizes 20s., 10s., 7s. 6d., and 2s. 6d. Schedules from R. Hefferd, Hon. Sec., Kingsthorpe, Northants. **Entries close July 28.**

August 10 to 12, at Beverley.—Show of Honey, &c., in connection with the Royal Yorkshire Agricultural Society. Schedules and form of entry from John Maughan, Secretary, Blake Street, York. **Entries close July 3.**

Notices to Correspondents.

INQUIRY (Dorset).—Dissolving Naphthol Beta.—1. You cannot use anything better than rectified spirits of wine for this purpose. 2. Dry sugar feeding is not usually practised now. 3. There is no association in Dorsetshire.

Mrs. A. Wilson.—Brood Cast Out.—The immature bees sent have been killed, and for this reason the brood has been cast out. As the stock is strong and doing well there is no cause for anxiety.

C. P. (Liverpool).—Bees Dying.—The bees appear to have died of starvation, and have dropped on the floorboard in a heap. They have commenced to decompose, hence the putrid odour.

GEO. W. JUDGE.—Bee-nomenclature.—The bees sent are the British wild bee (*Andrena rosea*). They build their nests in the form of tunnels, from 5 in. to 9 in. in depth, either in banks or horizontal flat ground, sometimes on hard, down-trodden pathways, storing them with the usual mixture of pollen and honey kneaded together.

A. B. B. (Southend).—Please send full address to Editor, as a letter posted to the address you gave has been returned by Post Office.

Suspected Combs.

R. A. G. (Southborough).—There are traces of black brood in the comb. The scattered cells contain drone-brood, showing either that the queen had become a drone-breeder before her disappearance, or that a fertile worker is laying in the hive. As there are very few bees the best plan is to destroy them, as those that are still alive would be old ones, and not worth uniting with others. Destruction of the combs also rids you of the spores of disease.

W. L. G. (Merionethshire).—The comb is very old and contains foul brood in the spore stage; also some cells containing hard pollen and granulated honey. As it is in the most dangerous condition such comb should not be given to a swarm, but should be destroyed.

WELSH DRONE (Montgomeryshire).—Comb is affected with foul brood of old standing. You should burn the skep and its contents without delay, and disinfect the place on which it has stood. Nearest B.K.A. is the Shropshire; hon. secretary, Mr. S. Cartwright, Shawbury, Shrewsbury.

Novice (Tetbury).—Comb is affected with foul brood in the early stage of the disease. As the stock is strong treat according to instructions in "Guide Book," and you will, no doubt, be successful in curing it.

Special Prepaid Advertisements.

Twelve words and under, Sixpence; for every additional Three words or under, One Penny.

FOR SALE, 3 Stocks of healthy Bees, in straw Skeps, also 3 May 5th Swarms, in straw Skeps.—W. G. MARTIN, Lenchwick, near Evesham, Worcestershire. p 70

CARNIOLAN QUEEN WANTED.—State age and price, L. NICHOLSON, Nursted Lodge, Devizes. p 79

"WELLS" DOUBLE HIVE, with Frames and Feeder, &c. Will exchange for Bees, also 2 Single Hives. What offers?—KEEN, Nechells, Birmingham. p 73

WANTED, Swarms, English or Italian, latter preferred.—Price and weight to HUTCHINSON, 57, Sydney-street, Stockton-on-Tees. p 67

GENTLEMAN'S FREE WHEEL BICYCLE, 35s. W. WOODS, Normandy, Guildford. p 66

WANTED, SWARMS, any number.—Price and particulars to HERRÖD AND STEWART, Luton. p 68

Special Prepaid Advertisements.—Continued.

METAL ENDS ("W.B.C."), sample gross 2s., post free.—BEE-KEEPERS' STORES, Arcade, Bedford. p 85

GUARANTEED GOOD, HEALTHY SWARMS BEES, excellent working strain, native black, 15s. each.—S. J. COAKES, The Watton Apiary, Clent, near Stourbridge. p 63

HEALTHY YOUNG FERRETS, ready for sale early in June, 2s. 6d. each, 6 for 13s. 6d.—J. COAKES, Clent, Stourbridge. p 64

STRONG BEE-HIVE, new, used few weeks, 30 frames, complete.—Price, particulars, PEB, Pinham, Gainsborough. p 81

STRONG SWARMS READY END MAY, from 10-frame Hives, 12s. 6d. and 15s. each.—NORTH, Poplar Hall, Cressing, Braintree, Essex. p 82

NATIVE QUEENS, 1908, 5s.; in June 1909 ones, 4s.—ROBERTSON, Benview, Dumbaron. p 80

2 LADIES, young, desire situations as Pupil-assistants, one to learn poultry-keeping, the other bee-keeping, gardening if possible.—"BEE," c/o BEE JOURNAL. p 69

WANTED, superior young girl, as help and companion, one willing to assist in 40-stock apiary preferred.—Write, stating particulars, to "A. G.," c/o BEE JOURNAL. p 61

STRONG, HEALTHY, GENUINE WORKING STOCKS, 22s. 6d., 21s.—O. HILL, Seborne-road, Worcester. p 78

TROPHY STAND, comprising one mirror, in case, with bevelled edges, 36 in. by 36 in.; plain glass plate with rounded and polished edges, 30 in. by 30 in.; ditto, 18 in. by 18 in.; ditto, 9 in. by 9 in.; 12 9-in. tall bottles, to hold stand; 45s., or nearest offer.—GARDINER, Institute, Chase-town, Walsall. p 74

4 VERY STRONG STOCKS, on 10 Frames, in splendid Hives, with 2 Lifts and Supers, my noted working strain, 25s. each; Hives worth amount; also now booking Swarms.—DAVIES, The Apiary, Bagshot, Hungerford, Berks. p 65

WANTED, this year's Extracted Honey, any quantity; also Sections, for delivery first week in July.—Samples of Honey to G. TUDOR-WILLIAMS, Balsam of Honey Manufactory, Aberdare. p 77

CHEAP LOT.—One healthy Stock Bees, two Bar-frame Hives, "Little Wonder" Extractor, Section Racks, Sections, Foundation, Feeder, Smoker, Veil, Guide Book, 27s. 6d. lot.—BARKER, 31, Coldcotes-avenue, Harehills, Leeds. p 76

SWARMS.—No more orders can be booked for this season. List of Stocks, Queens on application.—CHARTER, Tattingstone, Ipswich. p 93

"NEVER SWARM" "Detentionised" Hives, answer far better than the Claustal toy, without extra cost, floor, two 11 in. outer cases, roof, brood box, 12 Standard Frames, painted 3 coats, 22s. 6d.—HARRIS, Wavendon, Bletchley, Bucks. p 71

FOR SALE, Semi-Observation Hive, price 15s., or would exchange for Stock in Skep or May Swarm.—MISS BRIERLEY-JONES, 9, Thingwall-park, Bristol. p 72

3 STANDARD HIVES, complete (one quite new), Standard, Shallow Frames, Sections, all with Foundation, some drawn out, full appliances. Stock English Bees and Queen, perfect condition, cost £3; 45s., or will sell separately. Stamp for particulars; owner moving to town.—HAYNES, Stanleyhurst, Moseley, Worcestershire. p 62

500 SWARMS WANTED.—State price delivered Welwyn, carriage paid; boxes supplied if required.—E. H. TAYLOR, Welwyn, Herts.

PRIME NATURAL SWARMS, English, guaranteed healthy and safe arrival, 4 lb. to 7 lb. at 3s. lb. during May and early June. Cash with order or Deposit. Boxes returnable, or charged 1s. extra.—P. PESKETT, Post Office, Barnsgreen, Horsham. p 92

Editorial, Notices, &c.

PROMINENT BEE-KEEPERS.

MR. D. M. MACDONALD, F.E.I.S.

One of the best-known and most popular writers on bee-keeping at the present time is the subject of our third biographical sketch, and we have great pleasure in presenting a portrait of Mr.

that the quiet country life necessitated his taking up some hobby, and, luckily for bee-keepers, he became interested in bees, buying his first frame-hive in 1889. The story of his first lessons in the art is best told in his own words: "In starting bee-keeping I was fortunate in becoming acquainted with a prominent member of the craft in the person of Mr. Stokes, Duthill, Strathspey, a disciple of the late William Raitt, of Blairgowrie.

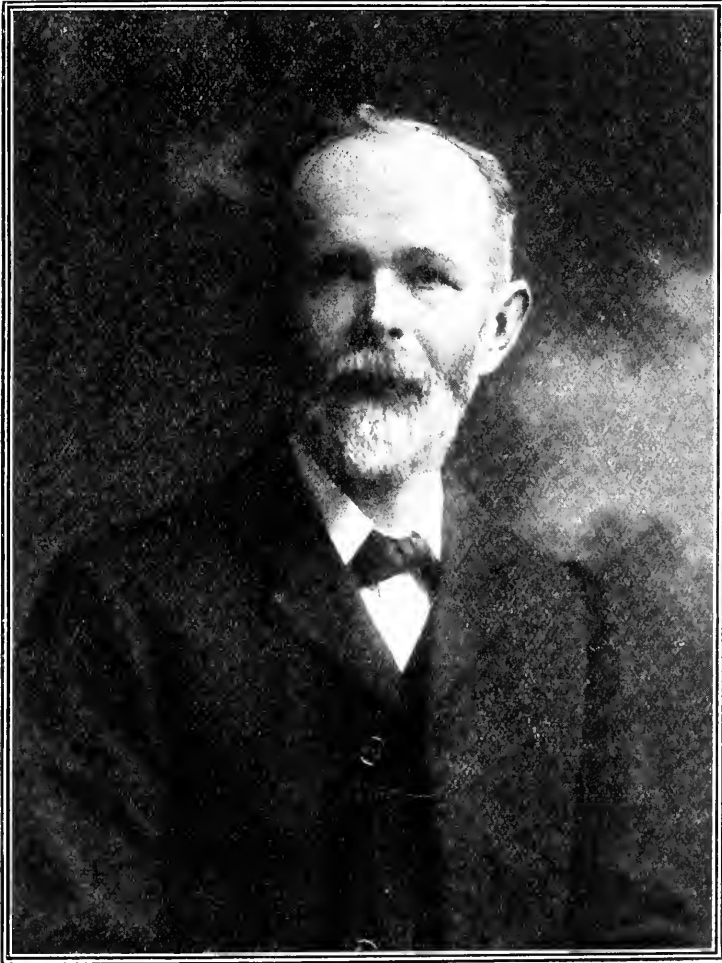

MR. D. M. MACDONALD, F.E.I.S.

D. M. Macdonald, whose *nom-de-plume* "D. M. M." is a household word amongst readers of the *B.B.J.* and *Record*.

Mr. Macdonald was born at Grantown, Morayshire, in 1853, and educated for the teaching profession at Edinburgh, where he secured a first-class Government certificate. He was appointed master of the public school at Morinish, Ballindalloch, a quarter of a century ago, and, being of an active temperament, found

He had imparted a large measure of his enthusiasm to Mr. Stokes, who, I think, handed down no small part of his ardour to me. One piece of advice he gave me was, 'Read every book you can lay your hands on, especially Cowan's "Guide," get the *Record*, and very shortly you will want the *B.J.* also,' and this proved true. He also urged *strong colonies* ready to boil over at the height of the season; he enjoined neatness, taste, and cleanliness

in getting up surplus, and gentleness in manipulation. All this advice I have endeavoured to follow, and the points are about as important as any I can counsel novices to attend to after twenty years' enthusiastic intercourse with bees, and almost that period of successful bee-keeping."

Mr. Macdonald became a subscriber to the B.B.J. and *Record* in 1890, and his undoubted literary gifts prompted him to join the staff of B.B.J. contributors, many delightfully interesting letters from his pen appearing above the initials "F. E. I. S." and "D. M. M.," under which latter pen-name his identity became known. A picture of his apiary appeared in B.B.J. of August 11, 1898, when he gave an interesting account of the famous Glenlivet in which it is situated. Probably on account of his own success in bee-keeping, for he has from the first found the hobby a paying one (his average returns per hive ranging from £1 to £2), Mr. Macdonald's articles have great practical value, and the frequency with which they are reprinted and commented on in the bee-journals of the U.S.A., Canada, and Australia shows that his writings are appreciated as much abroad as by the bee-keepers of this country. In addition to his contributions to our pages, Mr. Macdonald has also written extensively for the general Press, and his bee-notes have at different times been an important feature of several of the leading Scottish newspapers and magazines.

Mr. Macdonald possesses a very comprehensive knowledge of bee-keeping, both practical and scientific, his keen interest in the craft being by no means confined to his native land. He has long been a regular reader of all the American and Colonial bee-journals, and his "Extracts and Comments," now so popular a feature of the B.B.J., afford our readers the benefit of much valuable information gained from bee-men of other lands. He has always been greatly interested in bee-lore, and has read almost every bee-book, both ancient and modern, in the English language. In this connection he pays a much-appreciated tribute to "The Honey-Bee" when he says: "The contents of that book made me a bee-keeper."

Mr. Macdonald's interests are not confined to bee-keeping alone; he has for many years been teacher and superintendent of the Sunday school at Glenlivet Parish Church, and he has also held the offices of secretary, treasurer, and president of the County Association of the Educational Institute of Scotland. The holding of these offices, together with his literary work, makes such demands upon his time that in consequence he is obliged to keep his apiary within moderate dimen-

sions. His stocks range from twenty to thirty, which is the maximum number he is able to manage.

We admire Mr. Macdonald's devotion to work which has resulted in such success, and hope that he may long be spared to continue his usefulness for the benefit of British bee-keeping, and conclude this sketch by quoting the graceful allusion which he makes to the late Mr. Carr in the following words: "Another very pleasant and profitable feature of my apicultural experience was the delightful intercourse by correspondence I enjoyed with our late revered Editor Mr. W. Broughton Carr, and one of my heartfelt regrets is that the frequently-projected trip to London had not been carried out before he was taken to his rest."

SHROPSHIRE B.K.A.

ANNUAL MEETING.

The annual meeting of the Shropshire Bee-keepers' Association was held in the Mayor's Court, Shrewsbury, on Saturday, April 17. The president, Mr. Beville Stanier, M.P., occupied the chair, and there were also present the Revs. G. H. Pratt and D. E. Rowlands, Messrs. Roff King, R. Holland, P. Scott, J. Davenport, P. Jones, W. H. Lamb, J. Carver, — Clay, J. W. Butler, and T. Cooper, with the secretary (Mr. S. Cartwright).

In their annual report the committee recorded with pleasure a very satisfactory condition of affairs in all branches of the association: The annual show was held as usual in The Quarry, Shrewsbury, in connection with the Shropshire Horticultural Society's Great Floral Fête on August 19 and 20, and was very successful, the honey staged being of superior quality in the whole of the classes, showing that the labours of the association and its experts were bearing good fruit. The entries totalled 245, which were 90 more than in 1907. The statement of accounts showed a satisfactory increase in the balance in hand, amounting to £29 6s. 1d.

The report and balance-sheet were adopted.

On the motion of the Rev. D. E. Rowlands, it was decided to ask Mr. W. C. Bridgeman, M.P., to become president for the ensuing year.

A strong committee was next appointed. Mr. R. Holland was re-elected treasurer, Mr. S. Cartwright secretary, Mr. Roff King chairman of the committee, and Mr. P. Scott expert.

Mr. Scott stated in his report that on the whole there was a decided improvement in the methods of management and a better understanding with regard to modern methods of bee-keeping. The honey crop in the county

was a fairly good one, and some of the best honey he had ever seen was secured by members placed in one of the finest honey-producing districts in England, and obtained prizes in the strongest competitions in the country. Owing to the poor season of 1907, foul brood took a firm hold in many parts of the county, and he wished to warn apiarists that, though the good honey-flow of the past season had held the pest in check, it still revelled in their midst. He most seriously advised all bee-keepers to keep a keen look-out.

The Rev. D. E. Rowlands gave notice to move at the next meeting that Mr. Scott be asked to hold classes for the training of members to become experts.

On the motion of Mr. Rowlands, seconded by Mr. Roff King, a hearty vote of thanks was passed to Mr. Stanier, who, in replying, said he wanted to see the presidency going round each year, so as to extend the interest in the association. For his own part he would continue to take a great interest in their work.

Votes of thanks were also passed to Mr. P. Scott for his report and the officers of the association for their invaluable services in the past.—S. CARTWRIGHT, Hon. Sec.

W. B. CARR MEMORIAL FUND.

Amount already acknow- ledged	£	s.	d.
Miss L. Pollard	0	2	6
W. Patchett	0	2	6
M. K. S.	0	1	0
B. L.	0	1	0
"A Small Bee-keeper"	0	1	0
P. Kay	0	1	0
R. O.	0	1	0
S. D. Taffy	0	1	0
L. K. McFadyn	0	1	0
"A Drone"	0	1	0
D. A. C.	0	1	0
L. Krootger	0	1	0
"A Cheshire Bee-man" ...	0	1	0
"One Hive" (Kent)	0	1	0
E. C. M.	0	1	0
	£41	16	0

Correspondence.

The Editor does not hold himself responsible for the opinions expressed by correspondents. No notice will be taken of anonymous communications, and correspondents are requested to write on one side of the paper only, and give their real names and addresses, not necessarily for publication, but as a guarantee of good faith. Illustrations should be drawn on separate pieces of paper. We do not undertake to return rejected communications.

AMONG THE BEES.

INCREASE.

[7461.] In pursuance of the consideration of this subject in my last article, which dealt mainly with the amateur side of the question, I will now proceed to

deal with it on a more extensive scale and from a professional point of view. What, however, applies to apiaries carried on as a life's work, to provide the bread-and-butter, may be useful to the man engaging in the pursuit as a hobby or pleasant pastime with only a few hives, while the reverse rarely holds good.

The shaking plan is extensively carried on in large apiaries. The extensive bee-keeper cannot afford to wait patiently for developments, nor can he potter about personally or by deputy watching for problematic swarms. An out-apiary is visited, and, from patent signs known to the initiated, he concludes that a large proportion of the colonies are arriving at a period when they may swarm naturally. Forthwith he proceeds to anticipate their operations by making "shook swarms" of all and sundry. Now hives with foundation in frames are placed on the old stand, and bees are shaken clean off the old combs in front of the new hive, which receives also all the field bees returning from their foraging. The old hive is removed to a new site, there to re-queen and establish itself, or more generally with a young queen ready to head it. Or, again, if increase is desired, it may be broken up into two or three nuclei, generally at the period when brood has all been sealed over. Here is an important part of this and the following plans, as there is thus little loss from chilled brood.

A plan to be recommended is the following: Place a second body-box above the first, filled with empty comb if possible, and give the queen the whole range of the two sets of frames. When the queen takes possession of the upper story, remove the other and make a new colony of it, or break up the brood-nest into nuclei. It may be advisable, however, to place it overhead for about a week until all the larvae are sealed over, as then they are more certain to develop to maturity. With an excluder between, queen-cells, natural or artificial, may be ripened in the overhead body-box, so that when the division takes place queens may be well on the way to hatching.

An extensive bee-keeper has his own system of carrying out this plan in the following way: He takes out a frame of brood containing the queen, and places it in a new body-box with frames full of foundation. A queen-excluder on top of this confines the queen to this lower body, while the brood is placed bodily above this to hatch out and get sealed. On or after the eighth day this top body is carried away to a new site to make up the desired increase. This confining of the queen on a single comb in an otherwise empty hive must be carried out only in warm, settled weather, because otherwise

the bees might desert her. If nectar is flowing in, the lower frames are rapidly filled with fine fresh, new combs; but to secure this, if there is no flow, feeding may have to be attended to. The earlier this can be done, of course, the more certainty there is that surplus may not suffer materially. Another plan is: Withdraw the queen from a very strong colony—one that you can rely on as qualified to rear good queens—and in ten days, when the cells are all nearly ripe and all the brood fully sealed, proceed to make your division. Select two combs and place them in a new hive, shaking the bees from a third comb to strengthen these small lots. Confine them to their hive for about two days, and open the entrance late in the evening. Next day they will start work, and accept the new site on which they have been placed as their true home. While confined they have been making earnest efforts to effect their escape, and this helps them when they look out to a life of freedom in the morning to mark their location.

An *intensive* bee-keeper on a large scale watches until he finds queen-cells being built preparatory to swarming, and then shakes the bees and queen from the combs into a hive filled with either combs or foundation, preferably the latter. The box with brood is then placed over some moderately strong colonies for six or seven days to be taken care of, and at the end of that time placed closely contiguous to the other hive on a new bottom board, and both hives are so arranged as to get the flying bees about equally divided between them. Generally the shaken swarm, the weak colony strengthened, and the old brood body, now established by itself, make three strong lots. If number is the chief desideratum, he divides the brood-frames into two, thus making four. Queens are generally reared separately where desired to head any of these lots, but the started cells can also be used.

An up-to-date bee-keeper who believes in deposing his queens yearly, and rearing young ones to head all his stocks, does it in this way: About a week before the final winding-up of the late flow he kills off his queens wholesale, in order that he may have all queens young the following season. Ten days after, when cells have come to maturity, half of the bees and brood are taken out of as many colonies as desired, with adhering queen-cells, put into empty hives, and both sets of frames completed with empty combs from hives that may have died out in winter or spring. These colonies are soon headed by young queens. It is presumed that they will have about a week or ten days of a steady flow, but if this in any way fails they are given a quantity of stores for

winter, at the same time being kept breeding. Without killing off *all* queens yearly, this system may be practised on a limited scale; but up here it would fail frequently from the fact that queens would turn out drone-layers, owing to the changeable weather hindering them from mating.

The plans recorded above have all the same end in view. All desire increase, and only differ slightly in results, because at times the crop of honey is the chief desire, while in the other case the largest number possible of new colonies is aimed at, without studying how it affects the surplus. All can be worked about as successfully by the owner of two or three hives as by the man who runs as many hundreds.—D. M. M., Banff.

MID PIKE AND FELL.

THE "APIARY OF THE ROCK."

[7462.] Northwards to-day, northwards to Appleby, the capital of Westmorland: the town where, the chroniclers of old relate, so plentifully grew the apples that the Danish invaders settling here called the village Apple-bye, such being their affix for village. Apple blooms in yon rich meadow circled by the river, clover on the turf-land, and heather on the hillside: surely, even in those bygone days, it must have been a land of plenty for innumerable colonies of bees.

Three miles hence, at Brough, an old coaching town, now left stranded by the railway, the York-Carlisle road is reached. Roman soldiers held a fort on that hill where now the ruined castle stands. Roman legions have marched over the very track we are taking. Straight as an arrow they cut their roads, nor skirted hill nor avoided valley—alas! too straight for the cyclist, who groans as he mounts Brough Hill, where annually the Barnet Fair of the North is held, and the hardy Fell ponies are brought for sale. Now we are under the very brow of Roman Fell, of Dupton, and Merton Pikes, on our right, limestone-capped, chasm, river, hills, snow even now lying in their drifts,

Winter ling'ring in the lap of Spring.

Against their grey scaurs, grim and forbidding, the Atlantic clouds break, melt, and water the rich valleys lying on our left.

Now Appleby is below. A sharp "free wheel," and we are at the church of St. Michael. Stay! we have a call to make. Yon thatched cottage, just where the eternal red sandstone forms a wall solid and square to the road, is the "Apiary of the Rock."

Peering over the wall which bounds the slight ascent to the house, we see the quarry, deep and sheer, but ribboned with

green where fern and honeysuckle, wall-flower and moss cling to the cracks. I knock at the door, and am cheerfully invited to enter. I have but to announce the purpose of my visit: our mutual interest in the cult of the bee is a bond of brotherhood. Mr. Nelson, the proprietor of the cottage, a sturdy specimen of Westmorland manhood, welcomes me, and we are soon deep in bee-chat.

"Boy and man," he commences, "I have been a bee-keeper for nearly fifty years. My father kept bees in skeps, and we smothered those that weighed heaviest in the autumn. Then I had a bar-frame hive given to me, and bought a second. I attempted to drive a skep, and succeeded so well that I drove them all away, nor

budding out, what a view is before us! In the foreground Appleby Castle, scene of fierce combats of Sassenach and Scot, and in the distance the Lake Mountains, Skiddaw and Scawfell o'er-topping all. But Mrs. Nelson calls us to tea—to home-made scones, Westmorland fruit pasties, and cream. I note the antique furniture and the old china, but he is more proud of his trophies. "Six times have I won the Lord Lieutenant's cup and six times the Mayor's cup at rifle-shooting, and all those prizes have been won at flower shows and for honey, even so far away as Edinburgh and Derby."

But the day is drawing to a close and I have twelve miles to ride. The helm wind is rising over Cross Fell, and I needs



THE "APIARY OF THE ROCK."

saw them more. But one learns by experience. I have now fourteen hives in my bee-garden, and there is plenty of clover, and, later on, heather around, so we do well, and can sell all the honey we can produce. We keep our bees healthy by absolute cleanliness. Twice a year we scour the floorboards, which you will notice are numbered the same as the hives they belong to. Every frame I use I date when put in, and so know how old they are. I was for twenty-two years in the 2nd Volunteer Battalion of the Border Regiment, retiring with a long-service medal as sergeant. I know therefore the value of cleanliness in keeping health, and in all this my good wife, whom you see with me in this photograph of my apiary, helps."

Standing under the fruit trees, now just

must go. With a hearty shake of the hand I leave, not to forget for a long time the "Apiary of the Rock."

"But be sure to mention," is his last word, "how much my good wife has to do with all you have seen. She is as fond of the bees as I am."—J. SMALLWOOD.

SEASONABLE ADVICE.

[7463.] After a long spell of cold and wet weather, the opening days of the month of May have made quite a welcome change, bringing warm, genial weather, which bees have not been slow to take advantage of. At the time of writing they are in quite a merry mood, gathering nectar from the blossom of the plum and apple trees, the raspberry and gooseberry bushes, and pollen from the dandelion and what is left of the palm-willow.

A sharp look-out should be kept for robbers from other hives not overstocked with stores. Hives that have loose parts should be given a thorough spring cleaning. Take off the outer cases, and with a brush sweep all spiders' webs, &c., from the corners, and then gently lift off the brood-chamber from the floorboard, scrape off the dirt from the wood, and brush all dead bees, excrement, &c., on to a shovel, and burn it. If there are any old, mouldy combs, now is the time to remove them before they are filled with brood, and substitute either new foundation or good built-out combs. If food is short, gentle stimulation may be resorted to, but do not induce the bees to fill the combs with syrup at the expense of brood, as we require abundance of bees at the right time to take advantage of the clover honey-flow, which lasts only too short a time in the North, and even a few days' delay may cause one to lose it altogether. Those bee-keepers who do not work for clover honey—and there are not a few in the North—may with advantage work for increase, either by artificial or natural swarming. To the man who has not much time to look after his bees the former method is much to be preferred, and from personal experience I find it gives as good results as the natural method. Too often after the patient wife, or some other member of the family, has been watching for a day or two, and leaves her post for a few minutes, a fine swarm issues, and is lost, much to the chagrin of the bee-man when he comes home at night. With the artificial method he need not fear this, for when his stocks are divided and working merrily he can rest assured that there will be no swarming, and they will work up into strong colonies ready for the heather.

I am glad to see the short biographies and photos of prominent men in the Bee World who have helped to advance the craft to its present position, and whose example will be an inducement to the younger members to go and do likewise. I am sure the series will be read with great interest by all readers of the B.B.J.—W. S. WATSON, Southview, Wolsingham, Co. Durham.

BEEES RE-QUEENING THEMSELVES.

[7464.] In the issue of the BRITISH BEE JOURNAL of the 13th inst., on page 184, Mr. F. E. Matthews, Northfield, gives an instance of bees re-queening themselves. One of my stocks has done almost the same thing, but not until a little later. My queen, like his, was reared in 1907, and did very well last season. On April 15 I examined the hive, and found four frames, mostly sealed brood, also eggs. I transferred the stock into a

clean hive. A week later, on examining, there were no eggs, two sealed queen-cells, and five containing larvæ.

About April 26 the weather was too wet and cold to examine. On May 4 I found that the queen had hatched out, but there were no drones until a week later. The hive is very strong in bees, but up till to-day there have been no eggs. When can I reasonably expect to find them? The weather during this month has been fairly fine, but somewhat cool. Honey is coming in fairly fast.—D. ERNEST, Staunsted.

[Impregnation of the queen may be delayed without affecting her laying powers for twenty-one days after she leaves the cell, but if delayed beyond that time she usually lays eggs that produce drones, although exceptions do occur, and queens have been properly impregnated at thirty days. No doubt the cold weather has retarded the mating, but you may expect eggs forty-eight hours after she has mated.—ED.]

BEEES IN SOUTH HANTS.

[7465.] Although the season is a somewhat late one, my stocks are proving themselves more forward than the times. All have wintered well, including three driven lots of last autumn, hived separately. One of these lots, in fact, was the first to start breeding this year, judging from outside appearances. Several hives are ready for supers, and one which I discovered a week ago preparing to swarm I decided to let have their way. The swarm came off to-day in good numbers. Another hive yesterday I depleted of nearly all brood, and several others must be treated in the same way to make room for the queen to lay. The amount of brood is exceptional for the time of year. The apple-blossom is now bursting into bloom here, while earlier fruit-bloom has been out for the past fortnight. High winds in the daytime and cold nights have been prevalent during the week, but in spite of this drones were on the wing some days ago.

I visited a bee-keeper some eight or nine miles away to-day, and found his five hives much in the same condition as my own, and he was expecting a swarm or two within the week.

Given good, suitable weather, the season should be a bumper. Wishing all bee-keepers and yourselves a good harvest.—W. F., Havant, May 9.

BEEES IN WARWICKSHIRE.

[7466.] As I sit penning these few words in my dingy little hut—viz., the old wooden bee-shed—I feel a thrill of pleasure run through me at the splendid weather we are enjoying in this glorious

land of Britain, and every bee-man should feel the same pleasure as he watches his little workers going in and out of their hives with nectar and pollen for feeding their hungry brothers and sisters still in their helpless infancy, but who will be ready to do their share as soon as they are able. In the hive the females rule and work while the lazy males enjoy themselves and live on what the workers get. But being a man myself, though not a father, I will not say anything against the "lazy drone," as I have heard him called by some. I think of the pleasure I should have missed had there been no drones, for without them there could have been no females, and the honey-bee would cease to exist. Eh, brothers of the craft, I am sure you must agree with me if you have any love or tender feeling for your little labourers in the hive. Unfortunately this district of the picturesque county of Warwickshire is not a good one for honey, but I think one of my hives has made a record in it. Last May I bought from an advertiser in your paper, who lives in Erdington, a small colony of his non-swarming strain on three frames—one frame of brood and two of honey. On June 5, as advised by our local county expert, I put on this colony a rack of twenty-one sections, the bees by that time covering ten frames. On August 20 I took the rack off; twenty of the sections were well filled and one partly filled. They were so well filled that I exhibited twelve of these sections at the Warwickshire B.K.A. Show. I think this a record for a poor honey district like Erdington, which is only four and a half miles from the great city of Birmingham. All my bees are from the same strain, and I may say I am well pleased with them; they are English brown bees slightly crossed with a yellow race. I believe Mr. Sladen's "Golden British" is the yellow strain, as the gentleman I had them from used to keep Mr. Sladen's golden bees at one time, as well as the blacks. Unlike most hybrids, they are as gentle as flies, and unless hurt never sting. I have kept this strain of bees four years, and have only been stung by them three times.

Queen-excluder Zinc.—In such a bad honey district as this, when working for sections, we never use excluder, as we find the bees will not go through it well; therefore we always put the section-rack on without it. However, I am going to try this year the new wire excluder brought out by Mr. A. Wilkes, as it seems to be the very thing wanted, and it should be the excluder of the future.

"*British Bee-keeper's Guide Book.*"—I have just purchased the latest edition of this book, and must congratulate Mr. T. W. Cowan on the improvements it con-

tains. The older editions, of which I have two, are very good, and give all essential directions for bee-keeping; but the latest edition, enlarged and having more pictures (all photographs from Nature), I call the bee-keeper's *code micum*, and advise all, whether beginners or not, to get a copy if they have not already done so. I am sure they will not be disappointed, and I consider it worth three times the amount it costs.—WM. F. WIEMANN, Erdington.

AN EARLY SWARM.

[7467.] A swarm has come off to-day from a frame-hive which I manage, with others, for a lady in this district. The hive has not been stimulated by feeding, so I should think the queen is a very vigorous one. I am having the swarm myself, so it will be interesting to see what is secured from it in the way of surplus. Is this the first swarm this season? — THOMAS WELLS, Colchester, May 11.

[We have heard of several others this season; one issued on May 5.—ED.]

CAPPINGS OF COMB.

BY L. S. CRAWSHAW, NORTON, MALTON.

Spring Dwindling (page 156).—Is it too early as yet to ask "D. M. M." whether his fears for this year have been realised? It may be too early to boast, but I have been free from the trouble this spring, and several hives are at swarming-point.

"*Wax Craft*" (page 156).—Can there be any real difference between "American and English beeswax"? Why should Dr. Miller's wax be whiter than ours? His bees certainly are his own particular variety, but his crop is, like our own, from the white clover. But with us, selected cappings—*i.e.*, virgin wax—render a bright yellow, which colour will, however, eventually disappear upon bleaching. Mr. Cowan, in "Wax Craft," refers to the variation in readiness to bleach of different waxes, but England and N. America come under the one classification. Dr. Miller's wax is, however, white from the beginning. What, then, can be the cause of difference? Climate, perhaps, or wax-rendering methods. Would the Doctor tell us some more?

Rats (page 156).—I am assured that the most effective remedy yet discovered is known as the "Liverpool Virus." This produces a disease which is more or less progressive in its effect, and has been known to wipe out whole colonies of these vermin.

Queen-rearing (page 157).—I must say that I strongly agree with Mr. Thomas as

to the advisability for the queen-breeder to be a honey-producer. This is an association I have previously advocated aforetime, and it does seem to me to be very important that selection should be based upon results.

Suffocation (page 157).—Mr. Thomas's warning as to daubing the thorax of the queen on account of the spiracles seems at first sight to be a little superfluous. Less than a third—four out of fourteen—of these orifices are situate in the thorax, and they are not very accessible. Unless the honey were very thin, it would indeed seem difficult to choke them, protected as they are. This method of introduction, which, with apology, I may style the "daubiferous" or melliferous method, would not "do in a hurry," to quote Mr. Thomas, if the operator must attend until the intruder has suffered the initiatory licking, or, in fact, until her shortcoming has been smooth-tonguedly glossed over by the bees.

Aspen Pollen (page 165).—It would be interesting to ascertain the doings of the bees in the tree-tops, and this is no doubt where the aeroplane will one day assist our science! The novice may be glad to know that it is easy to ascertain whether a bee is obtaining pollen from the flower visited by its subsequent manœuvres. In this case it hovers in the air, facing the flower, whilst it transfers the pollen to its basket-legs before making another call. The brushing and scraping operations are very interesting.

Bee-law (page 166).—Claim to absconding swarms would seem to be about as satisfactory as claim to eggs which have been "laid away." In either case, something must depend upon the relations between the parties. The law says that you may claim your swarm if you keep it in sight, but does not guarantee you against action for trespass. Much legal thought was once expended on the problem of the peacock's egg, and I would like to submit to the same authorities a bee-problem in which the owner fails to satisfy the letter requirements of the law as to constant vision, but maintains that the bees are his own owing to his recognition of the clipped wing of the queen. It is admitted that no adjacent bee-keeper marks his queens in this way, but the neighbour upon whose land they are declines to relinquish, although conceding the identification. Can the owner legally establish his claim?

A Good Bee-district (page 167).—Mr. Towler shows much modesty in confining his inquiry to five counties with a trifling area of 6,000 square miles! Someone on the spot may be able to advise him! I can help him with regard to Yorkshire, if that is sufficiently "adjacent"! As to

"gardening, fruit-growing, poultry-rearing, pig- and bee-keeping," he might do worse than peruse Rider Haggard's "Rural England." But why keep the "pig" and the "bee" together? Any practical man will tell him that it is not the best way, and neither will do so well as when separately housed. But surely he need go no further than Hampshire, a county "famed for its honey"; and I would suggest to him that where sheep are reared in large numbers, and there is much permanent pasture, there he will find the white clover (*Trifolium repens*) at its best, and consequently a good bee-district. As to other sources of income. *Rumex aquaticus* is not mentioned specially in the bee-books, but if the bees work upon it Portsmouth itself may satisfy Mr. Towler's requirements, for this plant has been established and cultivated there by the Government on several hundred acres of most suitable property.

Sunstroke (page 167).—The real explanation of this affair "down under" on January 3 is that the bees had been letting the New Year in unwisely! The account reads as though the alighting-boards were so hot that the bees got their feet burned off, very much after the fashion of Casabianca. It will no doubt be remembered that—

... all but he had fled;
And when his feet were burned away,
He stood upon his head.

I am sure Mr. Bullamore would like to know whether these bees were black or yellow.

Knocking at the Door (page 175).—Mr. Avery does well to call this incident "memorable." If I remember aright, it was a reverend candidate who thus stirred up wrath. And it was this unfortunate examiner who was driven from the scene, with a headful of bees, to find a veil which could be decently drawn over the subsequent proceedings.

"Mid Pike and Fell" (page 178).—May we soon have some more of Mr. Smallwood's racy experiences. He must have already made some progress with our Northern dialects to be admitted to such fellowship. But he must be making fun of us with the hive inscriptions. The morals are so very pointed, as morals usually are. I suspect that he must be a wicked Tariff Reformer, or something equally dreadful; and which of the "neighbours" was robbing "the home of industry"? Not one of those mentioned would seem to have sufficient spirit, so that it must have had a Socialistic motto, and perhaps a portrait of the present Chancellor of the Exchequer!

Bee-tent (page 183).—One would indeed think that every man and woman in the U.K. who is interested in bees must

have seen the driving operation by now! Frame-hive demonstration may well claim more attention, and it is to be hoped that Mr. Woodley's excellent suggestion may bear fruit. In America they commonly do such—"stunts" I believe is the right word. Such operations as the fixing of supers, wiring and embedding foundation, extracting honey, &c., would certainly arouse interest. Extraction could be demonstrated with water, the combs being constantly refilled with a syringe.

Bee Shows to Come.

June 8 to 11, at Reading (Berkshire B.K.A.).—Show of Honey in connection with the Annual Exhibition of the Royal Counties Agricultural Society. Over £30 in prizes. Schedules from D. W. Bishop-Ackerman, Hon. Sec., Berks B.K.A., 161, King's Road, Reading. **Entries close May 22.**

June 22 to 26, at Gloucester (Royal Agricultural Society's Show).—Bee and Honey Section under the management of the B.B.K.A. Prizes arranged in groups of counties for Associations affiliated to the B.B.K.A. Schedules from E. H. Young, Secretary, B.B.K.A., 12, Hanover Square, London. **Entries close May 31.**

July 15 and 16, at Louth.—Show of Honey, Hives, and Bee-appliances in connection with the Lincs Agricultural Society, Bee-department under management of the Lincs B.K.A. Schedules from J. Hadfield, Hon. Sec., Lincs B.K.A., Alford, Lincs. **Entries close June 11.**

August 4 and 5, at Abingdon Park, Northampton.—Honey Show of the Northants B.K.A. Special prizes for open classes, including one for single 1-lb. jar honey. (Entry free.) Prizes 20s., 10s., 7s. 6d., and 2s. 6d. Schedules from R. Heford, Hon. Sec., Kingsthorpe, Northants. **Entries close July 28.**

August 10 to 12, at Beverley.—Show of Honey, &c., in connection with the Royal Yorkshire Agricultural Society. Schedules and form of entry from John Maughan, Secretary, Blake Street, York. **Entries close July 3.**

"ROYAL COUNTIES" SHOW AT READING.

We have been asked to inform readers that, owing to the small number of exhibits entered in the honey section of the above show, it has been decided to extend the time before closing entries until May 22.

Queries and Replies.

[3931.] *Re-queening by Artificial Swarming.*—I have a stock headed by a queen in her third year. The queen has been a very good one, and I wish to make the bees re-queen themselves in order to retain her good qualities, and yet I do not want to lose a single day's laying if it is possible to manage without. I have thought of a plan for doing this, but would like to have your opinion on its merits before attempting to carry it out, as there might possibly be some flaw which I am unaware of. My intention is to form an artificial swarm as soon as it is safe to do so by taking out the comb with the queen on and placing it, along with frames fitted with foundation, in a new hive on the old stand, and moving the old hive about a yard away. The old stock would then, of course, raise queen-cells. On a fine day, after the new queen was mated and had commenced to lay worker-eggs, I should return the old stock to the original stand, and place the artificial swarm some

distance away. After the majority of the bees had returned to the original stand I should kill the old queen, which would then be easy to find, and place the hive on top of the original stock with an excluder between them. If the scheme is feasible, I should like your advice on the following points: 1. Would it be safe to leave the original stock quite alone until the queen commenced to lay, or would it be necessary to cut out all the queen-cells but one? If this was necessary, when would be the best time to do so? 2. How long would it be advisable to leave the swarm after moving it to a distance? Or would it perhaps be better to place the swarm on top of the old stock without moving it to a distance, of course first taking the precaution to kill the old queen? 3. If it was desired to use shallow frames in the super instead of standard frames, would it be right to shake a bar or two of bees with the old queen in front of the hive instead of removing a frame from the old stock? 4. Would this plan effectually prevent swarming if the final operation were carried out at the commencement of the honey-flow?—W. E. B., Manchester.

REPLY.—1. You would have to cut out all the queen-cells but one eight days after they are commenced. 2. It would be nineteen to twenty days before the queen could fly out to be fertilised from the time the egg was laid, and another couple of days before she began to lay, so that you would have to unite the swarm with the old hive after that time. Your artificial swarm would have become a stock by then, and would have to be treated as such, the usual precautions being taken in uniting (see page 105 of "Guide Book"). 3. No, not if your object is to make an artificial swarm in the super without combs of brood. 4. Nos. 1 and 2 would do so if the artificial swarm is made at the right time and all queen-cells but one removed.

[3932.] *Dealing with Fertile Workers.*—1. I shall be much obliged if you can tell me whether the enclosed comb contains foul brood or chilled brood. 2. Also whether the bee is a queen or a worker, which I found on the floor of the hive. 3. The colony is queenless, and about a week ago we gave the bees a frame containing brood and eggs from another very strong hive, to enable them to raise a queen. They have a good many drones, also drone-brood, sealed, rather patchy, and we suspect a fertile worker. They have not begun to build a queen-cell yet on the brood we gave them, and the enclosed comb was taken from the latter. Was it chilled in moving from one hive to another? And can we do anything to make them raise a queen?—C. W. STACEY, Tonbridge.

REPLY.—1. The comb contains incipient foul brood; for treatment see "Guide Book," page 180. 2. The bee sent is an immature drone. 3. If the drone-brood is patchy, the probability is that a fertile worker is laying. Generally a hive having a fertile worker is perfectly demoralised, and will not raise queen-cells or accept another queen while the fertile worker is present. The only way is to break up the colony, dividing it among strong cues having fertile queens (see "Guide Book," page 123).

Notices to Correspondents.

Buckwheat Honey.—The Rev. R. M. Lamb, Burton Pidsea Rectory, Hull, asks where he can get a little buckwheat honey. Will any of our correspondents who have specimens communicate with him?

R. MASSAM (Lincoln).—*Moving Bees to Bean-fields.*—It would not be worth doing if there is pasture within two miles of your apiary.

G. GRAY (Hollensburg).—*Dead Bees.*—The bees found on alighting-board and ground appear to have been starved.

CHESHAM (Bucks).—Bees Deserting Hive.—There is nothing in comb sent to account for the bees deserting hive. In doubtful cases of disease it is quite right to take the usual precautions as to destruction of combs and disinfection of hives, and as in your case wax-moth had taken possession, you have proceeded correctly.

WORKINGHAM (Berks).—Bee-diagrams.—The diagrams mentioned in "Guide Book," 1894, were published by the B.B.K.A., and are now out of print.

A. B. EVANS (Gloucester).—Observatory-hive for School Exhibit.—If you apply to Mr. E. J. Burti, Stroud Road, Gloucester, he will no doubt arrange what you require for your school exhibit.

G. (Royston, Herts).—Chloride of Lime and Foul Brood.—The proportions are not mentioned, but we should judge from the amount of chlorine gas given off during evaporation a very small dose should be used. We should certainly expect honey to be spoilt in flavour by it, and would hesitate to use it where bees were working in supers.

F. G. PHIPPS (Herts).—Raising Queen in May.—1. The comb is cut away close to the cells containing the eggs or larvae desired for queen. You can enlarge the mouth of any particular cell you wish the bees to start upon with a piece of wood in the shape of a cone in such a way as to break down the walls of adjoining cells. 2. The comb is quite empty, and it is evident that the bees have died of starvation.

S. J. BADCOCK (Sussex).—"Swarthmore" Plan of Queen-rearing.—The late Mr. Prait published two works on this subject—one "Commercial Queen-rearing," price 2s.; and the other "Simplified Queen-rearing," price 1s. Both these books can be had from B.B.J. office.

Honey Samples.

S. J. B. (Sevenoaks).—No. 1 is very good in colour, but too thin to be classed as a first-class honey; the flavour and aroma are also only fair. **No. 2** is a very good honey, much better in flavour than No. 1.

Suspected Combs.

XIMENES (Hants).—Mild type of foul brood, not in an advanced stage. Follow treatment recommended on page 179 of "Guide Book."

STEEL (Sheffield).—There are traces of foul brood in one of the worker-cells. As the comb contains only drone-brood, examine the hive and ascertain if there is also worker-brood, a specimen of which should be sent. The appearance of the drone-brood on comb sent suggests the presence of a fertile worker.

F. D. E. (London, S.E.).—Recent outbreak of foul brood, not yet in spore condition.

NEVILLE (Yorks.).—Comb is badly affected with foul brood. The bees will affect the stock to which they were united, and should be fed with medicated syrup, a careful look-out being kept for signs of the disease in the united stock. If foul brood can be detected when in incipient stage it can be cured without destroying the bees, but almost invariably combs and frames should be burnt.

X. Y. Z. (Hants).—Comb is affected with foul brood, not of long standing. Burn frames and combs, treating bees as directed in "Guide Book."

E. C. S. (Yorks).—Comb affected with foul brood. There is a dent on the second abdominal ring of queen, otherwise there is nothing the matter with her.

ANXIOTS (Llanidloes) and W. MARSHALL (Leicester).—Foul brood. Treat as recommended on pages 179 and 180 of "Guide Book."

Special Prepaid Advertisements.

Twelve words and under, Sixpence; for every additional Three words or under, One Penny.

QUEENS, Doolittle's Famous Strain.—Customer writing May 5th says: "The Golden Virgin had last season was wintered on 4 frames, now cover 10 frames, packed to overflowing; shall have to give another set of 10 frames on top to give queen room, as our honey season will not be on yet." Is not this what all bee-keepers want? Hives boiling over before the honey flow arrives. Virgins now ready, 1s. 6d.; Fertiles shortly, 5s. each.—D. TAYLOR, Ilminster. q 12

GOOD NATURAL SWARMS FOR SALE, 10s. each.—HOLLEWORTH, Widmerpool, Notts. q 11

HEALTHY SWARMS, best strain, 14s., Deposit, guaranteed safe arrival. My 40 Stocks can be inspected by appointment.—P. HANSEN, gardener and bee expert, 3, Gladstone-cottages, Norwood Green, Southall, Middlesex. q 10

3 SEMI-OBSERVATORY NUCLEUS HIVES, dovetailed, 2 with frames complete. What offers in Bees? or sell.—STONELY, Wrexham. q 9

WANTED, guaranteed strong, healthy Swarms of Bees.—REDNALL, Chester-road, Erdington, Birmingham. q 8

FOR SALE, two 1908 Queens, 3s. 6d., cash, post free.—ROUSE, Rochford, Tenbury. q 7

SELL, or exchange Bee Appliances, Silver Lustre Teapot, Queen Anne shape, slight crack, otherwise perfect, 12s. 6d.; Golden Lustre Jug, figures in relief, decorated blue enamel; both antique.—BOUSFIELD, Woodbine Cottage, Hartley, Kirby Stephen. q 6

33RD YEAR.—NUCLEI, 3 Frames (wired), Bees, Brood, and Queen, 12s. 6d.; Empties, 1s. 9d., or returned carriage paid.—ALSFORD, Expert, Haydon, Sherborne. q 5

VIRGINS, Sladen's strains, 2s., three 5s. 6d.; Fertiles (shortly), 5s. 6d. Orders rotation.—PAUL, Salisbury-road, Bexley. q 4

3 STOCKS, 5 Frame Hives, Extractor, and all complete, giving up bee-keeping.—SWAINE, Well View, Barnsley. q 3

FOR SALE, a few Swarms of Bees, May and June, at 2s. lb., guaranteed free from Foul Brood.—W. HAMBROOK, Church Farm, Newington, near Sittingbourne. q 2

BEE APPLIANCES, cheap.—Frame Hives, from 7s.; Straw Skeps, hole in top, 1s. 3d.; Section Crates, complete, 2s.; Smokers, 2s. 6d.; Extractors, 7d.; Wax Moulds, 1s. 6d.; Metal Ends, 2s. gross; Spring Travelling Section Crates, 2s.; Bottle Crates, 1s. 6d.; Bee Escapes, 3d.; Board complete, 1s.; Naphthaline, 1s. box 6d.; Show Cases, for Shallow Frames, 1s.; Bee-gloves, 2s. 8d.—Particulars, KENT, Bee Appliance Works, Dorchester. q 1

WELLS' HIVE, one Single Hive. What offers in Swarms?—MARSHALL, 68, Chelmsford-street, Lincoln. p 98

WANTED, anything for the Apiary, in exchange for Harmsworth's "History of the World," value 25s.—H. ROE, Stanley-street, Ramsbottom, Lancashire. p 97

EXCHANGE LADY'S CYCLE, New Rapid, Palmer Tyres, not ridden 200 miles, for Swarms or Stocks.—WILLIAMS, Vange, Pitsea. q 13

FINISHING SIX HIVES, well made and painted, exchange three for two Swarms or Skeps, or two for good Stock on Frames.—77, Ladywood-road, Birmingham. q 15

14 REASONS WHY TILLEY'S IMPROVED PATENT "WON'T LEAK" SECTIONS SHOULD BE USED BY ALL BEE-KEEPERS, post free; sample and instructions, post paid 6d.; complete Super, with 9 2-lb. patent Sections, 4s. 6d., on rail. Order now to prevent disappointment. Particulars of Tilley's registered Damp-proof Hive, painting not necessary, ready shortly. The outcome of upwards of forty years' practical Bee-keeping.—M. H. TILLEY, Bee Farm, Dorchester. p 99

Editorial, Notices, &c.

FOUL BROOD AND CHLORIDE OF LIME.

In the B.B.J. of May 6, on page 171, there appeared, among "Reviews of Foreign Bee-Journals," a notice respecting a foul-brood cure by means of chloride of lime reported in *L'Apiculture Nouvelle*. No proportions were mentioned, and we have had inquiries respecting its use. We have, therefore, tried the effect of this substance on bees, and find that the very small quantity put in a linen bag which we placed in a stronghive excited the bees to such an extent that they commenced a stampede, and would have promptly left the hive had not the chloride of lime been removed. We do not know what effect it would have on weak colonies, but we have just received a report of a trial made which ended disastrously (see page 205), so that we must conclude that either the dose was too strong or our commercial chloride of lime is different from that used in France. We would, therefore, warn our readers to be cautious in the use of this powerful disinfectant, and except for experimental purposes to leave it alone.

BRITISH BEE-KEEPERS' ASSOCIATION

A meeting of the Council was held at 105, Jermyn Street, S.W., on Thursday, May 20. Present:—Mr. T. W. Cowan (in the chair), Mr. Thos. Bevan, Mr. C. L. M. Eales, Mr. O. R. Frankenstein, Mr. E. Garcke, Mr. James Grimwood, Mr. J. B. Lamb, Mr. Arnold Richards, and the Secretary.

Letters or telegrams of regret for absence were read from Miss Gayton, Mr. G. W. Avery, Mr. Geo. Hayes, Mr. Wm. Richards, Mr. A. G. Pugh, and Mr. Ernest Walker.

The minutes of the previous meeting were read and confirmed. Thirteen new members were elected, viz.:—Mr. Richard Bayly, Torr, Plymouth; Mr. W. G. Beach, 32, Pembury Road, Tonbridge; Mr. Henry Crowe, York House, Central Avenue, Wigston, Leicester; Mr. F. W. Folds, The Wandon End Apiary, near Luton, Beds; Miss Violet Gregory, The Rectory, Much Hadham; the Rev. Percival H. E. Wilder, B.A., Howe Rectory, Norwich; Mr. Reginald S. James, Mill Hill, N.W.; Mr. H. Osborn Morgan, 32, St. Michael's Park, Bristol; Mr. Rodway Stephens, Russell Lane, Whetstone, N.; Mr. Ernest L. Stroud, F.R.C.V.S., Grove House, Southall, Middlesex; Mr. G. Tudor-Williams, Cynon Cottage, Aberdare; Mr. J. Turner, Post Office, Dadworth Green, Windsor; and Mr. E. W. Zehetmayr, Belle View, St. Margaret's, Twickenham.

Mr. Eales, Mr. Frankenstein, Mr. Grimwood, and Mr. Richards were introduced

and welcomed by the Chairman on their first attendance as members of the Council. They severally acknowledged the welcome.

The report of the Finance Committee was presented and adopted.

Mr. J. B. Lamb, on behalf of the Special Appeal Committee, reported that 750 appeals had been issued to persons who were considered to be probable subscribers and to the City Companies. The response was just coming in, the amount received or promised to date being £8 16s. 6d., of which £1 consisted of new subscriptions and £2 0s. 6d. of increased subscriptions. One gentleman wrote as follows:—"I have kept bees to my great delight for fifteen years. I have always meant to join the B.B.K.A., but somehow always put it off. However, I now enclose my 5s. and a donation of £3 15s., which is 5s. for each year I have kept bees."

Arising out of the appeal, a discussion took place on means of extending the work of the Association. It was resolved to further discuss the question at a special meeting of the Council, Mr. Garcke undertaking to formulate a scheme to be laid before that meeting. A letter bearing on this question was read from the Rev. A. Downes-Shaw.

A letter was read from the Dairy Show authorities stating that, in view of the fact that the support of the B.B.K.A. in the Honey Department of the Dairy Show had extended over so many years, the Council had decided for this year to continue the classes as before, and to keep the entry fee at 2s. 6d. to all comers. The Secretary was instructed to express great satisfaction at this decision.

The Secretary reported that arrangements had been made with Messrs. Abbott Bros. and Messrs. Jas. Lee and Son to jointly furnish an exhibit relating to bee-culture at the Imperial Exhibition at Shepherd's Bush, the requisite space having been obtained by the Association.

The Secretary reported that eight candidates had entered for the first-class examination, and that the papers had been placed in the hands of the examiners.

On the recommendation of the examiner, it was resolved to award third-class expert certificates to Mr. Wm. Geo. Beach and Mr. Jas. Turner.

Numerous applications for examinations for third-class certificates were received, and the proposed arrangements sanctioned by the Council.

A voluminous correspondence from bee-keepers' associations in South Africa was read; and as it appeared that one of the Society's experts, Miss M. D. Sillar, now in South Africa, is about to visit England, a sub-committee was appointed to confer with her.

The next meeting of the Council was fixed to be held on Thursday, July 15.

"ROYAL" SHOW AT GLOUCESTER.

The cold and adverse weather experienced in early spring, together with the poor season of 1908, has had a bad effect upon the prospects of the "Royal" Show this year. Entries have not been made to the extent anticipated, and we are asked to remind our readers that there are only a few more days before May 31, the closing date at which they can be accepted. We therefore urge bee-keepers to apply at once for schedules, and assist the B.B.K.A. in their endeavour to keep honey and bees before the eye of the multitudes who attend this show. It seems, to our mind, to show a lack of public spirit on the part of bee-keepers that these annual appeals for entries should be necessary. Surely they realise that it is for their advantage that bee and honey exhibitions are held, and if our craft is badly represented at the most important agricultural show held in this country, the bee-industry will suffer loss of prestige just at the time when its importance is beginning to be recognised by the Press and the general public. It is not yet too late to make the "Royal" a record show. Honey is coming in rapidly, and even if at the last moment one is unable to stage an exhibit, it is worth entering on the chance of securing some first-class "stuff" which will carry off a good award.

W. B. CARR MEMORIAL FUND.

	£	s.	d.
Amount already acknowledged	41	16	0
H. Jonas	5	5	0
Geo. Hayes	0	5	0
G. W. Bullamore	0	5	0
A. G. Pugh	0	5	0
A. T. Tew	0	2	6
W. Henson	0	2	6
R. S. Williams	0	2	6
J. Cunningham	0	1	0
C. Reed	0	1	0
	£48	5	6

Correspondence.

The Editor does not hold himself responsible for the opinions expressed by correspondents. No notice will be taken of anonymous communications, and correspondents are requested to write on one side of the paper only, and give their real names and addresses, not necessarily for publication, but as a guarantee of good faith. Illustrations should be drawn on separate pieces of paper. We do not undertake to return rejected communications.

BRITISH BEE-KEEPERS' ASSOCIATION

[7468.] The appeal issued by the above Association in the JOURNAL of the 13th inst. should certainly demand our serious attention, and I for one was certainly looking for some general discussion with

respect to the work and present financial condition of the British Bee-keepers' Association.

Any person who takes an interest in bee-keeping would at once acknowledge that bee-keepers of to-day owe their present position almost entirely to the work carried on by the Association, but the fact that it has now become necessary to make a general appeal for funds should, I think, cause us to consider if the time has not arrived when a thorough re-organisation of the Association should take place.

Those who consider that the organisation of bee-keepers in the British Isles is adequate I would recommend to read again the report of the discussion which took place on the paper read by Mr. Gareke at the annual meeting of the Association, March 19, 1908 (*vide* B.B.J., March 26, April 2 and 9, 1908), which they would find most instructive.

At the present time it is estimated that there are ninety to a hundred thousand bee-keepers in the British Isles, so it must be admitted by all that if each one of these were a member of the British Bee-keepers' Association, and subscribed only 1s. per annum, we should immediately possess a strong financial Association, with an income of from £4,500 to £5,000 a year, in the place of our present Association with a dwindling yearly income of about £150.

In order to bring about a better result I would make the following suggestions:—

1. That we have one organisation only, known as the British Bee-keepers' Association, with a head office in London.

2. That county associations cease to exist merely as county associations, and become instead branches of the one organisation.

3. That where no county associations exist at the present time these counties should be apportioned to the adjoining counties where organisations now exist.

4. That the whole of the income received by the county branches be paid over to the head office in London, which would be the centre of the Association.

5. That county branches should organise district associations, these district associations to be able to give an account of every bee-keeper in their districts.

6. That district associations appoint delegates to represent them on the committee of the county branch in proportion to the income and membership of the district association.

7. That county branches appoint delegates to the executive council of the central organisation in London in proportion to members and subscription income of the branch.

To illustrate the result of the above

suggestions if put into force, let us take the Surrey Bee-keepers' Association. It would cease to exist, and would become the British Bee-keepers' Association—Surrey Branch. It would, of course, still retain its president and vice-presidents, so as to make it as strong locally as possible. The present executive council would meet and decide what district associations should be formed, so that every district in the county might be absolutely covered, and as soon as the district associations were properly organised the executive would disband, although probably the same gentlemen would appear again on the branch committee, being appointed as district delegates. Assuming that Surrey were divided into twelve districts, each district would appoint one or more delegates, according to the membership and the amount subscribed by the district; these delegates would form the committee for the Surrey branch, who in their turn would appoint delegates for the executive council of the central organisation. All subscriptions received by the district associations would be handed to the committee of the county branch, who would forward them to the head office. All local expenditure would first have to be approved of by the county committee, who would apply to the central organisation for the amount required; this would soon become a matter of routine, providing grants for regular purposes.

One of the most important points in the reorganisation scheme would be the reconstruction of the head office. This would be the centre of the Association and the home of the executive council, who would be responsible for the grants to be obtained from the various County Councils, would organise shows, generally direct the policy of the county branches, and assist in the organisation of the district associations.

For the head office it would be necessary for us to have a building of our own in a good position in London; this building to contain a thoroughly up-to-date library, a club and writing room, also class-rooms and a lecture-hall. As a means of revenue, part of the building could be used for a permanent exhibition of bee-hives and appliances—not for sale, but so that any bee-keeper coming to London could make a careful examination of any manufacturer's appliances and form his own opinion of them. For members who wished to make regular use of the club-room and library a special subscription would be required, but any member of a district association bringing a letter of introduction from its secretary could make use of the club and library at least twice a year without extra charge. Regular classes would be

held for those wishing to qualify for expert certificates; also popular lectures would be given, for which charges for admission could be made.

The above suggestions are put forward in a very crude form in the hope that those better able to deal with this matter than the writer will take it seriously in hand.

Mr. Garecke, in his paper referred to at the beginning of this letter, states that if all the counties of England, Scotland, and Wales could be brought up to the average standard of the Cumberland and Lincoln Associations we should have over 56,000 members, which, at an average subscription of only 2s. 6d. per annum, would yield a gross revenue of £7,000, and surely, with properly organised district associations, this is not in the least an impossible task.

Let us remember that we have some master minds, such as Lord Avebury and others, who take a practical interest in apiculture, and now that the Association is passing through a critical period let us seek their co-operation and support, so that the British Bee-keepers' Association may become such an organisation that every bee-keeper may be proud to be connected with it.—GEORGE HEBURN, Sutton, Surrey.

ROSS-SHIRE NOTES.

[7469.] In contrast to the condition of stocks at this time last year, bees are in flourishing condition, strong colonies being the rule, weaklings the exception. Stores are running short, however, and occasional supplies of sweetened water will be necessary until white clover blooms. Italians, as usual, are leading, with the new "Banat" bees a good second.

Rapid Increase.—In making three stocks from two a populous colony is shaken on to foundation, then fed and tended like a swarm. The removed combs—a mass of brood—are placed above another colony, thus giving the queen the run of twenty frames. The large brood-area puts her majesty on her mettle, and ovipositing is greatly accelerated. Then, as the honey-flow is in sight, ten selected frames of sealed brood with adhering bees are removed to a new stand, and a fertile queen given after the usual interval.

The Dual-Queen System.—Having had some success with this plan at the heather. I am now trying it with a view to building up extra-strong colonies for the clover-flow. Double-story colonies were selected, and early this month a small nucleus was made from each. The nucleus was placed close on to the brood-nest of its parent stock and warmly wrapped up in the quilting, an auger-hole through the lift acting as entrance.

Fed at intervals, and occasionally strengthened by combs of brood from below, the nurslings are making remarkable progress.

I have seen it stated that two queens in a hive is poor business, as one good queen can produce all the eggs the colony is able to care for. This is true as regards spring, when weather is cold and hives bare of bees. But in the few weeks preceding the honey-flow conditions are different, and a small number of bees can take care of much brood. If we get more brood now, we get more bees for the July honey harvest. Say a good queen can lay 3,000 eggs per day and an extra-prolific one a third more. Having two queens laying in one hive means securing 50 per cent. more brood than could be had otherwise, and, theoretically, should increase the weight of surplus to a like extent.

My experiment at the heather resulted in a yield of almost one-half more than the average; but in running extra-powerful colonies for sections during the clover harvest swarming has to be reckoned with.—J. M. ELLIS, Ussie Valley.

THE B.B.J. AS AN ADVERTISING MEDIUM.

[7470.] As a buyer of bees, I can fully endorse Mr. H. F. Grimes's letter on page 166 as to the value of the B.B.J. as an advertising medium; but in my opinion he proves several other points, to which, with your kind permission, I will briefly refer.

First, Mr. Grimes has discovered a fact well known to our worthy Editor and to all appliance dealers—namely, that bees are a marketable commodity, and that if no demand exists in the particular locality where the apiary is situated, then an advertisement in the B.B.J. will bring applications from north, south, east, and west.

Secondly, he has also found out what everyone in the trade knows, that bees are scarce this spring, and at present there are more buyers than sellers, and therefore, by the law of supply and demand, bees are dear and eagerly sought after.

There are several reasons for scarcity: The Arctic weather last spring (see B.B.J., May 7, 1908, page 187)—this killed many stocks; the almost total absence of swarms during swarming season 1908; and the increased demand, owing to the growing popularity of bee-keeping. It is noteworthy that the great interest in bees, now shown in many ways, is not amongst those whom, living in the country, by the favourable position of their homes and by reason of the missionary work done by the parent and

affiliated associations, we anticipated would take up bee-keeping. By this I refer to the cottager of this our highly-favoured land; he, speaking generally, is not interested in apiculture. But the increased interest is shown by those who earn their living in our great cities, and who keep bees in their country or suburban homes.

My experience leads me to the conclusion that even amongst experienced bee-keepers the preparation for packing of bees for transit by rail is not understood, and the plain directions in the "Guide Book," pages 116 to 120, are not carried out.

During the last few weeks I have received skeps in same position as when on their stands, all ventilation stopped, combs broken down, and with honey running out; also stocks in travelling-boxes received with so little attention to ventilation that the bees must have endured a veritable "Black Hole of Calcutta." Further, so many frames have broken down—that is, come away from top bars—that I would like to add a word of advice to those who send bees by rail. They should remember that railway porters are frightened of bees, and the present system of hurriedly rolling boxes out of guard-vans—not carefully lifting—makes it imperative that all frames have a fine pin driven through each joint, and when foundation is fixed frames should invariably be wired. I am not seeking a free advertisement; it is a pleasure to pay your reasonable charges, so I enclose my card and sign myself—A BUYER OF BEES, Notts.

A PROMISING OUTLOOK.

[7471.] I thought it might interest the readers of B.B.J. to know that I examined all my hives yesterday, and found them in such perfect condition that I should like to know if any other bee-keeper situated not too far south of my apiary has twelve hives in such capital condition. No. 1 has eight frames of brood and two partly full; No. 2, "Combination" hive, twelve frames of brood top to bottom and three partly full; Nos. 3, 4, 5, 6, and 7, each with ten frames full, except one side of the two outside frames; No. 8, which was a late swarm, two frames of honey and six full of brood, with two partly full; Nos. 9, 10, 11, and 12, just as satisfactory as the others. During the week I hope, if I have time, to put the supers on, and as I have about five acres of raspberries twenty yards away, an eighteen-acre field of hay containing a good percentage of white clover just at the back of the hives over the fence, and less than a quarter of a mile off a ten-acre field of clean white clover

to be left for seed, I hope to reap a good harvest, weather permitting. We had 11 deg. of frost here last night, so the bees will not have a superfluous quantity of bloom to work on, as many of the buds are already nipped. Hoping brother bee-keepers will have as successful a year as I am looking forward to.—B. J. MITCHELL, Norfolk, May 16.

EAST ANGLIAN OBSERVATIONS.

[7472.] *Early Swarms.*—Two swarms were recorded in Suffolk on May 13, being the first I have heard of in the county. Many stocks are busily preparing for the same performance, and queen-cells have been found galore.

Roll-call (page 178).—Yes; the majority of stocks in East Anglia have come through the winter well, and are in excellent condition. Weak lots in some cases succumbed. The best I have seen (an eleven-framed hive) contained ten frames of brood.

Early Honey.—Sections and shallow frames have been placed on many hives, and honey is being stored. Chief sources are fruit-blossom in abundance, chestnuts, and turnip. I have seen bees busy on dandelion too.

Wax-moth.—This is very prevalent in places. One bee-keeper used over 1 lb. of crude naphthaline to ten hives; result, nearly all brood dead.—A. W. SALMON, Hon. Sec. S.B.K.A., Cashfield House, Chingford, May 16.

REMOVING BEES.

[7473.] In most of the guide-books we are told that a stock of bees cannot be moved less than two miles away at this season. It may interest your readers to hear how I moved a stock less than half a mile. The entrance was secured with a piece of perforated zinc, and the hive taken (at night) to a dark, cool room and covered over. After leaving the bees for two days in this state, I took them out to their permanent position. The sun was shining brightly, and the busy creatures were soon hard at work bringing in pollen, &c. Only about fifteen bees returned to the old site. I consider this rather a success.—K. PAYNE, Erdington.

BEES AND DAISIES.

[7474.] I saw numbers of bees working on the common field daisies here yesterday. Can you say if they get honey or pollen, or both, from these flowers? So far as I could see, they gathered honey only.

Bees are very forward in this part of Essex for the time of year. I have never seen them in better condition, and with

such favourable weather and a good shower of rain occasionally we ought to make up for the last two poor seasons. I hope it may be so. Most good bee-keepers here have already put sections or shallow bars on the best stocks, and those not quite so strong will be ready for supering next week, if all goes well. I have lost one queen only out of twenty during the past winter.

I hope many of those bee-keepers not blessed with a superabundance of this world's goods will act on Mr. Herrod's suggestion and send the humble shilling to help to swell the W. B. Carr Memorial Fund. I enclose mine, and sign myself—THIRD-CLASS EXPERT, Wickford, Essex, May 18.

FOUL-BROOD CURE.

[7475.] As a beginner in bee-keeping, this being my third season—I joined the county B.K.A. on May 15—I was visited by the expert, who gave me a lot of useful hints, and pronounced one of my hives to be suffering from foul brood. I was told to procure some tabloids and place them in the hive. Having read of the foul-brood cure in B.B.J. of May 6 (page 171), and being over-anxious about my bees, I placed a false bottom under the frames, sprinkled chloride of lime on the bottom, and put a queen-excluder above to form a floor, so that the bees should not come in contact with the lime. On the morning of May 20 my tabloids arrived at noon, and on the morning of May 21 I went to place them in the hive and found the whole stock dead—they had fallen from the frames. I would advise "G., Royston, Herts," not to try the cure.—W. BROWN.

VARIABLE WEATHER.

[7476.] It is evident from reports in the B.B.J. that conditions of weather and bees vary in a more remarkable degree than usual in various parts of the country. I am receiving orders daily for candy, and complaints as to cold and wet weather and late season. Here in Liverpool it has been very cold till this Thursday, and much too dry—no rain for weeks past.

I thought these facts would interest you, and I also write to ask for more care by customers when ordering goods. We have four orders we are unable to execute for want of name or address.—GEORGE ROSE, Liverpool, May 21.

HIVE-CONSTRUCTION.

[7477.] The best covering for hive-roofs is sound yellow deal or Canadian pine. It must, however, be all heart wood. As an experiment in proof of this,

let anyone select a piece of sap wood and another of heart wood, both perfectly dry; weigh each, and then place them both in water for two or three hours. On again weighing it will be found the sap wood has absorbed water like a sponge. I have hive-roofs of sound deal which have been in use over fifteen years; they are now as sound as when made, and have only once been painted since new.—A. HARRIS, Wavendon, Beds.

AMERICAN AND COLONIAL PAPERS.

EXTRACTS AND COMMENTS.

By D. M. Macdonald, Banff.

From "*Gleanings*."—Mr. Hoeterman recommends bee-keepers to procure copies of a very fine lithograph plate which illustrates in natural colours a brood-comb with the cells affected with foul brood, as it will have great educational advantages. The latest edition of the "*Guide Book*" (page 173) reproduces an excellent untouched photo from Nature of a foul-brood comb.

Messrs. Root have such faith in alsike clover that they supply "free seed to farmers sowing it within one-fourth of a mile of their apiaries, and for all distances up to one mile they furnish it at half-price," and they consider "if we can get farmers educated to appreciate its value, locations will become much more valuable. When both alsike and white clover yield the season is a 'hummer.'" I think its value is under-estimated here. Farmers would be doing themselves a good turn as well as serving us by sowing it more liberally.

A new way for dispelling robbers is given us from Texas: "Instead of going to the trouble of smoking the bees, contracting the entrance, &c., simply give the hive being robbed a vigorous kick or two. This results in stirring up the bees, and they come out with a rush, and pounce on every bee in sight, and a vigorous fight is kept up against the robbers."

Shipping cases of corrugated paper are strongly recommended by Mr. Crane, and he prophesies that they will supplant the wooden cases entirely. "They make breakage," he says, "almost impossible by twisting, stepping on them, or even dropping them."

From "*Canadian Bee Journal*."—In a recent extract I ventured the assertion that simple *shaking* is insufficient to clear out the dregs of foul brood. The editor in March issue quotes me, and says, "I entirely disagree with you." I, in turn, disagree with his pronouncement, and give emphatic testimony from this and the other side in support of my contention. Dr. White, expert in bacteriology,

in April *Gleanings*, says: "Use no bee-supplies from an infected apiary unless they are thoroughly disinfected." Just what I said. "It is always safer to allow the bees to go into a new hive or a hive which has been thoroughly disinfected." Just what Mr. Cowan has ever taught. Mr. Root is equally emphatic on this feature. His words are: "Too much emphasis cannot be placed on this point. Our own experience has demonstrated that foul brood could be (and has been) communicated by the hive alone. All hives should be disinfected." Mr. Hurley should fall in line!

Mr. Alpaugh, dealing with spring dwindling, blames sour stores and ice-cold water as two predisposing causes; so he heats his water, as has frequently been advised on this side. Further, he has this to say of the water he supplies in spring: "To every pail of water I add a small handful of salt. I believe this salt will do more towards keeping the bees free from disease than anything else you can give them. When I first started giving salt I had two drinking-troughs, one salted and one fresh water. I found they would not touch the fresh as long as they could get the salted." The fascination shown by bees for saline water about manure-heaps may be due to the greater heat as well as the salt taste.

From "*Review*."—Mr. Hand considers "millions of bees will be crippled for life" by the "shaking" process, and he tells us of what he considers a more excellent way of rousing bees to new energy. "We simply interchange the two divisions of our brood-chamber, placing the top one that contains all the honey below, and the bottom one at the top. This compels the bees, through their instinct, to remove all the honey in the hive, which has the same effect as a mild honey-flow or stimulative feeding." This artificial flow he considers acts on the bees, queen, and nurses, bringing about a general air of prosperity in the whole hive. Mr. L. Scholl has promulgated a somewhat similar doctrine. Both work with shallow bodies with two or three sets of frames in the brood-nest.

From "*American Bee Journal*."—"How far will absconding swarms travel to hunt for a future home?" asks Mr. L. Scholl. He himself answers as follows:—"I have good evidence to show that they will go twenty to twenty-five miles from their starting-place, but how many times they camped on the way I don't know." I will consider the statement incredible until positive evidence is produced.

Mr. Byer deals with absorbent and sealed covers, and brings evidence to show that in his locality Mr. Root is wrong and Mr. Cogshall right:—"A few years ago, during an excessively cold winter, nearly

all the bees around here perished under sealed covers, while those with absorbent ones came through in good shape." This tallies with our experience.

Mr. York informs us that the April issue marks his semi-jubilee. It is just twenty-five years since he became connected with the *Journal*. By the way, that venerable paper will celebrate its jubilee next year.

Canada is ahead of the Mother Country. The Minister of Agriculture has just appointed Mr. Morley Pettit the first "Provincial Apiarist." He devotes his whole time to (1) experiments, (2) inspections, (3) lecturing. Would that our Agricultural Department would follow suit!

SUCCESSFUL APICULTURE.

(Continued from page 188.)

PARTHENOGENESIS.

"Close the gate, and let us hurry, the sky looks very black across the river."

"What did you mean by that big word you used just now?"

"Well, you have seen something of fruit fertilisation, and have read, 'Male and female created He them.' This applies to the animal as well as to the vegetable kingdom. You have perhaps watched a bee enter a bloom and come out with her body hairs covered with pollen-grains, which are the fertilising dust from the anthers or male organs of the flower. Away through space she flies with 'cupid wings' till entering another bloom she unconsciously dusts the pollen-grains on to the stigma or female organs of the flower she visits, and, travelling down into the ovary, these pollen-grains set the fruit, and in due time trees and plants are laden with luscious fruit, ripe red raspberries, melting strawberries, rosy-cheeked apples, and mellow pears. To attract these insect visitors plant life, out of its abundance, spreads a feast of nectar, loading them with pollen-grains, until, with measured beat of wing, they hie away home. You have sometimes when strolling along a hedgerow seen a hen on her nest, and on peeping in you have counted her pretty eggs. Could you tell me exactly how many male and how many female chicks there are in those eggs?"

"No; I don't think I could."

"But we can do this in the bee's nest. A bird's nest has only one compartment, but a bee has a compartment for each egg, which we call a cell. These cells are larger for the male than the female. Can you give me the size?"

"Yes; drones are about eighteen and the workers nearly twenty-nine cells to the square inch."

"Well, now, you see the queen-bee must lay every egg in the right cell—male eggs

in drone-cells and female eggs in worker-cells, and the Almighty knew what a wise provision He was making when He gave the queen the means to accomplish this end. It is this that we call parthenogenesis, which to the honey-bee is a real necessity. The word itself means reproduction without fertilisation: which in plant life would mean that an apple-tree could produce apples without pollen-grains being carried from anther to stigma. The drones are so produced in bee-life. But here we are 'home before the storm.'"—JOSEPH GRAY, C.C. Lecturer.

(To be continued.)

Bee Shows to Come.

June 8 to 11, at Reading (Berkshire B.K.A.).—Show of Honey in connection with the Annual Exhibition of the Royal Counties Agricultural Society. Entries closed.

June 22 to 26, at Gloucester (Royal Agricultural Society's Show).—Bee and Honey Section under the management of the B.B.K.A. Prizes arranged in groups of counties for Associations affiliated to the B.B.K.A. Schedules from E. H. Young, Secretary, B.B.K.A., 12, Hanover Square, London. Entries close May 31.

July 15 and 16, at Louth.—Show of Honey, Hives, and Bee-appliances in connection with the Lincs Agricultural Society, Bee-department under management of the Lincs B.K.A. Schedules from J. Hadfield, Hon. Sec., Lincs B.K.A., Alford, Lincs. Entries close June 11.

July 21 and 22, at Tamworth.—Staffs B.K. Association Annual Exhibition, Honey, &c. Six open classes. Excellent money prizes. Schedules from Joseph Tinsley, Expert and Lecturer, S.B.K. Assoc., 22, Granville Terrace, Stone, Staffs. Entries close June 26.

August 4 and 5, at Abingdon Park, Northampton.—Honey Show of the Northants B.K.A. Special prizes for open classes, including one for single 1-lb. jar honey. (Entry free.) Prizes 20s., 10s., 7s. 6d., and 2s. 6d. Schedules from R. Heford, Hon. Sec., Kingsthorpe, Northants. Entries close July 28.

August 10 to 12, at Beverley.—Show of Honey, &c., in connection with the Royal Yorkshire Agricultural Society. Schedules and form of entry from John Maughan, Secretary, Blake Street, York. Entries close July 3.

TRADE CATALOGUE RECEIVED.

THOS. W. HARRISON AND SON (5 and 7, Cheapside, Nottingham) send us an advance copy of their fully-illustrated and up-to-date catalogue of forty pages of all that is required for the apiary in the way of bee-hives and appliances. It also contains a selected list of garden requisites, dairy utensils, and poultry appliances, as well as a few useful hints for beginners in apiculture.

Queries and Replies.

[3933.] *Doubling Stocks*.—A week since I united four colonies into two; they each have nine frames of capped brood. I am thinking of working one on the doubled principle, as all the guide books recommend this for extracted honey. I work my racks with both extracting-frames and sections. I shall esteem it a great favour if you will let me know if it is advisable to work such racks on a doubled stock. I am pleased to be able to inform

you that there is very much less foul brood in this district compared with last spring.—J. W. L., Keswick.

REPLY.—There is no objection, provided that the bees have plenty of room to work in supers, and the breeding is restricted to the two body-boxes.

[3934.] *Decoy-hives*.—I shall be much obliged if you will kindly inform me in the B.B.J. if there is a law to forbid bee-keepers from putting out hives with comb in them in the open. A friend and fellow bee-keeper told me that there was such a law, but I told him that I had never heard of it. We are on very good terms, and have no animosity to one another. Bees in this district seem to be doing fairly well this spring, and I have heard of several swarms already this month.—F. D., Frome.

REPLY.—We know of no such law; but it is considered a very unneighbourly act to set decoy-hives with the object of enticing swarms to take possession of them. We have no doubt that if the owner of the swarm saw it enter such a hive he would be entitled to claim it.

[3935.] *Bees Superseding Queen*.—Having lately bought a hive of bees, more as a hobby than for profit, which I keep in a friend's garden near Finsbury Park, I should be much obliged if you would kindly clear up the following difficulties for me, as I am only a beginner in bee-keeping: 1. The stock I bought was supposed to be on eight frames, but I found on arrival that the bees only covered at the most four frames. (I may say that I did not buy the stock through the columns of your journal.) On further examination I found that the queen had a broken leg, but this does not seem to affect her, for she is laying pretty well, as far as I can judge. I found, however, last week that the bees had built two queen-cells, one of which had been sealed over and the other was well advanced. As my friend does not want a swarm if it can be prevented, on account of the neighbours, I cut out these queen-cells; but I am now thinking that perhaps it would have been well to let the bees raise a new queen, and then, when she is nearly ready, I thought I could take away the old queen, so that there should be no swarm. As, however, my comb seems to be all worker, I do not know whether it is advisable for me to do this. Can you tell me what I ought to do, having regard to the condition of the queen? 2. I should like, if possible, to get just a little honey from my hive to distribute among friends, but as I have no extractor it is very difficult for me to know how to obtain this. Would it be well for me to go in for sections or shallow frames, and if the latter, how can I obtain the honey from them without injuring the combs? I give name and address for reference, and sign.—E. R., London, N.

REPLY.—1. No doubt the bees were preparing to supersede their queen on account of the injury to her leg, and your best plan would have been either to have replaced her by another, or to have kept one of the queen-cells, and in due time removed the old queen. As your hive is so weak, it is not in a condition for swarming, and it is doubtful if you can work it up to proper strength in time for the honey-flow. Hives should be full of bees and ready for supers by this time. 2. You cannot remove the honey from shallow frames without injuring the combs, except with an extractor; you had therefore better go in for sections, and work for them as recommended in "Guide Book," page 58.

Notices to Correspondents.

* * * An application for schedule of the "Royal" Show has reached the B.B.K.A. office from "Loddington, Kettering." Will the writer please send his name at once as he omitted to sign the application.

G. H. L. (Petersfield).—*Bees Forsaking Hive*.—The comb contains a patch of chilled brood, which has become mouldy, showing that it has been forsaken for some time. Grubs of wax-moth and many ants are also present, and the honey-cells bear signs of robbing. As the comb shows no evidence of disease it is difficult to understand the reason for the bees disappearing in a hive supposed to be strong a fortnight before, and now overrun with robbers. At this time of the year bees may suffer from spring dwindling, "May pest," or similar diseases; but certain symptoms are evident in such cases which the observant bee-keeper could not fail to notice. You do not mention any of these symptoms, but the amount of wax-moth in the comb would suggest that probably the bees may have left the hive on account of this pest.

J. W. BEAUMONT (Huddersfield).—*Transferring from Skep*.—The bees will not go down into the frame-hive until the skep is too crowded for them. With warm weather and plentiful forage the bees will soon want more room, and should then take to the lower hive. Probably the young bees which you saw came out for an airing on May 8, as it is unusual for bees to swarm with an empty hive under them, unless there is something to make them dislike it. If you want the bees to transfer themselves, it is no use putting sections on the top of straw skep.

A. HARRIS (Wavendon).—*Detention-chambers*.—When we find that, in the hands of intelligent bee-keepers, the claustral hive in certain districts is a success, and the comparative results are published showing the advantage of this method of claustration over others seeking to attain the same object, we do not consider that we are misleading our readers by imparting to them these results, and think that they should know of the experience of practical men who are also extensive and successful bee-keepers. Our correspondent is entitled to hold what opinion he likes, but we should certainly be misleading our readers if we allowed them to suppose that by merely making a hole in division-board, and placing the frames behind it, the same object is attained as with the claustral hive. As will be seen on page 144, claustral hives have been "closed from the middle of November to the middle of March," and when the result is a loss of only one hundred bees during that time, the hive that is able to accomplish this can hardly be called a "toy."

G. W. J. (Dartford).—*Bees Dying*.—There is no evidence of any disease in the bees sent, and you can only ascertain the cause by observing the general behaviour of the stock. There was no abdominal distension; but, on the other hand, the honey-sac was empty.

R. DUTTON (Witham).—*Material for Quilts*.—We use unbleached calico on top of frames, and a piece usually lasts one season. Some use enamel cloth, and if this is placed smooth side downwards, very little propolis is deposited on it, and bees do not bite through, it being too glossy, and there are no projecting threads for them to take hold of. We have never tried jute, which is generally very coarse, and is used for making sacks and cordage. It could possibly be obtained of sack merchants or at marine stores.

G. BUDD (Sussex).—*Insects on Bees*.—From your description the insect you find on your bees is probably *Braula caca*, or blind louse. If you will send us a bee with some of the insects on it, we shall be able to tell you definitely.

WILLIE J. McKIE (Renfrewshire).—*Making Artificial Swarm*.—1. Yes; the plan you propose is workable. 2. We do not approve of working shallow frames for surplus below the hive, because bees, as a rule, store honey above brood-nest, and although they will work out combs below, they seldom put much honey into them,

and when they do so they usually carry it above as soon as the cells become free of brood. 3. If the colonies are strong, excluder-zinc is no impediment to their working in shallow frames; while racks of sections worked on top, with no excluder, result in many sections being bred in. 4. If both stocks are strong, there would be no advantage in uniting them for the heather. 5. There are sure to be drones about in June, and the virgin queen will fly out to meet them after she has been introduced. 6. No; they need no stimulative feeding when fruit-blossoms are abundant and the bees are storing honey. 7. Yes. 8. We have not yet tried the new excluder, but if accurately made it should be an advantage, as it would admit of a larger number of bees passing through during a honey-flow.

H. A. (Norfolk).—1. Add frames of comb-foundation on either side of brood-nest, according to the development of the colony. 2. Yes; you can return swarm and place frames of foundation at back, not between combs. 3. The young queen should be preserved, but cut out all superfluous queen-cells. 4. Hive swarm as shown on page 50 of "Guide Book." 5. Pages 21 to 24 refer to the management of swarms, and pages 24 to 53 treat of living bees. 6. Yes; if you return swarm. 7. There is an association in North Norfolk; the hon. secretary, Mr. C. J. Cooke, Edgefield, Melton Constable, could tell you of the nearest expert.

J. V. (Cumberland).—*Parasite on Bee*.—The bee sent is covered with the larvae of *Meloe*, or oil-beetle. These get into dandelions and buttercups, sometimes in large numbers, and attach themselves to bees when they are visiting the flowers. In some seasons they are very plentiful and in some districts are a great annoyance to bees, although usually they are parasitic on wild bees.

PERCY W. KNIGHT (Dorset).—*Examinations*.—1. As there is no association in your county you should apply to Mr. E. H. Young, the secretary of the B.B.K.A., 12, Hanover Square, London, and ask him to let you know the nearest place to you where there is likely to be a third-class examination this year. There will be examinations in connection with the "Royal" Show at Gloucester, at which you may probably be entered. 2. The comb sent contains incipient foul brood, but we do not think the tapes used in transferring have anything to do with it except in an indirect way. The spores of the disease have found some congenial medium in which to develop, and as the malady is in its earliest stages prompt treatment should result in a cure.

A. B. B. (Essex).—*Bees Dying*.—The bees have the appearance of having died of paralysis. In this disease, which is, fortunately, not very prevalent in this country, the healthy bees carry out the paralytic ones in the way you describe, and it is recommended to remove the queen and substitute another from a healthy hive. See page 185 of "Guide Book." This disease is so similar to others of the same class that it can only be diagnosed by observing the general behaviour of the stock.

HEREFORDIAN (Llanwarne).—*Queens Mating*.—You have to take your chance, as when there are other drones in the neighbourhood you cannot make sure of getting your queens mated with Italian drones.

INQUIRER (Dulwich).—*Dead Queen Cast Out*.—The queen is a virgin, and has probably been cast out in the way you suppose. The young hybrid bees in front of the adjoining hive have evidently been killed in trying to get into the wrong hive.

Suspected Combs.

A. B. C. (Hants).—No. 1 sample of comb is affected

with incipient foul brood, and No. 2 with foul brood in more advanced stage.

CONSTANT READER (Dorset).—Very bad case of foul brood.

W. J. B. (Herstmonceux).—Comb contains foul brood in early stage, and, as the hive is strong and working well, you should be able to cure it by following instructions in "Guide Book." If proper precautions are taken your other hives should not become contaminated, but you will have to exercise extreme care.

Special Prepaid Advertisements.

Twelve words and under, Sixpence; for every additional Three words or under, One Penny.

WANTED, SWARMS, ENGLISH BLACK.—Full particulars to A. B., 40, Highfield-road, Rock Ferry, Cheshire. q 29

CLERK AND CANVASSER WANTED, for dairy trade; preference given to one with knowledge in manipulation of Bees.—FRANK NYE, Dairyman, Littlehampton. q 48

STOCKS, with 10 Standard Frames, 25s., 1908 Queen; 3-frame Nucleus, 15s. 6d., with Queen; Racks of clean Shallow Combs, 4s. 6d.; Standard Brood Combs, 8d. each; cases returnable.—W. WOODS, Normandy, Guildford. q 41

GUARANTEED HEALTHY STOCKS FOR SALE, owing to removal, Sladen, Simmus, and Black Blood; Hives just painted. Can be seen during holidays.—WHITEMAN, 51, Woodfield-crescent, Ealing. q 53

FOR SALE, good Natural Swarm, May 15, not wanted, on four bars. What offer? Deposit.—Danehurst Gardens, Dauchill.

WANTED, several good prime Swarms. Quote lowest prices. Kodak Folding Camera, 3/6 plate, first-class order, will exchange for three good swarms.—REBBINGTON, Windsor Villa, Helensburgh, N.B. q 36

SWARMS, June delivery, 11s. each, cash with order.—WAIN, Thorpe Bank, Wainfleet. q 51

SWARMS FOR SALE, 12s. 6d. each.—WENT, Riverside, St. Osyth, Colchester. q 43

APIARY FOR SALE, 20 Stocks, exceptional district, instruction given.—For particulars apply. THE APIARY, Kingston, near Kingsbridge, Devon. q 40

QUEENS—I can spare a few 1908 Queens, Price 2s. 6d. each.—CHARLES H. BOCOCK, Ashley Apiaries, Newmarket. q 42

FOR SALE, several good strong Stocks, in Framed Hives; also 5 Swarms. Would exchange for Gentleman's Cycle, in good condition. Seen by appointment Whit Monday or Tuesday.—JAMES S. BAILEY, Swan-lane, Evesham, Worcestershire. q 43

FEW STRONG NATURAL SWARMS FOR SALE, from Bar-framed Hives; also Taylor's Bee Appliances.—E. GRINSTED, Street, Hassocks, Sussex. q 51

FOR SALE, a few Swarms, 12s. 6d. each.—KILLNER, Denham's Farm, Billingshurst, Sussex. q 53

FOR SALE, Graphophone and 60 records, complete, 25s., or exchange for good Swarm Bees.—SANDCROFT, York-road, Woking. q 52

SEVERAL EMPTY HIVES FOR SALE, perfectly healthy, from 6s. to 8s.; also Mating-boxes, 1s. 5d. each, holding 4 Frames, 5 1/2 in. by 4 in.—D. VALLANCE, Dunaskin, Ayr, N.B. q 37

WANTED, Swarm, or "W. B. C." Hive. Exchange Observatory, oak, never used; Fox-terrier, 3 months old, highly bred.—EXPERT, Shirfield, Basingstoke. q 39

1908 PROLIFIC BLACK QUEEN, 5s., on 3 Shallow Frames, 7s. 6d.—T., c/o B.B.J. q 49

Special Prepaid Advertisements.—Continued.

BOOKS WANTED.—Cheshire's "Bees and Bee-keeping," 2 vols. JOHN DAVIS, 13, Paternoster-row, London. q 52

22 S. 6 D. THE LOT.—Extractor, good as new (ungeared), and large ripener.—WALLACE, Bramhall, Cheshire. q 44

QUEENS, choice 1908, bred from my non-swarming stocks, 3s. 6d. each, per return.—TAYLOR, "Hollyhurst," Boldmere-road, Wyld Green, Birmingham. q 38

FOR SALE, cheap, vols. 11 to 35 "British Bee Journal," some bound, some unbound.—Particulars from R. HAYES, Hollywood, Crosshaven, Co. Cork. q 30

EXCHANGE FOR BEES, complete Harmsworth Encyclopædia, 40 parts, value 25s.—GOLDSBOROUGH, 6 Chapel-street, Headingley, Leeds. q 34

FOR SALE, Freehold Farm, 11½ acres; small house, cottage, stable, barn, orchard, &c.; good honey district; within 4 miles Uckfield, Sussex.—Apply, W. KENWARD, 1, Cliffe, Lewes. q 50

MUST SELL, four strong healthy Stocks of 4 Bees; two in W.B.C. Hives, 28s. each; one stock, Sladen's strain, 30s.; and one stock on shallow frames, 21s. One Shallow Frame and one Section Rack sent with each stock.—T. H. WOOD, 19, Park-street, Saltaire, Shipley, Yorks. q 54

BOOT REPAIRING BUSINESS, good, and **APIARY** for sale; nine well-stocked Bar-frame Hives, warranted healthy, with well stocked fruit garden. Inspection invited. Leaving district; low price for quick sale.—EDWARDS, Boot-maker, Buxted, Sussex. q 47

10 FRAME HEALTHY STOCK, in hive, £2.—**MOUNT PLEASANT APIARY,** Kington, Worcester. q 35

W. HAMBROOK, Church Farm, Newington, near Sittingbourne, wishes to inform customers that he has no more June swarms for disposal, having sold out completely. q 55

DRAWN-OUT SHALLOW COMBS, healthy, 6s. crate, with uncapping knife.—WAKERELL, 21, Mansfield-road, Croydon. i 27

NUCLEI.—Strong 3 or 4 Frame Nuclei, with Golden Queen, 11s. and 13s. 6d., early June delivery guaranteed.—J. W. TURNER, West Drayton, Middlesex. q 55

QUEENS, Doolittle's Famous Strain.—Customer writing May 5 says: "The Golden Virgin had last season was wintered on 4 frames, now cover 10 frames, packed to overflowing; shall have to give another set of 10 frames on top to give queen room, as our honey season will not be on yet." Is not this what all bee-keepers want? Hives boiling over *before* the honey flow arrives. Virgins now ready, 1s. 6d.; Fertiles shortly, 5s. each.—D. TAYLOR, Ilminster. q 12

GOOD NATURAL SWARMS FOR SALE, 10s. each.—HOLLEWORTH, Widmerpool, Notts. q 11

33 RD YEAR.—NUCLEI, 3 Frames (wired), Bees, Brood, and Queen, 12s. 6d.; Empties, 1s. 9d., or returned carriage paid.—ALSFORD, Expert, Haydon, Sherborne. q 5

BEE APPLIANCES, cheap.—Frame Hives, from 7s.; Straw Skeps, hole in top, 1s. 3d.; Section Crates, complete, 2s.; Smokers, 2s. 6d.; Extractors, 7d.; Wax Moulds, 1s. 6d.; Metal Ends, 2s. gross; Spring Travelling Section Crates, 2s.; Bottle Crates, 1s. 6d.; Bee Escapes, 3d.; Board, complete, 1s.; Naphthaline, 1s. box 6d.; Show Cases, for Shallow Frames, 1s.; Bee-gloves, 2s. 6d.—Particulars, KENT, Bee Appliance Works, Dorchester. q 1

SEVERAL "W.B.C." HIVES, Bees, and Worked-out Shallow-frames, and Lock-up Honey Tins. Sell cheap. On view by appointment.—GEO. STOCKS, 44, Bentley-road, Doncaster. q 23

HEALTHY SWARMS, best strain, 14s., Deposit, guaranteed safe arrival. My 40 Stocks can be inspected by appointment.—P. HANSEN, gardener and bee expert, 5, Gladstone-cottages, North Green, Southall, Middlesex. q 10

Special Prepaid Advertisements.—Continued.

14 REASONS WHY TILLEY'S IMPROVED PATENT "WON'T LEAK" SECTIONS SHOULD BE USED BY ALL BEE-KEEPERS, post free; sample and instructions, post paid 6d.; complete Super, with 9 2-lb. patent Sections, 4s. 6d., on rail. Order now to prevent disappointment. Particulars of Tilley's registered Damp-proof Hive, painting not necessary, ready June. The outcome of upwards of forty years' practical Bee-keeping.—M. H. TILLEY, Bee Farm, Dorchester. See advt. next week. p 99

BEES' DELIGHT, "Chapman Honey Plant," 6d. packet, post free.—LOUBET, Thameside, Weybridge. q 26

VIRGINS, Sladen's strains, 2s., three 5s. 6d.; Fertiles (shortly), 5s. 6d. Orders rotation.—PAUL, Salisbury-road, Bexley. q 4

2 STRONG EMPTY HIVES, Frames, and Supers complete, £1.—Particulars, E. BENNETT, Heacham, Norfolk. q 21

WILL BOOK A FEW MORE SWARMS, May 15s. and 12s. 6d., June 11s. 6d. and 10s. 6d. Satisfaction guaranteed.—MULLIS, Egerton, Kent. q 20

WANTED, SWARMS, any number.—Price and particulars to HERROD AND STEWART, Luton. p 68

"NEVER SWARM" "Detentionised" Hives, answer far better than the Claustral toy, without extra cost, floor, two 11 in. outer cases, roof, brood box, 12 Standard Frames, painted 3 coats, 25s. 6d.—HARRIS, Wavendon, Bletchley, Bucks. p 71

500 SWARMS WANTED.—State price delivered Welwyn, carriage paid; boxes supplied if required.—E. H. TAYLOR, Welwyn, Herts.

"CHAPMAN HONEY PLANT" SEED, 3d. and 6d. per large packet, post free.—W. WOODLEY, Beedon, Newbury. p 91

PROTECT YOUR FRUIT.—Tanned Garden Netting (best only), 50 by 8 yds, 17s.; 25 by 8 yds., 8s. 6d.; 50 by 4 yds. and 100 by 2 yds., 8s. each; 50 by 2 yds., 25 by 4 yds., 4s. each.—L. WREN AND SON, 139, High-street, Lowestoft. p 94

EXTRACTING HOUSES, Stock sizes, or own requirements. List free.—F. E. MATTHEWS, Cofton Apiary, Northfield, Birmingham.

COMFORTABLE APARTMENTS for Brother Bee-keepers visiting Douglas. Terms: Tea, bed, and breakfast, 3s. 6d.; or full board, 5s. per day.—HORSLEY'S, Merridale House, top of Castle Drive, Douglas, Isle of Man.

AVOID BEING STUNG by wearing Reynolds' famous "Burkitt" Bee Gloves, price 2s. 6d. without sleeves; with self-adjusting sleeves, 5s. 6d. pair. State size when ordering. These Gloves are light, hand-sewn, and not clumsy.—ED. REYNOLDS, Glove Manufacturer, Andover. Wholesale terms on application. o 19

"THE PREPARATION OF HONEY AND WAX FOR THE SHOW BENCH," post free 7d.—JOSEPH TINSLEY, 22, Granville-terrace, Stone, Staffs. h 24

DON'T GET STUNG,

When by using **APIFUGE** you can easily prevent it. **APIFUGE** will also be found extremely useful for travellers in foreign countries where insect pests abound. Bottles, 1s., post free.

S. E. GRIMSHAW, 4, Reginald Place, Chapeltown, LEEDS.

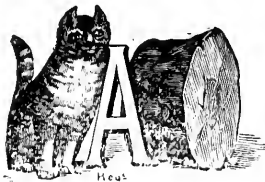
FREE.**MEADOWS,**
Syston,
Leicester.**BEST**
Goods Only.

Editorial, Notices, &c.

REVIEWS OF FOREIGN BEE-JOURNALS.

By "Nemo."

Divisible Brood-chambers.—As there seems to be an attempt made here to introduce divisional brood-chambers, it is opportune to state that M. E. Moret, writing in *L'Abeille de l'Aisne*, cautions bee-keepers, especially beginners, about using this so-called "new method," but one which has been tried many times and rejected. He points out that he is not alone in his objections to such hives with close-ended frames, and mentions Langstroth, Dadant, Bertrand, and others who have shown in their works the numerous drawbacks to these hives. Mr. Dadant, after showing the many disadvantages of the "Hoffmann" frame, and having explained how the queen who lays in a circle is obstructed when she encounters the wooden bars of the frames, adds: "A two-storied brood-chamber presents the same inconvenience, which is increased by the space existing between the two stories, a space that the bees have to warm, also by the obstruction caused by bottom bars of the upper story and the top bars of the lower one, without obtaining the least advantage from this arrangement. This division of the brood in two stories is one of the causes which prevent German bee-keepers from raising as many bees in their hives as those who employ the 'Langstroth' hive, for even a single bar across the comb hinders laying to such an extent that sometimes brood will only be found on one side of this bar." From this it will be seen that the upper chambers should be used only for storing honey and not for brood-rearing.

Race-breeding is the Proper Way.—We find Pastor Hering, writing in *Die Deutsche Bienenzucht* on this subject, says: "The circumstance that some colonies give good returns under unfavourable conditions, while others refuse to do anything, teaches us that we should try to increase the good colonies, and with this object in view must go in for more extensive race-breeding, according to the example of Swiss bee-keepers. The good result will not fail to manifest itself. It is already known that the common black German bee, with its great vigour and its late spring breeding, is best suited to the climate, and bee-keepers are cautioned not to introduce foreign blood, either Italian or Carniolan, and are advised to make an endeavour to improve the native race by judicious selection."

Granulation of Honey.—It is well known that pure honey granulates in course of time, even when it is in the comb, which

in this case renders its extraction impossible. Some honeys remain fluid much longer than others, and never become perfectly solid, but have a buttery consistence. There are, again, others that partially granulate, dividing into two portions, the solid and the liquid being distinctly visible. M. F. Ducroquet treats of the subject in *L'Apiculteur*, and explains that the chemical composition of honeys derived from different sources is the cause of this variation. The saccharose of nectar is converted in the honey stomach of the bee into dextrose and levulose, the former being crystallisable and the latter remaining liquid. The varying proportions of these in honey, depending on their source, determine the proportion and rate of granulation. M. Ducroquet says that analysis of honey should be directed towards determining (1) its contents of saccharose before inversion, (2) contents of dextrose and levulose after inversion, (3) comparative quantity of dextrose and levulose as determined by the polariscope. He mentions that in commerce saccharose is derived from sugar cane and beets. Other plants produce mixed sugars in variable proportions. Levulose, which has a pleasanter taste than dextrose, has hitherto been obtained principally from honey. Now it is extracted from dahlia and chicory roots. The first has from 9 to 13 per cent. and the last 7 to 11 per cent. of starch, called *inulin*, which by saccharifying is transformed into levulose, just in the same way as other starches change to glucose. He therefore thinks a distinction must be made between plants favourable for the production of levulose and those producing dextrose. Sweet fruits contain principally dextrose, and levulose is found in acid fruits. Nectar, he thinks, must have the same composition as the fruits, and plants yielding acid fruits would produce a levulose honey which would granulate with difficulty.

Degeneracy of the Common Black Bee.—M. E. Van Hay, in an article in the *Rucher Belge* on the degeneracy of the common bee and its selection, says that this degeneracy has been caused by the bee-keeper himself. Selection consists of a series of rational breedings with a view to preserving the good points in the race, and at the same time eliminating the bad ones. Hygiene is an important help. Instead of observing these conditions with the common bee, just the contrary has been the practice. The best colonies have been destroyed in order to obtain their greater produce. The same has been done with late swarms which could not store sufficient provisions. In this way the best queens and the most active workers have disappeared, leaving only indifferent

colonies of little value. Moreover, the hygiene of the hive has not been considered, and nothing has been done to endow the bees with a healthy dwelling. M. Van Hay says, if modern methods of breeding by selection were generally adopted, he is quite sure that the results would not only be favourable, but bee-keepers would have no reason to regret discarding the foreign races. He quotes M^r Bertrand, who has said that "every country possesses the bee which suits it the best," and this is a wise natural law. M. Van Hay has cultivated bees and poultry for the last twenty-five years, and for experiment has had various races, with the result that he has now discarded all foreign races of both bees and poultry.

Bee-keeping in Abyssinia.—We read in the *Bulletin de la Société Romande d'Apiculture* that rich and poor practise bee-keeping in Abyssinia. Isolated hives are to be seen there suspended in trees, and there are apiaries also containing as many as fifty colonies. The hives are trunks of trees, earthenware pipes, or baskets. There are a good many wild bees. The best produce comes from the plains of Waag, Laska, and Fedja. The honey in these regions is produced from a giant and very melliferous heath. Abyssinian beeswax is of good quality, and is exported principally from the port of Massowah. No honey is exported, all of it being consumed in the country.

OXFORDSHIRE B.K.A.

ANNUAL MEETING.

The annual meeting of this association was held at 4, Turl Street, on Saturday, April 17. The Rev. R. Hutchinson, in the unavoidable absence of Lord Effingham, presided. The report stated that, owing to the inclement spring, there had been a great mortality amongst stocks, some apiaries having lost as many as ten or twelve colonies. The past year, too, had not been a favourable one for swarms, although the latter adverse factor would not make itself felt until this year; as a consequence, there had been a great shortage in the honey harvest, although, on the other hand, all the honey that had been gathered proved of excellent quality. The work of the association had been greatly restricted through lack of funds, the withdrawal of the County Council grant a few years since having left it in a very bad way financially. But it was some satisfaction to find that the latter body had again become alive to the importance and value of the bee-keeping industry, and had given them a grant of £10. Additional honorary subscribers, however, were badly needed if the association was to do its work thoroughly, for

Oxfordshire was a very expensive county to work, owing to the distance from village to village and the lack of railway communication. The balance-sheet showed a deficit of nearly £10.

Lord Effingham was unanimously re-elected president. Mr. H. M. Turner expressed a wish to be relieved of the duties of secretary, but was willing to continue in office if they were unable to find a younger and more energetic bee-keeper to fill the position. Miss Maclaren and Messrs. Goddard, W. V. Hoey, T. E. Hancox, A. Humphries, and J. Salmon were elected on the committee. A vote of thanks to Mr. Hutchinson for presiding closed the proceedings.—(*Communicated.*)

W. B. CARR MEMORIAL FUND.

	£	s.	d.
Amount already acknow- ledged	48	5	6
S. Jordan	0	5	0
T. W. Harrison	0	5	0
M. Hammond	0	2	6
J. M. Best	0	1	0
	£48	19	0

Correspondence.

The Editor does not hold himself responsible for the opinions expressed by correspondents. No notice will be taken of anonymous communications, and correspondents are requested to write on one side of the paper only, and give their real names and addresses, not necessarily for publication, but as a guarantee of good faith. Illustrations should be drawn on separate pieces of paper. We do not undertake to return rejected communications.

AMONG THE BEES.

THE DOMINATING INFLUENCE.

[7478.] *As the Queen Halls.*—During the greater part of her life a queen will lay only worker-eggs—that is, fertilised eggs from which worker-grubs issue. And as into each of these she injects a spermatozoon while the egg is passing down the duct from the ovaries, controlling voluntarily the muscles which permit the fertilising matter from the spermatheca to accomplish this feat, it must be acknowledged that we have here an evidence of will power on the part of the queen beyond dispute. The motive agent beyond all this, however, lies deeper. Early in the season a queen in normal condition seeks only worker-cells, and rigidly eschews the larger drone-cradles. Later she instinctively alters her plans under altered circumstances, and oviposits in the larger cells, and from the fruits of that laying there result only male bees, the period when they attain perfect "manhood" synchronising exactly with the time when young virgins hatch out

and seek each her mate in the great void of ether. It would all seem at first blush as if the old queen maturely and deliberately brought about the conjunction of circumstances, but we shall find the predisposing cause for her actions lying still deeper. While, as I have just said, a queen in normal condition acts as I have indicated above, in abnormal circumstances the case is altered. Unfertilised queens, as we all know, cannot fertilise their eggs, so the product is all drones. Old, worn-out queens, either from the fact that the muscles controlling the spermatozoa are unable to act, or because the proper glands have ceased to secrete the necessary fertilising matter, lay mainly only drone-eggs, at times even when they are deposited in worker-cells.

But the Worker Will.—The prescient little worker is the mainspring which sets the clockwork of the hive agoing and regulates the mechanism. She "stokes" the queen, and, will she nill she, the eggs are manufactured. As spring advances the process of heavy feeding goes on, and the queen more and more becomes simply an egg-laying machine. Impelled by incoming nectar, this concatenation of circumstances produces a desire for supersedure of a failing queen or swarming, as the case may be, and the queen, under propulsion or compulsion, starts to deposit eggs in drone-cells. The workers, contemporaneously with the evolvment of these larvæ, proceed to construct queen-cells, and they, or the queen, supply the necessary egg or larva from which they create a new being with new functions, duties, and powers. The process we know darkly, the result we know patently. The treatment bestowed by the workers develops certain organs and atrophies certain others. The sting is practically eliminated, the wax-glands are made non-existent, the pollen-baskets disappear, and the ability to build, cap, and store the cells is not granted the queen. The powerful muscles, the sensitive hairs, and the collecting ducts on the tongue, so indispensable to the workers while prosecuting their industry in the fields, are unnecessary in the queen, and are therefore dispensed with. On the other hand, new organs are developed, all at the will of the worker, because in the ovaries all eggs are alike. When, however, the queen wills, they are fertilised, and the result is a worker; while, on the contrary, if she simply lets them glide down the oviduct there is produced a male bee. At the will of the worker, what would have become a full sister becomes the mother of future generations of queens, workers, or drones.

Brains Rule.—Let us pursue the subject a little further. The labourers perceive that the ovipositing powers of the

queen, from age, injury, or natural causes, are failing, and forthwith take steps to right what is wrong. The queen herself is not consulted over the question of supersedure, being, in fact, treated throughout by the wise workers during the process as a negligible quantity. One or more suitable larvæ are selected, large acorn-shaped cells constructed round them, a superfluity of royal jelly poured into the cell in which the young grub is floated, sucking in the food at every pore of the body. In due time a young virgin hatches, takes her nuptial flight, gets fertilised, and assumes the post of egg-layer. So little are the feelings of the old queen consulted that she is kept at bay by her own daughters if she presumes to trespass on the domains of the young mother-bee; otherwise she is simply tolerated in the hive and allowed to live side by side with the other on sufferance. The will of the workers is thus seen to be paramount, and their decisions are final.

The Controlling Force.—Or, again, take the question of swarming. Queen-cells are again raised by the bees over larvæ specially selected by them. Drones have been reared and hatched as a preliminary. Then on a fine day, at an hour chosen by the bees, forth they sally on swarming bent, rushing out pell-mell, flying madly about, apparently a chaotic conglomeration of atoms, but centering round their queen, not at her will, but theirs, curbing her powers of flight and confining her to the centre of the throng, where she is safest. Note, however, that she does not lead them out of the hive; they lead the dance, and it is only when from one-half to about three-fourths of the rush are in the air that she issues, frequently under compulsion and apparently reluctantly. Should weather or other circumstances prove unacceptable, the bees return to the old domicile, she following in the wake of the crowd, being led in, not leading the throng.

The Predominating Partner.—Let an accident happen in the interior of the hive—say a breakdown of the works—and the drones are cyphers in the hive, while the queen is a nonentity. The conclave of workers which collects round the ruins of their palace, seriously discussing the situation in calm, conventional conversation, form the judge and jury to decide how the wrong may be made right; and they, too, are the hewers in wax, as well as the architects who plan and carry out the work. Their foreseeing wisdom superintends and carries out the storing of nectar in the cells, which alone can tide them over the period when nothing can be gleaned from the flowerless fields. Their foreknowledge provides, months before it is required, the reserves of pollen which allow the rearing of the first

batches of brood in early spring; and their prescient "second sight" seals up every chink, crack, and cranny with propolis, to make all snug and comfortable when Boreas blows his stormy blasts. Look where we may, in or out of the hive, the dominating influence, the predominating partner, will be found in the worker-bee.—D. M. M., Banff.

A PROMISING OUTLOOK.

[7479.] Under this head your correspondent B. J. Mitchell (7471) reports on the prosperous condition of bees in Norfolk. May I report on the still more advanced progress of bees in East Surrey? On May 3 I supered all my hives (four in number), Nos. 1, 2, and 3 with racks in which there were nine or ten clean drawn-out sections saved from last year interspersed among the new ones; No. 4 with all new sections with full sheets of foundation. On May 20 the bees in Nos. 1 and 3 were "hanging out" in spite of all ventilation possible being given. On May 23, therefore, I gave a second rack below the first to hives 1, 2, and 3. The necessity for this was specially urgent in one case, where the bees had actually begun to build comb in the space behind the dummy.

Roughly judging by the weight of the racks as they were lifted to put new ones below, they seemed at least half-full. Having no more racks ready, I left the fourth hive until May 27, and then found the sections all drawn out, even to the extreme end rows, while some in the middle were being sealed over. I then gave this hive its second rack below the first. On the same day I looked into the top racks of the other three hives, and found finished sections in all, in one case the entire three middle rows being sealed. In all my experience (eleven years) I have never had finished sections in May, and certainly never had two racks on all my hives by that date. But what a wonderful month it has been, this May of 1909! One has constantly had to remind oneself that it was only spring after all; that all the summer is before us, with the main honey harvest (clover in this neighbourhood) yet to come.

The chief interest, to my mind, in this unusual early surplus-storing lies in the fact that it is almost exclusively gathered from what may be called wild sources as distinguished from cultivated. There are no "acres of raspberries" about here. I have several apple trees in my garden, and there are a few fruit trees scattered round in farm orchards, but this is all that can be called cultivated. It shows that, given the weather, the ordinary

flowers of the field and flowering trees yield enormous supplies, which, however, we do not often get, because we seldom have the weather.—G. S. N., Godstone, Surrey.

SWARMING VAGARIES.

[7480.] I think you will like to hear of a curious incident which occurred in my apiary on Saturday last. A prime swarm came off one of my stocks about eleven o'clock, settled most conveniently on the bough of an apple tree in my garden, and was safely caught in a skep by noon. About 3 p.m. we removed the old stock—which, by the way, was in one of your "Cowan" hives—to a new stand about 10ft. away, and hived the swarm in almost record time in a new "W. B. C." hive on the old stand. We did not see the queen enter the new hive, but feel sure that she did by the behaviour of the swarm, which marched in at once. Imagine our surprise when in about ten minutes or so out came the bees again and made for the old hive on the new stand! My coadjutor, a bee-man of over forty years' experience, was quite non-plussed, and we held a council of war, which resulted in opening up the two hives and taking out the old queen with a frame of bees and brood, and putting them bodily into the new hive, on the flight-board of which we shook off the bees from three more frames. I should add that we had originally placed a frame of brood and a frame of honey into the new hive to make sure that the swarm would remain in their new quarters, and had deposited the super of shallow frames from the old hive. The swarm was taken to the new hive, which has three frames of brood and stores and seven frames of worker-foundation, and the bees are working all right in the super. They are splendid bees—almost pure golden Italians. In any case, their conduct, if not unprecedented, is a tribute to *your pattern of hive!*—C. L. M. EALES, Walington.

A NOVEL BEE-HIVE.

[7481.] I was much interested in the account which appeared in B.B.J. of July 2, 1908 (page 265), of Miss Gertrude Todd's novel apiary, and thought you might like to see a photo of a novel hive which I bought from an old skeppist. It consists of an old-fashioned three-legged crock, and was first put on a straw skep to keep the wet out. A stray swarm hived themselves in the crock, and have remained in possession for the past two winters. Last year they sent off a big swarm. They are now very strong, and appear to have plenty of stores. I in-

tend shortly to transfer them to a frame-hive.

I only commenced bee-keeping in 1908 with one stock, which I transferred according to instructions given in "Guide Book." I took from them 63 lb. of honey last season, and on opening the hive a few days ago found that I had left far too much honey for them to winter on. I now have seven stocks, only three of which are in frame-hives, but I am going to transfer the other four as soon as I can.

This district is fairly good for bees; there are plenty of apple trees near, on

of varying strengths, from three frames of brood to ten. I simply dropped a teaspoonful between the frames, with no protection. Sometimes it dropped to the floor, sometimes it stuck at the top. Strange to say, the bees are not dead, but thriving, and seem to take no notice of it at all. I have seen them standing on the lime and fanning, and I have also seen (or think I did) bees sucking the liquid formed on the floorboard. Nor has there been any stampede from the hive. As regards good effects, it does not seem to cause the disappearance or turning out of foul brood (dried scales or spores), but I do not think



A NOVEL BEE-HIVE.

which I hope to see my bees working before long. There is also a fair amount of clover and beans within reach of my hives.—T. HARRIS, Shepton Beauchamp, Somerset.

FOUL BROOD AND CHLORIDE OF LIME.

[7482.] With reference to the above, I should like to thank W. Brown (page 205, B.B.J., May 27) and condole with him in his misfortune if due to the lime. However, from May 16 I started experimenting with it, either as a cure or a preventive of foul brood in about fifty hives

that bacilli are able to practise their fell business in its presence. All larvæ seem to thrive healthily, which is mainly what is required. I have not found naphthaline effect this. I bought the chloride of lime in Id. packets at the chemist's. I shall be pleased to report any further developments.—G., Royston.

SELLING SWARMS.

[7483.] Through my advertisement in your valuable little B.B.J. I have sold all the swarms I can spare, and could have sold hundreds more. In this district no one cares much for bees; those

who do keep them use the old straw skeps. I have to-day extracted about 100 lb. of this season's honey, taken from three stocks. Do you not think this fairly early even for Kent? I always read with interest and profit the accounts which appear in the *B.B.J.* and *Record* of the bee-experiences of other readers, and the "takes" of honey in different parts of the country.

About five years ago my apiary was practically wiped out with foul brood, my loss being about £30; but I started again, and have been clear of any disease since. I only made up my losses last year, when my profits came to about £20. Hoping all bee-keepers will have a good harvest this year.—W. H., near Sittingbourne, Kent, May 22.

CAPPINGS OF COMB.

BY L. S. CRAWSHAW, NORTON, MALTON.

Hive-roofs (page 175).—The object of wetting the canvas is probably to prevent its drinking the paint. This process is hardly so necessary when dealing with thin calico. I prefer to make the protection greater by pressing the material fully into service with a filling coat.

Ensuring Worker-comb (page 182).—I should like to add to Mr. Woodley's most important counsel a word as to embedding. Patches of drone-comb are sometimes built upon worker-foundation, in spite of full sheets, at the least excuse of stretched foundation or imperfectly embedded wire. Embedding should be perfect—there should be no unattached wire—and a drop of hot wax at each wire-end is worth while. But warm the foundation before embedding. This causes it to expand, and there is less risk of bulging. I do not find it good practice to fix up a lot of frames in winter. The wire may rust or the foundation become brittle and less acceptable. These operations may be done as required even upon a large scale. But if not, bulged combs may be largely obviated by thoroughly warming the foundation before use (thus causing it to expand and bulge) and then curing it by flattening. Replace the frame upon the embedding-board, the wire side up, and press flat with a similar board. Both boards should be wetted. I offer the suggestion to those who use light brood-foundation. But worker-combs may be built from starters in wired frames. Such should only be given to specially-prepared small colonies, and be built between separators. It is most important that they hang plumb. The least deviation from truth brings the lowest wires out of the septum. The wiring, too, should be extra good and all in the one plane. I have had a

number of such combs produced, but I am in doubt as to whether they repay the trouble.

Bees Hanging Out (page 182).—Mr. Woodley gives foundation when colonies hang out. My only colonies which do this are in some purchased skeps, so that it is difficult to carry out the operation. An examination at the time of writing shows that they have abandoned swarming preparations owing to the break in the weather, and I *did* want them to swarm! I wonder if I might say—Bother!—or Blow! I would shake out a swarm of such B's if they would do any good. I am no longer exercised, as many bee-keepers are, over the question To swarm or not to swarm? I should welcome a good early swarm from every hive. I am even prepared to crowd to eight frames when necessary to induce them. A plan, suggested by the late E. L. Pratt, for increase and cure of hanging-out is to place another hive so close that the bunch of bees covers the union of the entrance. Then when the second hive is partly adopted introduce a queen.

Bees in a Tomb (page 184).—A fitting monument to a bee-keeper might be a hive of bees sheltered in a rocky mound, with a cascade of arabis *et hoc genus*. It is, I hope, too early to talk of my own, but my friends may remember! Yes, and I should like a legend from the lesson of the Ancient Mariner:

He liveth best who loveth best
All things both great and small.

Two in a Cell (page 184).—Some years ago I came across a similar, though milder, case in Cheshire, to which I drew the attention of the then touring expert, Mr. Jas. Waddell. Subsequently we found a number of such cases, but could not, I remember, make them apparent to most other eyes. I think I referred speculatively to them at the time in the *B.B.J.*, but I had not the opportunity of tracing their subsequent history. Would Mr. Avery mind keeping an eye on this remarkable case, and ascertaining, if possible, what actually does occur? Is it not likely that the one larva will be imprisoned and starved behind the stronger when the latter begins to fill the cell?

Electrical Swarm-alarm (page 185).—Is not Mr. Ratlborne a little premature in saying that electricity "has been applied," seeing that his idea is still in the paper stage? As it is still experimental, criticism and suggestion may be helpful! Will not the bell "ring continuously" if a number of entrances are in the one circuit? For a few bees per entrance may equal a swarm! In any case, supposing the device to work, the bell must be constantly tinkling, and—if the dwellers in the inventor's kitchen be any-

Queries and Replies.

thing like our own—it is to be feared that the bell will attract as little notice as the morning alarm-clock! But why not have a foot-plate, like a shop-door alarm, to be depressed by a large number of bees springing into flight? Or a still shorter cut, why not obtain a bough upon which the bees have previously swarmed (it is well known that bees are partial to such settling-spots) and hang this to the front-door bell, and so let them ring *that*? But perhaps this would not be, like the former suggestion, altogether a-leg-trick! There would, however, be no risk of the assault and battery, to which the inventor calmly alludes as “short circuit,” and which would be, from a humanitarian point of view, sufficiently shocking!

A *New D-parture* (page ii).—What’s in a name? Or, rather, what isn’t? The name is, or used to be, Baldwin; but that was before the block-maker—for some reason best known to a head accustomed to blocks—left out the middle letter. Apparently the “D” has dropped from the roof down the lift, and landed fortunately upon its feet, with its own period, in the middle of B. C. This shorter title may be the intended one, although, early as Baldwin’s were in the field, it is doubtful whether they made hives so early as this would indicate. At least, it cannot justify the ignoring of A. D.! Perhaps B. C. means Bees Comfortable, which is all the more reason for restoring the D. to its proper name, lest its equivocal position be unfortunately misunderstood!

WEATHER REPORT.

WESTBOURNE, SUSSEX.

April, 1909.

Rainfall, 1.57 in.	Minimum on grass,
Heaviest fall, .38 in.	22° on 2nd.
on 19th.	Frosty nights, 3.
Rain fell on 13 days.	Mean maximum, 56.
Below average, .20 in.	Mean minimum, 39.7.
Sunshine, 232.9 hours.	Mean temperature,
Brightest day, 9th,	47.8.
12.2 hours.	Above average, 1.9.
Sunless days, 1.	Maximum barometer,
Above average, 48.4	30.480 on 2nd.
hours.	Minimum barometer,
Maximum tempera-	29.581 on 24th.
ture, 66° on 9th.	
Minimum tempera-	
ture, 29° on 2nd.	L. B. BIRKETT.

APRIL RAINFALL.

Total fall, 2.15 in.
 Heaviest fall in 24 hours, .44 in. on 19th.
 Rain fell on 15 days.
 Below average, .41 in.
 W. HEAD, Brilley, Herefordshire.

[3956.] *Uniting Bees*.—I have two colonies of bees, one in a frame-hive, and the other—a late swarm bought last autumn—in a skep. Three weeks ago both seemed strong and promising, but all last week, in spite of ideal weather, those in the frame-hive scarcely came out at all. On examination, I was unable to find a queen, although I saw a few bees bringing in pollen, nor was there any sign of brood in the combs. They appeared to be getting thin numerically, though well supplied in sealed stores. A friend who was with me was also of opinion that the queen was missing. I think, therefore, that I should unite my two stocks. Kindly advise best method of doing this under the circumstances. Supposing my friend and self are both wrong, and a queen is in the hive, would it be possible to unite by placing skep on top of frames?—COMPARITE, N.B.

REPLY.—No doubt your frame-hive has lost its queen, and as there is no brood the bees are gradually dying off with no young ones to replace them. If there are sufficient bees you can unite them with those in the skep by making an artificial swarm of all the bees in the queenless stock. Dust the other stock with flour, set the hive on a sheet, and raise its front edge. The queenless bees may then be dusted in the same way and shaken on the sheet in front of stock, which they will enter. The skep now containing all the bees can be placed on top of frame-hive, and in due time the bees will take possession of the lower story. Be sure that the frame-hive is really queenless, otherwise there will be fighting. See “Guide Book,” pages 107 and 150.

[3957.] *Making Artificial Swarm*.—I have to acknowledge gratefully the gleaming of much valuable advice from both “Guide Book” and B.B.J., but should be glad of your assistance in the following difficulty:—I have a stock with a particularly good queen in my garden, and two others at a farm twenty-two miles away, which I visit during holidays. There is no one there who can undertake anything in regard to the bees, and above all, I do not wish them to swarm. They were both strong, healthy stocks at Easter, and, as I have an empty hive and several drawn-out combs, I thought of making an artificial swarm at the end of this month, and introducing either a queen-cell or queen from the hive here at home. 1. Could an unripe queen-cell be transferred that distance safely and be effective? 2. If I allowed a queen to hatch out here and mate with a drone from the same hive, would that be too much in-breeding, likely to result in weakly progeny? 3. As I want to work for section-honey, would it be better to place supers on the strong stocks and defer the division till after the honey harvest? Hoping you will excuse the number of questions and thanking you in anticipation.—QUERETS, Birmingham.

REPLY.—1. Yes; if protected from cold on the journey. 2. No; once in-breeding would make no appreciable difference, and there is always the probability of your queen mating with a drone from another colony. 3. If you do so the bees are much more likely to swarm naturally, and as this is what you particularly wish to avoid, your best plan is to make the artificial swarm as recommended on page 94 of “Guide Book” as soon as the bees are ready for it, and then put on the sections.

[3958.] *Transferring Bees*.—I am transferring bees from skeps to frame-hives in the usual way, after driving them and putting the queen below. After twenty-one days the brood will be hatched. If I put shallow frames between body-box and

skep would the bees transfer the honey from the old combs?—J. W., Horley.

REPLY.—No; they usually store their honey above. If you wish to have the honey removed from the skep your best method is to turn the skep upside down and place a board on it with a good-sized hole, covered with queen-excluder. Then put your frame-hive on the top, and in due time the bees will carry the honey up into it. You must, of course, provide an exit for the bees, and whether they will work in the supers with shallow frames will depend on the strength of the colony and the space occupied by brood in the hive. If there is no room to store it in brood-chamber, they are more likely to carry it above.

[3939.] *Formaldehyde and Foul Brood.*—Will you kindly tell me: 1. What strength of formaldehyde is used for spraying combs of brood when it is used in the cure of foul brood? 2. Is honey likely to become spoilt in flavour by the occasional use of formaldehyde when supers are on? 3. What advantage is gained by using the strips of wood, one on the outer side of each outside comb in the brood-nest, as advocated in the chapter on "Hive-making" in the "Guide Book"? Thanking you in anticipation.—G. W. ASH.

REPLY.—1. A 10 per cent. solution is used, but although empty combs may be sprayed with it, you must not spray the brood, which would be killed by it. The best way is to let it evaporate in the hive. 2. If too strong certainly the flavour would be impaired. 3. The object is to get the space so that the bees may work out the outer combs to the same thickness as the others. Without strips the outer combs could not be built out; they would, therefore, not be fit for brood, and could not be interchanged with the other combs.

[3940.] *Bees Objected to by Neighbour.*—I have been a reader of your valuable journal for four years, and have derived great help from it, and would be glad if you could advise me with respect to the following matter: I have an out-apiary of five stocks in a corner of a ploughed field, one mile from my house and three-quarters of a mile from next village. The nearest house is a quarter of a mile away. The two fields adjoining that in which the bees are kept belong to two other farmers, and one of them objects to my bees being so near to his land, and has asked me to remove them. I have nowhere else to keep them, so that it would mean getting rid of them altogether, which would be a great loss to me. There is seldom any work done there with horses during the season that bees are at work, and there will not be a person there at work again until August, when I could confine the bees in the daytime if necessary. Can this farmer compel me to remove them, and, if so, how far from his hedge must I put them? Two of his men had about three stings between them last summer, but they made no fuss about it, and I gave them some honey. Thanking you in anticipation.—C. G. C., Doynton, Bristol.

REPLY.—Your neighbour would have to prove that the bees were a nuisance before you could be compelled to move them. If the hedge is sufficiently high the bees should be no trouble where they are; but why not move them further down 15 yds. or 20 yds. against the hedge of your neighbour who does not object? Bees have a great dislike to horses when they are heated from ploughing, and are liable to sting them. It would, therefore, be advisable for you to insure against any possible accident. Write for particulars of bee-insurance to the Secretary of the B.B.K.A., 12, Hanover Square, London, W.

[3941.] *Fixing Foundation in Sections.*—As a beginner and a reader of your paper I should be glad if you will kindly answer the following questions: 1. Is it advisable to fit full squares of foundation in sections, or only starters? 2. I

have some two-way sections without split top and no groove. How can I fit foundation in these? Thanking you in anticipation.—K. C. PAYNE, Birmingham.

REPLY.—1. Some use full sheets and others prefer starters reaching to within half an inch of the bottom, but in this case sections are sometimes not so well filled unless a quarter-of-an-inch starter is fitted on the bottom also. 2. Prepare a block of wood not quite an inch thick to fit inside the section, and nail a couple of strips of wood on one side to keep the block in the proper place within the section. Place on this block the foundation, allowing its upper edge to touch the under side of top bar of section, which must be held in an inverted position and at an angle of about 45 deg. Then run a little melted wax with a spoon or ladle at the highest point in the angle, and allow it to run down by its own gravity to the other end. If the wax is sufficiently heated the foundation will be perfectly fixed (see page 7L of "Guide Book"). Care should be taken not to overheat the wax and not to pour on too much.

[3942.] *A Beginner's Queries.*—I started bee-keeping four years ago, and have now five stocks in my cottage garden. One of them in a skep, which was my first stock, has given me a good swarm each year, and I am expecting one or two this season. 1. If a swarm issued from this skep, followed by another in ten days, should I put an empty skep under the stock that the bees may make a new home at the bottom? 2. Is it wrong to tar bee-hives, as I have done three, painting the front white? The tar does not stick or smell. 3. Is a cheese-box too cold for the bees to dwell in, as I have noticed bees kept in these in the Fens? 4. Can excluder-zinc be used for straw skeps, and where can I get it? Thanking you for reply in the B.B.J., which is most interesting to me. I am a deaf mute, and have been a reader of the B.B.J. for about a year.—WILLIAM HINER, Cambs.

REPLY.—1. If you take a swarm and a "cast" from the skep, it would be too much to expect the bees to build combs and transfer themselves into a new home the same season. If you wish them to do so your best plan would be to endeavour to prevent them from swarming by putting the hive below. 2. No; it is a matter of appearance and convenience. 3. We have known cheese-boxes used, but they have usually had a straw hive fitted within them. They would require protection if used alone. 4. The hole on the top of skep is generally too small to admit of the use of queen-excluder zinc, but if you wish to work supers, you could cut the hole so as to make it large enough to take an adapting-board fitted with a piece of excluder. Any hive-dealer could supply you with it.

Bee Shows to Come.

June 8 to 11, at Reading (Berkshire B.K.A.).—Show of Honey in connection with the Annual Exhibition of the Royal Counties Agricultural Society. **Entries closed.**

June 17 and 18, at Shrewsbury.—Honey Show in connection with Shropshire and West Midland Society's Show. All Open Classes. Schedules, Hon. Sec., 38, Wood Street, Shrewsbury. **Entries close June 10.**

June 22 to 26, at Gloucester (Royal Agricultural Society's Show).—Bee and Honey Section under the management of the B.B.K.A. Prizes arranged in groups of counties for Associations affiliated to the B.B.K.A. **Entries closed.**

July 15 and 16, at Louth.—Show of Honey, Hives, and Bee-appliances in connection with the Lincs Agricultural Society, Bee-department under management of the Lincs B.K.A. Schedules from J. Hadfield, Hon. Sec., Lincs B.K.A., Alford, Lincs. **Entries close June 11.**

July 21 and 22, at Cardiff.—Glamorgan B.K.A., in connection with the Cardiff and County Horticultural Society's Coming-of-Age Show. Members', Novices', and Open Classes. Record Schedule from W. J. Wiltshire, Maindy Schools, Cardiff. Judge, W. F. Reid, Esq., F.I.C., F.C.S. **Entries close July 18.**

July 21 and 22, at Tamworth.—Staffs B.K. Association Annual Exhibition, Honey, &c. Six open classes. Excellent money prizes. Schedules from Joseph Tinsley, Expert and Lecturer, S.B.K. Assoc., 22, Granville Terrace, Stone, Staffs. **Entries close June 26.**

August 4 and 5, at Abingdon Park, Northampton.—Honey Show of the Northants B.K.A. Special prizes for open classes, including one for single 1-lb. jar honey. (Entry free.) Prizes 20s., 10s., 7s. 6d., and 2s. 6d. Schedules from R. Heford, Hon. Sec., Kingsthorpe, Northants. **Entries close July 28.**

August 10 to 12, at Beverley.—Show of Honey, &c., in connection with the Royal Yorkshire Agricultural Society. Schedules and form of entry from John Maughan, Secretary, Blake Street, York. **Entries close July 3.**

August 18 and 19, at Shrewsbury.—Annual Show of the Shropshire B.K.A., in connection with the Shropshire Horticultural Society's Great Floral Fête in The Quarry. Nine Open Classes for Honey and Wax. Schedules from S. Cartwright, Shrewsbury, Hon. Sec. **Entries close August 6.**

Notices to Correspondents.

REV. A. A. HEADLEY (Hants).—*Our Failures.*—We are complying with your request, and the article, which will appear next week, has been revised by the author.

VICTOR (West Kensington).—*Hive Accommodation.*—The usual charge is one shilling a hive.

BEGINNER (Somerset).—*Bees in London.*—Messrs. Abbott exhibited samples of honey produced by the *Daily Mirror* bees at "The Ideal Home" Exhibition held in Olympia in October last, showing that although the honey was not of first-class quality, bees were able to get it even in London.

W. B. (Sevenoaks).—*Old Comb Foundation.*—As the comb is very old and brittle the bees are reluctant to take to it. The foundation from section is covered with old propolis, and should not be used again. The other foundation seems all right, but owing to its age has lost its aroma. You might dip the sheets in warm water sweetened with honey, and then dry them. This sometimes induces bees to accept such foundation more readily. The super foundation is too old and brittle.

M. McLAREN (Oxford).—*Dead Brood Cast Out.*—The bees are undeveloped drones, and such are frequently cast out first when a cold spell sets in, and is a sign that the stock is getting short of provisions. When swarming is retarded from any cause young queens are frequently cast out, but the bees sent are not queens, and as drones are being thrown out the bees are not preparing to swarm.

E. V. DIXON (Walthamstow).—*Bee-districts.*—1. Most parts of Kent are good, but we cannot say if Whitstable town would be suitable. 2. The secretary of the Essex B.K.A. (Mr. G. R. Alder, Rawreth, Essex) would be able to tell you about Hale End Road. 3. You will have to cut the combs apart and remove the pieces built over the frames before you can take them out to make an artificial swarm. 4. The bees were evidently not strong enough to go up into supers during the cold weather we have been having. 5. You could only build up a bee-appliance business by constantly advertising it; local trade would hardly

be sufficient to keep such a business going. 6. The queen is most likely the one from hive No. 1, but you can only tell by an examination of the hive.

L. D. (Hants).—*Time to put on Section-racks.*—1. You can put them on when you see new wax added to the upper cells of comb in frames. 2. The larva will develop and hatch out in due course if not damaged or chilled.

G. GRIERSON (Lanarkshire).—*Foul Brood and Chloride of Lime.*—You will see that as there are no proportions given, we have cautioned our readers on page 201 respecting the use of this powerful disinfectant.

W. OETZMAN (London).—*Drones Cast Out.*—The enclosed bee is an immature drone. When cold, rainy weather succeeds warm, and bees are running short of stores, and they are deterred from swarming, they cast out drones first. It is not a sign of disease, but only a sign that they are getting short of food.

C. C. WILLIAMS (Barnes).—*Dwindling Colony.*—There is nothing in the comb but hard pollen, and no trace of brood or stores of any kind. There is no doubt the bees have died of starvation. The brood you mention as mouldy has been chilled. 1. If you will separate the few clustering bees you will be able to see if they have a queen; but it is quite possible if she has been starved or chilled that she would be useless. Bees generally give their queen the last drop of honey, and she is usually the last to succumb. 2. It would be useless giving so few bees a frame of brood; but if there are sufficient of them you could unite them with another lot. Be sure to feed them before doing so.

M. MELTUSH (Essex).—*Artificial Swarming.*—1. As you are a novice at bee-keeping you should get the "British Bee-keepers' Guide Book," in which you will find full particulars of the different methods of making artificial swarms. 2. No, you will find how to make two stocks from one on page 93. 3. You need not buy a queen. 4. The different methods of introducing are fully explained on pages 135-142 of "Guide Book."

INQUIRER (Dulwich).—*Bees Accepting Virgin Queen.*—A colony that has lost its queen, and not having brood of proper age from which to rear one, will readily accept an unfertilised queen without caging. If the bees accept the young queen and do not intend to swarm, they would destroy the remaining queen-cell. To make sure of their not swarming you should see if the young queen has been accepted, and then remove the queen-cell if the bees have not already destroyed the inmate.

J. W. BEAUMONT (Huddersfield).—*Wax-moth.*—1. The grubs you send are full-grown larvae of the large wax-moth, described on page 165 of "Guide Book." 2. By untimely manipulation, especially in spring or when queens have just begun to lay, or have failed to become fertilised within a reasonable time, a queen may be attacked by workers and hugged to death. This is called "balling." Bees that have not filled themselves with honey are said to have "empty honey-sacs." 3. The bees, if strong, are very likely to swarm when the weather is favourable.

Honey Samples.

Ivy (St. Austell).—The honey is a good colour, but thin, and has a rank and bitter flavour, and may possibly be gathered from wild cherry blossoms.

Suspected Combs.

J. A. UTTELY (Bowden).—As there is foul brood on six of the combs, and from your description it must be of the virulent type, to avoid infecting the other hives your best plan would be to adopt drastic measures, destroy combs, and follow

instructions given on page 180 of "Guide Book."

H. E. S. VINER (Tewkesbury).—There are distinct signs of foul brood. As the spores may be carried by the wind from one spot to another, it is not always the case that the disease is communicated by contact.

Special Prepaid Advertisements.

Twelve words and under, Sixpence; for every additional Three words or under, One Penny.

WANTED, good Swarms. Quote lowest price; or exchange one "Wells" Hive for two Swarms.—KEIGLLEY, Hammerton, York. q 88

BORAGE, yields nectar all day for weeks, sturdy seedlings, 6d. dozen, post paid.—CRAWSHAW, Norton, Malton. q 77

FOR SALE, Honey Extractor (Cowan's), perfect condition, little used.—Particulars, ALEX. TURNBULL, Roxton, Chryston, Glasgow. q 76

14 REASONS WHY TILLEY'S IMPROVED PATENT "WON'T LEAK" SECTIONS SHOULD BE USED BY ALL BEE-KEEPERS, post free; sample and instructions, post paid 6d.; complete Super, with 9 2-lb. patent Sections, 4s. 6d., on rail. Order now to prevent disappointment. Tilley's registered Damp-proof Hive, painting not necessary, Bar-frames fixed by the Bees, movable by the Bee-keeper; less propolis, hence more honey. Particulars post free.—M. H. TILLEY, Bee Farm, Dorchester. q 78

FOR SALE, this season's Honey, good, sample 3d.—DAVID HANCOX, Deddington. q 74

WANTED, Extractor and Ripener, good condition. State price and particulars.—L., c/o B.B.J. q 71

STRONG HEALTHY STOCK HYBRID ITALIANS, 1908 Queen, ready for supers, in Taylor's Claustral Hive, good as new, cost 23s.; price complete, 37s. 6d.—E. PIDDUCK, Expert, Grove Apiary, Alsager, Cheshire. q 60

A FEW STOCKS STILL FOR SALE. Seen by appointment.—WHITEMAN, 51, Woodfield-crescent, Ealing. q 66

GUN FOR SALE, excellent double 12 bore, maker Charles Boswell, Strand, good condition, in case, £5, worth treble; might exchange for wooden house suitable for Bee Work.—GORNALL, Thornycroft, Oxted. q 68

SWARMS WANTED AT ONCE BY LB., guaranteed free from foul brood. State price.—REV. RUNNELS-MOSS, Ladywood Vicarage, Birmingham. q 61

SELL OR EXCHANGE, Bar Frame Hive, Section Crate, Excluder, for Swarm.—COURT, Herne Bay-road, Whitstable. q 64

HONEY, 50 lb., in Sections, for 30s.—LANE, q 66
Whatfield Rectory, Ipswich.

ADVERTISER REQUIRES ONE MONTH'S PRACTICAL INSTRUCTION IN BEE-KEEPING BY THOROUGHLY UP-TO-DATE BEE-KEEPER, preferably in East Sussex.—Full particulars, NOVICE, c/o Bee Journal Office. q 58

SALE, remainder gentleman's Apiary, including Hives, Section Racks, Excluders, Extractor (reversible cages), Honey Ripeners, &c.; Boxes 8 built-out Shallow Frames, 5s. each.—HILLS, Alton, Hants. q 69

EXCHANGE GOOD "WELLS" HIVE AND LIFT FOR NATURAL SWARM.—GREAVES, East Keswick, Leeds. q 73

SECTIONS WANTED.—State price; must be light and new.—THE HONIELADE CO., 23, Moorfields, E.C. q 72

BUY DIRECT FROM THE MAKER.—Section Racks, to hold 21 Sections, and follower, 1s. 3d. each, 3 for 3s. 6d., 6 for 6s. 6d.; free on rails.—MERRY, 69, Rosehill-road, Ipswich. q 59

Special Prepaid Advertisements.—Continued.

BEEES.—20 Stocks, in Standard Frame Hives, 25s. each; Section Crates, Shallow Frames, with comb; 6 Skeps, Strong Stocks.—HILL, Ashley, Stockbridge, Hants. q 63

EXCHANGE PHONOGRAPH RECORDS FOR STOCK OF BEEES, Italian preferred, on Standard Frames.—NEWTON, 319, Elland-road, Churwell, Leeds. q 70

QUEENS, calculated to be profitable for three years, 7s. 9d. each; from June 21 to end of July, 5s. 9d. each; August, 4s. 9d.; September, 6s. 6d.; October, 7s. 9d.; Stock of this race of Bees has been known to fill 105 1 lb. Sections, besides 40 lb. Extracted Honey. Prizes have been won for Honey gathered by this race of Bees at Birkenhead, Kilmarnock, Ayr, Glasgow, and Edinburgh. See account of Apiary, "The Weekly Guide," November 2, 1892.—POSTMASTER, Breechwood Green. q 65

3 BAR FRAME HIVES, also few appliances, 15s., or useful exchange.—8, Halkin-street, Leicester. q 62

BEE APPLIANCE BUSINESS FOR SALE, large demand, increasing fast, large orchard, good Stock of Bees and everything needed for same, an ideal spot. Price £300.—Principals only write to X. Y. Z., c/o BEE JOURNAL. q 57

BEEES FOR SALE, Swarms, 8s. each, or 2s. 3d. lb.—R. WHITTING, Mauea. q 80

FOR IMMEDIATE DISPOSAL, 1 Airedale, 2 Non-swarming Single-walled Hives, good condition, 6s., 7s. 6d. each, f.o.r.—TAYLOR, Moorside, Old Lindley, Holywell Green, Halifax. q 81

SWARMS, June delivery, 12s. 6d. each, carriage paid.—L. MATTHEWS, Great Rollright, Oxon. q 83

YOUNG MAN, single, wanted, to assist with Bees, make appliances, and be generally useful.—BUCKS, c/o BEE JOURNAL. q 85

"**BRITISH BEE JOURNAL**," 1903-1909. What offers? Some bound.—MRS. S., c/o BEE JOURNAL. q 86

NEW "W. B. C." HIVES, 14s. 6d., complete; also appliances.—J. BOWDEN, Broomhill, Witley, Surrey. q 79

QUEENS, STOCKS, NUCLEI NOW READY. List on application. Virgins, 2s.; Fertiles from 3s. 8d., post free.—CHARTER, Tattingstone, Ipswich. q 87

BRICE'S QUEENS, all selected, Hybrids 5s. 3d., Blacks 4s. 6d., Virgins from 2s. 6d., in introducing cage.—BRICE'S APIARIES, Otford, Kent, and Thornton Heath.

CLERK AND CANVASSER WANTED, for dairy trade; preference given to one with knowledge in manipulation of Bees.—FRANK NYE, Dairyman, Littlehampton. q 48

WANTED, several good prime Swarms. Quote lowest prices. Kodak Folding Camera, 1/2 plate, first-class order, will exchange for three good swarms.—BEBBINGTON, Windsor Villa, Helensburgh, N.B. q 36

QUEENS, choice 1908, bred from my non-swarming stocks, 3s. 6d. each, per return.—TAYLOR, "Hollyhurst," Boldmere-road, Wyde Green, Birmingham. q 38

FOR SALE, Freehold Farm, 11 1/2 acres; small house, cottage, stable, barn, orchard, &c.; good honey district; within 4 miles Uckfield, Sussex.—Apply, W. KENWARD, 1, Cliffe, Lewes. q 50

QUEENS, Doolittle's Famous Strain.—Customer writing May 5 says: "The Golden Virgin had last season was wintered on 4 frames, now cover 10 frames, packed to overflowing; shall have to give another set of 10 frames on top to give queen room, as our honey season will not be on yet." Is not this what all bee-keepers want? Hives boiling over before the honey flow arrives. Virgins now ready, 1s. 6d.; Fertiles shortly, 5s. each.—D. TAYLOR, Ilminster. q 12

Editorial, Notices, &c.

PROMINENT BEE-KEEPERS.

DR. C. C. MILLER.

It is with much pleasure that we are able to present our readers this week with a portrait of Dr. C. C. Miller.

He was born on June 10, 1831, at Ligonier, Pennsylvania, and after leaving school graduated at Union College, Schenectady. He then studied medicine,

his playing and singing when we visited him at Marengo some years ago. His first commencement with bees was in 1861, and we cannot do better than give in his own words what he tells us about his experience. He says:—

"When I was a little chap I found a bumble-bees' nest, from which small beginning a large and flourishing apiary never grew. Indeed, it was not till I was thirty years old that I undertook again to do anything in the way of management of bees. At that time my wife captured a runaway swarm, and hived it in a sugar-



DR. C. C. MILLER, OF MARENGO, U.S.A.

graduating from the University of Michigan, and taking his M.D. degree at the age of twenty-five. After settling down to practice, he says, "it did not take more than a year for me to find out that I had not sufficient stock of health myself to take care of that of others," so with much regret he gave up his profession. In 1857 he married, and spent some years in teaching vocal and instrumental music, and was for several years also principal of the Marengo public school. Dr. Miller's musical compositions are simple and delightful, and we were much charmed with

barrel. With not the slightest thought of ever becoming a practical bee-keeper, I became quite interested in the little creatures. The first number of a bee-journal ever published on the continent, the *American Bee Journal*, appeared at the beginning of that year, 1861, but it never occurred to me to inquire whether such a thing was in existence. I did, however, get hold of Quinby's book in the course of time, and made hives after the instructions there given. They were box-hives, for at that time the book had nothing to say about movable combs.

"Of course the bees were blacks. Five years later I got my first Italian queen. Whatever may be the case in England, there was such a marked difference between the work of the blacks and the Italians that for a number of years I made the effort to weed out all black blood. But that is not an easy thing, and there has never been a time when I had none but pure Italians. Indeed, for some years I gave up trying to keep pure yellow blood, and bred from the colonies that gave me the biggest yields, whatever the colour; and the best yielders generally had more or less black blood in them. As a result, I now have bees that are hustlers, and I feel sure that under the same conditions they will store more honey than any bees I formerly had, either yellow or black. Alas that by the side of every rose there is likely to be a thorn! Along with the hustling disposition there has been developed a temper that makes the bees veritable little demons to sting. If I had it to do over again, I would stick to pure Italian blood in the hope of having gentler bees. I have now some pure Italians, purporting to be of the best strains, but they don't begin to store like my vicious hybrids bred for storing.

"It would be a long story to tell of all the successes and failures of those first years—perhaps the failures would make a longer story than the successes, even if not so interesting. Winter losses were heavy, so heavy, in fact, that in spite of buying colonies at times, at the end of eleven years I had only two colonies. These two were the survivors of fifty that went into winter quarters the previous fall. But as I was only playing at the business I didn't care.

"One reason for some of my failures was that my business kept me away from home, with only an occasional chance in some years to see the bees. In 1876 I determined to give myself a chance to do better, and for the sake of living where my bees were accepted the charge of the Marengo public schools at a salary of \$1,200, less than half I could have had by staying away. Just how rich a man I should have been if I had not made that change I cannot tell. But I suppose I should have died years ago in spite of making more money. I'm still alive—that's a good deal; and I have had, and still have, the happiest kind of life—and that's a good deal more.

"In 1878 I gave up teaching, and since then have been nothing but a bee-keeper. The largest number of colonies I kept never exceeded 400, in four apiaries. For the past few years I have run only two apiaries, and the coming year expect to have only one.

"Unfortunately, I had a poor location, white clover being the only thing upon which I could depend for surplus, so I cannot boast of such big yields as some

others. In late years, however, fall pasturage has helped a little. The greatest trouble with white clover is that some years it will bloom abundantly but yield no nectar. One year, instead of getting a crop of honey, I had to feed my bees with 2,800 lb. of sugar to keep them from starving. I'll give you my three best years.

"In 1882, from 174 colonies, I took 16,549 lb. of comb honey. In 1903, 124 colonies gave 18,150 lb., increasing to 284. The best colony gave 275 lb. (300 sections). Last year, 1908, with 129 colonies, I took 19,480 sections (I did not weigh them). That was not so bad, considering that all the work in the apiary and most of the other work were done by a man of seventy-seven and a none too strong woman, my sister-in-law, Miss Emma M. Wilson, who has been my assistant for twenty-six years.

"One's interest in bee-keeping never dies. I have just as keen a relish in studying bee-problems to-day as I had forty-eight years ago. Just the same enjoyment in reading the bee-journals, and I feel pretty well acquainted with quite a number of the writers in the B.B.J. Best wishes to all its readers and writers."

Dr. Miller is well known to our readers by his writings, which are conversational, terse, and to the point, often tinged with the fun his good nature is unable to suppress. He is the author of "A Year Among the Bees," 1886, "Bee-culture," 1901, and in 1903 he published that charming book, "Forty Years Among the Bees," which gives an excellent account of his successful methods of honey production. Dr. Miller has been a valuable contributor to the bee-journals for many years, and owing to his worthy character is held in high esteem by all who know him. His whole life has been one of unselfish helpfulness, and we esteem it a privilege to have been personally acquainted with him. On page 147 of the B.B.J. a visit paid to his apiary was described by one of our correspondents, and a photograph was given of this veteran bee-keeper among his bees. May Dr. Miller be spared many more years to continue his usefulness.

REVIEWS OF FOREIGN BEE-JOURNALS.

By "Nemo."

Congress for the Suppression of Adulteration.—Adulteration is carried on to such an extent and has become such a menace to health that steps are being taken to wage war against it. With this object in view an International Congress has been held in Geneva, the proceedings of which are reported in the *Bulletin de la Société Romande d'Apiculture*. Amongst other things, the adulteration of honey was considered, and in

this, as in many of the other discussions, the representatives of different countries were prepared with printed definitions. The following are some of those referring to honey:—

Belgium: Natural honey must only contain the sweet substance (inverted sugar) elaborated by bees from nectar of flowers or other juices collected on plants.

Italy: It is forbidden to sell spoiled or unwholesome honey or that adulterated by the addition of water, starch, syrup, treacle, dextrine, saccharine, or other organic or mineral substance.

Switzerland: Honey is the sweet substance which the bees produce and transform in a special organ from the sweet juices of flowers and from other parts of plants, the product of this elaboration being placed in the waxen cells of the combs.

France: Honey is the pure product, elaborated by bees and extracted from combs without the introduction into it of any other substance.

Chili: Bees' honey dissolved in water must not show any precipitate.

After discussion by the congress, and in view of the possibility of bees being fed with syrup for the purpose of augmenting the returns, the following definition was finally decided upon:—

Honey is the substance that bees produce in transforming the sweet juices collected on plants, and which they store in their combs.

M. Prevost, the Swiss delegate, said it was now for chemists to come to the aid of bee-keepers by finding methods for determining with ease any adulteration. The immense progress made in chemistry during the last few years gives a reasonable hope that such easy methods will be forthcoming.

Harness Blacking.—M. Bourgeois gives the following recipes in *L'Abcille de l'Aisne*:—Dissolve in a vessel immersed in boiling water 100 parts of scraped beeswax, then add 10 parts of powdered Prussian blue and 50 parts of finely-pulverised animal charcoal; mix well, and remove from the fire. Add sufficient spirits of turpentine to make it into a stiff paste when cold.

Honey-soap.—Cut 2 lb. of yellow soap into thin slices and put into a saucepan with sufficient water to prevent the soap from being burnt. Place on the fire, and as soon as all the soap has dissolved add 1 lb. of honey and stir until the whole begins to boil. Then remove from the fire, add a few drops of essence of cinnamon, pour out into a deep dish to cool, and then cut into squares. It improves by keeping.

The Production of Wax.—In districts where honey is of poor quality it may be

profitable to work for the production of wax. M. C. Armould has been experimenting with this object in view, and describes the results in a series of articles in *L'Union Apicole*. He comes to the following conclusions:—

1. Artificial swarms placed at the commencement of the honey-flow into empty hives, and fed for a short time with sugar-syrup or honey, rapidly fill the hives with combs.

2. Common skeps, either empty or furnished with combs, and supplied with swarms of equal strength, will each store nearly the same quantity of honey, which allows one to assume that wax-secretion is not always a hindrance to the harvest.

3. Natural swarms generally work better than artificial ones, and will even catch them up, if not started too soon before them.

4. Hives with supers are equally good for the production of wax. All swarms placed in empty hives, containing supers with a little honey in the cells, will build even faster than if they were supplied with sugar-syrup.

5. Intensive feeding, either with sugar or honey, although complicated, is necessary, and this must be followed by methodical swarming in a reasonable manner.

Correspondence.

The Editor does not hold himself responsible for the opinions expressed by correspondents. No notice will be taken of anonymous communications, and correspondents are requested to write on one side of the paper only, and give their real names and addresses, not necessarily for publication, but as a guarantee of good faith. Illustrations should be drawn on separate pieces of paper. We do not undertake to return rejected communications.

OUR FAILURES.

[7484.] Many failures in bee-keeping arise from ignorance or want of energy, and from physical inaptitude, to which must often be added the disadvantage of small means. Of these it need here only be said that it is the duty of every experienced bee-keeper to discourage anyone from starting an apiary whom he recognises as lacking the necessary qualifications, and that experts especially should refrain from conveying the idea that anyone can handle a hive offhand with the ease that they themselves display in the bee-tent, or that dexterity alone is necessary to ensure success. All should remember that every failure is a discredit to the industry they profess to cherish, and that amongst the most fruitful sources of disease is a neglected, dwindling apiary.

Again, there is no one whose business or pleasure often leads him to visit apiaries but must have noticed many that, for no apparently adequate reason, are practically

non-remunerative. The owner seems to be no longer able or willing to do the bees justice; he will probably tell you that the labour is too great; he has no time to attend to them. Glancing round the garden, one can recognise the parent hives; the progeny, at first accommodated in skeps, has overflowed into makeshifts and queer commercial boxes. In full sympathy with a really busy man, it seems worth while to inquire into the causes of his failure, not without some hope of being able to suggest a remedy.

The two main causes of such a state of things are a faulty equipment and the want of a good system of management. Much depends on a fair start, and an odd lot of hives at the outset is a heavy handicap. For comfortable bee-keeping—and comfort means the saving of time and labour—a beginner should, if possible equip himself with two hives of the same size and by the same maker, one to be colonised, and the other for the time to remain empty. If this cannot be managed, the second hive, when acquired, must be like the first. Practise economy in everything; let the hive be quite simple; eschew all new devices; but do not stint the number of hives. Some will at times be vacant, but if used on the system to be described, they will pay their cost over and over again; and a good hive, if frequently repainted, will last for many years. Secondhand hives, be they full or empty, are no bargain for a beginner; let him buy them if he likes when he has learned to judge of them properly.

A man should buy hives suitable to his physical powers. Broadly speaking, there are now, and probably always will be, only two kinds in use; the "W.B.C." type with loose outer case, a limited brood nest, and frames at right angles to the entrance; and the long, double-walled Combination hive, with frames parallel to the entrance. Each has its advantages, but the former is much less laborious to handle, and a man of moderate strength should choose it in preference, unless he can reckon on always having help at hand. Everything, from supers, frames, &c., down to the very entrance-doors of the hives should be interchangeable throughout the apiary. In this respect the "W.B.C." hive arrangement for working both shallow-frame and section supers at the same time is convenient. The writer, who although he constantly recommends this hive has but recently acquired one, secures the same advantages in long hives by shortening the ends of his shallow-frames, and making the super-boxes, which are double-walled, of exactly the same square outline for frames or sections.

He loses both time and labour who sets himself to produce first-rate comb-honey in an unsuitable district. His hives may be

boiling over with bees in the spring, but unless there are broad acres of some special honey-plant, such as clover, sainfoin, or mustard, or great wealth of fruit blossom, or if the soil is such that a fortnight's hot sunshine parches it, his sections will be but second-rate, and his bees, having little else to do, will turn to swarming; while, on the other hand, working throughout the year on woodland, moor, or meadow they might have filled his shallow-frames with honey.

The question of swarming leads to the main cause of trouble, indiscriminate increase. The busy man, of all others, should decide how many stocks he is able to manage comfortably in the heat and stress of summer, and with *little more than half* that number he should always go into winter. *Half* would be safer, especially for the comb-honey producer; for, say what you will, bees will swarm, and the best course for the small apiarian is to keep his stocks strong, let them swarm if they will, and make the swarms do the work. The trouble and time spent are reduced to a minimum, and the only requisite is proper hives in which to accommodate the swarms. There is nothing new in this system, but it is much neglected. Its main principle, that of strengthening the swarm by the addition of the flying bees from the parent stock, was recognised and acted on more than 100 years ago by Schirach, and as elaborated by Mr. Heddon in America it was described by Cheshire in his "Bees and Bee-keeping" in 1886, since which time the present writer has constantly practised it with complete success, and he is convinced that there is no way in which a small apiary can so easily be kept in hand and worked with profit.

We will suppose that your hives are supered. When a swarm comes, take it as usual, and let it stay where it is while you place a fresh hive close alongside the parent, but turned aside at about half a right angle from the old line of flight. The same evening open the parent hive, setting the super on one side for the moment; take out two frames of brood (no queen cells) and one of honey, and place them in the new hive. Fill up each hive with foundation and empty combs. Set the super on the new hive, and run the swarm in by the entrance. In a day or two, when the new colony is quite at home, turn its hive to face the same way as the parent. The two hives will now be practically on the same stand.

In about eight days from the issue of the swarm another would be due, so two or three days in advance of this date, on a sunny morning, lift up the old hive very gently and remove it to quite a new stand. The flying bees will all join and strengthen the swarm, which should now be working hard in the super, while the old colony will

be so far depopulated that it will not have the heart to swarm again. It will become strong enough under its new queen, as the brood hatches, to fill a super of its own, should the conditions be suitable. At any rate, it should store several combs in the body-box. In the unlikely event of a second swarm issuing from either hive let it stay in the skep till the following night, and then return it, removing the queen as the bees run in if you think fit, otherwise the bees—or fate—will settle the succession.

In the autumn remove the older queen, and join the two stocks, leaving plenty of stores. No candy should be necessary. The superfluous stored combs are set aside carefully for feeding and stimulation next spring, and to serve again, empty or stored, when swarms come; the spare hive is overhauled and repainted at leisure; and the bee-keeper goes into winter with his proper number of hives containing strong colonies under young queens, and everything shipshape and in the best condition.

In the event of its being impossible to provide enough extra hives, the system could, to some extent, be carried out by using makeshifts. In this case the contents of the parent hive would be removed into the makeshift, which would take its place; there would be more trouble; the chance of the extra super must be foregone, and other advantages would be lost. In working as recommended, the busy man may, if he pleases, spare himself the trouble of doing anything to the parent hive beyond removing the super. This was Mr. Heddon's procedure, but I have found it advantageous to transfer combs to the swarm in proportion to its strength, and to the amount of brood in the parent hive. It is a matter of judgment; if made too strong there is more chance of a second swarm.

It will be noticed that to carry out this scheme all swarms must be identified, and as this in itself *takes time*, and is not always an easy matter if the issue has escaped attention, I hope our Editors will allow me to repeat the method of identification that I sent them many years ago; not my own device, for the flouring of bees for recognition dates from the days of Aristotle. When a swarm must be hived, unless you are quite certain whence it came, take a flour-dredger with you as well as a skep. There will generally be a few bees somewhere outside the skep after turning it over; if not, detach a few from the cluster, and give them a thorough dusting, repeating it if necessary. Forthwith remove the skep, and place it where the bees are not likely to find it; it need not be taken far if well concealed. The dusted bees, disheartened by the flour, and having lost their fellow-swarmlers, will be-

fore long make their way to the apiary, where they will be seen roaming disconsolately, like belated bee-ghosts. In from five to thirty minutes from their dusting they will be fanning vigorously on their own alighting-board, and all doubts as to the parent hive will be at an end.

Should the position of the apiary render the issue of swarms undesirable, one of the various non-swarmling methods known to readers of this journal can be adopted. The best perhaps is that recommended by the late eminent bee-keeper, Mr. Alexander. But none of them are infallible, and their success involves the occasional purchase and introduction of fresh queens. The system here advocated is especially suited to the busy man. It is at once orderly and economical, with a minimum expenditure of time and trouble.—LIEUT.-COL. H. J. O. WALKER, Budleigh Salterton, Devon.

BRITISH BEE-KEEPERS' ASSOCIATION

[7485.] Mr. Hepburn's carefully-thought-out letter (page 202) in your issue of May 27 demands discussion, as it contains the germ of that organisation to which the present importance of the bee-keeping and honey industry compels attention. The corner-stone of Mr. Hepburn's scheme is centralisation, which, being attained, would make the Association a power to act promptly, to look to for a lead in any question relating to the craft, and, equally important, to provide for education in the higher branches of apiculture. Yet this centralisation has some very cogent objections to it, and, though the principle is in the main sound, before it can come into practice they must be met and disposed of.

Firstly, it would tend to destroy the *esprit de corps* of the counties. Let it be remembered that where County Councils give grants to the associations it is because they are *county* associations, and as such deserving of their support; also there are many generous local influentials who subscribe for the same reason. In neither instance would they contribute outside the county, as very often, not being bee-keepers, they have no interest in the industry. Among bee-keepers, too, there exists that justifiable pride to see their own county rank high among competitors; they prefer to manage their own affairs; their own officials they know and have confidence in; the names on the list of members are those of neighbours whom they know. They would probably object to the whole of the funds going to London, to filtrate back again, and would suffer no control from a central body.

There is another probability which must be reckoned with. The census papers of

the Board of Agriculture are now among us, and we hope that legislation on the foul brood question is in the immediate future. Should that happen, probably the County Councils will be empowered to administer the Act. In the county associations they have at hand capable officials for the purpose, and, directly or indirectly, it means an accession of funds to the associations; if they work in unison, possibly a share in the expert expenses.

Will the county associations, financed to some extent by the County Councils, find any advantage in sinking their individuality? I am afraid not.

But that there should be one centre for these separate county associations seems to be of paramount importance, for the reasons given in the first paragraph. To "encourage, improve, and advance bee-culture" we need now those who know something more than how deftly to manipulate. We want men educated to the most modern improvements, to the best way of combating diseases, and these cannot be produced unless there is a school to teach them. Since its formation in 1874 the British Association has done its work well, but the time has now come when, as Mr. Hepburn puts it, "a complete reorganisation should take place."

The affiliated associations receive benefit from the parent association. It is the link which binds them all together. I cannot see how they can merge themselves into one "British Bee-keepers' Association," but I do think they might contribute more to its funds than they do at present.—J. SMALLWOOD, Hendon.

[7486.] I read letter No. 7468 (page 202, B.B.J., May 27) with very great pleasure, and was delighted to think that, after all, someone had brought forward this matter. I trust that as a result practical interest may be aroused and that readers of the B.B.J. will discuss the matter freely and in a friendly spirit, and something good may come of it. I must confess personally I cannot accept the whole of the suggestions put forward by Mr. Hepburn, as it appears to me the Association, as he wishes it, would be very much like a "trust," and at the present time I think we are suffering quite enough from these combines. But may I be allowed to make a further suggestion? In our various districts we have ladies and gentlemen of no small repute and influence, and if they were inspired by zeal similar to that of General Booth, for instance, to further at all costs the cause which makes such a particular claim upon them, I think we should soon see a great change for the better in bee-keeping, and the industry would be put upon a proper footing.—WILLIAM LLOYD, Lancaster.

VAGARIES OF SWARMS.

AN INTERESTING INCIDENT.

[7487.] As I derive much benefit and pleasure each week from reading in the B.B.J. of the experiences of others, I thought the following coincidence might interest your readers. On starting bee-keeping a few years ago, I arranged with a neighbour—who lives about one and three-quarter miles away—to buy his next swarm. As one was expected to come off shortly, I prepared a hive fitted with foundation in readiness in my garden, and being by chance in the vicinity when the swarm issued, I helped to hive the bees in a skep. They seemed quite contented for about ten minutes, then they suddenly rose again, and, taking the proverbial "bee-line," they crossed a river, a wood, and a village, went right to my home, and entered the hive intended for them.

We followed the swarm the whole time, and arrived just as the vanguard reached the hive, where, on opening the entrances, they made themselves quite at home.

Towards the end of the journey the bees went much slower, resting a minute or two on the grass and hedges before flying on after the main body.—H. E. LEYLAND, Cumberland.

BEEES DOING WELL.

[7488.] If I may judge from my own bees, stocks in this district have come through the winter very well. It was not until the first week of last month that I was able to clean the hives out, and I found all the combs full of brood. Last autumn I left the stocks with ten brood-combs apiece, well filled with honey, and therefore they did not require feeding at all this spring. There were a great number of young bees about, and plenty of honey, both sealed and unsealed. Last week I put on the supers, at the same time uncapping the honey in those brood-combs which seemed to be capable of taking more brood, all the honey so uncapped being fresh—*i.e.*, this year's honey. The bees are now hard at work in the supers, and have cleared out the honey from the above-mentioned combs, some of which already contain eggs. It is some years since I have found my bees in such good strength at the commencement of the season, in spite of the fact that I lost a great many during the first few days of April, owing to the very cold winds we experienced at that time.—WALTER ED. ZEHETMAYR, Twickenham.

INTRODUCING QUEENS.

[7489.] I should like to call your readers' attention to the above subject. Every year I execute orders for queens

"to put into long queenless stocks with plenty of bees." Then have a repeat order, with a letter saying "that the last introducing was a failure, as the queen was turned out next morning." Now it stands to reason that if the instructions for introducing were carried out correctly, we must look elsewhere for the cause of failure.

Bee-keeping proper starts in May, and if there are plenty of bees, but no brood, the natural conclusion to draw is that the old queen has bred in the early months, and then been killed and a young queen reared. (If the stock had been queenless through the winter very few bees would be left.) It takes practically a month from the time the cell is started until she lays, so there would naturally be no brood left during the last week before the queen commenced to lay.

Many people, seeing no brood but plenty of bees, jump to the conclusion that the stock is queenless, buy a queen, and usually get her turned out at the entrance, dead, soon after. Before ordering queens bee-keepers should make certain that the stocks are queenless and that no queen of any kind exists, and if this is done both money and trouble will be saved.—HENRY BRICE, Brice's Apiaries, Thornton Heath.

HOW DO BEES BECOME QUEENLESS?

[7490.] A hive in my apiary, which gave the best crop in 1908, was selected for drone-breeding in April, 1909, by inserting in it a frame of drone-foundation. Early in May an examination was made, and this frame was found to be packed with fine, healthy-looking drone-brood, but there was not a single egg in the hive. A search was then made for queen-cells, and two partly-formed ones only were found. Has any brother bee-keeper had a like experience?—J. M. BEST, St. Austell.

STINGS.

[7491.] While some people suffer little or no pain from a bee-sting, others feel it intensely not only from pain, but also from swelling, stiffness, irritation, and disfigurement. What are the reasons for this contrast? Perhaps some of the readers or the Editor of B.B.J. will throw some light on the subject. Is it the poor quality of blood that allows the formic acid such power? Does a person taking alcohol suffer more than an abstainer? Is it impurities in the blood or the reverse? I have read the interesting articles on stings and rheumatism, and

should like to know about the normal conditions.—GEO. GILES, Walsall.

[It is as difficult to explain why some people suffer more from stings than others as it is to tell why different constitutions are affected differently by various diseases. Stings are not all alike, some being more painful than others. The pain felt is frequently due to the mind dwelling on it, and imagination has a great deal to do with it. The sting from an enraged bee is also much more painful and is more apt to cause swelling. Bees are very sensitive to disagreeable odours, and that of alcohol is particularly obnoxious to them, consequently those taking it are more liable to be severely stung than abstainers.—ED.]

BEES TRANSPORTING EGGS.

[7492.] On May 22 I took off a rack of shallow frames for extraction as they were well filled. When I came to extract I found on one of the frames (about the middle one of the group) a perfect queen-cell and a perfect drone-cell containing larvæ in an advanced stage of development. No other trace of eggs was to be found in these shallow frames, and these two were found at the bottom of the comb, one on each side.

Is not this unusual, and may it not be evidence in favour of the worker-bee carrying the eggs? The queen-excluder was in use, and had been securely fixed by the bees between this rack and the brood-chamber.

Perhaps one of your many experienced readers would kindly give us his opinion?

Up to this week bees in this neighbourhood seem to be doing well.—NEVILLE A. HOLT, Canterbury.

A GOOD REPORT FROM STAFFS.

[7493.] I have no wish to cap Mr. B. J. Mitchell's report in B.B.J. of May 27 (page 204) as to the forward condition of his bees, but it might interest your readers to hear of two of my hives; these were last-year swarms, fed in the autumn, but not this spring. No. 2 hive on May 16 had nine frames full of brood (or practically so). I put on a crate of ten shallow frames that day with thick foundation. No. 3 was in a similar state, and I put on a crate of nine shallow frames with empty comb, kept from last season. On examining this evening, I find in both cases that all these frames are practically full of honey, with a large percentage of it capped. I belong to the Staffs B.K.A., and the expert considered my bees in a very forward state on April 24.—CHARLES E. ELWELL, Codsall, Staffs, May 27.

PROPOSED B.K.A. FOR GLOUCESTER.

[7494.] The question of the advisability of starting a bee-keepers' association for Gloucestershire has been talked over by some interested bee-men, all of whom favour a meeting being held to consider the matter.

The visit of the "Royal" Show to Gloucester seems a favourable opportunity, and it therefore appears best to hold a gathering during the show week, at which representatives of the British Bee-keepers' Association have promised to take part. The following local gentlemen are taking the initiative in the matter: G. Wayland Ancrum (Gloucester), A. W. Baker (Longlevens, Gloucester), Chas. Calvert (Cheltenham), James J. Hillman (Gloucester), O. Gordon Reid (Cheltenham), J. E. Swaffield (Cheltenham), and they invite the presence of all bee-keepers to this meeting, which will be held on Tuesday, June 22, in the Class Room at the Friends' Meeting House, Grey Friars, Southgate Street, Gloucester, at 6.30 p.m. It is impossible to send an invitation to all who would wish to attend, so we hope that B.B.J. readers will kindly inform any bee-keepers they know of and ask them to be present.

Light refreshments will be provided during the evening.—E. J. BURTT.

THE LATE W. BROUGHTON CARR.

Several correspondents have asked if they could get a photograph of Mr. Carr. The photographers, Messrs. Brown, Barnes, and Bell, The Royal Studios, 31, Bold Street, Liverpool, are prepared to supply cabinet portraits at 1s. 6d. each, and we must ask those desiring to obtain a copy to apply direct to this firm.

TRADE CATALOGUE RECEIVED.

GEORGE ROSE (*Seeds and Bees, Ltd.*, 50, Great Charlotte Street, Liverpool).—This is a very comprehensive illustrated catalogue of all that a bee-keeper may require. The copy before us (containing sixty-four pages) is mainly devoted to bee-keeping and the various appliances connected with it; it also includes bee-houses and a list of goods used in poultry-rearing. There is also a list of new and second-hand bee-books, of which Mr. Rose makes a speciality, as he does also of seeds of bee-flowers. We would call attention to an error on page 24, where under 567 is mentioned *phenol* or *phenyle*. These are two distinct substances, and should not be confounded. *Phenol* is a virulent corrosive poison, and was formerly used in great dilution as a remedy for foul brood. *Phenyle*, on the other hand, is not only as powerful a disinfectant as, but is superior to, carbolic acid or phenol, inasmuch as it is entirely

non-corrosive and non-poisonous as regards human beings and animals. We deem it right to caution readers, because if they use phenol in the proportions recommended in "Guide Book" for phenyle the consequences may be disastrous.

Queries and Replies.

[3943.] *Bees Deserting Skep*.—Could you give me a reason for the following annoying experience? Towards the end of last season I purchased and safely introduced into one of my hives a "British Golden" queen, purchased from Mr. F. W. L. Sladen. On Friday morning, May 21, this hive sent off a strong swarm, which I hived safely in a skep, and as it was not convenient to transfer the bees at once to a frame-hive they were left in the skep, where they worked comfortably till Saturday morning, May 22, and built a fair-sized piece of comb. On Saturday morning they deserted the skep, and settled again in a bush. Thinking it was no use putting them in the skep I at once started getting the hive ready; but in a few minutes they all flew away, and in spite of trying to follow them, they were soon lost to sight. The queries that arise are: 1. Why did they leave the skep after working comfortably for a day? 2. About how far would you expect them to fly? 3. Could I claim them if I found out where they were? I am offering 10s. reward for information leading to their recovery. There are no golden bees to my knowledge nearer than Maidstone (fourteen miles), so there could be no doubt as to where they came from. 4. Are bees of the stock likely to now go back to black? I am strictly an amateur, only keeping two stocks, but I take a great interest in bee-keeping, and look forward with pleasure to every Thursday and the B.B.J., in which I should be pleased to see replies to my queries.—W. BEADLE, Seven-oaks.

REPLY.—1. Your experience is not uncommon, as it sometimes happens that bees, for some reason or another, are not satisfied with the quarters provided for them. It is difficult always to tell the reason, but sometimes when placed in full sunshine and the hive becomes too hot bees leave, and they have been known also to desert their hives if disturbed by mice or the death's-head moth. 2. If the swarm is not hived when it first settles it is usual for the bees to rise and decamp. They may fly a mile or more before they settle again. 3. No; as you have lost sight of them you have no further claim. If the finder brings them to you in response to your advertisement he would be entitled to the reward, but if he prefers to keep them he would be justified in doing so. 4. If the young queen mates with a black drone you will have cross-bred bees; otherwise, if she happens to mate with a drone raised from eggs laid by the golden mother her progeny would be pure bred.

[3944.] *Sending Bees to the Heather*.—Being a regular subscriber to your interesting journal, I shall be grateful for any advice and help you can give me in replying to the following queries: 1. Although I am situated a great distance from any moors, I am desirous of getting a crop of heather honey. If I sent fifty or sixty stocks to the moors, do you think I stand any chance of success, assuming, of course, the bees were in proper condition and weather favourable? 2. Can you inform me of the nearest heather to this district, and also the easiest way to get at it by rail from here? 3. About what date would it be coming into bloom and ready for bees? 4. What weight of honey per

stock might be expected in an average season? 5. Can you say how frequently it occurs that the heather crop is a total failure? 6. Can you tell me of a bee-keeper living near the moors who would be willing to give some assistance, and make arrangements for me (for a consideration, of course)? Thanking you in anticipation, I enclose name for reference, and sign—AMATEUR, Worcestershire.

REPLY.—1. Very small chance, as bee-keepers living close to the heather near your district find that only occasionally any heather honey finds its way into the supers, and then only in insignificant quantities. 2. The largest tract of heather is at Sutton Park, about ten miles distant—by road or rail to Birmingham, then to Sutton Coldfield or Fair Oaks. 3. About the beginning of August. 4 and 5. See reply to No. 1. 6. Apply to Mr. G. Franklin, expert to Warwickshire B.K.A., Fair View, Barton Grange, Kenilworth, who could put you in communication with a bee-keeper near Sutton Park.

Bee Shows to Come.

June 17 and 18, at Shrewsbury.—Honey Show in connection with Shropshire and West Midland Society's Show. All Open Classes. Schedules, Hon. Sec., 38, Wood Street, Shrewsbury. **Entries close June 10.**

June 22 to 26, at Gloucester (Royal Agricultural Society's Show).—Bee and Honey Section under the management of the B.B.K.A. Prizes arranged in groups of counties for Associations affiliated to the B.B.K.A. **Entries closed.**

July 15 and 16, at Louth.—Show of Honey, Hives, and Bee-appliances in connection with the Lincs Agricultural Society. Bee-department under management of the Lincs B.K.A. Judges, Messrs. F. J. Cribb and W. Herrod, F.E.S. Schedules from J. Hadfield, Hon. Sec., Lincs B.K.A., Alford, Lincs. **Entries close June 11.**

July 21 and 22, at Cardiff.—Glamorgan B.K.A., in connection with the Cardiff and County Horticultural Society's Coming-of-Age Show. Members', Novices', and Open Classes. Record Schedule from W. J. Wiltshire, Mandy Schools, Cardiff. Judge, W. F. Reid, Esq., F.I.C., F.C.S. **Entries close July 18.**

July 21 and 22, at Tamworth.—Staffs B.K. Association Annual Exhibition, Honey, &c. Six open classes. Excellent money prizes. Schedules from Joseph Tinsley, Expert and Lecturer, S.B.K. Assoc., 22, Granville Terrace, Stone, Staffs. **Entries close June 26.**

August 4 and 5, at Abingdon Park, Northampton.—Honey Show of the Northants B.K.A. Special prizes for open classes, including one for single 1-lb. jar honey. (Entry free.) Judge, Mr. W. Herrod. Prizes 20s., 10s., 7s. 6d., and 2s. 6d. Schedules from R. Hefford, Hon. Sec., Kingsthorpe, Northants. **Entries close July 28.**

August 10 to 12, at Beverley.—Show of Honey, &c., in connection with the Royal Yorkshire Agricultural Society. Schedules and form of entry from John Mangban, Secretary, Blake Street, York. **Entries close July 3.**

August 18 and 19, at Shrewsbury.—Annual Show of the Shropshire B.K.A., in connection with the Shropshire Horticultural Society's Great Floral Fête in The Quarry. Nine Open Classes for Honey and Wax. Schedules from S. Cartwright, Shawbury, Shrewsbury, Hon. Sec. **Entries close August 6.**

Notices to Correspondents.

WALTER MORGAN (Kent).—*Certified Experts in Kent.*—Rev. R. H. Ellison, Hothfield Rectory, Ashford; Mr. A. J. Dover, Platt, Sevenoaks; and Mr. C. Waghorn, Paddock Wood. Mr. F. W. L. Sladen, Ripple Court Apiary, near Dover, might give you the information you require.

STEELE (Sheffield).—*Dronc-laying Queen.*—As you have found such a queen it is hardly worth

while to save the combs, and as they contain foul brood it will be safer to destroy them than run the risk of communicating the disease to other colonies.

B. E. BUCKWELL (London, W.).—*Names of Flowers.*—1. *Trifolium incarnatum* (crimson clover). 2. *Medicago minima* (bur medick). 3. *Vicia cracca* (tufted vetch). 4. *Ajuga pyramidalis* (erect bugle). Nos. 1 and 3 are visited by bees. No. 1 is cultivated and grown for fodder and sometimes yields honey in abundance. No. 3 is very much frequented by bees for both pollen and honey.

L. M. B. (Magham Down).—*Wiring Frames.*—Nothing but tinned wire should be used for wiring frames, as copper or brass has a deleterious effect on brood and honey.

A. H. S. B. (Walton-on-Thames).—*Transferring Bees from Old Frame-hire.*—If the colony in old hive is strong, and there is no excluder to prevent it, the queen will go down in due time, and the bees will use the upper hive for stores. There has hardly been time for them to go down yet, but when you do examine the hive and find the queen below, place excluder above the frames.

E. T. BURTON (Birmingham).—*Robber-bees.*—The bees are probably strangers from another hive in the neighbourhood, intent on robbing, and have no doubt been stung in their struggle with the "chuckers-out."

INEXPERIENCED (Barnstaple).—*Going in for Bee-keeping.*—The first thing to do is to get the "British Bee-keepers' Guide Book," and after studying it carefully you would be able better to judge if bee-keeping is an occupation that you would care to pursue. In it you will find fuller instructions than we could give room for, and in any difficulty we are always pleased to answer queries in B.B.J. It is a good plan to keep bees near fruit trees; but if placed under wire netting a certain number are sure to be lost owing to their flying or being blown against it.

W. W. (Kirriemuir).—*Dead Bees in Swarm.*—A natural swarm of hybrid bees would show a certain percentage of black or brown bees, and it need not necessarily be a mixed lot. If the swarm was a large one, and there was insufficient ventilation, the bees would be smothered on the journey. Sometimes anything soft placed on the swarm-box in the train which stops up the ventilation may suffocate the bees, more especially if they had been fed just previous to their dispatch. If the sender guarantees safe arrival you would be entitled to have the loss made good.

Suspected Combs.

TORRISHOLME (Lancaster).—Foul brood is developing in the stock, as the comb shows traces of it in incipient stage.

G. E. H. (Glos.).—The disease shown in sample of comb is black brood, not foul brood.

W. GRAY and MELISSA (Bedford).—Samples of comb indicate that the stocks are affected with black brood. In W. Gray's sample most of the cells contain only hard, dried-up matter, showing that this is not a recent outbreak of the disease. For further particulars of this complaint see "British Bee-keepers' Guide Book," page 182.

Special Prepaid Advertisements.

Twelve words and under, Sixpence; for every additional Three words or under, One Penny.

WANTED, Skeps of Bees.—Price and particulars to HERROD, Apiary, Luton.

BRICE'S QUEENS, 1909, Hybrid or Black. See advertisement columns.—BRICE'S APIARIES, Oxford. q 88

FOR SALE, two "King's" Patent Bee-hives, new, 6 and 8 draw, to be sold under cost price, or exchange for good old violin or an English cello.—E. McNISH, Linden Cottage, Abbotsford-street, Nottingham. r 11

Special Prepaid Advertisements.—Continued

STRONG HEALTHY STOCKS, in good Standard Hives, 25s. each; Skeps, 12s. 6d.; Natural Swarms, 12s. 6d.—REV. JARVIS, Coleford, Glos.

NEW "W. B. C." HIVES, 12s. 6d. Will exchange for Bees or Extractor.—WILLETT, Bee-keeper, New Malden, Surrey. r 4

PURE ITALIAN QUEENS, all tested and selected, 6s. 6d.; Italian Nuclei, 15s.—G. THOMAS, Pwllcrochan Rectory, Pembroke. q 98

WANTED, Farm Labourer, who understands modern Bee-keeping and can handle Bees; if married, wife can help in house work and laundry.—L. M., c/o E.B.J. q 89

QUEENS.—Two fine 1908 fertile Queens to spare, 2s. 6d. each; two Virgins, 1s. 9d. each.—J. SILVER, Croydon-grove, Croydon. q 94

GOOD SECTIONS WANTED, unglazed.—J. SILVER, Croydon-grove, Croydon. q 95

"NEVER-SWARM" DETENTIONISED HIVES are guaranteed to better fulfil the purposes of the Claustral Toy at no extra cost, floor, 2 11 in. outer cases, waterproof roof, painted 3 coats, brood box, 12 wired Standard frames, contracting board, 22s. 6d.; booklet, "Never-Swarm System," 3rd. free.—HARRIS, Wavendon, Bletchley, Bucks. q 93

SWARMS, 12s. 6d. each, immediate delivery; Honey Labels, 160 8d.—BERRESFORD, Spital, Chesterfield. r 5

BEE-FARM IN SOUTH AFRICA, nine miles from Cape Town, fully stocked modern Bee-Farm (freehold), with roomy up-to-date house, stabling, furniture, 2 workshops, honey rooms, &c., large stock Hives and appliances. Price for the whole, £650; cost £1,150. Grand opening for energetic man; magnificent honey country, equal to California. Half purchase-price may remain on mortgage if desired.—GORDON SAMSON, Oldfield, Bournemouth. q 90

STRONG STOCKS, on 8 Standard Frames, 1908 Queen, guaranteed healthy, 25s.; 3-Frame Nucleus, 13s. 6d.; Standard Brood Frames of Comb and Stores, 8d. each; Racks of 8 Shallow Frames of Comb, 4s. 6d. Can book orders for few more Swarms, 12s. 6d.—W. WOODS, Normandy, Guildford. r 9

HEALTHY SWARMS, in properly ventilated boxes, 12s. 6d. each; boxes free.—H. MARCH, Horsford, Norwich. q 96

FOR SALE, 50 Drawn-out Brood Combs, in lots to suit customers, guaranteed healthy, 1s. 3d. each.—H. CROWE, York House, Central-avenue, Wigston, Leicester. r 1

METAL ENDS ("W. B. C."), sample gross, 2s. 3d., post free.—BEE-KEEPERS' STORES, Arcade, Bedford. r 7

PRIME NATURAL SWARMS, June delivery, 12s. 6d. each, or 2s. 6d. lb.—G. BELL, Shoreham, Sevenoaks. r 2

A FEW GOOD STOCKS (IN HIVES) FOR SALE, from 27s. 6d.—WHITEMAN, 51, Woodfield-crescent, Ealing. q 99

20 NUCLEUS BOXES, hold 5 Frames, sound, good, mostly unused, 2s. 6d. each.—NICHOLSON, Langwathby. r 3

FOR SALE, on account of removal, 8 Bee-hives, "Meadows" pattern, also Frames with drawn-out Combs, 3 crates of 1 lb. Sections drawn out, Smoker, Veils, Quilts, Excluders, Feeders, &c., all nearly new and in first-class condition. Will sacrifice, splendid offer.—Apply, J. KENDALL, Broad Oak-terrace, Lightcliffe, near Halifax. r 8

EXCHANGE LEGAL AND BUSINESS ENCYCLOPEDIA (six volumes), by Barrister-at-Law, for anything for the Apiary.—WARREN, 121, Glendower-road, Plymouth. q 91

WANTED, good Swarms. Quote lowest price; or exchange one "Wells" Hive for two Swarms.—KEIGHLEY, Hammerton, York. q 89

Special Prepaid Advertisements.—Continued

QUEENS, Doolittle's famous strain, result of thirty years' breeding for good qualities. Hear what another customer says: "All my swarms from your queens weigh 8 lb. and over. One stock last season gave 125 lb. white honey in single hive." Another report: "The queen that I had from you last year has proved a real hummer." Virgins, 1s. 6d.; Fertiles, 5s. Orders in rotation.—D. TAYLOR, Ilminster. q 97

BORAGE, yields nectar all day for weeks, sturdy seedlings, 6d. dozen, post paid.—CRAWSHAW, Norton, Malton. q 77

14 REASONS WHY TILLEY'S IMPROVED PATENT "WON'T LEAK" SECTIONS SHOULD BE USED BY ALL BEE-KEEPERS, post free; sample and instructions, post paid 6d.; complete Super, with 9 2-lb. patent Sections, 4s. 6d., on rail. Order now to prevent disappointment. Tilley's registered Damp-proof Hive, painting not necessary. Bar-frames fixed by the Bees, movable by the Bee-keeper; less propolis, hence more honey. Particulars post free.—M. H. TILLEY, Bee Farm, Dorchester. q 78

FOR SALE, this season's Honey, good, sample 3d.—DAVID HANCOX, Deddington. q 74

SWARMS WANTED AT ONCE by LB., guaranteed free from foul brood. State price.—REV. RUNNELS-MOSS, Ladywood Vicarage, Birmingham. q 61

SECTIONS WANTED.—State price; must be light and new.—THE HONIELADE CO., 23, Moorfields, E.C. q 72

BUY DIRECT FROM THE MAKER.—Section Racks, to hold 21 Sections, and follower, 1s. 3d. each, 3 for 3s. 6d., 6 for 6s. 6d.; free on rails.—MERRY, 69, Rosehill-road, Ipswich. q 59

YOUNG MAN, single, wanted, to assist with Bees, make appliances, and be generally useful.—BUCKS, c/o BEE JOURNAL. q 85

NEW "W. B. C." HIVES, 14s. 6d., complete; also appliances.—J. BOWDEN, Broomhill, Witley, Surrey. q 79

CLERK AND CANVASSER WANTED, for dairy trade; preference given to one with knowledge in manipulation of Bees.—FRANK NYE, Dairyman, Littlehampton. q 48

NUCLEI.—Strong 3 or 4 Frame Nuclei, with Golden Queen, 11s. and 13s. 6d., early June delivery guaranteed.—J. W. TURNER, West Drayton, Middlesex. q 55

WANTED, SWARMS, any number.—Price and particulars to HERROD AND STEWART, Luton. p 68

500 SWARMS WANTED.—State price delivered Welwyn, carriage paid; boxes supplied if required.—E. H. TAYLOR, Welwyn, Herts.

"CHAPMAN HONEY PLANT" SEED, 3d. and 6d. per large packet, post free.—W. WOODLEY, Beedon, Newbury. p 91

PROTECT YOUR FRUIT.—Tanned Garden Netting (best only), 50 by 8 yds, 17s.; 25 by 8 yds., 8s. 6d.; 50 by 4 yds. and 100 by 2 yds., 8s. each; 50 by 2 yds., 25 by 4 yds., 4s. each.—L. WREN AND SON, 139, High-street, Lowestoft. p 94

EXTRACTING HOUSES, Stock sizes, or own requirements. List free.—F. E. MATTHEWS, Cofton Apiary, Northfield, Birmingham.

A VOID BEING STUNG by wearing Reynolds' famous "Burkitt" Bee Gloves, price 2s. 6d. without sleeves; with self-adjusting sleeves, 3s. 6d. pair. State size when ordering. These Gloves are light, hand-sewn, and not clumsy.—ED. REYNOLDS, Glove Manufacturer, Andover. Wholesale terms on application. o 19

"THE PREPARATION OF HONEY AND WAX FOR THE SHOW BENCH", post free 7d.—JOSEPH TINSLEY, 22, Granville-terrace, Stone, Staffs. h 24

Editorial, Notices, &c.

BRITISH BEE-KEEPERS' ASSOCIATION

A special meeting of the Council was held at the offices of the BRITISH BEE JOURNAL, 8, Henrietta Street, Covent Garden, London, W.C., on Friday, June 11. Present: Mr. T. W. Cowan (chairman), Miss M. L. Gayton, Messrs. R. T. Andrews, C. L. M. Eales, O. R. Frankenstein, E. Garcke, H. Jonas, J. B. Lamb, A. Richards, G. H. Skevington, E. D. Till, and F. E. Harcastle (acting for the secretary).

Letters of regret for absence were received from Mr. W. F. Reid (vice-chairman), General Sir Stanley Edwardes, Rev. H. E. N. Ellison, Messrs. T. Bevan, A. G. Pugh, and E. Walker.

The Chairman read the notice of the meeting, and stated that in consequence of Mr. E. H. Young's serious illness he had deemed it advisable to call the Council together to make temporary arrangements for carrying on the work. He had seen Mr. Young, and was quite satisfied that he must be relieved from work of every description to enable him to get the necessary rest. He had succumbed to overwork, which, with the insurances and examinations, had greatly increased, and he was sure that the Council would sympathise with him, appreciate his good services to the Association, and grant him the needed vacation. His brother, Mr. W. C. Young, was quite willing to superintend the work, and Mr. W. Herrod and Mr. Harcastle had cheerfully offered their help during Mr. Young's absence. Mr. Herrod, at his (the Chairman's) request, had already attended to matters connected with the "Royal" Show.

The Council unanimously passed a resolution of sympathy with Mr. Young, expressing their high appreciation of his services, and granted him the vacation he needed, with a hope of his speedy recovery. At the same time, they wished the other societies with which Mr. Young was connected to be informed as regards his health, asking them to grant the same leave of absence from work, so that he could get the complete repose which he required. Mr. W. C. Young, Mr. Herrod, and Mr. Harcastle were thanked for their offers of assistance.

Mr. W. Herrod was authorised to take charge of the work in connection with the "Royal" Show at Gloucester, and to make the necessary arrangements with regard to it.

Cheques were drawn for salaries and expenses connected with the "Royal" Show.

Applications for examinations for third-class certificates were received, and the examiners appointed.

The correspondence from the bee-keepers' associations in South Africa was read, and the Chairman stated that he had that day seen Miss M. Dagmar Sillar, the O.R.C. Government expert, and had had a long interview with her. He had asked her attendance there to meet the Council and to state the wishes of the associations she represented.

Miss M. Dagmar Sillar was then introduced to the Council, and stated that she was representing the South African Beekeepers' Association, which desired to be affiliated with the B.B.K.A., as they recognised the value of its certificates, and wished the examinations for them to be conducted by the B.B.K.A. There were many capable bee-keepers in South Africa who were desirous of obtaining these certificates, but at present there was no means of doing so. The other colonies, with the exception of the Transvaal, had united with the South African B.K.A., which had also many members resident in the Transvaal.

It was explained that if the South African B.K.A. were affiliated, the B.B.K.A. saw no difficulty in arranging that the third-class examinations should be conducted in the same way as they were carried out in the different counties in England—by examiners approved by the B.B.K.A. For second-class, the question-papers would be sent out to South Africa, written under supervision and returned here for adjudication, as also the papers for first-class examinations. It was explained to Miss Sillar that the Council could not approve of any dealers in appliances being appointed as examiners.

Miss Sillar thanked the Council for the interview, and the acting secretary was instructed to write to the secretaries of the two associations in South Africa and other applicants to say what arrangements they were prepared to make to meet their wishes.

It is requested that all communications relating to the "Royal" Show be made to Mr. W. Herrod, Old Bedford Road, Luton, and all matters in connection with insurances, examinations, judges, and membership be referred to Mr. W. C. Young, 12, Hanover Square, London, W.

The Council hope that bee-keepers will not trouble Mr. E. H. Young with any correspondence for the present, so that he may have the absolute rest which he requires.

SUFFOLK AGRICULTURAL SHOW.

The Suffolk Agricultural Society's show was held on June 3 and 4 at Bury St. Edmunds, when demonstrations were given in the bee-tent, under the auspices of the S.B.K.A., by Mr. A. W. Salmon.

Although a good deal of rain fell on the second day, lectures were given at favourable intervals, and were attended by numbers of people. The operations consisted of driving bees, manipulation of a frame-hive of bees containing various kinds of combs with queen-cells forming, and brood in its various stages of metamorphosis, transferring skeps, artificial swarming, fitting sections and shallow frames for honey-production, methods of extracting honey, &c.

The S.B.K.A. has to thank the secretary of the Agricultural Society and Mr. E. F. Goldsmith, the local secretary, for the excellent arrangements made in conjunction with one of the best-organised shows held in the kingdom.

REVIEWS.

Alexander's Writings on Practical Bee-culture. Edited and compiled by H. H. Root. (Published by the A. I. Root Company, Medina, Ohio, U.S.A. Price 2s. 6d.)—Bee-keepers are indebted to the late Mr. E. W. Alexander for many novel and valuable ideas, and it was a happy thought on the part of Messrs. Root to have his writings compiled and published. It was in 1904 that Mr. Alexander first began contributing to *Gleanings*, although for forty years he had been keeping bees in a large way and producing honey by the carload. He was the only bee-keeper in the United States who was able to manage from 700 to 800 colonies in one apiary, and managed to secure an extraordinary average weight of honey from each colony. In these writings we have many valuable hints and "tricks of the trade," and although Mr. Alexander did things in a large way, there is a great deal that is equally useful to the smaller bee-keeper. His plan of building up weak colonies, making increase and controlling swarming at the same time, and brood-rearing in spring are all things every bee-keeper desires to know. In the book before us we have not all the writings, but Mr. Root has made a selection of the best of the ideas, and the book cannot but be of use to many a bee-keeper in this country.

South African Bee-keeping. By H. L. Attridge, F.R.Met.Soc. (Published by the Department of Agriculture, Cape of Good Hope, S. Africa.)—Naturally, owing to the climate, bee-keeping in South Africa differs somewhat from the way it is carried on in this country, and the requirements of bee-keepers here fail in many particulars when applied to the entirely different conditions existing there. The author brought out in 1890 a pamphlet entitled "South African Bees and their Practical Management in Movable-comb Hives," a reprint of articles written by him for the *Wynberg Times*, and which

were largely responsible for the impetus given to bee-culture in that country. Mr. Attridge is an expert to the South African Bee-keepers' Association and Apicultural Adviser to the Department of Agriculture. He condemns many of the hives that have been imported, as also their bad imitations made in the country. On the other hand, he says, on page 27: "We have experimented largely with frames of different sizes, and have no hesitation in saying that for general use and easy manipulation that known as the 'British standard frame' is the most suitable and convenient." This frame has now been adopted by the Transvaal and the O.R.C. Bee-keepers' Associations, and is used by many of the advanced bee-keepers, and the author hopes to see it adopted at an early date as the standard frame for the country. The book consists of ninety-six pages, and is well printed and illustrated, and should be useful in helping to spread bee-keeping in South Africa. It has been adopted as the text-book by the South African Bee-keepers' Association.

From the U.S. Department of Agriculture we have received Bulletin No. 75, Parts IV., V., and VI. of *Miscellaneous Papers on Apiculture*.

Part IV. *The Relation of the Etiology (Cause) of Bee-diseases to the Treatment.* By G. F. White, Ph.D. (Price 6 cents.)—In this pamphlet we have a repetition in great part of what we find in previous papers, and in addition the writer mentions predisposing causes of disease, such as age, sex, heredity, race, climate, &c., and exciting causes like food, micro-organisms, &c. He still considers that there are two different diseases called foul brood in America, and not that there are two types of the same disease, as has been so conclusively shown by Drs. Burri and Maassen's investigations in Europe. The author states that a number of organisms have been found in the larvae dead from what he calls "European foul brood." One species he says is of special interest. He has, however, failed to get it to grow, and calls it *Bacillus* "Y." This is probably the bacillus mentioned by Dr. Burri in his work on foul brood published in 1906, and which he found associated with *B. alvei*.

Part V. *A Brief Survey of Hawaiian Bee-keeping.* By E. F. Phillips, Ph.D. (Price 17 cents.)—The author states that, as in all other places, this business, from its very nature, cannot become a leading industry. Bee-keeping in Hawaii is largely in the hands of four corporations, owning and operating at least four-fifths of all the bees on the islands. The companies are managed by Americans, but there are a few smaller apiaries, some of which are managed by Japanese. About 600 tons of honey is the produce, 200 of

which is floral and the remainder honey-dew or a mixture in varying proportions of honey-dew and floral honey.

Part VI. *The Status of Apiculture in the United States*. By E. F. Phillips, Ph.D. (Price 6 cents.)—The number of men who rely on the production of honey and wax for a livelihood in the United States, the writer says, is rather small, and most of the extensive producers in the West carry on some other business. Bee-keepers carrying on the business on a commercial scale are usually anxious that there should be no increase in the numbers engaged in it. The writer says that with a few bee-keepers proficiency is much more likely than when there are many small bee-keepers, and that he who is expert cannot hope to rid his bees of disease if there are a great many unqualified bee-keepers in his neighbourhood. The value of honey produced in the United States is given as averaging \$20,000,000 (£4,000,000), there being 700,000 bee-keepers. The average number of colonies per bee-keeper is less than six. The annual importation of honey amounts to 2,500,000 lb., so there does not seem a probability of American honey flooding the European market just yet. The writer thinks probably the honey-bee does more good to American agriculture as a pollensing agent than as a honey-producer.

These pamphlets can be obtained from the Superintendent of Documents, Washington, D.C., at the prices named.

HONEY IMPORTS.

The value of honey imported into the United Kingdom during the month of May, 1909, was £5,719.—From a return furnished to the BRITISH BEE JOURNAL by the Statistical Office, H.M. Customs.

Correspondence.

The Editor does not hold himself responsible for the opinions expressed by correspondents. No notice will be taken of anonymous communications, and correspondents are requested to write on one side of the paper only, and give their real names and addresses, not necessarily for publication, but as a guarantee of good faith. Illustrations should be drawn on separate pieces of paper. We do not undertake to return rejected communications.

AMONG THE BEES.

[7495.] *New-Old Cures*.—Now and again we see resurrected cures that we have read of as being "invented" long ago. The inference derived from the statements would read as if the subject had been newly discovered. Recently we heard from the other side of the Atlantic that a certain form of brood-disease could be cured by temporary de-queening, and some accepted the discovery as something

new and marvellous. But soon from this side came a claim of priority, and the claimant gave "chapter and verse" proving that he had evolved the same truth years earlier. At the time I had a dim notion simmering in my mind that the idea was an old one, and on reading Dzierzon's "Rational Bee-keeping" lately I got a key to the puzzle. Under the heading "The Method of Treatment of Diseased Stocks" he writes:—"To put an end to the disease immediately, catch the queen without delay as soon as any foul cells have been observed." On another page he adds:—"A fresh outbreak of the disease will be more certainly prevented if the stock is again deprived of its young queen as soon as she is fertilised and has fairly occupied the brood-nest." The newer claim seemed to be that depriving a colony of its queen for about three weeks, until all the brood had hatched out, would enable the bees to clean out the foul cells and all the dregs of the disease, so that when a fresh queen was substituted her progeny could start fair in a house freshly swept and garnished. I am not prepared to support the theory, but shall not deny that it might tend to a mitigation of the evil. All I am dealing with at present is that the idea is not new, being at least fifty years old, although I have an impression that I have met it in the works of some of the old masters who wrote one or two centuries ago.

Keeping Foundation.—Foundation kept over from a former year, if carefully wrapped up and packed away in a dry cupboard, will be quite good this season. It should be kept apart from any strong-smelling substance or anything from which it could acquire an offensive odour. Of course, it should be kept away from dust and damp. When taken out in spring it may look sickly; probably it will have turned a little off colour, having a rather grey and faded appearance. Almost certainly, too, it will have become hard and brittle, so that on handling it will crack and snap. To bring it back to its true colour keep it in a warm room for some time, and this will also make it more pliable and "malleable." Or dip it in warm water, not warm enough to melt it, and the sheets will at once look as well as they did when they came off the sheeting machine. If only a few sheets require treatment, hold each one, first one side and then the other, right in front of the kitchen fire, and almost in a moment you will note them resume their true colour and pliability.

Should, however, the sections or frames lie about all winter the foundation may prove unpalatable to the bees, in which case it is far better to melt it down to

wax. Frames or sections, too, which have been long in the hives after the bees have given over comb-building get so heavily coated with propolis that they appear as if they had received a coating of varnish; and the bees draw them out with considerable reluctance during the new season, or even decline to deal with them in any way.

Some Don'ts.—Don't pinch a queen when examining her. Hands off is the best policy. Don't keep your hands off a poor, failing, superannuated mother, but, without compunction, pinch her. Don't finger a young virgin when transferring her from one hive to another; the less handling any queen gets when introducing the more certain her reception will be. Don't tolerate weaklings in the apiary; such colonies are seldom a paying asset, and they may be centres for breeding or even disseminating disease. Don't tinker with disease in any form, but go to the root of the matter. A snake is better, not scotched, but killed. Don't, if a novice, leave suspected foul brood to develop unchecked. If there is even a suspicion send a sample to the Editor. He knows the false from the true. Don't be the least afraid that he will snub you if you have sounded a false alarm; his patience is beyond your most extreme conception. Don't send your sample in a sheet of paper, or a cardboard box even, but use a tin case which will stand the test of crushing and pressing entailed by a journey in the mails. Don't put any communication inside the box; do as you would be done by. Don't merely glance over practical articles; read them with understanding, and apply them with care. Don't forget that "locality" has much to do with the successful application of many a "useful hint." Don't neglect to take a momentary peep below quilts on the first fine day in spring; your diagnosis of the stock then may be of great value later. Don't fail to make occasional outside observations even before you can safely take off the roof. Don't fuss over a queenless stock in spring, but unite the bees to the nearest colony.

Deep Bottom Space.—I am glad to say that my recent protest against the very contracted area below frames in brood-body has been taken up both at home and abroad, and a good deal has been said and written in favour of from 1 in. even to 3 in. being given clear of bottom board. It will be in the knowledge of most readers that Mr. Carr was a strong advocate of the larger space in winter, and I am confident that where the 3-in. eke is used below the inner body sanitation will be in a more satisfactory state all winter and early spring. Don't be in too great haste to remove the extra room, because,

until heavy storing sets in, bees will respect the 3 in., and never dream of starting comb-building there. I have an idea that many colonies would go right through the season, with plenty of overhead space to satisfy their craze for comb-building, without troubling to build more than a few small, insignificant brace-combs below frames. In such a season as 1907 one experimented with did not build; and two others, with 1 in. and 2 in. respectively, left it clear without a vestige of bracing. Last year the deeper space in one had a fair amount only. Another with that depth built comb outside dummy, and even between the outer and inner cases rather than utilise this space, and they were contracted for a time above as an experiment, during the early days of August. Truth compels me to state that in a heavy flow there was a good deal of rough, irregular building about the bottom bar, but nothing to obstruct traffic or make frames any the less capable of being manipulated. Bees did not seem to resent the vacant space. By the way, they had the normal space from about mid-June up to the end of July.—D. M. M., Banff.

ISLE OF WIGHT BEE-DISEASE.

HOPEFUL PROSPECTS.

[7496.] During the last week in April I made a tour through the Isle of Wight with a view of seeing how the bees fared which were sent last year under the auspices of the Isle of Wight Bee-Fund, and, if possible, to get some light upon this mysterious malady.

I spent four days in the island, and during that time interviewed the majority of the bee-keepers and saw some very fine stocks. The most striking aspect is the wonderful success which attends driven lots of bees; nearly all the 4-lb. lots of these sent over in August and September had eight, nine, and ten frames of brood in the last week in April. Even single-skep lots of 1 lb. to 1½ lb. of driven bees in August and September, if they have a young queen, will grow into a strong stock by the following May. In almost every case the "driven bees" colonies were ahead of swarms, which arrived in June and July.

As an illustration of what bees can do in the island if free from disease, take the following case. One of the lots, sent to a labourer on a farm in the south, was a late swarm at the end of July. They were put into a new hive with ten frames of foundation. A large skep was put over the frames, which was taken away in September full of honey. In the first week in October two frames of bees were taken out, and a nucleus formed with a young

queen, which wintered on three frames, with the result that, equalising the two colonies this spring, the owner has supered two strong stocks and taken a large skep of honey, all from a late July swarm, and all the feeding they had was 2 lb. of syrup and a 2-lb. cake of candy.

Two or three instances of single frames of bees with a young queen sent by me at the end of June have grown without any feeding into colonies covering eleven frames when I saw them. On the other hand, an expert in the island last summer made up a number of nuclei from an island stock on the site of an old affected apiary, and all except one colony eventually died.

The case of one bee-keeper excites our sympathy, for out of three swarms last year and three this April and May half of them have decamped. These bees evidently understand their mission is to repopulate the island. By comparing dates I was enabled to trace two runaway swarms, one of which flew nearly six miles and the other over seven. The distance seems incredible, but with so few bees existing, the evidence of the dates, times, and line of flight is overwhelming testimony. I might add that swarming began on the island this season on April 24.

Mr. Sladen will be interested to learn that the virgins of his hardy dark strain purchased from him are going strongly, while in the stock of a Carniolan queen from Mr. E. H. Taylor, of Welwyn, the frames of brood were one solid level slab with scarcely a water-hole.

The stocks in the new hives with reversible floorboards and wintered with an air-space below, presented by Mrs. Massey Spencer and supplied by Messrs. James Lee and Son and Mr. E. H. Taylor, are all going exceptionally strongly. — J. SILVER, Croydon.

(Concluded next week.)

MID PIKE AND FELL.

[7497.] May 15. "A sharp frost last night, and the hills are covered with snow." A pleasant *réveille*, this, to hear one gardener telling another. Yesterday I was admiring the pendent blossoms of the sycamore and the showing spikes of the chestnut. An apple tree, too, blushing with the promise of its coming crop, had also caught my attention. I feared, yet as my domicile is at the moment high up on Penrith Beacon height, I hoped that in the valley it might not be so disastrous.

Reader, do you know the soft sough of the wind through the pine woods; the joy, though the air is keen, to open your windows to inhale the resinous breeze; the glory of a landscape sweeping over

twenty miles to your view, bathed in the soft morning sunshine, and bounded in the grey distance by the shadowy hills? You feel that life is worth living, and you thank your Creator for your existence.

Half-way on the road to my daily labour I am forced to walk up a rise. I have before pictured the mountains in grim nakedness. But this morning—oh, how different! Not yet has the sun risen sufficiently high in the heavens that his power may be felt. The snow is as it fell during the night, and a mantle, beautiful in its purity, covers the scene. Each peak from its neighbour stands out pointed in dazzling white, shaded by the dark gorges on either side where the fall has not stayed. First Merton and Dutton Pikes—foot-hills as it were—Mickle Fell in the mid-distance, but high over this Cross Fell, with its 3,000 ft. of height, to be still further capped by the heavy white cumulus clouds, mountain-shaped, glinting in the sun-rays, and seemingly a still higher range. Look at you mighty cloud-shadow racing and chasing across the view; another, and again another, follows. Mark the two colours: they shade you plantation, and how, mounting higher and higher, they leap over the top to other fields, where our eye cannot follow! Overhead, blue is the sky. In the trees the wood-pigeon "coo-coos" insistently, circling where his mate sits on two white eggs. In the stony meadow, where the lambs race in mimic contest, the cry of the peewit and the mellow, querulous note of the curlew are heard.

And with the heart of May
Does every beast keep holiday.

"But you have not yet seen Mary Gill and her bees," my guide tells me as I finish in the next village.

A white-washed old stone cottage, with a bright beck flowing in front. We cross the brig into a garden, old-fashioned as to the flowers and picturesque as to the skeps: lonesuckle, thyme, lavender, rue, and "old mau." In the corner, crowned with cone-shaped thatchings, two skeps. Birket Foster would have revelled in the picture.

At the half-opened door Mary Gill meets me—a bonnie, bright-eyed old lassie.

"You have kept bees a long while, Mary?"

"Whiah, let's see; ahs be eighty twenty nint er June, St. Peter's da-ay (if ah levee). Ah mind weel t' fust kest ah hed. Ah wer ten yeer awd than; bit ahd saved a bit brass. 'Seah, ah sed ter Betty Nixon. 'Thoo mebbe wadn't charge me see a deel for a kest, Betty.' 'Thoo sall hey you for eleben shilling an' sixpence agey—an' for luek,' sez she. That war sebenty yeer sen; but ah mind fetching them hyam as if it had nobbut

bin yesterday. Awd Willie Johnson's bull had been put int' pasther, an' ah didn't knaw out. My word, but ah hed to skiander gay sharp ter git oot of way, an' if ah hedn't kep t' mi feet ah sud er bin pinned tet wor. Ah've leaved i' this hoose ivver sen. Me awd man's eighty next August. Aw dirt mak mich oot et bees, but ah deah like t' hear 'em sing. Ah sall allus keep a few by me, for ahs rarely setten up when ah sees 'em kest."

"Whiah, good-day, an' thank yer," she said as we parted. "Ahl mebbe see yer ageyan if yer cum ower at baek-end an thaur wis hev annudther crack."

Mary Gill's autograph was wonderfully firm for eighty years. May she long enjoy, "wi' 'er awd man," their old-age pension.

Thanks, Mr. Crawshaw; but I am not funning (page 198). The hives may be seen, and there were more mottoes, but I considered space in the B.B.J., and refrained from piling up the agony. Our journal wisely refrains from politics, yet

Full many a shaft at random sent
Finds mark the archer never meant.

—J. SMALLWOOD, Hendon.

MIDLAND NOTES.

[7498.] A more favourable spring has probably not been known in the Midlands for a long time past. Bees have come on wonderfully well right from the beginning of April, and a large number of swarms have already issued from apiaries all round this district. The first reported to me was on May 5, and others almost continually until the 24th, when the weather changed. About $\frac{1}{2}$ in. of rain fell in the night. Since then it has been more or less unsettled up to the time of writing. However, the bees are quite ready for the honey-flow, which will begin in earnest in another week, when the white clover begins to bloom. I have one stock which has already nearly filled two crates of shallow frames, one being fully sealed and the other more than half finished; they contain altogether more than 40 lb. of honey.

Bees Re-queening Themselves.—The case of bees re-queening themselves reported by myself in the B.B.J. of May 13 (page 184) did not end in anything very unusual, though it started in rather a curious manner. The next examination failed to reveal the old queen, which had probably been destroyed. I then united the stock with a nucleus which had been kept over winter.

Mr. D. Ernest, Stansted, also reports a case of bees re-queening themselves, in your issue of May 20 (page 196, 7464), which he says is similar to mine. His queen was certainly the same age and

there was also about the same quantity of brood; but here, I think, the similarity ends, as he does not say anything about the early drones or the new small brood-nest on the outside comb. I would rather favour the idea that his queen was lost when transferring to the new hive. The bees would then, of course, commence queen-cells.

Ensuring Worker-comb.—Probably one of the best ways of getting worker-comb built from starters is with second swarms; these with me have always proved very successful. I first hive the bees on about three frames, placed about $1\frac{1}{4}$ in. or $1\frac{3}{8}$ in. centre to centre, and feed them every evening. There should be no difficulty in working them up into a good stock ready for winter by adding a frame fitted with $\frac{1}{2}$ -in. starter of foundation as often as necessary until the hive is complete, and if the swarm is rather a strong one in the first place (say 2 lb.) there should be a few combs extra: these can be taken from the outsides, and will be partly stored with honey, and they are very handy when building up stocks from driven bees. I have never failed to get strong stocks the next spring from after-swarms built up in the above manner.—F. E. MATTHEWS, Northfield, June 5.

A USEFUL HINT.

[7499.] I have taken in the B.B.J. for some years, and read with much pleasure the useful information given each week. As I have often noticed that readers have a difficulty in taking off their supers because of their being so fastened down with propolis, I thought it might be useful if I gave a very simple plan for preventing this. I simply take four strips of any sort of quilting (old, worn-out quilts, if cleaned, will do) and place them on the frame-tops before putting the super on the hive. I have these strips between each super I use, and find that it keeps the bees from getting out if the supers have warped a little during the winter. In taking off the boxes there is no twisting required; therefore the bees are not irritated and the operator does not get stung. I hope your readers will find this plan as useful as I have.—CHARLES TIMLOCK, Leicester.

CHLORIDE OF LIME AND FOUL BROOD.

[7500.] On page 171 of your issue of May 6 it is stated: "Foul Brood Cure.—A. Vibert describes in *L'Apiculture Nouvelle* how a client of his cures his colonies of foul brood [through] a receptacle containing ordinary commercial chloride of lime," &c.

How much chloride of lime does the bee-keeper referred to use, say, for a strong colony in a twelve-frame hive? Can

this information be got, with full particulars for using the cure, from A. Vibert or his "client"? If so, many British bee-keepers would doubtless like to have that information.

I might say that I tried about two table-spoonfuls of ordinary commercial chloride of lime placed in a receptacle on the floorboard of a six-frame nucleus (about 5 p.m.), and the next morning a large number of the bees had left the combs and were clustered outside on the box, whilst many were crawling about the ground apparently paralysed, and ultimately dying.—INTERESTED BEE-KEEPER, Cambs.

[Probably the dose was too strong, as you will see that a correspondent, on page 215, has used one teaspoonful of chloride of lime successfully.—ED.]

CAPPINGS OF COMB.

BY L. S. CRAWSHAW, NORTON, MALTON.

Bees Re-queening (page 184).—Does not the fact of the queen being in exile from the true brood-nest rather point to the fact that she was driven away at the manipulation on April 5? Possibly the subjugation was the cause, or the combs may have been altered. For some reason she may have refused to go back, and the other processes would follow naturally. This question might have been tested by removal of the queen-cells and replacement of the queen. Probably a young queen will become fertile, supersedure-companion-fashion. She might be profitably introduced to a swarmed stock, and further developments noted.

"Balling" the Queen (page 187).—"Bees with empty sacs are liable to 'ball' the queen." Is this altogether true? At least, there must be something more than this in concern. Sometimes it occurs in early spring, when it would seem to be inceptually a protective measure. At this time I use as little smoke as may be, none if possible, certainly insufficient to make the bees replete, and I do not experience the trouble. Very little reflection will show that comparatively few bees are able to fill up when a prosperous hive is opened. So that the pacification of the few must have a moral effect upon the digestive system of the community. That is, if we may speak of organic morality in an organised demoralisation! But "balling" cannot be solely a question of poverty, for the trait is differently pronounced in various strains. Some bees would not attempt it though there were no drop of honey in the hive from which to replenish their empty sacs (N.B.—This is a polite word for stomachs).

Lighting the Smoker (page 187).—Here is good practical instruction. The smoker may be lighted in a breeze if the match

be well alight and sheltered inside the smoker by the fuel. But is it necessary to strike the match inside the dirty barrel? The method is neither convenient nor clean, and a match-head blazes sufficiently long for the operation to be elsewhere. If a piece of sand-paper be glued to the bellows, it will fulfil this purpose, and afford a better grip for the fingers when the smoker is in use.

Size of Old Cells (page 188).—Surely Mr. Gray is incorrect in stating that "the cell does not grow less." Each larva reared spins its silken cocoon, and, however gossamer this may be, it must add to the thickness of the cell-wall and the weight of the comb. Consequently, however slow the process, the cell must reduce in size. Quite an appreciable reduction may take place before the size of bee is affected, but I have read of bees reared in such reduced cradles which were so small as to be amusing. I cannot trace this at the moment, but I think it was at the Roots' apiary at Medina. If this should catch the eye of the good editor of *Gleanings*, perhaps he might give us some information.

Mouldy Combs (page 196).—Damp combs may be thoroughly dried by inserting a pan of quicklime in the hive or box. (Of course, the bees should not be subjected to this treatment!) I have successfully treated mould by syringing with a disinfectant, extracting and drying in an ordinary room. When opportunity occurs, I am going to try spraying with a weak solution of naphthol beta. Some time ago I had some entomological specimens which developed a fungus. I dipped them in a solution and dried them at once. The growth was entirely killed, and I think that a further washing in methylated spirit will remove all trace of the naphthol without detriment to the specimens.

Signs of Early Breeding (page 196).—Curiously enough, it is not always the most forward hive which earlier showed the first-noticed signs of breeding. Of these, pollen-carrying is the most conspicuous. Thus a driven lot which had no store of pollen might be forced to seek it in the spring, whilst a well-stored stock might simply make the shortest possible excursions for water. I do not know what are the exact combinations which cause this, only that I have at times observed this without internal examination, as in early spring I happily let such pollen-carrying stocks alone.

His Little Wooden Hut (page 196).—May we conjecture, from his philosophy upon the relation of the sexes, that the writer of this note is a Benedick in Aready, and that, like "Tom Lad," he appreciates a place for secluded medita-

tion? May we join the discussion in his retreat? Can we describe drones and workers as brothers and sisters? I mean that it is a peculiar relationship, and even "half-brother" does not exactly meet the case. As to the importance of the drone, is it not possible that we might have had queens without his aid, if parthenogenesis had direct descent in the female line, instead of its present zig-zag down the alternate sexes?

The B.B.K.A. (page 202).—I do not desire to oppose or discourage any scheme for strengthening the hand of the parent body, but criticism of Mr. Hepburn's scheme may elicit further discussion. It is easy to estimate a considerable income, but where would the economy arise? Unless subscriptions were increased, or county expenditure reduced, would not the B.B.K.A. remain financially in much the same position? For it would be obliged to repay in grants what it received. Any banking advantages it would get really belong to the county associations, and not everyone of these has an unflinching credit balance! Mr. Hepburn does not indicate the margin which is to pay for a central club-house, &c., after paying for shows, expert work, and delegates' expenses. It is hard enough to get delegates from the distant counties annually under present circumstances. If the interest in the central body were increased, might not the local interest be diminished? Such associations as those cited must have been worked up by enormous personal enthusiasm, and a good deal of this appears to pertain to possession. Whilst the expense of the centre would be shared by all members, those at a distance could make no proportionate use of it or the engagements connected with it. But the central body cannot be expected to do much more without increased funds, and affiliation fees might very well be increased. I think that these should be exactly proportional to the memberships. Why not 1s. per head? If necessary, subscriptions might be slightly increased, for county members get astonishingly good returns for their money. The 2s. 6d. members are another difficulty in the way of centralisation. The deficits on their account are usually met at present by subscriptions which might not otherwise be forthcoming.

Bee Shows to Come.

June 22 to 26, at Gloucester (Royal Agricultural Society's Show).—Bee and Honey Section under the management of the B.B.K.A. Prizes arranged in groups of counties for Associations affiliated to the B.B.K.A. **Entries closed.**

July 15 and 16, at Louth.—Show of Honey, Hives, and Bee-appliances in connection with the Lincs Agricultural Society, Bee-department under management of the Lincs B.K.A. Judges, Messrs.

F. J. Cribb and W. Herrod, F.E.S. **Entries closed.**

July 21 and 22, at Cardiff.—Glamorgan B.K.A., in connection with the Cardiff and County Horticultural Society's Coming-of-Age Show, Members', Novices', and Open Classes. Record Schedule from W. J. Wiltshire, Mandy Schools, Cardiff. Judge, W. F. Reid, Esq., F.I.C., F.C.S. **Entries close July 18.**

July 21 and 22, at Tamworth.—Staffs B.K. Association Annual Exhibition, Honey, &c. Six open classes. Excellent money prizes. Schedules from Joseph Tinsley, Expert and Lecturer, S.B.K. Assoc., 22, Granville Terrace, Stone, Staffs. **Entries close July 26.**

August 4 and 5, at Abingdon Park, Northampton.—Honey Show of the Northants B.K.A. Special prizes for open classes, including one for single 1-lb. jar honey. (Entry free.) Judge, Mr. W. Herrod. Prizes 20s., 10s., 7s. 6d., and 2s. 6d. Schedules from R. Hefford, Hon. Sec., Kingsthorpe, Northants. **Entries close July 28.**

August 10 to 12, at Beverley.—Show of Honey, &c., in connection with the Royal Yorkshire Agricultural Society. Schedules and form of entry from John Maughan, Secretary, Blake Street, York. **Entries close July 3.**

August 13 and 19, at Shrewsbury.—Annual Show of the Shropshire B.K.A., in connection with the Shropshire Horticultural Society's Great Floral Fête in The Quarry. Nine Open Classes for Honey and Wax. Schedules from S. Cartwright, Shawbury, Shrewsbury, Hon. Sec. **Entries close August 6.**

August 25 and 26, at Stratford-on-Avon.—Annual Show of the Warwickshire B.K.A., in connection with the Warwickshire Agricultural Society. Schedules from J. N. Bower, Hon. Sec., Knowle, Warwickshire.

September 22, at Altrincham.—Honey Show, in connection with the Altrincham Agricultural Show, the largest one-day show in the Kingdom. Classes open to United Kingdom. Classes for Trophy of Honey, for Best Hive, Observatory Hive with Bees and Queen, twelve Jars of Extracted Honey. Classes open to County of Chester, for Run and Section Honey, Wax, &c. Special Classes for Cottagers, and Special Classes for Society's District. Good prizes, low entrance fees. Schedules from Mr. J. Herbert Hall, 2, Dunham Road, Altrincham. **Entries close September 4.**

Queries and Replies.

[3945.] *Irregular Combs.*—1. I beg to thank you for your reply (page 159) to my query *re* irregular combs, but, in the meantime, I had put on the supers, and therefore cannot now pare down the combs to their proper size. I now propose to leave this till the late summer, or even the autumn, when feeding-up for the winter, and I suppose there is no harm in doing so. 2. On one of my hives I have lately put a second super on top of the first, but do not know how I can find out when the one underneath is full enough for a third to be added. I am able, of course, to look at the upper one and see the progress made, but it projects beyond the lower one, and prevents my slipping up the wedge and board at the back of the super, which is underneath, and so I cannot examine it. When the honey in the top super is quite sealed over, what will be the state of the bottom one? 3. Does it check the bees at all, say, when adding another super to make an examination of the brood-chamber, leaving the supers with bees confined in the meantime? I should like to make quite sure that there are no signs of foul brood, although I believe all was right when the supers were put on. Should I be able to tell from the outside (by the behaviour of the bees) if they had the disease? 4. I also wanted to see if any queen-cells had been built and occupied, so as to know whether to expect a swarm or not. Would you advise an inspection for this purpose, or does it check the bees too much? My

hives are situated in a friend's garden, and I only see them at intervals, so that, in the event of a swarm coming off, I should very likely lose it. I do not want to increase my stocks to more than two, the number I have at present, and my intention was, if either hive did swarm, to house them in a skep until the evening, and then return them to the parent hive, keeping a good look-out for the old queen, and destroying her if possible. Or, as an alternative plan, running the swarm into a spare bar-frame hive, finding the queen and destroying her before returning the swarm to the parent hive. Is this the best course to take, as I only want section honey? 5. As I already have two supers on one hive and one on the other, I am hoping to get a good surplus this year. Will it be all right to leave the supers on all the summer, until the white clover is over? By that I mean removing the full ones and adding empty ones from time to time for the next three months, tiering up three deep in the usual way. 6. Will the brood-chamber need any attention during all this time?—BEGINNER, Somerset.

REPLY.—1. You can safely leave the operation until the autumn, when there will be hardly any brood to interfere with your work. 2. You should have placed the second super below the first, and if it has not been on many days, you might with advantage change the position even now, otherwise the top one will be ready first, as bees finish off the capping of honey-cells always from the top. 3. No, not in suitable weather. You can only tell foul brood from external signs when it is far advanced and of the virulent type (see "Guide Book," page 173). 4. It will not harm the bees to make the inspection you propose. Your best plan is to put the swarm into a hive containing frames fitted with comb-foundation. Place on the supers, and put the swarm on the stand of the parent stock. The latter should be stood close to the swarm, turning the entrance a little to one side and away from it. Most of the bees on the wing will return to the old stand containing the swarm, and will thus strengthen it. As you do not desire increase, on the second and third day the parent colony can be gradually turned, so that the entrances of both hives face the same way, then take it up and place it on the other side of the swarm, with the entrance turned in the opposite direction. Cut out all queen-cells, and by changing the position of the hive from one side to the other of the swarm several times, the old stock will be entirely depopulated in three or four weeks, all the bees having gone to strengthen the swarm, when the empty hive may be removed. 5. You can place a third rack of sections below the other two, and when the top super is completed it should be removed and an empty one placed below. 6. It should not want anything doing to it unless the bees swarm.

[3946.] *Honey in Brood-combs.*—I should be glad if you would reply to following query in the BEE JOURNAL: I have four stocks of bees, and am working for section honey. On one of them I have put a super of sections, but the bees have not gone up. Upon examining the stock I find the brood-chamber choked up with sealed honey. I have not got an extractor, and am wondering whether, if I uncapped the honey in brood-chamber, the bees would carry it up into super. I believe I have read something of the kind somewhere. I should be glad to know the name of the secretary of the Middlesex Bee-keepers' Association.—PINNER.

REPLY.—Probably the colony is not strong enough for the bees to go up into the sections. It will depend on the strength of the colony whether the bees will carry up the honey when the cells are uncapped. If the super is kept warm they are very likely to do so. In any case you should remove some of the combs of honey and give them empty combs or frames of foundation, so that the

queen may have cells in which to lay. Also be careful to uncup the cells towards evening so as not to attract robber-bees. The hon. secretary of the Middlesex B.K.A. is Major Fair, 11, Anlaby Road, Teddington.

[3947.] *Observatory-hive.*—I have made an observatory-hive on the lines of that made by Messrs. James Lee and Son, and I intend to put three frames in the lower part and four sections in the upper. 1. Will you please say what combs with bees I am to choose for the lower part? Should they have much young brood or brood just hatching? 2. Is it necessary for some of the frames to have sealed honey or will a feeder on top supply all the food necessary? 3. Should the frames have a queen and be crowded with bees? 4. Ought the sections to have starters put in, drawn-out comb, or be partly filled with stored honey? 5. Will ordinary syrup for spring feeding do? 6. How often ought the bees to be changed, as I want to keep the hive in the window in my house, and I think of keeping them in a fortnight, and then putting them back on their original place in the apiary to fly for a fortnight, and so on alternately? 7. Will they be sufficiently warm in the observatory-hive, which has double glass front and back, if I have a cover to put over them of some woollen material, and then ordinary wooden cover with zinc top to put on over that? 8. How often and what condition should the frames be in to necessitate my changing them, as I presume they will store honey from the feeder and fill everything up to the exclusion of the queen from laying, and I much want to have the whole process going on in the hive from the laying of the eggs to the hatching of the bees? 9. When in the hive should they have all the food they will take from the feeder; if not, how much should be given to them per day?—W. CLARK, Walton.

REPLY.—1. Two combs should have brood in all stages of development, the third a small patch of brood, with a little honey and empty cells. 2. The frames need not have sealed honey if you supply the bees with syrup. 3. There should be a queen, but the frames need not be very crowded if wanted for observation purposes; there should, however, be enough bees to protect the brood. 4. Either will do. 5. Yes. 6. The bees should have free egress if they are to be kept for observation, and you cannot confine them for a fortnight. 7. Yes. 8. If you want to see the whole process going on you must not confine the bees, and the combs which you put in to start the colony will do for the whole season. We should, however, prefer an observatory with six frames, as the one you propose to make is not much larger than a nucleus. 9. You can see by the state of the stores in the combs how much food to give the bees, and you should supply just as much as they need. When collecting honey they may not require feeding at all.

Notices to Correspondents.

AMATEUR (Bradpole).—*Brood in Supers.*—1. If the brood is that of workers you can place excluder-zinc between the supers and hive, after making sure that the queen is below. Any drone-brood should be cut out and destroyed. 2. You can either register a design or take out a patent. Application for provisional protection costs £1, and on filing complete specification a further fee of £3 is payable. Registration of design costs 5s. S. E. (Sandhurst).—*Super-cleaver Propolis.*—The "R. H. Smith" super-cleaver was probably propolised the last time it was used. Bees quickly propolise the sensitive springs if the cleaver is left on after they have passed through, and it should be examined and propolis removed every time before it is put on for use. This cleaver is constructed so that the escape can be removed for the purpose of cleaning.

X. Y. Z. (Bungay).—*Strengthening Swarms*.—The method you propose is frequently successful when there are a large number of well-laden foraging bees, who are readily admitted and welcomed, but occasionally fighting may result, with "balling" of the queen. The better way is to place the swarm on the stand of parent hive, and remove this to the stand of a strong stock, which is in turn given a fresh place.

NOVICE (Norfolk).—*Our Failures*.—Place the two frames of brood and one of honey in the centre, empty combs on either side, and fill up with frames of foundation on the outside of these.

T. A. ROBERTS (Northampton).—*Maturing Brood Cast Out*.—If it is drone-brood that is being cast out a couple of days before hatching, it is not an unusual proceeding when cold, wet weather sets in after a period of fine, warm weather. Bees seem afraid at such times of running short of stores, give up all idea of swarming, and cast out the drone-brood. If, on the other hand, worker-brood is being thrown out, it is a most unusual proceeding, and the four small lumps of naphthaline put on the combs cannot account for it. You should make a thorough examination of the hive and note the appearance of worker-brood.

ONE IN DOUBT (Bristol).—*Bee-pasturage*.—Sainfoin is an excellent flower for bees, and the honey is of the finest quality, but the flowers you send are those of crimson clover (*Trifolium incarnatum*), which does not produce quite such a good honey. White Dutch clover, where it yields plentifully, is also first-class. Charlock produces a white honey which granulates very rapidly. If you are surrounded by houses it would certainly be worth moving the bees three and a half miles to better pasturage.

MID KENT.—*Dead Queen*.—1. The queen is a young one, and has been killed by the bees. 2. There is a slight admixture of Italian blood.

SUFFOLK (Wigston).—*Wages of Assistant*.—From 25s. to 35s. a week, according to the requirements and responsibility. We thank you for your appreciative remarks.

W. A. CRACKNELL (Kent).—*Drones Cast Out*.—It is usual for bees to cast out drones in bad weather when they are getting short of stores and have given up the idea of swarming for the time.

G. A. B. (Wallington).—*Queen Cast Out*.—The queen sent is a young unfertilised one. It is probable that the swarm was delayed by bad weather, which has given time for young queens to hatch out. You should examine swarm and see if it has a fertile queen.

T. A. B. (Chester).—*Dimensions of Boxes in "Note-book"*.—1. The lengths are given on page 63 of "Note-book." The boxes there mentioned are of the standard sizes. 2. The Secretary of the C.B.K.A., Mr. R. S. Linnell, Grosvenor Chambers, Chester, would be able to give you the information you desire.

IGNORANT (Llangollen).—*Queenless Colony*.—The comb sent is full of hard pollen and no brood. There are also four queen-cell cups, but there are no bees. The colony has dwindled owing to the loss of queen at a time when the bees were not able to raise another. The partially-built queen-cells indicate that they made an attempt at rearing one. As there is no brood there is no sign of disease in the comb.

Suspected Combs.

M. Lucy (Crewe).—Comb is unmistakably affected with foul brood.

D. O. G. D. (Dumfries).—There is no brood in comb, which contains nothing but new pollen and a few cells of sealed honey.

IREA (Hereford).—The comb is affected with sour brood. The larvae in uncapped cells are too young to distinguish between worker and drone, but the capped cells contain drone-brood.

Special Prepaid Advertisements.

Twelve words and under, Sixpence; for every additional Three words or under, One Penny.

PUPIL-ASSISTANT WANTED IMMEDIATELY for Lecturing Tour; some knowledge Bees; pleasant holiday; small wage and expenses.—Write full particulars, EDWARDS, 22, Carnarvon-road, Reading. r 25

SWARMS WANTED. Boxes sent to ensure safe transit if required.—POSTMASTER, Breachwood Green. r 25

"W. B. C." HIVES FOR SALE, 10s. 6d. each; also good Extractor and quantity of accessories.—WILLIAMS, "Sunnyside," Wellington-road, Bilston. r 23

FOR SALE, all from healthy Stocks, and clean. 40 Shallow Combs, 2 Standard Combs, 2 Frames Wired Foundation, 19 Sheets first quality Shallow Foundation, 2 Sheets Brood Foundation, 20 Zinc and Tin Dividers, 3 Queen Excluders. The lot for 25s.; removing.—HENRY ROWSWELL, 116, Mawson-row, Chiswick-lane, Chiswick. r 24

OVERSTOCKED.—1 Stock Bees for Sale, 1909 Queen, with new "W. B. C." Hive, 30s. Expert's Certificate given.—J. BOWDEN, Broomhill, Witley, Surrey. r 22

WANTED. Letterpress, good order. Exchange Bees on Frames, or cash.—W. WOODS, Normandy, Guildford. r 21

FOR SALE, 6 "W. B. C." SECTION RACKS, extra strong, with 2 Lifts, double Floors, zinc covered, and painted, 15s. each; 2 good Hives, of other pattern, 10s. each, in excellent condition; 5 Crates "W. B. C." Hanging Frame Sections, with metal divisions, partially filled with Foundation partially drawn, 3s. 6d. each, or 15s. for lot; Super Clearer, Smoker, 4 Feeding Bottles and Stages, Eke, 42 Section Glasses, Quilts, 2 Section Show Cases, sundry small appliances. Owner giving up Bees. No reasonable offer refused.—Apply, MR. ROCHE, 40, Wellington-road, Oxtou, Birkenhead. r 20

VIRGIN QUEENS, Sladen's strains, 1s. 9d., 3 5s.; fertile, 5s. 6d.; Nuclei from 12s. 6d.—PAUL, Salisbury-road, Bexley. r 10

GIVING UP BEES.—Ungeared "Guinea" Extractor, good condition, 8s.—11, Havelock-road, Birchfields, Birmingham. r 19

HIGH-CLASS MICROSCOPE, by well-known maker, 3 objectives, eye-piece &c., splendid condition, 30s., great bargain.—L. WAKEFIELD, Blackmore, Bromsgrove. r 18

1909 FERTILE QUEEN, Sladen's and Woodley's Blacks, 3s. 6d., guaranteed safe arrival in introducing cages.—TOLLINGTON, Woodbine Apiary, Hathern, Loughboro'. r 17

SWARMS, 4 lb., guaranteed healthy, despatched per return on receipt of P.O. 15s.—H. WILCOX, Breddon Apiary, Northwood, Oton. r 16

8 WELL-MADE HIVES, with all appliances. worked-out Section, and Shallow Frames, to be cleared out cheap. Owner leaving the town.—Particulars from G. BROOKS, 41, Warwick-street, Rotherham. r 15

FOR SALE, 6 "W. B. C." SECTION CRATES, nearly new, cost 4s. 6d. each; also 70 Bar Frames, Standard, new, and about 50 Sections, 60 wood Cases, with glass, safely packed, 18s. lot, or offer.—TAYLOR, Sutton-on-the-Hill, Derby. r 14

MUST SELL IMMEDIATELY, 1 strong English Stock, 3 "W. B. C." Hives, guaranteed healthy, Comb. Appliances, Ungeared Extractor (new).—BECKETT, Roughdown, Boxmoor, Herts. r 13

WANTED, good Honey Extractor (geared). Quote make.—HOLMAN, Lydfords, East Hoathly, Sussex. r 12

FOR SALE, genuine Simmins' "Conqueror" Hive, good condition, Brood Box, to take Standard Frame, Supers fitted with Simmins' latest method of twin Frames, to take Divided Sections. Cost 50s.; will take 20s.—"ESSX," c/o B.B.J. r 38

Editorial, Notices, &c.

REVIVAL OF THE GLUCOSE CANARD.

It is not an agreeable task to have to call attention to misstatements made in other papers, but in the interest of justice it is sometimes necessary to do so, especially when such papers do not make the corrections when their attention has been called to the gross injustice done to the industry by such misstatements.

The old story of "glucose honey," invented by some newspaper man as a sensational article for the *Yellow Press*, seems to be revived again, and it has managed to find its way into this country. It has fortunately not yet made great headway, but a short time ago our attention was called by Mr. E. R. Root to the following leader in the *Family Doctor* of February 20 last, headed:

"GLUCOSE HONEY.

"It is not generally known, says a correspondent hailing from America, that the bees of many professional honey producers in that country do nothing the livelong summer but pack glucose into their hives from an open barrel that is left standing close by. The bee will not search fragrant flowers the livelong day for a trifling amount of pure honey when he can get glucose. The honey men see that there is plenty of glucose handy, and instead of one pound of pure honey they aid the bees in putting ten pounds of glucose on the market. Human ingenuity has not devised a way for making and sealing the honeycomb, or the bee would be dispensed with altogether. In handling the glucose the bees give it a honeyish flavour, and if you complain to the bee-man that it is not as sweet and sticky as it should be, he will tell you that it is the early crop, and that the heavy rains make it thin."

At the same time Mr. Root wrote the following letter to the publishers, calling their attention to the article:—

"*Gleanings in Bee-Culture*,

"Medina, Ohio, March 5, 1909.

"The *Family Doctor* Pub. Co.,
London, W.C., Eng.

"GENTLEMEN,—Our attention is drawn to an editorial in your issue for February 20 of the current year, entitled 'Glucose Honey.' The statement is broadly made that the bees of many professional honey-producers of America do nothing the livelong summer but pack glucose into their hives from an open barrel that is left standing close by. The impression derived from this item is to the effect that this is the way many of the bee-keepers produce their so-called honey. We desire to draw your atten-

tion to the fact that bees will not take raw glucose. The matter has been tried time, time and again. It has too low sweetening power to attract them in the least. They may take a product known commercially as grape sugar, and sometimes known as glucose, but even that product could not be marketed. It has a very low sweetening power and it would cost more to get the bees to take it than the product would be worth after it was put on the market. It is as much as ever the bee-keeper can do to make a profit off the nectar that comes from the flowers, which is as free as the air we breathe. If he had to pay for an artificial substitute he would make no margin in the operation. We hope you will see your way to correct the false impression and thus do justice to some three or four hundred thousand honest people who keep bees and produce honey in a perfectly legitimate and proper way. The item to which you refer originated from the brains of a newspaper man who evidently was trying to get bee-keepers to buy glucose from the Glucose Trust. It was copied to some extent in our eastern papers on this side of the ocean, but was so palpably absurd that the story failed to travel; but I notice that it is beginning to gain credence on your side of the line. Bee-keepers from all over the United States, when the story was published in this country, showered in their protests. Most of the papers at the time published retractions.

"Believing that you are sincere and that you desire to publish nothing except that which is strictly true, we would request that you write to Thos. Wm. Cowan, Upeott House, Taunton, England, Editor of the *BRITISH BEE JOURNAL*, London, an acknowledged authority on bees and honey throughout the United States, and, in fact, in the world. We are perfectly willing to rest this case with him.—Yours truly,

"(Signed) E. R. Root,

"Editor *Gleanings in Bee-Culture*."

We have also written to the editor three times pointing out that the editorial was evidently written under a misapprehension of the facts and based on untrue representations, and asking to be informed if any correction had been made respecting these statements. The editor has not even had the courtesy to reply, and on our calling at the office of the *Family Doctor* on May 21 we were informed that no further notice had been taken of the matter.

Every bee-keeper knows that bees will not take glucose, and that they soon perish if forced to use it, so that the whole story is an idle invention. To say that the bee will not search fragrant

flowers when it can get glucose is untrue. We have travelled in the United States and visited every State in the Union but one, and must say the bee-keepers whom we met would one and all scorn such an idea as giving bees glucose. We think that in justice it is due to them to publish this correspondence, and as our contemporary who has made these statements seems reluctant to retract, as the American papers have done, we would ask our readers to make the matter as public as possible, and see that the circulation of this canard is stopped before it goes any further.

THE "ROYAL COUNTIES" SHOW,
HELD AT READING.

The "Royal Counties" Agricultural Society held its forty-ninth annual show, from June 8 to 11, at Reading this year, the site selected being Prospect Park, the largest of Reading's public open spaces. Fortunately, good weather was experienced for the most part during the course of the show, though the drenchings of the previous week had left the ground in anything but a comfortable condition for getting about.

As is usual when the show is held in Berkshire, the Apicultural Section was under the management of the Berkshire B.K.A., Messrs. D. W. Bishop Ackerman and H. Edwards officiating as Hon. Secretaries of the section, and the latter being responsible for the arrangement and decoration of the honey shed and the staging of the exhibits. A screened enclosure had been arranged at the side of the shed, and within this a small "model" apiary of three frame-hives of differing type and a straw skep was located; and the lectures and demonstrations given therein at intervals by Mr. Edwards, as is usual at shows, drew large and interested audiences.

Speaking of the show as a whole, the number of entries constitute a record, and the same may be said of the bee-department; and, with the exception of the Royal Agricultural Society's visit to the town in 1882, never has such a magnificent display of honey been seen in Reading. Usually this show is held too early in the season for much of the current season's produce to be staged, but in view of the early spring this year, and the generally forward condition of the bees, classes for the produce of 1909 were included and produced some good exhibits, though the fortnight of impossible bee-weather immediately preceding the week of the show made its influence felt by preventing the staging of not a few entries. However, no less than 51 ft. of stepped staging had been provided for honey, and this literally

groaned under the produce of the honey-bee.

Messrs. F. B. Parfitt, J.P., chairman of the Berks B.K.A., and H. W. Seymour, of Henley, acted as judges, and made the following awards:—

Collection of Appliances.—1st, E. H. Taylor, Welwyn; 2nd, Mrs. Seadon, Bromley.

Best and Most Complete Frame-hive.—1st, Abbott Bros., Southall; 2nd, E. H. Taylor; 3rd, Mrs. Seadon.

Inexpensive Frame-hive.—1st, E. H. Taylor; 2nd, C. Greenhill, Wimbledon; 3rd, Mrs. Seadon.

Honey Trophy.—1st, J. Pearman, Derby.

Twelve 1-lb. Sections.—1st, J. Pearman; 2nd, W. E. E. Charter. Tattingstone.

Twelve Jars Light Extracted Honey.—1st, R. W. Lloyd, Thetford; 2nd, A. Turner, Amersham; equal 3rd, R. Morgan, Cowbridge; W. J. Cook, Binbrook; and S. G. S. Leigh, Broughton; h.c., E. Church, Cardiff.

Twelve Jars Medium Honey.—1st, W. F. Trineman, Saltash; 2nd, A. J. Brocks, Nether Wallop; equal 3rd, Fred Harris, Sibsey, and A. Turner; h.c., Miss Alice Allnutt, Wittenham.

Twelve Jars Granulated Honey.—1st, R. H. Baynes, Cambridge; 2nd, W. J. Cook; 3rd, J. Pearman; h.c., F. R. Ford, Burwell.

Six 1909 Sections.—1st, W. E. E. Charter; 2nd, Miss Alice Allnutt; 3rd, Miss F. E. Barker, Dunmow; h.c., R. H. Baynes.

Six Jars 1909 Honey.—1st, Albert Sandys, Drayton; 2nd, A. Turner; 3rd, Miss F. E. Barker.

One Section Sent by Post.—1st, Miss Courselles-Jones, Pangbourne; 2nd, Miss Millard, Winchfield; 3rd, C. W. Dyer, Compton; v.h.c., R. W. Johnson, Little Hinton.

One Jar of Honey Sent by Post.—1st, R. W. Johnson; 2nd, R. H. Baynes; 3rd, C. W. Dyer; v.h.c., A. J. Brocks.

Beeswax.—1st, E. C. R. White, Newton Toney; 2nd, W. F. Trineman; 3rd, A. J. Brocks; h.c., J. Pearman.

Beeswax in Cakes for Retail.—1st, E. C. R. White; 2nd, J. Pearman; 3rd, W. E. E. Charter.

Inventions.—1st, H. Edwards, Reading (divisible standard frame and nucleus hive to take whole or halved frames); 2nd, Abbott Bros. (patent honey spoons); 3rd, E. H. Taylor (hanging frame to hold six sections).

Observatory Hive.—1st, E. H. Taylor. Consolation prize of 5s. (the exhibit arriving too late to be staged in time for the judges), H. D. Davidson, Basingstoke.

Photograph.—1st, C. W. Dyer; 2nd, W. E. E. Charter; equal 3rd, C. J. Johnson, Caversham, and Miss Scott Walker, Slough.

OPEN TO RESIDENTS IN BERKS OR WITHIN TWENTY MILES OF READING.

Twelve 1-lb. Sections.—1st, W. Woodley, Beedon.

Twelve 1-lb. Jars Light Honey.—1st, W. Woodley; 2nd, C. W. Dyer.

Twelve 1-lb. Jars Medium Honey.—1st, Miss Scott-Walker; 2nd, A. Gibbs, Reading.

Twelve 1-lb. Jars Granulated.—1st, T. A. Flood, Reading; 2nd, Miss Alice Allnutt; 3rd, C. W. Dyer.

MEMBERS' CLASSES.

Six 1-lb. Sections.—1st, W. Woodley; 2nd, Miss Gill, Reading; 3rd, A. D. Woodley, Reading.

Six Jars Light Honey.—1st, W. Woodley; 2nd, F. Chapman, Goring Heath.

Six Jars Medium Honey.—1st, Miss Alice Allnutt; 2nd, C. J. Johnson; 3rd, A. Gibbs.

Six Jars Granulated.—1st, F. Chapman; 2nd, Miss Scott-Walker; 3rd, A. Gibbs.

Bee-swar.—1st, Miss Scott-Walker; 2nd, C. J. Johnson; 3rd, A. Sandys.—H. EDWARDS, Hon. Sec.

Correspondence.

The Editor does not hold himself responsible for the opinions expressed by correspondents. No notice will be taken of anonymous communications, and correspondents are requested to write on one side of the paper only, and give their real names and addresses, not necessarily for publication, but as a guarantee of good faith. Illustrations should be drawn on separate pieces of paper. We do not undertake to return rejected communications.

ISLE OF WIGHT BEE-DISEASE.

(Concluded from page 235.)

[7501.] With one exception, all the swarms presented by Messrs. Hancox, Chandler, Atkins, Miss Taunton, the Croydon Association, and others are doing well.

The stocks purchased from Mr. H. Davidson, of Basingstoke, and the driven bees obtained from Mr. W. J. Pritchard, of Andover, and Mr. S. G. S. Leigh, of Broughton, have without exception all done well. Mr. Davidson's stocks (and these, by the way, were selected vigorous ones when sent) have given a remarkably good account of themselves. They are black bees with good-sized white bands, evidently with a touch of Carniolan in them.

A significant feature is that three or four lots which came from districts in England (such as Guildford district) which this spring have developed similar symptoms to the Isle of Wight disease, died soon after their arrival. One

gentleman, who has persistently but unsuccessfully endeavoured to keep his apiary going with Italian hybrids, has his two remaining colonies both affected. On the other hand, a gentleman who moved his apiary from the mainland to the island in March, 1908, had a remarkably good season, and his stocks are all going strongly. His theory is that the disease is a sort of fever; but he has not seen it, and therefore his opinion does not count.

One of the stocks purchased from Mr. Davies, Bagshot, Hungerford, finished up so strong as to winter on twenty frames; while another instance of a box with fixed combs, transferred at end of May, 1908, gathered 70 lb. of honey and covered twelve frames the last week in April. These two cases were within a few yards of the site of old affected apiaries, and the same hives used, but thoroughly disinfected with a painter's lamp.

Two or three affected stocks which were offered to Dr. Malden in April for experiment have since so thoroughly recovered as to be supered. I have only heard of one case of a healthy stock at the time of my visit since showing affected symptoms.

Mr. H. M. Cooper, of Thorley, has always hoped eventually to find a hardy strain of bees which would survive and flourish. Evidence goes to show that only one stock has survived of the strain of bees which were in the island before the outbreak, and from this stock I have made arrangements to rear some queens.

Mr. Cooper, who long hesitated between two opinions, has finally come to the conclusion that the disease is infectious, and further that, when once a stock is affected, although it may temporarily recover, do what one may, it will eventually succumb. He has considerable doubts regarding the eventual fate of the stocks sent to the island, and states that his experience shows that when they have been about eighteen months in the island they go wrong.—J. SILVER, Croydon.

DISASTERS THROUGH USING DISINFECTANTS.

[7502.] In B.B.J. for May 27 (page 205) an account is given of a colony having been destroyed accidentally by using chloride of lime as a disinfectant, it having been placed on the floor of a hive containing bees. For the writer's and other bee-keepers' information I wish to publish my experience with carbolic acid. Foul brood recently occurred in two of my hives, A and B. I transferred all the bees from B, as well as four frames of brood (slightly infected), after spraying latter as directed in pamphlet on "Cure of Foul Brood," with weak solution of soluble phenyle— $\frac{1}{2}$ dr. to 40 oz. of water—into

hive C, which two days previously had been thoroughly washed over with a solution of carbolic acid (Calvert's No. 5)—1 to 2 parts of water—and been left exposed to the weather. The hive was quite dry, but smelt strongly of carbolic. Into same hive I also transferred all the bees from A (a very weak stock), uniting with flour. In both cases the bees were shaken off the frames in front of the hive C, which had been placed on the stand previously occupied by B. Hives A and B were removed for disinfection. The bees took possession of the hive, and apparently no fighting ensued. The two queens were presumably present with the double colony. A cold night supervened, and on the following morning (May 15) the ground in front of the hive was strewn with dead and dying bees. All that remained in the hive was a cupful of bees (including one of the queens), which had crawled between the quilts and as far away from the wood-work as possible.

It appears to me that the disaster was due to using a hive too soon after disinfecting with strong carbolic. I hardly think fighting was the cause, although I recognise it was a mistake having a second queen in the hive. The question arises in my mind: Is carbolic, in the strength I used, a suitable disinfectant, especially if the hive has to be used soon again? I think not. I am experimenting now with corrosive sublimate—1 in 1,000 parts of water. It is exceedingly cheap, is a powerful disinfectant, and leaves no smell. But here again I want to know: Is there any chance of poisoning the bees through their sucking up small particles of the poison from the wood of the hive?

Perhaps, Mr. Editor, you will very kindly answer my question; and if bee-keepers who are interested would say what, in their experience, is the most efficient disinfectant to use with infected hives I am sure many would be grateful for the information.—F. D. E., Bedford.

[We have for the last twenty years, after washing them, painted all our hives inside with carbolic acid in the proportions stated, and after exposing them in the sun for twenty-four hours have used them without their ever doing the bees any harm. All our hives are disinfected this way twice a year, but if we are not able to expose them to the sun we allow them to remain for a longer time before using. We find this and soluble phenyle the best disinfectants to use. Corrosive sublimate is a powerful disinfectant, but is so extremely poisonous that we cannot recommend it for general use. The solution, moreover, is quite clear and odourless, rendering it all the more dangerous.—Ed.]

BRITISH BEE-KEEPERS' ASSOCIATION

[7503.] I read Mr. G. Hepburn's letter in B.B.J. of May 27 with great pleasure, and consider the scheme he outlined is just about what is wanted. Here in Dorset there is no association, yet we have many residents interested in bees, appliance manufacturers and agents, experts, and several prize-winners at the leading shows. I regret to see we have also a few bad cases of foul brood somewhere in the county. There is much arable land, with its ever-varying honey-producing crops, meadows of flowers, and down by the coast thousands of acres of ling. I for one should like to belong to a branch of a strong central association with a committee of broad-minded business and scientific men, whose actions should command the respect and co-operation of all bee-keepers. What could they do with a 1s. or 2s. 6d. subscription from each member? Why, compel all bee-keepers to be clean and sanitary, make neglected foul brood impossible, instruct those that have little opportunity of acquiring bee-knowledge, give prizes at local shows perhaps, make themselves felt in legislative and farmers' club measures, and so enhance one of the side-industries of our country for the benefit of all.—T. H. NEWMAN, June 12.

BEE-NOTES FROM DERBYSHIRE.

[7504.] I have been asked to tell readers of the BRITISH BEE JOURNAL how my late-mated queen has turned out. On May 15 she half-filled six frames with brood, but for the benefit of new readers I will just give a brief outline of the history of the stock. The queen in question was mated on September 19 last, when she was just six weeks old. The first brood would hatch about the middle of October. There was not 1 lb. of bees in the hive then, and they hardly covered three frames. I kept feeding the stock till the end of November, when I was pleased to see patches of brood. To encourage the bees I put in two combs of heather-honey and packed the hive up for winter. On making my first examination in March I found patches of brood on three frames. It almost seems as if the queen has never stopped laying since she started. I have hives which came back from the moors packed with bees and honey on eleven frames which are not doing half so well as this one, and the queens heading them are not two months older than she is. The experience I have had in this connection shows that everything centres on the queen, and the prosperity of the colony depends mainly upon whether she is a good one or not. Sometimes one can buy 4-lb. lots of driven bees

in August that would not winter like this lot. Beginners in bee-keeping should never despair, and if you have a little lot of bees, just feed them gently till the end of November, and watch the result. I shall let readers know the quantity of honey taken from this stock after the heather season is over.

We have had some good bee-weather this spring; but on May 15 I rather thought I had awakened at Christmas, for it was snowing hard and the hive-tops were covered with an inch of snow, the Matlock Hills being white for the greater part of the day.

Bees are coming on very well now there has been plenty of fruit bloom, and sycamores are coming into flower, while the hedgerows are white with blossom. My best stock has nine frames of brood, while the worst has only five. The best stock I have seen this year is a hive belonging to a friend which has not been opened for eighteen months. When I examined it to-day it was a sight to behold: twelve frames literally packed with bees, and brood on eleven of them. I made a swarm on the "Alexander" principle, but as the combs are such badly-shaped ones I shall let all the bees hatch out before putting on supers.

We have just had a week of ideal bee-weather, honey coming in fast; in fact, I saw a super full to-day, and the honey is of very good quality. The season has opened well; let us hope it is going to be a record one.—TOM SLEIGHT, Danesmoor.

RESPECTING PARTHENOGENESIS.

[7505.] I shall be grateful for an explanation of the following point, which has somewhat puzzled me. In your wonderful book "The Honey-bee" and in bee-papers I have read of parthenogenesis, which I understand means reproduction without fecundation, or mating. How can it be reproduction in the true sense of the word when there are only males produced by an unfertilised queen? Though I do not agree with suffragists wearing the trousers, still in bee-life we must acknowledge that the amazons hold sway, the males taking third place. Were the eggs of an unfertile queen to produce females, as a fertile queen does at present, and the same metamorphosis and after-life take place with her progeny, as in the case of a fertilised queen, we could say there was parthenogenesis; but as the drone is a non-breeder in himself, I fail to see the point. There may be production without fecundation, but not reproduction. What do you say?—A REGULAR READER, Birstwith, Leeds.

[We are afraid that our correspondent will have some difficulty in getting the word "reproduction" changed to "pro-

duction," since the term "parthenogenesis" and its definition have been so long settled upon by scientists. The New English Dictionary defines parthenogenesis as "the reproduction without the union of sexual elements." Then we find the word "reproduction" defined as the action or the process of forming, creating, or bringing into existence again. Parthenogenesis was thus defined by Professor Owen in 1843, Von Siebold in 1856, and Leuckart in 1858, and in books treating on the subject of heredity. Professors Geddes and Thomson in their work on "The Evolution of Sex" also call it "degenerate sexual reproduction." Weismann in "The Germ-plasm: A Theory of Heredity," calls it "reproduction by means of unfertilised ova." Webster's American Dictionary, however, defines parthenogenesis as "the production of new individuals from virgin females," so that our correspondent has some reason in his contention. We may therefore take it that both may be correct definitions, although the former is the one universally adopted by scientists.—ED.]

MODELS IN BEESWAX.

[7506.] I had very little time available when in Berlin to see bee-keepers. I was able, however, to pay a long-promised visit to the director of the Berlin Museum of Antiquities, who showed me many interesting things. In the Egyptian department, especially, were some objects that would have interested bee-keepers. No. 17,561 is a beautifully-modelled head of Osiris in beeswax from one of the ancient tombs. Even the delicate head ornaments are perfectly preserved and as sharp as if they had been made yesterday. They are probably at least 3,000 years old. Nos. 17,562 and 17,563 are two heads of sons of Osiris, also in wax, but with less elaborate ornamentation. With them is No. 17,564, a scarabæus, also moulded in the same unbleached wax.

There is a curious representation of a queen-bee on the base of a statue of Rameses II., a king of the Nineteenth Dynasty who lived from 1300 to 1230 B.C.—WALTER F. REID, Addlestone.

BEEs TRANSPORTING EGGS.

[7507.] I have had exactly the same experience as Mr. Holt (7492, page 227, B.B.J., June 10), viz., a queen-cell with healthy live queen in shallow frame over the excluder, which convinces me that bees must at times transport eggs.

Bees are pretty forward here. I have sections filled and almost ready to take off on most of my hives, some with two racks nearly completed, and have extracted full shallow-frame racks from two

hives. The best of the harvest is yet to come; white clover is just beginning to bloom, and fine, warm weather is all that is now required to make a record take.

The early honey is from charlock, trefoil, and fruit blossom, and granulates almost as soon as it is removed from the hives. I extracted some on Sunday last, and to-day (Thursday) it is quite solid and perfectly white.

Last week was one of wet weather here, and I think and hope put the idea of swarming out of the heads of two or three stocks which were that way inclined. I have had two swarms up to the present in spite of the usual endeavours to prevent them—one on Sunday, May 16, and one on Sunday, May 30. The presence of the queen-cell before mentioned in the shallow-frame rack showed that that stock had the swarming impulse, in spite of the two surplus-chambers on top; but I think that an empty rack and last week's rain have stopped that. They are working well now.

Hoping for bee-weather to raise the hopes of all bee-keepers and that the expectations may be realised—G. F. WESR, Fareham, June 10.

A REPORT FROM MEXICO.

[7508.] The season has been terrible for bees around here, as we have had but one shower of rain since September 8, 1908. I have only taken a little over 100 lb. of honey per hive, and the season is passing and the weather hot, so that bees can collect but little nectar, as the heat dries it up in the flowers. Nevertheless, the bees are flying long before sunrise. With kind regards.—FRANK W. BREACH, Chinipas, Mexico, April 19.

BEEES AND CHLORIDE OF LIME.

[7509.] There is nothing new in the use of chloride of lime for disinfecting hives, for Neighbour's good old book, "In the Apiary; or, Bees and Bee-hives, &c.," mentions a case in the period of Mr. Woodbury's early days of an apiary being completely cured by its use in cleansing hives before being occupied again by bees.—Tom Cox, Yardley.

BEE-KEEPING IN BUCKS.

The Bucks County Education Committee is, through the medium of the Bucks County Bee-keepers' Association, arranging for a bee-van lecturing tour of five weeks' duration, during which all Parliamentary divisions of the county will be visited, lectures and demonstrations being given daily. The tour, which commences on Monday, June 28, and continues right through July, will be conducted by Mr. H. Edwards, and a full

itinerary is printed in the association's annual report, a copy of which will be sent to anyone in the county applying for it by the hon. secretary, Miss Scott-Walker, 5, High Street, Slough.

AMERICAN AND COLONIAL PAPERS.

EXTRACTS AND COMMENTS.

By D. M. Macdonald, Banff.

Shifting Bees.—"I had to move a hundred-colony yard some twenty rods, after they had been flying for a month. I did so at once by setting some obstruction in front of each hive, and I met with no serious loss. A few bees went back during the day, but at night they seemed to return to their own hives." This is the experience of a writer in *Gleanings*. In spring it is a well-known fact that bees can be shifted without any very evil consequences, if done with care. Altering the face of the hive, and blocking the front entrance so much as to obstruct the exit of the bees, force them to mark the location. A number of hives were shifted near here about half a mile from the old site. A few cold days kept them prisoners after the change of position, and the bees never looked near the old home.

A Bee-flora.—"Every European country has a honey 'flora.' Russia probably has the best," says W. K. Morrison in *Gleanings*. I am doubtful if one can get a good book on this subject in Britain. One exists in France and one in Spain. There is room for an English one. Who will do for our "honey flora" what Mr. Cowan has done for wax?

Swarm Control.—"The colony that has given the biggest yield in surplus is certain to have fooled away no time in swarming," says Dr. Miller, and he gives a few tips worth noting in seeking to hinder swarming. "I try at all times when bees are storing to let them have more surplus room than they need." "A bait-section attracts them above before they are crowded into sections." "I use a space of two inches under bottom bars, which leaves plenty of room for ventilation." "An empty super not required by the bees is placed above all; if the bees need it, it's there." "A young queen, laying only a few days, replaced an old queen." He put a lower story under the full one, confining the queen below by excluder in a few cases. These tips all tell, but still, after forty-five years' experimenting over swarm control, the veteran Doctor concludes: "I haven't got fully there yet!"

Re-queening.—Mr. Townsend, in *Review*, tells how he deals with a queenless lot in spring. "I mark the queenless colony, and at night quietly remove the cover, go to one of the light colonies with

a queen, carry it, without the bottom board, and set it on the top of the queenless colony. They are not disturbed again for four days, when the lower hive may be removed." In the hands of a veteran nothing else is required, but most beekeepers might with advantage place a sheet of rough brown paper above the frames of the lower hive, piercing one or two small holes near the centre. In the course of a few days, if they are examined, it will be found that both lots have gradually amalgamated. The small hole in paper has been enlarged to provide an ample passage-way.

Spring Pollen.—The editor of the *Canadian Bee Journal* states: "For the first time in our experience we found no pollen in our hives. All that had been stored was used up, and the queen had ceased laying." At once when fresh pollen began to come in queens re-started ovipositing. At times in Australia a dearth of pollen makes sad havoc, and depletes some apiaries to such an extent that they run down to nothing. In this country, while we have no regular pollen-famine, bees are much encouraged to early spring breeding by a supply of artificial pollen. For a number of years now I have not supplied any.

Diseased Brood.—The Canadian Department of Agriculture, in a leaflet on foul brood, wisely advises destruction of such brood. "Brood from diseased colonies is of no value and dangerous, and should be matted, burned, or otherwise destroyed at once. Brood from colonies having only a few cells diseased might be placed over an average colony only slightly diseased, and the queen caged. When most of the brood has hatched, treat as given above." That is, burn it. Of combs showing no disease, but yet of doubtful purity, it is recommended wisely: "It would pay best to melt them into wax and use full sheets of foundation." In this country combs having even a shadow of a doubt over them should never be returned to any hive, however fair they may look. Then there follows this further interesting item, which the editor and some of the inspectors might well ponder over and faithfully practise: "Empty lives in which the bees have died, or diseased combs have been stored or carried, should be scalded, or the inside burned over with a gasolene or oil torch." At headquarters disinfection is evidently understood and appreciated.

High-priced Queens.—A writer in the *Australian Bee-keeper* says: "I never could understand why bee-keepers should spend, say, 30s. on an extra special queen when they can buy six of her daughters for the same money, any one of which may be as good as her mother."

WEATHER REPORT.

WESTBOURNE, SUSSEX.

May, 1909.

Rainfall, 1.96 in.	Minimum temperature, 31° on 3rd.
Above average, .02 in.	Minimum on grass, 22° on 15th.
Heaviest fall, 1.17 in. on 24th.	Frosty nights, 2.
Rain fell on 9 days.	Mean maximum, 61.1
Sunshine, 344.8 hours.	Mean minimum, 41.5.
Above average, 113.1 hours.	Mean temperature, 51.3.
Brightest days, 19th and 30th, 14.3 hours.	Exact average.
Sunless days, 0.	Maximum barometer, 30.428 on 3rd.
Maximum temperature, 72° on 12th and 22nd.	Minimum barometer, 29.473 on 26th.

L. B. BIRKETT.

MAY RAINFALL.

Total fall, 1.15 in.
Heaviest fall in 24 hours, .57 in. on 24th.
Rain fell on 6 days.
Below average, .96 in.

W. HEAD, Brilley, Herefordshire.

Queries and Replies.

[3948.] *Brood in Supers.*—I should esteem advice in your paper on the following details. I was advised by a friend to try running a hive for extracted honey with no excluder, and using all worker-base foundation. The results are as follows: On May 15, No. 5 hive having the whole ten frames filled with brood, I put on a ten-frame super of shallow frames, fitted with worker-base foundation. The bees took to this at once, drew combs out, the queen laid in middle four frames, and honey was stored in others. On June 7, as the bees seemed very crowded, I put another super under the first one; to-day (June 12) the top super is crammed with brood and honey, and the bees have started several queen-cells (these now contain eggs); the second super put on has not been touched; the brood-box has a lot of empty cells, and no eggs have evidently been laid in it for some little time. From the above I surmise that when I put on the second super the queen was up in the first one, and then would not go down over the bare foundation to the brood-combs in brood-box, and being cramped for room in the super for laying, and bees for store-room, they have started queen-cells. I have now cut all queen-cells out, and have put the full super from the top next the brood-box, and placed the empty super over this. Do you consider my surmise correct, and have I done the best thing under the circumstances to stop swarming? Your advice will be very much esteemed. Thanking you in anticipation.—EXCLUDER, Warwickshire.

REPLY.—You have done the best under the circumstances, but you did wrong in dividing the brood-nest by placing an empty super between body-box and super containing brood without making sure that the queen was below. Your experience also demonstrates the advisability of using queen-excluder.

[3949.] *Bees Transferring Themselves from Skeps.*—Will you kindly inform me upon

the following point? I have six skeps of bees transferring themselves into six hives in the usual way. These hives stand in a straight line, each separated 5 ft. from the next. At the end of the line is a summer-house, where I want to winter the skeps, setting them on two shelves, one above the other, each shelf to hold three skeps. After removing the skeps from the hives in due course, might one take the six at once direct to their places in the summer-house instead of removing them by degrees in the customary fashion? The bees from the skeps which reverted to their hives would be welcome provided enough remained to look after the brood in the skeps so as to establish a stock for wintering. Thanking you in anticipation.—A. B., Norfolk.

REPLY.—By the time that the bees have transferred themselves to the frame-hive below, there should be no brood in the straw skeps, which should by then be filled with honey. Therefore, they could not be used for wintering bees, but must be treated as supers.

[3950.] "Telling the Bees."—I am sorry to say that a brother bee-keeper's wife has died in this district, and some of the people here who are also bee-keepers are trying to persuade me that we must go to the hives owned by the man whose wife has died and tell his bees what has happened. I think it rather foolish, but an answer in the B.B.J. would give them all a clear understanding. Hoping to see a reply in your columns.—E. W., Bricklin, Kensworth.

REPLY.—This is an old superstition for which there is but little foundation of either truth or reason. The custom of "telling the bees" was pretty general in Europe at one time, but with the advance of education happily such superstitions are fast dying out, and there are very few now who believe that loss of the bees is connected with this superstition. It arose from people having through bad management, as they do now, lost their bees, and remembering that a death had occurred at the time, without any reason connected the two things together. Then, when by a curious coincidence the two things happened again at the same time, the idea took root and grew, until at last people imagined that if a death took place it would bring misfortune to the bees. Happily people know better now, and attribute the loss of their bees to the proper causes.

Bee Shows to Come.

July 15 and 16, at Louth.—Show of Honey, Hives, and Bee-appliances in connection with the Lincs Agricultural Society. **Entries closed.**

July 21 and 22, at Cardiff.—Glamorgan B.K.A., in connection with the Cardiff and County Horticultural Society's Coming-of-Age Show. Members', Novices', and Open Classes. Record Schedule from W. J. Wiltshire, Maindy Schools, Cardiff. Judge, W. F. Reid, Esq., F.I.C., F.C.S. **Entries close July 18.**

July 21 and 22, at Tamworth.—Staffs B.K. Association Annual Exhibition, Honey, &c. Six open classes. Excellent money prizes. Schedules from Joseph Tinsley, Expert and Lecturer, S.B.K. Assoc., 22, Granville Terrace, Stone, Staffs. **Entries close June 26.**

August 2 (Bank Holiday), at Clewer, Windsor.—Show of Honey and Appliances by the Windsor Branch, Berks B.K.A., in conjunction with the Clewer Horticultural Society. Schedules from Hon. Sec., Mrs. W. S. Darby, 1, Consort Villas, Clewer, Berks. **Entries close July 28.**

August 4 and 5, at Abingdon Park, Northampton.—Honey Show of the Northants B.K.A. Special prizes for open classes, including one for

single 1-lb. jar honey. (Entry free.) Judge, Mr. W. Herrod. Prizes 20s., 10s., 7s. 6d., and 2s. 6d. Schedules from R. Ifford, Hon. Sec., Kingsthorpe, Northants. **Entries close July 28.**

August 10 to 12, at Beverley.—Show of Honey, &c., in connection with the Royal Yorkshire Agricultural Society. Schedules and form of entry from John Maughan, Secretary, Blake Street, York. **Entries close July 3.**

August 18, at Lancaster.—Lancaster Agricultural Society, in conjunction with the Lancashire B.K.A. Fifteen Classes for Honey and Bee-produce; also for Bee-hives. Numerous special prizes, including two silver challenge cups, twelve silver and bronze medals, &c. In applying, state Honey Schedule required. Thos. Armistead and Son, Secretaries, Lancaster; or J. M. Bold, Almonds Green, West Derby, Hon. Sec. Lancs B.K.A. **Entries close August 4.**

August 18 and 19, at Shrewsbury.—Annual Show of the Shropshire B.K.A., in connection with the Shropshire Horticultural Society's Great Floral Fête in The Quarry. Nine Open Classes for Honey and Wax. Schedules from S. Cartwright, Shawbury, Shrewsbury, Hon. Sec. **Entries close August 6.**

August 25 and 26, at Stratford-on-Avon.—Annual Show of the Warwickshire B.K.A., in connection with the Warwickshire Agricultural Society. Schedules from J. N. Bower, Hon. Sec., Knowle, Warwickshire.

September 16, 17, and 18, at Crystal Palace.—Surrey B.K.A. Annual Exhibition of Bees, Honey, Wax, Appliances, &c. Twenty-seven classes (nine open to all). Many medals and increased prizes. Schedules from F. B. White, Secretary, Marden House, Redhill, Surrey. **Entries close September 1.**

September 22, at Altrincham.—Honey Show, in connection with the Altrincham Agricultural Show, the largest one-day show in the Kingdom. Classes open to United Kingdom. Classes for Trophy of Honey, for Best Hive, Observatory Hive with Bees and Queen, twelve Jars of Extracted Honey. Classes open to County of Chester, for Run and Section Honey, Wax, &c. Special Classes for Cotagers, and Special Classes for Society's District. Good prizes, low entrance fees. Schedules from Mr. J. Herbert Hall, 2, Dunham Road, Altrincham. **Entries close September 4.**

Notices to Correspondents.

A. T. JAMES (Beds).—*Drone-brood Cast Out.*—1. Yes, it is a sign of scarcity, or that the bees have given up the idea of swarming for the present, and if they are prevented from collecting stores, a small quantity of food should be given them at night. 2. It is impossible to say if they will swarm, but with warm weather, plenty of bees, and abundant forage, there is still time for them to do so. 3. Now is the proper time to transfer from skep, but it must be crowded with bees to be successful.

J. FROST (Stoke-on-Trent).—*Drone-brood in Worker-comb.*—1. If the comb is worker a fertile queen will lay worker-eggs, although the cells may have been occupied by drones from a drone-breeding queen. 2. There is incipient foul brood in the comb.

NEIGHBOUR (Hants).—*Dead Swarm.*—The bees appear to have been smothered for some days, as they are quite wet and in a putrid condition.

R. WEBB (Cirencester).—*Ownership of Swarm.*—The swarm is yours so long as you can keep it in sight, and you can reclaim it. If you will refer to page 372 of B.B.J. for September 17, 1908, you will find in the legal opinion on the subject by Mr. E. A. C. Lloyd the following: "The fact that they are temporarily astray and that their owner cannot pursue them without infringing

another's rights by trespassing or the like, will not affect his right of property, and an action would, therefore, lie for their unlawful detention or destruction." In your case trespass would have been justified by the exercise of a legal right to follow the swarm, but of course you would have been liable for any damage done to your neighbour's property.

F. RICHARDSON (Cambs).—*Law with Respect to Bee-keepers*.—You have a perfect right to keep bees so long as they do not become a nuisance. Two hives cannot be deemed either a nuisance or a danger, and we think your neighbour unreasonable in requiring you to get rid of your bees because he got stung on the eyelid. In a Court he would have to prove that it was your bees that had stung him, and that they were a nuisance. With regard to the law on the subject, please refer to page 164 of B.B.J. for April 29 last: "Are We Responsible for Damage or Injury done by our Bees?"

UNEASY (Leeds).—*Bees Suffering from Dysentery*.—If your bees are suffering from dysentery, you have acted quite correctly. From the symptoms it is likely that the bees have been getting stores that have disagreed with them. There is also the danger from the spraying of fruit trees with poisonous compounds, and in some cases from using weed-killers on paths. We cannot guarantee replies to queries appearing in next number of B.B.J. after their receipt, as they have to take their turn, the first reaching us having precedence over later ones. 1. If colonies are strong, and weather as well as other conditions favourable, it is sometimes possible to get 10 lb. to 20 lb. of heather honey in such districts as yours. 2. You can do nothing to prevent bees from storing pollen, which they need for brood-rearing. In the spring, when you examine your colonies, you can remove a frame or two containing it if you find there is too much at that time.

W. J. WARREN (Plymouth).—*Various Questions*.—1. Nails for wiring frames should be No. 18. B.W.G., 1 in. long. 2. Division-boards do not require "W.B.C." ends. 3. Place feeding-stage over hole in quill. 4. 1½ in.; in centre. 5. One. 6. See "The 'W.B.C.' Hive and How to Make It" in "Bee-keepers' Note-book," pages 54 to 59, where all dimensions are given. 7. Do not use comb from secondhand hive; better melt it up, and avoid risk of introducing disease. 8. The B.B.J. was started May 1, 1875, and the new series January 2, 1890. There is an index at the end of every volume, published with the last number in December in each year.

A. H. HANSON (Ilkeston).—*Dividing Hive*.—There would be hardly time to rear the queens and build up three stocks as you propose from seven combs strong enough to go through the winter unless you can strengthen them with driven bees in the autumn.

ANXIOUS (Great Berkhamstead).—*Bees Dying*.—There is nothing in the appearance of the bees to show why they have died. You can only ascertain the cause by observing the general behaviour of the stock. Please refer to particulars of Dr. Malden's report on page 101 of B.B.J., and compare the characteristics with the behaviour of your colony.

G. C. (Oughtybridge).—*Wiring Frames*.—1. Of course frames can be used without wiring, but it is more convenient to work with them when wired, and there is much less chance of their breaking down during manipulation. Wired combs may be held in any position for examination, whereas if not wired they can only be held perpendicularly, otherwise they are liable to fall out of the frame. 2. Artificial swarms are not bound to be a failure unless they are re-

queened, as they will raise a queen, but time is saved by giving them laying queens.

B. C. (Cheadle).—*Wild Bee*.—The bee is *Andrena nitida*.

J. S. (Buckley).—*Queens Cast Out*.—It is not astonishing that there should be so many queens cast out, as you found sixteen queen-cells in the hive. As the bees have not started queen-cells from comb of eggs given to them, probably they already have a queen which should be laying by this time. You should examine hive to make sure.

BEGINNER (Bamford).—*Bees Not Taking to Supers*.—1. The hive is either not strong enough in bees, or the weather has been too cold to allow them to go up into the supers. 2. If your colony is strong enough to look after a double set of combs, this would be a good way of checking swarming and getting bees to work in supers.

R. HANNAM (Wigtownshire).—*Making Artificial Swarm*.—1. Cut out all queen-cells but one ripe one. 2. You can with advantage open the ventilators in hot weather. 3. The turning out of the drones is a sign that the bees are not intending to swarm at present.

ABELLE (Upper Clapton).—*Gentlest and Best Honey-gatherers*.—1. Pure British and British Golden would both suit your purpose and are quiet bees. Pure Italians are good-tempered, but fly too early in the season for most districts. 2. Whitethorn, snowy mespilus, ribes, *Prunus padus*, and *Buddleia globosa* you would find suitable.

W. G. (Starbeck).—*Name of Flower*.—It is *Clematis montana*, and is visited by bees for the pollen, but has little honey value. The colour of the excrement varies according to the colour of the pollen consumed, and is sometimes much drier than at other times. Our bees have worked on the same plant and are none the worse for it.

R. J. LAST (Barton Mills).—*Wasp's Nest*.—What you have found in your empty hive is the commencement of a wasp's nest, with a group of primitive cells surrounded by a layer of paper and part of another.

Honey Samples.

MRS. A. GALE (Essex).—The honey has been gathered principally from bean and fruit blossoms. It is of good consistency, a trifle dark, but light enough to be classed as light honey. Elms yield very little of either pollen or honey.

C. K. SMITH.—The colour and consistency of the sample are both good, and the flavour at first seems like nice clover honey, but the after-taste is rank and not very palatable. This may be caused by an admixture of honey gathered from wild parsley, or it may be that the bottle in which it was sent had contained something which has tainted the honey.

Suspected Combs.

ANXIOUS (Kirriemuir).—We regret to say that the stock must have been affected with foul brood for some time, as the disease is in the spore stage.

S. GREENWOOD.—There is foul brood of old standing in sample of comb.

MRS. M. (Lodoigi) and C. M. (Cathcart).—Comb is badly affected with foul brood.

B. J. (Kirriemuir).—There is no brood in sample of comb sent. If the stock was weak and appeared unhealthy, it would be safer to destroy bees, combs, frames, quilts, &c., instead of hiving a swarm on the combs. The hive also should be thoroughly cleansed and disinfected before being used again, as most probably the bees have been diseased.

Special Prepaid Advertisements.

Twelve words and under, Sixpence; for every additional Three words or under, One Penny.

QUEENS, choice 1909, bred from my non-swarming stocks, 3s. 6d. each, per return.—TAYLOR, "Hollyhurst," Boldmere-road, Wylde Green, Birmingham. r 38

SWARMS.—A few to spare, 3s. lb.—CHARTER, Tattingstone, Ipswich. r 57

BEES FOR SALE AT CHOBHAM, SURREY, 4 Stocks, one in Abbott's prize "W. B. C." hive, one in "Sandringham," and two in Skeps.—Offers to ABBOTT BROS., Southall. r 46

STRONG HEALTHY STOCKS, in good Standard 10-frame Hives, 25s. each.—H. J. NELMES, Cathcart. r 55

DRIVEN BEES, live delivery guaranteed before August 12, 8s. per lot, carriage paid, including new Skep. No Foul Brood whatever in district.—DAVIDSON, The Retreat, Melbury Abbas, Shaftesbury. r 43

STRONG SWARM (MAY), on 8 new Frames, in Taylor's No. 4 Hive, new 1908, guaranteed healthy, 35s. Approval; Deposit.—DAVIDSON, The Retreat, Melbury, Shaftesbury. r 44

SWARMS.—A few at 2s. 6d. per lb.—WAIN, Thorpe Bank, Wainfleet. r 41

BEE-HIVES, Comb Foundation, and Bee-Keeping Appliances can be obtained from S. BRIMLEY, 5, Wellington-street, Bedford. r 40

PURE ITALIAN QUEENS, all tested and selected, 6s. 6d.; select Imported, 4s. 6d.; Italian Nuclei, 15s.—G. THOMAS, Pwllcrochan Rectory, Pembroke. r 98

33RD YEAR.—Nuclei, 3 Frames (wired), Bees, Brood, and Queen, 12s. 6d.; empties, 1s. 9d., or returned carriage paid.—ALSFORD, Expert, Haydon, Sherborne, Dorset. r 54

BOOKS WANTED, Cheshire's "Bees and Bee-keeping," 2 volumes.—JOHN DAVIS, 13, Paternoster-row, London. r 63

WHAT OFFERS FOR CHESHIRE'S "BEES AND BEE-KEEPING," 2 volumes, in very good condition?—BROWN, Vine Cottage, Burton, Christchurch. r 62

3 "W. B. C." HIVES, new, complete, 10s. each, or exchange Bees.—GREEN, Bigg House, Arnold, Notts. r 61

STRONG NATURAL SWARMS, guaranteed healthy, 12s. 6d.; Second Swarms, headed by 1909 Queens, 8s. 6d.; safe delivery.—CADMAN, Codd-sall Wood. r 59

WANTED, by Handy Man, Situation, assist Gardener; understands Bees and making Appliances.—GARDEN, c/o B.B.J. r 58

HIVES.—1 "W. B. C." and 1 "Telescopic" for sale, with fittings, Frames, Supers, &c., cheap, must sell, owner going abroad.—SPENCER, 14, Walton-road, Sheffield. r 48

FOR SALE, "British Bee Journal," 10 volumes, 1899-08, complete, unbound, 12s. 6d. the lot.—HENRY GOW, Waggon-road, Crossford, Dunfermline. r 49

QUEENS.—1 1908 Fertile Black, 2s. 6d.; 1 ditto Italian, 3s.; 4 choice Virgins, 1s. 9d. and 2s. each, hatched June 20.—J. SILVER, Croydon-grove, Croydon. r 53

WANTED, good secondhand Observatory Hive. Cash or exchange appliances.—P. M. RALPH, Settle. r 64

EXCHANGE GOOD "WELLS" HIVE FOR Swarm or Stock in Skep.—RALPH, Settle. r 65

Special Prepaid Advertisements.—Continued.

FOR SALE, GIVING UP.—4 Hives, 2 with stands and zinc roofs, double walls, 19 Shallow Frames, mostly drawn out, 19 Brood Frames, drawn out, 5 Straw Skeps, over 100 metal ends, 4 Exhibition Glass Show Cases, for Shallow Frames, zinc Section Crates and Dividers, Queen Excluder, zinc Super Clearer, dozen Shallow Frames, in flat, Smoker, Feeder, quantity of wax, including Brood Foundation, wire, &c. Lot 45s.—FREEMAN, Franklin-road, King's Norton. r 52

1909 NUCLEI, with "Prolific Black" tested Queens, 3 or 4 S. Bars, 10s. 6d.; 2 1908 Black Queens, on 3 or 4 Shallows, 8s.—"T. c/o B.B.J. r 56

2 STRONG STOCKS, each on 8 Frames, 18s. each. Approval.—HAYES, County Asylum, Winterton, Ferryhill. r 51

STRONG NATURAL SWARMS, 12s. 6d.-13s. 6d., with 1938 Fertile Queen; second ditto, 1909 Queen, 8s. 6d.; Stocks, 10 Standard Frames Comb, 25s.; 3-Frame Nucleus, 11s. 6d.—W. WOODS, Normandy, Guildford. r 45

NUCLEI, 3 or 4 Frames, 12s. 6d. and 14s. 6d.; hardy and prolific Virgins, 2s. 6d. Orders booked.—MERE FARM APIARY, Nether Alderley, Chelford. r 42

SITUATION WANTED in Bee-Management; thoroughly competent handy man, machinery, garden.—Character, particulars, please address, EXPERT, MR. SEBLEY'S, Buckland Newton. r 50

TILLEY'S PATENT "WON'T LEAK" SECTIONS AND REGISTERED DAMP-PROOF HIVES. Particulars post free.—M. H. TILLEY, Bee-Farm, Dorchester. r 60

INCREASE YOUR SURPLUS BY PLANTING BORAGE, strong young plants, 6d. dozen, free.—SELF, Arlington, Mount Pleasant, Norwich. r 47

"W. B. C." HIVES FOR SALE, 10s. 6d. each; also good Extractor and quantity of accessories.—WILLIAMS, "Sunnyside," Wellington-road, Bilston. r 23

FOR SALE, 6 "W. B. C." HIVES, almost new, extra strong, with 2 Lifts, double Floors, zinc covered, and painted, 15s. each.—Apply MR. ROCHE, 40, Wellington-road, Oxtou, Birkenhead. r 20

HIGH-CLASS MICROSCOPE, by well-known maker, 3 objectives, eye-piece, &c., splendid condition, 30s., great bargain.—L. WAKEFIELD, Blackmore, Bromsgrove. r 18

SECTION GLAZING.—Best quality Lace Paper, made especially for Bee-keepers' use, not common box edging, white, 100 6d., 300 1s. 4d., 500 2s. 3d., 1,000 3s. 9d., post free; blue, green, or pink, 100 7d., 300 1s. 6d., 500 2s. 6d.; Lace Bands, 2½in., 3in., and 3½in. wide, white, 100 1s. 2d., 200 2s. 3d., 500 4s.; a few in pink and blue, 100 1s. 4d., 200 2s. 6d.—W. WOODLEY, Beedon, Newbury.

ITALIAN QUEENS DIRECT FROM ITALY, Extensive Apiaries.—E. PENNA, Bologna, Italy. Catalogue free. See advt. in B.B.J. of June 10. r 35

NEW SECTIONS WANTED TO PURCHASE.—T. SMITH AND CO., 17, Cambridge-street, Hyde Park, W. r 34

WANTED, Wax-moths, alive; also large Grubs of same.—HERROD, Apiary, Luton. r 32

WANTED, SWARMS, any number.—Price and particulars to HERROD AND STEWART, Luton. p 68

WANTED, Skeps of Bees.—Price and particulars to HERROD, Apiary, Luton.

SECTIONS WANTED.—State price; must be light and new.—THE HONIELADE CO., 23, Moorfields, E.C. q 72

Editorial, Notices, &c.

ISLE OF WIGHT BEE-DISEASE.

On page 253 we publish the notice sent to us by the Board of Agriculture and Fisheries respecting the outbreak of a disease in some hives in Buckinghamshire similar to that which destroyed so many colonies in the Isle of Wight. We wish, therefore, to call the attention of our readers to a summary of Dr. Malden's report which we published in B.B.J. (page 101) for March 18 last. This disease is very similar to several others, but the chief characteristic features are a more or less rapid mortality amongst the bees, disinclination to work, some distension of the abdomen—which is occasionally absent—frequent dislocation of the wings, and, later, inability to fly. When the bees leave the hive they run about the alighting-board and drop to the ground. Here they crawl about, and ascend blades of grass, and in every attempt to take wing fall to the ground again, and eventually die from exposure. The disease attacks young and old bees, but not the brood. It can only be detected by observing the general condition of the stock. The disease is under investigation by Dr. Malden, and as there is no known remedy anyone noticing the above symptoms should at once communicate with the Board of Agriculture and Fisheries, 4, Whitehall Place, London, S.W. It is impossible to diagnose the disease from the aspect of dead bees, and we mention this because we have had several samples of bees sent to us which have arrived quite dead, frequently in a putrid condition, as decomposition sets in very quickly after bees die.

It appears also from the communication of Mr. Simpson on page 255 that the disease may attack a hive already affected with foul brood, and in such a case means should be adopted to prevent it from spreading to other hives.

On the outbreak of the disease the usual precautions as to disinfection must be taken. A 10 per cent. solution of formalin should be placed in the hive, with two or three balls of naphthaline, just as in the case of foul brood. The ground all round the hives should be watered with carbolic acid solution—1 oz. to two quarts of water—and all dead bees found should be burned. As for May-pest, salt put on the floorboard has been found to arrest that disease; this might be tried. But in every case, when an outbreak occurs, bee-keepers should at once notify the Board of Agriculture.

"ROYAL" SHOW AT GLOUCESTER.

The seventieth annual exhibition of the Royal Agricultural Society of England opened on June 22 in the grand old-fashioned city of Gloucester. The ground selected was one of the best since Park Royal was vacated, being almost perfectly level, while the soil seemed capable of absorbing any amount of wet and so retaining a dry surface. It also had the advantage of being situated close to the city, and admirably served by the trams coming up to its very doors. It was a picturesque spot, with the city just beyond and the fine old cathedral towering above all. The bee-department had a splendid position this year, being placed in good company and surrounded by industries closely allied to it. On the left was the forestry exhibit, which has considerably developed the last few years. Right in front was the educational building, while on the right the horticultural tents formed one of the greatest attractions of the show, and the exhibits were a sight worth travelling many miles to see. The first day was marred by thunderstorms, with torrents of rain and hail falling at intervals; this, no doubt, was the cause of the attendance being the smallest recorded since Park Royal. The second day was the most important, because of the visit of the King, who received a royal welcome both in the city and on the ground, dense crowds lining the entire route traversed by the Royal party. The city was given over to a general holiday and bedecked with bunting, whilst at night it was ablaze with electric illuminations of all colours and designs, even the electric trams being gaily decorated. The attendance again was not so good as at other shows, which no doubt can be accounted for by the wet and cold of the previous day. A little rain fell, but for the most part the day was fine and the sun shone brightly. Thursday was quite as bad as its predecessors, being very cold, with frequent showers. More people attended on that day, and the bee-department received its due share of patronage from the visitors. This part of the show was quite up to its usual standard, and several attractive trophies, with the long rows of honey exhibits, presented a very pretty appearance from the front. Out of an entry of 151 there were but twenty-nine exhibits that did not turn up—very creditable considering the adverse weather experienced during the last few weeks. Friday again proved a disastrous day, rain falling the whole of the time, preventing demonstrations being given. The bee-department was crowded the whole of the day, in spite of the bad weather, and, judging from our conversations with visitors, the district must be well popu-

lated with bee-keepers, as a large number were present.

A novel feature was the bee-house erected by Mr. Burt, of Gloucester, on his own stand outside the honey department. It was a well-constructed and conveniently arranged house, with extracting-room, &c., and was sold during the show. This is the first time a manufacturer has been enterprising enough to put up an exhibit of this description.

Lectures and demonstrations in the bee-tent were given, when the weather permitted, by the B.B.K.A. lecturer, Mr. W. Herrod, when large audiences gathered round, and great interest in the industry was shown by numberless questions being asked the lecturer.

Owing to Mr. E. H. Young's illness, the arrangements for the show were carried out by Mr. Herrod, and Mr. C. L. M. Eales rendered valuable assistance.

Messrs. W. F. Reid, Addestone, Surrey; A. G. Pugh, Beeston, Notts; and S. Jordan, Bishopston, Bristol, acted as judges, their awards being as follow:—

HIVES AND APPLIANCES.

Class 476.—Collection of Hives and Appliances, including Suitable Outfit for a Beginner in Bee-keeping (5 entries).—1st, E. H. Taylor, Welwyn, Herts; 2nd, Mrs. Seadon, "S. J. B. Apiary," Bromley, Kent; 3rd, W. P. Meadows, Syston, Leicester; h.c., Edward Jno. Burt, Stroud Road, Gloucester.

Class 477.—Complete Frame-hive for General Use (11 entries).—1st, Abbott Brothers, Southall, Middlesex; 2nd, James Lee and Son, Ltd., Martineau Road, Highbury, N.; 3rd, E. H. Taylor; h.c., Abbott Brothers; c., James Lee and Son, Ltd., and W. P. Meadows.

Class 478.—Complete Frame-hive for Cottager's Use, price not to exceed 10s. 6d. (5 entries).—1st, W. P. Meadows; 2nd, E. H. Taylor; 3rd, C. Greenhill, Graham Road, Wimbledon; h.c. and c., James Lee and Son, Ltd.

Class 479.—Honey-extractor (6 entries).—1st, W. P. Meadows; 2nd, G. Heseldin, Bramhope, Leeds; 3rd, E. H. Taylor.

Class 480.—Observatory-hive with Bees and Queen (3 entries).—1st, James Pearman, Penny Long Lane, Derby; 2nd, Wm. Dixon, 27, Central Road, Leeds.

Class 481.—Any Appliance connected with Bee-keeping (4 entries).—1st, W. P. Meadows; 2nd, E. H. Taylor.

HONEY.

Entries in Classes 482 to 485 could only be made by residents in Cheshire, Cumberland, Derbyshire, Durham, Herefordshire, Lancashire, Leicestershire, Lincolnshire, Monmouthshire, Northumberland, Nottinghamshire, Rutland, Shropshire, Staffordshire, Warwickshire, Westmorland, Worcestershire, Yorkshire, the Isle of Man, Ireland, Scotland, or Wales.

Class 482.—Twelve 1-lb. Sections (8 entries).—1st, A. W. Weatherhogg, Wiltloughton, Lincoln; 2nd, James Pearman; 3rd, Joseph G. Nicholson, Langwathby, Cumberland; h.c., C. H. Haynes, Hanley Castle, Worcester.

Class 483.—Twelve 1-lb. Jars of Extracted Light-coloured Honey (17 entries).—1st, A. W. Weatherhogg; 2nd, W. J. Cook, Binbrook, near Market Rasen, Lincs; 3rd, Harry W. Seymour, West Street, Alford, Lincs; h.c., J. Boyes and James Pearman; c., E. Church, Masonic Temple, Cardiff, and W. M. T. Gunter, Plashin, Cowbridge, Glamorgan.

Class 484.—Twelve 1-lb. Jars of Extracted Medium or Dark Coloured Honey (7 entries).—1st, Fred Harris, High Ferry, Sibsey, Lincs; 2nd, James Pearman; 3rd, F. W. Frusher, Swiss Apiary, Crowland, Peterborough.

Class 485.—Twelve 1-lb. Jars of Granulated Honey (5 entries).—1st, A. W. Weatherhogg; 2nd, W. J. Cook; 3rd, James Pearman.

Entries in Classes 486 to 489 could only be made by residents in Bedfordshire, Berkshire, Bucks, Cambridgeshire, Cornwall, Devon, Dorset, Essex, Gloucestershire, Hampshire, Herts, Hunts, Isle of Wight, Kent, Middlesex, Norfolk, Northamptonshire, Oxfordshire, Somerset, Suffolk, Surrey, Sussex, or Wiltshire.

Class 486.—Twelve 1-lb. Sections (11 entries).—1st, W. E. E. Charter, Tattingstone, near Ipswich; 2nd, John Toombs, Sunny Bank, Leasington; 3rd, Miss F. E. Barker, Albans Farm, Barnston, Dunmow.

Class 487.—Twelve 1-lb. Jars of Extracted Light-coloured Honey (14 entries).—1st, R. Brown and Son, Flora Apiaries, Somersham, Hunts; 2nd, G. W. Kirby, Knowle, Bristol; 3rd, H. C. Smith, Woodmancote, Cirencester; h.c., S. G. S. Leigh, Broughton, Hants; c., David Hancox, Deddington, Oxon.

Class 488.—Twelve 1-lb. Jars of Extracted Medium or Dark Coloured Honey (8 entries).—1st, Charles Edward Billson, Cranford, near Kettering; 2nd, G. W. Kirby; 3rd, F. J. Old, Piddington, Northampton; h.c., E. C. R. White, Newton Toney, Salisbury.

Class 489.—Twelve 1-lb. Jars of Granulated Honey (8 entries).—1st, Fredk. Coates, Ewen, Cirencester; 2nd, R. Brown and Son; 3rd, E. C. R. White.

Class 490.—Three Shallow Frames of Comb Honey (8 entries).—2nd, Miss F. E. Barker.

Class 491.—Six 1-lb. Jars of Heather Honey (7 entries).—1st, Tom Sleight, Danesmoor, Chesterfield; 2nd, James Pearman; 3rd, M. J. Lamboll, Chiddingfold, Surrey; c., Thos. Walker, Hawshead, North Lanes.

Class 492.—Six 1-lb. Jars of Heather-

mixture Extracted Honey (3 entries).—1st, W. E. Brooking, Kingsbridge, Devon; 2nd, Wm. Dixon; 3rd, James Pearman.

Class 493.—*Honey Trophy* (4 entries).—1st, Wm. Dixon; 2nd, James Pearman; 3rd and h.c., R. Brown and Son.

MISCELLANEOUS.

Class 494.—*Beeswax (not less than 2 lb.)* (6 entries).—1st, E. C. R. White; 2nd, R. Brown and Son; 3rd, W. Patchett, Cabourne, Lincs; h.c., John Toombs; c., F. W. Frusher.

Class 495.—*Beeswax (not less than 3 lb., in Shape, Quality, and Package Suitable for the Retail Trade)* (5 entries).—1st, E. C. R. White; 2nd, James Pearman; 3rd, F. W. Frusher; c., W. E. E. Charter.

Class 496.—*Honey Vinegar (1 quart)* (4 entries).—1st, H. M. Brown, Wood Street, Shrewsbury; 2nd, G. W. Kirby; 3rd, James Pearman.

Class 497.—*Mead (1 quart)* (3 entries).—1st, W. H. Pretty, Shirehampton, near Bristol; 2nd, James Pearman; 3rd, R. Brown and Son.

Class 498.—*Exhibit of a Practical or Interesting Nature Connected with Bee-culture* (1 entry).—1st, Wm. Dixon.

BOARD OF AGRICULTURE AND FISHERIES.

The Board of Agriculture and Fisheries desire to warn all bee-keepers that an outbreak of disease, believed to be identical with the Isle of Wight bee-disease, has occurred in several hives in Buckinghamshire. This disease, which has destroyed almost all the bees in the island from which it takes its name, is due to a bacillus closely resembling the bacillus of plague, and no remedy for it is known. It is of the utmost importance, therefore, that bee-keepers should take every precaution to prevent the disease spreading, and they are strongly advised to keep a careful watch for any signs of its appearance. A full description of the disease was published in the *Journal of the Board of Agriculture* for February, 1909, and bee-keepers who find symptoms of disease corresponding to the description there given should communicate with the Board of Agriculture and Fisheries, 4, Whitehall Place, London, S.W.

W. B. CARR MEMORIAL FUND.

Amount already acknowledged	£	s.	d.
.....	48	19	0
"One who Remembers his Kindness and Courtesy"	0	5	0
Rev. W. R. Nightingale ...	0	3	0
W. Dixon, Leeds.....	0	2	6
F. E. Matthews.....	0	2	0
W. F. Wiemann.....	0	2	0
	£49	13	6

Correspondence.

The Editor does not hold himself responsible for the opinions expressed by correspondents. No notice will be taken of anonymous communications, and correspondents are requested to write on one side of the paper only, and give their real names and addresses, not necessarily for publication, but as a guarantee of good faith. Illustrations should be drawn on separate pieces of paper. We do not undertake to return rejected communications.

AMONG THE BEES.

SOME SUMMER HONEY-DRINKS.

[7510.] 1. Take six gallons of water, 10 lb. of honey, and the whites of three eggs. Boil one hour, and then add some cinnamon and ginger. When cold, add a spoonful of yeast. Stir the compound well, and put aside for a day or two, when it will be ready for use. 2. Proceed as in making ordinary lemonade, but use honey instead of sugar. The flavour will be much improved and the effect very refreshing. 3. Into twelve quarts of water squeeze the juice of a dozen lemons; add 2 lb. of heather-honey or other honey with a strong flavour, keep the drink in a cool place and a cool vessel until required. 4. Take one spoonful of fruit juice and one spoonful of honey in half a glass of water, place in as much soda as will rise with forefinger and thumb, and add nearly the same of tartaric acid, stir the compound, and drink at once. 5. In a small pamphlet lately published on "Honey and Health" honey-tea is strongly recommended. In a breakfast-cup nearly full of freshly-boiled water dissolve a large table-spoonful of extracted honey. Sip this as hot as possible three or four times a day an hour before meals. 6. Put two table-spoonfuls of oatmeal (rice or barley may be substituted) in a quart jug, nearly filled with freshly-boiled water, and cover up for twenty-four hours; then strain into another jug, into which place about three table-spoonfuls of honey, preferably heather-honey, and add the juice of two lemons.

"Back to the Land."—This cry is heard at present in every part of our country, and all who have the well-being of the nation sincerely at heart will support the sentiment it expresses. Whether Whig or Tory, all will agree that the nation's backbone is the small holder of land. When the dream of many patriots is fully realised by these holdings being dotted all over the country, our industry will receive an impetus greater than it has ever obtained in the past, because of all the small cultures none deserves more attention than apiculture. Here and there signs of advancement are apparent. Leading newspapers are always eager to record every item of interest in

connection with the craft, many devote special columns to bee-keeping, honey shows are becoming more common, and exhibits are welcomed at horticultural and many agricultural exhibitions. At present, in sympathy with the trend of public opinion, the authorities at the Aberdeen Agricultural College have determined to include bee-keeping in their new prospectus. The Highland and Agricultural Society, of old a sincere and active friend of apiculture, but which had dropped it for a long term of years, has included an article in its "Transactions." Personally, if the importance of the subject can be gauged by so small a sign, I have never hitherto had a tithe of the correspondence on the subject which now reaches me.

A Handy Tool.—A neighbouring bee-keeper has invented a handy little tool which in future will be an indispensable article with me in my spring cleaning. It is simply a small garden draw-hoe, with a perfectly straight edge well sharpened, so that any bee-keeper may make one for his own use. The shaft is only about 4 in. in length, and if the tool is grasped pretty well down it clears the top of three frames with a single sweep. As I leave on all brace-combs for winter passages this is a boon when cleaning up, as with about three strokes the whole of the frame-tops are cleared and ready for replacing the quilt. Previously I had used a scraper pushed ahead or a large knife; but both of these had a bad habit of digging into the wood of the frame and leaving rude gashes. The new scraper is a model in this respect and never misbehaves. Some might try it and report. Dr. Miller advised the use of an axe in cleaning up floorboards. Hitherto I have toiled with an old knife to clear off the rough and then moided away with a piece of broken glass held edgewise, being gratified when after an infinite amount of labour I left the floor clean as a newly-planed board. The new appliance, after very few cross sweeps, leaves it as clean, with a tithe of the labour, and the time taken is a cipher compared with the old appliances. Old bee-keepers might supply us with many similar useful hints.

The Season up to Date.—I might sum up the whole matter by saying that apiculturally we are only now, at the end of June, just about where we should be in the closing days of May, even in an average season. A correspondent living in a favoured spot in a neighbouring county writes to-day: "Isn't the weather atrocious? I don't think the wind has been out of the north or east for twenty-four hours on end all this month. In my records for ten years I

can't find such a spell of adverse wind and weather. Even June, 1907, though bad, showed a higher temperature. Bees have a struggle to sustain life, and it is only by the assistance of the feeder that they continue to exist. I have boiled a lot of sugar this spring, and weak stocks are the rule notwithstanding. Some of the hives were killing drones recently, and those marked 'Plenty' for stores when making the spring examination were found the other day reduced to the starvation point." This is exactly the condition of my own hives, and I fed every one of them to-day (the 26th) with a pound of sugar, and will repeat on Monday unless the weather improves, merely to keep them alive. Apparently the season is late generally in other places too. English swarms came to hand about three weeks behind expectations, simply, I learn, on account of adverse weather conditions. From Marengo, Northern U.S., we hear: "Not for many years has there been a spring with so few flying days." From Canada comes an account of "a backward spring with a vengeance." Of even sunny Texas we learn of colonies dying of starvation, and also of a new trouble, "a scarcity of pollen" even in April.

Pollen-bearing plants were very late in blooming here. According to Mr. Soal and the books, hazel should flower in February and willows in March. This year the first had a grand wealth of pollen in late April, and the latter are only now blooming. So it will be seen that matters are somewhat out of joint. Still, there is no occasion for getting down-hearted, because frequently a late season is a bountiful one, and, weather improving now and continuing favourable for a long spell, we may yet have an excellent honey-season.—D. M. M., Banff.

MID PIKE AND FELL.

[7511.] My wanderings "Mid Pike and Fell" are over—wanderings which have been happy in that I have been among scenes of Nature such as before I had only read and dreamed of. Arriving when scarcely awakened from her winter sleep, in her renewed youth petulant, uncertain if to weep or smile, she gradually unfolded her loveliness, beautiful and so welcome after its absence. Now that she is donning her brightest and gayest garb of early maturity it is sad to leave her.

Yes, to leave this land overflowing with milk and honey. Travelling moisture-laden across the Atlantic, the heavy clouds cannot mount o'er the lofty Penines until they have somewhat lightened their burden. Discharging this into the

fertile valleys below, rich with alluvial mould—deposited ages ago what time the glacial flood crushed over the land—spring flowers abound in profusion, and the glittering rills, coursing down the gills or woody valleys, which link the mountain and the plain, water the spreading roots of the whitethorn and the wild cherry, the sycamore, hawthorn, the chestnut, and the lime. Each in its turn contributes nectar to its little visitors, asking for, and receiving as its reward, that fertilisation by the interchange of pollen which Nature needs for the fruition of her harvests.

But the honey yield does not cease with the clover. A very short rest, and moor and mountain don a purple mantle—and such a purple! Not yet has artist been born who could transfer that glorious imperial colour to his canvas. Magnificent when the full glare of the midday sun shines, yet tell me, if you can, of a more reposing view than when that same sun is westering to its rest, and its slanting rays slowly sink out of sight one by one, while the changing shadows creep from crag to crag as they loom up out of the dale into the deep softness of the autumn night.

Therefore from early April until September there is food that the bees may find, though as yet in many cases modern bee-keeping has its way to make. The skep which their fathers and their grandfathers used before is good enough for the villagers, and where an attempt to create bar-framed hives has been made fearful and wonderful is the workmanship; an expert is a *rara avis*. Yet when the advantages of new systems and newer knowledge are shown, none are more quick than your Westmorlander to appreciate. Burly and strong of frame, he has a keen wit and a good heart. Saxon and Danish and Norman invaders have each left traces in his dialect, but when studied it is found to contain pithy, strong words forcibly expressing the thought.

Widely scattered, it takes much time to visit the villages. Yet, apart from the bee-cult, they are singularly interesting, often clustered round an ancient church, whose round arches and squat towers tell the tale of the time when their pious founders—Norman, Saxon, or even Briton—had to hold them as a fort against raiding Scot or sacrilegious Dane. Old yew-trees, gnarled and knotted, twisted and cracked, grow in God's acre, seemingly as if a thousand winters had passed over them. Not without purpose or for sentiment only were they planted here. Of these men made the bows which smote, though unsuccessfully, the invaders' ranks at Hastings and scattered the chivalry of France at Crecy, Poitiers, and Agincourt. On the stone pillars of the porch

yet are shown the deep grooves where the archers pointed their arrows.

Such length of shafts, such mighty bows,
So huge that many simply thought
But for a vaunt such weapons wrought,
And little deemed their force to feel
Through links of mail and plates of steel,
When, rattling upon Flodden vale,
The cloth-yard arrows fell like hail.

Westmorland and Kendal archers, according to a Scotch proverb, carried twenty-four lives in their belt, so unerring was their aim.

To get into the good graces of the vicar of the church was to command success in that village. Often bee-keepers, always deeply interested in bee-chat, I have pleasant recollections of my visits. Seldom is an expert graduated in ecclesiastical law; yet one of these good ministers submitted a somewhat serious question to me, to wit: A swarm had established themselves in the roof of his church, over the chancel, and had become very strong. He fain would have them removed, but had conscientious scruples. "For," said he, "they have taken sanctuary." But my argument, in reply, was: "The law of sanctuary availeth only within the church—*ad aram ipsam*, at the altar itself. So say the doctors of canon law, and therefore they are still outlaws, and may be expelled. *Vi et armis*, which may be translated by smoke and carbolic acid." Is my interpretation right? I have strong hopes of the verdict.—J. SMALLWOOD, Hendon.

ISLE OF WIGHT BEE-DISEASE.

[7512.] I send a few bees herewith which are from the pathway in front of two diseased hives. The disease these stocks are suffering from is somewhat similar to the I.O.W. disease, but also resembles foul brood in that the larvæ are affected, while in the former I believe only the adult bees suffer. It appears to me that it is likely to be a far more infectious disease than common foul brood, as the affected young bees crawl about yards away from the hives, and when rising, as most of these do, are as likely to enter the wrong hive as not, and so carry the disease there. There are no swollen bees amongst them. During the warmer part of the day the flight-boards have been covered with them, as though they were crowded out and ready to swarm. Some fly a few yards and then drop, others simply drop off the flight-board. Neither hive has been fed this season, but both have always managed to keep a little sealed stores, although neither had a great stock to begin with. I have seen many hundreds of ordinary foul and black brood cases, a few of pickled brood, and a large apiary attacked by an ex-

actly similar disease to the I.O.W. one, but none like this before.—A SIMPSON, Chalfont St. Giles.

[The bees arrived in a putrid condition and smelt horribly, but there was nothing to show cause of death. It is quite possible that bees may suffer from two diseases at the same time, which rather complicates matters, and unless colonies are very strong and the disease not far advanced the safest plan is to destroy bees, combs, and frames, for in doing so the spores, which are always a source of danger, are destroyed. See also editorial on page 251.—ED.]

ARTIFICIAL HONEY.

[7513.] Your article on the subject of the "Glucose Canard" reminds me of two separate occasions on which I had somewhat heated arguments about it. The first was with an Englishman—a regular Mr. Knowall, noted for his bombastic talk on all subjects. Soon after I commenced bee-keeping he told me I was working on quite wrong principles—that all the big bee-keepers kept their hives closed with perforated zinc, so as to confine the bees, while they fed them with syrup inside the hive. Thus there was no waste of bee-life, and the bees stored the syrup in vast quantities. Unfortunately, he knew I was a beginner, so that no amount of argument on my part would convince him of his error. Later on, however, I took my revenge by offering, in the presence of others, to pay him £1 for every bee that survived a year of such treatment if he, on his part, would pay me £1 if his experiment failed. In fact, I thoroughly held him up to ridicule before others!

The second occasion was later on in my apicultural career, the speaker being a very clever foreign politician. This gentleman began talking, in front of a large audience, of the strides apiculture had made in the last half-century, informing the company that bee-keepers now make their own combs (fully drawn-out), which they present to the bees to be filled with honey. I must confess that I felt somewhat diffident about arguing with a man of such well-known intelligence; but as I had, a few days previously, assisted a neighbour with some details of apicultural work, in which this gentleman had been keenly interested, I took heart of grace and entered the lists, telling him he had been misinformed. Whereupon he stated that a friend of his had told him that he had seen these combs manufactured. I then explained the principles of the manufacture of foundation, and informed him that any bee-keeper would willingly pay a very large sum for the secret of making arti-

ficially drawn-out combs, being careful to explain to him how they would benefit by such knowledge. I am glad to say he took my correction in very good part, saying he knew nothing of bee-keeping, whereas he knew that I did. And he further promised to bring up my arguments if he ever heard this *canard* under discussion in future.

My advice to bee-keepers is to do as I did. The spreaders of these *canards* resolve themselves into two classes—ignorant and bombastic individuals that love the sound of their own voices and intelligent persons that have been misinformed. The first should be treated to merciless ridicule before witnesses, while the second should be reasoned with gently with a view to making them champions of the truth.—COOKHAM, June 24.

[Two attempts, to our knowledge, have been made to invent machinery for making artificial drawn-out comb. One specimen of such comb was sent to the B.B.J. office over ten years ago by the inventor, a German. Another method was tried a year or two ago by a Mr. Smith, of Cardiff; but both attempts ended in failure. The first specimen referred to was too thick and heavy, and a great quantity of wax must have been used in the making. We did not see any of Mr. Smith's manufacture.—ED.]

SOUTH AFRICAN B.K.A.

[7514.] I read in the BRITISH BEE JOURNAL of June 17 (page 231) an account of the meeting of the Council of the B.B.K.A., and fear that I did not make myself clear as to the position of the S.A.B.K.A. I will now try to explain how things stand, and beg you to put in a correction in your next issue. The association was first started in South Africa under the name of the Transvaal Bee-keepers' Association. After it was firmly established the committee decided to ask the other colonies (Cape Colony, the Orange River Colony, and Natal) to join them and have one society for the whole country. This was agreed upon; and the name "South African Bee-keepers' Association" given to the united body, our object being unity and co-operation. It was the South African Bee-keepers' Association that I represented, and in your report the mistake is in saying "with the exception of the Transvaal," which is really the originator of the co-operation.—M. DAGMAR SILLAR, Representative S.A.B.K.A., June 25.

PRICES OF FOREIGN HONEY.

[7515.] I often see in your valuable paper returns of the importation of foreign honey. Would it be possible to

find out what prices are obtained for it in the different countries? I have been told that foreign honey has been sold for as low a price as 1½d. per lb. During the late war in South Africa I paid £1 for a small jar of Jamaica honey. The next day I was fortunate in finding a wild bees' nest. I ate it all—wax, honey, pollen, and dirt. I do not think there was any brood, but if there was I was too hungry to notice it.—THOMAS A. BAKER, Hoole.

[In some countries even 1½d. is not obtained, but good-quality honey fetches from 2d. to 2½d. a lb. In California the best honey sells for 2½d. a lb. wholesale.—Ed.]

BEE-NOTES FROM HERTS.

[7516.] I have been promising myself the luxury of a long letter to you for a great while, particularly as I do not see many "notes" from this part of the country.

"Bees do nothing invariably." What a good old truism this is! I have experienced it this year to the full.

Perhaps you remember my suffragette bees (see B.B.J., page 79, 3887), who would not stay at home and take care of the babies? (By the way, it was not mice, or anything else that I could discover.) They have given me more trouble than all the rest of my stocks put together.

They commenced their antics by sending out a 4¼-lb. swarm on Sunday, April 18 (no mistake in date, as I noted it at the time). Thickest part of a hawthorn hedge, of course, was where they elected to settle, and it took me nearly two hours to get them into a skep.

So far, so good; but that was only a beginning. I hived them on seven frames (foundation), covered them up warmly, gave them a feeding-bottle, and left them.

Well, to cut a long yarn short, they drew out four frames, the queen filled two with eggs, and then out they came again and proceeded to fly about the apiary, eventually settling and clustering under the floorboard of their own hive, which they had just left!

I smoked them out, got them into a skep again, put them back in the hive, killed the queen, and gave them a new one twenty-four hours later (obtained from a skep I have), and then took away the two combs of eggs and gave them to another stock to hatch.

I then (or rather a fortnight later) killed the young queen in the hive they swarmed from, and gave them another queen also.

Now if for any weird reason they go through the same performance, well, they

can go, and I wish the man who finds them joy of them.

On Sunday, June 13, four of my stocks swarmed together, and I hived 15½ lb. weight of bees! I should very much like to know if this is a record; they have crammed full (besides the brood-chamber) three racks of shallow frames and one section-rack. I should like to give them another super, but I dare not, as the winds here are keen.

Before I close I should like to ask a question or two. 1. Has a swarm ever been known to send out a swarm? This sounds a bit involved, but you know what I mean. 2. Can two swarms be joined when hived if they issue on the same day from hives three or four miles apart? Of course, one queen would be removed.

I have a lot more to talk about, but I think that this is enough for once. Everything points to it being a grand year. I have rarely seen stocks so strong in spring.—ROYAL NAVY, Herts.

[1. This, though not common, is by no means a rare occurrence. Such swarms are usually called *maiden swarms*. 2. Yes, see instructions on page 107 of Guide Book.—Ed.]

CAPPINGS OF COMB.

BY L. S. CRAWSHAW, NORTON, MALTON.

Dual-queen System (page 204).—“J. M. E.” utters a warning as to swarming, but one of the claims made by the advocates of this system has been that it prevents, or at least modifies, swarming. For myself, I am not yet able to say anything definite, but those who are trying the scheme might report the effect upon this characteristic.

Early Honey (page 205).—Mr. Salmon refers to chestnut honey. Is this from the catkins of the Spanish chestnut? He uses the plural to include, presumably, the horse-chestnut also, but here in the North I have not seen the bees at work upon the latter—for honey, that is to say. I think they generally get some propolis from this tree. Turnip honey is, I suppose, from turnip grown for seed.

New Cure for Robbing (page 206).—We are advised here to give the hive a good free kick, when out come the defenders. On the look-out for the free-booter, of course!

The Black Bee (page 211).—If this bee has degenerated, why has not the Italian race done so to the same extent? Were the Italian methods better than our own, or has so much been accomplished of late years in the matter of selection? I am very glad to subscribe to M. Bertrand's belief in native bees, and I think that we shall yet see a reaction in favour of our own race. There is no reason why its

devotees should not all proceed upon selective lines.

The Controlling Force (page 213).—Does the queen lead a swarm? It is quite evident that she must choose one of the many incipient resting-places, and if she be a virgin the extra distance travelled must be due either to her greater wing-power or to her wandering proclivity.

A Promising Outlook (page 214).—It is cheering to hear these good reports, but the beginner may well be warned that some of the honey is likely to be honey-dew, for this source has been in full flow this year. The rains have put a stop to it, but sections may be spoiled. It would be well to examine them now. The clover is just opening, and it would be a pity to allow this unsatisfactory blend.

A Novel Bee-hive (page 214).—Of course, this iron crock would cast a strong swarm, as from its nature one would expect it to be boiling over with bees! This good photograph would, I think, be even better without the modern roof in the foreground and the sapling in the rear, both of which catch the eye and detract from the lighting of the real object of interest.

Harness Blacking (page 223).—One well-known bee-keeper says that he disposed of a crop of spoiled honey, containing honey-dew, to a firm of blacking makers. This is worth remembering in the event of similar disaster requiring to be retrieved. Personally I am quite satisfied to rear brood on the substance. I have never been able to see that the bees were any worse than those reared on the best of show honey!

Identifying Swarms (page 225).—Thank you, Colonel Walker, for the useful and timely reminder. I have had a swarm today, the 28th, and a cursory examination of the whole apiary has quite failed to identify the source. This examination consisted of turning up the hives and exposing the bottom bars to look for queen-cells and judge of the population. So to-night I go down armed with the flour-dredger to label the stragglers, and to watch them come home wagging their tails behind them. I must remember not to take the salt-box by mistake.

Vagaries of Swarms (page 226).—Now that is something like a runaway swarm! But, of course, the bees had heard of their destination in the garden discussion, and had evidently approved of their prospective owner. Sellers of driven bees would find it invaluable to re-queen their stocks from this strain! "At the word of command"—HOME!

Isle of Wight Results (page 234).—The superiority of these driven lots is probably not inherent, but most likely due to their

possession of younger queens than the previous swarm-queens. This would in turn be due to the careful choice made by the donors. I should have liked to draw "D. M. M.'s" august attention to this unexpected evidence in favour of driven bees, but I cannot help thinking that this is the true explanation.

Loss of Swarms (page 235).—The loss of so many swarms by one bee-keeper suggests that there must be something abnormal, and that it might pay him to buy a few inches of excluder for each hive to make sure of swarms once they are hived.

TRADE CATALOGUES RECEIVED.

F. W. L. SLADEN (*Ripple Court Apiary, near Dover*).—This is a beautifully got-up and comprehensive catalogue of bees, queen-bees, and queen-rearing appliances. Mr. Sladen has since 1892 been breeding bees by selection for honey-gathering under specially favourable conditions, and has succeeded in producing certain strains noted for their good qualities, and which he has named "British Golden" bees. Besides these, Mr. Sladen supplies queens of foreign races. The appliances connected with queen-rearing are those which he has found best suited to conditions in this country. He also supplies complete outfits for queen-rearing. The catalogue is unique of its kind, and should be of interest to all bee-keepers.

JUNICHI NONOGAKI (*Nonogaki Apiary, Oku-cho, Owari, Japan*) sends a list of Japanese queens which he is ready to supply at prices from 3½ yen to 8 yen (7s. to 16s.) post free. Mr. Nonogaki gives the following quaint description of them: "Japanese bees are yellow dark. Their action, flying swiftly, are very pleasant. Their nature are very gentle, and seldom attempt to sting, so that you need neither bee-veils or bee-smokers. Their comb are very suitable for comb-honey, because its wall is extremely thin and colour is snowy white."

Mr. Nonogaki is also the editor of the *Hoho Kai* (The Bee-culture World), a monthly periodical devoted to bee-keeping. The copy before us contains fourteen pages, and is printed in Japanese.

Bee Shows to Come.

July 15 and 16, at Louth.—Show of Honey, Hives, and Bee-appliances in connection with the Lincs Agricultural Society. **Entries closed.**

July 21 and 22, at Cardiff.—Glamorgan B.K.A., in connection with the Cardiff and County Horticultural Society's Coming-of-Age Show. Members', Novices', and Open Classes. Record Schedule from W. J. Wiltshire, Maindy Schools, Cardiff. Judge, W. F. Reid, Esq., F.I.C., F.C.S. **Entries close July 18.**

July 21 and 22, at Tamworth.—Staffs B.K. Association Annual Exhibition, Honey, &c. **Entries closed.**

August 2 (Bank Holiday), at Clewer, Windsor.—Show of Honey and Appliances by the Windsor Branch, Berks B.K.A., in conjunction with the Clewer Horticultural Society. Schedules from Hon. Sec., Mrs. W. S. Darby, 1, Consort Villas, Clewer, Berks. **Entries close July 28.**

August 4 and 5, at Abingdon Park, Northampton.—Honey Show of the Northants B.K.A. Special prizes for open classes, including one for single 1-lb. jar honey. (Entry free.) Judge, Mr. W. Herrod. Prizes 20s., 10s., 7s. 6d., and 2s. 6d. Schedules from R. Hefford, Hon. Sec., Kingshorpe, Northants. **Entries close July 28.**

August 5, at Madresfield, Malvern.—Annual show of the Worcestershire B.K.A. Open class for collection of Bee-products. Prizes 20s. and 10s. Schedules from Mr. George Richings, 2, Shrubbery Terrace, Worcester. **Entries close July 31.**

August 10 to 12, at Beverley.—Show of Honey, &c., in connection with the Royal Yorkshire Agricultural Society. Schedules and form of entry from John Maughan, Secretary, Blake Street, York. **Entries close July 3.**

August 18, at Lancaster.—Lancaster Agricultural Society, in conjunction with the Lancashire B.K.A. Fifteen Classes for Honey and Bee-produce; also for Bee-hives. Numerous special prizes, including two silver challenge cups, twelve silver and bronze medals, &c. In applying, state Honey Schedule required. Thos. Armitstead and Son, Secretaries, Lancaster; or J. M. Bold, Almonds Green, West Derby, Hon. Sec. Lancs B.K.A. **Entries close August 4.**

August 18 and 19, at Shrewsbury.—Annual Show of the Shropshire B.K.A., in connection with the Shropshire Horticultural Society's Great Floral Fête in The Quarry. Nine Open Classes for Honey and Wax. Schedules from S. Cartwright, Shawbury, Shrewsbury, Hon. Sec. **Entries close August 6.**

August 25 and 26, at Stratford-on-Avon.—Annual Show of the Warwickshire B.K.A., in connection with the Warwickshire Agricultural Society. Schedules from J. N. Bower, Hon. Sec., Knowle, Warwickshire.

September 16, at Castle Douglas.—In connection with Dairy Produce Show, the annual show of the South of Scotland Bee-keepers' Association. Open Classes for three 1-lb. Jars (20s., 10s., and 5s.); three Sections (20s., 10s., and 5s.); entry, 2s. One Jar (5s., 3s., and 2s.); one Section (5s., 3s., and 2s.); entry free, but exhibits forfeited unless otherwise arranged. Beeswax (5s., 3s., and 2s.); entry 6d. Thirteen Classes Confined to Members. Numerous prizes, including two Challenge Cups and gold and silver medals. Schedules from Q. Aird, Hardgate School House, Dalbeattie, N.B. **Entries close September 4.**

September 16, 17, and 18, at Crystal Palace.—Surrey B.K.A. Annual Exhibition of Bees, Honey, Wax, Appliances, &c. Twenty-seven classes (nine open to all). Many medals and increased prizes. Schedules from F. B. White, Secretary, Marden House, Redhill, Surrey. **Entries close September 1.**

September 22, at Altrincham.—Honey Show, in connection with the Altrincham Agricultural Show, the largest one-day show in the Kingdom. Classes open to United Kingdom. Classes for Trophy of Honey, for Best Hive, Observatory Hive with Bees and Queen, twelve Jars of Extracted Honey. Classes open to County of Chester, for Run and Section Honey, Wax, &c. Special Classes for Cottagers, and Special Classes for Society's District. Good prizes, low entrance fees. Schedules from Mr. J. Herbert Hall, 2, Dunham Road, Altrincham. **Entries close September 4.**

Notices to Correspondents.

FORESTER (Coleford).—*Swarm Developing Foul Brood.*—1. If the old combs came from a hive that had been affected with foul brood, it is quite likely that they are the cause of it breaking out in the swarm put on them. 2. Only if the combs are from healthy colonies can they be used again, but we should in any case disinfect them and melt up those containing honey.

3. The honey in super would not be safe unless it were boiled for some time. Combs, frames, and quilts should be burnt and hives disinfected if you wish to prevent the disease from spreading, and follow carefully the instructions in "Guide Book," page 180. 4. It does not necessarily follow that the queen is diseased, although occasionally a queen has been found so. It would certainly be safer to give a new queen. 5. Yes; see "Guide Book," page 180. 6. Colonies having foul brood in an advanced stage are not usually strong enough to swarm, although they may do so when foul brood is in an incipient stage, and in such a case it would not be right to sell the swarm. It would be safe after it had been starved for forty-eight hours.

G. FARON (Gloucestershire).—*Chloride of Lime and Foul Brood.*—We have already written to the editor of *L'Apiculture Nouvelle* to find out from his correspondent what is known about this substance as a remedy. The article was a short one, and the translation of the whole of the description of the treatment was given in the paragraph on page 171 of B.B.J. for May 6. We should certainly expect chloride of lime to affect the honey in supers if used while they were on. As soon as we find out anything further with respect to it you may be sure we shall not fail to make it known.

A BEE-KEEPER (Settle).—*Pigeons Picking Seeds in Garden.*—We are sorry we are not able to give you the law on this subject, but should think you would have no right to shoot them, and would have to sue your neighbour for damages if they proved a nuisance.

MORLEY PETTIT (Ontario).—*Claustral Hire.*—A detailed description of above appeared in B.B.J. for February 23, 1905.

G. R. D. (Four Marks).—*Bee-parasites.*—The parasite on bee enclosed is the *Braula cœca*, or blind louse. We do not think that their presence, even in such large numbers, caused the death of the bees, as, though irritating, they do not seem to do any great harm. They usually die off in this cold climate in winter. Fumigate the hive with tobacco to dislodge the parasites, and they will fall upon floorboard, when they can be brushed off. The latter should be then washed with phenyle or carbolic solution.

IGNORAMUS (Billericay).—The insect is a *Braula cœca* (blind louse). See answer to "G. R. D."

E. H. C. (Codsall).—*Combs Broken Down.*—1. As the combs that have broken down contain only honey, if you cannot conveniently remove them, your best way will be to transfer the five good frames of brood-combs to another hive, and get as many bees as possible off the broken combs with smoke. You can then take them out piece by piece, brushing off any adhering bees with a feather. Fill up the new hive with frames of comb-foundation, and get the remaining bees into it. 2. The proper temperature for boiling sugar for candy is 235 deg. Fahr.

C. E. L. (Somerton).—*Names of Flowers.*—1. French honeysuckle; it is also called Maltese clover, red satin flower, and Soola clover (*Hedysarum coronarium*). 2. Field scabious, or clod weed, Egyptian rose, gipsies' rose (*Scabiosa arvensis*). 3. Bugloss, common vipers' bugloss, vipers' grass (*Echium vulgare*). All three are good bee-plants, yielding nectar plentifully.

W. C. (Kirkstead).—*Transferring Bees.*—You should have hived the bees in frame-hive on the same day that they swarmed. The combs in skeps containing the swarms of one week and three weeks old will be too brittle to permit you to drive the bees, as they would most likely break down when the skeps were turned up. Leave the three-weeks-old swarm until the end

of the season, when you can drive the bees and put them into your frame-hive, provided with frames of comb or foundation. You can do the same with the others if they have by that time filled their hives, otherwise it would be better to leave them until the spring, and let them transfer themselves in the usual way.

BUNNY (Plymouth).—Foundation Breaking Down.

—1. Yes; you have done quite right. The attached frames can be removed when the brood has hatched, and the bees cleared off it by shaking or brushing them off the combs (see page 102 of "Guide Book"). 2. It is quite a matter of fancy, but we should prefer the "W.B.C." hive, which for wintering can be packed with warm material between the body-box and outer case.

J. E. J. (Bristol).—Hive Accommodation.—One shilling per hive is the usual charge.

Broom (Beds).—Honey Granulating.—Honey from turnip, mustard, and charlock granulates very rapidly. Nothing can be done when it is in sections; but extracted honey can be liquefied (see page 90 of "Guide Book").

G. W. G. (Ilford).—Vicious Bees.—As your neighbours are complaining, you are doing quite right in introducing a Carniolan queen as a remedy. You could do as you propose by taking certain precautions, but we should prefer not taking the risk, and introducing queen by one of the methods described in "Guide Book."

J. S. (Croydon).—Name of Flower.—The flower is either a *crepis* or *hieracium* (one of the hawk-weeds), but it is impossible to say which from the dry and imperfect specimen sent. To name flowers belonging to such an extensive family it is absolutely necessary to have them perfect and accompanied by their leaves.

WEST HERTS.—Bees Refusing to Work in Supers.—

1. It is very difficult to prevent bees from swarming when they have once made up their minds to do so, especially if supers are not put on in advance of their requirements. In your case it is evident that the bees required a new queen, and as the old one left with the swarm this in turn is preparing to supersede her. 2. If the bees in old stock are behaving as described under "May pest," it will probably disappear, as this malady is due to improper food. The stock should, however, be watched, and if the mortality continues put some common salt on the floorboard, as this has been mentioned as beneficial in such cases.

H. J. P. (Colchester).—Granulated Honey in Sections.—The heat of the hive is not sufficient to reliquefy honey that has granulated in sections. If you uncup these as advised the bees will probably carry out all the granules, and only utilise the liquid portion. Your best plan would be to cut out the comb and put it into a tin, surrounded by hot water at a temperature of 150 to 160 deg. Fahr. The honey and comb will melt, and when cool the wax-cake can be removed from the surface.

OKAFIELD (Portadown, Ireland).—Transferring Bees to New Hive.—As the frames in new hive are not the same size as those in the old one, you would have to cut out the combs and fit them into the new frames. Take out one frame at a time containing brood, brush the bees back into the hive, then cut out the comb and tie it with tapes into the new frame. After doing a couple of frames shake in the bees from the other combs as you take them out, and proceed fitting all the brood-combs in the same way. When they have all been transferred place them in centre of hive, and fill up on either side with frames of comb-foundation, and put in the remainder of the bees. It is not worth troubling with combs containing honey, as these could be extracted. In a couple of days, if the bees have not already removed them, the tapes can be cut

and drawn out, when it will be found that the combs have been securely fastened. If the combs do not reach the top by $\frac{1}{2}$ in., let them rest on the bottom bar, and the bees will build upwards and secure them to the top.

Suspected Combs.

R. G. A. (Aberdeen).—Both samples of comb are affected with foul brood. Treat as advised in "Guide Book," page 170; but only if the stocks are strong is it advisable to try to cure them.

EDWARDS (Pewsey).—Comb is affected with foul brood, but it is evidently a recent outbreak, as the disease is not in an advanced stage.

C. WOOTTON and A. HARDING.—Samples of comb are affected with foul brood.

Special Prepaid Advertisements.

Twelve words and under, Sixpence; for every additional Three words or under, One Penny.

HOLIDAY-SEEKERS could find Comfortable Apartments reasonable terms at Drayton House, Brightlingsea. r 69

EXPERT ENGAGED BY COUNTY IN ADDITION COULD MANAGE FAIR-SIZED APIARY, make appliances, &c.—Drayton House, Brightlingsea. r 68

VIRGIN QUEENS, Sladen's strains, 1s. 9d., 3 5s.; fertiles, 5s. 6d.; Nuclei from 12s. 6d.—**PAUL,** Salisbury-road, Bexley. r 10

NEW "W. B. C." HIVES, 12s. 6d. Exchange for Bees or Honey.—**WILLETT,** Bee-keeper, New Malden, Surrey. r 83

1909 SEVERAL SPARE QUEENS, just beginning to lay, 3s. 6d. each, post paid.—**CRAWSHAW,** Norton, Malton. r 66

APIARY OF TWENTY-FOUR HEALTHY STOCKS FOR SALE, mostly in "W. B. C." Hives; owner removing to town sole reason for selling.—Apply **EDWARDS,** Wilmington Lodge, Hassocks. r 85

32ND YEAR.—All orders for Swarms executed. Large customer writes: "I am very well satisfied with the bees you have sent." Few more to spare. Three (wired) Frame Nuclei, 10s. 6d. each; packages, 2s. each, or return carriage paid; Home-raised Queens, 3s. 6d.; Imported Italians, 5s. 6d.—**E. WOODHAM,** Clavering, Newport, Essex. r 75

FOR SALE, "British Bee Journal," volumes 4 to 7, volume 36; "Record," volumes 8 and 9; all unbound, 7s. 6d. Wanted, volumes 15, 18, and 20 to 23 "B.B.J." Exchange by arrangement.—**ANDREW, Skidby, Hull.** r 79

VERY STRONG SWARM, on 5 frames, packed in box, 13s. 6d.—**MULLEY,** Filey. r 72

WANTED, Honey, Sections and Extracted; also Beeswax, in exchange for new Bee-hives or Appliances; Gramophone, with 18 10-in. records; Harmsworth Encyclopædia, bound, 8 volumes.—**J. BOWDEN,** Broomhill, Witley, Surrey. r 84

LADY WANTS SITUATION ON FARM OR IN THE COUNTRY, good practical knowledge of poultry, bee-keeping, and dairy work; willing to undertake gardening or other outdoor work.—Write, "J. P.," c/o B.B.J. r 86

SWARMS.—A few more Prime Swarms, from my noted strains of Honey Gatherers, 3s. per lb. Orders strictly rotation.—**DAVIES,** Apiary, Bagshot, Hungerford. r 77

COMFORTABLE APARTMENTS, pleasantly situated, to let in Sussex, with an experienced Bee-keeper; large garden and orchard; suit lady or gentleman who would like to keep a few stocks.—Apply, "A. B. C.," B.B.J. Office. r 70

FOR SALE, 2 June Swarms, on 9 frames, all worked out, roofs zinc-covered, £1; four 10-frame Colonies, ready to super, Hives good, zinc-covered, 28s. each; 2 straw Skeps, strong, ready for Super, 15s. each; all guaranteed healthy and free from foul brood.—**S. HARRIS,** Aberfeldy, Perthshire. r 71

Editorial, Notices, &c.

PROMINENT BEE-KEEPERS.

MR. T. B. BLOW, F.L.S.

We are pleased to be able to give a recently-taken portrait of this well-known bee-keeper, who is also one of our oldest readers and contributors.

Mr. Thomas Bates Blow was born in 1853 at Welwyn, Herts, where his family

Saving the lives of bees and modern methods were beginning to be advocated about that time, and Mr. Blow made his first wooden hive on the "Woodbury" pattern. This was a massive double-walled construction, weighing about one hundredweight, which he stocked with driven bees, and obtained very good results. Being encouraged by his success, year by year he took more interest in bee-keeping, and very soon laid the foundation of what eventually became a



MR. THOMAS BATES BLOW.

had resided for many generations. He seems to have inherited a love for bee-keeping, for his ancestors kept bees before him, but, of course, on the old methods. At the age of fourteen he commenced handling bees, and accomplished the task of taking up twenty stocks in straw skeps by an improved method of applying sulphur fumes by means of common house-bellows, with a hollow ball in the nozzle containing burning sulphur.

large business at Welwyn by the manufacture of appliances. He was also one of the first to take the position of regularly-engaged expert, and to make tours—which usually took several weeks—amongst bee-keepers, and in this capacity he assisted in organising the Hertfordshire Association. He also assisted in the formation of other associations by means of lectures and demonstrations. During one of his tours in Herts the first bee-

census of a county was taken, the numbers of both frame-hives and skeps being noted.

Mr. Blow was one of the few who ever produced one-piece sections in this country, the elaborate machinery for their manufacture being designed by him. After two years' trial this branch of his business was abandoned owing to our native woods not being so suitable for section-making as the American basswood. He was an exhibitor at most of the shows, always obtaining prizes, and bee-keepers are indebted to him for many improvements in appliances.

Being interested in natural history, Mr. Blow devoted himself specially to the study of the bee itself, and with this object in view he made several journeys into the Mediterranean, the most important of them being to North Africa, Malta, Cyprus, Syria, and Egypt. He brought home bees from Syria and Cyprus, and after a toilsome and expensive journey, many being lost on the way, upwards of one hundred stocks were got to England in safety and distributed amongst our best-known bee-keepers. Full details of this journey were embodied in a paper read before the B.B.K.A. in 1882, entitled "A Bee-keeper's Experience in the East." His next journey was taken with a view to inquire into the merits of Carniolan bees, and one month's investigation was sufficient to convince him that all that had been said in their favour was perfectly true.

Having exhausted the subject of the investigation of races, he undertook a journey to the United States and Canada. There he visited many of the principal bee-keepers and received the warmest welcome, and was thus able to study their methods. The results of this expedition were contributed to our columns in various articles during its progress, as were also the details of the journey to Carniola. In 1887 Mr. Blow published a pamphlet entitled "Among the Queen-raisers in the North of Italy and Carniola."

Mr. Blow was also interested in botany, one of his first works published being "Contributions towards a Flora of the Neighbourhood of Hitchin." He was also a large contributor to a work published on the "Flora of Hertfordshire," and frequently wrote for the *Journal of Botany*.

Some years ago Mr. Blow disposed of his business at Welwyn and went to Japan, where he is now settled, having married a Japanese lady. He is still as much interested in bees as ever, as will be seen from his recent articles in the B.B.J., and pays frequent visits to the old country, never forgetting to make a friendly call at the office of the B.B.J.

PREVENTION OF BEE-DISEASES IN CAPE COLONY.

The Governor of Cape Colony issued a proclamation on September 8, 1908, prohibiting the importation of bees and their larvæ or eggs, excepting those made by or on behalf of the Government of the Colony. In connection with "foul brood," the importation of honey and beeswax (including comb-foundation) is also prohibited except under a written permit obtained from the Secretary of Agriculture, under certain restrictions as may be deemed necessary.

In the *Board of Trade Journal* Mr. E. J. Cottell, at Cape Town, reports that several consignments of honey recently arriving at that port have been rejected on account of omission to comply with the terms of the above proclamation.

A further proclamation, amending the one of 1908, just issued, provides for the prohibition of the importation of beeswax or comb-foundation, except under a written permission previously obtained from the Secretary of Agriculture, and subject to the production in the case of each consignment of such sworn declarations, in prescribed form, as may be required. The declarations that are required to accompany the importations of beeswax or comb-foundation must state that the wax has been melted for not less than two and a half hours at a temperature of not less than 212 deg. Fahr., and that no bee-disease of any description exists on the premises of the person making the declaration or within two miles thereof. Such a high temperature is likely to destroy the colour and aroma of the wax.

"ROYAL" SHOW AT GLOUCESTER.

(Report continued from page 253.)

The collections of bee-appliances made a fine show, extending right along the back and one end of the tent, the only absentee in this class being Messrs. Jas. Leo and Son, who, through pressure of work, were unable to stage an exhibit, but the space they should have occupied was filled by the other four competitors. In the best hive class the first prize was obtained by Messrs. Abbott Bros. with a "W. B. C." pattern hive, a departure from the original design being that the lifts and outer case are made absolutely square. The hive is beautifully made with lock joints and a very smooth finish. For practical work this is an unnecessary expense, though it adds to the attractive appearance of the hive; also Oregon pine is too liable to split to make a satisfactory roof.

Messrs. Lee and Son came second with an original pattern "W. B. C.," a very

good hive, made in their well-known style, lock-jointed, and of good sound material, and had the appearance of being taken from stock. Mr. E. H. Taylor's hive was also a "W. B. C." pattern one of good workmanship.

In the class for cottager hives all three winning exhibits were good sound hives, very well made, and there was an entire absence of the common practice of putting about 20s. worth of work and material into an article priced at 10s. 6d.

For honey-extractors, Mr. Meadows won with his well-known "Cowan" Rapid" with reversible cages, the machine being beautifully made. The second prize was a very nice machine with a novel gearing of two grooved wheels and a round strap. It runs easily, is absolutely noiseless, holds four shallow frames, and is also cheap, the price being 25s.

Only two observatory-hives were staged, both of which were a source of great attraction to the visitors.

In the new appliances class Mr. Meadows came first with a very ingenious uncapping tray designed by Mr. J. Gray, which provides for the melting of the cap-pings and separating of the wax and honey at one operation. The second prize was awarded to Mr. E. H. Taylor for a honey-jar with glass screw-cap, which no doubt will be welcomed by those who do not care to have their food stored in vessels where it may come in contact with tin.

The honey classes were better than could have been expected, though it would give great satisfaction to the Association to see a larger number of entries. If bee-keepers would only bear this show in mind and save some of their good honey from previous years, a much more creditable display would be made at the most important agricultural show in the world. One wonders what would happen if the veteran exhibitors did not loyally support the show, especially in the trophy classes, in which this year we had only three entries, all being from veterans of the craft, Messrs. R. Brown, W. Dixon, and J. Pearman. The judges must have had some difficulty in awarding the prizes, as all were excellent exhibits. Great credit is due to Mr. Brown in staging two trophies in this class, composed entirely of this year's produce. Have we not amongst the new generation of bee-keepers some who have enterprise enough to stage trophies, for, apart from prize-money, excellent sales are usually obtained? The fickleness of our season was apparent in the shallow-frame class, where, out of an entry of seven, only one competitor was able to stage an exhibit, letters received from the others saying they wanted just another seven days of fine weather for the completion of shallow frames. The heather class was far better supported than

usual, but there was only one Scotch exhibit. "Wake up, Scotland!"

Both wax classes were very badly supported. This should not be so, as the season has nothing to do with such exhibits. The quality of that shown was excellent. Vinegar and mead were very good, as also was the single exhibit by Mr. Dixon of confectionery in the class for most interesting exhibit.

B.B.K.A. EXHIBIT AT IMPERIAL INTERNATIONAL EXHIBITION.

Visitors to the "White City" this season should not leave without seeing the bee-keeping exhibit in the Government, Historical, and Industrial Building (Stand 162). The British Bee-keepers' Association were able to secure space in one of the principal aisles, and two enterprising firms of appliance dealers, Messrs. Abbott Bros. and Jas. Lee and Son, assisted them in presenting an exhibit by contributing hives and appliances. There are shown hives of many different kinds, from quaint straw skeps and nucleus-hives to the most up-to-date "W.B.C.," Messrs. Abbott staging the model of the latter which has deservedly obtained so many premier awards when exhibited at shows. Messrs. Lee show one of their famous observatory-hives, as well as others of attractive appearance. Everything of use to bee-keepers is presented in its best form, plainly labelled so as to be intelligible to the non-bee-keeper. The workmanship of these goods is a credit to British manufacturers, and will show foreign and Colonial visitors that we can hold our own in this line at any rate. If a few more interesting photographs of British bee-keeping, such as those shown at the next stand by the Studley Horticultural College, had been provided, it would be an added attraction, as the appliances look somewhat uninteresting and mysterious to the uninitiated, and unfortunately no attendant is permitted to be at the stand to explain their use, which might be seen from the photographs.

Correspondence.

The Editor does not hold himself responsible for the opinions expressed by correspondents. No notice will be taken of anonymous communications, and correspondents are requested to write on one side of the paper only, and give their real names and addresses, not necessarily for publication, but as a guarantee of good faith. Illustrations should be drawn on separate pieces of paper. We do not undertake to return rejected communications.

NOTES BY THE WAY.

[7517.] The honey season is fast passing by, and the best one can say of it up to the present is that it has been

a chequered one—I fear with rather more black than white on the board. Last month was one of the most disappointing Junes on record, wet and dull days predominating, with bursts of sunshine of short duration, and July, so far, is much the same. I do not remember stocks ever stronger than when the honey season opened, and one's hopes were raised high in anticipation of a record honey harvest; but the experience so far is not conducive to a big take. It is the same old story: "Man always is, but never to be blest."

The paragraphs in the daily and other papers on the "new bee-disease" in Buckinghamshire must have a disquieting effect on bee-keepers in the vicinity of the districts in which the outbreak has occurred. I think everyone should be on his guard, and not purchase bees, hives, or bee-appliances from an infected district. Can copies of the *Journal of the Board of Agriculture* for February last be procured from 4, Whitehall Place, London, S.W.? [Yes, we believe so.—Ed.]

"D. M. M." mentions a handy tool for cleaning out the interiors of hives in his article on page 253. A similar tool is used by bakers to scrape out the insides of their dough-bins, and this would, in my opinion, meet the wants of bee-keepers equally well.

Swarming Vagaries.—Swarming has been very prevalent this season when the weather has been favourable. On June 26 we had fifteen swarms in about two hours, and a neighbour living about two and a half miles away in a bee-line—Mr. Dyer, of Compton—had five the same afternoon, all five joining together. I twice had two swarms join together, and this means time to separate them, which can ill be spared on a busy day. One of my stocks has swarmed and returned to its hive four or five times at my out-apiary. My man calls it the record swarmer. The season has been remarkable, too, for stray swarms. After two poor swarming seasons Nature is restoring the balance, and a good breeding season is replenishing the reduced stocks of bees.

Newly-hived swarms or "casts" must be fed with syrup for a few days, if the weather is not settled and warm, so that they can work. Judicious feeding will enable them to continue comb-building, and thus help to establish the stock. Another help to a new swarm is to give foundation, either in full sheets, carefully wired, or in half-sheets, which will not require wiring except when the weather is very hot. If full sheets are given some space should be left for drone-brood.—W. WOODLEY, Beedon, Newbury.

HIEROGLYPHS OF THE BEE.

[7518.] With reference to Mr. Reid's interesting note on models in wax, and the last paragraph in particular, perhaps it may interest your readers to know that the hieroglyph of a bee occurs a great number of times on the ancient Egyptian monuments and papyri, and signifies "the King of Lower Egypt." *Rameses II.* being the ruler of both Upper and Lower Egypt accounts for the bee appearing on his statue. The sign was also used to denote honey, and in this case the bee was followed by a drawing of a small jar, which stood for liquid, and so we get bee-liquid = honey

I understand there is still much to learn about this special hieroglyph, and should you think it of sufficient interest possibly I can secure further details.—*BASIL E. BUCKWELL, Ealing.*

[We should be pleased to have further details, as we are sure readers would be interested in them. In the meantime, in addition to what is stated by our correspondent, we should like to explain that so far back as the Fourth Dynasty, nearly 4000 years B.C., the bee was the symbol of Lower Egypt, while the lotus represented Upper Egypt. The lotus and the bee standing side by side before a king's name signified jurisdiction over the whole of Egypt. While a king is sometimes represented by a bee, the latter is also used to denote a loyal and industrious people, the following being the sign used in this sense for the country of Lower Egypt:

There are also many other hieroglyphs in which the bee appears.

Honey itself is represented by this symbol:  The title of the keeper of the treasury contains a bee, and it also figured in the religious beliefs of ancient Egyptians, denoting generally one of the priestly orders, also a member of one of their orders of priests. The bee was also found as a symbol associated with death. There must be many more allusions to the bee, and we should be glad to have anything our esteemed correspondent can ascertain about them.—Ed.

DISINFECTANTS FOR BEE-HIVES.

[7519.] It is probable that if properly used chlorine would be one of the very best disinfectants for hives and a good remedy for foul brood. It is more diffusive and penetrating than carbolic acid, and would doubtless play havoc amongst foul brood bacilli. However, to give it in the form of chloride of lime is not the best way, because this substance has no

standard of proportion between the lime and chlorine, so that a pound of calcium chloride bought at one shop might be stronger than that bought at another, as all lime is not fully saturated, and some may be "old stock" from which a good deal of the chlorine has evaporated. For the bee-keeper the lime would be better done away with altogether; and if it was desired to use it in a fine spray, then the chlorine should be absorbed by water, and this diluted to a proper strength.

But the best way to use it would be to fill a gas-bag with air to a known pressure, and then inject a given amount of chlorine gas into the confined air, and with this mixture the hive could be fumigated.

Greatly diluted with air, chlorine can be inhaled by human beings without injury; and why not by bees also? Chlorine is a very heavy gas, and if used as chloride of lime for disinfecting purposes, and placed at the bottom of hive in rather cold weather when the bees were quiet, and not ventilating much, the chlorine given off would be so dense at the bottom of the hive after an hour or two that the bees descending the combs to drive it out would be stupefied before they could even begin to drive out the deadly gas. A more scientific method is necessary to ensure success.—A. GREEN, Notts.

BEE-NOTES FROM WARWICKSHIRE.

[7520.] Your witty and able contributor Mr. L. S. Crawshaw is evidently trying to catch me napping in his "Cappings of Comb," B.B.J., June 17 (pages 237 and 238), and he asks whether he may join the discussion in my retreat. I answer "Yes, Mr. Crawshaw," both you and any other reader of the B.B.J. will be welcome in my old wooden bee-shed to discuss that most interesting little insect the honey-bee.

If "parthenogenesis had direct descent in the female line," as he states, we could get queens without the aid of the drone; but as it goes "in the present zigzag fashion down the alternate sexes," it must be acknowledged that one of the most useful bees in the large community is the drone. Oh, of what mighty import is that little word "if"! If I were a rich man I should give up my office labours and devote my time to the inhabitants of my hives, poring into them as into books, trying to obtain all the knowledge I could get, for the good of my brother bee-keepers and their charges. Alas! that little word "if" intervenes, and completely upsets the whole show.

Cells.—One of our prominent experts, for whose opinion I have the greatest respect—I speak of Mr. W. Herrod—stated at the last meeting of the Warwick-

shire Bee-keepers' Association that he had never found out why young queens when hatching always leave a small cap hanging to the cell instead of cutting the end right off like the worker or drone. I have thought of what may perhaps be a reasonable solution to this problem, and will try to explain it. As all bee-keepers know, the queen-cell hangs mouth downwards; naturally when the cap at the bottom is cut so far round by the jaws of the young virgin inside, the slightest pressure, helped by gravity, will force it open, and the young queen who has been pressing against it, finding an exit, certainly would not trouble to cut the cap right off, but is only too glad to leave it hanging and free herself from her late prison. The worker and drone cells, as we know, have the mouths near the top, for these cells are inclined a little upwards, and so when the bee inside cuts round the mouth it would take more pressure to open it than with the queen-cell, as gravity would be slightly working against it. The young insect, not at its time of exit having the strength to work against gravity and the pressure of the mouth of the cell, has to cut it all round before it can free itself and get into the hive. Of course, this is only my idea, and I should like to hear the opinion of others on this point. I notice some races of bees build larger queen-cells than others. My hybrids, which are as fine a strain as could be wished, build queen-cells about $1\frac{1}{2}$ in. long, whilst other bees have only built them $\frac{3}{4}$ in. to $\frac{2}{3}$ in. long. It would be advantageous to find out whether the cell has anything to do with the prolificness of the queen and the working powers of the bees. I prefer bees that rear their queens in large cells, as the young queens have much more room for expansion and are not so liable to be cramped when developing.

B.B.K.A.—I approve of the scheme outlined in B.B.J. (7468, page 202) with the exception of altering the names of the county associations. Let them each keep their county name, but act as branches of the B.B.K.A. in the way Mr. Hepburn suggests. Let me appeal to all British bee-keepers to join either the B.B.K.A. or their affiliated county association. You all know the motto "United we stand, divided we fall." Bee-keepers, it is your duty to help the associations who are doing so much to help the craft you take an interest in, and the parent society in London needs all the assistance you can give, as it is passing at the present time through a crisis, which I am sure it will pass through safely, as it should, considering the good work it does.

W. B. C. Memorial.—I enclose my mite to help on this memorial fund, and hope others who have not done so yet

will send a small contribution to perpetuate the memory of this good and faithful friend of the bee.

Vagarics of Bees.—I have always been led to understand that bees will only open queen-cells at the side, but I have found that this is not an invariable rule. I gave a queen-cell to a colony covering eleven frames, which had lost its queen a week or ten days back. The hive contained only sealed brood, but the next day I found the queen-pupa lying on the alighting-board dead. On looking into the hive I found the queen-cell I gave them perfect, with the exception of the mouth having been torn completely off. This shows that bees do not always tear the sides of the queen-cell when they do not accept it, but sometimes the mouth.—W. F. WIEMANN, Erdington.

LATE MATING OF QUEEN.

[7521.] Will Mr. Sleight (7504, page 244) please give us more information about his late-mated queen, such as proof and facts that she was six weeks old when mated? According to a conversation I had with him last autumn, I believe he takes his stand on the fact that it was not suitable weather for a queen to fly until September 19, and also that a queen will commence to lay about the third day after mating. My business occupies me on night-duty every third week, therefore I am in bed part of the day. When I get up my wife will sometimes remark, "It has been wet this afternoon," or "It has been a nice day and the bees have been flying strong," but if she did not tell me I should not know what the weather had been. I believe Mr. Sleight is always on night-duty and in bed in the daytime, and it may be that the queen had been on the wing earlier than he thinks. Surely during the whole of August we had some fine days on which she might fly. Again, if there is no honey coming in and weather is bad, a queen will sometimes go for weeks before laying after being mated. Is not that correct, Mr. Editor? September is not unusually late to mate if there are drones about. I remember four years ago I saw a drone leave the hive on November 9. I examined the stock, expecting to find it queenless, but there was a patch of brood as large as one's hand.—J. PEARMAN, Derby.

We only know of one authenticated case of mating being deferred for six weeks in which the queen subsequently laid normally. Virgin queens do take advantage of fine intervals to fly out, and may thus easily escape notice. Usually the queen begins to lay from forty-eight hours to sixty-five hours after mating,

but laying is sometimes delayed until the following spring by those mated as late as September, because the bees, whose instinct tells them that the season is at an end, feed the queen very sparingly and just sufficiently to keep her alive, but not enough to enable her to produce the eggs. In the same way, bees are able to prevent egg-laying by the queen in bad weather, when they fear running short of stores.—ED.]

BUYING FOREIGN QUEENS.

[7522.] Buyers are ready enough to complain if they do not get exactly what they expected when they answer an advertisement in the B.B.J., but, on the other hand, I should like to call your attention to the more than fair treatment I have received from a foreign advertiser. On April 16 I received a pure Italian queen from an Italian queen-breeder at Bologna, but the cold weather at that time had been too much for her. She was replaced free of charge on April 22, but the queen was again dead. A third queen was sent on April 29, but was badly chilled, and died three days after introduction.

Having to write to the advertiser in question, I mentioned my bad luck, when, to my surprise, I received a fourth very fine young queen.

Though this transaction must have proved a loss to the rearer (four queens, four registered postages, and only one payment), yet treatment like this ensures further business. I enclose my name and address, and sign myself—SECOND-CLASS EXPERT, Worcester.

BEE-NOTES FROM HERTS.

[7523.] I was interested in reading the account of four stocks swarming at the same time, as described by "Royal Navy, Herts" (page 257), and had the experience yesterday (Sunday, July 4) of two swarms issuing at the same time and uniting, which scaled 7 lb. 11 oz., so that my two swarms weighed within 1 oz. of half the weight of "Royal Navy's" four swarms—which is rather remarkable.—WEST HERTS.

SECOND SWARMS.

[7524.] In B.B.J. on page 257 (7516) "Royal Navy, Herts," asks whether a swarm has been known to send out a swarm. Singular to relate, one issued from one of my stocks on Friday, July 2, about three o'clock. The original swarm weighed about 2½ lb., the second about 4 lb. I noticed what rapid progress the bees had made in a few weeks, as it was early in June when the original swarm was hived. My first swarm this year came out on May 7, then I had another

on May 31, weighing 8 lb., which I thought was good.—J. WAYMAN, Cottenham.

ISLE OF WIGHT BEE-DISEASE.

[7525.] We have unfortunately suffered from an outbreak of the Isle of Wight bee-disease in this neighbourhood, and with regard to your article in the BEE JOURNAL of July 1, "although it is impossible to diagnose the disease from the aspect of dead bees," we find, on squeezing the abdomen of the bees attacked here, a thick, yellow matter (undigested honey) will exude. Bees forwarded for inspection should be packed while still alive, surrounded by a little tissue-paper in a small tin box.

Six hives in the first apiary affected here were practically wiped out by the disease in four weeks; then three others in a village one and a half miles away in one direction and one three miles off in another direction were noticed to be diseased. The whole ten hives had all the bees frames, and covers burnt and buried, and we hope in this way to have stamped out this terrible disease here. Formaline is being freely used by owners of healthy hives as a preventive.—M. MILLARD, Hon. Sec. Hartley Wintney District Bee-keepers' Co-operative Society.

[7526.] I read the interesting report of Mr. Silver (B.B.J., pages 234 and 243) re the Isle of Wight trouble with some anxiety. It is gratifying to know that, so far, imported bees have done well; but very disappointing to hear that the malady still lingers like a ghost around the scenes of its former glory. However, whilst such zealous workers as Mr. Silver and Mr. H. Cooper still keep watch over the island bees, we know that they will have every attention. I trust that all concerned will see the necessity of still

preventing the traffic of bees and appliances from the island to the mainland.—T. E. A., Lutterworth.

SUCCESSFUL APICULTURE.

(Continued from page 207.)

EXAMINATION.

"Bring those quart bottles of syrup, and we will finish examining the stocks; it is a week since we were at the apiary.

"Let us look at No. 4 first. You see there are three combs of sealed brood and one comb full of eggs and larvæ, which shows that the additional bees have

helped the queen. I would rather not open this stock till next week, as it is better to go slowly than too fast, as we may have severe frosts yet.

"We will use No. 5 hive as a spare one, and transfer each stock as we go along. Let us work together.

"Drop your carbolised cloth at the entrance of the next hive (No. 8), and help me to lift it back. While I am putting the clean hive in place, uncover and subdue ready to transfer. Six frames of brood, that is very good; and stores in plenty. Book eight combs of



PICKING THE QUEEN OFF A COMB (see p. 268).

brood. I have put the two outside combs into the centre, with a comb of brood between. I never move the pollen-combs that come next to the brood. I hardly expected six combs of brood yet, as I did not consider the queen one of my best.

A USEFUL HIVE-TOOL.

"Just give me the brush and tool, and I will clean this hive while you cover up the last one we examined."

"Do you mean the file?"

"Yes; it is the only hive-tool I use. It answers all purposes—hammer, screw-driver, pry, narrow scraper, and for a wide scraper use the side. Any blacksmith can forge you one. Take the tang of a 12-in. flat file, $\frac{3}{8}$ in. by $1\frac{1}{2}$ in., and hammer out the end to a screw-driver

edge, retaining the original 1½-in. width, and you will have the most useful tool a bee-man can wish for.

"Now for No. 8. You see there are only one and a half combs of brood, which is very unsatisfactory. This hive is also short of bees, and as I believe the queen is a good one, it appears to me as if the bees from No. 8, in their early spring flights, have been out in strong force and have mixed in the whirl of bees from No. 7, and so become part of that stock. You see, my hives stand in pairs, with 8 ft. between each pair. Bring a couple of queen-cages and the flour-dredder, and we will exchange queens, so that we can test the one in No. 8. Give the screw of the cages an extra turn, so that the door cannot swing open and release the queen when caged.

"I will show you how to catch and cage a queen. Here is the comb with the queen. I grasp it by the top lug, and allow the top-bar to rest against the palm of my left hand; with the same hand I hold the cage with the ½-in. side-door open. Now pick off the queen with the right hand by the wings or thorax, and cage her through the ½-in. door. The left thumb should cover the door if it is necessary to repeat the operation in order to put in workers. Do the same with the other queen. Dust the bees on the frame of the hive with which you wish to exchange queens with flour while it is tilted sideways, open the large door of cage, dust the queen, and gently shake her out on to the comb into the midst of the bees. Take note that she gains a foothold on the comb before you lower it into the hive. Within an hour she will be cleaned and about her maternal duties. Try to put the queen from No. 7 into No. 8 in the same way.

"The top bars want cleaning in No. 9. Do this while I get the empty hive ready. Use the two carbolised cloths, so that only one frame is exposed at a time, and the narrow scraper will clean the bars without a bee getting in your way.

"We have one stock with the queen unclipped. I see it is No. 11. Are you ready for the transfer?"

"Yes."

"What brood is there?"

"Four combs, and plenty of stores."

"Put a comb in the centre, and book five frames of brood while I open No. 10."

—JOSEPH GRAY, C.C. Lecturer.

(To be continued.)

Bee Shows to Come.

July 15 and 16, at Louth.—Show of Honey, Hives, and Bee-appliances in connection with the Lincs Agricultural Society. **Entries closed.**

July 21 and 22, at Cardiff.—Glamorgan B.K.A., in connection with the Cardiff and County Horticultural Society's Coming-of-Age Show.

Members', Novices', and Open Classes. Record Schedule from W. J. Wiltshire, Maindy Schools, Cardiff. Judge, W. F. Reid, Esq., F.I.C., F.C.S. **Entries close July 18.**

July 21 and 22, at Tamworth.—Staffs B.K. Association Annual Exhibition, Honey, &c. Schedules from Mr. J. Tinsley, 22, Granville Terrace, Stone. **Entries finally close July 21.**

July 23, at Nether Wallop.—In connection with the Horticultural Show. Open classes for Honey: Best 1-lb. Jar Extracted, Best 1-lb. Section. Schedules from Pryce E. Roberts, School-house, Nether Wallop, Stockbridge. **Entries close July 21.**

July 23, at Upwell, Wisbech.—Horticultural Society's Show. All exhibits will receive careful attention. Open classes for Honey, including gift class for 1-lb. Jar. Schedules from Hon. Secretary, J. Hy. Inman, Upwell, Wisbech. **Entries invited.**

August 2 (Bank Holiday), at Cambridge.—Honey Show, in connection with the Cambridge Mammoth Show Society. All Open Classes. Four Special Hives to be competed for. This show also includes Dogs, Poultry, Pigeons, Cats, Rabbits, Cage Birds, Flowers, Fruit, and Vegetables. Also grand programme of Sports. The World-famed "Besses o' th' Barns" Band has been specially engaged. Schedules from Hon. Sec., Mr. E. F. Dant, Member of B.B.K.A., 52, Bridge Street, Cambridge. **Entries close July 23.**

August 2 (Bank Holiday), at Clewer, Windsor.—Show of Honey and Appliances by the Windsor Branch, Berks B.K.A., in conjunction with the Clewer Horticultural Society. Schedules from Hon. Sec., Mrs. W. S. Darby, 1, Consort Villas, Clewer, Berks. **Entries close July 23.**

August 2 (Bank Holiday), at Melton Constable.—Annual Honey Show of the North Norfolk B.K.A. Four Open Classes, including one for Single 1-lb. Section and one for Single 1-lb. Jar of Honey. Schedules from C. J. Cooke, Edgefield, Melton Constable. **Entries close July 24.**

August 4 and 5, at Abingdon Park, Northampton.—Honey Show of the Northants B.K.A. Special prizes for open classes, including one for single 1-lb. jar honey. (Entry free.) Judge, Mr. W. Herrod. Prizes 20s., 10s., 7s. 6d., and 2s. 6d. Schedules from R. Hefford, Hon. Sec., Kingsthorpe, Northants. **Entries close July 23.**

August 5, at Madresfield, Malvern.—Annual show of the Worcestershire B.K.A. Open class for collection of Bee-products. Prizes 20s. and 10s. Schedules from Mr. George Richings, 2, Shrubbery Terrace, Worcester. **Entries close July 31.**

August 10 to 12, at Beverley.—Show of Honey, &c., in connection with the Royal Yorkshire Agricultural Society. **Entries closed.**

August 10, at Holyhead.—Annual Honey Show of the Anglesey B.K.A. Open classes for 1-lb. Jar of 1909 Honey, prize 10s. 6d., entry fee 1s. 6d.; for Honey Trophy, open to all North Wales, prizes 21s., 10s. 6d., entrance fee 2s. No second prize given unless three or more compete. Schedules from Rev. O. Kyffin Williams, Llangwyllog, Anglesey. **Entries close July 25.**

August 13, at Lancaster.—Lancaster Agricultural Society, in conjunction with the Lancashire B.K.A. Fifteen Classes for Honey and Bee-produce; also for Bee-hives. Numerous special prizes, including two silver challenge cups, twelve silver and bronze medals, &c. In applying, state Honey Schedule required. Thos. Armistead and Son, Secretaries, Lancaster; or J. M. Bold, Almonds Green, West Derby, Hon. Sec. Lancs B.K.A. **Entries close August 4.**

August 13 and 19, at Shrewsbury.—Annual Show of the Shropshire B.K.A., in connection with the Shropshire Horticultural Society's Great Floral Fête in The Quarry. Nine Open Classes for Honey and Wax. Schedules from S. Cartwright, Shawbury, Shrewsbury, Hon. Sec. **Entries close August 6.**

August 21, at Elworth, Sandbach.—In connection with the Elworth Athletic Club and Horticultural Society's Show. Class for Honey open to the County of Chester. Prizes: 1st, 15s.; 2nd, 7s. 6d.; 3rd, 5s.; for 12 Jars Run or Extracted Honey; also Bronze Medal given by the Cheshire Bee-keepers' Association. Entry fee, 1s.

Schedules from E. Jones, Hon. Sec., Elworth, Sandbach. **Entries close August 14.**

August 25, at Brislington, Bristol.—Annual Show of Honey, Wax, and Appliances of the Somerset B.K.A. Extended Schedule and increased prizes. Seven open and two free classes. Schedules from Mr. James Brown, Show Sec., 31, Bridge Street, Bristol. Tel. 21767. Telegrams, "Brown, Bristol." **Entries close August 21.**

August 25 and 26, at Stratford-on-Avon.—Annual Show of the Warwickshire B.K.A., in connection with the Warwickshire Agricultural Society. Schedules from J. N. Bower, Hon. Sec., Knowle, Warwickshire.

September 16, at Castle Douglas.—In connection with Dairy Produce Show, the annual show of the South of Scotland Bee-keepers' Association. Open Classes for three 1-lb. Jars (20s., 10s., and 5s.); three Sections (20s., 10s., and 5s.); entry, 2s. One Jar (5s., 3s., and 2s.); one Section (5s., 3s., and 2s.), entry free, but exhibits forfeited unless otherwise arranged. Beeswax (5s., 3s., and 2s.); entry 6d. Thirteen Classes Confined to Members. Numerous prizes, including two Challenge Cups and gold and silver medals. Schedules from Q. Aird, Hardgate School House, Dalbeattie, N.B. **Entries close September 4.**

September 16, 17, and 18, at Crystal Palace.—Surrey B.K.A. Annual Exhibition of Bees, Honey, Wax, Appliances, &c. Twenty-seven classes (nine open to all). Many medals and increased prizes. Schedules from F. B. White, Secretary, Marden House, Redhill, Surrey. **Entries close September 1.**

September 22, at Altrincham.—Honey Show, in connection with the Altrincham Agricultural Show, the largest one-day show in the Kingdom. Classes open to United Kingdom. Classes for Trophy of Honey, for Best Hive, Observatory Hive with Bees and Queen, twelve Jars of Extracted Honey. Classes open to County of Chester, for Run and Section Honey, Wax, &c. Special Classes for Cottagers, and Special Classes for Society's District. Good prizes, low entrance fees. Schedules from Mr. J. Herbert Hall, 2, Dunham Road, Altrincham. **Entries close September 4.**

Queries and Replies.

[3951.] *Queen Laying in Shallow Frames.*—On May 19 I supered one of my stocks with a rack of fourteen shallow frames, first putting on excluder, and making safe all round with calico. On June 18 I examined the frames, and found the queen had had access to them, and brood was in twelve of the frames, the other two being full of honey. I removed the rack and excluder, and put the rack back on top of brood-chamber. I then placed another super of shallow frames on top of the first, putting excluder between them, and making good all round with American oilcloth. Being anxious to get some extracted honey for exhibition at our local show in August, I thought it was the best thing I could do, as I did not want them to swarm. Are they likely to do so now? There are thirteen frames in brood-chamber, well stocked with brood. Your advice will be gladly received by—WESTWARD HO, Hants.

REPLY.—The success or otherwise of what you have done will depend upon the pasturage and the strength of the colony; without knowing more on these points, we cannot say whether the bees will store honey or not. If you find they do not take to the second super, look for the queen and place her in body-box and put excluder on the frames, so that she is not able to get into the super. The brood will hatch in due time, and the bees will store honey in the combs. You can only tell if they are likely to swarm by observing their behaviour and examining the combs. Any queen-cells found should be removed if you wish to prevent swarming.

[3952.] *Japanese Bees.*—I am rather interested in this week's B.B.J., seeing trade catalogue received from Mr. Nonogaki, and his offer of

Japanese queens, not that Japanese bees are better than ours; but I would like one just for curiosity. 1. Is it possible to get Japanese queens imported into this country alive, having to come such a great distance and through different climates? 2. If so, is it too late to send for one to arrive before cold weather comes? 3. Can Mr. Nonogaki correspond in English?—ENTHUSIAST, Glos.

REPLY.—1. Yes, and we presume Mr. Nonogaki thinks so also, as he says: "Please try a colony of them; your satisfaction guaranteed." 2. Yes; the time occupied in transmitting mails from Japan via Suez is thirty-six to thirty-nine days, and via Vancouver twenty-six days. 3. We presume he can correspond in English, as his list is in this language.

[3953.] *Queens Piping.*—Can you please give me a description of queens piping? I hear a noise in some of my hives which I cannot understand; but it is like the croaking of a frog, and not a shrill noise, as I expected.—S. T., Chichester.

REPLY.—"Tu-tu-tu" is the sound produced by the just-hatched queen, which is answered by "Qua-qua-qua" of those queens still enclosed in their cells.

[3954.] *Dealing with Queenless Colony.*—1. Regarding the paragraph on "Re-queening," in one of "D. M. M.'s" "extracts" from American papers, on page 246 of B.B.J. for June 24. I have a stock queenless in a single-walled hive, which is too narrow to take a queened stock in brood-box on top of it, though I should much prefer to unite the stocks in the manner mentioned. Would there be any objection to reversing the process, putting the queenless stock on a sheet of paper above the queened stock? 2. I am aiming at heather-honey chiefly, and wish to have as many ready drawn-out sections as possible when the heather is out. I have a section-extractor for the purpose. There are a good many half-finished sections on the hives now. If I take these, would it be best to put them in a warm cupboard first to ripen them and then extract, or extract first and leave in bottles in the cupboard to ripen after? 3. At about what temperature should I keep the cupboard to ripen successfully? 4. A lot of the honey is very dark, but not bitter, as from oak-dew. Will it be fruit-blossom honey, as there is plenty in the district? Thanking you for much assistance from B.B.J. past and present.—CRYP (Yorks).

REPLY.—1. We have not tried it, so are unable to say. We should advise you to carry out the instructions given, and for this purpose we should put strips of wood on the sides of the narrow hive, so as to enable you to put the queened stock on top. 2. Extract first, and put honey in ripener in a warm place. 3. From 80 to 100 deg. if possible. 4. It may be from fruit and bean blossoms.

[3955.] *Bees Working on Fir-trees.*—The fir-trees near my hives have for some time past swarmed with bees. Is this, do you think, only for the purpose of collecting propolis?—J. W. H., Berks.

REPLY.—The bees are working on fir-trees for the purpose of collecting the sweet juices that exude from the needles in certain seasons, and which produce a dark but wholesome honey. On the other hand, they may be getting honey-dew, which is sometimes present on such trees.

Notices to Correspondents.

PAT MURPHY (Mallow, Ireland).—*Beginner's Questions.*—1. There is no brood in comb sent, only pollen and honey. 2. The earliest date on which the queen could start laying would be twenty-one to twenty-two days from the day the egg was laid. This period may be retarded by bad weather. 3. The entrance should be wide open in summer,

6 in. wide in winter, and reduced to 1 in. or less in autumn and spring. 4. It depends on what you use for quilts. In winter four or five thicknesses of underfelt or carpet over the calico quilt will do, and during summer you have to use your discretion and remove some of them, putting them on when the nights are cold. The felt is thin, and double this thickness would be right, or extra thicknesses should be put on. 5. You can give more frames as soon as bees have built out the eight you have already provided them with. A 5-lb. swarm should easily occupy the ten frames before the end of the season. 6. Fresh sheets of foundation should be put at the side of brood-nest, not in the centre. 7. Hives should not be painted white the bees are in them. Transfer bees to a spare hive, which you should always have by you. 8. The calico is quite suitable for the purpose. First paint the roof and lay the calico on it while the paint is wet. You need not stretch it, but lay it on smoothly, and when tacked down paint over it. 9. All bee-keepers are surrounded by ignorant ones such as you describe, and these are always a danger to the industry, because they know nothing about foul brood, allow their stocks to die out, and take no precautions to prevent the disease from spreading. The only thing you can do is to keep disinfectants in your hives as preventives, always feed with medicated syrup, and take every precaution to prevent robbing.

L. J. (Hants).—*Dying Bees*.—You must not conclude because you find dead and dying bees in front of your hive that you have the Isle of Wight disease among your bees. The fact that you found your colony with plenty of bees and brood, but not a particle of food, would account for the dead bees on the floor, as at this season much food is required for brood-rearing. You did quite right in giving them syrup, but be particular about using only pure cane-sugar for making it. With regard to your other colony, which has been weak all along, the bees you sent were all dead when they arrived, and there is nothing in their appearance to denote cause of death. As the colony is weak, if you find the symptoms such as those described, we would recommend destruction of the bees and combs and disinfection of the hive and surrounding ground. In any case, such weak colonies are of very little use.

LOWER WARD (Renfrewshire).—*Bees Not Working on Hawthorn*.—1. Comb appears affected with black brood, but most of the sealed cells contain almost fully-developed bees ready to hatch. Some of the unsealed cells contain hard pollen. 2. In unfavourable weather hawthorn does not seem to secrete sufficient nectar to attract the bees, and it is seldom they are able to work on it. 3. Refer to page 159 of B.B.J. for April 16, 1903, for making an observatory-hive.

"HANTS" (Blackwater).—*Price of Swarms*.—Six, seven, or eight shillings, according to the size of the swarm, as this is July, and the honey-flow nearly over. Have had no report of the disease in your district yet.

A READER (Staffs).—*Queen-bee*.—1. The queen sent is a young unmated one. 2. There is no market for heather-honey in frames. Pressed out of combs, it would be worth from 50s. to 60s. a hundredweight, according to quality.

A. E. C. (Peterborough).—*Queen in Sections*.—As the bees found plenty of room in drawer under the frames in which they have built combs, they did not need to go into the rack of sections. If you desired them to work above, you should have prevented them from going below. 1. Probably, when you smoked the bees to put on the super-clearer, the queen ran up into the sections to escape from the smoke. 2. Yes, the separation from their queen would irritate the

bees. 3. You did right in returning the queen. 4. You can only tell if all is right by examining the hive to make sure that the queen is there and laying regularly. As there were bees in sections to protect her, she has probably come to no harm.

A. C. (Aviemore).—*Several Eggs in Cells*.—Occasionally there are abnormally prolific queens, which not only lay several eggs in a cell, but drop them on the floorboard. This may happen when they are cramped for room, there not being sufficient empty cells in which to lay. As a rule, queens only lay one egg in a cell.

NOVICE (Yorkshire).—*Beginning Bee-keeping*.—From your questions we presume you are a beginner; therefore, your best plan is to get the "British Bee-keepers' Guide Book," in which you will find full instructions, occupying ten pages, for preparing hives for working for (1) extracted and (2) comb honey. 3. The best time to purchase a swarm is as early as possible in spring. 4. You require a smoker, which is indispensable for manipulations. 5. Yes; see pages 151-2 of "Guide Book."

Honey Samples

K. (St. Asaph).—The honey is from mixed sources, and only suitable for dark honey class. Flavour and aroma are fairly good, consistency fair. There is a small quantity of honey-dew, which rather spoils it. It would not be good enough for one of the big shows, but in local competition might obtain an award.

INQUIRER (Knutsford).—Fruit-honey spoiled by honey-dew, and not good enough for show-bench or table use. It could be used for feeding back to the bees.

QUITE AN AMATEUR (Presteign).—The section was broken from the wood all round, and honey running out when it reached the B.B.J. office through faulty packing. Good fruit-honey. If well filled, sections such as these ought to fetch 6d. or 7d. wholesale, and 9d. to 11d. retail.

Special Prepaid Advertisements.

Twelve words and under, Sixpence; for every additional Three words or under, One Penny.

FOR SALE. 15 "Cottage" Bee-hives, cheap.—Apply, RIX, Wendover, Bucks. r 90

2 GRAND STOCKS BEES, on 10 Frames, in Taylor's "Twentieth Century" 20s. Non-Swarming Hives, as new, specially fitted for Heather, 35s. each; strong Stock, supered and fitted for Heather, 35s.; "Cowan" geared Extractor, perfect, cost 50s., accept 30s.; Honey Ripener and Strainer, 7s. 6d.; Racks fully drawn out Shallow Frames, 4s. each; Section Racks, fitted with Sections and Starters, 2s. 6d. each; good Smokers, 2s. each.—MEGGITT, Poynton, Cheshire. r 93

SWARMS, 8s. 6d. each; boxes free, guaranteed healthy.—MULLIS, Egerton, Kent. r 95

STRONG STOCKS, in straw Skeps, 1909 Queen, 12s. 6d., 13s. 6d.; Stocks, with 10 Standard Frames, 25s. 6d.; 3-frame Nucleus, 12s. 6d.; 1909 Queen, Racks of Shallow Frames and Combs, 4s. 6d.; all guaranteed healthy.—W. WOODS, Normandy, near Guildford. s 4

HEALTHY DRIVEN BEES, commencing August 1, 4s. per lot, with Queens; boxes to be returned. Orders in rotation. Cash with order.—T. PULLEN, Ramsbury, Hungerford. s 3

4 DOZEN SELECTED STANDARD FRAMES HONEYCOMB TO SELL, 10s. per dozen.—DAVID HUNTER, Craighead, Abington, N.B. r 94

HONEY PRESS, "Rymer" pattern, second-hand, good as new, 10s., on rail.—W. H., 72, Devonshire-road, Forest Hill. r 97

Editorial, Notices, &c.

REVIEW.

Mendel's Principles of Heredity. By W. Bateson, M.A., F.R.S., V.M.H. (Cambridge: The University Press. Price 12s. net.)—The author tells us that the object of this book is to give a succinct account of discoveries in regard to heredity made by the application of Mendel's methods of research. The theory of "evolution" and "origin of species" is so associated with the name of Darwin, whose celebration has so recently taken place at Cambridge, that one is apt to forget that there were others who for more than half a century had worked on the same lines, prominent amongst these experimenters being such men as Koelreuter, John Hunter, Gaertner, Naudin, Knight, and several others. In 1889 de Vries published a paper in which was foreshadowed a conception of unit-characters, which play so large a part in the development of what Professor Bateson has termed "genetics." It was in 1897 that Dr. Galton enunciated his law of heredity, which stated that of our total heritage we owe on an average one-half to our parents, one quarter to grandparents, one-eighth to great-grandparents and so on. Although there was a statistical accord between Galton's theory and some facts of heredity, in the practice of breeding there were already known so many classes of unconfirmable phenomena that his statement could only be looked upon as more an occasional consequence of the laws of heredity than one of those laws.

The author of this book is the first Professor of Biology in the University of Cambridge, and is known as one of the most distinguished of her men of science. He has for a long time put forward claims on behalf of the discoveries associated with the name of Mendel. The new law of descent was made known by Mendel so long ago as 1865, and his work, forgotten for a time, was brought to light again in 1900 by de Vries, Correns, and Tschermak, and it is due mainly to Professor Bateson that the work of Mendel has served as an inspiration for recent research in heredity. The scientific world is now giving full recognition to this new law. There is no discovery in the principles of heredity that may compare with it since "The Origin of Species" appeared, and it is of infinitely more practical importance than that work. Mendel's law teaches that when pure stocks or strains are crossed it is found that certain qualities remain indestructible and appear uncontaminated in a definite proportion of offspring of all generations

after the first. George Mendel, who was Abbot of Brünn, made known in 1865 this new law of descent, which he had discovered by the cultivation of peas and other plants, and also by observation of heredity in bees and other animals. This forms the subject of Professor Bateson's "Mendel's Principles of Heredity."

The essence of Mendel's discovery is that of segregation. We start from a common fact that all the ordinary animals and plants began their individual life by the union of two cells known as *gametes*. Each of these is supplied with certain ingredients or factors, which may be either the same in both male and female, or different. If both parent gametes bring in a certain quality, all the daughter gametes have it, but if neither brought it in, then none of the daughter gametes have it. If it came from one side only, then on an average it will be present in half and absent from the other half.

Mendel's experiments with the edible pea (*Pisum sativum*) are well known, and serve as an example of the general principles of his teaching. This is what Professor Bateson says:—

"Mendel took a pair of varieties, of which one was tall, being 6 ft. to 7 ft. high, and the other was dwarf, $\frac{3}{4}$ ft. to $1\frac{1}{2}$ ft. These two were then crossed together. The cross-bred seeds thus produced grew into plants which were always tall, having a height not sensibly different from that of the pure tall variety. From the fact that the character—tallness—appears in the cross-bred to the exclusion of the opposite character, Mendel called it a 'dominant' character; dwarfness, which disappears in the cross-bred, he called 'recessive.'"

In the next generation the tall cross-bred bore seeds which produced many tall dominants and some short recessives, in the proportion of three tall to one short, or, in other words, 75 per cent. dominants to 25 per cent. recessives. It was found that if allowed to fertilise themselves the offspring of the recessives again produced recessives only, showing them to be pure to the recessive character, which in this case was dwarfness. But the tall dominants behaved differently, and when tested by a study of their offspring, instead of being alike, as were the recessives, gave plants which were tall only, and were therefore pure to tallness, and also plants consisting of both tall and dwarf, showing again an average of three tall to one dwarf. The ratio of impure plants to the pure plants was as 2 to 1. The total in the third generation consisted of 25 per cent. pure dominants, 50 per cent. impure dominants, and 25 per cent. of recessives.

Since the fertilised ovum was formed by the union of germ cells having tallness and dwarfness as factors, both these elements entered into the composition of the original fertilised ovum or *zygote*. If at some stage in the process of germ formation the germ cells are bearers of either tallness or dwarfness, there must be a separation of the two characters. This dissociation of characters from each other in the course of formation of the germs is called segregation. As Professor Bateson shows, such segregation is one of the normal phenomena of nature. Segregation determines the regularity perceptible in the hereditary transmission of differences and defines the units concerned in the constitution of organisms.

Another example will explain the discovery by Professor Bateson of the meaning of *reversion*, which has for a long time puzzled scientists and breeders. We know tall sweet peas breed true. Of dwarf sweet peas both Cupids and Bush breed true. Now Cupid crossed with Bush gives Tall. The explanation is of the simplest. Cupid is tall minus something; Bush is tall minus something else. In sporting out of Tall, Cupid did so by losing a certain factor which produced tallness. Bush, in arising from Tall, did so by losing another factor, which also made for tallness. When Cupid and Bush are mated together each supplies one of the missing links of tallness and both necessary factors for tall are thus present in the offspring, which consequently are tall.

Not only is the Mendel law applicable to plants, but it is seen that they and animals, as such, do not show any difference in their manner of heredity. Inheritance on simple Mendelian lines has been also studied in reference to the structural characters of man, cattle, the horse, mouse, fowls, pigeons, canaries, &c. Animals and plants in which colour characters have been shown to have a Mendelian inheritance are fully described, and Professor Bateson illustrates this part of his subject with fine coloured diagrams, those of the lepidoptera, sweet peas, and *Primula sinensis* being particularly good, and clearly demonstrate the qualities to be emphasised.

Mendel's largest undertaking, besides the work on *Pisum*, was an investigation of the heredity of bees. Professor Bateson tells us that he had fifty hives under his observation, and collected queens of all attainable races, European, Egyptian, and American, and effected numerous crosses between these races. He made attempts to induce the queens to mate in his room, which he netted with gauze for the purpose, but it was too small or too dark, and the efforts were unsuccessful. Unfortunately, the notes he made

of these experiments cannot be found, and it is supposed that in the depression which he suffered before his death they were destroyed. Professor Bateson visited the Königskloster at Brünn, hoping to discover some trace of the missing books, but was unsuccessful, although he saw the hives which had been used standing in their places.

In the book before us Professor Bateson demonstrates that Mendel, by the study of the simple character individually, showed that law and order reign in inheritance. Much has already been done in the study of the subject, and there is every indication that through Mendel's law we are likely to have important discoveries in the breeding of plants and animals, as well as in the improvement of bees. Anything Professor Bateson writes on the subject is sure to command attention, and we are sure that the clearness and fairness with which he has treated it in his book will be appreciated not only by biologists, but also by others who cannot but find much to enjoy in its pages, for he has the happy knack of not only making his writings instructive but also highly interesting.

NEW B.K.A. FOR GLOUCESTERSHIRE.

Taking advantage of the impetus given by the "Royal" Show being held at Gloucester, the Gloucestershire bee-keepers have bestirred themselves, and held a meeting on Tuesday, the 22nd ult., at the class-room of the Friends' Meeting House to inaugurate, if possible, a county association. They had secured a strong contingent of well-known bee-keepers to address the meeting, including Messrs. A. G. Pugh and C. L. M. Eales, members of the Council of the B.B.K.A., Mr. W. Herrod, official expert B.B.K.A., and Mr. Brown, of Somersham, Hunts. Mr. Pugh was called to the chair, and Mr. E. J. Burt, of Gloucester, who had convened the meeting, introduced the business of the evening. After referring to an old county association, defunct for several years, he spoke of the great advantages bee-keepers would derive from a good working association in obtaining expert assistance in bee-management, in marketing their produce, and in mutual help. The chairman and all the above-named visitors urged other advantages upon the meeting, and explained various methods of working of successful associations. The bee-keepers of Gloucestershire might be sure of every help and encouragement the B.B.K.A. could give them. On the motion of Mr. Trevor, seconded by Mr. E. J. Burt, it was unanimously resolved to form an association in affiliation with the B.B.K.A.

The following gentlemen were elected on the committee:—Messrs. E. J. Burt, J. C. Calvert, and W. A. Workman. The position of Secretary is filled *pro tem.* by Mr. J. Hillman, of Stonehouse, Glos. It is generally felt that an association will be very successful in the county, and those wishing to join are asked to communicate with the Secretary. — J. HILLMAN, Stonehouse, Glos.

HONEY IMPORTS.

The value of honey imported into the United Kingdom during the month of June, 1909, was £5,886.—From a return furnished to the BRITISH BEE JOURNAL by the Statistical Office, H.M. Customs.

Correspondence.

The Editor does not hold himself responsible for the opinions expressed by correspondents. No notice will be taken of anonymous communications, and correspondents are requested to write on one side of the paper only, and give their real names and addresses, not necessarily for publication, but as a guarantee of good faith. Illustrations should be drawn on separate pieces of paper. We do not undertake to return rejected communications.

AMONG THE BEES.

HONEY PACKING-CASES.

[7527.] Grocers' empties come in handy as boxes for forwarding honey to the merchant who purchases it, and in some ways no better receptacle could be devised for its despatch. Orders vary so much. Sometimes sections wanted may number only half a dozen, a dozen, or a score. Frequently the order may be for one or two hundred. Boxes for the latter may be purchased at home for a few pence, and of course are considered as non-returnable. Grocers on a large scale prefer such cases, because they give them no trouble or responsibility to return, while they lie by in store to wait their turn to be repacked and forwarded with some other class of goods. If bee-keepers prefer to have a more elaborate class of packing-case their local carpenter is likely to make them as cheaply as, carriage included, they can receive them from a box factory. While, therefore, I consider that for this class of case provision is at present already made, this is not so for small orders, or for private customers of the better class.

It may not be generally known that the Safety Paper and Box Manufacturing Company about seven years ago turned out corrugated paper boxes for packing honey in either glass bottles or sections to hold 1 lb., and they were highly recommended as suitable for forwarding small packages as specimens, or for carrying home small orders from the grocery

stores. Similar boxes to hold two, four, six, and twelve jars or sections were also put on the market, but I have an idea that they have not found an extensive sale, perhaps owing to the fact that they are not advertised so extensively as to be kept before the notice of present-day bee-keepers. So strong were these small boxes that they could stand any rough usage and bear the strain of a very long journey. Our late Editor certified that he had personally tested their strength by standing on them, and his weight of 12 st. made no impression on their stability. The Box Manufacturing Company might take the hint and fully re-advertise these small cardboard boxes.

Quite recently the idea has been resuscitated in America, and we have lately had two competing designs illustrated in *Gleanings* of what they call shipping-cases, which are very favourably commented on, and some would even prophesy that they will drive all wooden ones out of the market. As I think such cases would fill a blank on this side I hope some of our appliance dealers or the above-named company, which can turn out anything in paper or cardboard as cheaply and efficiently as anyone can, will submit some cases at an early date in time for the marketing season, so that they can be fully tested before another year.

The Crane case claims to be stronger, cheaper, and lighter than any made of wood, while it transports honey in perfect safety, as is shown by the fact that about 30,000 lb. of honey travelled a long distance and reached the end of the journey in perfect condition. The description of the make-up is as follows:—"The case consists of a rectangular frame of cellular board with corrugated straw-board partitions. These are covered with a top and bottom, both having telescoping sides and ends that fit over the rectangular frame and meet in the middle. A sheet of single-faced cellular board is laid on the bottom to afford the sections a cushion." Like the cardboard cases made by our Box Company the illustration shows these latter filled with honey can bear the strain of a heavy man resting his whole weight above one. Mr. Crane contends that there will be a saving in freight, that honey carried in such cases will sell at a better price, and that they will bear a sudden fall, jerk, or jar better far than wooden cases. Many of his customers now stipulate that honey must be forwarded in these packages.

Another style of corrugated paper shipping-case "that can be put in the flat or knockdown without the use of any paste or sticker" is illustrated in a late issue of *Gleanings* (pp. 307-8). Dissected, the parts are as follows:—"The shape is rectangular, and internally a

series of divisions afford space for a bottle or section being pressed down in an apartment of its own. The sides and ends project in the form of a flap at the top and bottom, folding over, thus making a double cover and a double bottom. To strengthen it still further an extra inside rim with its cross partitions slips down into the case, making it very rigid and strong. It has the further great advantage that it can be forwarded to customers in the flat. Mr. Root considers that by their use "the problem of marketing comb-honey in large or small quantities with little or no breakage will be solved, which means a greatly increased market for this class of honey which it has hitherto been denied." (Latest *Gleanings* is not so confident.)

For honey producers all over this country a somewhat similar package would be a great boon, and for all who work for heather-honey in comb it would be particularly so. I have always felt that for private customers ordering small quantities a neater and more presentable package was needed. This indeed is one of the weak points in turning out honey of the best class. It is not presented to the public in a sufficiently taking way. Everyone has seen how great grocery stores vie with each other in offering their special goods in the most presentable packages, and no one will deny that this helps to make the contents more saleable and indeed more palatable. Bee-keepers should take a leaf from their book and cease to be content with any old soap box or similar discarded empty. Who will provide us with such a case?—D. M. M., Banff.

[The A.I. Root Co. have kindly lent us a block showing the new corrugated case, which we will illustrate in an early issue of B.B.J.]

DISINFECTING HIVES.

[7528.] *Blow-lamp Disinfection of Hives.*—This is an operation which can only be properly performed when done systematically and thoroughly. It is somewhat strange that the terms universally used—both by American and British writers—to describe this work, viz., to "burn out," "char," "scorch," &c., are so needlessly severe. Messrs. Root, for instance, advise charring infected hives brown or black, but add that it is not necessary to char deep in order to destroy the foul-brood germs. Now, how can anyone possibly think that it is? Really, one would think these germs were monstrous in size, and also burrowed deep into the wood, instead of being microscopic and, if present at all, lying on the surface.

So far, indeed, from its being needful

to actually char the wood, the mere passage of an intensely hot flame (such as that produced by a good brazing-lamp) over the surface must instantly shrivel up anything approaching the minuteness of foul-brood germs. To scorch a hive brown and black is to depreciate it quite 50 per cent. in value.

What is really needed is the systematic passing of the flame over every inch of the surface, beginning at one corner, and moving the lamp to and fro, lowering it at the return just the width of the flame, and not, on the contrary, moving it about promiscuously, charring one place and leaving another perhaps untouched.

The great difficulty, however, is not the disinfection of the hive, because this can be done to an absolute certainty; but the disinfection of the bees. The disease accompanies the bees into the new or clean hive, either in the blood of the queen, in that of the workers, in the honey, or actually, it may be, on the tongues of the bees.

A swarm from a diseased stock (albeit the disease may be of a very mild type) takes the disease with it into the new hive, although everything about that hive may be quite new.

In face of these facts I am quite unable to understand how it was that such an exceptionally able bee-keeper as the late Mr. C. N. Abbott consistently and persistently advocated the purchase of swarms by beginners, giving them plainly to understand that by so doing they avoided all risk of disease. There can be no such assurance, because hives with a mild type of brood-disease will throw off swarms, and good ones too, year after year.

Bee-keepers are advised that the use of naphthalene, the washing-out of hives with carbolic acid, the periodic or gradual renewal of combs, &c., &c., will or may prevent the inroads of brood diseases among their bees. In my opinion, not one of these precautions, nor all three combined, will do any such thing. Take the case of painting the hives over with carbolic acid, for instance. Now, what is the utmost that this can be expected to do? It may destroy any germs which might be adhering to the hives at the time of application only; but supposing, say, a week after this was done, a near neighbour bought a badly-diseased and weak stock, at a time when bees were inclined to rob, the result would probably be virulent brood disease in the hives, which the previous dressing with disinfectant would be utterly powerless to prevent. Please do not think I am advocating slovenliness. Very far from it; but it seems to me that the efficacy of these disinfectants, &c., is very much over-estimated. If the use of minute quantities of germicides in syrup were ab-

olutely inhibitive of the growth of the bacillus, then one would think that their continued use would abolish the disease; but is it so?

Notice Messrs. Root's method of cure and the inconsistencies to which it leads. After advising the bee-keeper to be most scrupulously careful to disinfect all appliances used, and to get all honey from a diseased stock well out of the way, they say they finally found relief by shaking the bees from their combs direct on to frames of foundation in a clean hive. Now, at any time in the honey season, when even a moderate flow was on, the thin nectar from the diseased combs would shake out all over the bees, and also on the new frames or board. Thus the bees are actually furnished with (presumably) diseased honey at the very outset. I feel confident that this method will not cure the disease.

Again, they say the bee-keeper who does not wish to sacrifice a quantity of healthy brood in the diseased hive may set it on the new lot until all healthy brood has hatched. Now, if this will not effectually infect the lower (or turned out) lot, what will? Indeed, if the germs of brood diseases were of a distinctly beneficial kind (say, in the ripening of honey), would not this be the very thing a bee-keeper would be likely to do in order to inoculate the lower hive?

But, you may ask, what about the numerous cases of reported cures by these and other methods? My answer is that in all probability, and in by far the majority of cases, they were not radical cures at all. The disease was merely scotched, not killed, and was not rediscovered until it had made considerable progress, when the bee-keeper at once put it down as a fresh outbreak, instead of which the disease was absolutely continuous.

No wonder that many bee-keepers dread the visit of a competent foul-brood inspector! I feel as sure as I can be of anything without ocular proof that many an apiary now set down as healthy would have to go into the "black list" if such rigid inspection were made.

In conclusion, I am of opinion that it cannot be too distinctly laid down that turning the bees out into a clean hive does nothing whatever, certainly save getting rid of the diseased combs, brood, &c.; but if those bees go into the new hive with the disease about them in any shape or form, it will, almost to a certainty, be reproduced in the very first batch of brood raised by them.—S. P. SOAL, Rochford.

A PROFITABLE QUEEN.

[7529.] Late last summer I purchased a golden queen from an advertiser in your paper, and made up a nucleus of

four frames, which wintered well, and came through strong in the spring of 1909. It became so crowded with bees that I had to add more frames, making twelve in all. Then I gave a rack of shallow frames fitted with foundation, and shortly afterwards a second rack, which was filled up very rapidly. I put a third rack on the hive, but this was not enough, for a swarm issued, weighing 6½ lb., and nine days later a 4-lb. "cast" came off. Then I made up two nuclei of three frames each, which are doing well. The parent stock is still strong, and I have ready to take off 65 lb. of honey.

One good swarm, one cast, and two nuclei is pretty good from one stock, so I think I may say, as a keeper of twenty-two years' standing of golden queens, if you get the right strain they cannot be surpassed. Another stock, headed by a black queen crossed with a golden drone, has given me 45 lb. of extracted honey and two well-filled racks of sections.

I may say there are a great many bee-keepers in Bucks near me, but I have not discovered one case of the Isle of Wight complaint yet.—A. N., High Wycombe.

EAST ANGLIAN OBSERVATIONS.

[7530.] *Early Honey* (page 257).—In replying to Mr. Crawshaw I might say that I referred to the horse-chestnut, and that correctly it should not have been in the plural, as I was not thinking of the Spanish chestnut at the time. Probably the temperature influenced the bees visiting the former, as, when staying with a friend in Mid-Suffolk just before Whit-sun, one particularly fine horse-chestnut tree was a mass of blossom and was constantly visited by bees gathering nectar; the temperature was about 80 deg. in the shade. A hawthorn tree close by in full bloom was scarcely noticed by them. On May 5 I passed a field of turnip, saved for seed, on which bees were working. On May 20 one bee-keeper showed me a tree in blossom, not familiar to local botanists, which proved to be *Prunus radus*, N.O. *Rosacea*. This was visited by bees. *Trifolium incarnatum* was in full bloom on May 26; beans, trefoil, and mustard about the same time also. Districts and stocks varied very much, according to nature of soil and weather. Strong stocks left well stored last autumn and having good queens were in capital condition and produced early honey in May, among which were the record hives of 1908. One that produced 200 lb. last season had stored new honey which was almost ready to seal over on May 15. This was in shallow-frame supers. Others had sections ready to take off that week.

The weather of June was not so favourable for bees, but a good deal of honey has been stored and taken. One bee-keeper has recently taken off 150 lb. of honey, the number of stocks kept being about ten.

Advantage of Insurance.—A bee-keeper near Felixstowe insured his hives at the end of April. A month later a neighbour's horse was so badly stung that death ensued.

Swarms (page 258).—Does Mr. Crawshaw recommend excluder-zinc to cover entrance of hive after living swarms, and so prevent reissuing of the queen? Has he tried the plan of putting a frame of brood in the hive to retain the swarm?

Swarms and Foul Brood.—Also will he give his opinion about swarms carrying disease, as maintained by some bee-keepers? A swarm must necessarily come from a fairly strong stock, and a strong stock cannot be badly diseased. If there were disease in the incipient stage, what is the risk?

Foreign Honey.—The following is the analysis of a sample of foreign honey:—Ash, 0.26 per cent.; optical rotation = -7 deg.; acidity, very slight; foreign substances, absent; odour, very peculiar.—A. W. SALMON, Chingford.

SWARM SETTling ON HORSE.

[7531.] Referring to the disaster at Sutton, N. Hants, whereby a horse was stung to death through a large swarm of bees settling upon him, I should like to know if any means could have prevented this fatal issue. Possibly the horse and cart were in a stackyard adjacent to a large apiary. No one knew how to deal with such a position, and the occurrence has caused a good deal of agitation in the district where bee-keeping is prevalent. I myself have eight stocks of bees in my garden at home (Sutton), and over the fence in the paddock have cows and ponies. The possibility of history repeating itself, perhaps on my favourite cob, is sufficiently disquieting to make me ask the opinion of an expert on the above and the probability of such a disaster happening, and how it is best dealt with. Are such occurrences frequent?—"NOVICE," Harrogate.

[Such occurrences are very rare, and there are a great many hives kept close to where horses and cattle are passing without any bad results. We can quite understand a horse whisking its tail to drive away the bees, and in this way irritating them and causing them to sting. We ourselves keep our bees close to a meadow where there are horses and sheep, and within a few yards of stables, and know that very many other colonies are kept under similar conditions. Such

cases can only be looked upon as accidents, which, although rare, may occasionally happen, and for this reason the insurance scheme was started by the B.B.K.A.—ED.]

HIVE-ROOFS.

[7532.] In compliance with your request on page 186 I herewith send particulars of my rainproof roof which I mentioned:—The roof is made of $\frac{3}{4}$ -in. boards, covered with Delabole slates, each kept in position by two round-headed

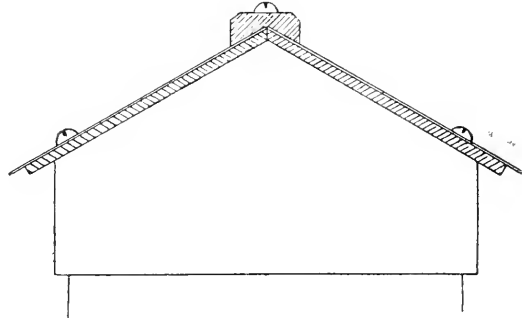

screws, as shown in sketch. The wood cap on the top is bedded in red lead and held down with screws. The sketch, I hope, will make all clear.—R. GROSE, Bodmin.

SOURCE OF DARK HONEY.

[7533.] I am pleased to report my bees are doing very well this season, and up to a week ago none but light honey was being stored. However, during the past week I find they have commenced filling up with dark honey. Can you suggest from what source they are gathering this, as privet is not yet out, and there is no honey-dew, which is to be expected after the rains during the past fortnight? I promptly extracted all that was capped over in order to make sure of having some light honey. One of your readers is a bee-keeper in a large way at West Finchley. Perhaps he would relate his experience as to this season's honey?—ENTOMOLOGIST, North Finchley.

WOMEN'S AGRICULTURAL AND HORTICULTURAL UNION.

The above association are holding their annual exhibition and sale of farm and garden produce, poultry, &c., on Wednesday, the 21st inst., in the gardens of the Royal Botanic Society, Regent's Park, London, at 2.30 p.m., when the Countess of Malmesbury will open the proceedings.

In addition to the show there are numerous other attractions. A fantasy, "Cupid in Arden," by Mrs. Adrian C. Hope, will be performed at 3.30 and 5.30; costume dances, songs, &c., by the pupils

of Miss Cowper Coles; butter-making; bee-driving demonstrations by Miss Winifred Seadon (aged eight years); while the band of the Essex Yeomanry will also play during the afternoon. The date for entries is now closed, but tickets of admission if obtained in advance can be had for 1s.; if payment is made at the gate on the day of the show the charge is 2s. 6d. The secretary, 64, Lower Sloane Street, S.W., will be pleased to supply tickets on application.

CAPPINGS OF COMB.

BY L. S. CRAWSHAW, NORTON, MALTON.

Swarming without Increase (page 225).—The Combination hive has long since proved its usefulness, and needs no praise from me. But I suggest that a good deal of hive lifting, and indeed the necessity for extra hives, may be dispensed with if this type of hive be put to its full service. Suppose a hive, holding at least fifteen frames and division-board, having entrances at each end, A and B. A stock on ten frames issues from A, whereupon the frames are slid back to B, and closed with the board. (This is equivalent to putting the old stock on a new stand.) Five frames of foundation (1), or (2) (a plan I should prefer but do not like to indiscriminately recommend), one frame of brood obtained from B, and five of starters, are given to A, together with the original supers. If necessary, give another super next to the excluder. After the honey-flow, or so soon as the young queen (B) begins to lay, remove the old queen and unite. Then or later, five empty or incomplete combs may be removed, or the brood-nest (A) may be placed over an excluder elsewhere, and rendered when free from brood.

New Ideas (page 233).—It is indeed easy to imagine oneself an originator, when the idea itself may have been forgotten, or even discarded long ago. Ideas recur, and it is no indictment of individual originality to point out that they have occurred before. Let us, however, when possible refer them to their "original originator." Now I do not know that it is so; but I have little doubt that were I to hunt for it I should find my excellent suggestion in the previous "Capping," or something like it, in the pages of, say, "A Modern Bee-farm," in which case I hope the writer will spare my life.

"D. M. M.'s" *Don'ts* (page 234).—"Don't pinch a queen when examining her." No; of course not. Examine her first! But it is not everyone who can catch a queen to pinch her. They might if only she would not run about; but she is as elusive as the little black sheep that would not stand still to be counted.

Physician, Heal Thyself (page 241).—I wonder what sort of man in private life is the editor of such a paper as that. Extreme credulity and ignorance, coupled with discourtesy, are no doubt useful editorial qualities, but they suggest, shall we say, a lack of that polish which is an attribute of the gentleman. I suspect such a person of a passion for ducks kept in the backyard for the sake of their song!

Reproduction (page 245).—To narrow the term in this way would surely mean that we could only consider as capable of reproduction those individual animals which happened to transmit their own sex! At the same time, most poultry-folk would admit that a cockerel-producing hen is not truly reproductive!

Sunday Swarms (page 246).—It is curious how the bees seem to affect this day. Sometimes it seems as though there really were grounds for the old belief. No doubt the bees hear the church bells, and connect the sound with the "tanging" which used to accompany their exodus. But all Sundays are not swarming-days. Yesterday, an execrable day, hardly a bee left hive-shelter to face the north wind, and one strong lot threw out the unatched drones; whilst to-day I am writing these notes in the sunshine amongst the hives, with one ear open for a swarm. Well, for the swarming note!

The Season (page 254).—An unknown correspondent sends me a card asking me to supply epithets for the weather. The subject is too disagreeable for me to attempt to qualify it, only if I were a weather doctor I would treat it for flatulence! How high were our hopes in the spring, and now we are having another lesson to expect nothing but the unexpected! Certainly the years seem capable of infinite variety.

The Suffragettes (page 257).—I wonder whether a moral can be attached, tin can fashion, to this tale. It seems that these discontented ladies (I nearly said "discantinted"!), weary of home duties, flung off, only to find equal tasks and a narrowed influence in their new sphere. Then they yearned for the Coptic fleshpots, and were once again for desertion of duty. So they went around, knocking at the doors of their neighbours, and finding none to take them in, were forced to camp outside the guarded portals of their old Eden. Or was it that the queen, who seems to have done her part, longed once more to hear the serenading song of the dear old drone at her doorway?

Yenoh Honey (adv. v.).—What is Yenoh? It reads like honey inverted; but has not honey already undergone all the inversion of which it is capable?

Queen's Forty-third Season (adv. v.).—These queens should be worth buying by those who wish to impart longevity to their stock. They should be valuable, too, for the production of supersedure cells.

SONG OF A WHITBY BEE-KEEPER.

Bring out the useful feeders,
And make the syrup hot;
Rummage round for something warm,
Old blankets—all you've got.
Pile them on the hives with glee,
To super them is vain,
If you'd save a single bee,
Now Summer's come again.

What though the icy breezes
Blow strong upon the coast,
And all the honey freezes,
And bees give up the ghost?
The bee-man keeps on grinning,
A grin that's half insane,
And says he loves his hobby,
Now Summer's come again.

When flowers are all over
The weather will turn hot,
And bees come out in thousands,
With nothing to be got.
Ah! happy then the bee-man,
With nothing more to gain,
He'll live on hope and—*nothing*
Till Summer comes again.

P. J. C. F.

Bee Shows to Come.

July 21 and 22, at Cardiff.—Glamorgan B.K.A., in connection with the Cardiff and County Horticultural Society's Coming-of-Age Show, Members', Novices', and Open Classes. Record Schedule from W. J. Wiltshire, Maindy Schools, Cardiff. Judge, W. F. Reid, Esq., F.I.C., F.C.S. **Entries close July 18.**

July 21 and 22, at Tamworth.—Staffs B.K. Association Annual Exhibition, Honey, &c. Schedules from Mr. J. Tinsley, 22, Granville Terrace, Stone. **Entries finally close July 16.**

July 28, at Dean, Hants.—In connection with the Dean and District Horticultural Show. Open classes for honey. Single 1-lb. jar, single 1-lb. section. Schedules from H. C. Knapman, Estate Office, Norman Court, Salisbury. **Entries close July 31.**

July 28, at Nether Wallop.—In connection with the Horticultural Show. Open classes for Honey: Best 1-lb. Jar Extracted, Best 1-lb. Section. Schedules from Pryce E. Roberts, Schoolhouse, Nether Wallop, Stockbridge. **Entries close July 21.**

July 28, at Upwell, Wisbech.—Horticultural Society's Show. All exhibits will receive careful attention. Open classes for Honey, including gift class for 1-lb. Jar. Schedules from Hon. Secretary, J. Hy. Inman, Upwell, Wisbech. **Entries invited.**

August 2 (Bank Holiday), at Cambridge.—Honey Show, in connection with the Cambridge Mammoth Show Society. All Open Classes. Four Special Hives to be competed for. This show also includes Dogs, Poultry, Pigeons, Cats, Rabbits, Cage Birds, Flowers, Fruit, and Vegetables. Also grand programme of Sports. The World-famed "Besses o' th' Barns" Band has been specially engaged. Schedules from Hon. Sec., Mr. E. F. Dant, Member of B.B.K.A., 52, Bridge Street, Cambridge. **Entries close July 28.**

August 2 (Bank Holiday), at Clewer, Windsor.—Show of Honey and Appliances by the Windsor Branch, Berks B.K.A., in conjunction

with the Clewer Horticultural Society. Schedules from Hon. Sec., Mrs. W. S. Darby, 1, Consort Villas, Clewer, Berks. **Entries close July 28.**

August 2 (Bank Holiday), at Melton Constable.—Annual Honey Show of the North Norfolk B.K.A. Four Open Classes, including one for Single 1-lb. Section and one for Single 1-lb. Jar of Honey. Schedules from C. J. Cooke, Edgefield, Melton Constable. **Entries close July 24.**

August 4 and 5, at Abingdon Park, Northampton.—Honey Show of the Northants B.K.A. Special prizes for open classes, including one for single 1-lb. jar honey. (Entry free.) Judge, Mr. W. Herrod. Prizes 20s., 10s., 7s. 6d., and 2s. 6d. Schedules from R. Hefford, Hon. Sec., Kingsthorpe, Northants. **Entries close July 28.**

August 5, at Madresfield, Malvern.—Annual show of the Worcestershire B.K.A. Open class for collection of Bee-products. Prizes 20s. and 10s. Schedules from Mr. George Richings, 2, Shrubbery Terrace, Worcester. **Entries close July 31.**

August 10, at Holyhead.—Annual Honey Show of the Anglesey B.K.A. Open classes for 1-lb. Jar of 1909 Honey, prize 10s. 6d., entry fee 1s. 6d.; for Honey Trophy, open to all North Wales, prizes 21s., 10s. 6d., entrance fee 2s. No second prize given unless three or more compete. Schedules from Rev. O. Kyffin Williams, Llangwyllog, Anglesey. **Entries close July 25.**

August 10 to 12, at Beverley.—Show of Honey, &c., in connection with the Royal Yorkshire Agricultural Society. **Entries closed.**

August 11, at Wye (Kent Honey Show).—Five Open Classes: Trophy, cup value £3 3s. (entry 1s.), 1 lb. Section, 1 lb. Light Run, 1 lb. Dark Run, 20s., 10s., 5s. in each case (entry free); Beginner's Outfit, to retail 30s. (entry free). Fifteen Classes open to Kent: Two Challenge Cups, value £6 6s., and money prizes for 6 1-lb. Sections and 6 1-lb. Jars Extracted Honey. Money prizes for 6 Jars Light, 6 Jars Medium, 6 Jars Dark Extracted Honey, 2 Shallow or Standard Frames, 3 Sections and 3 Jars. 1 Jar Granulated, Beeswax, Mead, Candy, Cake Sweetened with Honey, Display of Cut Flowers, &c.; two Special Classes for Cottagers. Schedules of J. Tippen, Secretary, Wye, Kent. **Entries close August 2.**

August 18, at Lancaster.—Lancaster Agricultural Society, in conjunction with the Lancashire B.K.A. Fifteen Classes for Honey and Bee-produce; also for Bee-hives. Numerous special prizes, including two silver challenge cups, twelve silver and bronze medals, &c. In applying, state Honey Schedule required. Thos. Armitstead and Son, Secretaries, Lancaster; or J. M. Bold, Almonds Green, West Derby, Hon. Sec. Lancs B.K.A. **Entries close August 4.**

August 18 and 19, at Shrewsbury.—Annual Show of the Shropshire B.K.A., in connection with the Shropshire Horticultural Society's Great Floral Fête in The Quarry. Nine Open Classes for Honey and Wax. Schedules from S. Cartwright, Shawbury, Shrewsbury, Hon. Sec. **Entries close August 6.**

August 19, at Salisbury.—Annual Show of the Salisbury and District B.K.A. Five classes open to the United Kingdom, including Single Section and Single Bottle. No entry fee. Schedules from Hon. Sec., J. E. Pinder, Salisbury. **Entries close August 11.**

August 21, at Elworth, Sandbach.—In connection with the Elworth Athletic Club and Horticultural Society's Show. Class for Honey open to the County of Chester. Prizes: 1st, 15s.; 2nd, 7s. 6d.; 3rd, 5s.; for 12 Jars Run or Extracted Honey; also Bronze Medal given by the Cheshire Bee-keepers' Association. Entry fee, 1s. Schedules from E. Jones, Hon. Sec., Elworth, Sandbach. **Entries close August 14.**

August 25, at Brislington, Bristol.—Annual Show of Honey, Wax, and Appliances of the Somerset B.K.A. Extended Schedule and increased prizes. Seven open and two free classes. Schedules from Mr. James Brown, Show Sec., 31, Bridge Street, Bristol. Tel. 21767. Telegrams, "Brown, Bristol." **Entries close August 21.**

August 25 and 26, at Stratford-on-Avon.—Annual Show of the Warwickshire B.K.A., in connection with the Warwickshire Agricultural Society. Schedules from J. N. Bower, Hon. Sec., Knowle, Warwickshire.

September 1 and 2, at Carlisle.—First Annual Show of the Cumberland B.K.A. Ten Open Classes (including Honey Trophy) for Honey, Hives, and Wax. Liberal Money Prizes in all Classes; also the C.B.K.A. Certificate of Merit to best exhibit in each class. Schedules from G. W. Avery, Hon. Sec., Heads Nook, Carlisle. **Entries close August 18.**

September 13, at Conway, N. Wales.—Annual Honey Show, in connection with the Conway Honey Fair. Open and local classes. Schedules from J. Hughes, Town Hall, Conway. **Entries close September 6.**

September 16, at Castle Douglas.—In connection with Dairy Produce Show, the annual show of the South of Scotland Bee-keepers' Association. Open Classes for three 1-lb. Jars (20s., 10s., and 5s.); three Sections (20s., 10s., and 5s.); entry, 2s. One Jar (5s., 3s., and 2s.); one Section (5s., 3s., and 2s.), entry free, but exhibits forfeited unless otherwise arranged. Beeswax (5s., 3s., and 2s.); entry 6d. Thirteen Classes Confined to Members. Numerous prizes, including two Challenge Cups and gold and silver medals. Schedules from Q. Aird, Hardgate School House, Dalbeattie, N.B. **Entries close September 4.**

September 16, 17, and 18, at Crystal Palace.—Surrey B.K.A. Annual Exhibition of Bees. Honey, Wax, Appliances, &c. Twenty-seven classes (nine open to all). Many medals and increased prizes. Schedules from F. B. White, Secretary, Marden House, Redhill, Surrey. **Entries close September 1.**

September 22, at Altrincham.—Honey Show, in connection with the Altrincham Agricultural Show, the largest one-day show in the Kingdom. Classes open to United Kingdom. Classes for Trophy of Honey, for Best Hive, Observatory Hive with Bees and Queen, twelve Jars of Extracted Honey. Classes open to County of Chester, for Run and Section Honey, Wax, &c. Special Classes for Cottagers, and Special Classes for Society's District. Good prizes, low entrance fees. Schedules from Mr. J. Herbert Hall, 2, Dunham Road, Altrincham. **Entries close September 4.**

Queries and Replies.

[3956.] *Queen Getting through Excluder.*—At the beginning of the season I purchased a Brice swarm-catcher and fitted it to my Claustal hive, simply filling recess for floor or alighting board, and I am absolutely certain that no bee could escape without first passing through the excluder zinc. Twice the bees swarmed, on each occasion alighting on trees. I returned them each time, removing all the queen cells after the second swarm three weeks ago. I then made a simple catcher (a board to fill front of porch with excluder wire), but, much to my disgust, out they again came last Saturday, although the catcher was on. Leaving the catcher on for the purpose of finding the queen, I again returned them through it without the desired result. Yesterday morning I found her cast out. I was under the impression that the queen could not pass through zinc or wire excluder. Is it possible for this to happen? If this is so a swarm-catcher, to my mind, must be of little use. I enclose the dead bee in question, which I take to be a queen. If this is so, is she of normal size, and how do you account for the above? I should also be pleased to know whether she is the ordinary old English black bee.—W. Jackson.

REPLY.—Sometimes queens do pass through excluder, if they are smaller than usual, or if there is a defect in excluder. Occasionally the zinc becomes buckled or otherwise damaged, and in this way the holes get enlarged, enabling the queen to squeeze through. Your queen, which is an ordinary black one, is of normal size, and on testing we find she will not go through excluder zinc. If she has done so there must be a defect in the zinc or some other means of exit.

Notices to Correspondents.

NEWHAND (Catford).—*Putting on Sections.*—1. There is still a prospect of honey-flow in some districts, and the lime trees are just coming into bloom, so that you may yet get some honey. It is no use putting on another rack of sections unless bees are storing honey in those now on. 2. Mignonette is very valuable for bees, and they also work on Michaelmas daisies.

DRIVEN (Leicestershire).—*Driving Bees.*—You will find full instructions for driving bees on page 147 of Guide Book (new edition), and best way of packing bees for transit on pages 116-120. 1. Drive each lot separately and unite as many as you wish. 2. Yes, see page 117. 3. The new edition has been re-written, and contains much new matter, and is the one always referred to.

LEX (Wrexham).—*Age of Queen.*—The queen is quite a young one.

M. L. (Emsworth).—*Race of Bees.*—The bees are hybrids of black and brown bees, which are usually bad-tempered.

WORTH (Sussex).—*Loss of Queen.*—Your best plan is to introduce another queen, but you must take certain precautions if there is no brood or young bees, as the old ones frequently ball the queen. If the hive has been queenless for some time, introduce frames of hatching-brood, and cage the queen on one of the combs.

A. B. HARRIS (Cheshire).—*Queen-cell in Super.*—1. The queen-cell you send contains an undeveloped drone. If the queen has not had access to the super, we can only account for it by supposing either that the workers have transported eggs to the super, or that drone-eggs have been laid by an unfertile queen or laying worker. A full-sized queen should not get through excluder, although sometimes an undersized one may do so. 2. Bees are frequently disinclined to commence work on comb-foundation, when they will at once take to ready-built combs.

WEST HERTS.—*Bees Dying.*—You must not assume because your bees are dying that they are suffering from the Isle of Wight disease. There are many cases with similar symptoms, where the bees recover after certain atmospheric changes, with honey coming in plentifully. In 1882 a similar disease was reported in the B.B.J. for August 1, page 78, and there was quite a scare at that time, but by destruction of the diseased stocks the disease disappeared.

WARWICKSHIRE READER.—*Bees Looking Like Swarming.*—The hive is crowded, and your bees have been evidently intending to swarm, but have been prevented from doing so by adverse weather. Remove what sections are completed and give more room. Two crates of sections are not sufficient for strong hives.

A NOVICE (Chester).—*Value of Bee-house.*—There is no doubt that a bee-house is advantageous for anyone who can go to the expense of one. We ourselves have such a house, and find it most convenient for manipulations. You will, however, require plain hives to go inside it. Your friend was having a joke when he offered to sell you a cock and hen bee.

E. C. C. (York).—*Name of Flower.*—It is the trailing *Loiseleuria (Loiseleuria proembens)*.

J. W. B. (Huddersfield).—*Bees Idle after Swarming.*—Bees do not do much after swarming for some days, as it takes all the population to look after the brood, so you need not trouble about them idling. You were wrong in cutting out queen cells before making sure that there was a queen. It is quite possible now the skep is queenless, but the swarm should have a queen, or the bees would not remain in the

hive unless there was brood. Do not introduce another queen without making a thorough examination to see if there is not one already. There is a York and District Association, Secretary, Mr. J. Gallimore, Escrick, York, who would give you information about membership.

FLORIST (Monmouth).—Drones being Killed.—It is quite right for the bees to destroy drones when they have no further use for them and stores are not coming in freely. Your hive has evidently got a fertile queen or the bees would not get rid of the drones. The mother hive has a young queen, and the virgin swarm would have the old one, and destroying the young queen to unite the swarm with the stock is only advisable if the old queen shows any superiority over the young one. Your best plan is either to hive the swarm from the swarm in a frame-hive, or examine the mother hive, and if you find there is no queen, unite the two.

WEST SUSSEX.—Honey Vinegar.—The sample is quite good enough for the show-bench, but whether it receives an award or not will depend upon how it compares with the other exhibits.

N. H. ROOKE (Herts).—Using Extractor.—Full directions are given in Guide Book, page 85, but some honey is so thick that it is impossible to extract it. Heather-honey, for instance, cannot be extracted at all, but has to be pressed out. If the comb was taken straight from the hive and put into the extractor at once, it should not have taken you more than a few minutes to get out the honey, and as it took three hours to get so little, it is evidently too thick to extract.

R. E. S. (Southampton).—Dwindling Bees.—1. She may do so, but you should make sure that the bees have plenty of good food. A healthy queen has been known to pull a weak colony through. 2. The only way to save the queen is to get some driven-bees without a queen, and introduce her to them.

ANXIOUS SEVENOAKS (Kent).—Bees not Working in Sections.—1. Bees will not go into sections until colony is very strong and weather suitable. It has been too cold lately for them to do so. Wrap up the supers and keep them as warm as possible. 2. Most likely the queen has been lost, as usually queens begin to lay as soon as combs have been built out. 3. It is too late to expect bees to transfer themselves from skep now, and by referring to Guide Book, page 150, you will see April is the month recommended. The bees may build out some combs, but it is not likely that the queen would go down so late in the season.

QUERY (Bucks.).—Stopping Fly Nuisance.—We do not know of anything that will prevent flies swarming at the entrance of hives. Reducing the entrance will enable the bees to keep them from getting into the hives.

ANXIOUS (Hants).—Disease in Combs.—The combs you send must have been a long time coming, as they were in a horrible condition, wet and mouldy, and swarming with small maggots. Traces of wax-moth on one of them, and two wax-moth grubs in box. Some of the brood is chilled, and there is black-brood, and here and there cells containing foul-brood.

PUZZLED (Wantage).—Dead Bees.—The bees appear to have died from starvation, and we would suggest that you give them some warm syrup poured into the combs.

H. C. (Rye).—Race of Bees.—The bees sent are crossed with Italians.

E. E. BARRY (Yorkshire).—Swarm-building in Tree.—It is a very common thing for swarms to commence building a piece of comb in the tree on which they settle, particularly if they are deterred by rain or bad weather from flying away after they have first swarmed. We frequently have such pieces of comb sent to us.

Honey Samples.

IDEJA (Herefordshire).—The honey is of good consistency and flavour, and would be suitable for staging as medium. You should get colour glasses, and compare the honey with them in the 1lb. jars, as it frequently looks darker in such jars than it does in a small sample such as you send.

J. ARNFIELD (Hereford).—Your honey has been spoilt by the amount of honey-dew in it, which renders it unfit for the table.

J. BURTON (Aylesbury).—The honey is rather dark but of good flavour and consistency.

Suspected Combs.

T. H. S. (Cams.)—Comb is affected with foul-brood, probably a recent outbreak, as it is not in advanced stage.

Special Prepaid Advertisements.

Twelve words and under, Sixpence; for every additional Three words or under, One Penny.

NEW "W.B.C." HIVES, 12s. 6d. Exchange for Bees or Honey.—**WILLETT, JUN.,** Beekeeper, New Malden, Surrey. s 7

SURPLUS WHITE ORPINGTON COCKERELS FOR SALE, Taminadge and Anthony's strain, 11 weeks old, 3s. 6d. each.—**BRISTOW,** Cane End, Reading. s 9

8 IN. and 10 in. JEWEL LAWN MOWERS, splendid condition, enclosed in case, 18s. and 21s.—**GEO. LEDGER,** Weybridge. s 10

GOOD SWARM OF HYBRID BEES, just out. Will sell for 10s. 6d.—**GEO. LEDGER,** Weybridge. s 11

"BRITISH BEE JOURNAL," 1905-'09, unbound, sell 7s. 6d., or exchange.—**"S.,"** c/o BEE JOURNAL. s 13

EXTRACTOR WANTED, good condition, geared, covered.—Particulars to "M.," Hockley Heath, Warwickshire. s 12

FOR SALE, 6 Hives, "W.B.C." pattern, other Standard size Hives, 1 Shallow Frame, Combs, Section Crates, all in good condition, reducing apiary.—**HILL, Ashley, Stockbridge, Hants.** s 14

HEALTHY DRIVEN BEES OR SHAKEN SWARMS WANTED, for moors, in not less than 4-lb. and not more than 8-lb. lots, with Queen in each. Can offer 1s. 3d. per pound for lots received from now up to July 31, and 1s. per pound from then to August 14. Cannot accept later. Will provide travelling boxes if wished, and pay all carriage. Cash by return post after receipt of Bees.—**J. M. BALMBRA,** East-parade, Alnwick. s 15

FOR DISPOSAL, 2 handsome carved oak panels and drawer fronts to match, size 26 in. by 18 in. No reasonable offer refused. Cash or exchange.—**BROWN, Vine Cottage, Burton, Christchurch.** s 15

QUEENS, 1909, selected hardy strain, 4s. each, posted in introduction cages. Satisfaction guaranteed.—**DAVIDSON, Basingsstoke.** s 17

EXCHANGE 1½ h.p. ENGINE, with Clips for Roadster Frame, new carburetter, electric coil, 20 hour accumulator, new, silencer, petrol tank, and strong frame, 1½ in. tubes, black enamelled, suit above parts. For Driven Bees, Hives, or anything useful.—**WATTS, Chickereil Farm, Weymouth.** s 21

NUCLEI, 3 Frames (wired), Bees and Brood, with young hybrid Queens, 11s. 6d.; Stocks on 9 Frames, in good Hives, 30s.; guaranteed healthy.—**BURT, 21, Station-road, Brockhurst, Gosport.** s 20

FOR SALE, about 50 Shallow-frame Drawn-out, suitable for Heather Honey; several Swarms established on 8 Standard Combs, 18s. 6d., free boxes; one Trophy Stand, comprising Stand, 4 sheets plate glass, bevelled edge and round corners, with 12 pillars, and case for travelling in, £2 17s. 6d. Photo sent.—**H. BARLOW, 558, Harts-hill, Stoke-on-Trent.** s 19

Editorial, Notices, &c.

BRITISH BEE-KEEPERS' ASSOCIATION

The monthly meeting of the Council was held at 105, Jernyn Street, London, W., on Thursday, July 15, there being present Mr. T. W. Cowan (chairman), Mr. W. F. Reid (vice-chairman), Messrs. R. T. Andrews, C. L. M. Eales, O. R. Frankenstein, E. Gareke, Jas. Grimwood, K. M. Hall, W. E. Hamlyn, J. B. Lamb, Arnold Richards, E. D. Till, and E. Walker. Letters were read from some absent members regretting their inability to attend.

Fifteen new members were elected, viz.: Walter Barnes, Foley Cottage, Exning, near Newmarket; H. M. Brown, 38, Wood Street, Shrewsbury; the Rev. Arthur E. Cook, Folksworth Rectory, Peterborough; Cyril Edwards, Banningham, Aylsham; George S. Fauch, Kylemore, Moorland Road, Ilford; C. R. Fielder, The Gardens, North Mymms Park, Hatfield, Herts; Mrs. Greg, Coles Park, near Buntingford; Mrs. Hemsley, 81, Ashburnham Road, Bedford; E. Kearney, St. Patrick's Cemetery, Leytonstone; Leonard J. Measures, Kimbolton Station, Kimbolton; Mrs. Poulter, Inglebrook, Brigg; V. Eric Shaw, 8, Moss Hall Grove, North Finchley, N.; W. B. Tallent, Post Office, Broomhall Street, Sheffield; C. Thompson, 6, Wood Street, Higham Ferrers; Stanley Wilton, Valkyrie Road, Westcliff-on-Sea.

Mr. Eales presented the report of the finance committee, and cheques as recommended by them were ordered to be signed.

On behalf of the appeal committee Mr. Lamb reported that further sums had been contributed, and the committee had every reason to hope that the total response would be satisfactory. The list would, of course, be kept open for some time to come.

Respecting the insurance scheme for the current year, it was reported that 9,504 hives had been insured up to the present, the premiums received making a total of £48 8s. 9d. Three claims had been already paid to a total of £15 8s., while a fourth, received a few days ago, for a horse killed, was being investigated. [This has since been paid by the underwriters.]

Reports were received upon third-class examinations recently held in Somerset, Gloucester, Hants, Essex, and Aberdare, with the following results:—Third-class certificates to Henry James Grist, Downside, Shepton Mallet; H. G. Kemp, Wallbridge, Frome; Alexander Manson, Aberdeen and North of Scotland Agricultural College, Aberdeen; the Rev. Hubert G. Stanley, Marshfield Vicarage, Cardiff;

George Bryce, Heath End, Farnham; W. Saunders, Hartley Wintney, Winchfield; A. V. Stewart, Hartley Wintney, Winchfield; G. H. Horscroft, 230, Coventry Road, Ilford; G. Tudor Williams, Cynon Cottage, Aberdare.

The Council made arrangements for some forthcoming examinations, and also judging at shows.

Three candidates for first-class certificates were in attendance to lecture before the Council on some subject, prescribed at the time, connected with apiculture. At the conclusion of the lectures it was agreed to award first-class certificates to the Rev. A. D. Downes-Shaw, Kettlestone Rectory, Fakenham, and C. Knight-Coutts, Holmdene, Evesham. The third candidate was requested to come again in twelve months' time, for lecturing only.

It was resolved to hold a special meeting on Thursday, August 5, for the special purpose of receiving and discussing Mr. Gareke's scheme for extending and improving the work of the association. The next ordinary meeting of the Council was appointed to be held on Sept. 16.

REVIEWS.

Winning a Living on Four Acres. By Fred. A. Morton. (London: A. C. Fifield. Price 6d. net.)—The author of this little book was a young clerk in the Civil Service, and gave up his post for the purpose of following the "Simple Life." He purchased four acres of land in Essex and began operations with garden produce, poultry, goats, and bees, living entirely on non-animal foods (except eggs, milk, and cheese). With a capital of only £117 he managed to make £45 at the end of the second year. He did not find all he undertook profitable, and first related his experience in a little book entitled "The Simple Life on Four Acres." The book before us is a sequel to the former one, and now he tells us the story of two years' further experience. He found with a larger number poultry were not so profitable as at first, and goats were disappointing. Bees, however, were not only the most interesting but also the most profitable. The chapter devoted to them is instructive, and, showing his appreciation, he says: "Things would be very dull now, I think, without the bee-interest, which does not fail in the winter and increases as summer approaches," and concludes with: "What a blessing this occupation of bee-keeping is! So distinct from my other duties, it furnishes a change in work that can hardly be overvalued." To prevent unsuitable and unpractical people from coming to grief through imitating his experiment Mr. Morton has allowed all the real difficulties and unavoidable disappointments

of the small holder's life to appear in his story. It is a book that everyone intending to start on a small holding should carefully read.

A B C de l'Apiculture. By A. I. and E. R. Root. Translated and edited by E. Bondonneau. (Paris: E. Bondonneau, 56, Avenue Félix Faure. Price 9 fr.—7s. 6d.)—This is the second edition of this well-known work, which has been brought up to date, and embodies the latest information contained in the American edition. The articles are arranged alphabetically in cyclopædic fashion, rendering the book an easy one for reference. The translation and editing have been carefully done by M. E. Bondonneau, the editor of *L'Apiculture Nouvelle*, who has introduced the description of many methods and appliances such as are more particularly adapted to European conditions. There are also articles which specially concern the commercial side of bee-keeping, as, for instance, the one on Customs duties (*droits de douane*), showing the duties payable on honey and wax when imported into different countries. A comprehensive list of flowering plants and shrubs visited by bees in Europe is also given, which will prove useful, especially where so much can be done in improving pasturage for bees. A novel feature in the book is the introduction of two coloured sectional models, one of the queen and the other of the drone, which will give bee-keepers some idea of the internal structure of each. A monthly calendar by M. J. Crépieux-Jamin ends the book, which is crammed full of useful information and illustrations in its 542 pages, and is a work that should find a place on the shelves of every advanced bee-keeper.

LINCOLNSHIRE B.K.A.

SHOW AT LOUTH.

The annual show of the above society was held at Louth on July 15 and 16, the honey department being under the management of the Lincs B.K.A. There were over 100 entries, but on account of the shortage in the season's honey crop only about half of these were staged. Moreover, the quality of the exhibits was not up to the standard of previous years, and this was especially noticeable in the classes for sections.

Mr. W. Herrod examined three candidates for third-class experts' certificates of the B.B.K.A., and also gave lectures and demonstrations at intervals in the bee-tent, which attracted large audiences.

Messrs. W. Herrod, F.E.S. (Luton), and F. J. Cribb (Retford) acted as judges, and made the following awards:—

OPEN CLASSES.

Twelve 1-lb. Sections.—1st, A. W. Weatherhogg, Willoughton; 2nd, Miss

M. E. Wilson, Great Canfield, Essex; 3rd, Miss F. E. Barker, Barnston, Dunmow, Essex.

Twelve 1-lb. Jars Extracted Honey.—1st, A. W. Weatherhogg; 2nd, Miss F. E. Barker; 3rd, J. H. Hadfield, Alford; 4th, F. W. Frusher, Crowland.

MEMBERS' CLASSES.

Twelve 1-lb. Sections.—1st, A. W. Weatherhogg; 2nd, A. H. Smith, Louth; 3rd, Rev. C. H. Murray, Partney; 4th, J. S. Thorn, Alford.

Twelve 1-lb. Jars Light Extracted Honey.—1st, W. J. Cook, Binbrook; 2nd, A. W. Weatherhogg; 3rd, Geo. Markham, Waltham; 4th, D. Seamer, Grimsby.

Twelve 1-lb. Jars Extracted Honey (other than light).—1st, F. Harris, Sibsey; 2nd, F. W. Frusher; 3rd, D. Seamer.

Twelve 1-lb. Jars Extracted Honey.—1st, W. Standen, Wellingore; 2nd, W. Townend, Utterby; 3rd, J. Balderstone, Authorpe.

Twelve 1-lb. Jars Granulated Honey.—1st, A. W. Weatherhogg; 2nd, R. Godson, Tothill; 3rd, W. J. Cook.

Bee-swar.—1st, F. Harris; 2nd, F. W. Frusher; 3rd, Wm. Patchett, Cabourn, Caistor.

COTTAGERS ONLY.

Six 1-lb. Jars Extracted Honey.—1st, W. Townend; 2nd, F. Harris.

APPLIANCES.

Observatory-hive.—1st, J. Lee and Sons, Highbury, London; 2nd, J. H. Hadfield; 3rd, E. H. Taylor, Welwyn, Herts.

Collection of Hives and Appliances.—1st, Jas. Lee and Son; 2nd, E. H. Taylor.

Complete Frame-hive for General Use.—1st, Jas. Lee and Son; 2nd, E. H. Taylor; 3rd, W. P. Meadows, Syston, Leicester.

New Appliance connected with Bee-keeping.—1st, W. P. Meadows.

Silver medal for comb honey (county and members of Lincolnshire Agricultural Society and Lincolnshire Bee-keepers' Association): A. H. Smith; bronze medal, A. W. Weatherhogg.

Silver medal for light extracted honey (same conditions): W. J. Cook; bronze medal, A. W. Weatherhogg.

W. B. CARR MEMORIAL FUND.

Amount already acknow- ledged	£	s.	d.
Jesse Garratt	1	1	0
W. A. Woods.....	0	5	0
L. B.	0	5	0
H. H. Bellers.....	0	5	0
P. Hansen	0	3	0
D. Hancox	0	2	6
Arthur Fox	0	2	6
E. Loxley	0	2	0
"Moreton Rectory"	0	1	0
F. W. Weller.....	0	1	0
	£52	1	6

PAPER HONEY PACKING-CASES.

Through the courtesy of the A. I. Root Co. we are able to give an illustration of the corrugated paper shipping-case described in the B.B.J. last week (page 273) by "D. M. M." This is not the one designed by Mr. Crane, but another make which is collapsible and can be delivered to customers in the flat.

That there is a demand for these "shipping cases," as they are termed in America, is shown by the favourable comments made by those British honey-producers to whom we have mentioned them. Some few years ago the Safety Paper Box Manufacturing Co. introduced cardboard cases to hold from one to twelve 1-lb. jars or sections, but probably owing to their not being advertised many bee-keepers have never heard that such packages can be obtained. However, now that the attention of bee-appliance

as to serve for winter passages?) from frame-tops, using the ordinary scraper "pushed ahead," it was apt to dig into the wood, mutilating the frame-tops. Of course it would when used (improperly) in the manner of a cutting-tool. To act as a scraper it should have been used with the blade vertical, or nearly so, to the surface scraped. In sharpening a lead-pencil, for instance, you lay the knife-blade at a low angle, *i.e.*, with small "clearance"; it then acts as a true cutting-tool; but if you wish to scrape the lead to a point you set the blade up on edge, *i.e.*, the clearance is 90 deg., and it then acts only as a scraping-tool. A better form of the hoe-scraper mentioned is one having a triangular blade, with three edges instead of one, all of which are equally effective.

Swarms versus Stocks.—Desirous, perhaps, of saying a good word for South of

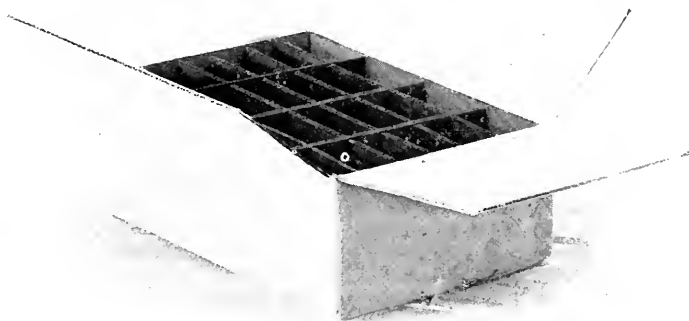

CORRUGATED PAPER SHIPPING-CASE.

dealers has been drawn to the matter we shall no doubt soon be able to procure them in this country at a reasonable price.

Correspondence.

The Editor does not hold himself responsible for the opinions expressed by correspondents. No notice will be taken of anonymous communications, and correspondents are requested to write on one side of the paper only, and give their real names and addresses, not necessarily for publication, but as a guarantee of good faith. Illustrations should be drawn on separate pieces of paper. We do not undertake to return rejected communications.

CURRENT TOPICS.

[7534.] *Scraping Frames.*—I notice your correspondent "D. M. M. (Banff)" says that in scraping brace-combs (how is it he has them so thick and "tall" on his frames

England swarms, "D. M. M." a short time ago stated that some he purchased in 1907 had beaten several of his stocks at honey-gathering that season. Now, I submit that the way a beginner would be apt to take this statement, and the way an old hand would read it, would be two very different things. To the beginner it would imply that swarms were superior to stocks in honey-getting. On the other hand, the experienced bee-keeper would simply infer (and rightly so) that those stocks (of "D. M. M.'s") were very poor ones to allow the swarms to beat them. Such statements, without proper qualification, are misleading to the novice. No swarm in my experience can rival, much less surpass, a first-class normal stock in good honey-getting trim. Such a stock is already far ahead of the swarm when the latter is hived, and it is too much of

a "stern chase" for it (the stock) ever to be overtaken. When the reverse of this appears in some measure to be the case it only denotes poor management resulting in poor stocks. In the foregoing remarks I refer entirely to the main or clover harvest.

Overrated.—One of the things which I think are considerably overrated in bee-keeping is the superior energy of a swarm. I do not, from observation, think this extra-working power is apparent after the first few days at most, when the swarm settles down to work just in proportion to its strength, like any other stock.

Another overrated thing in my opinion is toughness (with accompanying hardness) in comb-foundation. It seems to be altogether overlooked that excessive toughness and hardness is a great hindrance to the bees in working the foundation out into comb. It may almost be laid down as an incontrovertible law that "any increase of toughness with hardness beyond what is necessary to prevent stretching of the cells, &c., under the weight and heat of the bees is a positive detriment to both bees and bee-keeper."

Levelling of Hives.—Great stress is laid on the need for levelling hives in order to produce well-built sections, &c. Thus "D. M. M.," with the perfect innocence of the professional man (quite often a characteristic of such) tells all and sundry to be very careful to level the hive accurately if they would secure perfect sections. Now, although personally I level all my hives with a spirit-level, it is not because I believe that extreme accuracy is essential to the above-mentioned purpose, but in a great measure because I must do the thing in a workmanlike way, and will not on any account have my hives "looking all ways for Sunday." With regard to sections, if the hive is a little out of level lengthwise of the sections it will probably have no effect whatever on the comb-building. If even on the contrary it is a little out across the sections, it can have but small effect on the "hang" of the foundation. Will "D. M. M." tell us how far from the perpendicular the small sheets of foundation will deviate, supposing the hive requires the thickness of a piece of section ($\frac{1}{8}$ in.) under any pair of legs in order to make the rack of sections perfectly level (across the sections)?

On the Use of a Block in Securing Square Sections.—Many people advise the use of a block in folding sections, first to prevent breakages, and second to ensure the squareness of sections. Now, as far as the latter idea is concerned, the block is totally ineffective, and for the following reasons: On folding a one-piece

section there appears to be an unequal tensional strain set up in the joints, which tends constantly to throw the section out of square in many cases, so that the instant it is released from the block it goes over (more or less out of square) until this strain is relieved or equalised. This tendency may be partially overcome by "racking" the section over in the opposite direction; but the best cure is to use a rack which forces the sections to assume a square shape. As far as the danger of breaking sections when folding is concerned, I may say I have, with previously damped joints, folded a thousand consecutively without a single breakage.

In fitting foundation into split-top sections there is often a marked tendency of the sheet to either buckle or twist, owing, perhaps, to unequal grip of foundation in the groove or other occult cause, and if those who think they have, by manipulation with the fingers, permanently set these sheets straight, will look at them a short time afterwards, they will find in nine cases out of ten that the said sheets have, in the most perverse and obstinate manner, gone back to their former position. I know of no perfect cure in this case.

An Instinct Common to Queen and Workers.—I do not know whether the following occurrence has ever been noticed before, but I have never seen any mention of it in the books and journals that I have read. It is an act which proves that the queen has at least one instinct in common with the workers, as, indeed, might be expected seeing that they are both hatched from the same eggs. On July 8 last I was hiving a second swarm, and after the bulk of the bees had entered the hive I noticed the queen parading about among a handful of bees on the hiving-board, about 1 ft. from the entrance. She appeared as though trying to hide among the bees; but suddenly she evidently got the "call" from the fanners at entrance, and forthwith marched straight for the latter. Arriving there, she stopped in line with a number of workers fanning vigorously, elevated her abdomen, exposing the scent-gland, and "fanned" in exactly the same manner as the rest.—SAML. P. SOAL, Rochford, Essex.

ROSS-SHIRE NOTES.

[7535.] It is now the third week of July, and not a single section sealed over yet! Why, this beats 1907. Bees are strong and forage abundant, but the weather is so erratic that our stocks cannot work to advantage. The strongest have each filled a rack, and are comb-building in the second, placed on top of the one previously given. In this way, if the clover crop is short, we get it all

in the one super and saleable, while the rack of drawn-out combs will come in handy at the heather.

My most forward stock—curiously enough—is one that was wintered with three racks of partly-stored sections above its brood-frames. This disproves the idea that bees need lots of packing for winter. In this case the stimulus from the store-house above more than counterbalanced the lack of warmth below.

The supers were removed in May and two of them replaced by mid-June. The colony then had eleven frames of brood, but has now both racks well filled, and is ready for a third. No swarms have been heard of in this district as yet, which is surprising, as the season has been favourable for brood-rearing. I have an Italian stock covering twenty-eight frames, with brood in seventeen of them. That means a large population for the moors. An immense force of gatherers in a relatively small brood-nest makes for success at the moors.

I should be glad to hear how "Medicus" and other exponents of the divisible hive are preparing for the last stand amongst the purple heather.—J. M. ELLIS, Ussie Valley, July 19.

IS THIS THE ISLE OF WIGHT BEE-DISEASE?

[7536.] Will you kindly tell me what is wrong with the bees I send you? All the books on bees and all the practical experience hereabouts cannot find a name or a cure for a mysterious malady that has broken out in this part of Banffshire. A few other apiaries besides mine are similarly affected. It is not dysentery, because all the hives are clean—no trace of droppings nor anything of that kind. It is not paralysis, because the affected bees run about all over the place. I will give you a description of the trouble. Frequently, and especially on a very fine day when all the bees are out in full force and honey is being poured into the hive, one may see a bee come rapidly out of the hive and, instead of taking wing, walk over the edge of the alighting-board, and upon reaching the ground start to run about as if demented, with its wings outspread, making a jump every few feet as if it wanted to rise into the air. After running about in this way for, say, about ten minutes, it will stop and commence to stroke itself about the head and wings. Sometimes a few of the affected bees gather together into a bunch and stroke each other. They will remain like this, as far as I can observe, for about an hour or more—in a few cases only twenty minutes—and will then fall over on their backs and die. Upon taking up a seemingly dead bee and gently pressing

it, it will show signs of life by kicking out its legs. As I have said, it is only upon an exceptionally fine day that the greatest mortality occurs, and upon a medium working day perhaps only half a dozen bees will be found affected. I have consulted some of the best bee-experts hereabouts, and have read up all the standard books, including "The A B C of Bee-Culture." My hives are all in extra good condition, and supers are being filled; in fact, the hives are simply packed with strong working bees. This trouble has continued now, with an occasional day's interval, for nearly a fortnight. I put the usual piece of naphthaline into each hive ten days ago, so that if there was any trace of disease it would be checked. A week ago I made up some syrup of best loaf sugar and fed each hive. In fact, I have done everything I know of as prevention and cure for possible diseases. I had hopes yesterday, as the bees worked only half the day without any sign of trouble (the other half was rainy), that it was stopped. But to-day, one of the finest bee-days we have had, it is worse than ever, and bees are dying by hundreds. I therefore decided to write to you about it, as two other apiaries in my immediate neighbourhood are similarly affected. Is it possible on an exceptionally fine day for bees to work so hard as to be unable to fly owing to over-fatigue? I enclose a few bees which had just commenced to run about and a few dead ones picked up from the ground. I have dissected, examined, and studied the diseased bees, and cannot make anything of it, so you will be doing both myself and the other bee-keepers a great kindness if you can discover what is wrong and suggest a remedy.—HENRY JOHN WATSON, Banff.

[This is one of several letters we have had from different parts of the country, and although the symptoms are not all alike, they agree in the fact that the bees are not able to fly and die off in this mysterious fashion. The bees sent to us, which generally arrive dead, show no signs of disease, and a diagnosis can only be made by observing the general behaviour of the stock. The symptoms in many diseases which are amenable to treatment are very similar, but as this disease does not seem to yield to the treatment which is successful in paralysis and kindred complaints, it is probable that it is similar, if not the same, as that which was so prevalent in the Isle of Wight, and for which at present no remedy is known. Dr. Malden has the disease under investigation for the Board of Agriculture, but, of course, it takes considerable time to arrive at definite conclusions. In the meantime, as the

disease is very contagious, we would advise, where bees are seen to behave in the way mentioned above, to destroy them and their combs and disinfect the hives, and water the ground where the bees have died with a solution of No. 5 Calvert's carbolic acid—1 oz. in 2 quarts of water—picking up the dead bees, which should be burned. There is no doubt but that the unfavourable weather we have been having lately has been conducive to the breaking out of diseases, but it is remarkable that the one under consideration should, like influenza, appear simultaneously in districts so far apart as Banffshire in the North and Hampshire in the South, as well as in several intermediate counties. We therefore advise our readers to be on the watch, and as soon as the disease makes its appearance to take prompt measures for its extermination.—Ed.]

MIDLAND NOTES.

[7537.] Bees here in the Midlands have been confined to their hives during the greater part of the last five weeks, with the result that stores have increased very little, while some stocks have even had to be fed to keep them going. We have been occasionally favoured with a few hours' sunshine, which brought out the bees in thousands, and the spirits of the ever-hopeful bee-keeper were raised high only to be dashed to the ground again, for almost invariably enough the clouds began to obscure the sky, and before night rain was again falling. However, a welcome change in the weather appears to be coming at last, for to-day we have had beautiful sunshine, and the bees have been working, as if for dear life, right up to 7 p.m. The barometer is steadily rising, and, unfortunately for the bee-keeper, farmers are now cutting their grass in earnest, after two or three weeks' delay caused by the unsettled state of the weather. This will soon begin to tell its tale on the white clover crops, from which our bees are now gathering the greater part of their nectar.

It appears that the season will at the best be only a moderate one in the Midlands, though bees were very forward in the spring.—F. E. MATTHEWS, Northfield, July 12.

RESPECTING PARTHENOGENESIS.

[7538.] With reference to the subject of parthenogenesis, now so much discussed, I shall feel very grateful if you will kindly say in your *BRITISH BEE JOURNAL* where exactly Dzierzon published his theory: "To lay drone eggs requires no fecundation at all," and "all eggs in the ovaries of queens are of the same kind." I understand that the pub-

lication was originally in *Bienenzeitung*. Perhaps you can kindly give the exact references and oblige.—H. WATTHMAN, N. Devon.

[The quotation will be found in "Theorie und Praxis des Neuen Bienenfreundes," by Dzierzon, 1848, page 11. He previously wrote in the *Bienenzeitung* of Eichstadt for 1845, page 113: "I express the conviction, from which all phenomena and mysteries may be explained, that the drone-eggs do not require fecundation."—Ed.]

ISLE OF WIGHT BEE-DISEASE.

[7539.] I send you a few more live bees and a small piece of diseased brood-comb from one of the hives I mentioned in my letter (page 255, B.B.J., July 1), and trust that some of the bees may reach you alive. They were all taken off the frame the small piece of comb was cut from yesterday, and now appear to be quite lively. Those I sent you before were as lively as possible, apparently, at six o'clock the evening before you would receive them, so that they died and decomposed in quick time. You appear to have misunderstood my previous letter somehow, for in your editorial on page 251 you seem to be under the impression that the stock was suffering from foul brood first. This was not so, for in early April, and for a week or two after, it was a wonderfully good and sound stock, had then, and has at present, about seven frames of brood, and is at about same strength as regards bees as it was then. The first time I noticed anything amiss was about the end of April or early in May, and I then noticed a few odd raised, unsealed cells amongst otherwise perfect slabs of worker-brood. These I took at first sight to contain drone-brood, as they were raised about a sixteenth of an inch above the others; but on closely examining them I found they contained dead larvæ. The heads of all could be seen and were slightly discoloured. It appears to me that in their last dying stage they had stretched out, as most dying larvæ do, and the bees had built out the cells a little in consequence, so as to cover them before sealing. A few were only partly sealed over. For some weeks no small grubs were attacked as in ordinary foul or black brood. It was in June before I noticed any, and then only a very few. There is not a perforated cap in either stock. I could not send you bees from off the ground in front of this hive, for there have been none for some days. The weaker stock (the one which showed the disease first) appears to be recovering, for they are storing honey slowly and increasing in bees. They have built out a full comb within the last fortnight, and are quite crowded now. New honey is

doing this I expect. If the Journal about twenty-five years back is searched, I think there will be found a communication from me regarding an exactly similar disease to that of the Isle of Wight. It was the cause of my losing somewhere about twenty stocks; but I did not allow it to spread by robbing, for as soon as I suspected the food I took all away I possibly could. No other bee-keeper had it in the neighbourhood, and there were plenty of them near me; but I was at that time the only one within a radius of five miles whose bees had been moved to and from the heather, and the only one also who had introduced foreign queens. At the time I blamed the going to and from the heather for the disease. Now I am inclined to think it was imported by the foreign queens.—A. SIMPSON, Chalfont St. Giles.

[Some of the bees have reached us alive and do not show any signs of being diseased. The bees in the piece of comb were also hatching. Those sent before were not received the next morning, as owing to my being absent from London they had to be forwarded, but they were already dead when they reached the office. There are two forms of foul brood—in one the young larvæ die before they are sealed over, and in the other death takes place when the larvæ are full grown, and are generally sealed over. Both these may be present in a hive at the same time, together with sour brood. According to Dr. Maassen there is a struggle for supremacy between the bacilli of the two former, the one getting the mastery over the other. New honey coming in is known to have a remarkable influence in helping in the cure of diseases, and it is quite probable that the improvement you now notice is due to this. If you could help us with the title of your communication of twenty-five years ago we would look it up, but at present have failed to find it. There are, however, two references in B.B.J. of 1882, on pages 78 and 103, which are entitled "Poison, or a New Disease," which describe symptoms similar to those of the Isle of Wight disease. The disease, on very good grounds, was attributed to unwholesome food, and by destroying the bees and combs of affected stocks the malady was got rid of. With the bad weather we have been having and the quantity of honey-dew about, it would not be surprising to find bees starving or dying from unwholesome food.—Ed.]

BEE-KEEPERS AND FOUL BROOD.

[7540.] I quite agree with Mr. Newman (page 244) about compelling all bee-keepers to be clean and sanitary; but what would he do in the following case? An expert friend of

mine while on a tour for the county association visited certain bee-keepers in this district, whose apiaries, I know for a fact, are affected with foul brood. I am sorry to say he was flatly refused admission amongst the bees.—J. G. E.

THE SEASON IN MID-CORNWALL.

[7541.] I have just been glancing over my record of the past nine years, and find that the spring of 1909 was the best during that time. Swarming preparations by the bees were pretty general, but swarms not being desired from some of my hives, nor a surplus of spring honey either, queens were given the range of twenty-two standard frames with the "hope" (see page 278) of a bumper clover crop. June has in this part been the worst ever experienced, and the first half of July expires as fickle as the wind. I was appealed to to-day for some exhibits to help along a show, to-morrow being the last *extended* day; but it is blowing a gale, and hives cannot even be opened. Brother bee-keepers will do well to foster the fine spirit of a correspondent who wrote two years ago in the B.B.J.: "When God is sorting out the weather and sends rain, then rain's my choice." It is said "Hope never dies in a bee-man's breast," and this is certainly a valuable asset this year.—J. M. BEST, Trewoon Apiary, St. Austell.

AMERICAN AND COLONIAL PAPERS.

EXTRACTS AND COMMENTS.

By D. M. Macdonald, Banff.

Pleasures of Bee-keeping.—A writer in the *American Bee Journal* says: "More than half of the pleasures of bee-keeping to many of us is the ceaseless study which the bees afford. We like to get bumper crops of honey, and we prefer that our bees secure a profitable surplus every year; but we get extremely keen enjoyment in mastering the problems of which the hive and the honey-bee furnish such an unending stream." How very many perplexing but pleasant problems do turn up at every season of the year; there is an unending stream of them, each one more engrossing than its predecessor. I feel that while life lasts new enigmas, pregnant with enthralling delight in the solving, will continue to present themselves.

Non-swarming Bees.—Mr. Dadant, in an article on this subject, cites a large number of writers to support his conclusions "that the matter of prevention of swarming does not depend on any one race of bees" (page 205), and Mr. Aikin says (page 210): "We have been talking for over thirty years about breeding-out

the swarming impulse, but bees are going to follow instinct, and that elusive thing—or rather unexplainable thing—is influenced by conditions of environment. The swarming impulse lies in conditions under which the colony finds itself, not in the blood of bees that have forgotten how. No specific rules are applicable except those related to environment.” This, I think, if true, is only partly true. Take the three points Mr. Dadant emphasises—large hives, production of extracted honey, and house apiaries. None of these are in use here, yet swarming does not exceed 2 to 5 per cent.

Queenless, yet Carrying Pollen.—Until about two years ago I was under the impression that a stock in spring carrying in pollen was certain to have a queen, and I had heard repeatedly that pollen-carrying was a sign that the stock possessed a queen. Last spring and this I have had proof positive that queenless bees will carry in at times large quantities, but their conduct shows all the same that there is something wrong. Dr. Miller, in last *Gleanings*, draws attention to both of these points, and Mr. Root is confident “queenless bees do carry in pollen, and under some conditions a good deal of it; but queenlessness should be tested by the general activity at the entrance, associated with the presence of pollen-carrying.” Thus judged, the action of the two lots of bees is distinctly different. I have had some experience of queenless hives this spring, and have made several particular observations.

Smell as an F.B. Index.—I think too much is being made of this. Of course, when the disease assumes a pronounced form the strong, sickly odour is unmistakable; but this is only when the pest has taken a firm hold, and most probably when the more deadly spore stage has been reached. But—and this is important—the trouble may be rampant in a hive, and yet no distinct odour may be discernible. While, therefore, the smell is an index to the presence of foul brood, it is not an infallible one.

Building Up Weaklings.—Mr. Byer, Canada, gives us the following simple and apparently feasible plan for carrying out this operation successfully. From a very strong colony carry over a frame or more with adhering bees, and shake them down before the weakling, having first provided a platform for the bees to walk into the hive. The old bees at once fly back to the old stand, but the young ones walk into the hive you want to strengthen, giving the very best kind of help that it is possible to get. More than one colony can be drawn upon, and it is surprising to note the difference in the weakling in a few days' time—no brood chilled, no

queens lost, no fighting; in fact, no trouble of any kind, and you are absolutely sure of the plan being a success every time. After a limited trial I found it quite a success.

Frequent Extracting.—Mr. Facey, in the *Review*, puts in a plea for carrying out this operation frequently during the gathering season. “The rapidity with which bees will fill emptied supers after an extracting is often amazing,” he remarks, and he considers that here is a means of increasing the bees' energy under the inspiration of work. “The man who gets the most honey is the man who can hold his bees at the highest tension, and if this were done the average yield per hive would be more than doubled.” This beats “shaking.” I should fear, however, the result of so constantly extracting would be large quantities of “green” honey on the market. Honey ripens nowhere else as it does in the hive.

Supering and Controlling Swarming.—Elmer Hutchinson gives his mode of procedure as follows: Early in the season a super is placed above the brood-body to which the queen has free access. Then he makes up supers when the main flow approaches with eight frames in a ten-frame body. One of these he puts on each hive above excluder zinc. The combs of the first super just removed are shaken clear of bees at entrance, and the frames are then placed in the hive above the newly-placed super. He says: “By doing this I get three things. First, I get the queen below; second, I get any benefit secured by shaking bees; third, I split the brood-nest in two, filling the space between the two sections of brood with empty comb, which seems to give surplus-room just where it is needed to keep down the swarming impulse.” The idea seems a good one.

Bee Shows to Come.

July 28, at Dean, Hants.—In connection with the Dean and District Horticultural Show. Open classes for honey. Single 1-lb. jar, single 1-lb. section. Schedules from H. C. Knapman, Estate Office, Norman Court, Salisbury. **Entries close July 24.**

July 28, at Nether Wallop.—In connection with the Horticultural Show. **Entries closed.**

July 28, at Upwell, Wisbech.—Horticultural Society's Show. All exhibits will receive careful attention. Open classes for Honey, including gift class for 1-lb. Jar. Schedules from Hon. Secretary, J. Hy. Inman, Upwell, Wisbech. **Entries invited.**

August 2 (Bank Holiday), at Cambridge.—Honey Show, in connection with the Cambridge Mammoth Show Society. All Open Classes. Four Special Hives to be competed for. This show also includes Dogs, Poultry, Pigeons, Cats, Rabbits, Cage Birds, Flowers, Fruit, and Vegetables. Also grand programme of Sports. The World-famed “Besses o' th' Barns” Band has been specially

engaged. Schedules from Hon. Sec., Mr. E. F. Dant, Member of B.B.K.A., 52, Bridge Street, Cambridge. Entries close July 28.

August 2 (Bank Holiday), at Clewer, Windsor.—Show of Honey and Appliances by the Windsor Branch, Berks B.K.A., in conjunction with the Clewer Horticultural Society. Schedules from Hon. Sec., Mrs. W. S. Darby, 1, Consort Villas, Clewer, Berks. Entries close July 28.

August 2 (Bank Holiday), at Melton Constable.—Annual Honey Show of the North Norfolk B.K.A. Four Open Classes, including one for Single 1-lb. Section and one for Single 1-lb. Jar of Honey. Schedules from C. J. Cooke, Edgefield, Melton Constable. Entries close July 24.

August 4 and 5, at Abingdon Park, Northampton.—Honey Show of the Northants B.K.A. Special prizes for open classes, including one for single 1-lb. jar honey. (Entry free.) Judge, Mr. W. Herrod. Prizes 20s., 10s., 7s. 6d., and 2s. 6d. Schedules from R. Hefford, Hon. Sec., Kingsthorpe, Northants. Entries close July 28.

August 5, at Madresfield, Malvern.—Annual show of the Worcestershire B.K.A. Open class for collection of Bee-products. Prizes 20s. and 10s. Schedules from Mr. George Richings, 2, Shrubbery Terrace, Worcester. Entries close July 31.

August 10, at Holyhead.—Annual Honey Show of the Anglesey B.K.A. Open classes for 1-lb. Jar of 1909 Honey, prize 10s. 6d., entry fee 1s. 6d.; for Honey Trophy, open to all North Wales, prizes 21s., 10s. 6d., entrance fee 2s. No second prize given unless three or more compete. Schedules from Rev. O. Kyffin Williams, Llangwyllog, Anglesey. Entries close July 25.

August 10 to 12, at Beverley.—Show of Honey, &c., in connection with the Royal Yorkshire Agricultural Society. Entries closed.

August 11, at Wye (Kent Honey Show).—Five Open Classes: Trophy, cup value £3 2s. (entry 1s.), 1 lb. Section, 1 lb. Light Run, 1 lb. Dark Run, 20s., 10s., 5s. in each case (entry free); Beginner's Outfit, to retail 30s. (entry free). Fifteen Classes open to Kent: Two Challenge Cups, value £6 6s., and money prizes for 6 1-lb. Sections and 6 1-lb. Jars Extracted Honey. Money prizes for 5 Jars Light, 6 Jars Medium, 6 Jars Dark Extracted Honey, 2 Shallow or Standard Frames, 3 Sections and 3 Jars, 1 Jar Granulated, Beeswax, Mead, Candy, Cake Sweetened with Honey, Display of Cut Flowers, &c.; two Special Classes for Cottagers. Schedules of J. Tippen, Secretary, Wye, Kent. Entries close August 2.

August 18, at Lancaster.—Lancaster Agricultural Society, in conjunction with the Lancashire B.K.A. Fifteen Classes for Honey and Bee-produce; also for Bee-hives. Numerous special prizes, including two silver challenge cups, twelve silver and bronze medals, &c. In applying, state Honey Schedule required. Thos. Armistead and Son, Secretaries, Lancaster; or J. M. Bold, Almonds Green, West Derby, Hon. Sec. Lancs B.K.A. Entries close August 4.

August 18 and 19, at Shrewsbury.—Annual Show of the Shropshire B.K.A., in connection with the Shropshire Horticultural Society's Great Floral Fête in The Quarry. Nine Open Classes for Honey and Wax. Schedules from S. Cartwright, Shawbury, Shrewsbury, Hon. Sec. Entries close August 6.

August 19, at Salisbury.—Annual Show of the Salisbury and District B.K.A. Five classes open to the United Kingdom, including Single Section and Single Bottle. No entry fee. Schedules from Hon. Sec., J. E. Pinder, Salisbury. Entries close August 11.

August 21, at Elworth, Sandbach.—In connection with the Elworth Athletic Club and Horticultural Society's Show. Class for Honey open to the County of Chester. Prizes: 1st, 15s.; 2nd, 7s. 6d.; 3rd, 5s.; for 12 Jars Run or Extracted Honey; also Bronze Medal given by the Cheshire Bee-keepers' Association. Entry fee, 1s. Schedules from E. Jones, Hon. Sec., Elworth, Sandbach. Entries close August 14.

August 25, at Brislington, Bristol.—Annual Show of Honey, Wax, and Appliances of the Somerset B.K.A. Extended Schedule and increased prizes. Seven open and two free classes. Schedules

from Mr. James Brown, Show Sec., 31, Bridge Street, Bristol. Tel. 21767. Telegrams, "Brown, Bristol." Entries close August 21.

August 25 and 26, at Stratford-on-Avon.—Annual Show of the Warwickshire B.K.A., in connection with the Warwickshire Agricultural Society. Schedules from J. N. Bower, Hon. Sec., Knowle, Warwickshire.

September 1 and 2, at Carlisle.—First Annual Show of the Cumberland B.K.A. Ten Open Classes (including Honey Trophy) for Honey, Hives, and Wax. Liberal Money Prizes in all Classes; also the C.B.K.A. Certificate of Merit to best exhibit in each class. Schedules from G. W. Avery, Hon. Sec., Heads Nook, Carlisle. Entries close August 18.

September 13, at Conway, N. Wales.—Annual Honey Show, in connection with the Conway Honey Fair. Open and local classes. Schedules from J. Hughes, Town Hall, Conway. Entries close September 6.

September 16, at Castle Douglas.—In connection with Dairy Produce Show, the annual show of the South of Scotland Bee-keepers' Association. Open Classes for three 1-lb. Jars (20s., 10s., and 5s.); three Sections (20s., 10s., and 5s.); entry, 2s. One Jar (5s., 3s., and 2s.); one Section (5s., 3s., and 2s.), entry free, but exhibits forfeited unless otherwise arranged. Beeswax (5s., 3s., and 2s.); entry 6d. Thirteen Classes Confined to Members. Numerous prizes, including two Challenge Cups and gold and silver medals. Schedules from Q. Aird, Hardgate School House, Dalbeattie, N.B. Entries close September 4.

September 16, 17, and 18, at Crystal Palace.—Surrey B.K.A. Annual Exhibition of Bees, Honey, Wax, Appliances, &c. Twenty-seven classes (nine open to all). Many medals and increased prizes. Schedules from F. B. White, Secretary, Marden House, Redhill, Surrey. Entries close September 1.

September 22, at Altrincham.—Honey Show, in connection with the Altrincham Agricultural Show, the largest one-day show in the Kingdom. Classes open to United Kingdom. Classes for Trophy of Honey, for Best Hive, Observatory Hive with Bees and Queen, twelve Jars of Extracted Honey. Classes open to County of Chester, for Run and Section Honey, Wax, &c. Special Classes for Cottagers, and Special Classes for Society's District. Good prizes, low entrance fees. Schedules from Mr. J. Herbert Hall, 2, Dunham Road, Altrincham. Entries close September 4.

Queries and Replies.

[3957.] *Clipping Wings of Queen.*—Having several stocks of bees situated close to the premises of a neighbour who is, unfortunately, very disagreeable, I have been much troubled by my bees swarming on his trees. I am anxious to prevent the recurrence of this another season, so would you or some B.B.J. reader kindly advise me how much of the wings—and whether the upper or lower ones—should be cut off to prevent the queen taking flight? I presume the clipping would not be injurious to the queen or absolutely prevent her from leaving the hive with a swarm, but that on doing so she would fall to the ground, when the swarming bees would cluster round her. This would suit my purpose well, as someone would always be at hand to hive them at once. I don't wish to make artificial swarms, neither do I want to prevent swarming altogether. Any information or advice, for or against, will be appreciated.—A. C., Tewkesbury.

REPLY.—Catch hold of the queen's thorax with the finger and thumb, slide these off, pressing them together, which will enable you to take hold of the wings. One of the blades of the scissors is then slipped under the two wings of one side, and they are then cut off as short as convenient. It is not absolutely necessary to clip both the wings on one side, as the queen is just as helpless with

only the larger wing cut, but she is much easier to find when she is running across the combs if both wings on one side are clipped off. The clipping is not injurious to the queen, and there is no danger of losing her if someone is at hand to give the bees.

[3958.] *Glazing Section*.—Will you kindly give me instructions in the B.B.J. how to glaze sections, as I have not seen any done? I enclose name and sign—SALOPIAN, Bridgnorth.

REPLY.—Remove the completed sections from the rack, and scrape off all propolis from the wood. Then put a piece of glass-paper on a block of wood and rub down the sides until they are quite clean. Place a square of glass on one side of a section, and paste a strip of lace paper, made specially for the purpose, round the edge, fastening the glass to the wood. The lace paper must not project more than three-eighths of an inch over the glass, otherwise at an exhibition it would be disqualified. When one side is done, repeat the operation on the other side.

Notices to Correspondents.

Iste of Wight Bee Disease.—The Rev. A. Arthur Headley informs us that he is afraid there is a suspicious case of this disease at Old Alresford.

MR. GEO. ROSE (Liverpool) asks us to say that as the weather has been so unfavourable for photo work, he is extending the time for entries for his picture competition to September 30.

E. H. A. (Sheffield).—*Strange Behaviour of Bees*.—1. The unknown insect which you mention on the queen is probably *braula cæca*, the blind louse, but we could tell better if you sent a specimen. It is described on page 169 of "Guide Book." 2. With such weather as we have been having, bees are unable to gather sufficient to keep them going. There has also been much honey-dew collected, which, if not mixed with a large proportion of honey, is unwholesome and is not a fit food for bees. We have known bees under such conditions improved by being fed with warm sugar-syrup poured into the combs if they do not take it from a feeder. The hives should also be well protected from the cold.

W. C. R. (Wicklow).—*Moving Bees from Ireland*.—The neighbourhood of Taunton is very good for keeping bees, but we would advise you not to bring your bees with you as the district where you are going is free from foul brood. Your best plan would be to sell your bees and commence with swarms, and run no risk of bringing the disease (from which your bees are suffering in a mild form) with you.

WHITE STAR (Cheshire).—*Keeping Bees*.—It is quite possible for you to keep bees under the conditions mentioned, as there is little to do in winter, and bees should be left alone then. Your only difficulty will be in summer during swarming time, as you may lose swarms if there is no one to give them. Swarming may, however, be prevented by giving the bees plenty of room in advance of their requirements.

J. W. L. (Kewick).—The matter in queen-cell is merely "Royal jelly," the special food provided by the bees for feeding embryo queens. No disease.

H. C. (Bramber).—*Suspected Disease in New Comb*.—There is nothing in the sample of comb but freshly gathered pollen.

E. M. (Beaconsfield).—*Names of Flowers*.—1. Red dead nettle (*Lamium purpureum*). 2. Marsh thistle (*Carduus palustris*). 3. Greater centaurea (*Centaurea scabiosa*). 4. Prunella (*Prunella vulgaris*). Bees work on Nos. 2 and 3, and sometimes on No. 1.

DR. MANUEL DA ROCHA AMORIM (Portugal).—*Sample of Honey*.—The glass containing the honey arrived in fragments without a particle of the honey, which had saturated the wrapper in which it was packed. There are several dealers who advertise in B.B.J. for honey, and that from heather is generally saleable, if good. We cannot mention the value without seeing the honey.

AN ENQUIRER (Bridge of Allan).—*Young Bees Dying*.—The bees are young ones, and appear to have died from insufficient or improper food. Try giving them some warm syrup, and examine to see if there is anything amiss in the hive. Old combs should not have the effect produced. We should be pleased with a description of your case of a young queen mating twice.

Honey Samples.

IJEJA (Herefordshire).—The honey is of good flavour and free from honey-dew, although rather dark.

F. R. (Sutton).—Honey is gathered from mixed sources, but contains enough honey-dew to spoil it for table use.

Special Prepaid Advertisements.

Twelve words and under, Sixpence; for every additional Three words or under, One Penny.

TO ALL WHOM IT MAY CONCERN.—In the B.B.J. of July 15, page 275, a letter appeared headed "A Profitable Queen." This Queen was bred at my apiary at Ilminster, and there are more to be had. Buy the "right strain," and incidentally support British industry. Queens like this are dirt cheap at their price.—D. TAYLOR, Ilminster.

DRIVEN BEES, strong, healthy lots, with 1909 Fertile Queens, for early August delivery; also a few spare 1909 selected laying Queens, 5s. 6d. each; post free. — T. BRADFORD, Bee Expert, Worcester. s 32

FOR SALE, 3 strong frame Stocks, moved into brand new uniform hives, 30s. each. Exchange good gramophone.—77, Ladywood-road, Birmingham. s 27

NEW HONEY IN BULK, 56s. cwt.; Screw-cap Jars, 8s. 6d. dozen; half-jars, 4s. 9d. dozen; sample 2d., on application.—CHARTER, Tattingstone, Ipswich. s 40

HEALTHY DRIVEN BEES, with 1909 Queens, 3s. 9d. and 5s. 6d. per lot; boxes free; August delivery guaranteed. Write at once; orders rotation.—NEWLANDS, Itchingfield, Horsham. s 36

10 IN. "EMPIRE" LAWN-MOWER, as new. Exchange Driven Bees or Swarms.—"St. Elm," Carshalton-lane, Coulsdon, Surrey. s 39

STRONG STOCKS, with 10 Standard Frames of Brood and Stores, 21s., 1909 Fertile Queen; 3-Frame Nucleus, with 1909 Fertile Queen, 10s. 6d.; Stocks in Straw Skeps, 12s. 6d., guaranteed healthy.—W. WOODS, Normandy, Guildford. s 46

DRIVEN BEES, properly packed, 5s. 6d.; Queens, 2s. 6d.—152, Astwood-road, Worcester. s 48

SET OF SIX TELESCOPIC TIN BOXES, for carrying Driven Bees on bicycle, cost 21/-; price 16s.—EXPERT, 35, Lansdowne-crescent, Cheltenham. s 30

17TH YEAR.—Healthy Driven Bees, commencing August 5, 5s. per lot, on rail; 5s. 9d. parcel post; with young fertile Queens. Orders in rotation.—SOLE Expert, Stotfold, Beds. s 47

HEALTHY DRIVEN BEES WANTED EARLY, 1s. per lb.—D. HUNTER, Craighead, Abingdon. s 38

EXTRACTORS.—The "Wharfedale," second prize Royal Show, 1909, silent gear, extracts 4 Shallow Frames and Combs reversed, without withdrawing. See report last week's "B.B.J." Price £1 5s.—HESELDIN, Bramhope, via Leeds. s 25

Editorial, Notices, &c.

PROHIBITION OF THE IMPORTATION OF BEES, HONEY, AND BEESWAX INTO THE TRANSVAAL.

The secretary of the Transvaal Beekeepers' Association sends us a copy of the *Transvaal Government Gazette Extraordinary* of May 4, which contains the text of a Bill to provide for the importation of bees, honey, and beeswax into the Colony.

It is proposed that after the coming into operation of the Act no person shall import, or cause to be imported, into the Colony:—

(a) From any place whatever bees, without special permission of the Department of Agriculture.

(b) From any place outside South Africa honey or beeswax.

(c) From any place outside South Africa used bee-hives, or used bee-hive accessories, or appliances, or anything which has been used to contain or manipulate bees or beeswax.

The Bill further provides that the Governor may appoint officers to inspect consignments of bees and goods admitted on permission, and also to appoint officers to inspect any apiary or place where bees are kept, or any honey or beeswax which is intended for sale, and to cause to be cleansed or disinfected any apiary or place where bees are kept if disease is found to exist therein; also to cause to be destroyed any bees, honey, or beeswax imported in contravention of the Act or regulations, or found to be affected with disease.

Any person contravening the Act or regulations will be subject on conviction to a fine of £50, or, in default of payment, to imprisonment, with or without hard labour, for six months, or to both fine and imprisonment.

The Governor may allow by proclamation the importation of bees from any South African Colony if similar legislation exists therein, under similar penalty, prohibiting the importation of bees, except under special regulation.

PROGRESS IN CUBA.

As there is a growing interest in the United States, Canada, and England relative to Cuba and her resources, the Government at the beginning of the present fiscal year established a Bureau of Information. All persons wishing data concerning Cuba, her resources, business opportunities, agricultural and industrial advantages, or any other information relative to the island, can obtain particulars by writing to the Utility and

Information Bureau, Department of Agriculture, Commerce, and Labour, Havana, Cuba. Leon J. Canova, an American who has resided in Cuba eleven years and has a wide acquaintance with the island, has been appointed director.

GLAMORGAN B.K.A.

SHOW AT CARDIFF.

The principal show of the above association was held in connection with that of the Cardiff and County Horticultural Society at the Sophia Gardens on Wednesday and Thursday, July 21 and 22. The chief factor in the making or marrying of the event—viz., the weather—was, unhappily, not all that could be desired, the afternoon of the second day being rough and wet, spoiling the enjoyment of those present.

In Glamorganshire the present summer has been decidedly unfavourable to the gathering of even a fair honey-yield, the usual type of weather being either chilly, windy, or wet, and no sign of improvement has yet appeared. Consequently the exhibits, though good, were not numerous, and were hardly worthy of the services of Mr. Walter F. Reid, who kindly acted as judge, making the following awards:—

MEMBERS' CLASSES.

Twelve 1-lb. Sections.—1st, D. George, Merthyr-mawr, Bridgend.

Single 1-lb. Section.—1st, D. George; 2nd, T. Davies, Kenfig Hill.

Three Shallow Frames of Comb Honey.—1st, R. Morgan, Cowbridge; 2nd, J. Boyes, Cardiff.

One Shallow Frame of Comb Honey.—1st, R. Morgan; 2nd, Sam Lewis, Bridgend.

Twelve 1-lb. Jars Extracted Honey (Light).—1st, E. Church, Cardiff; 2nd, R. Morgan; 3rd, T. Davies; v.h.c., W. T. Gunter, Cowbridge.

Six 1-lb. Jars Extracted Honey (Light).—1st, R. Morgan; 2nd, E. Church; 3rd, J. Boyes.

Twelve 1-lb. Jars Extracted Honey (Medium or Dark).—1st, J. Boyes; 2nd, R. Morgan.

Beeswax (not less than 1 lb., in retail form).—1st, R. Morgan; 2nd, D. George; 3rd, G. F. Braddick, Cardiff.

Articles of Food (containing honey).—1st, R. Morgan; 2nd, G. F. Braddick; 3rd, D. George.

Candy (not less than 5 lb.).—1st, Miss Grivil, Cardiff.

PRIZES GIVEN BY J. HIBBERT AND SONS, CARDIFF.

Twelve 1-lb. Jars Extracted Honey (Light).—1st, G. F. Braddick; 2nd, R. Morgan; 3rd, E. Church.

Twelve 1-lb. Jars Extracted Honey (Candied).—1st, R. Morgan.

NOVICES' CLASSES.

Six 1-lb. Sections.—1st, W. Lewis, Bridgend.

OPEN CLASSES.

Twelve 1-lb. Sections.—1st, G. Tudor-Williams, Aberdare; 2nd, D. George; 3rd, W. Gage, Dulverton.

Twelve 1-lb. Jars Extracted Honey (Light).—1st, R. Morgan; 2nd, E. Church; 3rd, J. Boyes; v.h.c., G. F. Braddick.

Beeswax (not less than 2 lb., in retail form).—1st, R. Morgan; 2nd, D. George.

Collection of Appliances.—1st, E. J. Burt, Gloucester; 2nd, J. Hibbert and Sons, Cardiff.

Observatory-hive, with Queen and Bees.—1st, S. J. Wakeford, Dinas Powis; 2nd, H. D. Davidson, Basingstoke.

When the weather permitted, the Rev. H. Morgan, B.A., gave lectures and demonstrations in the bee-tent at intervals each day.—WILLIAM RICHARDS, Hon. Sec., Glamorgan B.K.A., Gabalfa, Cardiff.

LINES B.K.A. SHOW.

We regret two errors which appeared in the report of Lines B.K.A. Show in B.B.J. last week. The winner of the second prize in the Cottagers' Class was Mr. W. Standen, and the lectures in the bee-tent were given by Mr. H. J. Banks, not by Mr. W. Herrod, who attended the show as judge and to examine candidates for the B.B.K.A. expert certificates.

W. B. CARR MEMORIAL FUND.

Amount already acknow- ledged	£	s.	d.
.....	52	1	6
Mrs. W. Herrod	1	1	0
W. Herrod	1	1	0
L. McNeil Stewart	1	1	0
"D. M. M."	0	5	0
Thos. Marshall	0	2	0
	£55	11	6

Correspondence.

The Editor does not hold himself responsible for the opinions expressed by correspondents. No notice will be taken of anonymous communications, and correspondents are requested to write on one side of the paper only, and give their real names and addresses, not necessarily for publication, but as a guarantee of good faith. Illustrations should be drawn on separate pieces of paper. We do not undertake to return rejected communications.

DISINFECTING HIVES.

[7542.] Replying to Mr. S. P. Soal's remarks on above (7528, page 274), I think most people will agree with him so far as he goes. He seems but to elaborate the "Guide Book" instructions, only that he does not go on to say that the infected bees should be confined for forty-eight hours in a skep or box and then fed, on transfer to clean hive, with

medicated food. Without this latter precaution all the foregoing scorching and disinfecting of hives, appliances, &c., may very probably prove lost labour.

Last autumn I bought four stocks from a friend going to India, and discovered that they were more or less affected with foul brood. A month previously I had killed the queens of all my six stocks and allowed them to raise fresh ones, as they seemed to require more energy. At that operation I noticed some doubtful-looking cells in several of the combs. During the queen-raising all stocks filled the combs, as brood hatched, with ample stores for winter, and when later I examined the hives to find new queens I noticed several diseased cells, and decided to leave the job of curing until this spring.

One stock died out early in April, another was too weak to save, and the two remaining affected lots I shook into a box and skep respectively and proceeded to try the painter's blow-lamp, but later found a Bunsen burner attached to a gas-bracket more efficacious. With another piece of tubing in my mouth I blew the flame over the wood surface to a width of about 6 in. For cracks and joints I lowered it to a needle-like point of blue flame. Every inch of live-surface inside and out, also section-racks and shallow boxes (put on hives, alas! without avail last season), was licked by the fiery tongue. From the supers all starters and sheets of super-foundation were removed and melted up, sections being burned and shallow frames scorched. Smokers, queen-excluders, metal and wood dividers, all were "under fire" for a brief spell, and "W. B. C." metal ends (are these not sometimes overlooked?), veils, quilts, &c., boiled and sprayed. Then all the wood-work was scrubbed with boiling soda water, sprayed, and exposed in open air to the beneficent rays of Old Sol to lure out to their destruction any bacilli which might possibly have thus far eluded me. The brood-frames, freed as much as possible, even in saw-cut, from valuable wax, had yet sufficient left with resinous propolis to make excellent firefighters, whilst the combs, with much healthy as well as diseased brood, together with super-foundation and other scraps, gave me nearly 20 lb. of good wax after refining three times.

The bees, meantime, were not confined, but for seven days—last week of April—were freely flying and building a little new comb in their temporary quarters, in which the queens were already laying when I shook each stock into its cleansed hive on to new foundation. Nor did I warn them by smoke or movement to fill up with doubtful stores from doubtful comb, but raised them straight away, shook them, with one jerk, upon spread-

out newspaper, and so they travelled up into new frames. The small white combs went to the pot, and box and skep to a waiting bonfire, where the newspaper soon followed. A couple of frames of brood and stores were given to each from two strong stocks which had been previously fed with medicated syrup. These stocks are now fast gathering surplus, and are entirely free and healthy.

I have for some weeks been reading the old numbers of B.B.J., from 1906 onwards, and the articles come up again as fresh as ever. I am never without a B.B.J. in my pocket, and many an otherwise tedious wait or monotonous walk is thus averted or converted.

Were not my "Popular" hives, as made by a certain firm, so satisfactory in their dimensions, style, and finish, I should have them made in strict accordance with the valuable specifications recently contributed to the B.B.J. by Mr. Soal, for good workmanship and material seem to me of special importance for the success and enjoyment of bee-keeping. A thing of beauty is a joy for ever, and a well-painted white hive, perfectly fitted and well stocked, standing alone or with others similarly appointed, in garden, meadow, or orchard, gives the approaching bee-keeper a certain subtle thrill of pleasure and an added joy in life, known only to his fellows in the craft, and quite apart from the thought of "Do they pay?"—H. O. MORGAN, Bristol.

DISTANCE OF BEES' FLIGHT.

[7543.] I have just read in May 13 issue (7458, page 186) the letter on "Distance of Bees' Flight." I do not think that the case of Kaden, *Bienenzeitung*, 1854, is a sufficient proof, as the bees lost the vessel out of sight. The returning bees looked out for the vessel on that spot where they had seen it on the last visit. It is incredible that the bees followed the ship more than a short distance. A bee cannot make this reasoning: The vessel moving on is the same as that I saw on quite another spot at the last visit. You will find some cases about distant flights on page 19 of my paper "Are Bees Reflex Machines?"—DR. V. BUTTEL, Oldenburg i. Gr.

[On the page alluded to by Dr. v. Buttel-Reepen, he criticises the conclusions come to by A. Bethe in his work *Dürfen wir Ameisen und Bienen psychische Qualitäten zuschreiben?* where, in the chapter "How do Bees Find the Hive?" he says that they are "led back to the hive by a force entirely unknown to us," and that "the action of the force is not a circle with a radius of six kilometres, but of only between three and four kilometres." In a footnote Dr. v. Buttel

says: "The 'unknown force' must act at much greater distances under certain conditions, for other observations show that bees have flown five, six, or even over seven kilometres further under extraordinary circumstances. In these cases there was no forage near at hand. According to Dzierzon, some bees under these circumstances scented a large 'hundred-acre' rape-seed field which lay far outside their usual circle of flight. Roth, the leader of the Baden school of bee-keepers, in Durlach, observed that some of his bees returned in thirty minutes with full loads from a buckwheat field six kilometres away. Granting that Roth's bees flew to the buckwheat field from the south, there is no reason for thinking that bees from an apiary at the same distance towards the north had not hastened to this same nectar supply. Now if, for experiment, a colony should be taken from the southern apiary to the northern one, then they fly south to the buckwheat field, and there, coming into the field of action, would again return to the southern apiary. The 'unknown force' would reach twelve kilometres in this very possible case. If it be asked from what distance bees can find their way back, the answer cannot be made in kilometre measurements, for it depends upon whether the bees in their flight of orientation (see the same), or in their search for food, have flown to greater or less distances, upon the definite direction of the forage and the general orientation." Dr. v. Buttel further shows that this "unknown force" is simply memory on the part of the bees, and says: "The mysterious force acts within the space in which the bees have previously taken their flights of orientation, and acts only as far as they have flown at any time and gathered memory-pictures. The proofs of this are easy to bring forward. They show, on the other hand, that this unknown force so designated is identical with memory of location." He also gives a number of examples of experiments conducted by him, which tend to corroborate the above conclusions.—ED.]

ISLE OF WIGHT BEE-DISEASE.

[7544.] It is with a feeling of alarm that one reads the accounts of the ravages of the much-dreaded Isle of Wight bee-disease. In the *Farnham Herald* of last week "A Son of the Soil," a regular and apparently well-informed writer, speaks of one bee-keeper in Surrey having lost 1,000 hives. [This, no doubt, is either a mistake or an exaggeration, as we question if there is any single bee-keeper in Surrey who has 1,000 stocks to lose, and it only shows the harm that is likely to be done by such sensational reports.—

Ed.] Whether or not this is true, one feels that the time has come for absolutely definite information on the subject, to be carefully collected and published so that bee-keepers may know clearly where the disease exists. If carefully located, it may be possible to do much to prevent it spreading by restricting the removal of bees from affected districts, and even as a last resource by actual destruction of all the bees in such districts. I am sure the great majority of English bee-keepers would, if necessary, contribute willingly towards compensating for such loss if caused for the general good. The first point, however, appears to be to get the disease carefully located with the least possible delay.

On the other hand, I have heard it asserted that there is no cause for alarm, as there is no new disease prevalent. I have only had experience of one suspicious case, which happened in the apiary of the Rev. C. E. Hoyle, Vicar of Aldershot.

On June 25 Mr. Hoyle wrote: "One of my hives shows signs of Isle of Wight disease, I fear. I have written to the Board of Agriculture." I suspected starvation, and advised feeding.

On July 3 Mr. Hoyle again wrote: "The hive has gone from bad to worse, and for the last two days thousands of bees have been crawling on the ground near, and have perished. I put on the feeder a week ago on your suggestion, but they do not seem to care for it. By pouring some syrup, however, between the bars I am getting them to take it now, and to-day I seem to see some improvement and a little more vigour in those that fly to and from the hive. They had exhausted their stores in the frames, but there was a fair amount of brood. They are now bringing in pollen fairly freely, and I hope they will pick up."

I then advised pouring warm syrup directly into the cells along tops of frames and warming the hive with warm bricks over quilts.

On July 4 Mr. Hoyle writes: "I had done yesterday what you suggest—*i.e.*, pouring warm syrup on the combs—but not warming the hive, as it has kept very warm with a cushion of cork dust on the top. To-day there have been very few crawlers and the workers seem stronger; also they are going to the feeder better now. . . . On the evening of July 5 I opened this hive and found sealed food in the frame at back of hive. The bees and brood in the hive appeared quite healthy."

To-night (July 15) Mr. Hoyle informs me that the bees are now doing well.

I have tried to state the facts in the simplest way, and they all go to prove

that the bees were simply dying of starvation. I may say that during June I had to feed several of my own hives, as I found stores low. The only doubtful point seems to be the sealed food in the back frame. I had one hive with frames parallel to entrance, in which the bees died of starvation during last winter with two frames of sealed honey at the back. The whole facts give one the impression that the bees had used their utmost endeavours to feed the brood to the last, and were too exhausted to reach the food at the back. They appeared to be too weak to reach the feeder when first put on. Of course, it would be absurd to say that every suspected case of Isle of Wight disease was simply starvation because this one case seems clearly to be so. Still, it may be the case that some, let us earnestly hope many, of the alleged cases may be due to simple starvation. After the fruit-blossom fades, if a period of wet ensues, a long time may elapse before bees are able to gather sufficient stores to keep them, as an enormous quantity is necessary to feed the brood.

Unfortunately, many bee-keepers are unable to tell when a hive is devoid of stores; others never think it necessary to look. I think it would be sound advice, where bees seem exhausted, to at once begin feeding, and if they do not take to the feeder try them with some warm syrup poured into the cells.

I think, however, that it would be well for you to invite the immediate co-operation of all bee-keeping associations in making a special effort to obtain reliable information and reports regarding the progress of the disease. If it can possibly be confined to a limited area, whatever the cost, it will be far cheaper in the end than simply sitting tight and allowing it to spread all over the country without a single effort being made to check or limit it.

The postscript to Mr. Hoyle's letter of July 3 is not without interest as showing the dilatoriness of the Board of Agriculture to cope with the disease: "The Board of Agriculture is very leisurely. First they acknowledged my letter. Then they wrote again to say that they issued no leaflet, but if I would send 4d. they would forward me the February number of their journal, with a report on the Isle of Wight bee-disease. I sent 4d. on Thursday, but have had no reply." I am sure every bee-keeper will only be too glad to help them to cope with the disease by sending for their journal.—Geo. BRUCE.

[If the bee-keepers' associations will watch and take steps to prevent the spread of the disease in their counties, we shall be happy to give them every facility for doing so.—Ed.]

BRITISH BEE-KEEPERS AND COUNTY ASSOCIATIONS.

[7545.] I have read with interest the letters in your valuable paper, the B.B.J., on the above. And if members of county associations have met with the same treatment that I have I do not wonder that their associations are not in such a flourishing condition as one could wish. I had six stocks of bees in 1907 (but no

and what a state the bees were in. He replied that he would come as soon as he could. He next sent a card in October saying he would call on me shortly. I did not want him then, as most of the bees were dead, and those alive were settled for the winter. Other correspondence passed between me and the secretary on the subject. I could have easily got other experts to come, but relied on promises sent by the officials of the association.

GERMAN HIVES.

[7546.] I was over at Leipsic at the German "Royal" Show at the end of June, and took the accompanying photographs of the bee-department, showing the different types of hive in use, thinking they might prove of interest to some readers of the B.B.J. The fronts of all the observatory-hives were covered with paper, as I took these

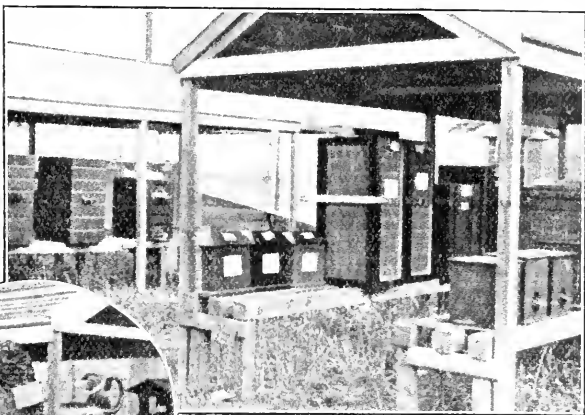

GERMAN HIVES.

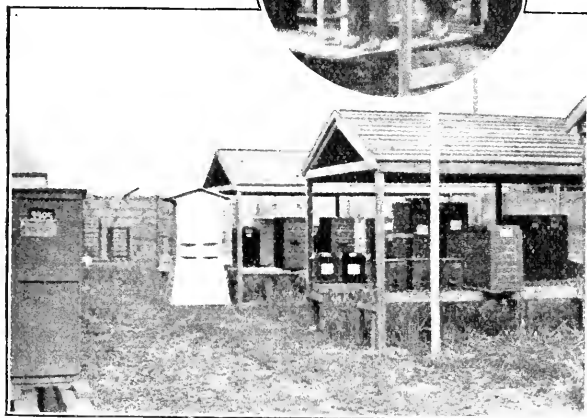
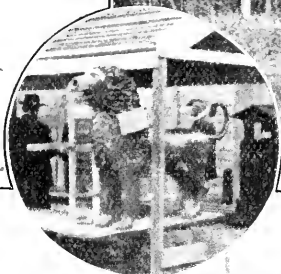

BEE-EXHIBITS AT THE GERMAN "ROYAL" SHOW.

the day before the show opened. The "Lion" hive was wonderfully made. The bees entered at the mouth, and the honey was removed by taking off the tail and latter end, and as an absurdity it would be hard to beat. There was no honey staged that I could find —only this exhibit of hives all full of bees. — F. J. CRIBB, Retford.

honey), and lost one stock by starvation in March, 1908. As a novice I joined a county association, and was promised that the expert would visit me at least once a year. The rules say "periodically," and as I wanted advice I wrote to the secretary, who sent my letter on to the expert, and after a time the latter wrote telling me what to do with the bees until he came, which would be early in June. I then had a card from him saying he could not come till the end of June, and the same thing happened in July. I wrote and told him how anxious I was,

While acting on the advice given and waiting for the expert I lost three stocks of bees. I bought a queen to put in with one lot, with some brood I had taken from my other colony. The queen seemed to be well accepted, as I saw her fourteen days later. The colony was then closed down with plenty of stores. This spring, however, they were queenless, and the stock died out, as I did not unite owing to cold weather. I have not taken 1 lb. of honey in the past two seasons, and besides losing these stocks I have fittings and foundation for all lying idle

and unused owing to the dilatoriness of the association. I have made complaints, and asked them to be placed before the committee, but have received no reply. I had a report for 1908 sent me, and there has been a general meeting (business arranged for 1909), but I received no notice of it, and it seems to me that this is an association in name only. It seems as if the 2s. 6d. member is ignored for others paying more. I do not wish to interfere with the doings of the association, and for that reason only I withhold my name and that of the county, except for reference, and sign myself—**BEGINNER.**

FOUL-BROOD LEGISLATION.

[7547.] Some years ago your journal took toll as to whether or not we should have legislation to protect bee-keepers from foul brood. Unfortunately, the vote was against it; so nothing was done. Foul brood flourishes as much as ever, apparently all over the country, therefore disease has to prevail. It seems strange that a country like England should be so backward in putting bee-keeping on a healthy footing. America has foul-brood laws, Ireland also; but we go on stagnating and grovelling in disease, apparently with the approval of the leaders of the industry. Unfortunately, a very large number of bee-keepers do not know anything about the disease, and consequently those who do have to suffer through their ignorance and incur heavy losses. If we had a law to protect us it would, or ought to, have an excellent effect by spurring on those who are ignorant of it to thoroughly master the disease, or else go under, whereas as matters at present stand those who understand it have to give way to those who do not, and bee-keeping becomes an impossibility.—**F. W. MOORE,** Bedford.

BEE-NOTES FROM BRISTOL.

[7548.] I have just taken in the B.B.J. again after giving up bee-keeping (owing to circumstances) for many years. One of the first things I note is the great loss the industry has sustained by the death of the late W. Broughton Carr. What a worker he was; what an inspiration to us novices in my early bee-keeping days! Surely, one of its most brilliant lights has been removed from the bee-world! What has become of the "Wells" system? It was just about the time when Mr. Wells was expounding his two-queen theory that I lost touch with the craft. Has the plan been found wanting? He certainly did well with it at that time; but no doubt it has been thoroughly tested

in the meantime, and its weakness (if any) exposed. However, I have made another start, with one stock, one swarm, and a strong nucleus, and if foul brood keeps away shall soon have a good-sized apiary, I hope. Bees do nothing invariably as true to-day as ever. A runaway swarm—a "cast," I expect—came over my garden the other day, travelling like a homing pigeon. It would not deign to settle with us, where plenty of low bushes were provided (they were too high for the garden syringe), so some of the younger members of my family followed it until thoroughly exhausted, and they were obliged to give up the chase. But the bees were still going as strong as ever over the elms and housetops. I am afraid the honey-crop about here will be a very moderate one—full of promise in May, but since, with rain and sunless days, wretched. I expect to see a lot of honey-dew gathered, as everything seems swarming with aphids.—**F. S.,** Bristol.

BEE-CLUB IN LONDON.

[7549.] I started bee-keeping this year, and began by getting the "Guide Book" and taking in the B.B.J., which I find extremely useful. I also obtained last year's copies of the B.B.J., and I was surprised to find that there was no place mentioned where bee-keepers could meet and talk over their experiences. Could not a bee-club be got up in London, either at the offices or in the City, where during the winter months bee-keepers could meet and where a supply of bee-literature could be kept? Of course, during the summer it would not be of much use, as the people are, or ought to be, at work in their apiaries; but during winter weekly lectures could be given, and debates could be got up, which, I am sure, would help the winter to pass quickly to bee-keepers. At present we can only discuss bee-matters with the people in our neighbourhood: but it would be of more interest if we could discuss the same matters with people in other parts of the country. Of course, this can be done, by writing, through the B.B.J., but people do not often write all they can talk. Hoping this will meet with your and other bee-keepers' approval.—**ALPHA,** Rugby.

[The B.B.K.A. tried getting bee-keepers to meet together once a quarter, but this had to be given up owing to very few attending. Now the *Conversazione* takes place twice a year, and a very much larger number of bee-keepers come; but we are afraid weekly lectures in London would not attract many of them. The county associations have the privilege of sending two representatives to the monthly meetings of the Council, but they

rarely attend any but the annual meeting in March and the *Conversazione* in October. Bee-keepers are not wealthy, and there would hardly be a sufficient number willing to pay the cost of a club in London.—Ed.]

THE LATE MR. LUKE WREN.

It is with deep regret that we have to record the death of Mr. Luke Wren, a veteran bee-keeper, which took place on July 5, after only a few hours' illness.

Mr. Wren was head of the firm of L. Wren and Son, saddlers and harness makers, of Lowestoft, and resided at

Somerleyton, five and a half miles away, where he had his apiary. Although his father kept bees when he was a boy, he was first actively attracted towards them in May, 1882. When walking through the garden of the late Jeremiah Coleman, he came across the bee-hives, *i.e.*, some half-dozen stocks in skeps. Mr. Coleman objected to the cruel sulphur-pit as a finish to the bees' labours in the summer, and so — as frame-hives and modern methods were unknown there-

abouts at the time — the bees had been in the garden for many years, but no honey had ever been taken from them. After some thought on the matter, Mr. Wren, though not knowing much about bees, volunteered to drive the bees and transfer them to frame-hives. His brother, who was a bee-keeper, sent him a pattern hive and section-rack to work from, and several were made, and in the end the bees were transferred to them without a single hitch, with the result that the first year after the owner got his first $\frac{1}{2}$ cwt. of honey from the bees. This exploit got noised abroad, and so many skeppists sought Mr. Wren's help in adopting the "new system" that he eventually had to put down a gas-engine

and machinery at his premises in Lowestoft for the manufacture of bee-appliances, which has grown into a large business, at the present time electric power being substituted for gas in driving the machinery.

Mr. Wren was an active bee-keeper, and went to different parts of the county to start cottagers, and to give lectures in village schoolrooms. He induced many to begin on modern principles by driving and transferring the bees for them. He started the Lowestoft and District Beekeepers' Association, and was its expert. During the last ten years he had the assistance of his grandson, who has grown

up in the occupation. Mr. Wren had about twenty hives at his private residence at Somerleyton, where, away from business cares, he had the opportunity of indulging in such congenial hobbies as yield pleasure and restful recreation. This apiary was illustrated in the *B.B.J.*, July 7, 1898. Up to a week before his death he was actively engaged in his apiary attending to his bees. He was a frequent contributor to our pages, and a regular reader, and his



THE LATE MR. L. WREN.

grandson, Mr. A. W. Wren, informs us that one of his many pleasures was the reading of the *B.B.J.* every Thursday when it came.

Mr. Wren was at business on the Saturday, and at chapel both morning and evening on Sunday. He was taken ill about 11.30 on the Sunday night, and passed away at 10.30 the following morning. We are sure all our readers will join us in sympathy with the family in their bereavement.

CAPPINGS OF COMB.

BY L. S. CRAWSHAW, NORTON, MALTON.

Abbott's "W.B.C." Hive (page 262).—Why should lock joints be "an unnecessary expense"? The extra expense should be trifling, whereas such a joint, cross-

nailed, is much stronger, and less liable to warp, than a straight joint nailed one way. This type of joint has been largely adopted and tested in America, and is a great aid to assembling when hives are bought in the flat. These should be put together and painted as soon as received. With unpainted hives such a joint might rot more easily in our climate; but thoroughly painted it is perfect. Again, it is a great convenience to have hives square—that is, with equal sides—as a small difference of dimension in an oblong hive is very trying.

A Matter of Mood (page 264).—Well, Mr. Woodley, it is something to be satisfied of existence, if not *with* it, even if one must attack Pope's infallibility to prove it! "Man always is, but never to be blest." Surely an even more pessimistic version than ever! "Ever, never—never, ever!" thus presenting an indefinitely different indication.

Chlorine for Disinfection (page 264).—Perhaps Mr. Green would add to his very helpful explanations by indicating a simple method of using the chlorine safely in a full stock. But why use any form of chlorine at all? Has it any advantage over formalin?

Parthenogenesis (page 265).—No, sir, I was not trying to catch you napping in your little wooden hut, and I made quite a noise as I came down the path, lest you should be enjoying forty winks. But the hut seems to be a comfortable place to talk things over, even sleepily, with one eye on the returning bees, and one, alas! upon the weather. If only it were warm! What a lot of difference may be made by that little word "if"! But I am not sure that it is a good difference in your case, for the honey-bee is not the only exponent of this form of generation, and in some cases—the aphid, for instance—parthenogenesis has direct descent in the female line.

"W. B. C." *Memorial* (page 265).—Dear "Brother Bee-keeper," if you can afford it, and you have any grateful or personal memory of the dear old man who was ever so kindly willing to help us all in the past—in other words, if you intend to give, will you not send your mite, however small, to make this fund worthy of the memory of "W. B. C."? I have no doubt that any suggestions as to the fund would be welcomed at headquarters, but the main point is that you should give whilst you remember, and not allow your effort to drift into the limbo of "forgotten things."

Second Swarms (page 266).—Is there not some clerical error here, or a mistake as to the source of the swarm? It is not possible for a 2½-lb. swarm to build its combs and rear its bees, the first of which would hatch in, say, three and a half weeks,

and then the following day, or a day or two after, to send off a 4-lb. maiden swarm. Yet this is what is stated. What is the explanation?

Disinfection (page 274).—I am very much in sympathy with some of Mr. Soal's pronouncements; but there seems to be a weak spot in his argument that hive disinfection is useless on account of danger from outside sources. Whatever the danger, that is no indictment of the process itself. Personally, I believe that, after cleansing, a good coat of paint is a most effective tomb for possible spores. It is not certain that spores are there, but—they may be! I wish Mr. Soal would give us the data which make him state so emphatically that swarms carry disease.

Treatment of Swarms (page 276).—1. Yes; my suggestion was that this particular bee-keeper, whose swarms would not "stay put," should confine with excluder-zinc. 2. Yes, I generally give a frame of brood and honey to a swarm. It settles the swarm, and provides against a possible break in supplies. I refer to this plan in the same number of the JOURNAL (page 277).

Swarms and Foul Brood (page 276).—No, I do not think that swarms carry foul brood. I do not assert that they *cannot*, but that the risk is minimum. A good natural swarm comes from a stock which is carrying fresh nectar, so that diseased honey is not in use. Even if some germs were carried in the sacs, the usual treatment of a swarm (particularly when sent to a distance) includes confinement and comb-building—in other words, the very essence of disease treatment.

The Northern Wailing Season (page 278).—Metre: "Till Summer comes again." *Tempo Andante*, so as to slur any difficulties of rime or reason. To be sung very sympathetically to a well-known tune:—

From Whitby's icy mountains,
From cliffs where ends the sand,
Where rain pours down in fountains,
And almost drowns the band,
'Mid bergs of frozen heather,
There sound the bee-man's wails;
Bee-men and bees together
Blubber o'er slaughtered males.

There stands the bright-billed blackbird,
A blot upon the snow;
The "summer" is so backward,
He wishes it would go.
In vain protective caution
Which donned the black and gold!
Dead drone must be his portion
To keep away the cold!

The swallows prate of flitting
Above the widowed hives;
They mock ideas of "sitting"
By shivering queenly wives:
"Small use for food to forage,"
The hungry worker hums—
Let's pack them in cold storage
Until warm winter comes!

WEATHER REPORT.

WESTBOURNE, SUSSEX,
June, 1909.

Rainfall, 3.08 in.	Minimum on grass,
Above average, 1.03 in.	39° on 8th and 11th.
Heaviest fall, .90 in. on 6th.	Frosty nights, 0.
Rain fell on 15 days.	Mean maximum, 60.
Sunshine, 145.2 hours.	Mean minimum, 47.9.
Below average, 90.8 hours.	Mean temperature, 53.6.
Brightest day, 8th, 12.8 hours.	Below average, 3.5.
Sunless days, 3.	Maximum barometer, 30.397 on 18th.
Maximum temperature, 68° on 18th.	Minimum barometer, 29.447 on 24th.
Minimum temperature, 39° on 8th.	

L. B. BIRKETT.

JUNE RAINFALL.

Total fall, 2.95 in.

Heaviest fall in 24 hours, .50 in. on 22nd and 28th.

Rain fell on 14 days.

Above average, .57 in.

W. HEAD, Brilley, Herefordshire.

Bee Shows to Come.

August 2 (Bank Holiday), at Cambridge.—Honey Show, in connection with the Cambridge Mammoth Show Society. **Entries closed.**

August 2 (Bank Holiday), at Clewer, Windsor.—Show of Honey and Appliances by the Windsor Branch, Berks B.K.A., in conjunction with the Clewer Horticultural Society. **Entries closed.**

August 2 (Bank Holiday), at Melton Constable.—Annual Honey Show of the North Norfolk B.K.A. **Entries closed.**

August 4 and 5, at Abingdon Park, Northampton.—Honey Show of the Northants B.K.A. **Entries closed.**

August 5, at Madresfield, Malvern.—Annual show of the Worcestershire B.K.A. Open class for collection of Bee-products. Prizes 20s. and 10s. Schedules from Mr. George Richings, 2, Shrubbery Terrace, Worcester. **Entries close July 31.**

August 10, at Holyhead.—Annual Honey Show of the Anglesey B.K.A. **Entries closed.**

August 10 to 12, at Beverley.—Show of Honey, &c., in connection with the Royal Yorkshire Agricultural Society. **Entries closed.**

August 11, at Wye (Kent Honey Show).—Five Open Classes: Trophy, cup value £3 5s. (entry 1s.), 1 lb. Section, 1 lb. Light Run, 1 lb. Dark Run, 20s., 10s., 5s. in each case (entry free); Beginner's Outfit, to retail 30s. (entry free). Fifteen Classes open to Kent: Two Challenge Cups, value £6 6s., and money prizes for 6 1-lb. Sections and 6 1-lb. Jars Extracted Honey. Money prizes for 6 Jars Light, 6 Jars Medium, 6 Jars Dark Extracted Honey, 2 Shallow or Standard Frames, 3 Sections and 3 Jars, 1 Jar Granulated, Beeswax, Mead, Candy, Cake Sweetened with Honey, Display of Cut Flowers, &c.; two Special Classes for Cottagers. Schedules of J. Tippen, Secretary, Wye, Kent. **Entries close August 2.**

August 13, at Lancaster.—Lancaster Agricultural Society, in conjunction with the Lancashire B.K.A. Fifteen Classes for Honey and Bee-produce; also for Bee-hives. Numerous special prizes, including two silver challenge cups, twelve silver and bronze medals, &c. In applying, state Honey Schedule required. Thos. Armistead and Son, Secretaries, Lancaster; or J. M. Bold, Almonds Green, West Derby, Hon. Sec. Lanes B.K.A. **Entries close August 4.**

August 13 and 19, at Shrewsbury.—Annual Show of the Shropshire B.K.A., in connection with the Shropshire Horticultural Society's Great Floral Fête in The Quarry. Nine Open Classes for Honey and Wax. Schedules from Hon. Sec., S. Cartwright, Shawbury, Shrewsbury. **Entries close August 6.**

August 13, at Salisbury.—Annual Show of the Salisbury and District B.K.A. Five classes open to the United Kingdom, including Single Section and Single Bottle. No entry fee. Schedules from Hon. Sec., J. E. Pinder, Salisbury. **Entries close August 11.**

August 21, at Elworth, Sandbach.—In connection with the Elworth Athletic Club and Horticultural Society's Show. Class for Honey open to the County of Chester. Prizes: 1st, 15s.; 2nd, 7s. 6d.; 3rd, 5s.; for 12 Jars Run or Extracted Honey; also Bronze Medal given by the Cheshire Bee-keepers' Association. Entry fee, 1s. Schedules from E. Jones, Hon. Sec., Elworth, Sandbach. **Entries close August 14.**

August 25, at Brislington, Bristol.—Annual Show of Honey, Wax, and Appliances of the Somerset B.K.A. Extended Schedule and increased prizes. Seven open and two free classes. Schedules from Mr. James Brown, Show Sec., 3L, Bridge Street, Bristol, Tel. 2176y. Telegrams, "Brown, Bristol." **Entries close August 21.**

August 25 and 26, at Stratford-on-Avon.—Annual Show of the Warwickshire B.K.A., in connection with the Warwickshire Agricultural Society. Schedules from J. N. Bower, Hon. Sec., Knowle, Warwickshire.

September 1 and 2, at Carlisle.—First Annual Show of the Cumberland B.K.A. Ten Open Classes (including Honey Trophy) for Honey, Hives, and Wax. Liberal Money Prizes in all Classes; also the C.B.K.A. Certificate of Merit to best exhibit in each class. Schedules from G. W. Avery, Hon. Sec., Heads Nook, Carlisle. **Entries close August 13.**

September 4, at Crayford, Kent.—Annual Honey Show. Open Classes. Sections and Jars (Light and Dark), 6 of each. Entrance fee 1s. Schedules from J. M. Bates, Hon. Sec., Warren Road, Bexley Heath.

September 13, at Conway, N. Wales.—Annual Honey Show, in connection with the Conway Honey Fair. Open and local classes. Schedules from J. Hughes, Town Hall, Conway. **Entries close September 6.**

September 16, at Castle Douglas.—In connection with Dairy Produce Show, the annual show of the South of Scotland Bee-keepers' Association. Open Classes for three 1-lb. Jars (20s., 10s., and 5s.); three Sections (20s., 10s., and 5s.); entry 2s. One Jar (5s., 3s., and 2s.); one Section (5s., 3s., and 2s.), entry free, but exhibits forfeited unless otherwise arranged. Beeswax (5s., 3s., and 2s.); entry 6d. Thirteen Classes Confined to Members. Numerous prizes, including two Challenge Cups and gold and silver medals. Schedules from Q. Aird, Hardgate School House, Dalbeattie, N.B. **Entries close September 4.**

September 16, 17, and 18, at Crystal Palace.—Surrey B.K.A. Annual Exhibition of Bees, Honey, Wax, Appliances, &c. Twenty-seven classes (nine open to all). Many medals and increased prizes. Schedules from F. B. White, Secretary, Marden House, Redhill, Surrey. **Entries close September 1.**

September 22, at Altrincham.—Honey Show, in connection with the Altrincham Agricultural Show, the largest one-day show in the Kingdom. Classes open to United Kingdom. Classes for Trophy of Honey, for Best Hive, Observatory Hive with Bees and Queen, twelve Jars of Extracted Honey. Classes open to County of Chester, for Run and Section Honey, Wax, &c. Special Classes for Cottagers, and Special Classes for Society's District. Good prizes, low entrance fees. Schedules from Mr. J. Herbert Hall, 2, Dunham Road, Altrincham. **Entries close September 4.**

Notices to Correspondents.

J. W. H. (Newbury).—*Honey-dew.*—A small quantity of honey-dew in honey darkens it and gives it a muddy appearance. In large quantities it is unpleasant to the taste, and if it is all honey-dew without admixture of honey it is

bitter, nearly as black as ink, and quite unfit for the table. It can be used for making blacking.

A Novice (Chester).—Bee-house.—We do not publish plans of bee-houses, but any simple wooden building can be used. On one side a bench is placed running the whole length of the house, and on this the hives are stood. A board runs the whole length, and in this tunnels are cut on a level with the entrance in floorboard to allow the bees to get out. These tunnels can be covered with glass so that you can see the bees walking out. Holes corresponding with the tunnels are cut in the side of the house, and an alighting-board with porches completes the arrangement outside. The hives are placed at a convenient distance from each other, giving room for the slides to work. These, however, are not necessary, as triangular blocks answer the same purpose. Care should be taken to adjust the hives so that the bees cannot get inside the house, and only leave the hives through the tunnels. The house is provided with windows working on pivots, so that bees can be turned out when manipulating the hives.

C. T. C. (Bexhill-on-Sea).—Bees in Skep Dying.—The bees appear to have died from starvation, and the skep should be examined and bees fed if necessary.

Honey Samples.

AMATEUR (Devon).—Nos. 1 and 2 are fruit-flower honey; No. 3 is fruit-flower honey with a trace of honey-dew.

A. L. F.—The honey is rather thin and unripe; the dark colour is caused by honey-dew.

L. A. W. (Liss).—The honey is not good enough for show purposes, being contaminated by honey-dew, a small quantity of which is enough to spoil it for table use.

Suspected Combs.

E. N. (Leeds).—The comb contains a quantity of chilled brood, but apparently no disease. The combs should be melted up for wax and not used for bees again in their present condition.

J. S. (Oxford).—The comb is affected with foul brood in the incipient stage. As you have discovered it in time you ought to be able to effect a cure, but if there is a great quantity of brood, it will be better to burn the combs and frames to save the bees the labour of clearing out the dead brood. Treat as directed in "Guide Book."

* Several important letters, &c., are in type, but held over from pressure on our space.

Special Prepaid Advertisements.

Twelve words and under, Sixpence; for every additional Three words or under, One Penny.

FOR SALE, a few lots of Driven Bees, to be delivered by the end of August, at 1s. 6d. per lb.—**W. HAMBROOK,** Church Farm, Newington, near Sittingbourne. s 76

FOR SALE, Pure English Honey, light colour. Sample 3d.—**LAW,** Cuckoo, Ashwell, Herts. s 75

PURE ENGLISH HONEY, best quality, light colour, in 28 lb. tins, 65s. per cwt., or offer, f.o.r.; cash or Deposit. Sample, 3d.—**A. GREEN,** Tangley, Andover, Hampshire. s 56

FOR SALE, good 10 Frame Stocks, £1; 4 Frame Nuclei, with Bees, Brood, and Queen, 12s. 6d.; Driven Bees, 4s. 6d. per lot.—**A. GREEN,** Tangley Vale Apiary, Andover, Hants. s 55

"W. B. C." HIVES, special make, tongued and grooved floorboards, on stout joists, dovetailed outer brood case and 2 6-in. lifts, inner brood box with 10 frames, metal ends and dummy, inner 6-in. crate with 10 shallow bars, or 3 with wide ends and dummy, 3-in. eke, rack of sections with starters, queen excluder, 3 quilts, 1-in. rabbeted weather-board roof with shallow lift attached, painted 3 coats, 22s. each; 4 hives carriage paid.—**C. H. BURPITT,** Builder, Bourton, Dorset. s 57

Special Prepaid Advertisements.—Continued.

DRIVEN BEES, live delivery guaranteed before August 12, 8s. per lot, carriage paid, including new Skep. No Foul Brood whatever in district.—**DAVIDSON,** The Retreat, Melbury Abbas, Shaftesbury. s 58

33RD YEAR.—Nuclei, vigorous Queen, Bees, Brood, and Stores, reduced price: 3 frames, 10s. 6d.; 4 frames, 12s. 6d.; 6 frames, 15s.; 8 frames, 18s.; cases, 1s. 9d., or returned carriage paid; Driven Swarms, 3s. 9d. and 5s. 6d., cases free, all perfectly healthy.—**ALSFORD,** Expert, Haydon, Sherborne. s 73

EXCHANGE PARTRIDGE WYANDOTTE AND BUFF ORPINGTON COCKERELS FOR DRIVEN BEES.—**HENSLLEY,** Perry-street, Chatham. s 55

50-LB. TIN BEAUTIFUL CLOVER, LUCERNE, SAINFOIN HONEY, 25s. Sample 2d.—**NEWMAN,** 117, Coldharbour-lane, S.E. s 52

SEVERAL HIVES OF BEES FOR SALE, cheap, through tenant leaving, brand new, modern hives, this year's stock.—**WOODLEY,** 50, Townshend-terrace, Richmond, Surrey. s 51

LIGHT SECTIONS BOUGHT, 7s. to 8s. per doz.—Send or write to **THE HONIOLADE CO.,** 23, Moorfields, E.C. s 50

OVERSTOCKED.—Good 8-Frame Stocks, each headed with 1909 Queen, 20s. each to clear.—**G. WORKMAN,** Llanishen, Glam. s 65

HEALTHY DRIVEN BEES, good lots, young Queens, delivery middle August, 5s. per lot; boxes free.—**H. KEMP,** Frome, Somerset. s 66

DRIVEN BEES.—Strong healthy lots, with young laying Queen, 5s. 6d. per lot; selected laying Queens, 3s. 6d. each.—**T. BRADFORD,** Bee Expert, Worcester. s 62

FOR SALE, 3 strong Stocks, in good Hives, splendid condition, for moors, £1 each, a bargain.—**ARTHUR FLETCHER,** Sedgefield, Co. Durham. s 59

HONEY FOR SALE; sample and quotation, 2d.—**HASTINGS,** Welcombe, Stratford-on-Avon. s 64

DRIVEN BEES WANTED IN AUGUST, 4-lb. lots, delivered Northfield. What offers?—**F. E. MATTHEWS,** Cofton Apiary, Northfield, Birmingham. s 67

BEES WANTED, in exchange for $\frac{1}{4}$ plate camera, by Lizars, London, new last season.—**PATERSON,** Rose Cottage, Auchtertool. s 68

DRIVEN BEES WANTED, 1s. 3d. lb. given to August 10.—**NICHOLSON,** Langwathby, Cumberland. s 70

FOR SALE, 5 empty Section Racks, with zinc Dividers, 7s., only used once, or exchange for drawn-out Shallow Frames.—**E. RACEY,** Hagbeach, Emneth. s 69

RIPE GOOSEBERRIES, 3s. 6d. per bushel, free on rail.—**W. WOODS,** Normandy, Guildford. s 72

DRIVEN BEES, from 10 Skeps end August. Highest cash offer.—**BOOKER,** Alford, Billingshurst, Sussex. s 74

SELL TWENTY EXTRA FINE PURE BRED WHITE WYANDOTTE COCKERELS, March hatched, Barron's strain, 4s. 6d., or exchange pullets.—**T. E. ATKINS,** Leire, Luttermouth. s 60

EXCHANGE FIFTY-EGG HEARSON'S INCUBATOR, good working order, for 30 lb. Driven Bees or 12 White Wyandotte chickens, March hatched.—**ATKINS,** Leire, Luttermouth. s 61

3 "W.B.C." HIVES, new, dovetailed, with 2 lifts, brood chamber, and 2 supers, 15s. 6d. each.—**Bigg House,** Arnold, Notts. s 54

HONEY, Extracted, 1908 and 1909, 56s. per cwt.; sample 3d.; remittance must accompany orders. Prompt despatch.—**OWEN BROWNING,** Ashley, Kingsomborne, Hants. s 63

Editorial, Notices, &c.

REVIEWS.

Successful Jam-making and Fruit-bottling. By Lucy H. Yates. (London: Rebman, Ltd. Price 2s. 6d. net.*)—This book comes opportunely, as this is just the time for making jams and preserves. The demand for choice fruit preserves is very great and steadily on the increase, so that there is a splendid opening for the enterprise of fruit-growers and other country dwellers. There is a tendency to be more particular about our food and a leaning to seek supplies from persons who are able to give individual attention to the preparation of it, rather than get it from factories, which, although well equipped and manned, when great quantities have to be dealt with attain a good average rather than perfection. There is a fine opening for the small manufacturer in the preparation of fruits, in every way, and this book teaches how to equip a model factory and the way to select the best varieties of fruits and other raw materials. It also shows how all this can be done successfully on a small scale, and how the produce can be marketed to best advantage. One point is emphasised, and that is that it is easier to compete successfully for a choice market than to make any kind of profit on cheap products. There are always people willing to pay for a high-class article which has been well and cleanly prepared. Therefore to the person with small capital the select trade is recommended. British-grown fruits are particularly well adapted to fruit-bottling and to preservation whole, and for doing this successfully a simple sterilising apparatus at small cost is described. Next in importance to good fruit is the selection of the sugar, and in Chapter V. the difference between cane and beet sugars is shown, and the reader is taught to understand why cane is the only sugar suited for high-class preserving purposes. This chapter is of special interest to beekeepers, as it will help them to understand why only cane sugar is suitable for bee-food. We can recommend this book, as it will appeal both to careful housewives and to those who wish to add to their incomes, at a very small cost, by embarking on an interesting and profitable industry.

Successful Dairy Work. By A. T. Matthews. *Small Estate Management.* By A. C. Freeman, M.S.A. (London: Rebman, Ltd. 2s. 6d. net each.)—The demand of sanitarians, backed up by legislation, and the active supervision

of local authorities tend to increase the attention paid to the milk-supply. *Successful Dairy Work* is intended to keep dairy-farmers and milk-dealers abreast of modern methods. Mr. Matthews is Market Reporter to the Board of Agriculture and an expert, and deals with the subject of milk production and distribution in a practical way. While the hygiene side is kept well in view, valuable hints are given on business systems, thus appealing directly to all classes of the public.

The national policy of establishing allotments and small holdings has had a direct effect on estate management. Wherever possible the aim is to plan an estate to give a number of small holdings rather than a few large farms. Mr. Freeman's book has been written with a view to placing the management on a more business and scientific basis, and to bring practical information within reach of those who are responsible for the development of small estates. The chapter devoted to the Small Holdings Act of 1907 will be found full of useful information to those who contemplate making a start in farming in a small way.

STAFFS B.K.A.

ANNUAL SHOW AT TAMWORTH.

The above association held its annual show of honey, hives, &c., on July 21 and 22, in conjunction with the Staffs Agricultural Society's meeting at Tamworth. The show was a great success, there being over 102 entries and only about half a dozen not staged. The gold medal usually awarded for the best trophy was won this year by Mr. W. Marchant, of Weston-under-Lizard. Mr. Geo. Skevington and Mr. P. Scott acted as judges, and made the following awards:—

Collection of Hives and Appliances.—1st, E. H. Taylor, Welwyn, Herts; 2nd, Messrs. Jas. Lee and Son, Ltd., Highbury, London.

Honey in Any Form, not exceeding 100 lb.—1st, W. Marchant, Weston-under-Lizard; 2nd, Jos. Price, Old Hill; 3rd, J. Lucas, Fradley, Lichfield; 4th, J. Beach, Cannock Road, Burntwood.

Twelve 1-lb. Sections.—1st, G. Evans, Bromstead, Newport; 2nd, W. Marchant; 3rd, Miss E. F. Smith, Whittington House, Lichfield.

Twelve 1-lb. Jars Light Extracted Honey.—1st, H. C. Barlow, Hartshill, Stoke-on-Trent; 2nd, J. Kendrick; 3rd, C. H. Mytton, Stafford Road, Lichfield; 4th, Miss E. Baggeley, Swynnerton Grange, Stone; v.h.c., Jos. Russell; e., Miss Lowe, Comberford, Tamworth.

Twelve 1-lb. Jars Medium Extracted

* Or at the BRITISH BEE JOURNAL Office, 2s 8½d. post free.

Honey.—1st, J. Lucas; 2nd, J. Price; 3rd, J. Beach.

Twelve 1-lb. Jars Granulated Honey.—1st, J. Price; 2nd, G. Evans; 3rd, J. Russell.

Twelve 1-lb. Jars Dark Honey.—1st, J. Lucas; 2nd, H. J. Arch, Bloxwich; 3rd, B. Levett, Lichfield.

Beeswax.—1st, G. Evans; 2nd, Miss E. Baggeley; 3rd, J. Kendrick; 4th, W. Marchant.

COTTAGERS' CLASSES.

Twelve Sections.—1st, G. Evans.

Extracted Honey.—1st, G. Evans; 2nd, J. Lucas; 3rd, Mrs. H. M. Croome, Weeford; v.h.c., Miss E. Baggeley.

NOVICES' CLASSES.

Twelve 1-lb. Sections.—1st, F. Eger-ton, Befcote, Gnosall; 2nd, Jos. Russell; 3rd, E. Kendrick, Lichfield.

Twelve 1-lb. Sections.—1st, J. Morrey, Warton, Newport; 2nd, J. Russell.

OPEN CLASSES.

Specimen of Bees.—1st, G. H. Mytton; 2nd, J. Pearman, Derby; 3rd, E. H. Taylor, Welwyn; 4th, S. J. Durose, Burton-on-Trent.

Twelve 1-lb. Sections.—1st, J. Pearman; 2nd, A. W. Weatherhogg, Willoughton, Lincs.; 3rd, Miss F. E. Barker, Barnston, Dunmow; c., Miss E. F. Smith.

Twelve 1-lb. Jars Extracted Honey.—1st, R. W. Lloyd, Thetford, Norfolk; 2nd, S. J. Durose; 3rd, H. W. Seymour, Alford, Lincs.; v.h.c., A. Jackson, Suffolk; h.c., C. Billson, Kettering; c., Mrs. W. Craven-Jones, Atherstone.

Single 1-lb. Jar Extracted Honey.—1st, W. S. Brown, Shrewsbury; 2nd, H. C. Barlow; 3rd, R. W. Lloyd; v.h.c., Mrs. W. Craven-Jones; c., Miss F. E. Barker.

Single 1-lb. Section.—1st, Miss F. E. Barker; 2nd, W. Marchant.—J. TINSLEY, Hon. Sec.

Correspondence.

The Editor does not hold himself responsible for the opinions expressed by correspondents. No notice will be taken of anonymous communications, and correspondents are requested to write on one side of the paper only, and give their real names and addresses, not necessarily for publication, but as a guarantee of good faith. Illustrations should be drawn on separate pieces of paper. We do not undertake to return rejected communications.

AMONG THE BEES.

LOSS OF QUEENS.

[7550.] This season, in my experience, beats the record for queens suddenly disappearing in early summer after withstanding the winter's rigours, and even making a start at ovipositing in spring. It could not in either case be a question of "balling," as no examination of the hive interior and no spring-cleaning took place until the third week of May, yet

half a dozen queens were found to be missing. In half the cases good colonies were left; in the other half they had dwindled considerably. In all but one there was unmistakable evidence that a queen had been present in the early days of May. In only one case was the deposed queen seen thrown outside. In none of the six hives was such an untoward event anticipated when they were winter-packed, and none of the queens had attained an age when the bees would naturally be expected to depose them. Speaking to several other bee-keepers, they related similar cases, but only isolated instances had occurred in the experience of each. Coming at a season of the year when they cannot easily be replaced, there was little choice but to add on the bees to neighbouring hives. My own idea is that they were the product of that wretched season 1907; their early rearing left them in some way defective, and they gave way prematurely, either dying off from debility or being deposed by the workers, who were conscious of their worthlessness.

Introducing Queens.—I have noted two points lately worth repeating concerning queen-introduction, and think there may be something in both. To the best of my recollection, I have never come across similar recommendations previously. Hunt for the queen in course of the day, cage her, and leave the cage above frames of hive, placing at the same time the cage with the new queen in the same position. In the evening get rid of the old queen, place the new one in her cage, pressing a small piece of foundation over the feed-hole, punching a few small holes in the covering right over the opening. Replace cage, and the bees will do the rest, liberating the queen in a few hours. The second "tip" lies in running the new queen in the cage first occupied by the one being deposed, and then rubbing the dead body of the queen superseded all over the outside of the cage, now containing the new queen. Presumably both plans count on imparting the queen odour of the old mother to the one substituted. It has often been recommended previously to coat the new queen with honey from the hive into which she is being introduced, but I am not certain about the advisability of daubing the young mother in this way. A point worth considering, however, is the following: Liberate the queen and her train against a window. Confine her and a half-dozen young, "unfeathered," newly-hatched bees from the hive into which she is being run, and she will almost certainly be accepted without any demur.

"*Current Topics*."—Mr. Soal's comments (7534), although pertinent, appear

to me to be thoroughly illogical. In pars. 1, 2, and 5 he stands up for the "ordinary scraper," yet he goes one—nay, two—better than I do, for he winds up by recommending a *three-faced "hoe"* to replace the single-faced one I this year found so convenient.

In par. 2 he is inclined rather to lecture me on the sin of making statements "without proper qualifications." I am not inclined to say "Peccavi," because, if my commentator re-reads my original statement, he will find, first, that '07 is recorded as being an exceptional year; second, that I at the time expressed regret that I had not aided my stocks by feeding, under the peculiar circumstances of the season; and, third, he should read into the facts what he well knew, that my district does not "entirely depend on clover as the main harvest," which latter fact entirely vitiates his whole argument. In par. 5 Mr. Soal's words must mean that it is a matter of moonshine whether hives are levelled or not, yet he informs us: "I level all my hives with a spirit-level"—just what I advised; but not to "all and sundry," only to those requiring and willing to take wise advice, for I know that there are immaculate bee-keepers who require no instructions, and thousands who know what to do better than I can tell them. If he had seen, as I have frequently, hives lying at almost all angles short of toppling over he would not only have endorsed my advice, but have emphasised it. I do not wish the multitude of beginners to make mistakes just because the immaculate ones know everything; so, purely and entirely for the novices, I reiterate and quote the following endorsement: "With frames so prepared, and *hives set perfectly level*, the bees will build straight combs." This is from the "Guide Book" (page 24), and I am positive if I were to open, say, twenty other bee-books I should find nineteen, if they referred to the subject at all, giving similar advice. I have said Mr. Soal's comments are *pertinent*, but I must except lines 4, 5, and 6 in paragraph 5. If by the term professional he means a professional bee-keeper, I must pass on the compliment to some other individual, as I am simply an amateur apianian engaging in the "profession" *con amore*. If, however, by the "perfect innocence of the professional man" he means my real profession, I fail to see what that has to do with bee-keeping or with my contributions to the BRITISH BEE JOURNAL.

A Short Crop.—The wretched weather conditions experienced right through June and July, not only in Scotland, but, as reports reaching me show, in England also, make it almost certain the crop of honey will be a small one—several say not

half a crop. It is to be hoped, therefore, that sellers will stand out for a good price. Here there is not only no surplus, but in the third week of July there was not a superfluous pound of honey in any of my hives. Bees are living "from hand to mouth."—D. M. M., Banff.

CHLORINE FOR FOUL BRÖOD.

[7551.] In reply to Mr. Crawshaw (B.B.J., page 298), I am designing a smoker for the using of chlorine. Mr. Crawshaw asks, "Why chlorine and not formalin?" Without saying a word either for or against formalin, I will state why I think chlorine is suitable as a remedy for foul brood. First let us go to the root of the matter, and ask, What is the nature, or rather the action, of a "disinfectant" in stopping the progress of disease? I presume Mr. Crawshaw accepts the theory that most diseases are the result of a vast number of minute collections of gases having regular forms and each in a vitalised state. Call them germs, microbes, bacilli, or what you like, they are living; and whether they have the power of reproduction or are only the result of continuous spontaneous generation under favourable conditions is of little importance in this case.

By what means does a disinfectant destroy these germs? Do they have formalin for, say, breakfast, dinner, tea, and supper, and then go to sleep, never to wake again? The typhoid microbe, which is one of the largest and most easily produced and formed, and enjoys much popularity in consequence, is generated in filthy water. Water is known to contain hydrogen, and the filth would be certain to contain carbon, and as these gases easily unite it is probable that the typhoid germ will contain both. If Mr. Crawshaw can find a gas having a stronger affinity for either the hydrogen or the carbon than they have for each other, we shall be able to destroy the unity, the life, and the germ itself, and it is because chlorine has a stronger affinity for hydrogen than any other known gas that I think it will prove useful in cases of foul brood. I feel certain that foul brood is generated in a damp atmosphere, and probably what we call an unhealthy one, and therefore the bacilli would contain hydrogen, and if so chlorine would prove an irresistible "Dreadnought."

Upon the grounds above stated I rely upon chlorine as a certain remedy when rightly used.—A. GREEN, Notts.

CURRENT TOPICS.

[7552.] Replying to Mr. Crawshaw's criticism *re* the disinfection of hives (B.B.J., page 298), I do not condemn that operation as useless, but, to borrow Mr.

H. O. Morgan's expression, consider it useful "so far as it goes."

We cannot tell for certain how in every case the disease is communicated; therefore I differ from Mr. Crawshaw in the opinion that because a strong stock at swarming-time has generally gathered a quantity of new nectar therefore every bee of the twenty or thirty thousand composing the swarm takes away with it nothing but this new, uncontaminated honey. On the contrary, it is very probable that some of this honey may have been stored in cells that have contained dead brood. Besides this, the bees are continually applying their tongues to the brood. I have seen a worker apply her tongue to a larva that had died of, in this case, I think, black brood.

As to the data upon which I ground my statement that swarms take the disease with them into the new hives, they are summed up in two words—personal experience.

I am glad that my remarks on hive-making were so well appreciated by Mr. Morgan, but I am not at all sure that I reached my ideal in the hive I described. To mention one thing, I can see undoubted advantages in the "claustral" porch, and the only thing I can see against it is its unmitigated ugliness. Again, if I were establishing another apiary I should probably go in for a "taper" frame, as it offers advantages in manipulation not to be gainsaid where a large apiary is concerned (with a small number of hives the style of frame is of comparatively little moment). A frame 15 in. by 14 in. by 9 in. or 9½ in. would, I think, be a good size. I have never used such a frame (they were in use thirty years ago), but can fully appreciate the safety, ease, and rapidity with which they could be manipulated.

Scraping Sections.—For this purpose I find nothing equal to the large blade of a penknife well sharpened on an oil-stone. I prefer this because it is the only tool which is suitable for cleaning the "insets" of sections, and these are often so badly stained with propolis that nothing less than an actual shaving off the wood will make them presentable. In shaving the edges the knife should be held so that not more than ½ in. of the blade projects beyond the thumb, and the latter should be placed on the "flat" of the section to act as a guide and prevent slipping. These precautions are very necessary in view of the fact that the comb is built almost level with the wood at the insets. —SAML. P. SOAL, Rochford.

CURIOUS BEHAVIOUR OF BEES.

[7553.] On June 23 I took a small "shake" of bees from a somewhat bad-tempered stock, giving them a

young and fertile English queen, and living them on foundation. They settled down quite quietly; but, owing to the bad weather just then, I was obliged to feed a little. On July 2 (nine days afterwards), noticing that I had shaken about twenty or thirty drones in with the rest, I decided to kill them, which I did with the aid of a knife as they alighted in front of the entrance. The bees took this quite philosophically; but about half an hour after I had finished they suddenly became very much excited, hustled their queen out, and began "balling" her on the alighting-board. I at once rescued her, and after holding her in my hand for about five minutes reintroduced her under the quilt. The excitement continued for more than two hours, so I sat down to watch. But as the queen was not turned out again, I left them in peace. To-day (July 8) I examined them, and found plenty of eggs, so it is clear that the queen was allowed to settle down in peace. But I am quite unable to understand the reason of the "revolution," and why, after the bees had made up their minds to kill their queen, they afterwards reconsidered their decision.—COOKHAM.

CONDITION UNDER WHICH NECTAR IS SECRETED.

[7554.] I think it would interest bee-keepers generally to know if there is any scientific foundation for such a forecast of the weather as I read lately in a daily paper, that we shall have some fine days in August, but no settled weather till September; or is this only a guess? Also it would be interesting to know if the moon affects the weather? Does the weather change when there is a new moon? Another question that I think would be of interest to bee-keepers is, temperature and weather conditions necessary for the secretion of nectar in flowers—*i.e.*, when, as to-day, rain falls till mid-day, then the weather clears, with moderate sun and thermometer at 65 deg. in shade? Can any honey be gathered by the bees the same day—sainfoin out in full bloom?—F. GORDON, Herts.

[We do not think it possible to forecast the weather more than a few hours, and believe the moon has nothing to do with it. With respect to the latter part of our correspondent's question, the quantity of nectar produced by plants varies according to circumstances. The amount secreted is greatest in the morning, it diminishes in the afternoon, but gradually increases again towards the evening, and continues to increase during the night. Its secretion gradually diminishes during a long series of dry days. The

best conditions for the production of the nectar are a series of fine days after rain, or during thundery weather without rain. The quantity secreted in the plants increases with the latitude and altitude, the moisture of the ground and air, to such an extent that a plant may produce it in one district and not in another. It may also vary with the composition of the soil; the same plant may be nectariferous on a calcareous soil and less so on a silicious one, or the reverse. Under the conditions mentioned by our correspondent, some nectar should be gathered from sainfoin in full bloom.—Ed.]

ISLE OF WIGHT BEE-DISEASE.

[7555.] In your issue of July 22 I notice you state the above disease is very contagious, and advise the destruction of the bees. I have had this disease under close observation for some time, and I have to suggest: 1. That primarily it arises from climatic influences acting upon a system improperly nourished. 2. That it is not a contagious disease. 3. That bees affected should at once be fed continuously with good sound food, and where too weak to take food down pour it into the combs, cover up very warmly and disturb as little as possible, reduce entrance to prevent robbing, and contract comb-space. 4. When bees are well on the way to recovery, as they will be if properly treated, unless the queen is young and vigorous, re-queen. Where possible, I would advise extracting the impure stores from combs before starting the feeding.—WILLIAM M. YETTS, Woking, July 24.

THE SEASON IN WARWICKSHIRE.

FOUNDATION AND FOUL BROOD.

[7556.] I am wondering how Warwickshire bee-keepers in general have fared as regards surplus, for as the season around here is nearly over, one can estimate fairly well now what the take is going to be. In my opinion 1909 must be classed as a remarkable year; it is the first season I have procured any surplus in sections from apple-blossom, which bloomed in May, and, naturally, raised high expectations. These, however, were quickly "submerged" in June, which I think, if anything, was worse than June, 1907. Bee-keepers cannot call it a good season, when the premier month absolutely failed to give us more than a week's bee-weather in all. I see, according to the *London Daily Mail*, only eighty-six hours of sunshine were recorded in June, as against an average of 165. Your contributor from Whitby hits the nail on the head with his verses very aptly. The limes are now in full bloom and the weather was perfect,

until to-day, when rain is threatening. I should be glad to see a report from any local bee-keeper respecting the colour of this season's honey. I have taken 200 sections or so, and although nearly all are fit for consumption, there is some honeydew amongst it, which is surprising considering the heavy falls of rain which we have had at regular intervals.

I read with interest the article by your correspondent Mr. Soal on "Disinfecting Hives" (page 274), but notice that he does not mention comb-foundation as a likely source of spreading foul brood. It is my firm opinion that some of the foundation bought is far from pure, and also may not be thoroughly sterilised. It would be interesting if figures could be obtained of the number of cases of disease in skeps and frame-hives respectively. I believe the skeps would come out less. As an instance I may mention the case of a friend of mine, who has a hive in his garden which had not been touched for four or five years. I went through it for him and found the bees crowded on to eight frames. As the stock was very strong, I suggested putting in two sheets of foundation, and I procured same from a shop in Birmingham and placed the frames in the hive for him. On the next occasion when I examined the hive I found fifty or sixty of the grubs in these two frames had developed foul brood, whereas the old combs were absolutely free, both at first inspection and afterwards. I may add that I promptly withdrew the two frames and burnt them; but this, to me, is fairly conclusive that the foundation was contaminated, as it touched nothing to infect it in any way, as I brought it straight from shop to hive.—H. WILCOX, Olton.

TWO QUEENS WITH ONE SWARM.

[7557.] I had a rather unique experience the other day (July 12) when one of my colonies swarmed, as it is evident that there must have been two queens with the swarm. It came off about eleven o'clock, and settled in a very convenient place, so I had no difficulty in placing a straw skep over it in the usual way; but although it remained in that position until six o'clock in the evening, only one half of the bees went into the skep, and I had consequently to drive them with the smoker. Knowing that the queen was old, I intended to remove her, and allow a young queen to take her place; accordingly I examined the frames with the intention of cutting out the queen-cells with the exception of the ripest one. On the very first frame I took up—the back one—I found a young queen, evidently on the hunt for queen-cells. I removed her to the house to further examine the hive,

and, having cut out two queen-cells, I was taking out a centre frame when out popped a young queen from her cell: this I also captured, and destroyed all the other queen-cells. I now wished to catch the old queen when hiving the swarm, and a friend, who is also a bee-keeper, kindly volunteered to help me. We had not been long watching the bees going up the flight-board when he noticed the queen, and made a grab at her, but was too late, and she passed into the hive. However, as I did not observe her myself I still kept a sharp look-out, although the bees began to run into the hive: but I was not surprised at last to see a queen, and had no trouble in capturing her. I now had three queens from the one swarm, and I liberated the first one with the idea that it might be the strongest, and allowed her to run into the hive with the tail end of the swarm. I could find no cause for the issue of the swarm, as there was plenty of room for stores and for the queen to lay, and there was also a rack of sections on top, in which the bees had commenced working. On examining the hive two days later I found the young queen which I allowed to go in with the swarm dead on the floorboard, so concluded that the colony was queenless. I obtained one of Mr. Sladen's golden virgin queens, and proceeded to introduce her as per instructions. She was liberated all right, and after a week from the day on which I removed the piece of cardboard from the queen-cage I examined the hive to see if my "British Golden" queen had commenced to deposit eggs; but imagine my surprise to find the old queen crawling about, with no appearance of having deposited any eggs since she came off with the swarm.

I started keeping bees in 1907, and many a time during that season I almost despaired; but being encouraged and assisted by a good friend, who is now in Australia, I stuck to it, and must say I derive great pleasure from this most interesting hobby, if nothing else. My old stock (or first stock) last year gave me about 160 lb. of honey, while I had a swarm and about 80 lb. from the other hive. I have now five hives to attend to, and try to give my neighbours all the assistance I can.

I think this season is worse than 1907; rain every day, with cold northerly winds the whole summer, and although the clover crop is simply magnificent hereabouts, the bees are prevented from gathering nectar owing to the inclemency of the weather. This is now the last week of July, and I have not heard of a single rack of sections being completed yet. My bees are, I am pleased to say, all healthy and in good order. I have three colonies with two racks on, the top ones being

almost completed, which is considered good. Some of my neighbours have supers on, but in many cases the bees are not yet working them. I notice some of the drone-larvæ and some of the worker-larvæ being thrown out.

I have induced some of my friends to discontinue the use of straw skeps, and I started transferring the bees into bar-frames about the last week of April, but not one has begun to draw out the foundation, and I am afraid they will have to remain in the straw hives for another winter.—W. F. L., Ballindalloch.

LATE MATING OF QUEENS.

[7558.] In further reference to my letter (7521, page 266), I think my view has been strengthened that Mr. Sleight's queen had mated sooner than he thinks. A member of our B.K.A. came to me for a queen, and tells me he has a drone-breeder in one of his hives. The stock swarmed June 7, and three weeks later the young queen had not commenced to lay, but to-day he has noticed drone-brood sealed over. I may say the weather has been very bad here for queens to meet with drones. I had a swarm three weeks ago, and the young queen has brood on four frames, which I think very good, and I intend to send her to the Derbyshire heather hills for her holiday.—J. PEARMAN, Derby.

RECORD SWARM (?).

[7559.] Perhaps the following account will interest readers of the B.B.J. On Sunday, July 18, at mid-day a swarm issued from one of my two hives and settled on a small branch of a neighbouring plum-tree. The stock from which it came was on twelve frames and supered with three racks, one of sections and two of shallow frames. I had given as much room as possible in the hope of preventing swarming, and I knew it was an exceedingly strong stock. I was not free till the evening to hive the swarm, so left it swaying rather ominously in a fresh breeze. At 4 o'clock I went to attend to it, and was just in time to see it dislodged by an extra gust of wind and fly away. I followed it, and it settled low down in a rose-bush about 200 yards distant. Half an hour later I shook the swarm into a good-sized skep, which seemed not nearly large enough, and about 7.30 p.m. removed the lot. On weighing I found that the swarm went just $12\frac{1}{4}$ lb., or 16 lb. including skep and covering piece of canvas. Is this a record? During the three years I have kept bees and read the B.B.J. I have never heard or read of a swarm of such a size. I took the bees that evening to a person who had bought them, a couple

of miles off, and he procured a frame-hive the next day. On going to transfer the swarm from the skep to the hive that evening, I found the bees had decamped, owing, no doubt, to their too confined quarters. We discovered them again hanging in a pear-tree about sixty yards away, and shook them again into the skep. It was then too dark to complete the business, so I left them for the night, and successfully hived them at 5 o'clock next morning. With regard to Sunday swarming, both my hives swarmed this and last year, and the one which is the subject of this letter each time chose a Sunday.—H. W. COWLEY, Hounslow.

SUCCESSFUL APICULTURE.

(Continued from page 268.)

SEALED CELLS IN COMB.

"There are four sealed brood-cells on one of the combs. Are they foul brood?"

"No, I think not; but it is wise never to leave sealed cells in a hive. Examine them, and see what they contain. If there are dead, unhatched bees, the cells are all right, because in foul brood the contents would have become a rotten mass. If the cells are mouldy there is no foul brood, as mould germs are not present with this disease; but if, on the other hand, the cells are apparently empty, make a close examination, and see if on the lower sides of the cell are resting dried-up scales, which would show foul brood in the spore condition. The four cells while closed are inactive, but if opened even after a lapse of years the disease will be sure to appear in the brood."

"Each of the cells contains a dead bee."

"That is nothing to cause alarm. Never leave closed brood-cells in a comb, and do not transfer to another hive, but keep such a doubtful stock in quarantine.

"You clean the hive while I examine No. 10. Four frames of brood, but very short of stores. What have you left out of No. 5?"

"Two good combs, half full of stores."

"I will exchange these for two empty ones. Bring the thickest syrup also, and pour some into the comb, for it is the best way of feeding stocks that are short. Book five combs of brood. This is a bad roof. Just hand me that self-opening tin out of the tool-box, which contains the beeswax dissolved cold in motor spirit. With it we can quickly stop up this leak."

FINDING AND CLIPPING QUEEN.

"We have to clip the wings of this queen. See if you can find her for me."

"How can I best tell her?"

"Look for her long legs. They are most quickly detected by one not well

accustomed to bees. If you do not discover her at once, try a systematic way of seeking her. You have heard of the Nassanoff canal, which Sladen discovered to be a scent-organ—well, this will guide you in detecting the queen.

"Take out two or even three combs, put them on one side, well covered up so as not to attract robbers. Your stock subdued, lay a pliable quilt over the frames, and use your lightly carbolised cloth at the end nearest to you. Now get out your first frame, and as you do so glance at the comb-face of the next one in the hive. If the queen is in a hurry to get away from the light, her legs are easily seen as she runs towards the bottom of the comb, and it is only a moment's work to put down one frame and lift up another before she escapes. In this way a queen that runs from comb to comb may often be caught. If this fails, examine your combs, always holding each over the hive, lest the queen should drop off on to the ground, and allow the light to fall on to the comb.

"You have four combs near you, and three not yet examined at the other side of the hive, with a broad belt of light between. The queen will not pass this light part, and if you have not missed her she will still be on one of the three combs. This you can easily prove by Sladen's scent-organ.

"See, all heads are turned towards the three combs, so she is still undiscovered. Proceed now with extra care. I saw her run down that last comb away out of sight. In your eagerness to examine the comb you held you forgot to glance down the next one. Now give me your last comb to hold while you drop down on your knees and search the hive-side. Throw the veil back from your face."

"Here she is!"

"Keep cool, and pick her up by the wings with the right hand. Now let her feet grasp your left fore-finger in such a manner that the thumb holds the thorax. The queen will not sting you. She will now curl her abdomen round your finger, leaving the wings free to flap. Take the scissors, and cut with the point. Hold them clear of the abdomen, and cut only the very tips of both wings.

"You see, I have laid the comb flat. Drop the queen on to it, and allow her to gain a foothold and recover her dignity before you lower the comb into the hive. Make a note of this hive. Three frames of brood and a clipped queen."

"Why did you clip two wings instead of one? Some bee-keepers clip the right wing one year, and the left the next, so that they know the age by their wings."

"That plan will tell the age, but I don't like it myself. To clip through the

heavy nerves makes the queen very liable to be deposed as faulty, and one wing fully clipped unbalances her, and there is danger of her being lost. By clipping both wings slightly the queen cannot fly far, and it is a sure mark to recognise her by, and show you that she has not been superseded.

"Bring along that empty hive, and let us change this last stock."

"The top bars won't fit."

"Then we will leave it, and take the hive home to alter it. I don't believe in making frames to fit the hive, but to make the hive to take the standard frame, top bars included, and so save trouble later."—JOSEPH GRAY, C.C. Lecturer.

(To be continued.)

Bee Shows to Come.

August 10, at Holyhead.—Annual Honey Show of the Anglesey B.K.A. Entries closed.

August 10 to 12, at Beverley.—Show of Honey, &c., in connection with the Royal Yorkshire Agricultural Society. Entries closed.

August 11, at Wye (Kent Honey Show).—Entries closed.

August 18, at Lancaster.—Lancaster Agricultural Society, in conjunction with the Lancashire B.K.A. Entries closed.

August 18, at Salisbury.—Annual Show of the Salisbury and District B.K.A. Five classes open to the United Kingdom, including Single Section and Single Bottle. No entry fee. Schedules from Hon. Sec., J. E. Pinder, Salisbury. Entries close August 11.

August 18 and 19, at Shrewsbury.—Annual Show of the Shropshire B.K.A., in connection with the Shropshire Horticultural Society's Great Floral Fête in The Quarry. Nine Open Classes for Honey and Wax. Schedules from Hon. Sec., S. Cartwright, Shawbury, Shrewsbury. Entries close August 12.

August 21, at Elworth, Sandbach.—In connection with the Elworth Athletic Club and Horticultural Society's Show. Class for Honey open to the County of Chester. Prizes: 1st, 15s.; 2nd, 7s. 6d.; 3rd, 5s.; for 12 Jars Run or Extracted Honey; also Bronze Medal given by the Cheshire Bee-keepers' Association. Entry fee, 1s. Schedules from E. Jones, Hon. Sec., Elworth, Sandbach. Entries close August 14.

August 24, at Cartmel, Lancs.—Bee and Honey Show, in connection with the Cartmel Agricultural Society's 37th Annual Show. Open Classes. Schedules from J. N. Parker, Cartmel, near Carnforth. Entries close August 12.

August 25, at Brislington, Bristol.—Annual Show of Honey, Wax, and Appliances of the Somerset B.K.A. Extended Schedule and increased prizes. Seven open and two free classes. Schedules from Mr. James Brown, Show Sec., 31, Bridge Street, Bristol. Tel. 2176y. Telegrams, "Brown, Bristol." Entries close August 21.

August 25 and 26, at Stratford-on-Avon.—Annual Show of the Warwickshire B.K.A., in connection with the Warwickshire Agricultural Society. Schedules from J. N. Bower, Hon. Sec., Knowle, Warwickshire.

September 1 and 2, at Carlisle.—First Annual Show of the Cumberland B.K.A. Ten Open Classes (including Honey Trophy) for Honey, Hives, and Wax. Liberal Money Prizes in all Classes; also the C.B.K.A. Certificate of Merit to best exhibit in each class. Schedules from G. W. Avery, Hon. Sec., Heads Nook, Carlisle. Entries close August 18.

September 2, at Stockport.—Annual Show of Honey, &c., in connection with the Adlington and

E. Cheshire Agricultural Society's Honey Department, under the direction of Cheshire B.K.A. Schedules from Mr. J. O. Garner, Ivy House, Bramhall, Stockport. Entries close August 24.

N.B.—Exhibitors who are showing at Bramhall on September 4 can have their exhibits removed to Bramhall if they will enclose 3d. for carriage of same at time of entry.

September 4, at Bramhall, Stockport.—In connection with Bramhall Horticultural Show. Honey Section under management of C.B.K.A. Liberal prize list for Honey, Extracted or Sections, and Wax. Silver and bronze medals for Local Class. Schedules of Mr. J. O. Garner, Secretary, Ivy House, Bramhall, near Stockport. Entries close August 24.

September 4, at Crayford, Kent.—Annual Honey Show. Open Classes. Sections and Jars (Light and Dark), 6 of each. Entrance fee 1s. Schedules from J. M. Bates, Hon. Sec., Warren Road, Bexley Heath.

September 7 and 8, at Derby.—In connection with the show of the Derbyshire Agricultural Society at Osterley Park, Derby. Honey Department under the direction of the Derbyshire B.K.A. Several Open Classes. Schedules from Hon. Sec., R. H. Coltman, 49, Station Road, Burton-on-Trent. Entries close September 1.

September 13, at Conway, N. Wales.—Annual Honey Show, in connection with the Conway Honey Fair. Open and local classes. Schedules from J. Hughes, Town Hall, Conway. Entries close September 6.

September 16, at Castle Douglas.—In connection with Dairy Produce Show, the annual show of the South of Scotland Bee-keepers' Association. Open Classes for three 1-lb. Jars (20s., 10s., and 5s.); three Sections (20s., 10s., and 5s.); entry 2s. One Jar (5s., 3s., and 2s.); one Section (5s., 3s., and 2s.), entry free, but exhibits forfeited unless otherwise arranged. Beeswax (5s., 3s., and 2s.); entry 6d. Thirteen Classes Confined to Members. Numerous prizes, including two Challenge Cups and gold and silver medals. Schedules from Q. Aird, Hardgate School House, Dalbeattie, N.B. Entries close September 4.

September 16, 17, and 18, at Crystal Palace.—Surrey B.K.A. Annual Exhibition of Bees, Honey, Wax, Appliances, &c. Twenty-seven classes (nine open to all). Many medals and increased prizes. Schedules from F. B. White, Secretary, Marden House, Redhill, Surrey. Entries close September 1.

September 18 to 25, at the Agricultural Hall, London.—Honey Show in connection with the Seventeenth Annual Exhibition and Market of the Grocery and Kindred Trades. Liberal prizes. Open to all British Bee-keepers. Schedules from H. S. Rogers, Secretary, Exhibition Offices, Palmerston House, Old Broad Street, London, E.C.

September 22, at Altrincham.—Honey Show, in connection with the Altrincham Agricultural Show, the largest one-day show in the Kingdom. Classes open to United Kingdom. Classes for Trophy of Honey, for Best Hive, Observatory Hive with Bees and Queen, twelve Jars of Extracted Honey. Classes open to County of Chester, for Run and Section Honey, Wax, &c. Special Classes for Cottagers, and Special Classes for Society's District. Good prizes, low entrance fees. Schedules from Mr. J. Herbert Hall, 2, Dunham Road, Altrincham. Entries close September 4.

Queries and Replies.

[3959.] *Starting Bee-keeping on Two Acres of Land.*
—I shall be much obliged for an answer to the enclosed questions in the B.B.J.: What capital would be required to start bee-keeping in a small way by a single man who understands bees, could make all the hives, &c., and breed all his queens? He holds the third-class certificate of the B.B.K.A. Could he make a good living out of two acres of land by keeping bees and poultry, and by fruit and flower growing? What would be the smallest

capital he could start on to make a success of it? Which of the three counties would be the best—Devon, Somerset, or Dorset?—QUEEN-BEE, Dorset.

REPLY.—If you will turn to page 281 of B.B.J., you will see a review of a book called "Winning a Living on Four Acres." The author started with a capital of £117, and managed to make £45 at the end of two years. It is impossible to say how much could be made out of two acres, as all depends upon the practical as well as the business ability of the man. We would recommend you to get the above book, and after reading it decide for yourself if you are prepared to make the venture. All three counties are good. If any of our readers who have had practical experience of starting in this way can give our correspondent any assistance, we shall be glad to hear from them.

[3960.] *Catching the Queen.*—Your correspondent L. S. Crawshaw (page 277, B.B.J., July 15), referring to "D. M. M.'s" "Don'ts"—"Don't pinch a queen when examining her"—goes on to say: "But it is not everyone who can catch a queen to pinch her." This, to me, seems the big difficulty in re-queening a stock. I presume there is no other mode except lifting out the comb, finding her, then taking her off by the thumb and finger. If you know an easier way, will you kindly name it?—GEORGE CRAPPER, Yorks.

REPLY.—Another way is to use the pipe-cover cage described on page 135 of "Guide Book." The cage is placed over the queen and a card slipped underneath. The cage and card are then placed on the comb, and on withdrawing the card the cage is pressed into the comb. The whole operation can be performed without touching the queen with the fingers.

[3961.] *Bees Running about Floorboard.*—1. Will you be kind enough to tell me the probable cause of my bees running all about the floorboard outside the hive after they have ceased flying for the day? They do not seem to have any definite purpose in so doing, but they spend quite an hour every evening in this manner. I may say that they have plenty of room, as there are three supers on each of my two hives, none of which are full. 2. I also find drone-brood in one or two of the sections, but no worker-brood, although the frames below are fairly full of sealed worker-brood. I do not use queen-excluder zinc, as I think the bees work better without it, and get very few sections spoilt in this way. But why should there be drone-brood only? 3. I have had sixty sections off each of my two hives already, which I think is pretty good, don't you? 4. Why do they store pollen in some of the sections?—BEGINNER, Somerset.

REPLY.—1. Bees are sometimes disturbed by the wax-moth, which endeavours to enter hives of an evening, and is probably the cause in this case. They also frequently run about in the way you describe when they have lost their queen. 2. Because the queen found drone-comb in the sections and there was plenty of worker-comb below. 3. Yes, it is very good. 4. Because they have brought in more than they find room for below.

[3962.] *Fertile Worker.*—Being in doubt re the following point, I should feel obliged if you will enlighten me as to why a swarm covering eight frames is filling brood-combs with honey and syrup instead of brood. There is no worker-brood, but several capped and uncapped drone-cells, and the combs are very irregular. The bees have been well fed. One of the eight combs is not drawn out yet.—C. W. CATTON, London.

REPLY.—The reason of your bees filling brood-comb with honey, and there being no worker-brood and only several cells containing drone-brood, is because the colony has lost its queen and a fertile worker is laying.

Notices to Correspondents.

ROSEWATER (Essex).—*Honey-dew.*—1. You can distinguish honey-dew from honey by the taste and appearance. It is generally dark and nearly black, and slightly bitter in taste. Honey may contain more or less of it, and will vary in colour with the amount found mixed. 2. If the honey is taken out of sealed combs and is of good consistency it will not require further ripening, but can be used at once. 3. Yes, if you send a sample we can advise you. 4. Mr. G. R. Alder, Rawreth, Essex, is the secretary of the County Association, who would give you any particulars you desire, and you could then decide if you wished to join.

A NOVICE BEE-KEEPER (Kendal).—*Re-queening Vicious Stock.*—A Carniolan would suit your purpose, but Carniolan bees are great swarmers, the queens being very prolific. (See "Guide Book," page 144.) You can prevent swarming sometimes by giving more room, and twelve frames would not be too many. You could have prevented all swarms after the first from issuing by removing all queen-cells but one from the hive that swarmed, and by placing swarm on the stand of parent stock, removing the supers from the latter to the swarm. The depopulation of the hive would have prevented further swarming, and work in supers would have been continued.

A READER (Middlesex).—*Bees Dying.*—There are several complaints in which bees behave in a similar manner, and you can only tell by observing the general behaviour of the stock. If only one stock is affected and the symptoms are similar to those described on page 231 of B.B.J., either destroy the bees and combs, or try the remedies recommended, and if the bees, on examination, are short of food give them some syrup.

A NOVICE (Rugby).—*Bees Working in Supers.*—1. Your bees have evidently too much room in supers. Remove section-rack, leave super with shallow frames as it is, and if the honey-flow continues the bees may finish some more of the combs. 2. Your swarm is not strong enough to give an artificial swarm this year, and you should defer it until next spring. A hive should be crowded with bees, and the fact of your bees not working in supers shows that they are not strong enough to be divided.

LACTO (London).—*Wintering Bees, &c.*—1. The object sent is a dried-up, undeveloped pupa, and is covered with mould, showing it to have been dead some time. 2. In wintering push all the frames to the back and leave air-space in front. 3. In a ten-frame hive the wide spacing for uniting is obtained by removing the outer frames, and using those in the centre containing brood. If there are not sufficient of these, fill up with combs containing some honey. In a "Combination" hive put brood in centre and add other combs according to the strength of the colony. 4. Sladen's "Golden Prolific" are very good bees, and as your stock has done so well you cannot do wrong in propagating this race.

NOVICE (Lancashire).—*Having Swarm.*—1. The best way would have been to have the swarm on all the frames and next day to have removed such as were superfluous, putting them outside the division-boards. The bees naturally preferred the empty space to that having frames. 2. The bee arrived perfectly flat, and is an immature worker.

NOVICE (Hawick, N.B.).—*Bees Swarming.*—1. Your first swarm was retarded, probably by bad weather, and this was the cause of the second swarm issuing sooner than you expected. 2. It is not at all unusual to find as many as twelve queen-cells capped in stocks of prolific races of bees.

ANOX (Herts).—*Name of Bees*.—1. The crushed bee with a pin in it is a common worker. 2 and 3. These are drones not fully developed cast out before their wings had been formed.

J. G. W. (Motherwell, N.B.).—*Cause of Late Swarming*.—It is difficult to say why bees will swarm notwithstanding all the precautions taken to prevent them. As you returned the first swarm and cut out all queen-cells, they deferred the swarming until the weather was favourable and fresh cells had been constructed. They may also have superseded their queen, and the swarm may have come out with the young queen. It is not unusual to find as many as twelve queen-cells on the combs. There are many complaints this season about bees not finishing off sections owing to the cold weather, and in some places what honey was stored was carried down by the bees.

J. H. L. (Blagdon).—*Bees Swarming*.—1. It is very difficult to prevent bees from swarming when they have determined to do so, and nothing the bee-keeper can do seems to stop them. Bees from skeps are much more liable to swarm than those reared in the larger frame-hives. "British Golden" are a good race, and you would do no harm in re-queening with them as you propose, but we cannot say if you will entirely prevent swarming by doing so, as much depends on the bee-keeper himself doing the right thing at the right time. 2. The nearest expert is Mr. S. Jordan, 25, Longfield Road, Bishopston, Bristol.

J. I. (Lanarkshire).—*Loss of Queen*.—1. The queen sent is not a "British Golden," and cannot, therefore, be the one you introduced, which has probably been superseded by the black queen you found in the hive. It is possible you may have omitted to cut out all the queen-cells when you introduced the golden queen, or they had a second queen which was overlooked. The queen sent is a young one, probably from another hive. 2. Woven wire, eleven meshes to the inch, is what is used for heather-honey press, and it must be tinned, otherwise it is sure to discolour the honey. See page 87 of "Guide Book."

F. H. (Westmoors).—*Sugar for Winter Food, &c.*—1. The proper sugar for making autumn food for bees is white lump cane (page 197 of "Guide Book"). 2. The quilts should consist of a layer of unbleached calico or of "bed-ticking," laid on the frames, and over this two or three layers of druggot or felt (see page 38 of "Guide Book").

E. G. (Erdington).—*Cleaning Dirty and Rusty Extractor*.—Remove the rust with paraffin, then scrub it thoroughly with "Monkey Brand" soap and hot water, and be careful to remove every particle of paraffin, which would otherwise spoil the honey.

OPTIMIST (Somerset).—*Driving Bees from Wooden Boxes*.—It is possible to do this in the same way as driving from skeps, but you would have to strike the sides of the box much more vigorously so as to jar the combs.

NOVICE (Derbyshire).—*Uniting Swarms*.—1. Bring the hives close together by degrees, and then you can unite the stray swarm with the one in frame-hive. 2. Yes; you must dust both bees on frames and the others with flour.

A. S. L. (Chatham).—*Changing Breeds*.—If you can introduce your black queen in shallow super, and take the proper precautions to make sure that she is accepted by the bees, your plan would be feasible as regards carrying out the principle of keeping the two queens apart by means of excluder. We suppose that you are going to introduce the brood with the queen into the super, so that the hatching-bees will look after her, as you propose "to keep some bees with her until her eggs begin to hatch." It would be possible to separate them into two in the spring, if the queens survive through the winter, but frequently they do not do so. Much

the simpler plan would be to remove the undesirable queen, and introduce the black one in the usual way.

F. G. (Royston).—*Insects in Hive-roof*.—The insects sent are nocturnal moths.

A CONSTANT READER (Chatham).—*Working Two Stocks in One Hive*.—If you want two stocks to work in one super you must use a board between them with small holes bored in it, on the "Wells" principle. In this way both acquire the same scent, and in the spring excluder-zinc can be placed on top of the frames, and the super on this, allowing both colonies to work together, but keeping the queens apart. A hive made of a "Quaker Oats" box to hold sixteen frames is hardly large enough for two colonies, and it would be better if made to hold ten frames on each side of perforated board.

T. B. (Haverhill).—1. The brood is chilled only, and there are no signs of dysentery. 2. Honey will be quite fit for use. 3. You should feed the bees, or they will starve during this inclement weather.

M. D. (Slisden) will be pleased if any bee-keepers who have used paper-pulp honey-pots will give an opinion as to their efficacy, or the disadvantages (if any) of using them for liquid honey.

Honey Samples.

AMATEUR (Worcestershire).—Dark colour is caused by honey-dew. Though not fit for table use, it might be sold for manufacturing blacking or other purposes. Yes, it might be used for bee-food. The value is only about half that of good honey.

H. B. K. (Knutsford).—The dark and muddy colour is caused by honey-dew, which has been very troublesome this season.

Geo. C. (South Woodford).—Honey is from mixed sources, but spoiled by honey-dew; there is no flavour of lime in it. The process of eliminating honey-dew is too tedious and costly to make it worth while; it is better to feed the honey back to the bees.

Special Prepaid Advertisements.

Twelve words and under, Sixpence; for every additional Three words or under, One Penny.

3-FRAME NUCLEI, from 10s. 6d., headed by young Queens; British Queens, 3s.; Hybrids, 4s.; Imported Italians, 5s.; Swarms.—E. WOODHAM, Clavering, Newport, Essex. s 81

DRIVEN BEES, strong lots, free from all diseases, with young Laying Queen; safe arrival guaranteed, 5s. 5d. per lot; young Laying Queens, 3s. each.—BRADFORD, Bee Expert, Worcester. s 88

WANTED, DRIVEN LOTS, Carniolans or Sladen's Golden Bees.—H. SHARD, The Hough, Alderley Edge, Cheshire. s 87

HEALTHY DRIVEN BEES, with Queen, 5s. lot; boxes returnable; spare Queens, 2s. 6d. each.—MORETON, Bee Expert, Hallow, Worcester. s 89

DRIVEN BEES, good, healthy lots, with young Queen, 5s., on rail; selected 1909 Queens, 2s. 6d. per post.—SOLE, Expert, Stotfold, Beds. s 92

WANTED, Pure Italian or Carniolan Bees, in strong lots, 1s. 4d. lb. given if received early.—D. JOHN, Mwyndy Cottages, Llantrisant, Glam. s 77

FOR SALE, Extractor, by Root, takes six Standard Frames at once.—WOOD, Bottisham, Cambs. s 86

HEALTHY DRIVEN BEES, with Queen, 5s.—HIGLEY, Expert, Mason-street, Kidderminster. s 80

Editorial, Notices, &c.

BRITISH BEE-KEEPERS' ASSOCIATION

A special meeting of the Council was held at 105, Jermyn Street, London, S.W., on Thursday, August 5. Present: Mr. T. W. Cowan (in the chair), Mr. W. F. Reid (Vice-Chairman), Mr. R. T. Andrews, Mr. C. L. M. Eales, Mr. O. R. Frankenstein, Mr. E. Garcke, Mr. J. B. Lamb, Mr. F. B. White, Mr. Arnold Richards, Mr. G. H. Skevington, Mr. E. D. Till, Mr. Joseph Tinsley, and Lieut.-Colonel H. J. O. Walker.

Four new members were elected, viz.: Mr. David Hancox, Deddington, Oxon; Mr. T. D. Sinfield, 26, Upper George Street, Luton; Miss F. M. Stange, White Lodge, Collington, Bexhill-on-Sea; and Mr. F. W. Watts, Lowood, Alleyn Road, Dulwich.

The meeting was specially called to discuss Mr. Garcke's scheme for extending and improving the work of the Association. Introducing his proposals, Mr. Garcke stated that there are in England about twenty-nine county associations and about twelve counties without associations. The associations have about 6,500 members. This figure represents only about 10 per cent. of the estimated number of bee-keepers in the counties represented by the associations. About 115 members pay £1 and upwards per annum, about 210 members pay between 10s. and £1 per annum, and about 6,200 members pay an average of 3s. per annum. The aggregate income of all the county associations is: From subscriptions, £1,200 per annum; from County Councils, £500 per annum; from donations, £200 per annum—total, £1,900.

The B.B.K.A. has an annual income from members' subscriptions of £90, and from donations about £50—total £140, and its revenue from other sources is about £150 per annum. Only two or three of the associations have cash balances exceeding £100 each, while the cash balances of the other associations average only about £15 each. The average membership of all the associations is one subscriber to 4,000 of the population; but the Cumberland Association has one subscriber to 450 of the population of the county; the Lincolnshire Association has one subscriber to 700 of the population; and the Surrey Association has one subscriber to 1,100 of the population. If all the associations had memberships equal to that of the Surrey Association there would be 20,000 subscribers, and, assuming an average subscription of only 3s. per additional member, there would be an annual revenue of £3,315 instead of only about £1,290; but even this need not be

regarded as the limit of the attainable position, as is evident from the figures in regard to Cumberland and Lincolnshire.

The reports of the associations demonstrate that some associations are doing much better than others as to organisation, as to the number of their members, and as to donations they obtain from County Councils. It is difficult, however, to say in all cases whether the disproportion in the number of members of the associations is attributable to the relative number of bee-keepers in the respective counties, or to the lack, or otherwise, of energy and organisation on the part of particular associations in securing bee-keepers as members. It is clear, however, that, taking the counties as a whole, only a small proportion (10 per cent.) of the estimated number of bee-keepers belong to any association, and also that the financial position of the associations taken collectively is not strong. Nevertheless, it cannot be gainsaid that the associations are doing excellent work, and that the beneficial results of their labours would be materially enhanced if more bee-keepers became members.

The foregoing statistics and conclusions suggest the advisability of determining whether it is better: (1) to increase the number of bee-keepers; (2) to organise the existing bee-keepers, and make their apiaries more efficient and more productive; or (3) to do both.

In the language of the apiarist, it is necessary for the associations to decide whether to work for increase or for strength and yield. Makers and sellers of appliances will probably favour an increase in the number of bee-keepers; producers of honey, on the other hand, will probably favour a limitation in the number of bee-keepers. The foregoing statistics and other evidence point to the wisdom of getting the organisation in order and increasing efficiency and vitality before further augmenting the number of bee-keepers.

If this view be accepted, the next question to be determined is—What is the best way of accomplishing the objects stated? Is it better to centralise or to decentralise the organisations, or is the ideal arrangement to be found in a combination of both centralisation and decentralisation? It is evident that any single county association cannot do the work of the industry as a whole, nor can any county association very well do executive work outside the area of its influence. In such matters as examinations of candidates and representations to Parliament and Government departments, and negotiations with other bodies, collective action is necessary, and some central body is

essential. On the other hand, a national association cannot without decentralisation or very elaborate executive organisation meet the requirements of individual bee-keepers.

A consideration of this question will suggest that a choice must be made between a consolidation of all existing associations into one association having county divisions and district subdivisions, and embracing the members of all associations; or separate county associations, as at present, with a central association, or federation, which would be without individual members, but would be sustained by contributions from the county associations on some equitable basis, say in the proportion of their revenues.

1. To convert all the associations into one association with subdivisions will present many difficulties. Some of the associations would certainly dislike surrendering their independence, and even if such a proposal could be carried by a majority of votes, the settlement of the details of the organisation, especially the financial arrangements, would no doubt involve discussions of a kind which it would be better in the interests of unity to avoid.

2. Effect could be given to the idea of a federation of all the existing associations without disturbing the constitution or organisation of any of the associations other than those of the B.B.K.A., and the main principles having been agreed to by all parties, the consequential steps could be taken, after due deliberation, without necessitating any upheaval of existing conditions. The B.B.K.A. would have to disband its members and advise them to join the associations of their respective counties. The B.B.K.A. would then be maintained by each county association contributing a minimum subscription of £1 1s. per annum, and, say, 5 per cent. or 7½ per cent. of its gross revenue from members' subscriptions, not taking into account any donations for special purposes from County Councils and others. The contributions paid by the county associations would approximately equal the present revenue of the B.B.K.A. derived from members' subscriptions. Such a contribution would not impose a heavy burden upon any association, especially in view of the fact that the memberships of the county associations would certainly increase, and that the associations would benefit in a variety of ways. In order, however, not to expose any association to the danger of a reduction of its present resources, it is suggested that the percentage contribution to be made to the B.B.K.A. should be made only out of increased revenue from subscriptions in excess of the pre-

sent revenue from that source, and it is further suggested that in order to protect the B.B.K.A. against the remote risk of not having a revenue at least equal to that which it surrenders by disbanding its members, a guarantee fund should be formed to provide that the revenue of the B.B.K.A. from contributions by county associations should, for the next three or four years, be not less in any one year than the present subscriptions of members of the B.B.K.A. No difficulty is anticipated in regard to the formation of such a guarantee fund.

Under this suggested scheme the interests of the B.B.K.A. would be made perfectly identical with those of the county associations, whereas under the present arrangement the B.B.K.A. cannot promote the increase of the county associations without, in a measure, aggravating its weakness. Under the suggested scheme there would obviously be more *esprit de corps* among bee-keepers generally to work for their common interests.

The new constitution and organisation of the B.B.K.A., acting as a federation of the county associations, would have to be settled by a new council, elected by the county associations. It would, of course, be advisable that the B.B.K.A. should continue to hold examinations and grant certificates, but it is a matter for consideration whether in future it should not be a condition that every candidate for examination should be a member of an affiliated association, and that the validity of the certificate should cease with membership, and that the respective county associations should defray the expenses and receive the fees.

In conclusion, Mr. Garcke moved:

(a) "That in the opinion of this meeting it is desirable, with a view to removing an obstacle to the establishment of complete identity of interests between the B.B.K.A. and all the county associations, that the members of the B.B.K.A. be recommended to transfer their future subscriptions to their respective county associations in consideration of the county associations agreeing to pay to the B.B.K.A. a minimum annual affiliation fee of one guinea, and also a percentage to be settled of the total amount received by each county association in respect of subscriptions, but not in respect of donations from County Councils and others for special county or other purposes, and that such percentage shall be payable only out of increased subscriptions received in respect of the subscriptions for 1908. This arrangement to come into effect as from January 1, 1910.

"(b) That a guarantee fund be formed of £200 for the purpose of guaranteeing

to the B.B.K.A. an annual income of not less than £90, including the affiliation fees payable by the county associations. The guarantors to be discharged at December 31, 1912, and any surplus funds remaining to be returned rateably or to be dealt with as directed by the guarantors.

“(c) That a committee, consisting of five members of the Council, be appointed to consider the best means of giving effect to the foregoing resolutions, and to report to the Council.”

A long and detailed discussion followed, participated in by Mr. Tinsley, Mr. Till, Mr. White, Mr. Richards, Colonel Walker, Mr. Frankenstein, Mr. Reid, Mr. Lamb, and the Chairman. The resolutions were formally seconded for the purposes of discussion; but they were not generally favoured, and in the end Mr. Garcke withdrew them.

On the motion of Mr. Reid, seconded by Mr. Tinsley, Mr. Garcke was heartily thanked for taking the trouble to formulate his scheme and bring it before the Council.

W. B. CARR MEMORIAL FUND.

Amount already acknow- ledged	£	s.	d.
.....	55	11	6
C. H. Haynes.....	0	5	0
Rev. Sidney Smith.....	0	5	0
Miss E. Scott Walker.....	0	5	0
H. Webber	0	3	0
J. R. Truss	0	2	0
C. H. Curling	0	1	0
W. Yarwood	0	1	0
D. H. Durrant	0	1	0
“Grosmont”	0	1	0
“Anon”	0	1	0
	£56	16	6

NOTTS B.K.A.
ANNUAL SHOW.

The above association held its annual show, in conjunction with the Horticultural Society, at Mansfield on Bank Holiday, August 2, the weather being on that day an improvement on the past few weeks. The entries were slightly below last year's, but, contrary to expectations, exhibits turned up well, and the tent set apart for these was well filled. This year for the first time a challenge cup, generously provided by Wm. Herrod, Esq., of Luton, was competed for, and the winner of this was Mr. W. Lewin Betts, of Mansfield-Woodhouse. Three years ago the annual show was held at the same place, when the late Wm. Broughton Carr, Esq., undertook the duties of judging, and I believe this was the last show, outside the “Royal,” at which he officiated. I am glad to remember him saying, after the day's work was over, how pleased he

was with every arrangement and how very much he had enjoyed the day.

This year Mr. W. Herrod undertook the judging of exhibits, assisted by Mr. R. J. Turner, of Radcliffe-on-Trent. Mr. Herrod also gave lectures in the beehive to crowded audiences, and examined three candidates for third-class expert certificates, working very hard all day.

The awards were as follow:—

Honey Trophy.—1st, W. L. Betts, Mansfield-Woodhouse; 2nd, Uriah Wood, Arnold.

Exhibit of Light-coloured Extracted Honey.—1st, A. G. Pugh, Beeston; 2nd, J. T. Wilson, Shirebrook; 3rd, W. L. Betts; 4th, Geo. Marshall, Norwell.

Exhibit of Dark-coloured Extracted Honey.—1st, Dr. Elliot, Southwell; 2nd, Geo. Marshall; 3rd, W. Lee, Southwell; 4th, Jno. Woods, Nettleworth.

Six 1-lb. Sections.—1st, W. Lee; 2nd, G. H. Pepper, Oxtun; 3rd, W. L. Betts.

Six 1-lb. Jars Granulated Honey.—1st, J. T. Wilson; 2nd, John Woods; 3rd, H. Merryweather, Southwell; h.c., Geo. Marshall.

Exhibit of Extracted Honey (Amateurs).—1st, C. F. Fincham, Nottingham.

Six 1-lb. Sections (Amateurs).—1st, John Woods.

One Shallow Frame.—1st, John Woods; 2nd, W. L. Betts; 3rd, Geo. Marshall.

Specimens of Bees.—1st, W. L. Betts; 2nd, Geo. Marshall.

Beeswax.—1st, Geo. Marshall; 2nd, Uriah Wood; 3rd, A. H. Hill, Balderton.

SPECIAL PRIZE.

The “Herrod” Challenge Cup (offered for the highest number of points obtained by an exhibitor).—W. L. Betts, Mansfield-Woodhouse.—Geo. HAYES, Secretary.

Correspondence.

The Editor does not hold himself responsible for the opinions expressed by correspondents. No notice will be taken of anonymous communications, and correspondents are requested to write on one side of the paper only, and give their real names and addresses, not necessarily for publication, but as a guarantee of good faith. Illustrations should be drawn on separate pieces of paper. We do not undertake to return rejected communications.

NOTES BY THE WAY.

[7560.] One feels obliged to say something anent the weather, as our industry depends on the amount of sunshine we get during the two past and the present months. The waning season of 1909 must be a poor one, and from many correspondents I hear it is a poor season generally not only in the South and the Midlands, but also in the Northern shires and Scotland. A large bee-keeper north of the Tweed said he had not one section sealed

over (this was only a few days ago). I do not remember a season which opened with greater promise of being a record one in the month of May. Stocks were extra strong, forage promised to be abundant; but the resultant weather has spoiled the picture, and here we are at the end of our "storing-in-supers" season with only half a crop. This being the case, "What of the price?" Who will advise us in this matter, and thus enable the unfortunate bee-keeper to secure a better price for his honey, as a solatium for the small harvest.

I can endorse what Mr. Soal (7534) says *re* tough and hard foundation. The modern method of making foundation may ensure that wax only can be used in the "Weed" machine, but my mind reverts to the methods in vogue in the early eighties, when some very excellent brood-foundation was made at the shows at South Kensington by Mr. Abbott, with the plaster casts simply dipped into a vessel of melted wax, shut up like a book, taken out of the wax, and plunged into another vessel of cold water, and the result was stock foundation of very excellent quality. This may not have had the toughness of roller-made foundation, but it possessed a malleability which enabled the bees to utilise the wax when working it into comb. The midribs of the combs were worked down to almost, if not quite, natural-built-comb thinness. It should be impressed upon bee-keepers to level their hives before supering. I have seen many cases of hives out of level, in which several of the sections in the racks were built to the dividers in consequence of neglecting this precaution.

Folding Sections.—My method is to lay a wet folded towel on a brick floor, then place a layer of sections edgewise on the wet cloth. Another wet cloth is placed over them, then another layer of sections (on edge), then another cloth. Leave them till next day, and they can be folded without breaking. I use no block, but simply fold them on a table, and with a pressure of the hand force the toothed ends into place, and the section is ready to receive the foundation. They can be done very quickly—ten or twelve per minute—and square as a right angle. I never use split-top sections, but always fix the foundation with the small roller as recommended by the late Mr. C. M. Abbott. I have tried the split-top and the grooved-all-round sections, but found them not so satisfactory.

I am very sorry to see in B.B.J. that the new bee-disease is spreading, but the trade done in bees at the present time points to the means by which it is spread (*vide* the advertising pages of last week's B.B.J.).—W. WOODLEY, Beeton, Newbury.

VARIOUS BEE-NOTES.

[7561.] Bee-keepers, like astronomers, have had a long wait till "the clouds should roll by," and when the end of July came with little brighter prospects many thought there was no hope of a honey harvest this year for those who could not go to the moors. I know one bee-keeper who on August Bank Holiday had a good look round the fields, and found what he had never seen so late before—great breadths of grass dotted all over with white clover. He said: "If we only get a blazing sun for three weeks we may yet get some clover honey." Briskly he set to work for a couple of days to extract a heterogeneous mixture from fruit, charcoal, beans, and honey-dew, not because he wanted it, but to clear the combs of their dark contents, well knowing that the best honey would be spoilt unless they were emptied. Now, a week later, he is away on a short holiday, but anxiously wondering what his inspection on returning will reveal—whether it is all really too late. But he wants the three weeks extended to a month, or he is afraid his hypothetical "best white clover" will not be sealed over.

Thank you, Mr. Editor, for your opportune note (pp. 304-5) on the secretion of nectar by plants. I rarely pass a meadow with white clover without trying to estimate the proportion of "deadheads" to fresh blossoms. Gathering half a dozen of the latter, the odour which bespeaks later on a delicious aroma is sought. The most prominent organ of the face will sniff with satisfaction if the day be fine, or with disappointment if the day be dull, cold, and gloomy. The deadheads count for a little, not much, because the young flowers' energies for fertilisation are thrown into the later work of seed-development.

Your correspondent (page 303) presumes that Mr. Crawshaw "accepts the theory that most diseases are the result of a vast number of minute collections of gases having regular forms and each in a vitalised state." Mr. Crawshaw is well able to speak for himself, but I always had the impression that gases are almost amorphous, and that, while they have vitalising, or destructive, or neutral properties, they are anything but "all alive." Yet Mr. Green says "they are living, call them germs, microbes, bacilli, or what you like." Why, Sir, if we could reduce the germs, microbes, or bacilli to the gaseous state our bees would no longer have foul brood, and we should have no fear of their resurrection or of their "spontaneous generation." Just possibly the typhoid germ contains hydrogen and carbon; certainly water does. But I never heard of the explosion of a mixture

of the two gases named, scattering typhoid germs all over the laboratory. I do not say that chloride may not be a remedy for foul brood; if not a "Dreadnought," it is undoubtedly a "destroyer." But gases are not germs.—S. J., Bristol.

CANE V. BEET SUGAR.

[7562.] As one interested in bees, I send you the enclosed cutting, thinking it might be of interest, and will simply remark that I do not quite follow Mr. Cluer's reasoning, and I imagine the bees would not either if they were served with beet instead of cane sugar!—J. R. BAXTER, Glos.

Several keepers of small grocers' shops were summoned by the Islington Borough Council, before Mr. Cluer at the North London Police Court on July 16, for selling beet sugar crystals as Demerara sugar.

The magistrate said he took the view in these cases that no great harm was done, the beet sugar being as good as the Demerara sugar. Demerara had become a name which most respectable grocers used in a general way for sugar.

Mr. Bramall, for the prosecution, contended that there was a striking difference between the two sugars. "One," he said, "is made from the sugar-cane and the other from beets." The following sharp dialogue ensued:—

Mr. Cluer: And very good stuff it is! I constantly use it.

Mr. Bramall: It is dyed.

Mr. Cluer: It is quite harmless.

Mr. Bramall: It comes from France and Germany.

Mr. Cluer: Both are excellent countries.

Mr. Bramall: It has less sweetening power.

Mr. Cluer: Then it is less likely to give you diabetes!

Mr. Bramall: I am told that the crystals are so different that beetles will not touch them.

Mr. Cluer: They must be bad judges.

Mr. Bramall: Here we have the produce of a British colony undersold by—

Mr. Cluer (interrupting): I will not have political matters introduced here. If you ask for a bad Jamaican cigar, and you are served with a good German cigar at the same price, surely you are better off! These sugars are about the same thing in quality and in price, and it does seem to me to be a waste of public time and money to worry about what the purchasers receive. There is nothing harmful about beet sugar, and these prosecutions look like worrying shopkeepers unnecessarily.

In the three cases before the court one defendant was ordered to pay the costs, another case was dismissed, and a third adjourned.

[The magistrate above referred to evidently knew nothing about the difference between beet and cane sugar; but as showing the harm done by using the latter, we publish on page 317 an article which shows another aspect of the case, and justifies bee-keepers in using none other than pure cane sugar for bee-food.—Ed.]

ISLE OF WIGHT BEE-DISEASE.

[7563.] Referring to my previous communication with you of the 24th ult. (page 305), it may interest you to know that bees taken from my apiary were forwarded to the Board of Agriculture, and reported upon by them as undoubtedly suffering from the Isle of Wight disease.

The result of my treatment has been most satisfactory, and I may further mention that one hive in particular built up from a nucleus received in July last year, and where the conditions of the artificial food-supply were sufficient for its needs, has never shown any sign of disease; and, further, a nine-comb colony of bees introduced into the midst of the trouble, and fed during the bad weather, is at present in first-class condition, and has already filled one rack of sections.—WILLIAM M. YETTS.

DEALING WITH QUEENLESS STOCKS.

[7564.] Referring to "D. M. M.'s" comments (page 246), and his advice to use brown paper for uniting, I thought perhaps the following experience may be of interest to your readers. I had a queenless stock at the time of reading "D. M. M.'s" suggestion, so I determined to try it, and having a swarm which came off a few days after, I put a sheet of brown paper on the stock, and stood the skep with the swarm on the top of it. It has proved a complete success, with a total slaughter of only four bees.

I regret to say nearly all honey in this district is spoilt with honey-dew.—H. C. PARHAM, Hants.

THE HAMPSHIRE MOORS.

GOOD PROSPECTS.

[7565.] The season here promises to be a good one, for, in spite of unsettled weather, the bees are storing honey very fast. Stocks that have not swarmed are already working in three racks of sections, and early June swarms have nearly filled two racks. The *Erica cinerea*, which is now almost over, has been a good crop, but the ling (*Calluna vulgaris*), which is just coming out, promises to be one of the best we have had for many years.

The latter often fails if the weather is hot and dry in June and July, so that a season like the present delights the heart of a bee-keeper in this district. It has been quite an unusual swarming season, all bee-keepers being unanimous in saying that they have never had so many stocks swarm. My apiary now numbers thirty-three stocks, and I quite anticipate a record honey-yield, for during the six years that I have lived here, although I have never had a bad season (two racks of finished sections per hive being the minimum take), my bees have never been in such a forward condition, nor had so much honey stored in the supers during July as they have at present.—E. W. F., Ringwood, Hants.

FAILURE IN UNITING BEES.

[7566.] Thank you very much for your reply to my inquiry. A few days ago I wished to strengthen a pure Italian stock with black bees from another hive, so I shook a number of these into a skep and fed them with scented syrup. After intimidating the stock I wished to strengthen, I fed that also with a liberal dose of syrup, and then, spacing out the frames, threw down the strangers on the tops.

A tremendous commotion ensued. The legal tenants attacked the intruders with terrible fury, the alighting-board and space behind the dummy being soon covered with groups of fighting bees. Fighting went on for an hour, although I did all I could to restore order. I smoked, rapped the hive, floured the bees, and covered the entrance for a time with a subjugating cloth; all to no purpose. The ground in front of the hive was strewn with dead and dying bees, and today I write with difficulty owing to two nasty stings I received. My advice to beginners who think of uniting "shaken" or driven bees to established stocks is to shake all bees off the combs into a skep, and unite while separated from the combs either by putting two skeps containing bees together and jerking downwards, and so mixing them, or by allowing the two lots to run into the same hive. As "D. M. M." has pointed out, shaking renders bees more or less docile.—E. G., Erdington, August 5.

[Your failure consisted in not fully carrying out the instructions in "Guide Book." In addition to feeding with scented syrup, the bees should have been sprayed, or, better still, dusted with flour. You only did the latter after the bees had commenced fighting, which was obviously too late. We have never heard of a case of failure in uniting in the way

recommended on page 107 of "Guide Book," if the instructions are carried out. It is also pointed out that swarms may be united by shaking them together on a sheet, but the way you suggest would only succeed if the bees were reduced to the condition of swarms by being made to fill themselves with honey. Simply shaking them off the combs does not always succeed, and very frequently leads to fighting.—Ed.]

FOUNDATION AND FOUL BROOD.

[7567.] I have had a similar experience to that of your correspondent H. Wilcox (page 305). I purchased some foundation from a shop in Birmingham, putting two sheets into a hive. Both developed foul brood so badly that I at once (when found) burnt them, the remaining old combs being quite clean. If it has been the fault of the foundation, I consider that the makers are very much to blame.

The enclosed honey samples are specimens of the kind taken about here this year. Your kind criticism would be esteemed.—T. T., Kings Norton.

[Both samples are spoiled by honeydew, No. 1 being quite black and having a slightly bitter flavour. No. 2 has a flavour resembling a cheap sweetmeat known as "raspberry drops." Neither could be called a saleable honey.—Ed.]

CAPPINGS OF COMB.

BY L. S. CRAWSHAW, NORTON, MALTON.

Race Description (page 279).—Correspondent No. 3956 refers very carefully to "the ordinary old English black bee." There would hardly seem to be any room left for another label on his queen to prevent confusion with any other ordinary, or old, or English, or black bee! He may, apparently, rest assured that his bees are "old English." In fact, if he will take the trouble to examine the wing nervures he will easily discover, in Old English characters, the significant letters "o c"!

Brace-combs as Winter Passages (page 283).—Mr. Soal criticises "D. M. M.'s" brace-combs, or burrs, but it is not quite clear how "tall" he imagines them to be. About as high as a "Hill" device apparently! So that candy may be fed amongst the stems, and birds roost in the branches thereof. But surely almost any burr-comb, left after the removal of a super, will provide a winter passage. Less than a quarter of an inch will do,

and the quilt is borne upon a forest of the small columns.

Energy of Swarms (page 284).—After all, this is mainly a question of terms. There is, I think, no doubt that a natural swarm is hard to beat at comb-building. I do not think that either a stock or an artificial swarm can compare with it. The stock has other business in hand, and the artificial swarm is not so well prepared, or, if you like, in the same mood, for the work. And it is this building of comb which makes such a show of work; and it is work, real hard work, though quiet and unobtrusive. The bees are able to concentrate their energies upon their brick-making and the subsequent house-building. I doubt if there are many idle bees in a new swarm, whilst there is always a percentage of resting or loafing bees in an established stock.

Tough Foundation (page 284).—Does this mean that Mr. Soal does not think "Weed" foundation so good as softer varieties? It is claimed for the make (the toughest, I believe) that it will stretch less than other makes. If we may take this for granted, Mr. Soal's criticism seems to lack point, for "Weed" foundation certainly expands somewhat in use, and therefore is not more than necessarily tough. No mean advantage of the tougher make is that foundation can be made much thinner, and, being pure beeswax, it should not lack ductility at comb-building temperature.

Levelling Hives (page 284).—Here is good reason, both precept and practice, for the use of a spirit-level, and very little to the contrary. It is reducing the matter to absurdity to speak of section thickness, a difference which might not be detected by some of the levels in use! And foundation does not always hang true, so that it is well not to encourage any out-of-truth tendency. Quite a small difference in level will seriously affect the hang of a sheet of brood-foundation.

Supering and Controlling Swarming (page 288).—Would not the plan of splitting the brood-nest by the insertion of a super lead very often to the rearing of a young queen in the top half, and perhaps the superseding of the old queen?

B.B.K.A. Meeting (page 296).—Why should not the B.B.K.A. devote some of its millions to a spectacular display? A bee-keeping pageant! Here we should have the history of bee-keeping, with every bee-keeping race represented, and specimens of every type of hive, including the authentic lion which Samson saw, and, if the nuisance inspector would allow, the original Virgilian ox!

SUGAR THAT KILLS BEES AND BABIES.

Under the title of "Sale of Yellow Crystals as Demerara Sugar," Thos. Wm. Blake, M.D., relates an experience in the *Times* newspaper the interest of which is only excelled by its seriousness, as disclosing a fact in the physical degeneration of the nation.

Continuous rainfall having prevented his bees from gathering honey, he supplied them with what was sold to him as Demerara sugar, a food he knew they liked best. To his great astonishment, this was turned out of the hive by the elder bees, though they had neither food nor the chance of obtaining any. He was further surprised to find it undissolved by the rain. Analysis proved it to be a sham sugar, chemically manufactured in Germany, and purchased chiefly by the British poor, who were more easily deceived than the bees, at least old and strong ones, for the young ones ate it, with the result that three hundred were found dead or dying outside the hive the morning after their chemical feed, and, to judge by their death struggles, remarks Dr. Blake, they must have suffered great pain. The next night they were fed with pure sugar, which was devoured without injury. A second feeding with the sham sugar produced the same results, since when they have thrived on pure sugar.

A fair and simple test of the purity of sugar can be made by placing some in a glass stoppered bottle for a few days, then remove the stopper, when, if the sugar is chemically prepared, the odour will be disgusting; but if pure cane sugar—the best and most nourishing of sugars—such as our grandmothers used, only the sweet odour of molasses will be given off.

Further testing showed that the chemically-prepared sugar remained undissolved even after being boiled in test tubes. In twelve hours a "sub-deposit" appeared which proved to be a mineral-oxide, which the addition of strong nitric acid—and again boiling water—would not dissolve. Tin is the hardest of mineral oxides to dissolve. An analytical chemist of high standing informs me that these sham sugars are treated with chloride of tin, which causes the intensely disagreeable odour.

"Now here is the key to a cruel fraud," concludes the public-spirited writer, "and, in my opinion, throws light on the grave questions on causations of increased infant mortality, due chiefly to diarrhoea and enteritis. We, the faculty, know that these metallic chlorides produce both these effects. This metallic-dressed sugar imported from abroad—chiefly Germany—has, I have no doubt, killed more babies than bees, especially in poverty-stricken

towns where it is used in feeding-bottles, with their gruel, or infusion of bread-crusts, as a chief substitute for milk for infants. In the country the poor children get natural feeding, and the mothers are better nourished to supply it, and their progeny are therefore stronger. Hence the difference in infant mortality in towns and country, and the physique of the survivors. An ill-nourished babe will not develop into a strong man. I blame the sugar brokers and not the retail traders in putting this chemical sham-sugar on the market, and also the Government and those in legal authority in not prosecuting them, the brokers, instead of the innocent retailers."—*Herald of Health*.

Bee Shows to Come.

August 18, at Lancaster.—Lancaster Agricultural Society, in conjunction with the Lancashire B.K.A. **Entries closed.**

August 18, at Salisbury.—Annual Show of the Salisbury and District B.K.A. **Entries closed.**

August 18 and 19, at Shrewsbury.—Annual Show of the Shropshire B.K.A., in conjunction with the Shropshire Horticultural Society's Great Floral Fête in The Quarry. **Entries closed.**

August 21, at Elworth, Sandbach.—In conjunction with the Elworth Athletic Club and Horticultural Society's Show. Class for Honey open to the County of Chester. Prizes: 1st, 15s.; 2nd, 7s. 6d.; 3rd, 5s.; for 12 Jars Run or Extracted Honey; also Bronze Medal given by the Cheshire Bee-keepers' Association. Entry fee, 1s. Schedules from E. Jones, Hon. Sec., Elworth, Sandbach. **Entries close August 14.**

August 24, at Cartmel, Lancs.—Bee and Honey Show, in conjunction with the Cartmel Agricultural Society's 37th Annual Show. **Entries closed.**

August 25, at Brislington, Bristol.—Annual Show of Honey, Wax, and Appliances of the Somerset B.K.A. Extended Schedule and increased prizes. Seven open and two free classes. Schedules from Mr. James Brown, Show Sec., 31, Bridge Street, Bristol. Tel. 2176v. Telegrams, "Brown, Bristol." **Entries close August 21.**

August 25 and 26, at Stratford-on-Avon.—Annual Show of the Warwickshire B.K.A., in conjunction with the Warwickshire Agricultural Society. Schedules from J. N. Bower, Hon. Sec., Knowle, Warwickshire.

August 26, at Oxford.—In conjunction with Royal Oxfordshire Horticultural Show, in Headington Drill Hall and Park, Oxford. Open Classes: Single Section and Single Jar Extracted Honey. No entrance fee. Schedules, H. M. Turner, 4, "The Turf," Oxford.

September 1 and 2, at Carlisle.—First Annual Show of the Cumberland B.K.A. Ten Open Classes (including Honey Trophy) for Honey, Hives, and Wax. Liberal Money Prizes in all Classes; also the C.B.K.A. Certificate of Merit to best exhibit in each class. Schedules from G. W. Avery, Hon. Sec., Heads Nook, Carlisle. **Entries close August 18.**

September 2, at Stockport.—Annual Show of Honey, &c., in conjunction with the Adlington and E. Cheshire Agricultural Society's Honey Department, under the direction of Cheshire B.K.A. Schedules from Mr. J. O. Garner, Ivy House, Bramhall, Stockport. **Entries close August 24.**

N.B.—Exhibitors who are showing at Bramhall on September 4 can have their exhibits removed to Bramhall if they will enclose 3d. for carriage of same at time of entry.

September 4, at Bramhall, Stockport.—In conjunction with Bramhall Horticultural Show. Honey Section under management of C.B.K.A.

Liberal prize list for Honey, Extracted or Sections, and Wax. Silver and bronze medals for Local Class. Schedules of Mr. J. O. Garner, Secretary, Ivy House, Bramhall, near Stockport. **Entries close August 24.**

September 4, at Crayford, Kent.—Annual Honey Show. Open Classes. Sections and Jars (Light and Dark), 6 of each. Entrance fee 1s. Schedules from J. M. Bates, Hon. Sec., Warren Road, Bexley Heath.

September 7 and 8, at Derby.—In connection with the show of the Derbyshire Agricultural Society at Osterley Park, Derby. Honey Department under the direction of the Derbyshire B.K.A. Several Open Classes. Schedules from Hon. Sec., R. H. Coltman, 49, Station Road, Burton-on-Trent. **Entries close September 1.**

September 13, at Conway, N. Wales.—Annual Honey Show, in conjunction with the Conway Honey Fair. Open and local classes. Schedules from J. Hughes, Town Hall, Conway. **Entries close September 6.**

September 16, at Castle Douglas.—In conjunction with Dairy Produce Show, the annual show of the South of Scotland Bee-keepers' Association. Open Classes for three 1-lb. Jars (20s., 10s., and 5s.); three Sections (20s., 10s., and 5s.); entry 2s. One Jar (5s., 3s., and 2s.); one Section (5s., 3s., and 2s.), entry free, but exhibits forfeited unless otherwise arranged. Beeswax (5s., 3s., and 2s.); entry 6d. Thirteen Classes Confined to Members. Numerous prizes, including two Challenge Cups and gold and silver medals. Schedules from Q. Aird, Hardgate School House, Dalbeattie, N.B. **Entries close September 4.**

September 16, 17, and 18, at Crystal Palace.—Surrey B.K.A. Annual Exhibition of Bees, Honey, Wax, Appliances, &c. Twenty-seven classes (nine open to all). Many medals and increased prizes. Schedules from F. B. White, Secretary, Marden House, Redhill, Surrey. **Entries close September 1.**

September 18 to 25, at the Agricultural Hall, London.—Honey Show in conjunction with the Seventeenth Annual Exhibition and Market of the Grocery and Kindred Trades. Liberal prizes. **Open to all British Bee-keepers.** Schedules from H. S. Rogers, Secretary, Exhibition Offices, Palmerston House, Old Broad Street, London, E.C.

September 22, at Altrincham.—Honey Show, in conjunction with the Altrincham Agricultural Show, the largest one-day show in the Kingdom. Classes open to United Kingdom. Classes for Trophy of Honey, for Best Hive, Observatory Hive with Bees and Queen, twelve Jars of Extracted Honey. Classes open to County of Chester, for Run and Section Honey, Wax, &c. Special Classes for Cottagers, and Special Classes for Society's District. Good prizes, low entrance fees. Schedules from Mr. J. Herbert Hall, 2, Dunham Road, Altrincham. **Entries close September 4.**

Queries and Replies.

[3965.] *Law Relating to Swarms.*—Will you kindly give me information on a point of law relating to bees? One of my hives swarmed and settled in a neighbour's garden. I saw them settle, and asked permission to go and take them, which was refused, but eventually I went into the garden and took them (without my neighbour's consent). Am I a trespasser? Would my neighbour be entitled to the swarm?—A. T., Bowes Park.

REPLY.—If the swarm was seen to issue from your hive and to settle upon your neighbour's tree, it still remained your property, though in entering his garden to take it you were trespassing. In B.B.J., January 16, 1908, page 30, a reply to a correspondent who asked a similar question to yours appeared; also in the issue of September 17 of the same year there is an article by a barrister-at-law written specially for our paper on the "Ownership of Swarms," which meets your case.

[3964] *Domesticating Humble-bees.*—I derive much benefit from the perusal of the B.B.J., which I get every week. I shall feel grateful if you will

kindly give me some information regarding a colony of wild bees which I discovered the other day in a hole in the wall of an old building. They seem to be very inoffensive, pretty large, and thick-set; black in colour, with some yellow. They appear to be the humble-bee of our schooldays. Would it be possible to domesticate them? If so, how should I proceed? Even in this wet weather, when the honey-bee is doing absolutely nothing, the wild one seems to be leading the strenuous life. Thanking you in anticipation, and wishing your valuable journal a long career of usefulness—M. H. C., Carlingford, Ireland.

REPLY.—Mr. F. W. L. Sladen, who has an extensive knowledge of the humble-bee and its habits, has kindly sent the following information in reply to the above query:—A colony of humble-bees may be transferred without much difficulty into a glass-covered box for observation, if the nest is under the ground or on the surface of the ground; but if it is in a wall the only way to get it out would be to break the wall open. Smoke having no effect on humble-bees, I have found it best to catch the bees one by one, as they come out of the hole, in a glass jar, a sheet of cardboard being placed over the mouth of the jar to prevent escape. The bees thus captured are collected in another similar jar. Digging out the comb and collecting the bees proceed together, so that by the time the comb is reached only a few immature bees and the old queen remain on it, and these are easily secured. Humble-bees will work at a lower temperature, and will commence earlier in the morning and continue till later at night, than honey-bees. They also work on red clover, horehound, honeysuckle, and other long-tubed flowers seldom or never visited by honey-bees. If the weather gets very cold and wet the colony will become foodless and torpid; but it will recover, little or none the worse, when finer weather returns. Towards the end of a favourable season a strong colony will store a little honey in the old cocoon-cells. The honey in these cells is almost, but never entirely, sealed over: it is of very thick consistency, does not granulate, and has a pleasant, mellow flavour. The colony perishes in the autumn, after the young queens have flown.

Notices to Correspondents.

G. HOLLINGSWORTH (Surrey).—*Bees in the Ground.*—If the bees are ordinary hive-bees and are very strong, it may be worth trying to get them out; but probably they will have built far away in a rabbit-burrow, and you would have some difficulty in getting them.

NOVICE (Clapham).—*Race of Bees.*—1. From the flattened specimen sent we should judge it to be a cross of black with Carniolan. 2. We have had no personal experience of keeping bees on a roof of a house 40 ft. above the ground, but they were kept during all last season in the City on the roof of the *Daily Mirror* building and did not desert the hive.

S. C. S. (Motcombe).—*Deserted Skep.*—1. From your description it appears as if the bees had died some time ago, as the powdery comb you have found is probably due to the ravages of wax-moth. If you will examine the skep more closely, and send specimen of comb, we can advise. 2. It is not probable that the swarm came from this skep.

KILARNEY (Glencoe).—*No Eggs in Combs of Swarm.*—1. If the bees refuse to build queen-cells from brood and eggs given to them, it is generally a sign that they already have a queen, although she may not be ready to lay. It is not unusual to find no eggs in swarms hived two days previously, especially in those headed by virgin queens. 2. You can unite driven bees by thoroughly dusting the bees on the combs and

throwing the driven bees in front of the hive, also dusting them thoroughly. You, however, run a risk of their fighting, and much the safest plan is to have a spare hive and carry out the instructions on pages 107-108 of "Guide Book."

APEX (Birmingham).—*Bees Unable to Fly.*—The bees appear all right, and are quite lively to-day (Wednesday). The shortness of food in the hive may account for their behaviour. Feed them with some thick slightly warm syrup. We have heard of many stocks suffering from starvation during this warm weather, and bee-keepers are apt to think that because the weather is fine bees must be able to obtain honey.

C. T. B. (Barnard Castle).—*Dead Bees.*—We can see nothing the matter with bees sent. Examine hive and see if they have plenty of stores, and if short of them, feed without delay.

A. G. HEMMING (Surrey).—*Transferring from Skeps.*—1. It is too late to get bees to transfer themselves from skeps, and you had better wait until spring. You can proceed as you propose, provided there are sufficient bees to protect the brood in the skep until it hatches out. The better plan would be to follow instructions given on page 150 of "Guide Book." 2. You can feed bees in a skep by cutting a hole in the top and placing the board of feeder on it, packing it round to keep it level.

HORTUS (Ammanford).—*Making Artificial Swarm.*—It is getting late in the season for making artificial swarms, and even with a strong colony it is not advisable to do so unless you can introduce a fertile and laying queen. You would certainly have to feed to keep the queen laying.

H. C. P. (Hants).—*Honey Mixed with Honey-dew.*—1. No, it is not injurious to human beings, but if there is much honey-dew in the honey it is unpleasant to the taste. 2. We have had no experience of making mead with such honey, but do not see any reason why it should not do, except for the colour and flavour that it might impart.

NUCLEUS (Birmingham).—*Nucleus Management.*—1. You should keep both separate, and the division-board should fit closely. It can be perforated, but the holes must not be large enough to allow the bees to go through. 2. (a) It is possible to winter a nucleus in the way you propose. (b) Entrance would be better at side or back, because if in front the bees may enter the lower hive, and thus depopulate the nucleus. (c) Yes, if your object is to have brood in upper hive, but under similar conditions we have found one queen amply sufficient, and if there is a paucity of bees such a stock is not in proper condition for doubling. (d) No, queens can be successfully mated even in September.

NOVICE (Llanfair Caereinion).—*Transferring from Skep*—1. It is too late to expect bees to transfer themselves into frame-hives. Examine the hive, and if the queen has gone down put excluder on frames, and replace skep until the brood has hatched out, when the skep can be removed. If the queen has not gone below, drive the bees from skep and put them into the frame-hive. Any combs containing brood can be cut out of skep and tied temporarily into frames, and placed in hive until the brood has hatched. 2. The probable reason that your bees in No. 1 hive do not carry pollen is that they have lost their queen. 3. Ventilating bees stand with their heads inclined downwards, but we have never seen bees "standing on their heads," although they use their heads for packing pollen in the cells.

D. POWELL (Cumberland).—The heather is *Erica vulgaris* or common ling, and is one of the best bee-plants known. Your friend is quite right.

CHELTONIAN (Cheltenham).—Write to the Secretary of the B.B.K.A., 12, Hanover Square, London, W., for particulars of what is required of a candidate for a third-class expert's certificate.

Suspected Combs.

FORESTER (Hants) and W. S. W. (Durham).—Comb is affected with foul brood. Treat as directed in "Guide Book," where full instructions are given for dealing with this and other diseases of bees.

W. E. W. (Northallerton).—There is no foul brood in comb. The brood appears to have been chilled.

Honey Samples.

CONSTANT READER (Bridgnorth).—Good fruit honey with a very slight trace of honey-dew. Aroma and flavour good, but it is rather thin.

F. E. B. (Cambs).—1. Should be entered in light honey class. 2. Contains no honey-dew. 3. That depends on the amount of competition. 4. About 56s. cwt. wholesale is a fair price this season. 5. Examine the combs before extracting. The dark cells contain honey-dew, and can be detected if comb is held up to the light. On the whole it is a very good honey, and has been gathered mainly from clover.

SISTERS OF BETHANY (Crowborough).—The section is quite spoiled by honey-dew. This is a substance exuded by the aphid, a minute insect which infests leaves of trees, especially in dry weather. A small quantity extracted with the honey will cause the latter to have a dark, dirty appearance, and the flavour is spoiled by the bitter taste if a considerable quantity is present. Such honey would be unsaleable as a table honey. It is not poisonous or harmful to human beings, but it is not very palatable. It is better not to winter bees on it. A great deal of honey has been spoiled in this way this year.

J. W. (Llantwit Pardre).—Poor honey, being thin and dark-coloured, and contains honey-dew. See answer to "Sisters of Bethany."

B. (Lewes).—1. No. 1 is good honey from mixed sources, but a large proportion from clover. It is quite good enough for the show-bench as a light honey. No. 2 contains a very small quantity of honey-dew, which spoils the colour, but it is quite fit for table use, though it would not fetch a very good price if for sale. 2. It is not too late for a queen to be mated.

D. THOMAS (Somerset).—Good fruit-blossom honey, mainly from apple blossom apparently.

T. H. (Loscoe).—Sample spoiled by honey-dew.

E. L. (Kent).—Gathered from mixed sources, but has a strong flavour of wild mint. It is thin and dark, with the characteristic dirty colour which shows the presence of honey-dew.

H. J. M. (Horley).—Honey is of very poor quality, being thin and dark in colour.

A. S. WOOD (Hereford).—No. 1 sample is a good medium-colour honey, and would probably secure a prize if shown, though not in competition with light clover. No. 2 is only fair. Both are gathered from mixed sources.

F. J. WIDDOWSON (Notts).—Very good flavoured honey, with slight taint of honey-dew, which will not be noticeable when honey is granulated.

F. H. G. (Dulwich).—Sample seems more like sugar syrup than honey. It also has a slightly burnt taste. The bees have probably been stealing from a sweet factory.

A. P. (Colwall).—You are right as to the source. It is apple-blossom honey, and the strong flavour is characteristic of this source. It is very palatable, and can be classed as a good fruit honey.

X. Y. Z. (Somerset).—Colour of sample is poor, the flavour fair. Probably gathered from mixed sources, but contains no honey-dew.

CONWAY (N. Wales).—The honey is probably gathered from sycamore. It is not of good flavour, but contains no honey-dew.

Special Prepaid Advertisements.

Twelve words and under, Sixpence; for every additional Three words or under, One Penny.

STOCKS, 9 Frames, 1909 Queen, packed free on rail, £1, cash with order; Driven Bees, 1s. 3d. lb.—SNOWDON, Albury, Ware. t 3

WANTED, small Foundation-making Machine, with Dipping Tanks.—Price to CARPENTER, 135, Manchester-road, Swindon. t 7

DRIVEN BEES, 4s., or 1s. 6d. per lb; package, 6d.; spare Queens, 2s.; cash with order.—GORDON, Bassingbourne, Royston. s 95

SURPLUS QUEENS, cheap for prompt sale: Genuine Sladen golden, 5s. 6d.; young darker hybrids, 4s.; on 3-frame nuclei, 12s. 6d., 10s.—PAUL, Salisbury-road, Bexley. s 96

FOR SALE, 12 HIVES, fitted with Frames, 6 Skeps, 6 Boxes of Sections. What offers? Or exchange for bees or canaries.—A. STILLWELL, 32, Avenue-road, N. Finchley. s 98

FOR SALE, several strong Stocks in Bar-frame Hives. — WILKES, Asterley, Minsterley, Salop. t 8

FOR SALE, healthy Stocks of Bees, in good Hives, with drawn-out comb, in first-class condition for the Heather; also other appliances.—WM. ARTHUR, Bee Appliance Dealer, Alloway, Ayr, N.B. t 9

FOR SALE, about 15 Stocks of good healthy Bees, in Bar-frame Hives, with Brood and Stores in new Hives; £1 1s. each.—J. PADGET, Suspension Bridge, Welney, Wisbech. t 2

WANTED, HONEY IN SECTIONS. Quote lowest prices for cash in quantities; carriage paid home. (Trade). — BARUCH BLAKER, Worthing. t 10

WANTED, Standing Room for 4 Hives on Heather, in Derbyshire, or nearest point to Leicester.—State terms to H. CROWE, York House, Central-avenue, Wigston, Leicester. t 15

DRIVEN BEES, from the East Coast, where the natural conditions have selected THE STRAIN to stand cold, exposed situations; 4lb. 5s., boxes returnable; orders booked for end of August and September. Terms cash.—FLUDDER, Ardleigh, Colchester. t 14

A FEW HYBRID FERTILE QUEENS FOR SALE.—MISS KIMPTON, Millbrook, Bentley, Ipswich. t 13

FINEST ENGLISH HONEY, 17s. 6d. per 28lb. tin; sample 2d. — DUTTON, Terling, Essex. t 1

LIGHT SECTIONS BOUGHT, 7s. to 8s. per dozen.—Send or write to THE HONIBLADE CO., 23, Moorfields, E.C. t 11

WANTED, first quality 1lb. Sections. State quantity, prompt cash. — W. CHILTON, Southdown Apiaries, Polegate, Sussex. t 12

WHAT OFFERS? Bees from 10 strong Stocks, Driven August 12th and 13th, weather permitting.—BAILEY, Swan-lane, Evesham. t 5

QUEENS, Doolittle strain, see B.B.J., of July 15, for an account of the doings of one of these Queens; this is not a solitary instance, there are numbers of them scattered up and down the country whose owners are equally pleased with them. The Virgin season being now over, I can only supply a limited number of Fertiles at 5s. each.—D. TAYLOR, Ilminster. s 97

WANTED, 3 cwt. New Honey, good quality, this sent. — Sample and lowest price to HERBERT HILL, Ockbrook, Derby. s 99

PERFECTLY HEALTHY LOT BEES FOR SALE, on 8 Frames, with or without Hive. Offers.—ANDERSON, 123, Castelnau, Barnes. s 94

*. Several important letters, &c., are in type, but held over from pressure on our space.

Editorial, Notices, &c.

PROMINENT BEE-KEEPERS.

DR. ULRICH KRAMER.

Dr. Kramer, whose portrait we present this week, is the President of the Swiss Bee-keepers' Society, and is well known to readers of the B.B.J., as we have frequently had occasion to mention him in connection with the work he was carrying on in Switzerland.

Dr. Kramer, who is now sixty-four

of instruction. As he was a fluent and animated speaker, he won thousands over to rational methods of bee-keeping, and constantly added members to the society. Dr. Kramer is a voluminous writer, and has contributed upwards of 300 able articles to the *Swiss Bee Journal*. He was very active and a leading spirit at shows, and displayed great taste in arranging the exhibits of the society, which in consequence obtained four diplomas, he himself being awarded a gold medal. He made many observations, for he kept a colony on scales, and this led him in



DR. ULRICH KRAMER.

President, Swiss Bee-keepers' Society.

years of age, was a lover of Nature, and especially of bees, from his youth. He commenced bee-keeping about thirty years ago, and has been closely associated with the Swiss Bee-keepers' Society since that time, joining the Committee of Management in 1881. By profession a schoolmaster, he began about this time to teach bee-keeping, and became a regular contributor to the *Schweizerische Bienenzeitung*. As a peripatetic instructor of bee-keeping he showed great activity, lecturing upwards of 200 times, and arranging a great number of courses

1884 to found "apicultural observation stations," where the bee-keepers in charge have to make and record series of observations. For twenty-two years he has compiled the material gathered from the twenty to forty stations, and has produced a profusely-illustrated and valuable annual report, which is a treasury of scientific and practical inquiry. In these reports there is a general summary of the weather during the year, a table of temperatures, winter losses, dysentery, commencement of breeding, the first honey-flow, the development of the

colonies, size of brood-nest, May-pest, swarming fever, the periods of swarming, results of swarming, spring harvest, queen-rearing, summer harvest, bee-pasturage, conditions in autumn and winter. The report is accompanied by a coloured statistical diagram, showing the daily increase and decrease at the different stations as shown by the hives on scales.

From 1880 to 1887 Dr. Kramer conducted the annual courses of instruction of school-masters as bee-keepers, and in this way he has trained a large staff of peripatetic teachers of bee-keeping. In 1889, in conjunction with the Rev. J. Jeker and M. O. Theiler, Dr. Kramer published "Der Schweizerische Bienenvater," which has already gone through six editions. He also edits the "Swiss Bee-keepers' Almanac." In 1896 he became President of the Swiss Bee-keepers' Society, which through his indefatigable labours now numbers 8,000 members.

With the great development of bee-keeping, the importation of foreign races of bees increased, and Dr. Kramer soon found out that the brown bee, the product of the climatic conditions of the country, was the best suited for Switzerland. He therefore brought all his influence to bear on furthering the culture of the Swiss race. He established mating-stations, remote places for the fertilisation of queens with pure-bred drones. In 1898 he commenced the annual courses of instruction for "race-breeders," at which over one hundred Swiss bee-masters attended. The result has been most satisfactory, and a large number of colonies now consist of the pure Swiss race headed by selected queens.

The whole theory and practice of the race culture of Swiss bees is to be found in a book recently published by Dr. Kramer, entitled "Die Rassenzucht der Schweizer Imker," which is a very valuable addition to the literature on the subject. Austria and Germany have followed the lead of Switzerland, and have introduced observation stations founded on the same plan.

Bee-keeping certainly owes a debt of gratitude to Dr. Kramer, and it was with pleasure that we had to record on page 144 of the B.B.J. that the University of Bern had conferred on him the well-merited reward of a doctor's degree *honoris causa*. The British B.K.A. also, at its last annual meeting, elected him an honorary member as a recognition of the services which he has rendered to bee-keeping. We made his acquaintance in 1883, and were then much struck by his oratory, scientific knowledge, and by the admirable way in which he had compiled the statistics of bee-keeping in the country.

We have only mentioned some of Dr. Kramer's work, but he has done much more to bring the Swiss Bee-keepers' Society to its present flourishing position. Amongst other things, a foul brood insurance scheme of 5 centimes per colony was instituted through his instrumentality, by which it is hoped to remove this pest from the land.

His health beginning to fail in 1906, he was obliged to hand over some of the work to younger men, and although he is no longer treasurer and has relinquished the management of the apicultural stations, he still remains President of the society and chief of the race-breeding department, to which he has devoted so much labour and attention. We hope Dr. Kramer may enjoy good health and be long spared to continue his useful work for the advancement of bee-keeping.

LEICESTERSHIRE AND RUTLAND B.K.A.

ANNUAL SHOW.

Under the most favourable climatic conditions this association held its annual exhibition of bees and honey, in conjunction with the Abbey Park Flower Show, at Leicester, on August 3 and 4. The number of visitors to the show totalled about 36,000. The bee and honey department was, as usual, under the management of the Leicestershire and Rutland Bee-keepers' Association. Here, again, the cold, sunless summer has told its sad tale, for in Leicestershire (in common with most other counties) the weather has been decidedly unfavourable to the gathering of even a fair honey-yield. Consequently the exhibits, though good, were not numerous, thus showing that bee-keepers were anxious to make the best of a bad season as far as lay in their power. Lectures and demonstrations were given in an adjoining tent by experts in the craft. Mr. R. Brown, Somersham, Hunts, and Mr. W. W. Falkner, Market Harborough, kindly officiated as judges, and made the following awards:—

Observatory-hive with Queen and Bees.—1st, J. H. Hubbard, Leicester; 2nd, W. H. Wood, Old Aylestone; 3rd, S. Clarke, Old Humberstone.

Twelve 1-lb. Sections.—1st, Chas. Bottrill, Kimcote; 2nd, A. MacVinish, Woodhouse; 3rd, Chas. Timlock, Leicester.

Twelve 1-lb. Jars (Light) Extracted Honey.—1st, J. Garratt, Willoughby; 2nd, E. Varty, Diseworth; 3rd, J. Kenney, Cosby; 4th, A. J. Marriott, Market Harborough.

Twelve 1-lb. Jars (Dark) Extracted Honey.—1st, J. Waterfield, Kibworth; 2nd, E. Varty; 3rd, J. Kenney; 4th, C. Bottrill.

Three Shallow Frames of Comb Honey.—1st, W. Marshall, Leicester; 2nd, F. H. Hubbard.

Twelve 1-lb. Jars Granulated Honey.—1st, J. Waterfield; 2nd, S. Clarke; 3rd, F. H. Hubbard.

Display of Honey.—1st, J. Waterfield.

Six 1-lb. Jars (Dark) Extracted Honey (novices).—2nd, F. Price, Sutton-in-the-Elms.

Six 1-lb. Sections (novices only).—1st, J. Veazey, Wilbarston.

Six 1-lb. Jars (Light) Extracted Honey (novices only).—1st, J. Veazey; 2nd, W. Marshall; 3rd, W. S. Joyce, Leicester.

Honey Beverage.—1st, J. H. Geary, Enderby.

Beeswar.—1st, E. Varty; 2nd, E. A. Jesson, North Kilworth; 3rd, J. H. Geary.—JOHN WATERFIELD, Secretary.

HONEY IMPORTS.

The value of honey imported into the United Kingdom during the month of July, 1909, was £5,587.—From a return furnished to the BRITISH BEE JOURNAL by the Statistical Office, H.M. Customs.

FOUL BROOD AND CHLORIDE OF LIME.

In response to the request for more information respecting chloride of lime as a remedy for foul brood, alluded to on page 171 of the B.B.J., as mentioned by M. Vibert in the *Apiculture Nouvelle*, the editor of that journal courteously supplied us with a letter on the subject, and informed us at the same time that an article by M. Vibert treating the subject fully was to appear in the next number of *Apiculture Nouvelle*. We are now pleased to be able to give the latter to our readers. M. Vibert writes:—

"This is the way I proceeded with the cure in the case mentioned, where my assistance was sought in 1908.

"The apiary consisted of twenty colonies, only three of which had foul brood. After inspecting them, all combs in the infected hives had every cell cleaned out, taking care to burn all decomposing matter, pieces of wax or rubbish removed. After transferring the bees into clean hives, all the combs were placed in them, including those known to be healthy, but leaving out two on each side. The three hives had their entrances closed by means of fine wire gauze, and they were removed to a shady spot at the other end of the yard. The body-boxes were then pushed back on their floorboards, to enable the 'Alexander' feeders to be placed in position.

"On the feeder, which thus formed a continuation of the floorboard, there were placed in the two angles on the left a

small tumbler three-fourths filled with dry powdered chloride of lime, and on the right another tumbler three-fourths full of pure carbolic acid. Both were covered with wire gauze to prevent bees from falling into them. [The French tumblers are rather smaller than ours, with about three-fourths the capacity.—Ed.] The colonies were fed with thick sugar-syrup for eight days—three parts sugar to one part honey of best quality—given warm every evening after sunset.

"After this the bees were allowed their liberty, the tumblers removed and replaced by sardine boxes two-thirds full of chloride of lime and carbolic acid respectively, these boxes being slid under the frames. The four combs removed in the first place were replaced by other combs containing honey.

"By the end of April all traces of foul brood had disappeared, the colonies were found in good condition, and the queens were laying regularly. At the close of the season there was a good surplus of honey, the colonies wintered well, and now the three hives are perfectly healthy.

"As a preventive, the other seventeen colonies were supplied with similar medicaments in sardine boxes, the bees not appearing to be in the least inconvenienced. The above treatment was again tried this year in April and May on five diseased colonies in Lyons. Two were cured, but three of them, owing to overdosing and not carrying out the instructions properly, succumbed.

"After two or three days' claustration the bees are allowed to have a cleansing flight, by removing temporarily the wire gauze and reducing the entrance to about an inch in width.—A. VIBERT."

THE COMING HONEY-SHOWS.

In view of the improvement in the weather and the late honey crops now being obtained in many parts of the country, it is to be hoped that the leading shows of honey and bee-produce held in London in September and October will not suffer, as so many of the earlier exhibitions have done, from lack of entries. We refer particularly to the Grocers' Exhibition held at the Agricultural Hall, London, from September 18 to 25, and the Dairy Show at the same place from October 5 to 8.

The directors of the former show have decided to omit the honey competitions from the Confectioners' Exhibition this year, and to concentrate their efforts on the Grocers', and, while entry fees still remain 1s. in each class, are offering unusually liberal prizes (see advertisement on page iii.) as an inducement to beekeepers to make the honey section more successful.

Some of the shows held during the present season have been very well supported, the exhibits lacking neither quantity nor quality. This being so, we hope that at these Metropolitan honey exhibitions, which hold so important a place in the bee-keeping world, the industry will be properly represented. Everything possible is done by the officials to ensure proper staging and safe return of exhibits, and many enterprising bee-keepers have secured permanent customers for their produce through the opening obtained by exhibiting in this way, while the valuable prizes offered ought to be an inducement in themselves. No time should be lost in sending for schedules before it is too late to make an entry.

Correspondence.

The Editor does not hold himself responsible for the opinions expressed by correspondents. No notice will be taken of anonymous communications, and correspondents are requested to write on one side of the paper only, and give their real names and addresses, not necessarily for publication, but as a guarantee of good faith. Illustrations should be drawn on separate pieces of paper. We do not undertake to return rejected communications.

AMONG THE BEES.

BEES AND FLOWERS.

[7568.] Reference has repeatedly been made to the strange freak of Nature shown by a bee visiting orchids about this season of the year; and the peculiar protuberance like a horn on the bee's head, brought about by the visits paid to flowers of this species, has been repeatedly illustrated in the B.B.J. Press in the point of a lead-pencil and the same result follows. The sticky substance adheres to the point, and you have a small projection not unlike a miniature Indian club. The result is interesting, but the cause is simple. Notice bees rolling in the broom blossom. Not only are their pollen-baskets quickly loaded with the yellow dust, but their legs all over are coated with it, so that they are uniformly of a golden hue; while the whole body of many bees, especially young ones who have not yet fully developed their pubescence, is one mass of shining gold. The perfect abandon with which these youngsters revel in the broom bloom is worth watching. Life seems to be wholly a delight, and the hardships of existence are as yet in the dim and distant future for them. Observe bees working on the malva, or mallow family of flowers. Take *Malva moschata*, or musk mallow. What jolly dusty millers the bees are when they have loaded up on the flowers, blooming in such profusion on each one of these plants. Perhaps no other plant so well

illustrates the correlation between flower and insect as the salvia, or sage. "The calyx and corolla of sage are in agreement, and the stamens are so placed and constructed as to strike the bee with the anthers in a certain place. Then, again, the stigmas are so situated that they must hit the bee precisely where the pollen had been previously deposited." There are only two stamens in this flower, supported on very short filaments; but the connection which unites the anther-cells is extraordinarily developed into a curved rod, which moves up and down as on a pivot. The uppermost anther has pollen, but the lower one has none. When the bee enters the flower her head strikes the spoon-shaped empty anther-cell, so that she sets the connection moving, which then brings the polleniferous anther down upon her back. By these means the bee gets the nectar from the honey-gland and the pollen from the stamens, while at the same time each successive flower visited has conferred on it that pollinarius exchange without which it would fail to propagate its kind.

Nature, in adapting flowers to insects, seems to have brought into play many ordinary mechanical forces, such as *springs* and *levers*, by help of which the bee in its visits is, as it were, compelled to act the part of a pollen-carrier, in order that the separate plants may have the fertilising matter carried to them with almost a dead certainty.

A Cheap Weed-killer.—For killing weeds in garden walks and about beehives purchase the cheapest sulphuric acid, costing only about 1d. per lb., and mix it with about twenty times its own amount of water. Apply very lightly by means of a watering-can with a fine rose. It kills all the weeds about, and also the seeds in the walk ready to germinate. Before applying, it is best to hoe out all the more prominent weeds. Be careful in using not to let any of the mixture touch any borders or flowers lined along the walks, as a little readily injures them.

Introducing Virgins.—Many will be introducing virgin queens now, and although the subject has recently been dealt with, I comply with a request for some explanation as to why so many failures occur in carrying out this operation. For the first three days or so after a queen issues from the cell she can be introduced to almost any stock with scarcely any precaution whatever, but every day thereafter adds to the difficulty. In the earlier period she is so unlike a queen that the bees let her have the run of the hive as some innocuous creature, or treat her as a negligible quantity, owing to her innocence. Later she asserts herself and claims her pre-

rogative rights, standing somewhat on her dignity. In the earlier stages she becomes one of themselves before she assumes the portly gait and stately demeanour. The bees gradually come to know she is no ordinary worker-bee, but a something deserving honour, respect, and fealty, so before they rightly know how or why she is adopted as the "grand seigneur," or ruler of the hive. Rather she is respected and esteemed as the mother-bee, without whose presence destiny dooms even their teeming thousands to rapid extinction.

A queen, however, matures rapidly; so in about a week she asserts herself, becomes combative, or claims her rights. The bees, spying a stranger where they think she has no right to be, stand on the defensive, or, acting on an unwritten bee-law, demand her expulsion. Frequently a fertile worker may be present, and the bees, thinking they have something of their own, dethrone the new claimant. Then many times when not suspected incipient cells may have been overlooked in any examination, from which the bees expect to rear a queen of their own. Yet again, and this is often the case, when an old, failing queen is deposed she may have a daughter present in the hive. The almost inevitable result follows—the stranger is "balled," and her dead body thrown out.

Make the bees combless and broodless; or leave them on their combs, but with no unsealed eggs or larvæ, so that they are hopelessly queenless, and in ninety-nine times out of the hundred they will unquestioningly accept the new mother. In the hundredth case some carelessness or bungling of our own is the likely cause of her rejection.

I had some unusual experiences this season showing that bees do at times act most peculiarly. One colony found queenless in spring declined to accept a successor, and rejected five separate attempts to re-queen them. In the case of two weaklings, both queens disappeared a few days after, and when a third lot was joined on they refused that queen too. All attempts at queen rearing or mating in June and July proved failures, and virgin queens all failed to mate.—D. M. M., Banff.

CHLORINE AS A DISINFECTANT.

[7569.] A good deal has been written in your journal regarding the use of chlorine as a disinfectant, but Mr. A. Green's remarks in your issue of August 5 are so misleading that it appears advisable to strike a note of warning.

Mr. Green gives one to understand that chlorine will combine with the hydrogen in water to form hydrochloric acid and

oxygen, thus depriving the water of one of its constituent elements, which would otherwise go to build up germ-cells. But unfortunately oxygen has a far higher attractive power for hydrogen than has chlorine, as any chemist will admit. Indeed, "chlorine water"—*i.e.*, water holding chlorine gas in solution—is a commercial product. Were Mr. Green's theory correct, such a product would be impossible of achievement. And it may be remarked that chlorine is got from hydrochloric acid by offering free oxygen to the hydrogen in the acid, and thus throwing it out of combination. To put the matter in a chemical formula,

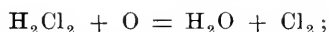

whereas Mr. Green would reverse the process, thus:



which is quite impossible.

The true secret of the disinfecting power of chlorine lies in its destructive action on mucous membrane, and for this reason I should hesitate long before I consented to use it in a hive. Its action on the human frame is highly dangerous, unless it be greatly diluted with air, and even then it is extremely irritating to the nose and throat. Its effect, therefore, on lower organisms (such as insects) would probably be fatal, if administered in any quantity sufficient to be noticed by man. I would caution your readers to leave all such experiments in the hands of competent chemists and bacteriologists.—H. CAMPBELL, Cookham, August 12.

CUMBERLAND SHOW.

AN INTERESTING MEETING.

[7570.] May I ask you to insert a short note in next issue of your valuable paper to say that, owing to the lateness of the season, the time of entering for the honey show of the Cumberland B.K.A. at Carlisle on September 1 and 2 is extended to August 25? Up to the time of writing entries are very small considering the value of the prizes offered, and this show, which is held in connection with that of the Carlisle Horticultural Society, should be well patronised by exhibitors from both sides of the Border. In the hope that North and South would strenuously compete, well-known judges from both sides were appointed. They are our well-known friends Messrs. "D. M. M." and L. S. Crawshaw, and I sincerely hope a large muster will turn up to meet them at Carlisle on September 1 and 2. All bee-keepers who intend being in the Border City on the evening of the 1st should communicate with myself, when they will receive a hearty invitation and a ticket of admission to a tea and pleasant

evening with well-known bee-men.—G. W. AVERY, Hon. Sec. Cumberland B.K.A., Croft House, Heads Nook, near Carlisle.

SWARMING VAGARIES.

[7571.] Your correspondent H. W. Cowley (page 306) gives a very interesting account of a large swarm which beats the one reported by me in B.B.J. of November 28, 1907.

The largest swarm I ever saw was hived on June 14 this year; it was really two large swarms with probably one queen. An account of this will no doubt be found interesting. My boy fetched me from church on Sunday morning, June 13, to hive a swarm, which first settled in a plum tree, then returned to its hive again, and eventually went back again to the plum tree. As I was about to shake it into a swarm-box the bees took wing, and settled close to the parent hive, a few bees entering the hive, the bulk remaining on the ground and the leg of the hive. I placed the box on the ground, tilting it against the hive, and put the queen (she was unable to fly) inside the box, all the bees following and remaining inside.

Whilst watching my bees in the afternoon a swarm came from a hive seven yards away from the hive that had sent off the swarm a few hours previously, and without hesitation entered their hive.

Late in the evening the first swarm mentioned came out of the box, forming a bridge, and the queen walked over, again entering the parent hive with her swarm, and staying till the next day, when the two swarms came off as one. Will those young bee-keepers that think of having their queens' wings clipped read between these lines, please?—D. HANCOX, Deddington.

ISLE OF WIGHT DISEASE AND THE BOARD OF AGRICULTURE.

[7572.] I can corroborate Mr. Hayle's remarks as to the dilatoriness of the Board of Agriculture. On June 19 the first case of Isle of Wight disease in this district was brought to my notice, the bees lying dead in thousands from six hives, all containing ample stores and honey in sections. I sent one box of live and one box of dead bees that night to our county association. Receiving no reply by June 23 (or since), I sent duplicate boxes to the Board of Agriculture, who wrote by return of post to say the bees had been sent to their expert, and they would forward the result. I have heard nothing further up to now (August 9), except a polite acknowledgment of a second letter written about a

fortnight after the first to urge a speedy reply.

We have meanwhile destroyed every stock affected, together with combs and quilts, and I have fed swarms and weak stocks with syrup containing a solution of formalin. It remains to be seen whether the disease reappears next spring. I shall be pleased to try other measures if I can obtain any advice, but this appears to be impossible.—M. MILLARD, Hon. Sec. Hartley Wintney Bee-keepers' Co-operative Society, Hants.

BRITISH BEE-KEEPERS AND COUNTY ASSOCIATIONS.

[7573.] As the honorary secretary of a county B.K.A., I have read the letter (7545, page 295) with feelings of sympathy—not for "Beginner," but for the secretary of the unfortunate association he joined. He appears to be one of that class who take no real interest in apiculture, else why, being a "novice," does he buy half a dozen stocks to begin with, but hopes he is going to make them profitable with the aid of others? To this end he joins a B.K.A. as a cottager member, and thinks the expert should call, not when the weather permits (of this, in all probability, he takes no account), but just when he requires him. By his own showing, he "could easily have got other experts to come"; but, no, although he was so "anxious" about his bees, he kept on waiting for the expert, and so lost three stocks. These are not the class of members who do an association any good, or become successful bee-keepers, and if I might offer "Beginner" any advice it would be to "give it up."

I suppose the secretary of almost every B.K.A. has had experience of that large class of subscribers who are not bona-fide cottager members, but who expect to get the very best attention at a fee which does not anything like cover expenses, and it is about time county associations cut adrift these very unprofitable drains upon their resources.—HON. SECRETARY.

CURRENT TOPICS.

[7574.] Dealing with "D. M. M.'s" (7550) remarks seriatim—in the first place, I do not "stand up" for the ordinary scraper *as a tool*, so much as for its proper use. Further, it is just because the triangular scraper "goes two (edges) better" that I recommend it.

Now as regards "swarms *versus* stocks." "D. M. M." misquotes me when he places the words "entirely depend on clover as the main harvest" between inverted commas, and as relating specially to his district. What I said was that my remarks referred entirely to the main or clover harvest. "D. M. M." says that

this saving clause "entirely vitiates my whole argument"; but I am willing to throw in the heather harvest also, and am still pretty sure that the stock will be ahead in the aggregate yield. I have myself taken hives to the (North Yorks) moors for several years, and, although I have no written data to refer to, I believe that this was generally the case.

Again, I do not say, neither can my words fairly be made to bear the meaning, "that it is a matter of moonshine whether hives are levelled or not," but that extreme accuracy or "perfect levelling" is not essential to the production of first-class sections. Give me a dozen strong stocks in a district where abundant clover and sainfoin crops yield a heavy flow of honey, and I will set those hives approximately level by the eye only, and engage to produce very much better sections than can be obtained with an equal dozen located where only a moderately good flow is available, even though the hives were levelled to a hair's breadth. The heavy flow of nectar is of paramount importance to the production of perfect comb honey: the "perfect" levelling of the hives, while not altogether mere moonshine, is comparatively a very minor matter indeed. Now "perfect levelling," as I understand it, means as level as it is possible to set the hive by means of a spirit-level, and I never had in mind hives so tilted as to appear in danger of "toppling over." These must be ruled "out of court" as belonging, in practically every case, to incorrigibly careless and slovenly bee-keepers, upon whom advice, "wise" or otherwise, is simply thrown away.

"D. M. M.'s" quotation from the "Guide Book" obviously refers to frames, not sections, and it is equally obvious that, as frames are just double the depth of the latter, the deviation of the sheet of (*unwired*) foundation from the medial line of frame will be much increased for the same amount of variation from the level. Therefore it is of much more importance to level hives for the above-mentioned purpose, always supposing "starters" or unwired foundation to be used. With all due deference, therefore, to the score or so of authorities whom "D. M. M." would bring against me, I must adhere to every word of my statement *as written*.

The season here has been most tantalising: an exceptional white clover bloom in the meadows "wasting its sweetness on the 'sunless air,'" to slightly alter Gray; but that very want of sunshine has prevented the bees from taking anything like full advantage of the bloom. The weather the last few days has been magnificent, but too late, save for the heather.—SAML. P. SOAL, Rochford, Essex.

PAPER-PULP HONEY-POTS.

[7575.] Replying to M. D.'s (Silsden) inquiry on page 310, the honey-pots in question have for a considerable time been successfully used for cream, and, in the words of the one who, in my opinion, is the finest word-painter in the cataloguing of bee-appliances, "We offer them confidently to bee-keepers for honey."

From practical testing there is no doubt they do answer, and whilst being an additional article in which to sell honey, the lower price is a distinct advantage.

The disadvantages as they appear to me are the honey cannot be seen, and that the pulp pot when empty (unlike jars, tins, &c.) cannot be used for other household purposes.—THOS. N. HARRISON, Carrington, Nottingham.

ERRATA.

[7576.] Will you allow me to correct a mistake of one word, "carbon," which should have been "oxygen," for chemical union with hydrogen to produce water (page 314), though the error was too obvious, I hope, to cause inconvenience? Certainly your correspondent (page 303, 7551) is not to be blamed for my lapse, though it arose from a cursory reading of his remark on the union of hydrogen and carbon.

I see, too, I must have sent in "copy" with "chloride" instead of "chloride of lime."—S. J., Bristol.

WEATHER REPORT.

WESTBOURNE, SUSSEX.

July, 1909.

Rainfall, 3.25 in.	Minimum on grass, 33° on 2nd.
Above average, .69 in.	Frosty nights, 0.
Heaviest fall, 1.36 in. on 27th.	Mean maximum, 63.
Rain fell on 16 days.	Mean minimum, 52.
Sunshine, 201.6 hours.	Mean temperature, 57.5.
Below average, 31.5 hours.	Below average, 3.7.
Brightest days, 20th and 24th, 13.5 hours.	Maximum barometer, 30.275 on 2nd.
Sunless days, 1.	Minimum barometer, 29.540 on 25th.
Maximum temperature, 74° on 19th.	
Minimum temperature, 43° on 2nd.	

L. B. BIRKETT.

JULY RAINFALL.

Total fall, 2.90 in.
Heaviest fall in 24 hours, 1.25 in. on 27th.

Rain fell on 18 days.
Below average, .21 in.

W. HEAD, Brilley, Hereford.

Bee Shows to Come.

August 21, at Elworth, Sandbach.—In connection with the Elworth Athletic Club and Horticultural Society's Show. **Entries closed.**

August 24, at Cartmel, Lancs.—Bee and Honey Show, in connection with the Cartmel Agricultural Society's 37th Annual Show. **Entries closed.**

August 25, at Brislington, Bristol.—Annual Show of Honey, Wax, and Appliances of the Somerset B.K.A. Extended Schedule and increased prizes. Seven open and two free classes. Schedules from Mr. James Brown, Show Sec., 31, Bridge Street, Bristol. Tel. 2176y. Telegrams, "Brown, Bristol." **Entries close August 21.**

August 25 and 26, at Stratford-on-Avon.—Annual Show of the Warwickshire B.K.A., in connection with the Warwickshire Agricultural Society. Schedules from J. N. Bower, Hon. Sec., Knowle, Warwickshire.

August 26, at Oxford.—In connection with Royal Oxfordshire Horticultural Show, in Headington Drill Hall and Park, Oxford. Open Classes: Single Section and Single Jar Extracted Honey. No entrance fee. Schedules, H. M. Turner, 4, "The Turl," Oxford.

September 1 and 2, at Carlisle.—First Annual Show of the Cumberland B.K.A. Ten Open Classes (including Honey Trophy) for Honey, Hives, and Wax. Liberal Money Prizes in all Classes; also the C.B.K.A. Certificate of Merit to best exhibit in each class. Schedules from G. W. Avery, Hon. Sec., Heads Nook, Carlisle. **Entries close August 25.**

September 2, at Stockport.—Annual Show of Honey, &c., in connection with the Adlington and E. Cheshire Agricultural Society's Honey Department, under the direction of Cheshire B.K.A. Schedules from Mr. J. O. Garner, Ivy House, Bramhall, Stockport. **Entries close August 24.**

N.B.—Exhibitors who are showing at Bramhall on September 4 can have their exhibits removed to Bramhall if they will enclose 3d. for carriage of same at time of entry.

September 4, at Bramhall, Stockport.—In connection with Bramhall Horticultural Show. Honey Section under management of C.B.K.A. Liberal prize list for Honey, Extracted or Sections, and Wax. Silver and bronze medals for Local Class. Schedules of Mr. J. O. Garner, Secretary, Ivy House, Bramhall, near Stockport. **Entries close August 24.**

September 4, at Crayford, Kent.—Annual Honey Show. Open Classes. Sections and Jars (Light and Dark), 6 of each. Entrance fee 1s. Schedules from J. M. Bates, Hon. Sec., Warren Road, Bexley Heath.

September 7 and 8, at Derby.—In connection with the show of the Derbyshire Agricultural Society at Osterley Park, Derby. Honey Department under the direction of the Derbyshire B.K.A. Several Open Classes. Schedules from Hon. Sec., R. H. Coftman, 49, Station Road, Burton-on-Trent. **Entries close September 1.**

September 13, at Conway, N. Wales.—Annual Honey Show, in connection with the Conway Honey Fair. Open and local classes. Schedules from J. Hughes, Town Hall, Conway. **Entries close September 6.**

September 16, at Castle Douglas.—In connection with Dairy Produce Show, the annual show of the South of Scotland Bee-keepers' Association. Open Classes for three 1-lb. Jars (20s., 10s., and 5s.); three Sections (20s., 10s., and 5s.); entry 2s. One Jar (5s., 3s., and 2s.); one Section (5s., 3s., and 2s.), entry free, but exhibits forfeited unless otherwise arranged. Beeswax (5s., 3s., and 2s.); entry 6d. Thirteen Classes Confined to Members. Numerous prizes, including two Challenge Cups and gold and silver medals. Schedules from Q. Aird, Hardgate School House, Dalbeattie, N.B. **Entries close September 4.**

September 16, 17, and 18, at Crystal Palace.—Surrey B.K.A. Annual Exhibition of Bees, Honey, Wax, Appliances, &c. Twenty-seven classes (nine open to all). Many medals and increased prizes. Schedules from F. B. White, Secretary, Marden House, Redhill, Surrey. **Entries close September 1.**

September 18 to 25, at the Agricultural Hall, London.—Honey Show in connection with the Seventeenth Annual Exhibition and Market of the Grocery and Kindred Trades. Liberal prizes. **Open to all British Bee-keepers.** Schedules from H. S. Rogers, Secretary, Exhibition Offices, Palmerston House, Old Broad Street, London, E.C.

September 22, at Altrincham.—Honey Show, in connection with the Altrincham Agricultural Show, the largest one-day show in the Kingdom. Classes open to United Kingdom. Classes for Trophy of Honey, for Best Hive, Observatory Hive with Bees and Queen, twelve Jars of Extracted Honey. Classes open to County of Chester, for Run and Section Honey, Wax, &c. Special Classes for Cottagers, and Special Classes for Society's District. Good prizes, low entrance fees. Schedules from Mr. J. Herbert Hall, 2, Dunham Road, Altrincham. **Entries close September 4.**

Queries and Replies.

[3965.] *Queen Flying out during Manipulation.*—I have just examined the frames of a hive containing a swarm that I received on Friday last, and which had honey near the top bar. Whilst I was examining the frames to find the queen she flew away. I therefore immediately replaced the frames and closed the hive. I should therefore like to know—1. Will the queen return or not? 2. Do bees need to be fed during wet nights if they have been gathering nectar during the day? If you will answer the above queries in your valuable paper I shall be very much obliged.—Novice, Lintlithgow.

REPLY.—1. You did wrong in replacing frames and closing the hive, and you should have kept still and left the hive in the same condition as when the queen flew out, until her return, which would have been in a few seconds. If the queen happens to be one that has not previously flown out of the hive, you ran the risk of losing her, as she would not recognise the closed hive if there are others about, and she might be killed in trying to get into the wrong one. 2. No, not if it is an established stock; but it is an advantage to feed swarms (see page 111 of "Guide Book").

[3966.] *Unfinished Supers.*—Early this spring on one of my very strong stocks I doubled the brood-nest, nine frames being full of brood. The queen then filled about sixteen combs with brood, which were then supered with a rack of shallow frames. The shallow frames are now half full of sealed honey, and the upper brood-box is partly being filled with unsealed honey, all the brood having hatched out. 1. Will the bees take away the honey from the top box of shallow frames and fill the upper brood-box? 2. If I place the shallow frames below the upper brood-box and only lightly cover it, will the bees take down this honey and fill and seal the shallow frames, which I should much prefer? 3. In taking bees to the moors some distance away, and presuming that the sections are filled, what is the best method of clearing the bees from the sections quickly, as I can only go on Saturday afternoon to the moors, and, in this case, I presume the "bee-escape" boards would be of no use?—WHARFEDALE.

REPLY.—1 and 2. No, but if left on too long they will carry it down into the brood-nest for winter use. You might try putting the upper brood-box below main hive, as bees usually carry their stores above the brood-nest, and, in the event of this being already full of brood, would store the honey in the shallow frames above. You should, however, place excluder between to prevent the queen from going down. Another plan would be at the close of the season to extract the unsealed honey first, and then that which is sealed. Keep each separate. The unsealed honey can then be put into a ripener, and that on the top which remains thin can be used for feeding. 3. Take

them out one by one and shake or brush the bees off on to the alighting-board. A whole rack of sections can be cleared in this way in a few minutes.

Notices to Correspondents.

Lex (Wrexham).—Formalin for Foul Brood.—1. A 10 per cent. solution of formalin is placed in a tin tray and allowed to evaporate, being renewed as required. The tray is covered with perforated zinc and placed under the frames. In addition, three balls of naphthaline are kept in the hive. 2. It is not used for feeding at all, and can only be sprayed on combs free from brood, being fatal to it when in contact. In ordinary mild cases destruction of combs is not necessary, but if the disease is far advanced it is advisable.

A. B. H. (Essex).—Dwindling Swarm.—Instead of taking out five frames with queen in making your artificial swarm, you should have only taken one. By doing so you depleted the other hive, which had only the queen-cell. You do not say where you placed this, but probably the old bees returned to the hive with the queen. The young bees remaining would not go out collecting, and if they were short of stores would be weak when they flew out. There is nothing apparently the matter with the bee sent. Your finding the hive queenless on July 2 and not giving them any means of raising a queen until the 25th, when they were already weakened, would account for their not doing so then.

J. W. (Sheffield).—Queen-cell in Hive.—If your hive is not crowded with bees, and there is plenty of room for the queen to lay, there is no reason for making queen-cells, unless for some cause or other the bees wish to supersede the present queen. If you are satisfied that she is doing well, when the queen-cell is sealed over it could be removed.

Novice (Rugby).—Re-queening Colony.—1. It will be quite safe to introduce now a golden queen amongst black bees if the proper precautions recommended in the "Guide Book" are taken. 2. You can obtain a list of flowers visited by bees from Messrs. Sutton and Sons, Reading. 3. The prices of the articles mentioned will be found in trade catalogues of advertisers in "Guide Book," to whom you should apply. 4. Bees can be put into a hive as soon as the paint is dry and hard.

J. C. (Barnet Green).—Hybrid Bees.—If you are certain that the colony is headed by a black English queen, the explanation would be that the yellow queen had been deposited when the black queen was reared from brood in the hive, and that she had mated with a yellow drone; consequently the progeny would be some black and others yellow.

FORESTER (Coleford).—Naphthol Beta Solution.—1. If you find difficulty in getting methylated spirit, rectified spirit, to be obtained of any chemist, will do equally well. 2. It is probably from lime or other strong-smelling nectar that the odour proceeds. 3. White crystallised cane sugar will do as well as lump. Beet sugar contains injurious potash salts, which it is difficult to eliminate in the manufacture. It is the presence of these salts that makes beet sugar liable to fermentation. Cane sugar is free from them.

E. J. J. (Pembroke).—Remains of Queen.—The portion of bee sent is that of a queen, which has probably met with an accident.

MEL ROSÆ (Isle of Wight).—Bees between Hive and Outer Case.—1. There must be some opening through which the bees escape into the outer space. Either the supers do not cover the top

of the hive or the quilts do not fit close. There may also be an opening at end of sections. 2. As there would only be old bees, they would probably "ball" the queen, as they usually do, although a colony that has lost its queen, and not having brood of proper age from which to rear one, will readily accept an unfertilised queen.

F. P. C. (Sutton Valence).—Name of Insect.—When the box reached us it contained only a fragment of skin of a centipede, and as there were two holes, evidently the creatures you sent must have bored them, and thus made their escape from the box.

Clover (Watling Street).—Clover Seed.—The most useful clovers for bees are the white Dutch and alsike. They should be sown either in the autumn or preferably in early spring.

G. B. (Bath).—Uniting Bees.—Remove old queen. You can drive the bees from the skep the same evening as you bring them home. Great care must be taken to prevent fighting when uniting driven bees with established stocks. You will find full instructions for doing this on page 107 of "Guide Book."

F. T. W. (Lancaster).—Undeveloped Bees.—The bees were quite decomposed and had an offensive odour. They seem unusually small, and as your hive seems crowded with bees, it is probable that the brood was suffering from want of stores, and the undeveloped bees have been cast out. Probably with the favourable change in the weather the bees may be collecting enough to supply their wants now. We cannot say if there is any foul brood without examining the brood-combs. The appearance of foul brood is well shown in the coloured illustration in "Guide Book" facing page 173.

H. A. M. (Kirby Bedon).—Removing Bees over Bay Window.—Find out where the bees enter under the lead, then have this removed, and see if the combs are confined to the space over the bay or are extended beyond under the floor above drawing-room. In the latter case the floor would have to be taken up, and the bees would be probably found between two of the floor joists. If you want to get the bees alive, smoke them and cut out the combs, brushing the bees into a prepared hive. Watch for the queen, and make sure that you secure her. Any combs containing brood can be tied into frames placed in the hive and allowed to hatch out. In this way you can get out most of the bees, and if the hive is allowed to stand close to their usual entrance for a short time, most of the flying bees will enter it. After uncovering the place, the bricklayers need not go near it until you have removed the bees and combs, and if their services are required they had better have veils. In making good, care must be taken not to leave any opening by which the bees may enter again. The operation can be performed now.

J. D. GRAHAM (Portugal).—Bees for Portugal.—The best time to send stocks of English bees would be in October, when they would be ready to take advantage of the flowers opening with the first rains. If there is not sufficient early pasturage they could be fed.

S. M. (Surbiton).—Sending Hive to the Heather.—1. The heathers sent are those mentioned in "Guide Book." 2. You can leave sections on and tack on the canvas. 3. If your hive has an outer case, secure this by putting blocks of wood between hive and outer case, and pack the space with paper as tightly as possible. The supers can then be secured in lift in the same way, and cord the whole in the manner shown on page 119 of "Guide Book." The roof can be taken separately and put on again when destination has been reached and the hive uncorded. 4. You require something in the way of a ripener for extracted honey, but you can use any deep

vessel, and pour off the thin honey that may float on the top.

Honey Samples.

- H. W. L. (Wolverhampton).—Sample is thin and poor in flavour. The dark colour is chiefly caused by honey-dew.
- M. E. F. (Warwicks).—Fairly good dark honey, gathered mainly from fruit blossoms.
- IDEJA (Herefords).—Both samples are fruit or tree blossom honey. A is of good quality, though somewhat lacking in consistency. B is inferior in both colour and flavour to A.
- MANOD BACH.—Fairly good honey, quite fit to show in medium or dark honey class. We cannot tell exactly which, as the sample is so small. It contains no honey-dew.
- J. W. L. (Keswick).—Sample is rather thin, light in colour, and somewhat sweet and insipid in flavour; but, on the whole, it is a good honey, and, as far as we can judge, quite pure.
- F. K. S. (Garden City).—Honey-dew predominates in the sample, and this is the cause of the black, dirty appearance and the slightly bitter after-taste.
- H. T. (High Bickington).—Honey is good in colour and flavour, but rather thin and unripe. It will be quite fit for the show-bench if slightly warmed to cause evaporation of the superfluous moisture.
- W. C. H. (Newton Abbot).—The honey is quite spoiled by honey-dew, and bees should not be wintered on it, as it might cause disease. It can be used for manufacturing purposes, such as making blacking, if you could find a purchaser, but is not fit for table use.
- CRICKET (Sussex).—Sample, though thin in consistency, is good in colour, and fairly good in flavour. Should be entered as a medium-coloured honey. It contains no honey-dew.
- A. C. (Auchnagatt).—1. A very good white clover honey. 2. Should hold its own at any show. 3. If signs of granulation appear, warm it in a pan of hot (not boiling) water, not allowing the jar containing the honey to touch the bottom of the pan. It will become bright and clear, and if properly done no loss of flavour or aroma will result. 4. The show authorities will dispose of the honey if desired. You must state the price you are willing to take, and they will deduct a small commission on the sale.
- I. G. (Peckham, S.E.).—Section was broken to pieces when received, but we sampled the honey and found it a very sweet, light-coloured honey, with a slight flavour of limes. 1. It is very creditable to get twenty-eight such sections in a town district, especially in such a poor season as the present one. 2. Most probably the queen went up into the sections, for, though bees do transfer eggs, it is a rare occurrence, and only happens under exceptional circumstances.
- T. C. (Watford).—Fairly good honey, with flavour of limes. It contains no honey-dew. Tree honeys are always rather dark in colour.
- NOVICE (Cheshire).—Flavour of sample fairly good, but the honey is thin and colour poor. It contains a very small quantity of honey-dew, and might be saleable if kept until granulated. It is quite wholesome for table use.
- A. H. G. W. (Kent).—Good honey from mixed sources, chiefly sainfoin. Though rather lacking in consistency, it is quite good enough to exhibit, but is, we think, too light for medium honey class. It is rather cloudy, and should be slightly warmed to improve and brighten the colour before exhibiting. Honey from lucerne (or alfalfa) is light and very thick.
- Suspected Combs.*
- R. O. (Port Dinorwic).—Comb is affected with incipient foul brood of the mild or odourless type. We cannot say whether your district is suitable for bee-keeping or not, but the trees you men-

tion, though many are pollen-bearers, are not good in other ways, the honey obtained from them being of very poor quality. Rhododendron and privet honeys are also rank and unpleasant in aroma and flavour. The best bee-forage is white clover, with ling as an autumn source of supply.

Special Prepaid Advertisements.

Twelve words and under, Sixpence; for every additional Three words or under, One Penny.

OFFER 56s. cwt. for Light Extracted English Honey.—Sample and particulars to "BEE-KEEPER," care of Albery, 33, Carfax, Horsham. t 36

STRONG 10-FRAME STOCK, in good hive, with rack of sections and starters. Lot 26s.—BURT, 21, Station-road, Brockhurst, Gosport. t 33

EIGHT STOCKS OF BEES FOR SALE, on 10 Frames; the pick of 14 hives. Inspection.—BOOKER, Alfold, Billingshurst. t 33

DRAWN-OUT SECTIONS FOR THE HEATHER; 2s. 6d. doz.—MULLIS, Egerton, Kent. t 23

HEALTHY DRIVEN BEES, properly packed, 5s. 6d.; Queens, 2s. 6d.—152, Astwood-road, Worcester. t 37

HONEY FOR SALE; quality and colour good. Price 56s. Sample 3d.—SPARKES, Apiary, Chute-Standen, Andover. t 38

CACTI, about 300, sell 30s. per 100; or exchange Bees, Poultry, or Rabbits.—BRETT, 62, Cantwell-road, Plumstead. t 34

THREE STOCKS BEES (black), on 10 Frames each; strong, healthy; 18s. each.—HUGHES, Berthengron, Llanfair, Ruthin. t 28

EIGHT STRONG STOCKS, on 8 Frames (no hives), packed and free on rail; boxes returnable; 18s. each.—L. W. MATTHEWS, Great Rollright, Oxon. t 26

DRIVEN BEES, 5s. 6d. lot, guaranteed healthy, package returnable.—CADMAN, Codsall Wood, Wolverhampton. t 31

TWENTY HIVES OF ENGLISH BEES FOR SALE, zinc roofs, excluder, section-rack, and wired standard frames; guaranteed healthy; price 15s. to 21s., according to pattern.—KNIGHT, Sawkins, High Easter, Chelmsford. t 25

EXCELLENT SECTIONS FOR SALE, 1908 7s., 1909 8s. a dozen.—Apply GEORGE SAUNDERS, Oakley Lodge, Eye, Suffolk. t 22

FOUR STOCKS OF BEES, on 8 Standard Frames, 18s. each; 3 Single-walled Hives, nearly new, 5s. each; 50 Shallow Frames, Drawn-out Comb, perfectly clean, 10 for 5s.; 2 "W.B.C.," Section Crates, 6s.—Apply J. BROOKFIELD, 108, Stamford-road, Birkdale. t 21

BEES ON 8 FRAMES, with Hive, 25s.—ANDERSON, 128, Castelnau, Barnes, S.W. t 27

FOR SALE, best quality Light-colour Honey, 60s. cwt.; sample 3d. Also thoroughly good Stocks of Bees, on 8 Frames, 17s. 6d.—A. GREEN, Tangley Vale Apiary, Andover. t 35

CARNIOLAN BLACK QUEENS, 3s. each; Swarms ditto, established on wired frames, 10s. 6d. and 15s.; Bees, 1s. 6d. lb.—STORMONTIL, Kirkbride, Cumberland. t 29

HEALTHY DRIVEN BEES, WITH FERTILE QUEEN, 5s. lot; Fertile Queens, 2s.; postage 3d. each. Boxes free.—ROLLINS, Stourbridge. t 30

DRIVEN BEES, free from all diseases, with Young Laying Queen; safe arrival guaranteed; 5s. 6d. per lot; Young Laying Queens, 2s. 9d. each.—J. BRADFORD, Bee Expert, Worcester. t 39

FOR SALE, 20 Hives of Bees, Bar-framed, and Skeps.—J. WAYMAN, Cottenham, Cambridge. t 20

Editorial, Notices, &c.

BEES KILLED NEAR COPPER-SMELTING WORKS.

M. Ed. Bertrand, to whom it was addressed, sends us the following letter, which we publish not only for the information of our readers, but in the hope that some of them may be able to say if they have come across similar cases where new copper-smelting works have been started:—

The Ministry of Commerce and Agriculture of the Kingdom of Bulgaria.

Department of Agriculture.

Sofia, July 21, 1909.

HONOURABLE SIR,—By reason of your well-known ability in apicultural matters, the Royal Ministry of Commerce and Agriculture has the honour of addressing you on a question to be stated lower down, and which is of great importance to the apicultural industry of this country.

In a mountainous part of our land, watered by the Iskar, a tributary of the Danube—a region rich in honey-plants (natural meadows, lime forests, &c.)—all the colonies of bees, after having wintered well, began at the end of March to perish in large numbers, and towards the end of May every colony was exterminated.

As an average showing the fertility of this region, it may be stated that common hives gave from two to three swarms, while modern hives, especially the "Dadant-Blatt," yielded a return of three to four supers of honey of good quality. The region is protected from northerly winds, and is generally favourable for the culture of bees. Up to now, not one of the oldest bee-keepers in the district has known such an epidemic to so completely exterminate the bees.

It should be mentioned, amongst other things, that copper works have been started in this region, and in November, 1908, they commenced smelting the mineral pyrites, which are used for the production of copper, the gases given off during the process, which pass up the chimney, being composed of poisonous antimonial and sulphurous vapours. Within a distance of fifteen kilometres round the works, all the colonies of bees have been completely destroyed. The mortality commenced in the month of March, when the bees began flying and carrying in new honey and pollen from plants. The colonies nearest the works were first attacked, and then those more or less distant from them succumbed.

The colonies destroyed early in spring were found to be abundantly supplied with stores, brood-rearing had commenced,

and there were plenty of bees to care for the brood.

From the first outbreak, the most careful investigations were made in order to find out if the mortality was not due to some disease. There was, however, no trace of any disease known to apicultural science.

In order to gain knowledge respecting this special case, the following practical experiments were made:—In the month of May one of the attacked hives was transported to a distance of fifty kilometres. On the other hand, a healthy, well-developed colony from another district was brought and placed within two kilometres of the works. The bees in the first soon recovered and are now in perfect health, whereas the healthy bees placed near the works are on the point of dying, having no brood, and are lacking the energy which they should have under normal conditions.

Hoping that the above-mentioned case will interest you, the Ministry has the honour of appealing to your kindness, in asking you to give your opinion and say if you know of other similar cases.

Hoping to hear from you, we ask you, Sir, to receive our thanks and consideration.

(Signed)

The Minister, A. LIAPTCHÉV.

Chief of Department, A. GETCHEFF.

NORTHANTS B.K.A.

ANNUAL SHOW.

The Northamptonshire Bee-keepers' Association held their annual show at Abington Park, Northampton, on August 2 (Bank Holiday), in connection with the flower show, and in the Museum buildings the products of the bees were staged. Unfortunately the entries were only half the number of last year, the wet and cold weather being alone responsible for this.

Mr. W. Herrod, F.E.S., expert to the British Bee-keepers' Association, acted as judge, and also gave educative lectures in the bee-tent, which were well attended.

The following were the awards:—

Twelve 1-lb. Sections.—1st and silver medal, A. Hiscock, Loddington; 2nd, Mrs. Collins, Berrywood; 3rd, Askew and Kennedy, Odell; 4th, Geo. Mason, Yardley Gobion.

Twelve 1-lb. Jars Light Extracted Honey.—1st, C. E. Billson, Cranford; 2nd, W. Manning, Northampton.

Twelve 1-lb. Jars Extracted Dark Honey.—1st, G. Mason; 2nd, Jas. Adams, West Haddon; 3rd, A. Arlidge, Northampton.

Twelve 1-lb. Jars Granulated Honey.—1st, Northants B.K.A.; 2nd, G. Odell, Roade; 3rd, W. Manning.

Shallow Frames of Honey.—1st, A. His-

cock; 2nd, J. Adams; 3rd, C. J. Burnett, Northampton; 4th, Miss Burnett, Northampton.

Super in Glass or Wood.—1st, H. Williams, Overstone; 2nd, A. Arlidge; 3rd, G. Hickman, Northampton.

Beeswax.—1st, E. Palmer, Kettering; 2nd, Mrs. James, Piddington; 3rd, T. A. Roberts, East Haddon; 4th, A. Hiscock.

CLASSES FOR NON-FIRST PRIZE-WINNERS.

Six Sections.—1st, E. Palmer; 2nd, W. Pickbourne, Northampton; 3rd, C. W. Phipps, Northampton.

Six Jars Extracted Light Honey.—1st, E. Palmer; 2nd, W. H. Chambers, Northampton.

Six Jars Extracted Dark Honey.—1st, A. Arlidge; 2nd, H. Collins, Berrywood.

OPEN CLASSES.

Single 1-lb. Jar Extracted Honey.—1st, C. E. Billson; 2nd, H. W. Saunders, Thetford; 3rd, W. J. Cook, Market Rasen; 4th, F. J. Drake, Andover; 5th, A. Pugh, Beeston.

Special Class—Single 1-lb. Jar Extracted Honey.—1st, A. Sargeant, West Looe, Cornwall; 2nd, W. J. Cook; 3rd, R. W. Lloyd, Thetford; 4th, T. S. Hillier, Andover.

Honey-cake.—1st, J. Adams; 2nd, Mrs. Burnett; 3rd, A. Arlidge; 4th, Mrs. Mason. — R. HEFFORD, Hon. Sec., Northants B.K.A.

HONEY SHOW AT ABERDARE.

In conjunction with the Aberdare Horticultural Show the usual honey exhibition of this district was held on August 2. excellent weather prevailing the whole day. Unfortunately entries were few, owing to the very wet season experienced here.

The Rev. H. Morgan, B.A., our very popular county expert, judged the exhibits, and in the afternoon gave an interesting lecture and demonstration with bees kindly lent by Mr. G. Tudor Williams, the local expert, which were much appreciated. No bee-tent was used, and it was found a distinct improvement, for even the onlooking children allowed the bees to crawl on their hands and faces without fear. No one was stung, and most of the onlookers really doubted whether the bees "had stings." The demonstration will assuredly increase the interest in bee-keeping in this district. The following were the awards:—

Six 1-lb. Jars Extracted Honey.—1st and 2nd, M. Dobbins and M. Braddick, Cardiff; 3rd, G. Tudor-Williams, Aberdare.

Six 1-lb. Sections.—1st, G. Tudor-Williams.

Articles of Food Containing Honey—1st, M. Braddick.

Six 1-lb. Sections (novice class).—1st, Percy Rake, Aberdare; 2nd, C. Mosley, Cwmaman.

Beeswax.—1st, Percy Rake; 2nd, A. O. Hughes, Cwmaman.

Three Shallow Frames.—1st, — Danger, Llwydwd; 2nd, W. H. Flooks, Aberdare.

Display of Honey and Bee-produce.—1st, G. Tudor-Williams; 2nd, Percy Rake.

Local Competition—Six 1-lb. Jars of Honey.—1st, G. Tudor-Williams; 2nd, Percy Rake; 3rd, C. Mosley.—Hon. Sec., Aberdare B.K.A.

BEDFORD B.K.A.

The first meeting of the above association was held at the Cookery School, in Dame Alice Street, Bedford, on July 2. In spite of the inclement weather, the meeting was well attended, many of those present coming from the surrounding districts some miles away.

The chair was taken by Mr. Cecil W. Kaye, M.A., who in his opening remarks drew attention to the devastation which is being wrought amongst the stocks of bee-keepers in Bedford and district by the disease called foul brood. He urged most strongly the necessity for prompt and united action with the view of endeavouring to eradicate this worst of bee-plagues.

The meeting then proceeded to elect a committee, and five well-known local bee-keepers agreed to act on the same. Mrs. E. K. Hemsley, of 81, Ashburnham Road, Bedford, kindly consented to undertake the duties of honorary secretary and treasurer. The suggestion was then made that two inspectors should be appointed by the association—whose services should be at the disposal of members in need of advice or assistance. Mr. J. Harper suggested that the inspectors should be certificated experts of the British Bee-keepers' Association. This was agreed to, and Mr. F. W. Moore and Dr. H. W. L. Waller were accordingly appointed. The subscription was fixed at 2s. 6d. per annum for ordinary members, and 1s. per annum for cottage members.

Nearly all of those present enrolled themselves as members of the association, and the meeting concluded with a vote of thanks to Mr. Kaye for presiding.—(Communicated.)

W. B. CARR MEMORIAL FUND.

Amount already acknow- ledged	£	s.	d.
J. Nightingale	0	2	6
F. S. H.	0	2	6
J. Todd	0	2	6
H. Marr	0	2	0
	£57	6	0

Correspondence.

The Editor does not hold himself responsible for the opinions expressed by correspondents. No notice will be taken of anonymous communications, and correspondents are requested to write on one side of the paper only, and give their real names and addresses, not necessarily for publication, but as a guarantee of good faith. Illustrations should be drawn on separate pieces of paper. We do not undertake to return rejected communications.

CHLORINE AS A DISINFECTANT.

[7577.] Your correspondents Mr. Green and Mr. Campbell seem both to have a very elementary idea of the action of chlorine, and, without going into the question of its value as a cure for foul brood, I should like to take up a little of your space and try to give your readers some idea of its action, as well as some idea of its value as a disinfectant and deodorant.

Chloride of lime, commonly so called, is made by passing chlorine gas over slaked lime, the product being a chemical compound, not merely a mixture, of hypochlorite and chloride of lime. This compound owes its commercial as well as its industrial value to the amount of chlorine it contains, which it parts with to a large extent on exposure to moisture and air.

Thus exposed, it slowly yields hypochlorous acid. This breaks up into water, chlorine and chloric acid; this latter acid, being also unstable, decomposes into water, oxygen, chlorine, and perchloric acid.

To sum up, the hypochlorous acid given off by chlorinated lime in the presence of moisture gives up $\frac{1}{3}$ ths of its chlorine as gas.

Your correspondent is wrong in assuming that "any chemist will admit that oxygen has a far greater attractive power for hydrogen than has chlorine." Under certain conditions this is so; given other conditions and the very opposite prevails. Chlorine is used largely as a bleaching agent, and depends for its action on the well-known fact, which your correspondent disputes, of combining with the hydrogen of water and liberating the oxygen.

Dry chlorine gas will not bleach, as Mr. Campbell may prove for himself by submitting a piece of cloth coloured with some vegetable dye to the action of dry chlorine, and he will find no change if he leaves it for weeks; add a little water and the colour will be immediately destroyed, the nascent oxygen being in this case the real bleaching agent, although ordinary oxygen has not this power to any great extent, the wherefore of this being also easily explainable from a chemical point of view.

Mr. H. Campbell says: "Chlorine water is a commercial product, and were Mr.

Green's theory correct such a product would be impossible of achievement." Here he has his premises correct, but his deductions are totally false.

Chlorine water is a commercial product, but a very unstable one; it has to be prepared fresh to enjoy that distinction. In the presence of light this solution decomposes into hypochlorous acid and hydrochloric acid; these reacting form hydrochloric acid and oxygen, thus:

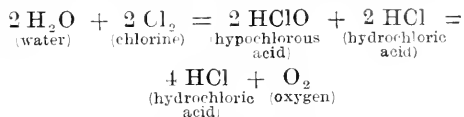

Chlorine's power as a disinfectant, of which it is one of the most efficient known, does not depend for its value on its destructive action on mucous membrane, as your correspondent contends, but to its action on putrefactive substances, these being in unstable chemical combination, and the action being similar to that upon organic colouring matter as explained above, although of a more complex character.

Both your correspondents seem to be unaware of the fact that to get a definite chemical action you must fulfil certain definite conditions.

Mr. Campbell seems to have a peculiar method of reasoning. Because chlorine is, as he says, in a concentrated form highly dangerous to life, that to me is no reason why it should not be tried as a cure for foul brood. Prussic acid is one of the most rapid and fatal poisons known, yet it is used in small doses as a sedative to the peripheral extremities of painful nerves.

In seeking for a cure for foul brood by the application of some chemical compound, be it gaseous or in solution, you will find this impossible to obtain without endangering bee-life, unless applied with a certain amount of skill; or, to put it in another way, the substance which will kill foul brood in its virulent form will also in a larger dose kill bee-life. This latter contention is my own, and open to be proved false, not an uncontrollable fact like the rest of this contribution. I am afraid I have trespassed rather largely on your space, but to be plain I have had to be prolix.—T. F. NEWTON, M.P.S., Durham.

CHLORINE FOR FOUL BROOD.

[7578.] I have read with much interest the correspondence in recent issues of your journal respecting chlorine and its properties, and have been struck not only by the fanciful theory of Mr. Green, but also by the inaccuracy of another corre-

spondent who criticises him in your issue of the 19th inst.

I presume that when Mr. Green states that microbes are gases he had in his mind that the ultimate atoms which constitute matter are believed by some to be vortex-whorls in the all-pervading ether. Even if so, it was ludicrous to stretch the idea so far as to say "a microbe is a gas." He might equally well argue that we ourselves are but "gases." He thinks that the typhoid germ is formed by the union of the carbon of filth with the hydrogen in water, as these "gases" easily unite. Now carbon does not "easily" unite with hydrogen, and the compounds of these elements are generally well known to chemists, and are certainly not alive.

Mr. Green's theory of the manner in which chlorine may effect a cure of disease is not without some basis, however. It is probable that the action of chlorine on living tissue is directly or indirectly due to its power of decomposing water, owing to its powerful affinity for hydrogen. This power is denied by Mr. Campbell, who says that the reaction represented by the equation

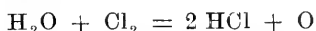

is impossible. Strangely enough, too, he instances the existence of chlorine water in support of his statement, and says that hydrogen has a much greater attractive power for oxygen than for chlorine.

If he had had any experience of chlorine water he would know that it is very unstable, because the chlorine is constantly breaking up the water and liberating oxygen in accordance with the equation:

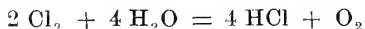

To retard this change chlorine water is kept in blackened bottles. It is for the same reason that chlorine is used for bleaching, the liberated oxygen being the active agent.

Mr. Campbell is also wrong in stating that *free* oxygen "offered to" hydrochloric acid will produce chlorine. Heat and a catalytic agent are necessary to aid in the decomposition.

With respect to Mr. Green's theory I am not disposed to say that it is unlikely that chlorine will destroy disease by altering the chemical constitution of some constituent of the organism of the microbe, and so causing its death: but I am inclined to think that it is more likely that if cures can be effected by environment, as distinguished from medicine, it is because the atmosphere is made such that all weakly and diseased bees are unable to live, and consequently the larvæ in time cease to receive infected food, those larvæ already infected being removed by the bees. I have effected several apparently successful cures by environment, and am at present

conducting some similar experiments with black brood, but I very much doubt whether diseased combs ever become permanently freed of disease, whatever cure be adopted.—L. E. S., Weston-super-Mare.

BEES AND POLLEN.

[7579.] Is it not generally held that bees invariably visit only one kind of flower during each foraging trip? Some five years ago a letter signed "H. Berkley Score, F.R.G.S., F.R.Hist.S.," appeared in the *Record* (page 58, 1904), stating that the writer had seen bees visit more than one kind of flower during one flight from the hive. He considered that this occurred when there was a scarcity of pollen or nectar. About two years ago there was a note in the B.B.J. where the writer said he remembered having seen bees visit different flowers during one flight. Beyond this, I have nowhere seen any reference to the fact that bees do sometimes visit more than one kind of flower on one journey; so hope that the following may be of interest.

During the last two summers I have made a practice of going down to the hives and collecting samples of pollen from the pollen-baskets of home-coming bees. I use a small camel-hair paint-brush, moistened between the lips, with which it is easy to remove from the bee's legs, as she runs up the alighting-board, any "load" of pollen one may wish to examine. The lumps of pollen so obtained are then placed on a clean glass slip, care being taken to keep them separate, and also to wipe the brush carefully on a clean cloth after each capture; so that each "load" of pollen remains as it was collected by the bee; and, if it be found to contain two or more kinds of pollen, we may infer that the bee has visited two or more kinds of flower during that journey.

I have so far collected samples of pollen in this way on some seventy days; and on eighteen of these have come across at least one mixed "load" of pollen. That is, on rather more than one day out of four mixtures have been observed. Of course the percentage of mixed to pure "loads" of pollen brought in by the bees is very much smaller than this.

In making the above calculation I have not counted any cases where there was cause to suspect that the brush had not been properly wiped or that the pollen had been mixed up on the glass slip; neither have I counted as mixtures cases where the proportion of one kind of pollen to the other was so small as to leave room for doubt whether some error (due to the above causes) had not occurred.

It is very probable that Mr. Berkley

Score's explanation is, in many cases, the true one. Possibly also, when many different plants are growing close together, as in a herbaceous border, the bee gets confused, and visits more than one kind of flower in consequence. Neither of these explanations will, however, apply to cases where the mixed "load" consists of two kinds of pollen, both of which are very plentiful at the time; for example, among cases I have observed are:—Heath (*Erica cinerea*) and heather (*Calluna vulgaris*), observed on August 6, 1908, and August 16, 1909; heather and dwarf gorse (*Ulex nanus*), observed on August 10 and 14, 1908. As (in 1908) heath was yielding pollen to the bees from June 24 to September 8, heather from July 20 to October 12, and dwarf gorse from August 10 to October 1, it is plain that scarcity of pollen can hardly be the explanation in these cases.

It seems, therefore, that we may conclude that, though bees usually keep to one kind of flower during each foraging trip, they do not, even under favourable circumstances, invariably do so.

I may mention that I have observed cases of mixed "loads" of pollen where one end of the bee's pollen-basket was occupied by one kind of pollen and the other end by the other kind, showing that the bee had not visited the two kinds of flower indiscriminately, but had begun on one kind and changed to the other when her pollen-baskets were partly filled. For example, on June 29, 1908, I took a "load" of pollen from a bee; to the naked eye it appeared to be yellow with a dark smudge at one end. On inspection it proved to be composed of pollen from some plant of the order Compositeæ (yellow pollen) and from a species of poppy (dark pollen). In other cases the two kinds were observed to be mixed up, showing that the bee had gathered pollen indiscriminately from the two plants concerned.—ANNIE D. BETTS, Camberley.

BEE-NOTES FROM DERBYSHIRE.

[7580.] July is past and gone, but the month will live long in the memory of bee-men in this locality as the coldest, windiest July ever experienced. Bees have been confined to hives for whole weeks; in fact, one might count the days on which they have gathered any honey on the fingers of one hand. Then the honey itself would put gas-tar to shame as far as colour is concerned. The clover has failed entirely here, and I believe bees got more honey from buttercups in early June than from anything else since. I failed to see a bee with pollen on its legs on a buttercup, so it was not pollen they were after. We had a wealth of May bloom this year—the hedges were a

white mass—but it yielded nothing but pollen, and the bees clogged many combs with it. I never remember stocks in such form for honey-gathering in early July as this year, and hopes were high for three or four days; then the bad weather set in and dashed them to the ground. Whatever the heather crop may be, bees will be scarce to gather it. In some of my strongest hives a month ago the queens had almost stopped laying, most notably my late-mated queen. I made an "Alexander" swarm with this hive three weeks ago to hatch all brood, thinking that the queen would fill the bottom full of brood for the heather, but whether caused by the cold honey-less days, or because she is failing, she simply confined her energies to two frames, so I have deposed her and given a young queen. One of my early June swarms swarmed again in the middle of July, but only sent off a small "cast," as the queen had two or three frames to lay in, there being only brood in six; but a neighbouring bee-keeper bought a swarm in May from Worcester, and on July 22 it sent off a 6-lb. swarm, leaving the hive so populous that he could hardly tell a swarm had issued. The queen must be a fine one to push breeding in a season like this. I can hear of nobody in this part having got any honey in supers. I took one of my hives about three miles away, and another six miles, and they have done a little better. This makes the third bad season, my "takes" being in 1907 12 lb. from fifteen hives; in 1908 50 lb. from thirteen hives; and in 1909 about 10 lb. from six hives and a swarm. I call that *keeping* bees, but we have managed to balance things up by taking them to the heather, which has saved buyingsugar for winter food, and we have besides secured a little prize-winning honey. I was surprised at there not being more Scotch heather-honey shown at the "Royal" Show. Mine did not get a look in at Ayrshire last year, after taking two first prizes at the chief London shows, and I quite expected to be left out altogether at the "Royal" after that; but it is a long way from Scotland to Gloucester, so no doubt the Scotch heather-men will meet me on the show-bench at Beverley or Carlisle, which is a bit nearer home. The hive I mentioned in my notes (page 244) as being so strong in spring has secured most honey this year. I took quite 40 lb. off it the other night, and it was packed with bees in two supers. I had taken it about three miles from here, and the bees worked on the charlock before the honey-dew appeared.

Later (August 9).—I thought a week since a change was coming, and what a magnificent one it has turned out! The bees at Rose Farm Apiary have worked

from morning till night on the few limes near, and brood-nests, formerly bare of brood and honey, are almost filled up. The queens are now laying, and unless room is given they will be crowded out with honey. It has been a tree-honey year about here, clover being conspicuous by its absence.

Mr. Pearman can, of course, keep his own opinion as to when my queen was mated last year (page 306), but I have had some in the hive nearly all July which were only mated this week. Bees are too eager to replenish the brood-nest to keep a queen in the hive long after she is mated without letting her lay. I rear about a score of queens every season, and carefully watch them each day, so I ought to know what I am writing about, and though I do work all night I am always up between ten o'clock and two, so I can tell whether queens will fly or not that day, as it is seldom they fly later.

I was on the moors on Sunday the 8th, a very hot day. One bee-keeper had placed nine hives there, and the bees were working well on the clover round about, but I could not see a bee on the heather, which grows very sparsely here. I could only find a sprig or two, and fear it will be late in blooming. I also have been to look at one of my hives six miles away on some clover. In June the sheep had eaten the fields quite bare; now they are knee-deep in clover and simply white, while the hum of the bees on it was a pleasant sound to hear. That hive actually swarmed on August 3. A friend found the swarm in a hedge when he went to look at his bees at night, or I should have lost it. He hived the bees in a box of shallow frames, and put it under the roof of the parent hive. Next day they were working out under the roof. So I thought I would leave them where they were, and they could go down through brood-nest out to work; but when I went again I found they had joined the bottom lot. The queen evidently tried to get round the excluder-zinc corner, and had stuck fast and died there; so with no brood to rear (the queen had stopped laying a week or two before, as brood was all hatched out) the bees are just clogging the brood-combs with some of the clearest honey ever seen; but it seems strange to have them storing so much honey now, when, as a rule, the harvest is all over by about the middle of July, and probably they will continue for another week if the weather keeps hot.—TOM SLEIGHT, Danesmoor, August 9.

COMB-FOUNDATION AND JUDGING SECTIONS.

[7581.] I am forwarding for your inspection a sample of comb-foundation.

Will you kindly say if same is genuine beeswax, seeing that I have had an exceptionally large proportion of sheets broken down, although each was properly wired, similar to those I have done for over twenty years?

I was indeed sorry you were out of town when I called at the B.B.J. offices (July 30) during my brief stay in the Metropolis, as I should have liked very much to have a few minutes' talk (and to make your acquaintance personally) on the subject which takes up the greater part of my leisure time.

In the B.B.J. of November 28, 1907 (6909), you published an article of mine *re* "Large Honey-Take." It may be interesting to know that a very large swarm has taken possession again (July 15), and seems to be doing well, from outward appearances.

I should be pleased to have your opinion as to what are the rights and the privileges usually allowed to adjudicators in judging comb honey. I sent a beautiful section to a show last week. It was returned to me this morning, and to look at the large amount that had been consumed one would naturally have thought it had been returned from the tea-table. Although I obtained the premier prize, I do not think it necessary for judges to entirely deface and render exhibits unfit either for sale, show, or other purposes. It is very annoying to have an exhibit spoiled in this way (? legal), especially when I had anticipated showing again in the near future, and with no prospect of replacing the breach this year. Some of the other competitors had even a larger amount taken from their exhibits than I had.

To-day it is raining heavily, accompanied by vivid flashes of lightning and heavy peals of thunder. I could occasionally send a few bee-notes from this corner of North-west Durham, if you think they would be interesting to your readers.—J. WATSON EGGLESTONE, W. Durham.

[If the foundation breaks down when properly wired it is probably not made of pure beeswax. A number of tests are given on pages 95-97 of "Wax Craft," which if carried out would show if the foundation is adulterated. There was certainly no occasion for such a large piece being cut out of the section, as judges usually employ a glass taster specially made to go into a cell. We seldom think it necessary to taste more than one cell, and this is generally selected on the outer edge, so as not to injure the section. So large a piece as that taken out of yours, which amounts to about a quarter of the section, not only disfigures it, but is absolutely unnecessary. We shall be pleased to have your notes.—ED.]

MIDLAND NOTES.

[7582.] The past season, so far as the Midland counties are concerned, has been a very disappointing one indeed. After such a favourable spring we hoped for better things, but June and July proved quite a failure, being cold and sunless; and when August came with much-improved weather it was too late for our bees to take advantage of it. Like most other districts, the moderate quantity of honey gathered is more or less spoilt with honey-dew, and I am afraid there will be very little fit for sale.

A *Simple Feeder*.—For the feeding of swarms or driven bees a simple and inexpensive feeder may be made as follows: Take a piece of board 5 in. by 5 in. by $\frac{5}{8}$ in. thick, and in the centre cut a 2-in. circular hole; over this tack a piece of wire cloth with a mesh of about fourteen to the inch—this will form the stage for placing over the feed-hole in the quilt, but be careful to keep the wire cloth on top: the hole in the board will then form a space for the bees to cluster in and take the food. Next get a glass jar (a 1-lb. honey-jar will do), fill it with syrup, and over the mouth place a piece of strainer-cloth, which may be secured with string, or, better still, an elastic band, as it can then be quickly taken off or put on again. In turning up the jar to place it on the stage it is necessary to place a small piece of board over the mouth, and then after turning it over gently slide the jar off this on to the stage; none of the syrup will then run out and make a mess. When using this feeder it is best to see that no bees have access to the roof of the hive from the outside, or robbing may commence.—F. E. MATTHEWS, Northfield.

BRITISH BEE-KEEPERS AND COUNTY ASSOCIATIONS.

[7583.] Replying to "Hon. Secretary" (7573, page 326), I am pleased to find that my remarks have not fallen to the ground unnoticed. The cap has evidently fitted at least one honorary secretary, but I should like to inform him that when I joined the association in question I was a *bonâ-fide* cottager according to their rules, and also the aid I wanted was promised in those rules. I asked for no more, and weather (admitted by all bee-keepers not to be so bad as this year) and all other obstacles that "Hon. Secretary" can mention I will take into account. I acknowledge that I could have had advice and aid from other bee-keepers, but as the expert (according to the postcards sent) was always coming, they advised me to leave matters for him. Had I relied solely on the expert's advice and promised visit I should have done as "Hon. Secretary" says and "given it up," or at

least my bees would have done so; but at present I am more keen on bee-keeping than ever. I have had no outside help, but through the knowledge obtained from the B.B.J. and "British Bee-keepers' Guide Book" (both good) I have this year taken over 20 lb. of honey, and I think shall be able to take 40 lb. more; this from two stocks. It may interest "Hon. Secretary" to know also that I exhibited in an open class and obtained a second prize. I have bought some driven bees, which look like making good stocks, given fair weather, and this is more satisfactory to me than the advice "Leave them till I come" and "Give it up." I have not drained the resources of the association, as all I got is mentioned above, and a few postcards do not cost much. I thank "Hon. Secretary" for his advice to "give it up," which I will take—as far as the association is concerned. Name enclosed for reference.—BEGINNER.

[7584.] I gather from the letter from "Hon. Secretary" in B.B.J. (page 326) that the amount of attention a member receives from a county association depends on the amount of his donation. My hives are suffering from a bad attack of "sans miel," and I should like to consult an expert. Will you kindly let me know if a subscription of ten guineas will ensure his attendance, say, on Boxing Day this year?—A MILLIONAIRE, Bradford.

[7585.] The thanks of all beginners thinking of supporting their county association are due to "Hon. Secretary" (page 326) for his intimation that only members who pay high fees are wanted. Personally I do not consider even the repeated promises of a visit from an expert worth half a crown.—PIE-CRUST, Sussex.

CROAKING NOISE IN HIVE.

[7586.] Referring to the B.B.J. of July 8 (page 269), your correspondent "S. T. Chichester," asks what is the sound made by queens piping, as he has heard a noise in the hive like the croaking of a frog.

One night I heard a noise exactly like the croaking of a frog, and on removing the hive-roof it was so loud that I could hardly believe it came from bees. It kept recurring at short intervals with varying force of sound. At the time the bees were casting out drones, and I noticed one was generally cast out soon after the sound had ceased.—J. H. TODD, Hull.

[The usual sound heard when drones are being expelled has been interpreted as "Brr-brr-brr." See "The Honey-Bee," page 87.—ED.]

AMERICAN AND COLONIAL PAPERS.

EXTRACTS AND COMMENTS.

By D. M. Macdonald, Banff.

Not Italians.—Of a stock that has done exceedingly well with him a writer in *Canadian B.J.* says:—"They are not beautiful Italians, but a mixture of Carniolans and blacks. Apart from being such hustlers they are very quiet to handle." The editor also commends similar queens as very prolific and vigorous:—"Certainly we could not ask for better work from queens than these have done. They are a cross between Carniolans and blacks—the black predominating."

"Automatic" Management.—*Gleanings* recommends the following plan:—"If one is engaged in business and can be at his yard only night and morning, he should tier up two, three, or even four stories. This kind of management is as nearly automatic as anyone can adopt. There will be little or no trouble from swarms, and one can do all the necessary work night and morning. Indeed, he may not have to go near his hives oftener than once a week. When the season is over he can take off his honey at one handling, &c." For the busy business man, the labourer away from early till late, or for working small out-apiaries, I have recently advised the foregoing as the best possible management. With a minimum of work there is likely to be a maximum of profit, as too much fussing is more frequently a bane than a blessing to the bees.

Introducing Queens.—Here is another extract well worth acting on. Indeed, I am not sure but it is about the best of the many I have recorded from time to time. "It is well known that young bees are much more kindly disposed towards strange queens or bees than old ones. To that end we can take out a frame or two of bees and hatching brood and put them in another hive on a separate stand. At the end of twenty-four hours all the old bees or those that will be hostile towards an old queen will have gone back to their old home. We can now with comparative safety introduce the valuable queen, or a five or six days old virgin, giving the bees some time to liberate her." The caution is given that this should be left to the bees unaided by the apiarist, because every time the hive is opened the bees are disturbed more or less, and each of these disturbances endanger "balling."

Hope.—Apparently the miserable season we had until the opening of August has been felt also in America. Miss Wilson informs us that at the very time when honey should have been coming in at its best they were giving bees store combs "to keep them from starving." The

editor of *A.B.J.*, commenting on several similar reports, begins already to look forward to *next* season with expectant eyes. "Your true bee-keeper is a hopeful individual, and if the season should prove to be one of entire failure, he will only the more hopefully look forward to what may be in store for him next year. Good seasons have been, and good seasons will be again." Since the advent of August we have had superb bee-weather, with a good flow from white clover and alsike, and the heather after the 10th of the month yielding well. So we have got beyond the hoping stage—at last.

Dead Brood.—Examining some hives about the end of June, a good deal of dead brood was seen, so much so that one of the party fancied it might be foul brood. Although I was certain the symptoms were different, I kept an eye on that and several other hives. It turned out to be simply *undeveloped* brood. Owing to the cold and the shortage of both honey and pollen the brood was insufficiently fed and not fully cared for. Mr. Root records the same:—"There has been considerable dead brood reported from various sections. When there is a scarcity of nitrogenous food some of the larvæ die, because they have not a balanced ration. It appears usually in the cells not sealed. The larva lies on its back at the bottom of the cell with its two ends curved up. Unlike the real black or foul brood the bees will, however, remove this matter." That is exactly what occurred here, and I mention it to allay the fears of many who may have mistaken this for foul brood.

Damping Sections.—The Editor of the *Review* commends Mr. Townsend's system of damping sections which have been allowed to become too dry and brittle. In this condition a good many of them snap in folding. Pouring water in the V-cut is apt to be overdone, in which case the wood swells so much that they cannot be folded true. Mr. Townsend recommends laying the sections together and covering them with a wet blanket over-night, when on the morrow they will be found in first-class condition for folding. Regulate the dampness of the cloth to the brittleness of the wood.

Colour of Wax.—Dr. Miller *thinks* all virgin comb in his apiary is white. Mr. Cowan discovers a tinge of yellow in even the whitest in this country. New comb being built by a swarm appears quite white, but if melted down it will be of a yellow shade. How yellow depends on several circumstances. Mr. Root considers "this depends very largely upon the conditions of locality and season; but in many cases the colour depends on the honey and pollen. Commercial wax is

yellow or brown, probably because the combs contained more or less pollen." There can be no question, I think, that the colour of wax depends on the honey of which it has been manufactured, and also the pollen, less or more of which is incorporated in the cake. Compare wax built of sugar syrup and that constructed during a heather flow. What a vast difference is shown not only in colour but in aroma and ductility.

Painting Hives.—In a symposium on this subject writers to the *Australian Bee-keeper* all agree that hives should be painted in order to preserve the wood, to prevent cracks and openings, to lengthen the existence of the hive, to help in allaying the temperature in summer, and assist in preserving it in winter, but they do not forget that an apiary looks ever so much better with all hives painted. White is the favourite colour, but several have a fancy for a cream shade, and others mention green, blue, red, and indigo. All agree the best paint is the cheapest in the end.

Bee Shows to Come.

September 1 and 2, at Carlisle.—First Annual Show of the Cumberland B.K.A. Judges, Messrs. D. M. Macdonald and L. S. Crawshaw. **Entries closed.**

September 2, at Stockport.—Annual Show of Honey, &c., in connection with the Adlington and E. Cheshire Agricultural Society's Honey Department, under the direction of Cheshire B.K.A. **Entries closed.**

September 4, at Bramhall, Stockport.—In connection with Bramhall Horticultural Show. Honey Section under management of C.B.K.A. **Entries closed.**

September 4, at Crayford, Kent.—Annual Honey Show. Open Classes. Sections and Jars (Light and Dark), 6 of each. Entrance fee 1s. Schedules from J. M. Bates, Hon. Sec., Warren Road, Bexley Heath.

September 7 and 8, at Derby.—In connection with the show of the Derbyshire Agricultural Society at Osterley Park, Derby. Honey Department under the direction of the Derbyshire B.K.A. Several Open Classes. Schedules from Hon. Sec., R. H. Coltman, 49, Station Road, Burton-on-Trent. **Entries close September 1.**

September 13, at Conway, N. Wales.—Annual Honey Show, in connection with the Conway Honey Fair. Open and local classes. Schedules from J. Hughes, Town Hall, Conway. **Entries close September 6.**

September 16, at Castle Douglas.—In connection with Dairy Produce Show, the annual show of the South of Scotland Bee-keepers' Association. Open Classes for three 1-lb. Jars (20s., 10s., and 5s.); three Sections (20s., 10s., and 5s.); entry 2s. One Jar (5s., 3s., and 2s.); one Section (5s., 3s., and 2s.); entry free, but exhibits forfeited unless otherwise arranged. Beeswax (5s., 3s., and 2s.); entry 6d. Thirteen Classes trouble to Members. Numerous prizes, including two Challenge Cups and gold and silver medals. Schedules from Q. Aird, Hardgate School House, Dalbeattie, N.B. **Entries close September 4.**

September 16, 17, and 18, at Crystal Palace.—Surrey B.K.A. Annual Exhibition of Bees, Honey, Wax, Appliances, &c. Twenty-seven classes (nine open to all). Many medals and increased prizes. Schedules from F. B. White, Secretary, Marden House, Redhill, Surrey. **Entries close September 1.**

September 18 to 25, at the Agricultural Hall, London.—Honey Show in connection with the Seventeenth Annual Exhibition and Market of the Grocery and Kindred Trades. Liberal prizes. **Open to all British Bee-keepers.** Schedules from H. S. Rogers, Secretary, Exhibition Offices, Palmerston House, Old Broad Street, London, E.C.

September 22, at Altrincham.—Honey Show, in connection with the Altrincham Agricultural Show, the largest one-day show in the Kingdom. Classes open to United Kingdom. Classes for Trophy of Honey, for Best Hive, Observatory Hive with Bees and Queen, twelve Jars of Extracted Honey. Classes open to County of Chester, for Run and Section Honey, Wax, &c. Special Classes for Cottagers, and Special Classes for Society's District. Good prizes, low entrance fees. Schedules from Mr. J. Herbert Hall, 2, Dunham Road, Altrincham. **Entries close September 4.**

Notices to Correspondents.

J. A. (Herts).—*Hive Construction.*—1. You can make your "Combination" hive to hold as many frames as you wish, but usually sixteen are found sufficient. Whether the hive has single or double walls is a matter for the bee-keeper to decide, as both are used. The entrances alluded to on page 277 are placed at each end. You must work out the dimensions of lifts, &c., when you have decided on the size of hive you wish to make. 2. There is an objection to sliding chambers, especially when they get stuck with propolis and brace-combs. 3. No, there are not many districts where the large hives used in some parts of the Continent can be profitably worked, and hives with standard frames can be enlarged to any extent for all requirements. Foundation and all appliances are now made to use with the standard frame, and if you had any other you would have to get everything made specially for you at a considerable increase of cost. As you have only begun bee-keeping this year we would advise you to adopt the standard frame and be content with methods that have been found most successful by our largest bee-keepers and those working on a commercial scale. You can easily adapt your commercial "W.B.C." hive to your requirements.

J. P. PHILLIPS (Worcester).—*Name of Insects.*—The insects sent, which were found in crop of pheasant, are drone-flies. We do not know if the pheasant is sufficiently expert in distinguishing *Apis mellifica*, but have never heard of it eating bees.

S. C. S. (Motcombe).—*Deserted Skep.*—From the specimens of comb sent it is evident that the bees left owing to starvation. The comb has been bitten in order to get out the last trace of honey.

J. T. (Windsor).—*Name of Insect.*—It is *Sirex gigas*. The key to the diagrams published by the B.B.K.A. has been out of print for some years, but you will find all the explanations you require in "The Honey-Bee" to be obtained at this office.

C. J. ASHWORTH (Wilts).—*Uniting Driven Bees.*—1. It is not necessary to cage queen if the instructions given on page 107 of "Guide Book" are carefully carried out. 2. It is possible to keep queens through the winter in nuclei of three standard frames provided they are well crowded with bees, but it is hardly worth the trouble, seeing that queens are raised so easily in spring. 3. Such a divisional hive as you propose would answer the purpose.

DISTRESSED (Glouce).—*Drone-breeding Queen or Fertile Worker.*—You could tell if you had a fertile worker by examining the brood, which would appear as shown on page 13 of "Guide Book." You can unite one of the driven lots with your queenless colony, and then unite the one having fertile worker with this. Otherwise,

remove the one with the fertile worker to a fresh place at some distance from present stand, and after a few days shake the bees down on a sheet a hundred yards or more away. The bees, all but the fertile workers, will return to the hive, and you can then unite in the usual way one of the driven lots with them.

BEGINNER (Bristol).—Home-made Hive.—It is quite immaterial which way you place your frames. There are many bee-keepers who like them parallel with the front, while others prefer them the other way, as the bees dropping off the combs in winter are not so liable to obstruct the entrance.

R. C. CLARK (Essex).—Removing Supers.—1. These should be removed at the end of this month. 2. Breeding will go on so long as there is anything coming in. 3. As breeding decreases less pollen is required; consequently less is collected. You can only tell if the brood-chamber is choked with honey by an examination. 4. If you apply to the Hon. Secretary of the Essex B.K.A., Mr. G. R. Alder, Rawreth, he may be able to tell you if you could hire an extractor from any member in your neighbourhood, if the association has not one of its own. 5. As you already have the bees in a ten-frame hive these should be sufficient, and you may have to remove some of the frames for winter if they are not covered with bees. 6. Boil it until it is reduced to about one pint. 7. Not later than the middle of September.

J. NICHOLSON (Cumberland).—Name of Insect.—From your description we should say the insect was the female *Sirex gigas*. The ovipositor is used to perforate the bark of fir trees, and the larva deposited there finds itself in the midst of its food.

Honey Samples.

H. JACKSON (Durham).—Flower honey discoloured by honey-dew.

L. B. W. (Wells).—Honey of good flavour and consistency, from fruit blossoms.

READER.—Thin honey of good flavour slightly discoloured by honey-dew.

H. J. E. (Broxbourne).—The honey is thin, and is from beans and other flowers, with a trace of honey-dew. It is quite possible you may find similar honey in the other hives, as there was a short period when honey-dew was plentiful, which would spoil the appearance of the honey if the supers were not removed. Since that time light honey has again been coming in. Some people prefer dark honey to light, and it would be saleable.

ERICA (Colwyn Bay).—The honey has an objectionable flavour, and appears to be contaminated. It is possible to clarify honey by chemical process, but it would not be improved by it.

C. C. (Cheltenham).—It is difficult to tell English from foreign honey when gathered from the same flower, but in the sample sent there is a distinct flavour which we have not met with in English honey, and we should suspect it of being foreign.

J. B. (Bridgnorth).—Your honey is from privet and other flowers slightly discoloured by honey-dew. It is dark, but quite wholesome.

C. EDSALL (Luton).—The light honey is of good colour, flavour fair, but too thin to be classed as a good exhibition honey. The dark sample is better in flavour and consistency, and might secure an award in dark honey class, though there is a slight trace of honey-dew.

W. H. R. (Wisbech).—No. 1 is of good quality and consistency. It does not granulate on account of the large amount of levulose in it. In course of time it may do so, but we have known similar honey to remain liquid for several years. No. 2 is rather coarse in the grain, strong-flavoured, and high-coloured. No. 3 has a fine granulation, and is consequently of slightly better quality

than No. 2. No. 4 is a mixed honey of good quality and consistency.

L. E. G. (Beckenham).—Sample is almost white and very thin; it resembles syrup more than honey, and has a slightly burnt taste. Perhaps the bees have been over-fed, and stored the syrup in the supers together with a little honey, or they may have been robbing.

J. P. (Troedyrhiw).—Gathered from beans and mixed sources; contains a little honey-dew. Not good enough for a table-honey, but might be used for bee-food, or why not try it for mead-making?

J. CHANDLER (Blackheath).—The glass containing sample was smashed in transit, but the honey is from limes, and of good quality.

C. J. S. E. (Campton).—Honey is from mixed sources, but the predominant flavour is from limes. A very palatable dark honey, with a slight trace of honey-dew.

E. J. G. (Belfast).—Rather thin honey from beans and other sources. It also contains honey-dew. We should class it as of poor quality.

F. CHENNELLS.—The sample of honey has evidently been lost in post, as it has not reached us.

O. I. B. F.—Honey is fairly good in colour and flavour, but lacking in consistency. It could not be called a first-class honey.

*** Several important letters, &c., are in type, but held over from pressure on our space.*

Special Prepaid Advertisements.

Twelve words and under, Sixpence; for every additional Three words or under, One Penny.

FOR SALE, 5 Stocks, well established, on 10 Standard Frames, in good Hives.—For price, &c., apply to F. S. GLOVER, South Leverton, Lincoln. t 50

FOR SALE, 2 Empty Hives, quantity Supers, Frames.—E. BENNETT, Heacham, Norfolk. t 47

EXTRACTOR WANTED, good condition essential. State make, price.—"E." c/o BEE JOURNAL.

HEALTHY DRIVEN BEES, for September, 1s. per lb.—R. MANLEY, Potcote, Towcester. t 41

6 DOZEN DRAWN-OUT SECTION COMBS, 2s. 6d. dozen; strong Stocks, on 8 frames, 18s.—L. W. MATTHEWS, Great Rollright, Oxon. t 48

DRIVEN BEES, from strong, healthy Stock, with young Queen, 5s., package free; ditto, by parcel post, 5s. 9d.; Young Laying Queen, selected, in self-introducing cages, 2s. 9d.—SOLE, Expert, Stotfold, Beds. t 57

QUEENS, choice 1909, bred from my non-swarming stocks, 3s. 6d. each, per return.—TAYLOR, "Hollyhurst," Boldmere-road, Wyld Green, Birmingham. t 55

BEE AND POULTRY FARM, including day-old chick business, established six years, six-roomed house, stable, coach-house, grain shed, large incubator house (1,600 egg capacity), workshop, store shed, and large well-stocked kitchen garden, two acres of land, all wired, ideal honey district, miles of heather, rent £16 per annum; Stock of Bees, Incubators, and few appliances to be taken over.—Full particulars, E. W. FRANKLIN, St. Ives, Ringwood, Hampshire. t 55

STRONG STOCKS OF MY SELECTED BEES, on 8 frames, 17s. 6d., healthy, and safe arrival guaranteed.—TAYLOR, Hollyhurst, Boldmere-road, Wyld Green, Birmingham. t 54

100 DRAWN-OUT SHALLOW FRAMES OFFERED, 7d. each, on rail.—P. ASH-KENAZIE, Ulrome, Hull. t 52

FOR SALE, Swarm, in good newly-painted double wall Hive, Brood, in frames, 16s., a bargain.—ARTHUR FLETCHER, Sedgefield, co. Durham. t 51

Editorial, Notices, &c.

KENT HONEY SHOW AT WYE.

The eighth annual honey show was held at Wye on the 11th ult., in connection with the local horticultural show and sports, and proved very successful. Considering the unfavourable season in this part of England, a very large quantity of honey, &c., was staged, and Mr. F. W. L. Sladen, who acted as judge, had a very difficult task in arriving at a conclusion in several of the classes, competition being so very keen. Mr. Sladen in his report of the show says: "The average quality of the honey was very good indeed, and the fine display did great credit to both exhibitors and stewards."

The honey exhibits proved a great attraction, and during the whole period the show was open the tent was crowded with visitors. Mr. Jesse Garratt gave demonstrations with live bees in a separate tent erected for that purpose. The Hon. Mrs. Deedes, who is greatly interested in bee-culture, presented the prizes to the successful exhibitors. Subjoined is a list of the judge's awards:—

OPEN TO KENT.

Six 1-lb. Sections and Six 1-lb. Jars Extracted Honey (9 entries).—1st (Past President's (1907) Silver Challenge Cup), Mrs. Seadon, Bromley; 2nd, S. Burden, Headcorn; 3rd, H. W. Trendell, Harrietsham; 4th, A. J. E. Baker, Betteshanger.

Six 1-lb. Sections Comb Honey (15 entries).—1st (Past President's (1908) Silver Challenge Cup), E. R. Nash, Smarden; 2nd, A. J. E. Baker; 3rd, Mrs. Seadon.

Two Standard or Shallow Frames of Comb Honey (11 entries).—1st, T. Head, Canterbury; 2nd, J. Pack, Ashford; 3rd, A. H. Briggs, Bilting; 4th, W. J. Moody Smith, Pluckley.

Six 1-lb. Jars Light Extracted Honey (16 entries).—1st, A. J. E. Baker; 2nd, Rev. M. W. B. Osmaston, Goodnestone; 3rd, Mrs. Seadon; 4th, S. Darlington, Charing.

Six 1-lb. Jars Medium Extracted Honey (17 entries).—1st, H. W. Trendell; 2nd, Rev. H. R. N. Ellison, Hothfield; 3rd, Mrs. Seadon; 4th, J. Pack.

Six 1-lb. Jars Dark Extracted Honey (12 entries).—1st, J. G. Hall, Wye; 2nd, W. Brown, Westwell; 3rd, T. Head; 4th, E. R. Nash.

Three 1-lb. Sections and Three 1-lb. Jars Extracted Honey (9 entries).—1st, S. Darlington; 2nd, A. H. Briggs; 3rd, F. E. Green, Northbourne.

Beeswax (14 entries).—1st, E. R. Nash; 2nd, W. J. Moody Smith; 3rd, F. E. Green.

Mead (5 entries).—1st, A. E. Allchin, Kennington; 2nd, Mrs. Hall, Wye.

Bee-candy (9 entries).—1st, S. Burden; 2nd, T. Head.

Single 1-lb. Jar Granulated Honey (13 entries).—1st, S. Burden; 2nd, E. R. Nash; h.c., W. J. Moody Smith.

Cake Sweetened with Honey (7 entries).—1st, F. E. Green; 2nd, Miss Gillings, Wye; 3rd, A. E. Allchin.

Display of Cut Flowers Visited by Bees (5 entries).—1st, Mrs. Hall; 2nd, W. Hills, Kennington; 3rd, Miss H. McGregor, Wye.

Three 1-lb. Sections (cottagers only) (7 entries).—1st, A. H. Briggs; 2nd, J. Goodsell, Sissinghurst; 3rd, T. Wyatt, Calehill.

Two 1-lb. Jars Extracted Honey (cottagers only) (11 entries).—1st, J. Mepham, Orlestone; 2nd, J. Pack; 3rd, T. De Vere, Harbledown.

OPEN CLASSES.

Trophy of Bee-products (4 entries).—1st (Champion Silver Cup), Mrs. Hall; 2nd, J. Pearman, Derby.

Single 1-lb. Jar Light Extracted Honey (22 entries).—1st, R. W. Lloyd, Thetford, Norfolk; 2nd, W. Patchett, Cabourne, Lincs; 3rd, Mrs. Seadon.

Single 1-lb. Jar Medium or Dark Extracted Honey (24 entries).—1st, W. Brown, Westwell, Kent; 2nd, A. Lepper, Wye, Kent; 3rd, J. M. Best, St. Austell, Cornwall.

Single 1-lb. Section (20 entries).—1st, A. W. Weatherhogg, Willoughton, Lincs; 2nd, J. Pearman; 3rd, W. Canham, Soham.

Beginner's Outfit (2 entries).—1st, T. Head; 2nd, Mrs. Seadon.—(Communicated.)

CAMBRIDGE MAMMOTH SHOW.

In spite of the rough, wet weather the Cambridge Show held on August Bank Holiday was a great success. Over 16,000 people attended, and the bee and honey section was one of the most popular features. Though the season has been one of the worst from a bee-keeper's point of view, experienced for many years, the entries were three times as many as those of last year, and a still more satisfactory feature was that, with the increased numbers, there was a corresponding increase in quality, the show all round being the best ever held in Cambridgeshire. Mr. R. Brown, of Somersham, and Mr. Allan Sharp, Litlington, acted as judges, and the general excellence of the exhibits made their task one of extreme difficulty. Mr. Sharp and Mr. Brown also gave lectures on bees and bee-keeping during the day, and their demonstrations were watched with great

interest by large crowds. The awards were as follows:—

Display of Honey.—1st, R. H. Baynes, Cambridge; 2nd, G. Hills, Coton.

Twelve Sections (special prize given by Messrs. J. Lee and Son, London).—1st and special, R. H. Baynes; 2nd, C. Holmes, Fulbourn; 3rd, S. Catling, Hildersham; v.h.c., A. Barber, Comberton; h.c., R. Alderman, Babraham.

Twelve 1-lb. Jars Light-Coloured Honey (special prize by Mr. E. H. Taylor, Welwyn).—1st and special, R. W. Lloyd, Theford; 2nd, R. H. Baynes; 3rd, A. S. Gibbs, Bartlow; v.h.c., H. W. Seymour, Alford, Lincs.; h.c., J. Kitson, Stansted.

Twelve 1-lb. Jars Medium-coloured Honey.—1st, R. H. Baynes; 2nd, G. Hills; 3rd, A. Barber.

Three Shallow Frames.—1st, J. Lee and Son, Fulbourn and London; 2nd, C. J. Mapey, Cherryhinton; equal 3rd, J. Lee and Son and T. Bunting, Debden.

Six 1-lb. Sections (special prize by Messrs. J. Lee and Son).—1st and special, G. Hills; 2nd, R. H. Baynes; 3rd, E. F. Dant, Cambridge; v.h.c., C. Holmes, Fulbourn; h.c., T. Bunting.

GIFT CLASSES.

1-lb. Section (special prize by the Hon. E. S. Montagu, M.P.).—1st and special, W. Barnes, Exning; 2nd, E. F. Dant; 3rd, R. H. Baynes; v.h.c., H. Skipper, Stapleford; h.c., C. Holmes.

1-lb. Jar (special prize by the Hon. E. S. Montagu, M.P.).—1st, A. H. Suckling, Linton; 2nd, A. S. Gibbs, Bartlow; 3rd, W. G. Tweed, Great Thurlow; v.h.c., W. J. Cook, Binbrook, Lincs.; h.c., I. Rayner, Newmarket.—E. F. DANT, Secretary.

YORKSHIRE AGRICULTURAL SHOW.

BEE AND HONEY EXHIBIT.

One of the attractions of the Yorkshire Show has always been the bees and appliances, and the exhibition held at Beverley from August 10 to 12 was no exception to the rule, many visitors inspecting the bee and honey section with evident interest. Messrs. W. Dixon, Leeds, and E. H. Taylor, Welwyn, Herts, both staged good collections of bee-appliances—not for competition—and other interesting novelties were a honey-comb design, an observatory-hive, and a swarm-catcher.

There was a very good entry of honey in the open classes—in fact, the best that has been shown. Some of the exhibits had travelled from the South of England. These, however, were last year's gathering, and consisted chiefly of heather, which was in excellent condition. The Yorkshire class was not so good, there being many vacant places. The disastrous sea-

son this year has no doubt been seriously felt, causing a small display, but what few sections were shown were above the average.

The judge was the Rev. Sidney Smith, of Wheldrake Rectory, York. During the day the Rev. R. M. Lamb, the vicar of Burton Pidsea, gave interesting lectures, with the manipulation of bees in the open, the latter being done by Mr. W. Dixon. In regard to the latter, it is worth noting that the bees handled were the ordinary English black.

The following were the awards:—

Complete Frame-hive.—1st and 2nd, W. Dixon, Leeds; 3rd, A. C. Jemison, Dringhouses, York.

Twelve 1-lb. Sections Heather Honey.—1st, H. Waddington, Boroughbridge; 2nd, W. Dixon; 3rd, J. Pearman, Derby.

Twelve 1-lb. Sections, other than Heather.—1st, W. Dixon; 2nd, A. W. Weatherhogg, Willoughton; 3rd, W. Patchett, Caistor, Lincs.

Twelve 1-lb. Jars Extracted Heather Honey.—1st, Burn and Botham, Whitby; 2nd, J. Pearman; 3rd, T. Sleight, Chesterfield.

Twelve 1-lb. Jars Extracted Honey, other than Heather.—1st, A. W. Weatherhogg; 2nd, W. Patchett; 3rd, W. Dixon.

Twelve 1-lb. Jars Granulated Honey.—1st, W. Dixon; 2nd, A. W. Weatherhogg; 3rd, J. Pearman.

Beeswax.—1st, F. Harris, Sibsey, Boston; 2nd, W. Patchett; 3rd, W. F. Trine-man, Saltash, Cornwall.

Six 1-lb. Sections.—1st, G. Garbutt, Ingleby, Barwick; 2nd, H. Waddington; 3rd, E. W. Spink, Easingwold.

Six 1-lb. Jars Extracted Honey.—1st, G. Garbutt; 2nd, W. E. Richardson, Whitkirk, Leeds; 3rd, J. H. Oldfield, Rotherham.

Six 1-lb. Jars Granulated Honey.—1st, J. F. Stephenson, Harrogate; 2nd, G. Garbutt; 3rd, J. C. Hall, Howden.—(Communicated.)

NORTH NORFOLK B.K.A.

ANNUAL SHOW.

The sixteenth exhibition of honey, under the auspices of this association, was held in the Park, Melton Constable, on August 2, and attracted an entry of about eighty-five exhibits, or about 320 lb. of honey, as compared with 790 lb. last year. The judge was Dr. T. S. Elliot, of Southwell, Notts, and for the season the honey was very fair, but, as was to be expected, not up to last year's standard. The awards were:—

Twelve 1-lb. Sections Comb Honey.—1st, W. F. Fake; 2nd, W. J. Norman; 3rd, S. J. Mayer.

Twelve 1-lb. Jars Extracted Honey.—1st, H. W. Saunders; 2nd, W. J. Norman; 3rd, W. F. Fake.

Six 1-lb. Sections.—1st, S. Mayer; 2nd, J. Mayer; 3rd, W. Nobes.

Six 1-lb. Jars Honey.—1st, W. Nobes; 2nd, J. Mayer; 3rd, H. C. Holsey.

Three 1-lb. Jars and Three 1-lb. Sections.—2nd, W. Platten.

Beeswax.—2nd, H. W. Saunders; 3rd, S. J. Mayer.

Twelve 1-lb. Sections (open).—2nd, W. J. Norman; 3rd, W. F. Fake.

Twelve 1-lb. Jars Extracted (open).—2nd, W. J. Norman; 3rd, W. F. Fake.

Special Class—Single 1-lb. Jar (open).—1st, W. J. Cook; 2nd, H. W. Saunders; 3rd, W. F. Fake.

Single 1-lb. Section.—1st, W. J. Norman; 2nd, H. W. Saunders; 3rd, S. J. Mayer; 4th, J. Mayer.

Challenge Cup.—H. W. Saunders, Thetford.—(Communicated.)

Correspondence.

The Editor does not hold himself responsible for the opinions expressed by correspondents. No notice will be taken of anonymous communications, and correspondents are requested to write on one side of the paper only, and give their real names and addresses, not necessarily for publication, but as a guarantee of good faith. Illustrations should be drawn on separate pieces of paper. We do not undertake to return rejected communications.

AMONG THE BEES.

CHECKING ROBBING.

[7587.] In spring and autumn robbing booms are frequently looked for as a matter of course in many apiaries. This should not be, as in general the instinct can be suppressed before it leads to mischief. This is one of the cases where prevention is of more importance, and in every way more effective, than cure. If I enumerate a full dozen causes for rousing the excitement and encouraging the predatory spirit I may be doing something to help many beginners to prevent it or nip the disease in the bud.

Honey is often left lying about the apiary, thus affording bees a chance of stolen sweets. Syrup is spilled or left exposed when feeding is going on. Ventilators and cone-clearers are fitted so loosely as to allow bees readmittance. Hives should have no cracks or crevices, yet they often have. Weaklings and nuclei are generally left with two large entrances. The honey-house is frequently not quite bee-proof. Far too many weak, and sometimes queenless, lots of bees are kept dragging on a miserable existence. Untimely manipulations are often undertaken when prowlers are nosing about. Feeding at the wrong time works evil. Spring cleaning on a fine day gives robbers a start. Empty hives left open encourage the marauders, and simply invite their visits. Entrance slides fitting badly

encourage robbers and often invite disaster. Outside feeding leads to it.

The foregoing baker's dozen of causes leading to robbing may now be followed by as many preventives, checks, or cures; but it must be understood that several of them have to depend on the intelligence with which they are applied to guarantee success. (1) Have all your stocks equal and as strong as possible. I know this is theoretically easy of attainment, although practically there is often a hiatus somewhere. But the nearer you approach to this ideal the more certain you are to have no robbing. (2) Leave your strong stock with as wide an entrance as the hive allows if you have a mind, but reduce the opening in touch with the strength of the stock. (3) Join up all nuclei and weaklings before the honey harvest utterly fails, because immediately this happens prowlers go prospecting everywhere searching for sweets; and by sight, smell, and hearing they are quickly attracted to a centre where this source has been discovered by their sisters or neighbours. (4) Do not extract honey outside. In the height of the season that may be all right. With a honey-dearth it is quite wrong. Every crack and crevice in the honey-house should be made bee-proof. A swing-window to throw out any bees which may find an entrance by the door or be carried in by the full supers should be in every honey-house. (5) Have all hives bee-proof. Every joint should fit tight. I know some factory hives even are not perfect in this respect. It is right to have lifts and roofs easy, but they should have no play. (6) Notice that all cone-clearers, while they allow bees out, hinder their re-entrance. This at times is not the case. (7) Clear out all racks of sections by means of some system of clearance connected directly with the brood-nest. In this way no shaking has to take place. No honey is thrown about out of unsealed cells, and no prowlers are attracted to the temporarily exposed honey. (8) On the least signs of agitation use carbolic acid liberally. Hang some rags saturated with it above the entrance and on each side, and paint the flight-board with the exception of a space near the entrance with a weaker solution. (9) Remove the attacked stock to a temporary site fully two miles from the apiary, and keep it there for some weeks until the chillier weather of autumn confines the caterans to their own home. This, where possible, is the very best cure which can be recommended, and, as the attacked stock is generally weak and bees not over numerous, they bear confinement nicely while being transplanted to the new site. (10) Almost an equivalent of this is the American plan of carrying the attacked stock "down cellar," where they are kept

for some days until the attacking bees forget to revisit their stand. (11) Clustering the robbed stock keeps out the robbers, until they give the assault up as a bad job. (12) Exchanging the weak lot to the site of a strong one and substituting the other allays the robbing-fever. But here there is possibly a danger to either queen at times. (13) One of the very best preventives that can be given is to have all hives well provided with stores in autumn; enough to tide them right over the spring until early fruit bloom yields well, or even until white clover supplies nectar. (14) As an extra means of stopping robbing I may conclude with the latest plan given across the Atlantic:—When the attacked stock is removed place on its stand a similar hive provided with a *robber-trap*, affording the marauders easy access, but no means of exit. All these bees are now prisoners, and, as they generally come from one hive, these being all trapped effectually hinders any further attack. The weakling may then be restored to its former position, and the trapped robbers can be carried to an out apiary or otherwise disposed of. — D. M. M., Banff.

ARE BEES POSSESSED OF A HIGH ORDER OF INTELLIGENCE?

[7588.] No doubt many bee-keepers at one time or another, standing before an open hive, have longed to be able, if but for a very brief moment, to pierce the veil that separates us from the insect world, and look on life and being as it is to the bee. Although such a privilege can never come within our reach, yet from our own standpoint we are permitted to get near enough to be able to see that the bee is possessed of a very high order of intelligence indeed, and no doubt there are few bee-keepers who cannot call to mind instances of remarkable memory in these busy creatures similar to the one related below.

On one occasion, after changing my place of residence, my apiary was limited to one stock for the greater part of a year, which, though scarcely enough to satisfy the aspirations of a sanguine apiarian, enabled me to make many observations which I could not have done so safely with a greater number of stocks.

The climatic conditions of South Africa being entirely different from those prevailing at home, our system must vary accordingly. As we have about four months in the winter without any rainfall, bees are seldom confined to the hive for more than a few days at a time. There is usually a period of one or two months' cessation from brood-raising, when the queen takes her short but well-earned rest, in the months of May and

June. Now British bee-keepers must think, as they remember the damp quilts and leaky roofs of their own hives, which have often caused the loss of their best stocks in the long, dreary months of winter, that this country must be a bee-keepers' paradise, with not even a shower of rain to cause them an anxious thought. But the long drought has its corresponding drawbacks, and it takes the very best wood and workmanship in hives to withstand the influence of such dry weather.

During this dry period of the year a great quantity of water is carried into the hive by the bees, and the one hive already mentioned gave me a good opportunity of ascertaining how much a prosperous colony required at a time when brood had fairly started and no flowers were as yet in bloom to furnish the thinner food for the young larvae.

I found that on fine days the bees always took in over a pint of water daily with one exception, which it may be of interest to note. In order to determine how far the American-cloth quilt helped to lessen the labour of the water-carriers, I made several tests with it, and always found that when it was placed over the frames the amount of water carried in was less by half a pint, proving a great saving of labour to the bees. Later in the season, when flowers came into bloom, the quantity of water carried in decreased still more, as no doubt the nectar and the dew on the flowers supplied the deficiency.

Reverting to my remark on the faculty of memory in bees, here is the instance in question: One afternoon, instead of filling the feeder (an inverted bottle) with water, I filled it with syrup, just to see how long a colony would take to remove a pint of food in the open. In a moment or two a bee alighted and brought in the first load of syrup. In an incredibly short space of time the bees were pouring out of the hive almost like a swarm, and, contrary to what I expected, did not hover around in search of the newly-found stores, but flew direct to the house about thirty yards away, which they entered in great numbers. Now it happened that some time previously the making of marmalade was occupying the attention of the household, and incidentally of the bees also; but after this work was finished the bees soon discontinued their visits, and nothing else attracted them till the afternoon in question.

Being struck with the way in which they at once made for their last field of labour, I looked up the dates, and found that the marmalade had been made over six weeks previously, and nothing had attracted them during the intervening period. I think it shows in a remarkable manner how memory lives in the bee. A

week later the same experiment was repeated, and, though the bees flocked out in great numbers, only one or two visited the house. All seemed to think the water-bottle was this time the source of supply.

While our admiration for these wonderful insects may have a tendency to lead us too far in attributing to them qualities greater than they really possess, I think it may fairly be said that bees have a certain amount of reasoning power. This is seen in transferring. I have transferred combs both from boxes and odd-sized frames, and have very often found the bees busy removing the tapes two hours afterwards, yet never in one instance have I known them to touch a tape till they had first secured the combs. An examination showed that only on brood-combs was this feverish haste displayed; those containing honey or pollen were secured more leisurely. Now transferring is an event that could never occur in the natural order of bee-life, and this provision of making the combs secure cannot be prompted by instinct.

In the B.B.J. for April 8 (page 136) I was pleased to see a letter from a fellow-colonist pointing out the superiority of British over American hives. Let me remind him he is not alone in this part in holding this view. I, too, tried the American article, but a short season sufficed, as it should do with anyone who has ever worked with the British system. I was sorry Mr. Wilson did not give his full address, as, holding similar views, I should have liked to correspond with him.

Best wishes to all brother bee-keepers, and especially the contributors to the B.B.J., who give us freely of their store of knowledge.—H. MARTIN, Dannhauser, Natal.

CHLORINE AS A DISINFECTANT.

[7589.] I do not wish to take up your space and your readers' time by entering into a discussion with Mr. Newton and "L. E. S." on a subject that has no special interest for bee-keepers; but I will ask you to accord me a little patience while I explain to these two gentlemen what must, I think, have been patent to the majority of your readers.

Were I asked, in the course of conversation, whether any acid would react on gold I should state that a mixture of nitric and hydrochloric acids would do so. Yet if I failed to add that the reaction would only take place in the nascent state I do not think I could justly be accused of inaccuracy.

In the case under discussion your correspondents appear to think that I ought to have explained all the details of a

chemical reaction, and because, having a regard to the nature and object of your journal, I did not do so, they say I am inaccurate. Mr. Green's letter might well have led the inexperienced to suppose that, since bees are not gaseous bodies, they could safely be subjected to an unlimited dose of chlorine. My object was solely to deter them from acting on any such erroneous supposition, and I quite fail to see why I should be expected to qualify my statements anent chlorine as though I were writing for a scientific publication.

The interiors of my hives happen to be in a more or less permanent state of gloom, and therefore I did not consider it worth mentioning that chlorine will decompose water under the influence of light. Had I thought that many of your readers kept their bees in glass hives I should have modified my statement. Both your correspondents lay stress on this property of light, whence I conclude that their hives *are* built of glass.

Both letters appear to me to split hairs. Mr. Newton states that, under certain conditions, hydrogen has a greater affinity for chlorine than for oxygen. This is perfectly true. It is equally true that, under certain conditions, hydrogen will replace sodium in combination with chlorine; but if Mr. Newton would argue from this that hydrogen has a greater chemical affinity for chlorine than has sodium, his argument, from a chemist's point of view, would be false. Similarly, "L. E. S." objects to my statement that free oxygen, when offered to hydrochloric acid, will produce chlorine. Of what benefit to bee-keepers, I ask, would it have been had I explained exactly *how* the oxygen should be offered?

I repeat that the equation

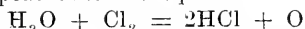

is normally impossible. It is quite beside the point to argue that light and time will render it possible, since the one is non-existent in most hives and the other (slow reaction) renders the resulting product practically valueless.—H. CAMPBELL, Cookham.

BEE-KEEPERS AND COUNTY ASSOCIATIONS.

[7590.] The correspondence in the B.B.J. (7583-4-5) is very interesting, but is not quite fair to the county associations, and "Beginner," in his desire to belittle them, has forgotten the many benefits that come from that source, and can only think of the failure in his own case upon which to base his adverse criticism. There are, I suppose, hundreds of men who are faithfully discharging the duties of bee-expert to county associations with little or no recompense.

and yet "Beginner" would, from the tone of his letter, condemn all associations because of the laxity of this one man. Here are a few of the benefits to be derived from joining an association, which should induce all beginners to become members. The minimum fee is generally 1s. or 2s. 6d., and for this the member can use the association's labels guaranteeing the purity of his honey, he can compete at the county shows free of entrance fee, he can attend all lectures of the association and will receive by post notification of such, he can by application to the secretary or to the despised bee-expert get the information he needs to make him a successful bee-keeper, and he will, if possible, receive at least one visit during the season from the association's expert. I say "if possible," because the bee-keeper himself sometimes makes it impossible by binding the expert down to a certain hour. I would advise all beginners to join their county association, but in doing so to remember that there are other members besides themselves, that the bee-expert is generally a busy man, that his duties are to inspect and advise, but not to take on lengthy manipulations, unless by special arrangement. When "Beginner" cycles four miles three times in succession to visit a bee-keeper (as I did), and then gets reported to his association by this same gentleman for inattention to duty, he will realise that bee-experts, like the bees, have their bad seasons, when instead of collecting honey they have to be content with the honey-dew of adverse criticism.—J. E. F., Elgin.

BEEES IN BURMAH.

[7591.] I have received a letter from the South Shan States, Burmah, the following extract from which may be of interest to B.B.J. readers.—H. RICHARDSON, Marlborough.

"I have seen three varieties of the honey-bee out here: 1. A large kind which hangs its comb from under a big branch. My men took about 10 lb. of honey from this variety the other day, the comb being three feet long. 2. A bee of the same size as our English ones, which always makes its nest in a hole with a small entrance. 3. A very small bee which hangs its comb from bushes. I much prefer the honey produced by this small bee; it is more substantial and better flavoured than that of the two former kinds mentioned.

"The poison of these Burmah bees must be less virulent than that of the English variety, for the effect of a sting upon me is very slight, while after being stung by one of the bees at home I used to swell up like a pudding."

THE SEASON IN NORTHUMBERLAND.

[7592.] Can you kindly tell me what the enclosed species of bee are? They are very numerous at present, and I first noticed them about a week ago. They appear to work on golden rod and marguerites, but I have not noticed any on "Chapman's honey-plant," which is covered with my bees.

This has been a most heartbreaking season up here. I had seventy sections, out of which only three were sufficiently sealed to show, and with these the colour was against them, there only being one class (light) at the local show, though they were "commended" at Kelso.

The heather harvest, I fear, will be still worse. Yesterday, with two prominent local bee-keepers, I went to Langlee Ford to see if we had any sections for a show to-morrow. We examined forty-four hives, and found three sealed sections! The cold and rain have played havoc during the last ten days, racks that were then crowded with bees being almost deserted. Even if we should get a fine spell now, the hives are not half the strength they were.—(CAPT.) F. SITWELL, Northumberland, August 27.

[Both the insects belong to the *Diptera* or flies, having only two wings. One is *Anthrax morio*, and is parasitic in the nests of *Andrenidæ*; and the other *Volucella zonaria*, which attacks wasps'-nests and, curiously enough, wears a similar livery, so that it is sometimes mistaken for an Italian bee.—Ed.]

CAPPINGS OF COMB.

BY L. S. CRAWSHAW, NORTON, MALTON.

All-jar (and near) and O-Mecca (page 296).—Do the enthusiastic advocates of a bee-keeper's shrine realise what a pilgrimage the journey to town means to a poor bee-keeper? Much as we should like to meet and discuss, we are not all able to afford it. Nor would such journeys generally repay the outlay. Possibly when "Alpha" has become "Beta" (symbol of scientific advance in the Bee-world of letters), or has still further rung his triumphal way up the ladder of bee-knowledge—a long journey, in the initial steps of which so much must appear Greek, and upon which I must confess that I have only reached the doubtful distinction of "Kappa"—he will find that it is not every old bee-keeper who is anxious to discuss, but that it is mostly the beginners who are eager for information. And these latter can usually obtain help near at hand; well, nearer than London, and, failing that, most of their questions can be satisfactorily covered by an outlay of one shilling and sixpence!

Queens Deposed in Spring (page 302).—“D. M. M.” does not say anything as to preparations for supersedure. In the absence of these, I doubt if the bees would “depose” a queen, even if she were laying no better than a barn-door fowl in the sitting season! Rather do I think that the bees might remain fondly loyal until too late to rear a successor from the last of her eggs. “D. M. M.’s” theory as to the cause of their debility—the year 1907—sounds most plausible. Has any other reader, in other than a heather district, suffered in the same way?

Introducing (page 302).—This is a great scheme for giving the new queen something of the old scent. But “D. M. M.” does not tell us, in plan No. 1, what to do with the attendant bees; and why place the new queen also over the top bars? Would the work be simplified as a modification of the “Simmins” plan? That is, cage the old queen and workers in a matchbox, and later use the box for the solitary confinement of the new queen.

Chlorine for F.B. (page 303).—No: so far as my knowledge goes, I cannot agree, if that is Mr. Green’s meaning, that disease germs are only gaseous. For instance, we are able to fix and stain them for inspection. I am not aware that this has ever been done with particles of any gas. Again, spores have a protective envelope which certainly cannot be gaseous. Minute as these germs are, they are yet not so minute as gas particles. But it is not quite clear what Mr. Green means by the term, for he refers to carbon as a gas! Surely this is a mistake.

As to spontaneous generation we know that F.B. is infectious, and its reproductive process has been observed in division of the bacillus; whilst the freedom of large areas, where favourable disease conditions must exist, justifies the conclusion that F.B. does not, easily at any rate, generate spontaneously. At the same time, its death or cure by means of a gas is perfectly reasonable, and chlorine, well known as a disinfectant, may happen to prove specially valuable. Experiment is, of course, the test, and if Mr. Green is familiar with the process he should make disease cultures, and subject them to variously dilute mixtures of the gas. The experience thus gained may then be applied to actual hive conditions. The most dilute effective mixtures must be used to prevent destruction of bee-life also. But without special knowledge it would be well to risk no spread of the disease by crude experiments.

Swarms and F.B. (page 304).—I am very glad to have a friendly difference with Mr. Soal, but he should read again

my note on page 298, and this time carefully, when he will see that he has inadvertently distorted it. There I distinctly discuss the possibility of the carriage of germs. My contention is rather that the stress of comb-building disposes either of the disease germs or of the diseased bees. Mr. Soal airily alludes to “personal experience” to the contrary, but does not give details. It is a little difficult to see what satisfactory proof he can give. In other words, how does he *know* that a swarm took disease with it and did not contract it?

Two Queens with Swarm (page 305).—Probably swarming was deferred a day or two by weather, and the first-hatched virgin went out in the excitement of the swarm. This would be the quick-footed queen which ran into the hive first. She would not, of course, lay for some days, and in the meantime she perhaps polished off the “Golden” virgin. At least, “W. F. I.” does not tell us what became of the latter.

Late Mating (page 306).—The cause was no doubt bad weather, or perhaps a dearth of drones, and the result a drone-breeder. Is it possible that this is one of Nature’s ways of providing against a recurrence? That is to say, by provision of the necessary drones. A wild suggestion, no doubt, but containing a trifle of food for thought. By the way, one may be over-hasty in deciding that a queen is a drone-breeder just because she happens to lay a few drone-eggs at first. It is not without precedent that such a queen may prove fertile. We want more evidence about these matters, and if the fortunate possessors of such queens can afford it, we shall owe them a debt of gratitude if they refrain from killing them at once. Carefully collected data and dates may greatly add to our knowledge. I am willing to help, whenever convenient, by exchanging a good queen for one of these freaks for the purpose of observation.

The Queen’s Holiday (page 306).—Mr. Pearman’s quaint suggestion of a moorland holiday is likely to prove a “serious business” for the mother-bee. Her “holiday” will be, like that of many other mothers with large families, as full of hard work as ever. In the words, slightly altered, of the nursery rhyme:

There is an old woman who lives in a hive,
She has so many children that it’s strange she’s alive!

Though her business in life is the laying of eggs,
With a “rest” at the moor she’ll be run off her legs.
Yes, and then they wonder why so many queens are superseded at the heather.
Holiday indeed!

Successful Apiculture (page 307).—“Never leave closed brood-cells in a

comb." Of course, WE understand what Mr. Gray is driving at, but if some poor novice takes it literally his brood may get a bad cold in the head! The conversational style of these articles reminds one of Sandford and Merton, or of Doolittle at his best, and is so attractive that I am foolishly minded to try a fall at it myself. If I fail to get over the style, or the manipulations are not such as the expert would approve, that will at least not be his fault. So here goes!

Finding the Queen and Feeding Bees (page 307).—"The queen is the most important bee in the hive. Let us look for her together. Do you know how to find her quickly?"

"No."

"I will tell you. Do you see those large bees? They are drones. Watch their actions. See! They point like setters to No. 7 frame. The queen is there. Withdraw the frame carefully. Ah, you have crushed the queen. Hand me the repair outfit you will find in the queen-breeder's vade-mecum."

"Here it is."

"Rub a little of the solution on her abdomen, gently chafing her long legs. See! She recovers. Run her back into the hive, and close it up for the day. Ah, there is just time to feed that starving stock before hurrying homeward to our well-earned meal. Hand me those fat combs of honey you left out of No. 13 last week."

"They are empty."

"That is the work of robber-bees, who have discovered them leaning against yonder tree. Reach me the comparatively-thick syrup. We will pour it over the frames."

"Will it not drown the bees?"

"It will not hurt them, and they will notice its presence the sooner. Yes; they will clean the floorboard—it is an exception to the rule I gave you. Slip the empty combs into that nucleus for the queen to fill with eggs. Now for home before the bees see us."—L. S. CRAWSHAW, C. (of) C. Lecturer.

PRESS CUTTING.

BEE-FARMING IN SOUTH AUSTRALIA.

The keeping of bees is generally carried on in conjunction with other pursuits. With a suitable climate and natural flora it is surprising that the industry does not increase with greater rapidity. Information respecting this pursuit was first obtained in 1891, when it was found that 500 tons were gathered. The year 1900 was very favourable, the returns for that year showing 26,700 hives and a production of 763 tons of honey. The production for the last five years has been as follows: 315,765 lb., 1,197,737 lb., 1,193,421 lb.,

1,090,489 lb., 953,395 lb. The returns for the year 1907 show 18,529 productive hives and 5,101 unproductive—a total of 23,630, in comparison with 24,107 in the previous year; 953,395 lb. of honey and 12,854 lb. of beeswax were gathered.—*British Trades Journal*.

Bee Shows to Come.

September 4, at Bramhall, Stockport.—In connection with Bramhall Horticultural Show. Honey Section under management of C.B.K.A. Entries closed.

September 4, at Crayford, Kent.—Annual Honey Show. Open Classes. Sections and Jars (Light and Dark), 6 of each. Entrance fee 1s. Schedules from J. M. Bates, Hon. Sec., Warren Road, Bexley Heath.

September 7 and 8, at Derby.—In connection with the show of the Derbyshire Agricultural Society at Osterley Park, Derby. Honey Department under the direction of the Derbyshire B.K.A. Entries closed.

September 13, at Conway, N. Wales.—Annual Honey Show, in connection with the Conway Honey Fair. Open and local classes. Schedules from J. Hughes, Town Hall, Conway. Entries close September 6.

September 16, at Castle Douglas.—In connection with Dairy Produce Show, the annual show of the South of Scotland Bee-keepers' Association. Open Classes for three 1-lb. Jars (20s., 10s., and 5s.); three Sections (20s., 10s., and 5s.); entry 2s. One Jar (5s., 3s., and 2s.); one Section (5s., 3s., and 2s.), entry free, but exhibits forfeited unless otherwise arranged. Beeswax (5s., 3s., and 2s.); entry 6d. Thirteen Classes Confined to Members. Numerous prizes, including two Challenge Cups and gold and silver medals. Schedules from Q. Aird, Hardgate School House, Dalbeattie, N.B. Entries close September 4.

September 16, 17, and 18, at Crystal Palace.—Surrey B.K.A. Annual Exhibition of Bees, Honey, Wax, Appliances, &c. Entries closed.

September 18 to 25, at the Agricultural Hall, London.—Honey Show in connection with the Seventeenth Annual Exhibition and Market of the Grocery and Kindred Trades. Liberal prizes. Open to all British Bee-keepers. Schedules from H. S. Rogers, Secretary, Exhibition Offices, Palmerston House, Old Broad Street, London, E.C. (See advt., p. iv.).

September 22, at Altrincham.—Honey Show, in connection with the Altrincham Agricultural Show, the largest one-day show in the Kingdom. Classes open to United Kingdom. Classes for Trophy of Honey, for Best Hive, Observatory Hive with Bees and Queen, twelve Jars of Extracted Honey. Classes open to County of Chester, for Run and Section Honey, Wax, &c. Special Classes for Cottagers, and Special Classes for Society's District. Good prizes, low entrance fees. Schedules from Mr. J. Herbert Hall, 2, Dunham Road, Altrincham. Entries close September 4.

October 5 to 8, at the Agricultural Hall, London.—Show of Honey and Bee Produce in connection with the British Dairy Farmers' Association. Numerous and liberal prizes for Honey, &c. Schedules from Mr. Wm. C. Young, Secretary, 12, Hanover Square, London, W. Entries close September 6.

Queries and Replies.

[3967.] "*Combination*" *Hive and Nucleus*.—I am thinking of installing in my apiary a number of hives made on the "*Combination*" principle, capable of holding sixteen frames, and having an entrance at both ends: i.e., at the back and the front. My idea is to have the stock-hive on ten frames in the front and a nucleus-hive at the back on six

frames, or less, as the case may be. Of course the stock-hive and the nucleus would be divided by a dummy. The advantage I claim for a hive of this description is that in the spring a nucleus can be made from the parent hive and placed at the back, and then made to produce a young queen in the usual way by providing a ripe queen-cell. Thus we shall have the old queen still in the stock-hive and a laying queen in the nucleus, ready to unite to the parent stock whenever necessary. Moreover, if the nucleus is made up early in the spring and it is not necessary to unite the nucleus until after the honey-flow, the growing population in the nucleus can be united to the parent stock, say, every month, thereby proving a great help to the stock-hive just at the right time, viz., during the honey-flow. After the honey-flow is over the old queen is removed and the nucleus united to the parent stock, thus providing a young laying queen, besides additional strength. I have never given such a hive a practical test, but in theory it seems to be a rather good idea, as it facilitates queen-rearing and does away with the necessity of having a number of nucleus-hives for queen-rearing. Knowing you to be an essentially practical man, I should like you, in the light of your experience, to tell me what you consider are the drawbacks to such a hive. As far as I can see it has no disadvantages, but many advantages. Your valuable comments on the above will, therefore, be esteemed by—ROBIN HOOD, Bristol.

REPLY.—There is no objection to adopting the plan you propose, which has already been in use by some bee-keepers for the last twenty-five years. You will find such a hive illustrated and described on page 61 of Cheshire's "Bees and Bee-keeping," published in 1888. In his hive he has the main entrance at one end and the entrance to nucleus at the side of the farthest end, so that the manipulator can stand behind the hive, the bees from the main colony flying from him as they leave the hive by the entrance, while those from the nucleus fly out on the right, and do not trouble him.

Notices to Correspondents.

S. C. P. (Gloucester).—*Beginning Bee-keeping.*—As you say you have not kept bees and know nothing about bee-keeping, your best plan is to get the "Guide Book" and study it during the winter months. You can then begin with a swarm in the spring, which is the best time for commencing. In the book you will find minute instructions how to prepare a hive for bees and all about feeding at different seasons, and when to feed. You could only get driven bees now to put into your hive, and as you have had no experience, you would most likely lose them during the winter. We therefore advise you to make the start in spring.

E. G. G. (Hinckley).—*Changing Hives.*—1. You can put the bees into a new hive at any time during the working season. We make a rule of putting our bees into clean hives in the autumn, when we prepare them for winter, and again in the spring, when a thorough examination is made. 2. The honey sample is a thick, slightly reddish dark honey, with a strong flavour of almonds. No trace of honey-dew. Quite a palatable honey.

SAN PABLO (Greenhithe).—*Bee-farming.*—1. Forty stocks would be sufficient in one apiary, and are as many as can be profitably managed in one place, although in some localities as many as a hundred have been placed, but the returns are proportionately smaller. 2. Common black bees. 3. Swarms as early in the summer as possible; see page 145 of "Guide Book." 4. It depends entirely upon the weather, pasturage, the strength of the colonies, and the ability of the bee-keeper. Under favourable conditions from sixty

to eighty pounds. 5. The "Guide Book" gives all the necessary information for successful bee-keeping. You would also find "Roots' A B C" useful for your purpose. 6. You need not cut down the red clover, as bees will not visit it while sainfoin is in bloom.

LIGHT (Consett, Durham).—*Breed of Bees.*—Hybrids, Italian and black.

R. E. T. (Llandudno).—*Dead Undeveloped Bees.*—The three bees have not been properly nourished, as they are not fully developed, and probably this is the cause of their death. See if the colony is sufficiently provided with honey and pollen.

F. T. CHESWORTH (Staffordshire).—*Fossil Coal.*—The fossil sent is an imprint of a *Lepidodendron*, frequently found in coal. The earliest appearance of the bee (*Apis Adamitica*) is in the Tertiary formation (very much later than the Carboniferous), in which also honey-plants, as well as wasps, first appear.

C. L. F. (Shorlands).—*Dwindling Colony.*—The queen sent is not an old one, but has a dent in one of the abdominal rings, showing that she has been injured. She has also been roughly handled by the bees, as she has lost both her hind feet and the wings are torn.

F. V. W. (Gloucester).—*Pure Cane-sugar.*—1. We doubt very much if you can get pure cane lump sugar at 2d. a pound, as it costs 2½d. purchasing it by the hundredweight. Unless they are giving it away at less than cost price, we should suspect it to be beet sugar. 2. You have put in more bees than were necessary, but they should make a strong stock if liberally fed.

A. P. W. (Sussex).—*Uniting Driven Bees.*—The safest way is to drive the bees into separate skeps, and unite by dusting with flour both lots thoroughly, throwing them out on to a sheet and allowing them to run into the live together.

J. W. (Broughty Ferry).—*Winter Stores.*—1. There is no inconsistency in the two passages alluded to. Rapid feeding in September ensures the sealing of stores before the approach of cold weather, but, of course, it is impossible to have every cell sealed, and the bees use the unsealed honey first, usually consuming the small quantity there may be present before they are confined to the hive for any length of time. Unsealed stores kept in the hive through the winter would cause dysentery, and to avoid the possibility of this rapid feeding is resorted to. 2. A frame one foot square would represent one superficial foot. On page 113 of "Guide Book" it is stated how the bee-keeper may judge the proper quantity to leave. 3. Extract the honey from the unfinished sections, and, after they have been cleaned by the bees, keep them for starting with next season.

J. N. (Stratton-on-Fosse).—*Transferring Bees from One Frame-hive to Another.*—Place the frame-hive into which you wish to put the bees on the stand of old stock, moving the latter to one side. Then take out each frame from the old hive and shake the bees off the combs into the new hive, as directed on page 102 of "Guide Book." Look out for the queen and make sure of getting her into the hive. The bees may also be brushed off with a light dusting-brush, if the combs will not bear shaking. It is as well to place a lift on the hive, as shown on page 103, as it prevents bees running over on to the outside of the hive. As the robbing season has set in, the transfer should be made late in the afternoon, when bees have ceased flying, as the manipulation is likely to induce robbing.

C. B. C. (Plymouth).—*B.B.K.A. Examinations.*—The books recommended by the B.B.K.A. are "Modern Bee-keeping," Cowan's "British Bee-keeper's Guide Book," Cowan's "Honey-bee," and Roots' "A B C of Bee-culture." If you apply to the secretary, Mr. E. H. Young, 12, Hanover Square, London, W., he will send you a

prospectus, giving full particulars respecting the examinations. For first-class certificate candidates are required to show a satisfactory acquaintance with the best literature on bees and bee-keeping.

E. P. (Bexley Heath).—*Section Honey Dark*.—1. Putting soot on the ground has nothing to do with the colour of your honey, which appears to have been gathered from privet and limes, as it has a flavour and aroma of both. It is very thin and contains honey-dew, which makes it nearly black. 2. No doubt the dead bees which you found in front of your hive have been killed in fighting.

LOWER WARD (Renfrewshire).—*Bee-keeping in South Africa*.—The bee-keeping industry in South Africa is a progressive one, and lately a South African Bee-keepers' Association has been formed, which will give it a further impetus. We cannot say what opening there is for employment in any of the apiaries, but if you wrote to the secretary, Mr. G. S. Oettlé, C.S.A.R. Headquarters, Johannesburg, he would be able to give you more information. Mr. H. L. Attridge, Stickland Siding, Bellville, Cape Colony, would be able to help you with regard to that colony, being apicultural adviser to the Department of Agriculture. Mr. W. C. Mitchell, Secretary of the Natal B.K.A., Government Farm, Cedera, Natal, could give you information respecting Natal as an opening. We do not know which of the Colonies would best suit your health, but if you will let us know we can no doubt give you names of bee-keepers from whom you could get the information you desire.

WEEKLY SUBSCRIBER (Polegate).—*Re-queening Hive*.—If you left the bees alone they would settle matters, as no doubt the young queen you saw was intended to replace the old one. The young queen is probably not yet fertilised, and you would save time by re-queening with the one which you have sent for.

J. H. TOWN (Hull).—*Putting Hive on Eke*.—The best time is the beginning of October, although you can do it now, provided you take proper precautions to prevent robbing from being started.

ROSWEAR (Cornwall).—The heath is *Erica cinerea*, or bell-heather, and though bees do obtain honey from it, the quality is not very good, being thinner than and of inferior flavour to that gathered from ling (*Calluna vulgaris*). A great deal of dark honey has been gathered this season, but most of it is of very poor quality.

Honey Samples.

FLINTS (Ellesmere).—Nearly black honey, with a slight flavour of limes. The honey-dew, which is the main cause of the dark colour, has spoiled it as a table-honey, though it would not harm human beings if eaten. It is not suitable winter food for bees.

J. HOLMAN (Devonport).—Fairly good medium-coloured honey, gathered from mixed sources. It is rather lacking in consistency.

H. S. O. (Barton).—Honey is of poor quality, from lime and privet mainly. It is also thin, and contains a slight trace of honey-dew. Bees are Italian hybrids.

F. P. H. (Ware).—Both samples are gathered principally from limes. Colour is good, consistency fair, but neither contains honey-dew. The chance of an award would depend on what is staged in competition with them.

F. F. B. (Bowdon).—Honey is thin and dark, of very poor quality. The unpleasant taste is caused by the admixture of honey-dew which it contains. It is not harmful to use as food, but is not very palatable.

Suspected Combs.

B. L. (Brockenhurst).—The comb shows the presence of foul brood and sour brood. It is a

recent outbreak, as the disease is not very far advanced. Treatment is the same as for ordinary foul brood; but full particulars of this form of disease are given in "Guide Book," page 183.

*** Several important letters, &c., are in type, but held over from pressure on our space.*

Special Prepaid Advertisements.

Twelve words and under, Sixpence; for every additional Three words or under, One Penny.

WANTED, Cottage, with 1 or 2 acres of land, after Christmas, at low rental.—"BETA," c/o BEE JOURNAL Office.

FINEST ENGLISH HONEY, 17s. 6d. per 28 lb. tin; sample 2d. — DUTTON, Terling, Essex. t 1

HEALTHY DRIVEN BEES AT ONCE, in large or small quantities. What offers?—Address, EXPERT, c/o BEE JOURNAL Office.

WANTED, a "Ford-Wells" or "Wells" Hive, in good condition.—Particulars, 175, High-street, Guildford. t 85

CARNIOLAN BLACK CROSS, prolific young Queens, 4s. 6d.; Bees are gentle and excellent honey-gatherers.—J. GEARY, Barwell, Hinckley. t 84

FOR SALE, Honey, in 1 lb. screw cap jars, 7s. per doz., 60s. per cwt. Sample, 3d.—RACEY, "Franklin," Emneth, Wisbech. t 82

BEES, on 10 Frames, two Supers, 25s., or exchange Honey.—FRASER, Rheda-terrace, Cleator Moor. t 81

20TH SEASON.—Healthy Driven Bees, with young fertile Queens, at 1s. 3d. lb., in not less than 4-lb. lots; boxes returnable, or charged for; healthy fertile Queens, in introducing cages, 2s. each. All orders in rotation.—R. BROWN AND SON, Flora Apiaries, Somersham, Hunts. t 80

WANTED, $\frac{1}{2}$ cwt. Light Honey, in bulk, and 2 doz. Sections.—Sample and lowest price on rail to W. BRANSTON, Kinnerley, near Hereford. t 79

FOR SALE, strong Stocks Bees. What offers? —THOMAS, Herbrandston Rectory, Milford Haven. t 78

HAVING NO ROOM TO STORE, MUST CLEAR 100 Draw-out Sections, clean and perfect. No reasonable offer refused. —MULLIS, Egerton, Kent.

"ALNWICK" FEEDER, suitable for feeding Driven Bees. Price 6d. each; postage of one costs 3d., two 4d., six 6d., doz. 10d.—J. BALMBRA, East-parade, Alnyick. t 76

STRONG STOCKS, in Skeps, plenty natural Stores, 12s. 6d., 13s. 6d.; Driven Bees, 5s., 6s. per lot, with Fertile Queen. — W. WOODS, Normandy, Guildford. t 75

6 PRIME SKEPS, with young Queens, 12s. each, or offers for the lot.—W. H. SMITH, Smitenwood, Offord Cluny, Huntingdon. t 74

NOTE.—You must have our Extractors, "Rymer" Press, Screw Wax Extractor, Gray's Uncapping Tray, &c.—MEADOWS, Syston.

WANTED, to Rent or Purchase, House, brick built, 6 or 7 large rooms, must stand high, southerly aspect, not on main road, with 2 acres land, in good honey district.—Full particulars, URGENT, c/o BEE JOURNAL. t 62

SEVERAL STOCKS, on 8 Frames, 18s.; Spare Queens, 2s. 6d.; Extracted Honey, 28 lb. tins, 15s.; few lots Driven Bees, 5s.; packages returnable.—BOGGIS, Geldeston, Beccles. t 64

70 DRAWN-OUT SHALLOW FRAMES, 7d.; ditto Sections, 2s. 6d. dozen, healthy. — ASHKENEZIE, 1, Ulrome, Driffeld. t 77

BARGAIN.—Grand Stock "Sladen's Goldens," well stored, and accessories, good hive, 25s.—WAKERELL, 21, Mansfield-road, Croydon. t 87

Editorial, Notices, &c.

REVIEWS OF FOREIGN BEE-JOURNALS.

By "Nemo."

Plurality of Queens in a Hive.—On this subject, which has recently received a good deal of attention, M. Noblecourt says, in *L'Abeille de l'Aisne*, that in order to introduce several queens one must first have them on hand, for he does not think bee-keepers would care to pay six or seven francs each for the purpose of introducing them into a hive in which there is already a laying queen. They must, therefore, be reared, which cannot be done earlier than May, laying queens being ready for introduction about June 10. What would be the use of such a large number of eggs, seeing that the workers produced would not be foragers until July 20 to 25, when the great honey-flow had ceased? He further says that a good queen is amply sufficient to produce a strong population ready for the June harvest, and frequently the hives are so full of bees in August that he defers examining them thoroughly until later. He points out that Mr. Alexander lived in a district where the only harvest was from buckwheat, produced towards the middle or end of summer; it was therefore not astonishing that his method may have been more useful to him than to us. The only way, M. Noblecourt says, to have large harvests is to replace all queens towards the end of July by young ones raised towards the end of June or in July. Queens less than a year old lay very few drone-eggs, hardly swarm, and give the maximum of returns.

Do Bees Hear?—Mme. A. Perroteau describes in *L'Apiculteur* a case which tends to confirm the fact that bees are capable of hearing sounds at a distance. Having last October found three death's-head moths in a hive, she set herself carefully to watch, and every evening she closed the entrance, having on several occasions heard the cry of these moths in the vicinity. On October 30 she forgot to close the entrance, but was reminded of it by the "ery" of a death's-head moth, which she had disturbed in gathering a bunch of asparagus. His cries indicated that he was making for the hive, which was only about one hundred yards away. She went towards the hive, and arrived there before the cries had ceased. The bees were in a great state of agitation at the entrance of the hive, those inside making a buzzing noise. The moth had settled on a laurel bush close by, and Mme. Perroteau threw a handful of earth at it, which caused the moth to fly away, still uttering its shrill cry. She

then waited and saw all the bees enter the hive, when she closed the entrance. After a few seconds, when the cries of the moth were no longer heard, the bees in the hive became quiet, and when she returned to look at them half an hour later they did not stir at her approach. The conclusion deduced from this observation, made when perfect calm reigned, so that the flight of the moth could easily be heard, was that the bees had heard the cry of their enemy, and were preparing to guard their entrance against a possible invasion.

Propolis Varnish.—We are told in the *Union Apicole* that a good varnish may be made from propolis. To obtain it, frames and other parts of the hive covered with it should be scraped. If this is done during cold weather, the propolis will be found in a powdery condition. It is then collected and boiled in water. The wax and other impurities will float on the surface, and can be removed. The refined propolis remains at the bottom of the vessel, and is removed before the water becomes cold, when it can easily be kneaded into a ball. At a low temperature this can be reduced to powder, which is put into a glass bottle, rectified spirits of wine poured in, and the whole well shaken. If the solution is not complete, a little coarse sand is put in and the bottle shaken again, when it will be found that the whole of the propolis has dissolved. This produces a varnish or lacquer which can be used for furniture, instruments, hives, &c. It can be made of any strength, and several coats can be applied if one is not found sufficient. By adding powdered pigments different colours can be produced. If the article covered with it is slightly warmed, a fine polish may be obtained. We would here point out that the beautiful varnish seen on Russian lacquered wooden bowls and spoons is made with propolis.

Diseases of Bees.—Dr. Zander, Professor at the University of Erlangen, Bavaria, has published in the *Deutsche Imker aus Böhmen* the result of his investigations of diseases of bees. He, like Dr. Maassen, recognises three diseases that affect the brood and which he finds due to three different microbes. He gives them a slightly altered name, and calls them (1) rare foul brood, (2) common foul brood, and (3) sour brood.

1. In Bavaria Dr. Zander finds the rare foul brood is caused by *Bacillus alvei*. This grows on various media, and has a foul smell similar to bad cheese or sweat; the foul brood mass is pasty and can be drawn out in short threads.

2. Common foul brood, which is much more prevalent, is caused by *Bacillus Brandenburgensis*. This grows on bouil-

lon made of bee-larvæ or brains, and the cultures emit a hardly perceptible odour of glue. The rotten mass is gelatinous, and can also be drawn out in threads. Both the above bacilli form spores.

3. Sour brood is caused by *Streptococcus apis*. This differs from the others in that it does not form spores. It, however, is of easy culture, and produces an acid odour resembling that of vinegar or lactic acid. The rotten mass is pasty, but does not draw out in threads.

He agrees with Dr. Maassen, and finds that in the common form the larvæ are attacked after the cells are sealed, but in the rare form the larvæ nearly always die before sealing. The diseased larvæ lose their pearly-whiteness and the skin becomes flabby, acquiring a yellow tinge. On endeavouring to remove it the larva goes to pieces. In the end it turns to a brown colour. Only in sour brood can the larva be extracted from the cells whole. All these forms of disease are contagious, and may be found in the same hive at the same time, sometimes two of them combined in the same cell.

WARWICKSHIRE B.K.A.

ANNUAL SHOW.

The annual exhibition of the above association was held at Stratford-on-Avon, in conjunction with the Warwickshire Agricultural Society, on August 25 and 26. The 1909 season has been very poor for bees and bee-keepers alike, and as a consequence the show suffered in comparison with that held at Solihull last year. Dull, cloudy, showery weather has multiplied the work of the bees, and given the owners less honey, and that inferior in quality. Honey-dew has also been prevalent, and during the past year a good many Warwickshire samples have been depreciated by it, but in few cases has it been present in sufficient quantities to spoil the honey entirely. Mr. W. Herrod acted as judge, and the Mayoress of Stratford (Mrs. Priest) handed the prizes to the successful exhibitors, which were awarded as follows:—

OPEN CLASSES.

Bees in Observatory-hives (Stock of Ligurians or other foreign bees).—1st, E. H. Taylor, of Welwyn.

Stock of English Bees.—1st, G. Franklin, Burton Green, Kenilworth; 2nd, W. F. Wiemann, Erdington.

Honey from One Apiary.—1st and silver medal, Miss Roberta Haine, Little Welton, Shipston-on-Stour.

Three Shallow Frames.—1st, A. L. Robinson, Tanworth-in-Arden; 2nd, W. Duffin, Bilton.

Twenty-four 1-lb. Sections.—1st, Miss Roberta Haine; 2nd, W. Churchill,

Edgbaston; 3rd, A. D. Melson, Hither Brome, Lapworth; 4th, W. J. Alliband, Claverdon

Twelve 1-lb. Jars Extracted Honey.—1st, A. L. Robinson; 2nd, Mrs. Craven Jones, Shustoke; 3rd, Miss Edith Poole.

Extracted Honey.—1st and bronze medal, W. G. Harris.

COTTAGERS' CLASSES (CONFINED TO MEMBERS).

Honey from One Apiary.—1st, J. Tandy, Barston.

Twenty-four 1-lb. Sections.—1st, W. Turner, Kingswood; 2nd, J. Corbett, Knowle.

Twelve 1-lb. Sections.—1st, J. Lees, Wootton Wawen; 2nd, J. Arthars, Studley.

Twenty-four 1-lb. Jars Extracted Honey.—1st, J. Seeney, Stratford-on-Avon; 2nd, J. Tandy; 3rd, W. Turner; 4th, W. Ayres, Knowle.

Twelve 1-lb. Jars Extracted Honey.—1st, J. Seeney; 2nd, J. Arthars; 3rd, J. Lees.

Six Sections and Six Jars Extracted Honey.—1st, J. Grimley, Erdington; 2nd, J. Lees; 3rd, J. Arthars.

Collection of Hives and Appliances.—1st, E. H. Taylor.

Beeswax.—1st, J. Lees; 2nd, A. L. Robinson; 3rd, E. Palmer, Kettering.

Mr. G. Franklin gave lectures and practical demonstrations on bee-management during the show.—(Communicated.)

WORCESTERSHIRE BEE-KEEPERS' ASSOCIATION.

ANNUAL SHOW.

The annual show of the above association was held at Madresfield on August 5 in connection with the Madresfield Agricultural Show. The number of entries fell considerably short of last year, owing to the unfavourable weather in July and the prevalence of honey-dew, one would-be exhibitor saying that his entire crop was spoiled by it. Mr. Jordan, of Bristol, was appointed judge by the B.B.K.A., and made the following awards:—

Display of Bee-products.—1st, G. Richings; 2nd, A. R. Moreton.

Twelve 1-lb. Sections.—1st (silver medal), J. Toombs; 2nd (bronze medal), G. Richings; 3rd (certificate), F. C. Bleakman.

Six 1-lb. Sections.—1st, J. Toombs; 2nd, J. Price; 3rd, W. J. Woolley.

Twelve 1-lb. Jars Extracted Honey.—1st, J. Toombs; 2nd, A. R. Moreton; 3rd, G. Richings.

Six 1-lb. Jars Light or Medium Honey.—1st, J. Toombs; 2nd, J. Price; 3rd, A. R. Moreton.

Six Jars Dark Honey.—1st, A. R. Moreton; 2nd, J. Toombs; 3rd, W. J. Woolley.

Shallow Frame.—1st, J. Toombs; 2nd, J. L. Brierley; 3rd, G. Richings.

Bee-wax.—1st, J. Toombs; 2nd, J. Price; 3rd, G. Richings.—GEORGE RICHINGS, Assistant Secretary.

Correspondence.

The Editor does not hold himself responsible for the opinions expressed by correspondents. No notice will be taken of anonymous communications, and correspondents are requested to write on one side of the paper only, and give their real names and addresses, not necessarily for publication, but as a guarantee of good faith. Illustrations should be drawn on separate pieces of paper. We do not undertake to return rejected communications.

NOTES BY THE WAY.

[7593.] Having secured our crop of honey for 1909, we must lose no time in getting our stocks into good order for the coming year. Our hopes and aims are ever in the future, and as soon as one harvest is garnered we have to look forward and begin preparing for the succeeding season. Although our "takes" of honey may not have been large, it is no fault of the bees. On every fine day during the summer there was ample proof of the eagerness of the industrious little creatures to work their hardest during the sunny hours, and often bees would arrive home with their last load after the sun had sunk below the horizon.

We must now without delay see that stocks are put into condition both as regards young queens and abundant stores. Having attended to the queen, see that the brood-combs contain a sufficient quantity of food to carry the stock through the winter; in fact, up till May or June, according to the district in which the apiary is situated. Here in Wessex they require enough to last till June; at least, practical experience extending some three decades proves that those stocks which go into winter quarters with a good supply of food come out strongest in spring, build up ready for the first honey-flow, and give the best results year after year. Twenty years ago bee-keepers relied more on spring feeding for building up stocks, but experience has proved that colonies well provisioned and headed by a young queen of a good strain are the ones that give a good report of themselves, even in a poor season such as that just over. The best strong stocks have stored three times as much honey as the more backward ones, and what is also of importance, during the fine weather in early August they sealed over the last rack of sections and stored enough in the brood-combs for winter and spring consumption. Where stocks have not been able

to do this, food should be given at once, the feeding being done rapidly, so that it can be sealed over before the colder weather comes. There are several different makes of feeders, but a cheap, handy rapid-feeder can be made with a 3-lb. jam-jar in the following manner: Cut a piece of tin large enough for the sides to fold over and clip the projecting lip of the jar; punch several small holes in the centre of this tin cover. Now take a square piece of wood $\frac{1}{2}$ in. thick, and cut a 2-in. hole in it. This will form a platform over the feed-hole in centre of quilt covering the brood-combs. Fill the jar with syrup, snap on the tin cover—which if made to fit will not allow any leakage—and the jar is then inverted over the stage or platform. Cost of feeder complete 3d., and it will last a lifetime. All feeders require to be wrapped up to prevent bees from outside getting to the syrup. When refilling jar a piece of glass takes its place. Robbing-out weak or queenless stocks often occurs after the close of the honey harvest; if robbing starts, nothing quells it more quickly than the fine rose of the watering-can. Give all stocks a good sprinkling, and remove the stock being robbed, or close the entrance and spread some carbolic acid on the entrance and alighting-board with a feather. The entrances of the other hives should be reduced to 1 in. or $1\frac{1}{2}$ in., and another sprinkling with the watering-can should be given all round. If any clusters of bees are on the top or around the robbed hive, these bees should have an extra drenching with clean water, and their courage will soon cool down.—W. WOODLEY, Beedon, Newbury.

HOW TO USE "THE BRITISH BEE-KEEPERS' GUIDE BOOK."

[7594.] With such a *vade mecum* to be consulted on every point by the would-be expert or successful bee-keeper, and with the able writer of that invaluable book sitting in the editorial chair of the B.B.J. and willingly answering the questions of all who are in difficulty, it may seem a great presumption to offer a few hints to some of its readers as to the way of making the best use of it; and yet, after considerable experience in examining candidates for the third-class expert's certificate, and frequent observation of the questions sent to the Editor, when, however kind, his answer must be, in effect, "You will see exact particulars on such and such a page of the 'Guide Book,'" I venture to think some bee-keepers may welcome a little assistance. Indeed, I have met many quite eager to avail themselves of such help from a

fellow bee-keeper, whose many winters' frosts may almost entitle him to excuse as a veteran.

Very often I have asked candidates if they know the "Guide Book," and have had the answer, "Yes; through and through," only to be told a little later "I never noticed that point. I will read it carefully when I get home." And all the pages—nay, all the paragraphs—of the "Guide Book" are bristling with points, often essential, and all of them the result of many years of study, careful research, close and detailed observation, of success and failure and their causes, and thousands of questions put in the B.B.J. and elsewhere. Take, for example, the first short paragraph on robbing, page 162, and read it somewhat after this fashion. First line: I am pretty safe if honey is rolling in. Second: It can be prevented at other times if I know how. Third and fourth: When it is likely to occur. Fifth: How fierce will be the fight. Sixth: Dire results. Then follow other paragraphs, important, practical, imperative. And all of this has its bearings on the taking and extracting of honey (page 84), feeding, time of day when operations are best performed, opening of hive for any purpose, and even the storage of honey. Undoubtedly the writer had all this and more in his mind when he penned the chapter.

I think such a chapter would never be skimmed if, after reading it carefully and asking ourselves the reasons for every recommendation, we closed the book and said, "Now, I will see if I can reproduce it just as if I were explaining it all to a novice and doing my best to help him." Never mind if you forget this, that, or the other; keep on and do your best to the very end. When this is honestly done, read the chapter carefully again, and you will know what it is worth, how it meets difficulties everywhere, and, what is more, you will never forget it.

Take one more example, and that most briefly, the little table on the "Metamorphosis of Bees" (page 12). The following chapters on brood-rearing, swarming and "casts," prevention of swarming, and many more would be utterly incomplete without this groundwork. This table is the very A B C (with apologies to Mr. Root) of bee-keeping.

It may be worth while to mention some of the many malpractices in manipulation: Hurried movements; giving too much smoke—the bees are upset and the queen escapes observation; not giving a little time after the first smoke for the bees to sip honey from the cells; insecurely fixing hive for driving or the empty one above; giving the bees chances to congregate everywhere except in the

chamber above; not placing the ends of the combs below in apposition with the upward passage-way; banging instead of gently and continuously tapping—bees do not need dynamite to persuade them to travel; tapping near the sides instead of near the ends of combs; letting the bees travel too fast and in huge masses when you want to find the queen; letting the hive fall when you are stung. I observe that these faults, when working with skeps, have recently been more prevalent, as skeps are becoming very rare in many districts, and it is often difficult for the beginner to get much practice in the work. Manipulation in frame-hives is much more familiar to most of our candidates, and many of them set about this in a very methodical and workmanlike fashion. I believe the "Guide Book" is more generally and carefully followed in this respect than in any other, though some are too hurried, others too slow, and the bees are not sufficiently undisturbed when handling them.

May I add a line of warm appreciation of the careful and methodical research indicated by Miss Annie D. Betts (page 334), and of hope that she will follow up this work and give your readers the benefit thereof? I am not sure that other insects visiting the flowers may not carry a mixture of pollen with them, and so account for some cases of mixed product.
—S. J., Bristol.

CURIOUS OLD SMOKER.

[7595.] I am enclosing a very rough sketch of an article which I picked up at a curio shop, and which was bought at a sale of a collection of antiquities. It was described as a bee-smoker, and as a bee-keeper it naturally aroused my curiosity, although I am disinclined to think it was made for the purpose. Anyhow, I thought no harm would be done by sending you a general outline of this appliance and asking your valued opinion. I have certainly tried a long cartridge of brown paper with pronounced success so far as the volume of smoke is concerned, although the means of obtaining it is very primitive and laborious. The nozzle proper is about 12 in. long and about 18 in. over all. The disc of wood is turned by a small handle (which, by the way, is a screw), which in turn causes the shoulder (s) to revolve, this being fixed to the axle of the fan as shown by dotted lines, which in turn revolves very rapidly, and thus creates a continuous draught through the nozzle.

It is indeed a very curious-looking arrangement, reminding one of a huge revolver.

If you can enlighten me in the matter I should be very glad, or should you like

to see it, I will with pleasure forward it for your inspection.—F. K., Seaford.

[We had a smoker almost the exact counterpart of the one you describe, and of which you send a sketch, except that it had a chamber for putting in the fuel. This smoker was too troublesome, as the fan had to be driven by hand, and both hands were employed while smoking the

smoker is very useful for long operations, and we frequently employ it, as it allows the free use of both hands.—Ed.]

CHLORINE FOR FOUL BROOD.

[7596.] Referring to the remarks of "S. J., Bristol" (page 314), I have no doubt Mr. Crawshaw, like many others,

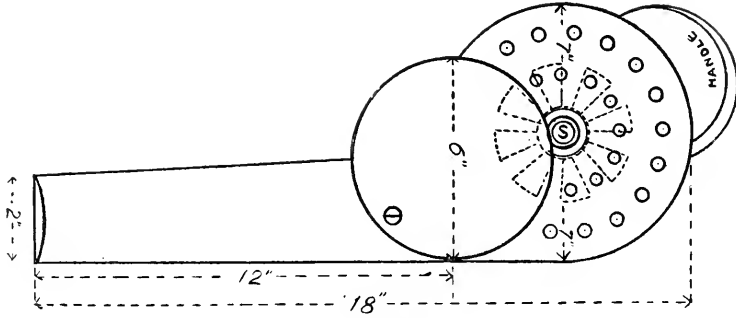

CURIOUS OLD SMOKER.

bees. For the last twenty-five years we have used an automatic smoker on the same principle, the fan being, however, driven by clockwork instead of by hand. This smoker was the invention of M. G. de Layens, who introduced it in 1874, since which time it has been much improved. The illustration will explain the apparatus. A is the fan, which revolves rapidly on winding the clock, the key of which is on the other side, and not seen in the engraving. B is a brake for regulating the speed and the volume of

would be glad to hear of a certain remedy for stamping out foul brood, and there can surely be no harm in trying to find such a remedy. It is with this object in view that I have referred to chlorine.

First let me ask "S. J." one question—If disease germs are not composed of gases what are they composed of? I begin to suspect that he does not know that he himself is composed of gases, and that they are vitalised, not separately, as he has understood me to mean, but in a collective and chemically united state.

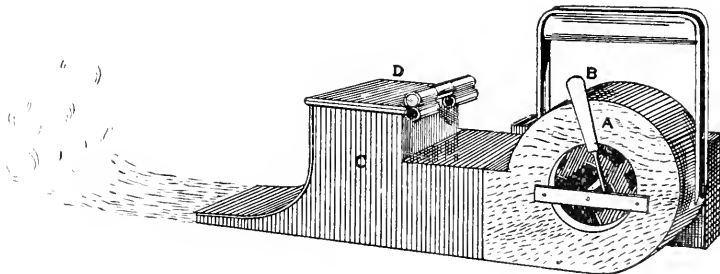

AUTOMATIC SMOKER.

smoke required. This can be done to the utmost nicety, and by simply touching the brake a continuous gentle stream can be produced; by releasing the brake, the more rapid revolution of the fan produces a thicker volume of smoke. C is the receptacle for fuel, and D the cover. When once alight it is only necessary to lift the cover from time to time and feed the receptacle with a little rotten wood or rags. When wound up the fan will revolve for half an hour or more, and produce a continuous stream of smoke, so that the

And unless "S. J." is very careful to preserve these gases from a high or a low temperature or contact with, say, chlorine, there is an end of vitality, although the gases are still there.

If "S. J." and a million foul brood germs, all alive and happy, were plunged into pure chlorine for, say, five minutes (less would do), all would suffer the same fate—death. So that in this instance both are on a level, and in an atmosphere of chlorine "S. J." cannot claim superiority over the minutest

microbe. Why is this? Because both contain gases or a gas which cannot resist the action of chlorine.

One may put one's hand into chlorine and draw it out again, but if the head were put in instead, a different result would follow. Why this difference? Because the hand is protected, whereas the internal parts are not, and therefore cannot resist the chemical action of the chlorine. Owing to the minuteness of microbes and the rapidity with which they are generated and developed, there is no time for oxidising any outer covering and but little material to work upon, so that I should think that the action of chlorine in their case is direct and *external*, and not internal as in the case of "S. J."; but still the chemical action is the same in both cases—the breaking up of a unity of combined gases in a vitalised state by introducing a gas which forcibly combines with one or more of the gases, and thus destroys a unity of gases capable of vitality, but no longer so when attacked by this foreign element, chlorine. This, I submit, is the action of chlorine on fowl brood bacilli.

"S. J." says:—"I always had the impression that gases are almost amorphous, and that while they have vitalising, destructive, or neutral properties they are anything but 'all alive.'" Leaving out the "almost amorphous" question, I made no attempt to say that gases separated from each other are all alive, but if ever I do say it "S. J." will not be able to disprove it. What I said is that disease germs are composed of gases in a chemically-combined state, and by breaking up the combination you destroy the germs.

I will now reply to my two other critics, T. F. Newton and "L. E. S." (pages 333 and 334). I will not stop to refer to the action of nascent oxygen in bleaching, but go to Mr. Newton's weakest spot—chlorine as a disinfectant.

When disinfectants were first used as such, the nature of their action was a mystery, and it was said that their value depended on a putrefactive substance, which is exactly what Mr. Newton says now. But this antiquated and very vague idea has been exploded for some time, and something more scientific and definite has taken its place. Chemistry moves along while many chemists stand still, and so their incontrovertible facts become obsolete and anything but facts. Chlorine is not dependent on putrefaction; its action is precisely the same whether it attacks a living substance or one in a state of decay. It is simply a change of position of combination always going on very largely, and it does not follow because a substance is putrefactive or decomposing that germs are being produced

which will cause sickness in man or fowl brood in bees. To disinfect is to destroy something which is infectious, and what is infectious is living and not in a state of putrefaction as Mr. Newton would have us believe.

When replying to "L. E. S." (page 334), I will leave ether and "vortex whorls" alone until they are better understood. Why are my critics so determined to make me say things I never thought of saying? I did *not* say "a microbe is a gas," but a combination of gases. I do argue that we ourselves *materially* are but gases. It must be so, as there is nothing else with which to form anything. There is no such thing as permanent matter. How strange that so intelligent a person as "L. E. S." should say that hydrogen and carbon do not easily unite when hydro-carbons are so very common and can be had by thousands of tons!—A. GREEN, Notts.

[In some form or other bacteria contain the elements of nitrogen, carbon, and hydrogen. All these substances are combined in the protoplasm of the body of which the microbe consists. Besides the variable quantity of nitrogen present, the protoplasm may also contain various mineral salts. Sulphur, starch, and iron are commonly present, as are also various pigments, so that it is hardly correct to speak of germs as a "collection of gases." It is true gases such as carbonic acid, carbonic oxide, hydrogen, nitrous oxide, sulphurous acid, and some others are known to arrest the growth of bacteria, if they do not kill them, but they have very little lethal value for spores, unless used in such concentration as to be destructive of animal life as well. It is the bacilli, and, above all, the spores, that we have to destroy, and we do not think subjecting the latter to chlorine even for five minutes would do so. The resistance of bacteria, and more especially of the spores, to disinfectants is due to a protective sheath or membrane composed principally of cellulose, which surrounds the protoplasm. In closing this discussion, we must say that little is known as to the cause of the fatal action of disinfectants on bacteria. Salts of the heavy metals, such as corrosive sublimate and nitrate of silver, coagulate protoplasm. They probably destroy life by precipitating certain substances from the protoplasm of the cells. Other substances, such as alkalis and acids, may act by the separation and solution of proteid bodies, thus destroying the protoplasmic structure. As we have no knowledge of the peculiarities of protoplasmic structures on which the phenomena of life depend, the matter in most cases is beyond explanation.—Ed.]

A REMARKABLE STOCK.

[7597.] Amidst the many poor records shown by bee-keepers this year, an occasional good return (considering the season) may be noted. One such case has come under my own observation, and, taking all the circumstances into consideration, I think the results are little short of marvellous. In January last a gentleman left his residence at Ashley Hill, Bristol, to remove to another short distance away. He had one stock of hybrids, and they were left in the garden for a few days whilst the family got settled in their new home. Some mischievous or ignorant person upset the hive, turning the brood-chamber upside down, smashing hundreds of bees and damaging the combs and frames. In this condition, with the roof off and exposed (except for an old sack which luckily fell over them) to the rain and frost, they remained for some days with the frames resting on the cold, wet grass. I was then informed of the mischief, and examined the bees, expecting to find them all dead, but to my surprise they were very much alive, still strong in numbers, and naturally very indignant at the treatment they had received. Taking a clean hive, I put them in it, covered them up warmly, and gave them a large jar of warm medicated syrup, the only thanks they gave me being plenty of stings. I then removed them for about three miles, kept them until they had had several flights, and then returned them to their owner, who does not care to handle bees himself. In May they were wonderfully strong, the owner had no section or shallow-frame rack, so I placed a small wooden box above the excluder-zinc. This they filled with about 15 lb. of beautiful honey from the fruit bloom. I then supered them with a rack of shallow frames fitted with full sheets of foundation. They started to work on this at once, but on June 10 sent out a tremendous swarm, which the owner sold. I cut out eleven of the twelve queen-cells, and a young queen was duly raised and fertilised. The weather, as we all know, was extremely bad afterwards; my own bees did little or nothing after May, and this was the experience of most bee-keepers in the neighbourhood. On Monday last I inspected this stock, and to my astonishment found the rack of shallow frames absolutely full of sealed honey, the weight of the rack, frames and honey, being just over 41 lb. The frames had broad metal ends and averaged $4\frac{3}{4}$ lb. per frame; the honey, mostly from limes, is of beautiful colour and consistency and with no trace of honey-dew. To get nearly 55 lb. of honey and a strong swarm from one hive in such a season as this is, I think, very

good, especially after the treatment the bees had in January last.—ARTHUR GRIFFIN, Bristol.

BEE-KEEPERS AND COUNTY ASSOCIATIONS.

[7598.] I have read with interest the letters in recent numbers of the B.B.J. (pages 295, 337, and 345) respecting the manner in which bee-keepers' associations are conducted, and having some experience as an old association member, I must confess that in many cases there is a just cause of complaint. Certainly there are times when unnecessary questions are asked by novices which could easily be explained by a reference to the "Guide Book," which should be in the hands of every bee-keeper, novice or otherwise; indeed, I know many naturalists also who find it useful.

I have been a bee-keeper for about a quarter of a century, and a member of the county association for some years previous to 1907, when I sent in my resignation. As "Beginner" does not give the name of his county, I cannot think he belongs to mine, as I have every confidence in the experts employed, and feel sure if they had promised a visit they would not have failed to pay it, even at their own expense. Honorary secretaries and committee-men are not like bees—you cannot "stimulate" them to increase energy in business matters, even if you are a millionaire.

I give two instances of what happened in my own case. In August, 1907, I was successful in winning a silver medal from a county association, but as this did not come to hand for some months I made three different applications in writing to the secretary, who did not even acknowledge my letters. On writing a fourth time, however, I got a reply that he regretted it had been overlooked. The medal came to hand in July, 1908—eleven months after it was won.

Again in August, 1908, I won another silver medal from the same association, and now—exactly twelve months later—I have not heard a single word about it, though they have it recorded in their last year's annual report.

Now, if bee-associations are to go on successfully surely something more must be done to gain the confidence of the members. It is not surprising that the membership is decreasing and balances are rapidly growing less.

I note some of the prosperous county associations make their annual meetings both interesting and attractive, and others might well follow their example. Let the meetings be held at a convenient time and place, so as to give the working-

men members an opportunity to take part; they have an equal interest in the association, even if they only subscribe the modest half-crown.

We bee-keepers will know that a hive would be useless if it were not for the number of workers, and even a queen would look a poor monarch without these. The manner in which county associations are conducted, to ensure success, must be more progressive and businesslike than at present, and when this is so members will not be lacking. But at present I advise new bee-keepers to speculate in a "Guide Book."—H. POTTS, Cheshire.

WEATHER REPORT.

WESTBOURNE, SUSSEX,

August, 1909.

Rainfall, 3.14 in.	Minimum temperature, 44° on 29th.
Above average, .58 in.	Minimum on grass, 35° on 3rd.
Heaviest fall, .61 in. on 24th.	Frosty nights, none.
Rain fell on 11 days.	Mean maximum, 69.7.
Sunshine, 250.2 hours.	Mean minimum, 52.1.
Above average, 31.3 hours.	Mean temperature, 60.9.
Brightest days, 7th and 28th, 13.5 hours.	Above average, .2.
Sunless days, 2.	Maximum barometer, 30.299 on 11th.
Maximum temperature, 82° on 12th and 13th.	Minimum barometer, 29.394 on 18th.
	L. B. BIRKETT.

AUGUST RAINFALL.

Total fall, 1.26 in.
Heaviest fall in 24 hours, .49 in. on 17th.
Rain fell on 12 days.
Below average, 2.18 in.
W. HEAD, Brilley, Herefordshire.

Bee Shows to Come.

September 13, at Conway, N. Wales.—Annual Honey Show, in connection with the Conway Honey Fair. **Entries closed.**

September 16, at Castle Douglas.—In connection with Dairy Produce Show, the annual show of the South of Scotland Bee-keepers' Association. **Entries closed.**

September 16, 17, and 18, at Crystal Palace.—Surrey B.K.A. Annual Exhibition of Bees, Honey, Wax, Appliances, &c. **Entries closed.**

September 18 to 25, at the Agricultural Hall, London.—Honey Show in connection with the Seventeenth Annual Exhibition and Market of the Grocery and Kindred Trades. Liberal prizes. **Open to all British Bee-keepers.** Schedules from H. S. Rogers, Secretary, Exhibition Offices, Palmerston House, Old Broad Street, London, E.C. (See advt., p. iii.).

September 22, at Altrincham.—Honey Show, in connection with the Altrincham Agricultural Show, the largest one-day show in the Kingdom. **Entries closed.**

October 5 to 8, at the Agricultural Hall, London.—Show of Honey and Bee Produce in connection with the British Dairy Farmers' Association. **Entries closed.**

Queries and Replies.

[3968.] *Transferring Bees.*—Will you please answer the following question through your paper next week? A man near here has some bees, and he knows nothing about them. Last July he had a swarm, and sent for me to come and hive them, but I was laid up at the time and could not go, so he got another man to hive them. He had a spare hive, with ten frames in it, in good condition. The man took these out and shook the bees into the hive with no frames. Some weeks afterwards I put a rack of sections in another hive for him, and as I was coming away he told me they had put the bees into the new hive. In about a month's time I went to look at the sections, and he asked me just to look at the other hive. I did so, and found that the bees had built in all the space from floor to roof. He now offers me the honey if I drive them out and leave him the bees. If I do so they will starve to death, and I do not want them myself. If I start driving them how could I fix the hive to get them out, as they are in the roof as well as in the brood-chamber? Do you think it would be best to kill them, as he would not look after them? I do not like doing so, for the sake of humanity. Sorry to give you so much trouble, but you will oblige me by putting an answer in B.B.J.—SAVAGES PIT, SUSSEX.

REPLY.—You will have a troublesome job; but with patience it could be done. Have a hive ready with frames fitted with foundation, and place it on the stand of the old one. Smoke the bees, and if you are not able to take off the roof turn the lot upside down and remove the floorboard. Then with a little smoke drive the bees away and cut out each comb, brushing the bees into new hive. Any combs containing brood could be fitted and tied into frames with tape, and the brood allowed to hatch out. Some of the comb containing honey could also be fitted into frames to give the bees a good start. Keep a watch for the queen, and be sure to place her in the new hive. After all the combs have been removed, the few remaining bees can be brushed off in front of the hive. The operation should be performed in the afternoon, when bees have ceased flying, to prevent robbing. The bees in new hive must be closed down and fed liberally, and, if possible, should have another lot of driven bees added to them. If you want the bees simply for uniting with another lot, brush them off on to a sheet as you take out the combs, and let them run into a skep, where, if you have secured the queen, they will remain until you are ready for uniting.

[3969.] *Glass on Top of Sections.*—Will you be kind enough to tell me, in your "Queries and Replies" section, as early as convenient, if there is any objection to the use of a sheet of clear glass over the rack of sections in a hive, which will enable one to prospect the sections for the purpose of noting progress without letting the bees escape or having to use smoke. It seems to me that this would lend great facility for examination of sections, which is so obvious that I can only think there must be some objections to its adoption, possibly by moisture condensing on the underside of the glass, or something else that has not entered my mind. Of course, the usual quilts would be placed over the glass to keep in the warmth. Thanking you in anticipation.—A NEW HAVEN, CONN., U.S.A.

REPLY.—The objection to using glass is that it would become propolised to the sections, and it

would not answer the purpose for which it is intended, as bees cluster quite to the top of the sections, and you could not see the progress of the work without lifting the glass and driving the bees down with smoke, which is much easier accomplished where a calico quilt is used. Lifting the edge of the quilt and giving the bees a few puffs of smoke will quickly drive them down sufficiently to enable anyone to see the progress of the work, and is infinitely less trouble than using glass.

Notices to Correspondents.

J. T. (Cumberland).—Multitude of Eggs in Sections.—We can only account for the number of eggs in the cells of section by supposing that a young queen must have got up among the sections immediately after fertilisation, and as she increased in size was not able to get below the excluder. Some queens confined in small space, such as in a nucleus, will frequently continue laying, as they do not seem to be able to control the production of eggs, and go over the same cells continuously, sometimes even dropping the eggs on to the floorboard. The queen-cells were probably started before the queen issued, as they do not appear to be newly-formed ones, and there is no jelly in the cups, which also contain numbers of eggs. The eggs are mostly only one day old, some of them having completely dried up. Probably now that you have removed the excluder you will find the queen laying below.

AN OLD READER (Birmingham).—A Simple Swarm-holder.—We should be glad to know if you have tried the device of which you send a sketch, and if it has been successful. If it has, we would like to have full detailed description of time and method of fixing, and particulars of construction, which would enable bee-keepers to try it.

E. G. T. (Tunbridge Wells).—Leaf-cutter Bees.—The rose-leaves sent have pieces cut out by a *Megachile*, a leaf-cutter bee, which burrows in the ground or in rotten wood. The long pieces with the rounded ends are used for lining the nests, and the circular pieces for closing them at the top, all being cemented together with a gluey substance excreted by the bee.

H. H. S. (Surrey).—Queen Thrown Out.—There does not seem to be anything the matter with the queen, which is a young fertile one. It is possible when you removed the old queen that you might have overlooked a young one, and the bees have cast one of the two out. You should examine the hive to make sure of there being a queen.

J. W. S. (Blandford).—Adjustable Gauge for Hive-making.—The ingenious model of appliance which you send would be useful for amateurs and those making their own hives, and would enable them to cut their boards to any length when it was once set. You would have to depend upon such for a sale, and to any other amateurs who work in wood, for manufacturers already have their gauges attached to the machines by which all their wood is cut out, as very little of such work is made by hand now. When you have a complete working appliance made you could send it on for inspection, and we would show it at the next *Conversazione* of the B.B.K.A., to be held on October 7, where it would come before the notice of a good many bee-keepers. It could be described in B.B.J. as a "Novelty for 1909."

DISAPPOINTED (Norfolk).—Dark Section Honey.—1. The reason why your early sections were light was because the honey was the produce of flowers only yielding light-coloured honey, such as

clover, &c. The dark colour of the later honey is probably owing to honey-dew or flowers producing dark honey, such as privet, limes, or buckwheat. 2. It cannot be prevented, but the sections can be removed as soon as the early flow ceases, and when it is noticed that dark honey is being stored, or when there is honey-dew on the trees. 3. The reason why some are partially light and dark is because the early flow ceased before the sections were finished, and bees continued to store the dark honey.

A SCOTSMAN (Rathes).—Fertile Workers.—It is a well-established fact that there are laying workers, but as from outward appearance they do not differ from ordinary workers, it could not help you to recognise them, and as you say "to my knowledge there never existed such a freak as a fertile worker, and no other bee-keeper ever saw one," it would be difficult to convince you to the contrary, even though bee-keepers have seen them in the act of laying. In our long experience since 1860 we have had many such fertile workers brought to our notice. Anatomically they differ from ordinary workers, for although incapable of fertilisation the ovaries become sufficiently developed to allow the bee to lay eggs. The ovaries of a fertile worker are shown on page 135 of "The Honey-bee," where also the rudimentary ovaries of an ordinary worker, consisting merely of thread-like tubes, are shown for comparison. If the bees are left destitute of either brood or queen for ten to fourteen days, the bee-keeper is liable to find evidences of the presence of fertile workers in the shape of eggs scattered about promiscuously, as shown on page 13 of "Guide Book." With Cyprian bees it is not at all uncommon to find several workers laying at the same time. More information as to how these fertile workers come about will be found on page 150 of "The Honey-bee." A pure-bred queen, although not fertilised, does not produce mongrel drones as you allege, but if she is a mongrel herself the drones will be so too.

NOVICE (Rugby).—Wintering Bees.—1. We get very few dead bees from strong stocks, and never require to clear the entrances in winter, as we do not use zig-zag entrances, and leave ours well opened. You can use the device you mention, but we prefer raising the hive on to a 3-in. eke. You can put a wooden protection in front of porch to act as a shelter from snow, provided you allow the bees free egress. On fine days they will remove any dead that may fall on the floorboard. As you are not leaving until November, before you go open the entrances to 6 in. 2. Preparations for queen-rearing should be made in April (see "Guide Book," page 125). 3. Yes; three combs are sufficient for a nucleus (see page 132). 4. If you intend to have more than one nucleus in a hive, use close-fitting division-boards, and have entrances in opposite directions. 5. Yes; the binding can be done by our binders. The price would be 2s. 6. The B.B.K.A. *Conversazioni* are for members, whose friends are also welcomed. When you are in London, if you call upon us, we shall be pleased to introduce you.

H. G. G. (Whitechurch).—Breed of Bees.—They are dark Italians.

Honey Samples.

E. A. R. L. (Tisbury).—The honey is well granulated and of good appearance, but the flavour is spoiled by some greasy substance. It is possible it may be English, but can certainly not be classed as "best."

J. B. (Lanarkshire).—1. It is very thick and dark, but not bad flavoured. 2. Principally from flowers of fruit trees and beans. 3. It will not spoil the appearance of heather honey, as that is nearly as dark.

C. T. B. (Okehampton).—The honey is of good consistency and flavour, being principally from apple and sycamore, and is free from honey-dew.

THE MISSING LINK (Co. Dublin).—It is nice-looking light honey, with a peculiar, not disagreeable, flavour, resembling that of acacia and raspberry.

W. H. (Staffs.).—Very nice lime-honey, of good colour and flavour.

J. T. B. (Chelford).—Honey of poor quality, being thin and watery, colour dark, aroma and flavour rather unpleasant. It also contains honey-dew.

O. R. Q. (Ilford).—Good honey, gathered mainly from limes. Colour and consistency equally good in both samples. Quite saleable, as many people like the somewhat strong flavour of lime-honey.

B. (Lewes).—The colour of sample is very good, consistency fair, but the honey tastes rather watery and unripe. Only that from the bottom of the ripener should be used for show purposes. The thin honey will float at the top.

W. P. (Catrine).—Fairly good honey, gathered from bramble blossom. No honey-dew in it. Rather thin in consistency, but could be used for the table or for the bees.

H. A. J. (Tisbury).—There is no honey-dew in sample, which is fairly good in flavour, and quite fit for table use. Probable source beans and late-flowering plants.

LILYS HELI (Festiniog).—Dark honey which contains no honey-dew. Gathered from beans and mixed sources. Quite good enough for table use and for showing in dark honey class.

NOVICE BEE-KEEPER (S. Woodford).—Very dark honey, with strong flavour of limes. Contains a little honey-dew, but is quite palatable. Its colour is its worst point. Could either be eaten or fed back to the bees.

C. R. F. (Hatfield).—Fairly good honey, from beans principally. Flavour and consistency both good; colour is its worst point.

A. COOK (Ratho).—Almost pure lime-honey. Colour and flavour both good.

H. M. JONES (Birmingham).—Very thick dark honey, of good flavour, from beans, brambles, and such sources. Very slightly tainted with honey-dew, which has rather spoilt its appearance.

R. CLARK (Leytonstone).—Honey gathered from limes, and free from honey-dew. Good in colour and flavour, but rather thin, probably through some of it being unsealed. It would have been good for show purposes had it been of better consistency; but its chance of securing an award will depend on the class of honey in competition with it.

Suspected Combs.

UNFORTUNATE NOVICE.—Comb appears to be affected with black brood, but it is in the early stage of disease. There is no odour, but a slight trace of ropiness.

ANXIOUS (Bridgwater).—Some of the brood is merely chilled; but there are suspicious signs of black brood commencing. As this disease is as contagious as foul brood, and in some respects resembles it (American bee-keepers call it European foul brood), you should take the same precautions as with foul brood, and treat the stock in the same way.

P. C. (Aberdeenshire).—Comb is affected with foul brood in advanced stage. You would have been more certain of a cure if you had destroyed the combs, frames, and quilts, putting the bees on to new foundation; but the stock may be cured. In fact, bees have been known to cure themselves during a good honey season; but you must keep a careful watch in spring for signs of a return of the disease.

Special Prepaid Advertisements.

Twelve words and under, Sixpence; for every additional Three words or under, One Penny.

HONEY RIPENER, never used, in exchange for Driven Bees.—**CRUICKSHANK**, Station-master, Grantown-on-Spey. u 10

ITALIAN HOME-RAISED QUEENS, yellow beauties, from best strain obtainable. Return post, 5s.—**O. KNIGHT**, Epney, Stonehouse, Glos. u 10

QUEENS, choice 1909, bred from my non-swarming stocks, 3s. 6d. each, per return.—**TAYLOR**, "Hollyhurst," Boldmere-road, Wyde Green, Birmingham. u 13

THE CHANCE OF A LIFETIME.—"Dell" Apiary and 22 poles of gardens; low rent; Stocks of Bees, in grand condition, at valuation. Full particulars on application.—**A. NICHOLLS**, 38, Oxford-road, High Wycombe. u 12

1909 FERTILE BRITISH QUEENS, 3s.; 3-frame Nuclei, 12s. 6d.; 4 frames, 15s.; strong Stocks, in good Hives, 30s.—**ROBERTSON**, Benview, Dumbarton. u 11

FOR SALE, 3 strong Stocks Bees, in Bar-frame Hives, guaranteed healthy, 30s. each.—**ARTHUR POLLARD**, Silsden, near Keighley. u 9

HEALTHY DRIVEN BEES, with 1909 Queens, 4s. 6d. lot; also 40 good Stocks, on Frames, 16s. each; in good Hives, with plenty stores, 21s. each; in Skeps, 12s. 6d. each. Deposit only.—**HARRISON**, Bee Farm, Middleton, Pickering. u 8

5 GOOD STRONG SKEPS BEES, 1909 Queens, 9s. 6d. each, or offer; five good Stocks, on 10 Frames, boxes, 15s., or offer; overstocked reason of disposal.—**HARRIS**, Postman, Aberfeldy. u 7

"COWAN" EXTRACTOR, cog-gearred, reversible cages, new last season. Cost 50s.; exchange Nuclei on Frames, with 1909 Queens, British, or sell £2.—**DAVIES**, Bootmaker, Northop Hall, Flintshire. u 6

FOR SALE, 2 Stocks, on 10 Frames, wired, 1909 Queens, "W. B. C." Hives, £1 each.—**J. GLADDING**, Castle Rising, King's Lynn. u 5

2 STRONG STOCKS HYBRID LIGURIANS, guaranteed healthy, good Hives, 1908, 1909 Queens, Supers, 3 dozen Shallow-frames, Queen-rearing Hive, Smoker, Sundries, 2 guineas.—**WILLOUGHBY**, 27, Fasset-square, Dalston. u 4

HEALTHY DRIVEN BEES, 3s. per lot; spare Queens, 1s. 9d.; to spare, few pedigree 1909 Taylor-Doolittle Golden Queens, mated with Sladen Golden Drones, 4s. each; cash with order; ditto, as 3-frame Nuclei in 5-frame Hive, 12s. 6d.; as 5-frame Stocks, in Hive, 15s.; Natives, 10-frame Stocks, Stores, healthy, young Queen, 17s. 6d. each. Deposit.—**GORDON**, Bassingbourn, Royston. u 3

WANTED, six lots healthy Driven Bees. State lowest price per lb.—**EDGELL**, Manager, Farrington, Bristol. u 2

WANTED, Secondhand Honey Extractor, also Ripener and Strainer.—**DAVIES**, Haulfryn, Barmouth. u 1

DRIVEN BEES.—Guard your Honey supply in the Variable Seasons with our grand strain of Blacks, unqualified success, a few lots left, 4 lb. 5s. 6d., package free; other lots 4 lb. 4s. 6d.; boxes allowed for if returned.—**FLUDDER**, Arleigh, Colchester. t 99

LIGHT SECTIONS BOUGHT, 7s. to 8s. per doz.—Send or write to **THE HONIELADE CO.**, 23, Moorfields, E.C. t 98

ROYAL SOVEREIGN AND LAXTON STRAW-BERRY RUNNERS, 2s. 100, carriage paid.—**MRS. MARSII**, Baytree Cottage, Sayerland, Polegate. t 96

Editorial, Notices, &c.

CUMBERLAND B.K.A.

SHOW AT CARLISLE.

The first annual show of honey, hives, and beeswax held by the C.B.K.A. took place, in conjunction with that of the Carlisle Horticultural Association, in the Covered Markets, Carlisle, on Wednesday and Thursday, September 1 and 2. The joint exhibition resulted in one of the finest displays of its kind ever seen in the Border City, and attracted crowds of visitors from all parts.

The bee-keepers' section was situated in the verandah, in West Tower Street, and the exhibits, which numbered 130, were ranged along one side of the building. The construction of this staging, which was beautifully draped in front and decorated with heather along the top, and the suitability of the building for an exhibition of this kind, elicited many approving remarks from both visitors and exhibitors, gratifying to the secretary and his willing band of helpers. With regard to the exhibits, it was the opinion of the judges—Messrs. D. M. Macdonald, Banff, and L. S. Crawshaw, Norton, Yorks—that, considering the scarcity of honey all over the country, caused by unfavourable weather and the prevalence of honey-dew in many places, the display was a very good one and the quality of many of the exhibits excellent.

The classes for heather honey were disappointing in point of number of exhibits staged, showing clearly how little heather honey has been secured this season; but some very creditable specimens of both section and extracted honey were staged.

It was disappointing also to find that not a single entry of any kind had been made from north of the Border. The general excuse of Scotch exhibitors not appreciating Southern judges could not be put forward here, and we can only conclude that paucity of honey "ayont the Tweed" was the cause of the absence from the bench of Scotch exhibits.

Trade exhibits of hives and appliances were shown by Muncaster Bros. and Messrs. Gibson and Cairns, both Carlisle firms. An observatory-hive with queen and bees, staged by the secretary, was the centre of attraction on both days of the show. Subjoined is a list of the judges' awards:—

OPEN CLASSES.

Twelve 1-lb. Sections (other than heather).—1st and certificate, J. Pearman, Derby; 2nd, W. Patchett, Cabourne; 3rd, Miss G. B. Hudson, Crosby House, Carlisle.

Twelve 1-lb. Heather Sections.—1st and certificate, J. Pearman.

Twelve 1-lb. Jars Extracted Honey.—1st and certificate, W. Patchett; 2nd, H. W. Saunders, Thetford, Norfolk; 3rd, R. W. Lloyd, Thetford, Norfolk; v.h.c., J. Pearman; h.c., J. W. Egglestone, Bishop Auckland.

Twelve 1-lb. Jars Extracted Heather Honey.—1st and certificate, J. Pearman; 2nd, T. Sleight, Danesmoor, Chesterfield; 3rd, J. W. Egglestone.

Twelve 1-lb. Jars Medium-coloured Honey.—1st and certificate, J. Pearman; 2nd, J. Carey, Birkenhead; 3rd, W. F. Trineman, Saltash.

Single 1-lb. Section.—1st and certificate, W. Henderson, Blackford, Carlisle; 2nd, G. Kerr, Longtown, Cumberland; v.h.c., W. H. Patchett; h.c., T. Hewson, Calthwaite, Carlisle; c., J. Ismay, Fletchertown, Cumberland.

Single 1-lb. Jar Extracted Honey.—1st and certificate, H. W. Saunders; 2nd, J. Pearman; v.h.c., W. Patchett; h.c., J. Wakefield, Cockermouth, Cumberland; c., W. Henderson.

MEMBERS' CLASSES.

Twelve 1-lb. Sections (other than heather).—1st and certificate, W. H. Bennett, Calthwaite, Carlisle.

Six 1-lb. Sections (other than heather).—1st and certificate, J. G. Nicholson, Langwathby; 2nd, W. Henderson; 3rd, Miss G. B. Hudson; v.h.c., J. Ismay; h.c., Mrs. Lewthwaite, Brackenburgh; c., Miss M. Bird, Penrith.

Six 1-lb. Heather Sections.—1st and certificate, J. G. Nicholson.

Twelve 1-lb. Jars Extracted Honey (other than heather).—1st and certificate, J. Wakefield; 2nd, D. Bouch, Aspatria.

Six 1-lb. Jars Extracted Honey.—1st and certificate, W. Henderson; 2nd, J. Wakefield; 3rd, D. Bouch; v.h.c., J. J. Grieve, Blackford, Carlisle; h.c., G. Kerr; c., Miss M. Bird.

Six 1-lb. Jars of Medium-coloured Honey.—1st and certificate, J. Ismay; 2nd, G. Moir, Calderbridge, Cumberland; 3rd, D. Bouch.

Honey Trophy (open).—1st and certificate, J. Pearman, Derby.

Beeswax (open).—1st, F. Harris, Sibsey, Lincs; 2nd, W. F. Trineman; 3rd, H. W. Saunders; v.h.c., J. Price, Haden Hill, Staffs; h.c. (equal), P. M. Ralph, Settle, and D. Bouch.

Hives (open).—1st and certificate, W. A. Muncaster, Carlisle; 2nd and v.h.c., Messrs. Gibson and Cairns, Carlisle; h.c., G. Kerr.

Photographs of any Apiary or other Interesting Object in Connection with Bee-keeping (open to amateurs only).—1st, J. Sewell, Heads Nook, Carlisle; 2nd and v.h.c., Mrs. Johnson, Montague

Road, Hornsey, London; 3rd, J. Pearman; h.c., R. Atkinson, Milburn House, Newbiggin; c., J. Price.—G. W. AVERY, Hon. Secretary.

PERTSHIRE B.K.A.

ANNUAL SHOW.

The eighteenth annual exhibition of the Perthshire Bee-keepers' Association was held, in conjunction with the Royal Horticultural Society's exhibition, at Pitcullen, Perth, on August 19 to 21. Notwithstanding the backwardness of the season, principally owing to the inclement weather in July, a good entry was made, the honey, which was artistically laid out, being of fair quality. In the artistic honey display class there was keen competition, Mr. J. Hutchison being awarded first prize. Two observatory-hives stocked with bees were an interesting feature of the exhibit, and attracted considerable attention.

Honey Display.—1st, J. Hutchison; 2nd, H. Caven; 3rd, P. McPherson.

Six 1-lb. Jars Granulated Honey.—1st, J. Hutchison; 2nd, H. Caven.

Twelve 1-lb. Sections.—1st, J. Hutchison; 2nd, H. Caven; 3rd, J. Hepburn.

Four 1-lb. Sections.—1st, J. Hutchison; 2nd, H. Caven; 3rd, J. Hepburn.

Super of Honey.—1st, J. Hepburn; 2nd, P. McPherson.

Six 1-lb. Jars Extracted Honey.—1st, J. Hutchison; 2nd, A. Yule; 3rd, H. Caven.

Show-case of Honey.—1st, J. Hutchison; 2nd, A. Yule; 3rd, J. Hepburn.

Two Standard Frames of Honey.—1st, P. McPherson.

Observatory-hive.—1st, H. Caven; 2nd, P. McPherson.

Beeswar.—1st, J. Hepburn; 2nd, J. Hutchison; 3rd, A. Yule.

Mr. J. Hutchison, having gained the highest number of points, has won the gold medal for 1909.—A. G. CUMMING, Secretary.

HONEY-SHOW AT HORSHAM.

The show of honey held in connection with the Horsham Horticultural Society took place on August 19. The season being the worst for many years, entries were few in number compared with last year. Mr. F. Brett, Warwick, judged the exhibits and made the following awards:

Twelve 1-lb. Sections.—1st, J. Wadey; 2nd, S. Bailey; 3rd, J. Muggeridge.

Twelve 1-lb. Jars Medium Extracted Honey.—1st, J. Wadey.

Twelve 1-lb. Jars Dark Extracted Honey.—1st, W. Thornton.

Twelve 1-lb. Jars Granulated Honey.—1st, J. H. Stephens.

One Shallow Frame.—1st, S. Bailey.

Beeswax.—1st, W. Thornton; 2nd, R. B. Dart.

Honey-cake.—1st, Mrs. S. Carter; 2nd, Miss Evershed.

Honey Vinegar.—1st, R. B. Dart; 2nd, W. Evershed.

COTTAGERS' CLASSES.

Six 1-lb. Sections.—1st, A. Tidey; 2nd, W. Wright; 3rd, G. Atkins.

Six 1-lb. Jars Honey.—1st, A. Tidey; 2nd, T. Faulkner; 3rd, G. Atkins.

Beeswax.—1st, T. Duncan; 2nd, W. Thornton.—R. DART, Hon. Secretary.

W. B. CARR MEMORIAL FUND.

Amount already acknowledged	£	s.	d.
.....	56	16	6
Cairncross and Tillen (Pretoria)	0	13	6
F. S. H.	0	2	6
J. Todd	0	2	6
H. Marr	0	2	0
W. C. Hannaford	0	2	0
A. Cook	0	2	0
J. Chandler	0	2	0
Sisters of Bethany	0	2	0
A. Gambrill (Bristol)	0	1	0

58 6 0

Correspondence.

The Editor does not hold himself responsible for the opinions expressed by correspondents. No notice will be taken of anonymous communications, and correspondents are requested to write on one side of the paper only, and give their real names and addresses, not necessarily for publication, but as a guarantee of good faith. Illustrations should be drawn on separate pieces of paper. We do not undertake to return rejected communications.

AMONG THE BEES.

A QUEEN'S EGG-LAYING.

[7399.] Generally in a normal season queens, having once started ovipositing, keep right on. As spring disappears and summer mellows, the pace is gradually accelerated until the height of the season passes, and then the process usually wanes slowly. This has been an abnormal season, and apparently matters have not followed the orthodox fashion. Slow of beginning in early spring, the wintry March and April showed very little breeding. Then followed a spurt, but the chill and inclement weather of June and July afforded few chances for bees to provide pollen, and fewer still for the ingathering of nectar. Consequently in many hives egg-laying almost ceased time after time. Repeatedly, hives under observation showed a shrinkage of bees

from the combs outside the regular cluster, and as a result patches of chilled brood were seen again and again. Beyond this area eggs were observed, outside the influence of the nurse-bees or the life-giving heat of the worker cordon. These were carefully watched later, and although the larvæ which had perished from cold and neglect were cleared out, the eggs appeared to receive attention, and they developed into living larvæ when the cells were sealed, and live bees issued in regular course. Apparently these eggs had been lying inert for about three weeks. During that time, although they made no progress, they did not lose their vitality; but on the extension of the heat cluster they passed through the usual metamorphosis and became living bees.

Scattered Eggs.—Queens in a normal condition lay their eggs in a very compact way. Starting in early spring, the first patch may be a small roundish or oval-shaped area on two of the central frames, facing each other in the very heart of the cluster, where their successful tendance and feeding are most certainly assured. In time these patches are enlarged most systematically, until in warm weather, in the height of the season, they may form a solid block of brood in all the central frames. Whenever irregularly-formed patches are found, with the eggs much scattered, you may pretty safely suspect the presence of laying workers or a drone-layer in the hive. Perhaps at times a queen, after a long sojourn in the mails, may do a little of this for a day or two, but after that her ovipositing is normal. Several eggs in one cell may indicate an over-prolific queen, one with too few bees to tend the eggs, a failing queen, a drone-layer, or that one or more fertile workers are present in the hive.

Moving Eggs.—Some authorities do not believe that bees move eggs or larvæ from one cell to another; others claim there is a doubt about it: some affirm that they are incapable of carrying out the operation; and yet others have an open mind. On the other side, a considerable number believe they can and do move eggs, while others are positive of the fact, without much authority for the belief. A few have affirmed that they have indirect proof of the feat being performed, while a small remnant state that they have proof positive that bees can carry out the operation at will. No insuperable barrier in the way of a performance of the act can be seen, and we have fairly circumstantial evidence in favour of the aided migration of eggs.

Duplicating Eggs.—Although under normal circumstances a queen lays eggs

systematically and one in each cell, yet on occasions numbers may be found lying on the floorboard, and even when manipulating she may deposit them on the hand of the examiner. Kept in a very cramped space, she makes several circuits, laying an egg in the same cell again and again. Quite recently I saw a section with from six to sixteen eggs in every single cell. It will be interesting to hear more of this abnormal case, and I expect to see further particulars in an early issue.

The Value of New Combs.—While old combs well built and all worker-cells are at times a valuable asset (and I have no sympathy with those who would, foolishly as I think, renew the whole hive works every year), I am becoming more and more convinced that no combs showing defects, and none about which there is even the shadow of a doubt, should ever be returned to a hive once they are withdrawn. A neighbouring bee-keeper, working with hives of the "Combination" type, every year at the spring examination shifts back three of the most imperfect frames, extending the brood-nest later when a flow sets in with three new frames furnished with full sheets of foundation. At the end of the season he presses the three frames standing alongside of the back dummy, frequently getting nearly 20 lb. of honey from them. In this way he has no frame in his hives longer than about four, or at most five, years. I think the system is a commendable one, and I practise it on a limited scale. It is just as easily carried out in hives with the frames at right angles. All frames showing defects may be placed next the dummy, or one at each side, leaving them pretty widely spaced in order that they may be plump, fat ones, worth pressing in early October. The honey obtained will more than balance expenditure, and the works are kept fresh, sweet, and clean, and this beyond a doubt helps to keep disease at bay. Then the value of a new comb *per se* is undoubtedly considerable. To test this, let anyone during the busy months place a frame of wired foundation in the centre of brood-nest of a populous colony, and he will find it drawn out as if by magic. In twenty-four hours every cell-wall will be well lengthened, and the chances are that by the next day almost every single cell will be occupied by a tiny white speck, which on being examined will be found to be a new-laid egg. All this before the cell-walls are much more than half built. This preference of a prolific queen for a fine fresh, new comb should show the value she puts upon it. Then I often think that if inserted at the right time it seems to cost the bees little or no labour, or no appreciable loss of honey,

to draw this new comb fully out, while I am almost certain they employ time in accomplishing this which would otherwise be profitless. Bees frequently have a craving for comb-building, and are even benefited by being enabled to do so. Thus I contend new combs can be frequently obtained from a strong stock at very little cost of time, labour, or materials. Bees at a certain stage of their existence are unable to join the forces in the field; they have time hanging heavy on their hands after undertaking any nurse work, preparing chyle food, and doing any capping. This time, I feel, can be profitably spent in comb-building.—D. M. M., Banff.

INTRODUCING VIRGIN QUEENS.

[7600.] I am one of your new subscribers across the "big pond," as the Atlantic is often called, and like to read your journal very much. By referring to 7568, page 324, on introducing virgins, I will say that I had similar trouble to "D. M. M." in introducing queens into a colony, but worse. I am a queen-breeder here in the United States, and my demand was greater than I had arranged for, and I was obliged to take queens out of full colonies, introducing virgin queens. One hive swarmed with the virgin queen, so I put the swarm back into a new hive, which contained two frames of brood and honey and eight frames of full sheets of comb-foundation. The hive was examined after a few days, and the young queen was gone. Another was introduced, and then another, but laying workers put in their appearance. I introduced six queens, and all met the same fate. I then placed this hive on the stand of the strongest colony, or, in other words, I exchanged the colony with the strongest colony I had in my home yard, and in a short time the bees just cleaned out the laying workers. Another queen was then introduced, but with no success, so I put the brood-chamber, bees and all, on top of another good strong colony, with queen-excluding zinc between the two, and put one frame of brood in different stages of development in the top chamber, and left it there for forty-eight hours. By so doing I had a goodly number of young or nurse bees in the top brood-chamber. It was then moved to a new stand, and another queen was introduced, this time successfully, and the colony is now doing well.

We have had a dry spell here, and the bees have collected a great deal of honeydew. I want to ask you a few questions shortly, as there are some things I see in the "Guide Book" that are different from the practice in the U.S.—O. F. FULLER, Blackstone, Mass., U.S.A.

NOTES FROM NORTH BUCKS.

[7601.] I enclose an interesting cutting from the *Daily News* of September 1, headed "A Remarkable Hive." Could not some reader of the B.B.J. get a few more particulars? It seems to me, with over a bushel of bees, there must have been quite a number of separate colonies, and further details would be very interesting reading: "For twenty years bees have hived themselves in the wall of a house on Merle Common, Oxted, Surrey. Yesterday a man cut away the brickwork and found large clumps of comb containing honey suspended from the outer and inner walls. He estimated the honey in the self-made hive at about three hundredweight, and actually managed to secure about two hundredweight. In addition he succeeded in hiving over a bushel of bees. In the hive there was also found a starling's nest and a quantity of egg-shells, and the occupier of the house states that a brood of starlings were hatched there this season. The bees and the starlings entered their abode by the same aperture and lived harmoniously together."

Damping and Folding Sections.—The simplest and quickest way of doing this is to slightly damp the outside of each section (in the flat) just where the angles will be. A small paint-brush is best for the purpose. About twenty-one sections can be damped at a time. Then begin with the first that was damped, and fold on a mandrel, not over a block, closing up with a few raps of a small hammer, which rivets or clinches the teeth and helps to keep them true. It would be impossible to properly close the sections I get with hand pressure. With me the first operation is to sand-paper them (in the flat, of course): it saves my bees a lot of time, and it would surprise anyone who has never done this to see the quantity of débris from half a dozen sets of sections.

Late Swarms.—A bee-keeper (skeppist) a few miles away says that his bees were swarming to the very end of July; he thought they would never leave off. Another near here had her best, or rather her largest, swarm on July 23—about 5 lb. or 6 lb., from a skep!

Depth of Frames and Brood-box.—I was pleased to see notice taken of the space between bottom of frames and floorboard. I have often been annoyed to see a full $\frac{1}{2}$ -in. space between bottom of comb and bottom bars of frames, although the orthodox $\frac{3}{8}$ in. was left between bottom bars and the floor, and when the former happens to sag there is a first-class retreat for wax-moth grubs. To remedy these faults I have slightly

deepened all my brood-boxes, so as to give a full $\frac{1}{2}$ in. below bottom bar; and also I now use $\frac{3}{8}$ -in. or $\frac{1}{4}$ -in. by $\frac{1}{2}$ -in. bottom bars, taking care when nailing them on that they have an upward curve. I now find the comb drawn out down to the bottom bars and attached thereto. But I think it advisable not to have the sheets of foundation above $7\frac{1}{2}$ in. deep, as if they stretch down to the bottom bar they "buckle" and spoil the comb.—A. HARRIS, Wavendon, Bucks.

HIMALAYAN BEES.

FIRST EXPERIENCES IN APICULTURE IN KASHMIR.

[7602.] Apparently very little is known about Himalayan bees, but as a bee-association has been recently started at Simla with the Lieutenant-Governor of the Punjab as president, it is to be hoped that progress will now be made.

In Kashmir bees are very common. I saw wild bees as high as 7,200 ft. above sea-level which had made their home in the trunk of a pine-tree. The wild bee appears to be yellower in colour and to have a rather longer body than any of the domesticated varieties. Of the latter I have seen two kinds—a dark variety which may be called a black bee, and another with pale yellow bands round the abdomen and a thorax covered with a light brown fur. In this yellow variety, at the upper part of the abdomen under the wings, there is a fairly broad transverse stripe on the back, below which there are four parallel ones. That nearest to the tail is a little broader at the middle, which makes the bee look as if it had a white tail. The wings when folded reach to the lower margin of this stripe. These white-tailed bees are said to be gentler than the darker variety.

A very large number of villagers in Kashmir keep bees in curious hives which are merely earthenware cylinders about 2 ft. long, and these are built into the walls of their houses. The outside end of the hive has a central hole about 1 in. across or sometimes a series of small holes in a circle, while the inner end has an earthenware lid fitted over it, and kept in position with clay. No artificial feeding is done in the summer, but in winter the bees are supplied with food, though no special measures are taken to protect them from the cold; therefore the mortality is, I understand, very great. In many villages, after a severe winter, when the temperature sometimes falls to zero Fahrenheit, more than three-quarters of the colonies will perish. The Kashmiris understand something of the management of queens. They have a curious way of securing a restless queen by tying a fine thread to one of her legs and pinning her

to the comb. Sometimes they also change queens. The hive is opened for the harvest in October, when the bees are generally smoked out and large numbers are killed. No care is taken of the brood-combs, and insufficient supplies are generally left with the surviving bees. Sulphur is, however, not used.

Bees seem to do better in the hills than in the valley of Kashmir, the latter being too hot in summer. This may account for the great difficulty which is often experienced in keeping swarms, which sometimes desert their hive even when there is brood in it. Of five swarms which I hived this spring I lost three. The natives say that the bees go off to the hills for the summer, return in September, that they are then easier to handle, and remain contentedly during the winter. Both the swarms which I succeeded in keeping were secured by fitting queen-excluder across the entrance of the hive and retaining it there for a month. One colony left the hive two months after it had been introduced. I had examined the hive the previous day, and found it was a weak colony, there being only a small quantity of brood. The bees being quite gentle, subduers were unnecessary. Next day robbers attacked this hive. The entrance was made as small as possible, and carbolic acid solution sprinkled in front, but a day later I found the hive empty. Where Kashmir bees are kept in wooden hives there seems to be an unusual amount of fighting and attempted robbing. The local earthenware hives do not appear to attract bees, although hornets are often seen attempting to get in; but the wooden hives seem to emit an odour from their joints which attracts robbers, and sometimes even swarms.

Swarms usually issue early in the month of May. On May 4 a swarm was brought to me in a basket, which I hived in the evening, and fitted queen-excluder over the entrance. Into a second hive, on May 9, I introduced another swarm, which escaped on May 10, and some of the bees tried to enter the first hive. I floured them, and most of them were admitted. On May 11 I put another swarm into the empty second hive, and next day a swarm from a third hive settled on the front of it, and had to be removed. A fortnight later the third hive was attacked by a swarm from a fourth hive, and nearly all the colony was destroyed. On June 5 the queen of this hive was seen outside with about twenty bees round her, and on the 11th the hive was completely deserted.

I had a good deal of trouble with one swarm before it was finally lost. It was hived on May 25, with queen-excluder in front, and on the 26th somehow the queen

must have got out, as the swarm, decamped to a neighbouring mulberry-tree. We secured it, and tried to hive it in the evening, but it refused to go in, and went off again, this time to the top of the tree. On the 27th we captured it again, hiving it in the evening; but the next day it issued again, and, after attacking another hive, it bolted.

I understand that all bee-keepers in Kashmir have very similar experiences, but that they are much more frequent when English hives are used.

During the month of May and early June the honey-flow is fairly good. In one hive six frames were fully built out and occupied in one month, but in the following month hardly any work was done, possibly owing to the heat and drought which usually prevail at this time of the year. About 3 oz. of stimulating syrup per day appeared to have a beneficial effect.

Very large hornets are constantly attacking the hives. The bees come out in groups of about seven or nine, and when a hornet approaches they lower their heads and, with a peculiar quivering movement, turn their tails towards the intruder, who invariably veers off. Sometimes, however, a bee with a bolder spirit takes more decisive action. Perhaps, like Sir Nigel Loring, she regards the hornet as a "courteous and worthy person with whom some small bickering may be had." Or possibly, Marcus Curtius like, she seeks, by sacrificing herself, to save the whole community. I have seen a bee suddenly dash out from the armed circle of defenders and pierce a formidable hornet four times her own size, inflicting a fatal wound. But all are not so courageous, for one day I placed a dead hornet on the alighting-board when the sentry had gone in for a moment. A casual bee coming out for an evening walk suddenly and unexpectedly caught sight of the orange-coloured monster, gave a most dramatic start, and then hastened back to her own quarters. Whether she spread the alarming news I know not, but almost at once a fierce and stalwart worker emerged and, single-handed, seized the unwelcome intruder and threw him off the platform. In their behaviour with ants bees seem rather timid. Ignoring them unless they come quite near, they even then appear to chase them with some apprehension lest the ant should turn and seize them by the nose. No one can watch the action of sentries in front of a hive for long without coming to the conviction that there is often an interchange of intelligence between them and the returning foragers. In hot weather when supplies were scarce I noticed drones, who often disport themselves outside the hive during

the hotter part of the day, were sometimes very reluctantly admitted, and were even then treated as if they were strangers, being chased from the hive. During such weather a fall of rain, so far from stopping work, seemed to give it a stimulus, owing perhaps to the more rapid secretion of nectar in the flowers. I have been surprised to find how comparatively few varieties of flowers are resorted to by the bees. Of course, in spring the blossoming fruit-trees and fields of flowering cruciferæ are crowded, and in summer mignonette, virginia creeper, hollyhocks, and balsams appeared to possess the greatest attraction; but, curiously enough, there were very few bees to be seen working on white clover. During the hot weather, when supplies are scarce, the bees are rather bad-tempered, and an occasional undeserved sting is sometimes meted out to an observer who has been previously tolerated. In the evening, although the hive may be full, the inmates seem more gentle than in the heat of the day. The stings appear to vary considerably in intensity. Some, even when delivered deeply and strongly, produce little swelling or pain; others, inflicted lightly and in passing, as it were, have produced great irritation. It is probable that in this and many other respects Kashmir bees are very like their English relatives. It will be interesting to see whether the introduction of English or Italian queens will result in greater industry or whether their progeny, too, will succumb to the somewhat enervating influence of climate and the summer and autumn droughts.—(DR.) ERNEST F. NEVE, F.R.C.S., Kashmir, N. India, July 20.

DANGER OF SUFFOCATING BEES.

[7603.] I gain much valuable information from the publication of the experiences of bee-keepers, and trust the following may be beneficial to any reader who has occasion to confine his bees in a skep. A friend of mine had the misfortune to have an outbreak of foul brood in his apiary, and as his stocks were exceptionally strong he decided to try and save the bees, and proceeded according to instructions in "Guide Book," page 180. The bees (which crowded twelve frames) from one stock were got into an empty straw skep, a piece of coarse packing cloth (quite as open as cheese cloth) was tied over the bottom. They were then placed on two strips of wood an inch wide, standing about 2ft. off the floor in an open shed; a quick feeder containing medicated syrup was placed on top, and they were left to await their forty-eight hours' confinement. But,

alas! on going to them the following evening to see if they had emptied the feeder, it was found that out of between 40,000 and 45,000 bees only about 200 remained alive; the rest were lying on the packing-cloth in a saturated condition, having been suffocated. Now, in my humble opinion, I consider that there should be more ventilation given than stated in the "Guide Book." It may answer very well for a medium quantity of bees, but when they are extra strong in numbers I think there should be a hole cut in the roof or one in each side of skep and covered with perforated zinc or wire cloth. I am certain that had the bottom been covered with open netting or cheese-cloth very little more air could have found its way into the skep, and the fact that they were placed in an open shed did not increase the heat more than a bag or other covering would have done, which would have been needed to protect them from the weather, if left in the open.—G. MACKIE, Tewkesbury.

[The above is a melancholy illustration of want of proper judgment being exercised in such operations. To cram 40,000 to 45,000 bees, equal to a swarm of 9 lb., into an ordinary-sized skep, which we presume must have been employed, was to court disaster, and we are not surprised at the result. When bees are fed heat is generated and the cluster expands, so that it requires more room. Under such conditions open netting and even extra holes suggested by our correspondent would not have proved sufficient. For such a strong hive, the bees of which crowded twelve frames, the skep should have been at least of the same capacity as that from which the bees were taken.—ED.]

PORTRAITS OF PROMINENT BEE-KEEPERS.

[7604.] The new feature of the present volume of the B.B.J.—portraits and sketches of well-known bee-keepers—is excellent indeed, and, I am sure, just what most bee-keepers desire very much to see. The one in B.B.J. just to hand, that of Mr. Macdonald ("D. M. M."), pleases me particularly, because I look upon him as holding a premier place as a writer on bee-keeping. Ever clear, concise, and to the point, with nothing superfluous or foreign to the subject, his readers are not given the trouble of sifting the chaff from the wheat: he does the sifting himself.

Speaking of "chaff" by the way, I think the B.B.J. would be much improved if some of the writers would refrain from giving us so much of it. At any rate, the articles under comment would be more in keeping with the aim you, Mr. Editor, have in view of making it a paper devoted purely to bee-keeping.

Mr. Smallwood's racy letters are rare gems indeed, and give one a very pleasing glimpse of the romantic yet homely nature of the craft, and I hope we shall have many more from his able pen. Hoping British bee-keepers have had a most prosperous season.—H. MARTIN, Dannhauser, Natal.

A PLEA FOR THE WASPS.

[7605.] I enclose a cutting from the *Daily Mail*. You will notice that the writer says:—"Wasps feed principally on maggot-breeding insects. . . . The wholesale destruction of wasps of late years has resulted in a universal increase of maggots in fruit, insect blight on vegetables, &c." Now most bee-keepers keep either a garden, orchard, or allotment, and it would be interesting to know whether they would have wasps and clean vegetables, or no wasps and blighted vegetables, plus honey. My experience this year is that we have had both the wasps and blight, and a little honey.—W. G. C., Rugby.

"SIR,—I notice yet another letter on the subject of wasp destruction. If people wish to destroy wasps' nests, the safest and simplest way is to pour a little paraffin (not lighting it) down the holes. The wasps within are killed instantly.

"But—it is the greatest folly to destroy wasps at all. Wasps feed principally on maggot-breeding insects, and against these pests they are man's greatest allies. The wholesale destruction of wasps of late years has resulted in a universal increase of maggots in fruit, insect blight on vegetables, &c. This may be noticed everywhere. It is true wasps take toll of the fruit, but they fully earn it by the protection they accord to the whole tree. And if the rotten and overripe fruit is left for them, and not picked up and thrown away, they will keep principally to this.

"They are—shocking to relate—greatly addicted to alcohol, and this they find in the rotten fruit. I have seen hundreds of them under pear trees, crawling over the windfalls 'as drunk as lords.'

"Anyhow, for the sake of our gardens and orchards, it is to be hoped that the senseless war against them may cease. Nature knows more about it than man, and if he willfully destroys her 'balance' he must suffer."

[Wasps have been just as much of a plague with us this year as other insects, which they have not kept down, and they have done an immense amount of damage to fruit. If they confined their visits to rotten fruit, not much could be said against them; but they persistently attack fruit just before it ripens, and as

a result it soon begins to decay. We are not able to get any apricots, peaches, or greengages without protecting them, and even then wasps manage to bite through the muslin bags.—Ed.]

Bee Shows to Come.

September 16, 17, and 18, at Crystal Palace.—Surrey B.K.A. Annual Exhibition of Bees, Honey, Wax, Appliances, &c. Entries closed.

September 18 to 25, at the Agricultural Hall, London.—Honey Show in connection with the Seventeenth Annual Exhibition and Market of the Grocery and Kindred Trades. Liberal prizes. Open to all British Bee-keepers.

September 22, at Altrincham.—Honey Show, in connection with the Altrincham Agricultural Show, the largest one-day show in the Kingdom. Entries closed.

October 5 to 8, at the Agricultural Hall, London.—Show of Honey and Bee Produce in connection with the British Dairy Farmers' Association. Entries closed.

Queries and Replies.

[3970.] *Moving Bees Short Distances.*—I have five stocks in Lees' "Alliance" hives which I am feeding up for the winter. I shall have to move them about one hundred yards before the 29th inst., and shall be glad if you will tell me whether it is possible to confine them in their hives and put them in the cellar or some other cool, dark place for about a fortnight, and then take them straight to their new place, or whether it is necessary to move them two miles away for a time. I have read about bees being kept confined like this, and wondered whether it would be in any way harmful. In the B.B.J., page 343, a correspondent recommends it as a cure for robbing, and I thought it might also serve to facilitate moving. Any information you can give me will be much appreciated.—E. L., Kent.

REPLY.—It is possible in cool weather, by confining the bees in a cellar for at least five days, to move them short distances, but there is always a risk of some of them returning to the old spot when released. Tack a wire cloth over the entrance, provide ventilation on the top, and be sure that the cellar is quite cool, or the bees are likely to be restless, and become suffocated as a consequence. The safest plan is to take the bees one and a half to two miles away, and, after leaving them there for two or three weeks, to bring them back to the spot you wish them to occupy.

[3971.] *Honey and Smoky Atmosphere.*—I am sending you per separate packet parcel post a section of honey I took from a stock I purchased this spring. The sections were put on on June 4 and taken off Sept. 2. As you will see, the honey is very dark—in fact, almost black—and is more like treacle than honey. In my opinion it also has a "nip" in taste. Is this wholly due to honey-dew, or is it in part due to the very smoke-laden atmosphere we have in this district? We are practically surrounded by coal-pits and large steel works. My hives, of course, are situated inside the Estate Policies, close to the Mansion House Gardens, and are standing in a mixed orchard (thirty-seven acres) of apple, pear, plum, and damson trees. The orchard lies down to the River Clyde, on the opposite side of which there is agricultural land under cultivation—corn, barley, wheat, beans, and hay, as well as the usual green crops, potatoes, and turnips. I shall be interested to know what your opinion is, and whether you

think the smoky atmosphere has anything to do with the dark colour. Certainly the sections were on for a very long time, but we have had such an exceptionally bad season this year that the bees had little chance of doing much. I have three hives, one stock and two of last spring's swarms, and I only got twenty-four sections off the stock hive, of which the sample is one, and the swarms did not, in many cases, go up into the sections, and where they went up they did little or nothing in the way of "pulling out" the sections. I am of the opinion that, given a good season, I ought to get a fair harvest even here, as, in addition to the orchards and fruit, flower, and vegetable gardens, there are a large number of lime, chestnut, beech, and privet trees close to my hives.—J. G. W., Motherwell, N.B.

REPLY.—Your section arrived smashed in the post, but the honey is rather thin, dark, and of a reddish colour. We do not think the smoky atmosphere has anything to do with the colour, as there is no taste of smokiness, and the dark colour is due partly to the dominant pasturage and honey-dew. You seem to be situated in a capital district as regards pasturage, and in a better season you should have a good harvest.

Notices to Correspondents.

J. E. (Sutton).—*Dwindling Stock.*—1. As your colony has nearly filled two racks of sections it must have been pretty strong. As there is now scarcely any brood, the queen has either ceased to lay with the end of the honey-flow or is a defective one. Bees on the ground unable to fly would indicate weakness or disease, which can only be recognised by the general behaviour of the colony, and we are not able to tell from a few live bees, which appear perfectly healthy. 2. Yes; you can do away with the queen, and try uniting driven bees with a young one as you suggest. 3. As you are now feeding you will be able to see if this has induced the queen to start laying again.

HEREFORD (Peterchurch).—*First Swarm from Swarm.*—The old queen usually leaves with the first swarm.

CANDY (Leicester).—*Overtaking with Naphthol.*—Remelting would evaporate some of the spirit, but the extra dose of naphthol which you have inadvertently put in, although it might not hurt the bees, owing to its bitter taste, probably prevent them from taking it down. It would be better to make another lot, omitting the naphthol, and remelt what you have made, adding it to that freshly made, as it will keep if stored in a dry place.

E. G. G. (Hinckley).—*Ripening Honey.*—1. Honey already capped, if extracted and put in a honey-ripenner and kept at a temperature above 80 deg. for a few days, will then be ready for putting into jars. It will ripen as well in the ripener as if kept in the hive until the end of the season. 2. Shallow frames can be extracted as soon as the combs are capped over.

G. T. H. (Bradford-on-Avon).—*Wintering Bees.*—1. If the naphthol beta is pure, the solution made correctly and added to the syrup when still hot, there should be no such bitter pellets as you describe. We have never encountered this trouble with the drug we employ. 2. In the paragraph you allude to on wintering, 1½ in., in line eight, should be 1½ in. The chapter on wintering in "Guide Book" seems so clear that if you will state what is not quite lucid to your mind in the paragraph you mention we will endeavour to explain it.

S. E. JOHNSTONE (Birmingham).—*Honey Showing.*—We do not publish letters which have already appeared in other papers. The letter which you send with your signature is word for word an

- exact copy of one which appeared in the *Oswestry Advertiser* of September 1, and which was signed by F. E. Holmes, The Nursery, Welshpool.
- E. B. (Golborne).—*Hives in Bee-house*.—It would be no detriment to the bees if the hive were placed so that the entrance is at the corner instead of the middle.
- GLYN (Pontypool).—*Wintering Bees*.—1. Lift brood-chamber and place eke on floor-board, then put the former on this, turning up the lugs to keep it in position. It is simply to give a 3 in. space under the frames. 2. The empty combs are part of the eight frames mentioned. 3. The rapid feeding should precede the arranging of the frames, as otherwise you would not know how the combs were filled. Those containing most stores should always go on the outside. 4. If you have no empty combs place those containing the least stores in centre, and if the bees are strong they will soon have empty cells to cluster on.
- A. G. (Essex).—*Detecting Honey-dew*.—1. The only way of detecting honey-dew is by the taste and observing the aspect of the honey. When present honey is not only darkened in proportion to the amount of honey-dew it contains, but also becomes cloudy and of a dirty appearance. Honey-dew does not interfere with the density of honey. All dark honey, however, does not contain honey-dew, and if the former is clear and bright, the colour may be due simply to the pasturage. 2. You can place your hives at any height most convenient to yourself, so long as you have large alighting-boards.
- E. J. L. (Merioneth).—*Dead Bees in Super*.—1. The comb from super is quite new, has not been bred in, and contains nothing but beautiful clover honey, most of it being unsealed. The bees are dry and look all right, but their wings are ragged, and among them there are cocoons and grubs of wax-moth, showing that the hive is infested with these. The probability is that the opening in skep over which you put the excluder was too small to admit of the free passage for the bees, as well as for sufficient ventilation. 2. There is no bee-association in your county, but the Cheshire and the Shropshire are the nearest to you, or you could join the British B.K.A. 3. The honey in skep is quite safe for the bees, but you should turn up the hive and see what the condition of the combs is, and whether wax-moth have gained a footing, in which case the bees should be got out of the skep as soon as possible.
- MAC (Pontnewydd).—*Parasite on Bees*.—The insect is *Braula caeca*, or blind louse, a full description of which is given in chapter on "Enemies of Bees" in "Guide Book." They irritate the bees, and in that way are detrimental, but they usually die off in the winter in this climate. Fumigate the hive with tobacco-smoke, which will dislodge them, and they will drop on to the floor-board, when they can be swept off. As an additional precaution the floor-board should be washed with a solution of carbolic acid.
- H. G. MACE (Essex).—*Beginner's Experiences*.—1. It is quite probable that during the inclement weather we had the honey in the sections diminished. 2. In course of time you will get used to stings, and take no notice of them. 3. The queen of your driven bees will lay if they are liberally fed. 4. You will find a list of the principal honey-producing plants and trees on page 159 of "Guide Book." Of those forest trees you mention, the useful ones are the crab, maple, lime, sycamore, and chestnut. 5. Among the shrubs sloe and hawthorn, as well as brambles, are good. 6. Certainly it is worth putting on supers for the early-flowering trees if the colonies are strong enough. 7. You will find instruction as to stimulation on page 109, where and how to do it. 8. You may see different varieties of bees in private collections or at the Natural History Museum in London. 9. Instructions for finding the queen are on page 136.
- LOWER WARD (Renfrewshire).—*Bee-keeping in South Africa*.—If you will apply to Miss M. D. Sillar, Grootoler Government Experimental Farm, c/o Department of Agriculture, Bloemfontein, O.R.C., South Africa, you will get the information you require respecting that colony. Miss Sillar is the bee-expert in connection with the Department of Agriculture, and would know the prominent bee-keepers in the Orange River Colony.
- MEL ROSÆ (Isle of Wight).—*Bees Working on Heather*.—Heather half a mile away is quite within the reach of the bees.
- H. A. V. (Rye).—*Queenless Colony*.—1. If you find no queen, and drones are present, it is generally a sign at this time of the year of queenlessness. Unite with another lot having a queen, as your stock appears very weak. If you could introduce frames of hatching-brood you could give them a queen (see page 141 of "Guide Book"). 2. You should feed as rapidly as possible now (see page 112) and stimulative feeding should be discontinued.
- A. A. R. (Erpingham).—*Dead Bees in Super*.—1. The bees which clustered on the comb while it was standing out were strangers, and when you opened slide on clearer the bees of the hive attacked them. They were not attacked when outside, because they and the proper inmates of the hive were busy filling themselves with sweets. Probably the mouth of escape was choked with dead bees, and the others were not able to get through. 2. If the bees are not able to escape rapidly, numbers of them are frequently found dead on super-clearer. The dead bees may also be the result of fighting.
- J. S. (Cumberland).—*Fertile Workers*.—A colony having a fertile queen rarely tolerates a fertile worker, so that it is very probable, as you have succeeded in introducing a queen and she is already laying, that the colony will now resume its normal aspect.
- S. M. (Surbiton).—*Feeding Bees with Honey*.—If the honey is very thick add a small quantity of water, otherwise it is not necessary. Good's candy can be used in spring.
- SALOPIAN (Shrewsbury).—*Parasites on Queen*.—The queen was evidently in a bad way, as there were over thirty *Braula caeca* about her. Certainly the hive should be fumigated before introducing a new queen. See reply to "Mac."
- W. T. (High Bickington).—*Wax-moth*.—The specimens sent are the wax-moth, *Galleria cereana*, described on page 165 of "Guide Book."
- MRS. G. M. (Beaconsfield).—*Race of Bees*.—1. Black with a trace of Italian blood in them. 2. Young black queen.
- C. M. (Dobcross).—*Pollen in Comb*.—There is nothing the matter with the comb sent. Some of the cells contain pollen which has been stored by the bees for future use.
- E. S. (Timperley).—*Leaving Supers during Winter*.—As there is no honey in brood-chamber, you had better remove super and feed up as rapidly as you can (see page 112 of "Guide Book"). If you decide to leave on the super you must remove excluder, but you must take the chance of your bees not getting to the stores or taking up their quarters in the super.
- TORQUAY (Devon).—*Partnership Agreement*.—Everything depends on agreement made. Partners usually agree to share all losses as well as profits, and unless there is any special clause making either liable for neglect the other would have no redress.
- F. B. (Caine).—*Race of Bees*.—1. Italian hybrids. 2. The only way to keep moth out of hives is to

have the colonies strong and transfer the frames into clean hives in the spring and autumn, so as to give the moth no chance of getting a footing.

NOVICE (Edmonton).—*Bee-district*.—The neighbourhood of Bournemouth is a fair honey-district, but not good enough for commercial bee-keeping.

SCATTERGOOD (Herts).—*Bee-keeping in the Isle of Man*.—This is considered a good district. Mr. T. J. Horsley, Empire Terrace, Douglass, would give you the information you ask for.

H. W. L. (Wolverhampton).—We do not know who would purchase your honey, but if you advertise it you would probably find a customer.

Honey Samples.

N. (Cheshire).—Honey is thin and of poor quality. The strong rank flavour spoils it for table use.

NOVICE (Berwickshire).—Light honey of good colour, but thin in consistence, and becoming cloudy from incipient granulation. If thicker it would be a good show honey, but would have to be relievied before exhibiting.

J. JESSOP (Nottingham).—The "greenish colour" is usual with lime honey, of which yours is a sample. Some people like the strong flavour of limes, and would not consider it "poor," though it cannot be classed as a first-class honey.

H. W. R. (Cattford).—Nice honey of good colour and flavour from clover and limes. It is quite ripe and in good condition. We are pleased to hear of your success.

D. J. (Ruabon).—The honey is quite spoilt by honey-dew, which is the cause of the black colour. It is not wholesome for bees in winter, being apt to cause disease, and would only be saleable for manufacturing purposes.

W. J. M. (Lawton).—Honey is from limes, and very thin, though fairly good in other respects.

P. P. W. (York).—The section was smashed in post, but the honey, though dark, has a pleasant enough flavour. Probable source sycamore and other tree-blossoms; no honey-dew. All winter stores should be sealed, therefore you should feed without delay in order that this may be accomplished before cold weather sets in.

J. C. (Blackheath).—The honey from limes, though better than your last sample, is hardly up to show standard.

ASHGROVE (Breccon).—Thick dark honey from tree-blossoms principally. The flavour is fair, but quality is not improved by a slight trace of honey-dew which it contains.

T. GILLET (Nottingham).—Sample is spoilt by honey-dew, which is the principal cause of the bad colour. It also has a slightly bitter taste. No precautions or care will prevent bees gathering honey-dew in seasons like the present one.

W. S. (Clitheroe).—The honey is of good consistency and colour, and is gathered from mixed sources.

IZAL (Grosmont).—1. It only contains a trace of honey-dew, being principally from flowers of bean and privet. 2. Quite fit for human food. 3. Yes, you can work some into the candy.

RAMMILL (Lancs.).—Honey of fair quality slightly discoloured by honey-dew. Quite fit for use.

E. M. H. (Lyth Hill).—Honey of good consistency, bean and privet principally. Honey-dew is found on the leaves of oak and other trees, and is caused by aphides piercing the leaves. A small quantity darkens honey, but is not injurious. In large quantities it gives the honey an unpleasant, bitter taste.

M. A. (Bardon Hill).—No. 1 is too thin; No. 2 of good consistency, and both have a trace of honey-dew. No. 2 would be good for table use, but No. 1 should be used for feeding bees.

CYMRU (N. Wales).—From mixed sources; it is granulated, and contains honey-dew. It would be fit for table use if there is no objection to its strong flavour.

W. P. P. (Kidsgrove).—Good, but thin, light-coloured honey, with a saffron flavour.

LOUPDOWN HILL (Galston).—Your honey was probably not dark enough for the class in which it was entered. It is, however, very good, although a trifle dark, and quite fit for table use. It is principally gathered from beans and clover.

BR. COLUMBAN (Devon).—The honey is quite fit for table use, and contains only a trace of honey-dew, not sufficient to affect the flavour. Mixed source, principally apple and lime.

W. S. W. (Co. Durham).—1. No. 1 is the best and could be shown; No. 2 is too bitter. 2. The wax, if clarified, would be fit to show. 3. You must take the word of the dealer, as it is impossible to tell for certain without analysis if the sugar is cane or beet. It has the appearance of the latter, and we should hesitate about using it without a guarantee.

Suspected Combs.

R. S. H. (Wanstead).—It is a very bad case of foul brood in an advanced stage.

E. F. (Eastbourne).—Commencement of black brood.

X. Y. Z. (Bucks.).—The stock is apparently suffering from black brood. Treatment is similar to that used in cases of ordinary foul brood, as the two diseases are alike in some respects, and both are highly contagious. If you have a copy of "Guide Book" refer to page 182 for particulars of this disease.

*** Several important letters, &c., are in type, but held over from pressure on our space.*

Special Prepaid Advertisements.

Twelve words and under, Sixpence; for every additional Three words or under, One Penny.

FOR SALE, Simmins' Double "Conqueror" Hive, latest, dissolving partnership.—Osborne Gardens, Torquay, Devon. u 38

YE OLDE ENGLISH BEES, healthy, strong lots, with fertile Queen, on rail, 4s.; young fertile Queens, in Introducing Cage, 2s.—MISS EMILY SOLE, Stotfold, Baldock, Herts. u 37

PURE WELSH HONEY, in 56 lb. tins, 31s.; sample, 3d.—G. THOMAS, Coedmelyn, Stackpole, Pembroke. u 21

25 STOCKS BEES FOR SALE, 8 and 10 frames, 2 Section Crates with each box, zinc covered roofs, healthy.—STONE, Enford, Pewsey, Wilts. u 22

PURE ENGLISH HONEY, 56s. cwt. Sample, 2d. Quantity of Sections.—BANHAM, Lilac Cottage, Westmere, Petersfield. u 30

DRIVEN BEES, free from all diseases, with young laying Queen, safe delivery, 5s. 6d. per lot, box free; young laying Queens, post free, 2s. 9d. each.—THOS. BRADFORD, Certificated Export, Worcester. u 32

HEALTHY DRIVEN BEES, with fertile Queens, 5s. per lot.—SHELDON, Monmouth. u 34

WANTED, "Bingham" Smoker, Bee Literature, Wire Veil, cheap.—H., Herbrandston Rectory, Milford Haven. u 31

FOR SALE, 2 Stocks, in "W. B. C." Hives, guaranteed healthy, £1 each.—J. GLADDING, Castle Rising, King's Lynn. u 35

FOR SALE, 4 Stocks of Bees, in Frame Hives. No reasonable offer refused.—T. BOLTON, Fernlea, Hayes, Kent. u 33

Editorial, Notices, &c.

BRITISH BEE-KEEPERS' ASSOCIATION

A meeting of the Council was held at 105, Jermyn Street, London, S.W., on Thursday, September 16. Present: Mr. Thomas W. Cowan (in the chair), Mr. C. L. M. Eales, Rev. H. R. N. Ellison, Mr. O. R. Frankenstein, Mr. H. Jonas, Mr. J. B. Lamb, Mr. John P. Phillips, Mr. Arthur G. Pugh, Mr. W. F. Reid, Mr. Arnold Richards, Mr. G. H. Skevington, and Mr. E. D. Till. Letters were received from Mr. R. T. Andrews, Mr. E. Garcke, and Mr. E. Walker regretting their inability to attend.

The minutes of the last meeting were read and confirmed.

Four new members were elected, viz.: Mr. C. B. Bartlett, 59, Corn Street, Witney, Oxon; Mr. Revill Anthony Fairclough, 25, Kensington Palace Gardens, W.; Mr. H. John L. Lambert, The Vicarage, Weeton, Leeds; and Mrs. Elsi Russell, Canema, Crockenhill, Swanley.

Mr. J. B. Lamb presented the report of the Finance Committee, which showed that the accounts had been examined and that the balance at bank on September 15 amounted to £121, against which they had passed cheques for payment to a total of £14 12s. 11d. He also reported that since the last return made on July 15 1,677 hives of bees had been insured, making the total of hives insured for the year 10,181, totalling in premiums £57 0s. 9d. The report was adopted.

Reports upon examinations of candidates for third-class experts' certificates, held in Somerset, Bedfordshire, Kent, Lincolnshire, Worcestershire, Northants, Middlesex, Yorkshire, Shropshire, and Notts, were received, and certificates were awarded to the following:—Revs. A. C. Murray and G. E. Pratt-Pratt, Messrs. C. J. Adams, T. W. Atlay, J. L. Brierley, John Brown, E. G. Drew, W. B. Dennis, T. Fowle, A. G. Gambrill, A. Griffin, A. Gilman, G. E. Horwood, F. Harborne, G. W. Judge, H. S. Keighley, E. R. Knight, J. F. Lang, J. C. Longstaffe, R. Litman, R. Mackender, F. Morgan, J. W. Mason, J. C. Roberts, Mark S. Rothwell, W. Randall, J. Roper, W. Reynolds, S. Simmons, W. J. Smith, A. C. Thompson, M. Thomas, H. J. Willoughby, F. W. Watts, U. Wood, J. H. Willmott, W. E. Whitehouse, W. J. Wooley, Ellis Wright, H. J. Witt, W. F. Wiemann, Misses H. Byles, D. Giles, G. Mortimer, M. E. Rowntwaite, M. Sowerby, M. A. Shuttleworth, and E. M. Willoughby.

Mr. J. B. Lamb was nominated and appointed as an examiner for third-class certificate candidates at an examination to be held in London on September 25.

Letters from the Canterbury (New Zealand) Bee-keepers' Association, Pretoria Bee-keepers' Association, and the South African Bee-keepers' Association, with regard to affiliation and examinations, were discussed. The Chairman stated that he had had some correspondence with regard to the approval of examiners for conducting the examinations in South Africa for the Association's certificates for third-class experts, and it was decided that, provided application for the examination were received in the usual way, the nomination of the persons suggested would be approved of. The Chairman also reported that he had had correspondence with the Natal Bee-keepers' Association, who wished to know under what conditions certificates would be granted to their members in the event of the association not affiliating with the South African B.K.A., and he was requested to inform them that the conditions would be the same as those for the S.A.B.K.A.

The Council decided to keep open the W. B. Carr Memorial Fund for the reception of subscriptions until the end of October, and the Conversazione was fixed to be held at 105, Jermyn Street, S.W., on the Thursday of Dairy Show week, October 7, at 5.30 p.m.

A candidate for first-class expert certificate then proceeded to lecture before the Council on a subject connected with bee-culture, but failed to deal with the subject to the satisfaction of the Council, and the secretary was instructed to write accordingly.

Correspondence with the Suffolk Bee-keepers' Association, urging the Council to approach the Board of Agriculture on the necessity of an Infectious Diseases Notification Bill being brought before Parliament, was discussed; but, in view of past experience in this direction, no action at present was deemed advisable by the Council.

The next meeting of the Council is to be held on October 7.

THE GROCERS AND KINDRED TRADES' EXHIBITION.

HONEY SHOW AT THE AGRICULTURAL HALL.

The seventeenth International Exhibition of the Grocers and Allied Trades was opened on Saturday, the 18th inst., and continues during the present week. We must defer until our next issue the report of the honey section, but both the quality and number of the exhibits staged reflect great credit on British bee-keepers. Messrs. T. W. Cowan and Ernest Walker officiated as judges, and made the following awards:—

Outfit for a Beginner in Bee-keeping.—1st. J. Lee and Son, 4, Martineau Road.

Highbury, London; 2nd, Mrs. Seadon, The "S.J.B." Apiary, Bromley.

Display of Honey and Honey Products, shown in Suitably Attractive Form for a Tradesman's Window.—1st and B.B.K.A. silver medal, Jas. Lee and Son; 2nd, J. Pearman, Penny Long Lane, Derby; 3rd, C. Radway, Somerford Keynes, Cricklade, Wilts; 4th, Mrs. Turner, Broadway, Amersham; h.c., Mrs. Seadon; c., Mrs. Seadon.

Twelve 1-lb. Sections.—1st and B.B.K.A. bronze medal, J. G. Nicholson, Langwathby, Cumberland; 2nd, R. H. Baynes, 51, Bridge Street, Cambridge; 3rd, W. Woodley, Beedon, Newbury; 4th, J. Pearman; 5th, A. Willmott, Lyndhurst, Stanstead Abbots, Herts; v.h.c., Jas. Lee and Son; A. Barber, Comberton, Cambs; h.c., R. Brown and Son, Somersham, Hunts; c., W. Patchett, Cabourne, Caistor, Lincs; A. G. Brocks, Nether Wallop, near Stockbridge, Hants.

Twelve 1-lb. Sections Heather Honey.—1st, W. Dixon, 27, Central Road, Kirkgate, Leeds; 2nd, J. Pearman; 3rd, A. Young, 34, East Street, Chatham.

Three Shallow Frames Comb Honey.—1st, Jas. Lee and Son; 2nd, J. Herrod, The Manse, Sutton-on-Trent, Newark; 3rd, F. G. Hales, Wellow, near Bath; v.h.c., E. C. R. White, Newton Toney, Salisbury.

Twelve 1-lb. Jars Light-coloured Extracted Honey.—1st and B.B.K.A. certificate, M. R. Lloyd, 8, Norwich Road, Thetford, Norfolk; 2nd, Mrs. Turner; 3rd, R. Morgan, Cowbridge, Glam.; 4th, T. G. Hiller, Hurstbourne Tarrant, Andover; 5th, E. Church, Masonic Temple, Cardiff; v.h.c., H. W. Saunders, 43, Croxton Road, Thetford; W. B. Talent, Diseworth, Derby; H. E. Pugh, Beech House, Beeston, Notts; W. Woodley, Beedon, Newbury; h.c., G. Braddick, 4, Mortimer Road, Cardiff; R. Brown and Son; c., R. H. Baynes; J. Waterfield, Kibworth, Leicester; E. W. Sherwood.

Twelve 1-lb. Jars Medium-coloured Extracted Honey.—1st, G. Marshall, Norwell, Newark; 2nd, R. H. Baynes; 3rd, J. Herrod; 4th, F. W. Frusher, Swiss Apiary, Crowland, Peterborough; v.h.c., J. Southwell; J. Birch, Up Down Hill, Hindlesham, Surrey; C. Billson, G.N. Station, Melton Mowbray; h.c., G. Thomas, Mrs. Harris; c., E. C. R. White, A. J. Brocks, J. Pearman.

Twelve 1-lb. Jars Dark Extracted Honey.—1st, T. Marshall, Ivy Cottage, Sutton-on-Trent, Newark; 2nd, A. Young; 3rd, J. Southwell, Hockerley Green, Hockerley, Romsey, Hants; v.h.c., R. Brown and Son; J. Best, Trewood Apiary, St. Austell, Cornwall; h.c., A. Barber, F. W. Frusher; c., A. S. Hoare, Trerolaid, Saltash; E. C. R. White.

Twelve 1-lb. Jars Heather Honey.—1st, G. Hunt, 66, Hawton Road, Newark; 2nd, J. Pearman; 3rd, T. Sleight, Danesmoor, Chesterfield; v.h.c., Burn and Botham, Phenix House, Whitby; A. Young, T. Marshall; h.c., H. Waddington, Kirby Hill, Boroughbridge, Yorks; H. Slator, Stretton, Alfreton; c., W. Dixon.

Twelve 1-lb. Jars Heather-blend Honey.—1st, J. Pearman; 2nd, A. Young; 3rd, W. Dixon; 4th, G. Hunt; v.h.c., J. T. Willson; A. S. Dell, Leigh, Lancashire; h.c., A. G. Pugh, Notts.

Twelve 1-lb. Jars Granulated Honey.—1st, A. W. Weatherhogg, Willoughton, Lincoln; 2nd, G. Harrison, Willoughton, Lincoln; 3rd, T. Marshall; 4th, J. T. Willson, York Villas, Shirebrook, Mansfield; v.h.c., J. Lee and Son; R. Godson, Tothill, Alford; h.c., E. C. R. White; J. G. Nicholson; W. Patchett; c., Mrs. Seadon, F. W. Frusher, J. Pearman.

Beeswax in Cakes (quality of wax, form of cakes, and package suitable for retail counter trade).—1st, Goodburn Bros., Rock Road, Millfield, Peterborough; 2nd, Mrs. Harris, High Ferry, Sibsey, Boston; 3rd, J. Pearman; 4th, F. W. Frusher; v.h.c., J. Lee and Son, E. C. R. White; h.c., Mrs. Seadon, J. Berry; c., F. Coates, Emin, Cirencester.

Beeswax (judged for quality of wax only).—1st, A. Hiscock, Loddington, Kettering; 2nd, E. C. R. White; 3rd, J. Berry; 4th, J. Lee and Son; v.h.c., Goodburn Bros.; J. Trineman, Bridgend, Lostwithiel, Cornwall; F. A. Kent, Dorchester; h.c., W. Patchett, Mrs. Harris; c., Mrs. Lockwood, Nazing, near Waltham Cross, Essex.

HONEY SELLING CLASSES.

Extracted Honey in Bulk.—Certificate, G. Thomas, Coedmelyn, Stackpole, Pembroke.

Extracted Honey in 1-lb. Jars.—Certificates of merit awarded to:—A. Gibbs, Bartlow, Cambs; H. D. English, The Chestnuts, New York, Lincs; Mrs. Williams, New Row, Pwllheli, North Wales; J. Rowlands, Maes Apiary, Pwllheli.

1-lb. Section of Comb Honey.—Certificate, J. Rowlands.

SHROPSHIRE B.K.A.

ANNUAL SHOW.

The above exhibition was held on August 18 and 19 at The Quarry, Shrewsbury, in connection with the Shropshire Horticultural Society's Great Floral Fête. The display of bee-products was very creditable, taking the fact into consideration that the season has been one of the worst experienced in the district during the last eighteen years. The silver medal

of the B.B.K.A. was secured by Mr. J. Clay, the bronze medal by Mr. S. Cartwright, and the certificate by Mr. P. Jones. The Rev. T. J. Evans held an examination for third-class experts' certificates on the second day of the show, at which four candidates presented themselves.

The Rev. T. J. Evans, Rock Ferry, and Mr. T. D. Schofield, Alderley Edge, officiated as judges, and made the following awards:—

OPEN CLASSES.

Twenty-four 1-lb. Sections.—1st, J. Carver, Wellington; 2nd, J. Cartwright, Shawbury.

Twelve 1-lb. Sections.—1st, J. Evans, Bromstead, Staffordshire; 2nd, J. G. Nicholson, Langwathby, Cumberland; 3rd, Miss Wilson, Camfield, Essex.

Twenty-four 1-lb. Jars of Extracted Honey.—1st, E. Church, Cardiff; 2nd, J. Carver; 3rd, A. Hamer, Mumbles.

Twelve 1-lb. Jars Extracted Honey.—1st, J. Boyes, Cardiff; 2nd, J. Carver; 3rd, G. F. Braddick, Pontcanna.

Twelve 1-lb. Jars Medium-coloured Honey.—1st, J. Carver; 2nd, W. Trine-man, Saltash, Cornwall; 3rd, J. W. Mason, Orleton, Pembroke.

Twelve 1-lb. Jars Dark Honey.—1st, W. Trine-man; 2nd, A. S. Hoare, Trevol-lard, Cornwall; 3rd, A. Hamer.

Single Jar Extracted Honey.—1st, R. Morgan, Cowbridge, Glamorgan; 2nd, J. Carver; 3rd, F. Harris.

Single 1-lb. Section.—1st, J. Carver.

MEMBERS' CLASSES.

Twenty-four 1-lb. Sections.—1st, Jas. Clay, Wellington.

Twelve 1-lb. Sections.—1st, J. Clay; 2nd, J. Bright, Cradington; 3rd, T. Crox-ton, Hope Bowdler.

Twenty-four 1-lb. Jars Extracted Honey.—1st, S. Cartwright, Shawbury; 2nd, Mrs. Powell, Langley, Shawbury.

Twelve 1-lb. Jars Extracted Honey.—1st, P. Jones, Church Stretton; 2nd, Mrs. Powell; 3rd, E. Brookfield, Myddle.

Twelve 1-lb. Jars Medium-coloured Honey.—1st, P. Scott, Broseley; 2nd, J. Clay; 3rd, Miss A. M. Davies, Waters Upton.

Twelve 1-lb. Jars Dark-coloured Honey.—1st, N. Wilthew, Knockin; 2nd, F. W. Smallwood, Ford; 3rd, Mrs. Powell.

Twelve 1-lb. Jars Granulated Honey.—1st, N. Wilthew; 2nd, P. Jones.

COTTAGERS' CLASSES.

Twelve 1-lb. Sections.—1st, E. Brook-field, Myddle; 2nd, W. Passant, Bas-church; 3rd, J. Hammond, Hope Bowdler.

Twelve 1-lb. Jars Extracted Honey.—1st, L. Powell, Longley; 2nd, W. Pas-sant; 3rd, W. Rowley, Bomere Heath.

Twelve 1-lb. Jars Extracted Honey.—

1st, F. H. Frost, Ellesmere; 2nd, E. Brayne, Shrawardine; 3rd, L. Powell.

Six 1-lb. Sections.—Equal 1st, T. Crox-ton, Hope Bowdler, and J. Bright, Card-ington.

Single 1-lb. Section Comb Honey.—Equal 1st, T. Croxton and J. Bright.

Twelve 1-lb. Jars Extracted Honey.—1st, R. Blakemore, Bayston Hill; 2nd, P. Glover, Bicton; 3rd, G. Croxton, Grinshill.

Six 1-lb. Jars Extracted Honey.—1st, R. Blakemore; 2nd, J. Chetwode, None-ley; 3rd, R. Jones, Bomere Heath.

Single 1-lb. Jar Extracted Honey.—1st, R. Blakemore; 2nd, J. Chetwode; 3rd, J. Bright.

Display of Honey.—1st, J. Carver; 2nd, P. Scott.

HIVES AND APPLIANCES.

Hive.—1st and 2nd, Little and Cooper, Shrewsbury.

Collection of Appliances.—1st, Little and Cooper.

Bee-scar.—1st, R. Morgan; 2nd, G. Evans, Bromstead; 3rd, H. W. Saunders, Thetford, Norfolk. — S. CARTWRIGHT, Hon. Sec.

HONEY IMPORTS.

The value of honey imported into the United Kingdom during the month of August, 1909, was £4,459.—From a re-turn furnished to the BRITISH BEE JOURNAL by the Statistical Office, H.M. Customs.

Correspondence.

The Editor does not hold himself responsible for the opinions expressed by correspondents. No notice will be taken of anonymous communications, and correspondents are requested to write on one side of the paper only, and give their real names and addresses, not necessarily for publication, but as a guarantee of good faith. Illustrations should be drawn on separate pieces of paper. We do not undertake to return rejected communications.

NOTES BY THE WAY.

[7606.] *Preparing for Winter.*—A fortnight ago I advised getting stocks fed up for winter and the following spring, and to-day I repeat the advice, and remind the laggards in bee-work that the season for preparing stocks fit to pass through the winter, and give a good account of themselves another year, is fast passing away.

Wasps are very numerous again this season, and the persistent way they dodge about the entrances of hives, seeking admission for a taste of the honey if they can manage to pass the guards, is amusing, especially when the bees bundle them out and off the alighting-board without ceremony. I suffered quite a loss through their depredations, caused by my placing

a number of clearers on the hives, and when taking the honey off the following day I must have missed or forgotten one rack on which I had left only one quilt and a thin wrap. The wasps gnawed a hole through the covering, reached the honey, and quite spoiled some fifteen finished sections, besides six at the ends, which they cleared out also. Since having this experience I have been more careful to wrap up the racks of sections very carefully until removed from off the clearing-board.

After reading Mr. A. Griffin's account of his "Remarkable Stock" (page 357) in the B.B.J. of September 9, I should like to mention a case in my own apiary. A driven lot of bees last season were put on six full combs of honey, the centre three combs having brood-space but no brood. These wintered well on six frames, and early in May I gave a full sheet of wired foundation, and later another full sheet wired, the whole being confined by two packed dummies, which gave plenty of supering room. At the end of May I placed a super of twenty-one sections on the hive, and in June another rack under the first one. In July I took off the first full and sealed to the ends, and gave a third rack, which this little stock on eight frames has filled, the sections being all sealed and saleable. My ten, eleven, and twelve frame stocks have not done better; in fact, only two or three have done as well. I shall perpetuate that strain next year by breeding from them.

Those bee-keepers who have had a poor "take" of super honey should examine their brood-combs. Probably during those twelve days' hot weather in August the bees may have filled the brood-frames to the bottom bar. If this is so, one, or possibly two, frames at the back or side can be spared by the bees. Move the dummy up close, and winter on the nine or the eight frames. Next spring, in May, give frames of wired foundation in centre of the brood-nest; it is a good plan to do this every year. The new combs will be filled with brood, and the brood-combs are kept in fairly new condition.—W. WOODLEY, Beeton, Newbury.

CURRENT TOPICS.

[7607.] *Comb-foundation* (second par., page 317).—Mr. Crawshaw's opening sentence hits the nail so fairly and squarely on the head that he has driven the point clean out of sight. Probably that is the reason he fails to see any "point"! However that may be, I do not propose to pursue the subject further at present, but hope at some future time to go into it more fully. At the same time, I am pleased to see my main idea reinforced by so practical a bee-keeper as Mr. W. Woodley.

Leveling Hives (page 317).—I can scarcely add anything to what I said in my last letter on this subject, except to remark that levels which will not detect a variation from level of $\frac{1}{8}$ in. in 20 in. are in need of readjustment!

Swarms and F.B.—I think Mr. Crawshaw will see, on further reflection, that it is almost impossible to give the positive proof in this matter that he seems to require. Mr. Crawshaw will allow that there are many things in bee-keeping about which we must take the "probabilities," the direct and absolute proof being either extremely difficult or, at present, quite unattainable. One might build a large flight-room, isolate swarms therein known to have issued from diseased stocks, use only *new* appliances in their manipulation, find that they developed the disease, and then have the objection raised that air-borne spores entering the room from without might have caused its development. I mention this suppositional case merely to show the extreme difficulty of giving proofs which shall satisfy everyone. On the other hand, my experience with swarms from diseased stocks leaves no doubt in my mind that they *do* take the disease with them, and, therefore, I expressed none. If Mr. Crawshaw will turn to page 119 of "A Modern Bee-Farm" he will see that Mr. Simmins is of the same opinion *re* natural swarms.

Cone-escapes in Roofs (page 343).—None of these ordinary short cones are effective in excluding robber-bees and wasps. Bees on robbing bent have little difficulty in finding a hole at apex of cone, and wasps have *none at all*. The only really efficient cone-escape is one fitted with springs like the "Porter" "house" escape.

Swing Windows in Honey-houses (page 343).—These are by no means a very practical arrangement. In the first place, they must be fairly close-fitting all round—in order to exclude bees—and this makes them liable, in damp weather especially, to stick fast, in which condition they are not merely useless (for the time being), but a most vexatious nuisance to boot. The chief reason against their use, however, is that they are non-automatic. It will be safe to say that by far the larger number of bee-keepers in this country are away from home during the day, and should such a one remove his half-dozen supers before breakfast he has no time to do more than set them on the bench in the honey-house and, if he be wise, lock the door; then, breakfast over, he is off to business. The window, of course, remains closed till his return, and, pending that time, the few scores or hundreds of bees left in his supers are as much con-

fined to the room as though the window were a fixed one. The swing window is, therefore, with him practically inoperative. If we turn now to the large bee-keeper who is most of (or all) his time at home, he certainly will not be so unwise as to use a swing window (or windows) in his honey-room or workshop requiring considerable personal attention, when he can just as easily arrange a device which shall be self-acting and always ready for work. One very good arrangement would be to have a screen of stout wire-cloth fixed to the frame outside, projecting above it, leaving a bee-space at the top, or with two or three "Porter" "house" escapes at the highest points, as recommended by Messrs. Root; on the inside a sliding window running in grooves, the panes to be in one piece from top to within $\frac{1}{2}$ in. of bottom rail, which could be closed over the opening when required, and slid back out of the way when free ventilation was desired.

"Play" of Roofs and Lifts (page 343).— "It is right to have lifts and roofs easy, but they should have no play." These two statements appear to me to be quite incompatible, for if lifts and roofs are to be easily removed and adjusted they must have a certain amount of play. Taking this statement in accordance with the context, "D. M. M." seems to imply that the necessary play between the "over-laps" of outer-cases, &c., may, if it amount to a bee-space, allow bees to enter from the outside; but it cannot possibly do so in a normally-constructed hive, for the walls of each succeeding tier rest solidly all round on those of the next below. Should any pair of walls in the roof *not* do so, small fillets should be nailed inside at the correct height to bear on the walls of lift or outer-case.

The Season.—In a former note on this "topic" I said that the fine weather at the beginning of August had come too late for districts other than heather, but I have since found to my surprise just four times as many sections finished as I expected to have in July. The bees worked very hard during the first fortnight of August, as though they were determined, as far as possible, to make up for lost time.—SAML. P. SOAL, Rochford, Essex.

A NEW BEE-TREE.

[7608.] I congratulate you, Sir, on the great and growing interest which your journal possesses for the disciples of the famous Huber; and not only for bee-keepers, but for numbers who love horticulture and entomology. Many become bee-keepers through reading the pages of the B.B.J. It well deserves the name "British," for it circulates throughout the Empire, and, indeed, all over the

civilised world. Your last issue contained a deeply interesting letter from Kashmir by Dr. Neve, another from a South African bee-keeper, and yet a third on green-introduction from the United States.

I should like to bring to your notice a short article that appeared in *Le Rucher Belge*, of interest generally to horticulturists and particularly to bee-keepers. It tells of a Japanese quick-growing tree, rich in honey-bearing flowers just at the season they are needed. I hope you will publish the letter in the original, for I am sure that it will be "read, learned, and inwardly digested" the more for not being translated!—P. HILARBOR.

"Du *Praktische Wegweiser*: Lors de l'exposition apicole de Breslau, 20 août, un apiphile national découvrit, dans ses pérégrinations à travers la ville, un arbre couvert d'une masse de fleurs blanches et sur lesquelles toutes les abeilles de la ville semblaient s'être donné rendez-vous. Après enquête, il réussit à savoir qu'il avait affaire au *Sophora japonica*, arbre à croissance très rapide, prospérant dans toutes les terres, donnant un bois excellent et, ce qui le rend précieux au point de vue apicole, produisant une profusion de fleurs depuis le commencement d'août jusqu'en septembre. Il est mellifère à l'égard de l'acacia et permet encore une abondante récolte de pollen. M. Kramer, dans la *Schw. Bztg.*, compte cet arbre parmi les plus mellifères, méritant surtout l'attention des apiculteurs dont les abeilles n'ont pas de miellée tardive. . . ."

BEE-KEEPERS AND COUNTY ASSOCIATIONS.

[7609.] I have read with great interest the correspondence in the B.B.J. relating to bee-keepers and county associations, and think "Beginner" is rather hard on both associations and experts. I only took up bee-keeping this year, but consider that the most important person in the associations to us is undoubtedly the expert, who seems to get all the stings, while we get all the honey.

In our failures and disappointments, which in nine cases out of ten are the result of not obeying the instructions contained in the "Guide Book," I am afraid we beginners are inclined to be too hasty in laying the blame on someone else, generally the expert.

So far I have received every attention from the district expert, and when he first came to me I besieged him with the usual beginner's questions. He was kind enough to answer them, and also was the first of a number of old bee-keepers who told me to study the "Guide Book." This advice was carried out, and I soon found the answers to the questions I had put to

him. Since then he has been over four or five times to see how the bees were getting on, and also how my bee-education was progressing. He also showed me how to extract honey, and during my holiday came over to see to my bees during my absence. Living four miles away, this meant a lot of trouble on his part. We beginners are apt to forget that the expert has other bee-keepers to visit, all of whom expect him to answer their questions. He has also his own bees to look after, besides his ordinary work.

Bearing all this in mind, I would recommend those who are beginners like myself to first look in the "Guide Book," where they will probably find the answer they require. If, however, they cannot find a satisfactory answer there, instead of asking the expert to come over to them, let them take the trouble to go to him, giving him due notice when they are coming. Probably he will be able to give ten minutes at his house, during which all the questions could be answered, whereas he could not spare an hour to go over to them.

I am afraid most beginners will always be wanting to ask questions; that is why I wrote to find out if a bee-club existed in London (page 296), a place where bee-keepers could meet and relate their experiences. But I see now that this could not be possible, because (1) a great many bee-keepers could not afford a journey to town, and (2) if a club were started it would consist principally of beginners, who would congregate round an old hand and worry him with questions, to which the answers could be easily found in the "Guide Book"; so I am afraid the old bee-keepers would be conspicuous by their absence, for, as "Kappa" truly says on page 316, "It is not every old bee-keeper who is anxious to discuss," probably for the above mentioned reason. But if we beginners carry out the excellent advice given to us by our elders and betters, e.g., "Read the 'Guide Book'" we should not want to ask questions; and the old bee-keeper or the expert, knowing that when they saw a beginner they would not be worried with questions, might then discuss and tell us their experiences, which no doubt we should find extremely interesting and useful. The expert also might find more pleasure than he does at present in visiting a beginner's apiary, and therefore might come oftener. ALMA, Rugby.

BEEES AND FRUIT.

[7610.] There is a point not often alluded to by subscribers to your journal with regard to bee-keeping. Most people reckon the value of bee-keeping in the amount of honey they obtain per hive. I do also to a certain extent, but add as

well the value of fruit per tree. I find, roughly, that in our garden we get 25 per cent. to 30 per cent. more fruit than our more distant and even near neighbours. As an instance of the value of bees, I may mention that last spring, after five weeks of cold weather, we had one very warm day. The pear blossom had been kept back by the cold; during the morning about six trees burst into full bloom in a most astonishing manner. The bees simply stormed them, and by nightfall almost every petal had dropped off. The next day was wet, and the cold again returned. As a result, the trees are full of fruit, due, to my mind, only to the rapid fertilisation of the blossoms by the bees. As a matter of fact, I at first thought there was a swarm out, so numerous were the bees. Otherwise there are few pears this year in our immediate district.—WALTER ED. ZEHETMAYR.

IMPROVED FLOORBOARD FEEDER.

[7611.] Now that the season for honey-gathering is practically over, and our bees will require rapid feeding, I have

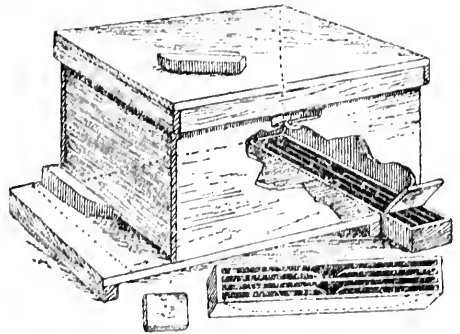

"ALEXANDER" FLOORBOARD FEEDER.

sent a sketch in perspective of my floor-board feeder. It is my own invention, and I have used it for many years, and found it very satisfactory.

When in use the hive-body is shifted back over it, so there is no loss of heat through shifting quilts, as with top feeders. In winter it can be filled with candy. In spring one half can be used for water and the other half for syrup.

The honey crop in Cornwall has been a complete failure this year, which is very unfortunate for our poor bee-keepers.—R. GROSE.

[The feeder is similar to that used in America, and known as the "Alexander" feeder. It is really a "simplicity" feeder placed at the end of the floorboard, the hive being drawn back over it. We give an illustration of the "Alexander" feeder in use, which will make it quite clear. Mr. Grose has a division in the

centre, and fastens his feeder to the floor-board by means of projecting iron straps and a screw eye.—Ed.]

BEEES KILLED NEAR COPPER-SMELTING WORKS.

[7612.] Regarding bees being killed near copper-works, as stated in B.B.J. (August 26, page 331), the matter is a very simple one, as the poisonous gases given off during the reduction of the copper pyrites would unite with the atmosphere sufficiently to cause the deadly gases to be carried some distance, this being regulated by the temperature, humidity, and stillness or otherwise of the air. Condensation would go on from the time the gases left the cupola, and, as the quantity of poisonous gases deposited near the works would be the greatest, the bees placed nearest the works would suffer most. As these condensed gases fell to the earth they would be certain to come in contact with flowers, and especially the pollen, which would be gathered by the bees and given as food to their young, which would die as a result. An atmosphere charged with these gases would not be very healthy for bees, but as they survived the winter in it the cause must be sought in the poisoned pollen and honey. In this country there is a law to prohibit the reckless diffusion of deadly gases from chemical works. At one time all vegetation in the vicinity of works where washing soda is made was destroyed by muriatic acid, which, leaving the works as a gas, combined later with the moisture in the air, and fell in its hydrated form upon vegetation and by degrees destroyed it.—A. GREEN, Notts.

WAX-GATHERING IN MALAYA.

[7613.] In *Chambers's Journal* for September there is a most interesting article on "Wax-gathering in Malaya," by D. W. O. Fagan, a short review of which may interest readers of the B.B.J. sufficiently to cause them to peruse the article as a whole. The author describes how, in search of fresh experience, he and the "Penderang" (Rajah's heir) joined a wax-gathering expedition to the forest, and so to his subject:

"The wild bees of Malaya are, I take it, a genus apart—larger, fiercer than those of the domesticated species known to Europe, and differently marked. They hive in the thick jungle of the interior in immense numbers, and with this peculiarity, that they invariably make their home in one species of tree alone.

"The 'Rajah-tree' of Sumatra, common to all the islands of Malaya, with a trunk-diameter of six to eight feet, towers amid tropic undergrowth to a

height of a hundred and fifty feet or more. In appearance it resembles nothing so much as a huge umbrella wide open, poised upright on its handle. No knot or protuberance breaks the smooth, vertical column of the massive trunk till, seventy or eighty feet from the ground, the crown of branches radiates horizontally from the bole as spokes from the hub of a wheel, or, to carry out my first simile, the ribs of an open umbrella. On and above the branches is superimposed a dome-shaped mass of dense foliage, flattened and compressed, the outside rim of the mushroom-like top, regular and orderly as though trimmed with giant shears, forming a circle of perhaps two hundred feet diameter.

"In the shade of this vast umbrella the bees live in colonies, shielded alike from the fierce rays of the sun and the flail of the tropic rains that now and again sweep over the forests. Their hives, fashioned of wax, hang in thick clusters from the under surface of the great limbs, semi-circular in shape, with a circumference of three feet; these hives, of which there might be quite two hundred in one tree, give one the idea of so many gigantic yellow pudding-basins sticking by their rims beneath the branches.

"From time immemorial a sort of semi-religious sanctity has been thrown around all rajah-trees. They are held sacred to the rulers and potentates of those provinces where they grow, who also claim full right of value of all wax produced by the bees. To cut or injure a 'rajah' is regarded as an offence meriting the shortest possible shrift; and if, indeed, any unfortunate Malay of the common people were to cut one down or set it on fire accidentally (he would never do it on purpose), I have never been able to find out what sort of frightful thing would happen to him.

"Yearly, as the season approaches, armies of bee-trackers are sent out, whose duty it is to mark the young swarms and follow them to their homes, and as soon as it is observed that bees have commenced to frequent a 'rajah-tree' both it and the spot on which it stands are 'tabooed,' to prevent any molestation of the insects by a too near approach. As no tree is considered worth robbing unless it contains at least one hundred and fifty hives, the 'taboo' may hang round the tree and its environs for quite a long time.

"Where the bee-tree grows far back in the wilds, many miles beyond the settlement-line, the hive-robbing becomes a work of some magnitude, and the expedition may last three weeks. Fortunately in our case the scene of operations was

only about four miles, within the fringe of the forest, beyond the village outskirts.

"Like burglars setting out to crack a crib, we waited till the shades of night had well fallen ere starting. Like many another nefarious undertaking, hive-robbing is best done in the dark. Precipitation is to be avoided; and, anyhow, as my friend Hamil sensibly put it, there's no use starting in to rob bees till they are sound asleep.

"On arrival at the village we found the hunters, ten active and athletic Malays, waiting our presence and the coming of the 'Mullah'; for no company of pious Mohammedans could be got together for a night expedition, unless under the leadership of the 'Crang-Kramat,' literally 'Mystic Man,' as the village priest is called.

"Presently, headed by the Mullah, a fine-looking Arab, with grave, ascetic face, we crossed the cleared land, where the moonlight fell in a silver flood, and plunged into the gloom of the forest, the Mullah lighting a toreh, as with the guide he marched in through the undergrowth. The Panderang and I followed close in single file, and after us the hunters, bearing various impedimenta on their heads—coils of light, strong rope, baskets, bundles of torches, and bales of split bamboo pegs pointed and fire-hardened to an iron-like rigidity.

"Elephant-tracks and rhinoceros-runs pierced the jungle here and there, and where possible they were followed as offering easy going until they arrived at the vicinity of the 'rajah-tree.' Here the tangle of undergrowth fell back, leaving a sort of natural clearing. In the centre of the open space the great trunk, massive and column-like, held aloft its huge mushroom top of leaves and branches. One could just make out in the gloom overhead clustering bunches of hives depending in groups from the under surface of the giant limbs.

"At the tree-foot a halt was called, and the Mullah, lifting hands to heaven, invoked the protection of God for his men and a blessing on the undertaking. The group of hunters and ourselves stood silent, with bowed heads, as the priest, chanting the universal prayer of Mohammedans, marched seven times round the tree-trunk. One could almost fancy one's self present at a midnight service in some vast mosque of Nature's fashioning, so weirdly impressive was the scene. The red light of the single torch borne aloft by the Mullah as he moved cast momentary flashes of crimson colour now on tree-bole, now on dusty forms of waiting hunters."—R. WHYTE, Glasgow.

(Concluded next week.)

GLASS ON TOP OF SECTIONS.

[7614.] As regards the query and reply on the above in B.B.J. (No. 3969, page 358), I beg to state that I have used glass on the top of sections, also on tops of frames of brood-chamber, for three or four years, but have not had any trouble as regards propolis, as I have made a wooden frame to lie on the top of the frames and sections, and the glass lies on the top of the frame. The progress can be easily observed under those conditions. Besides that, I have two pieces cut out of the glass in front and at the back, so that I may feed the bees with syrup by means of the ordinary feeder without lifting the glass.

I was led to adopt the above plan as I had been troubled with the wax-moth and larvae in the quilts. Of course, I cover the glass over with warm articles. With best wishes to all fellow bee-keepers.—A SUFFOLK BEE-KEEPER.

[Thirty years ago the old "Woodbury" hive was constructed with such a framed glass as that suggested by our correspondent, and was given up because very little could be seen of what was going on below, as the bees cluster quite up to the top of the frames; and it was much more trouble than quilts, by the use of which any number of the frames can be uncovered without exposing them all.—Ed.]

CAPPINGS OF COMB.

BY L. S. CRAWSHAW, NORTON, MALTON.

Catching the Queen (page 309).—A satisfactory and simple method, which I often adopt, is to use an ordinary match-box. Half open the box, and place it over the queen and attendant bees. "Waggle" the box a little to get it fairly flat upon the comb without crushing bees, and close it with the forefinger. The whole operation is quick, and—a great point—it is one-handed. It is, of course, merely a modification of the pipe-cover method, but it has the advantage that the box may be slipped at once into the pocket, leaving the hands free.

Mr. Garcke's Paper (page 312).—I could wish that we might have had a terse account of the gist of the subsequent discussion. It would have been generally enlightening to us poor provincials. A perusal of Mr. Garcke's careful scheme gives a favourable impression. I agree as to the undesirability of upheavals. Even the disbanding of B.B.K.A. members does not seem essential. Why not retain as many as possible of these as voluntary subscribers? The majority of them are in that altruistic position to-day. Of course, county members would have to be placed upon an equality as to voting powers. This re-

tion would remove the necessity for a guarantee fund. I do not think that the idea of expert certificates terminating with membership is fair. But I do think that the central body might be kept in touch with those experts who do active work. For their mutual benefit county associations might very well report as to capabilities and general satisfaction, and the central body might well be approached when engaging experts. For the possession of a diploma is one thing and the possession of the requisite personal qualities and touring efficiency is, as some secretaries know, quite another. But that is a dog with a different bark. Of course, the engaging county could always stipulate for current membership of the B.B.K.A., if that were desirable.

Folding Sections (page 314).—Without actually having tried it, I feel sure that this is a splendid tip for softening the joints. "D. M. M." refers to this in favourable comment (page 338). One objection to wetting the section is that where the water comes in contact with the outside it spoils the finish. The wood becomes swelled and roughened, and staves. We cannot be too nice in all our dealings with that *article de luxe*, comb honey.

Cane v. Beet (page 315).—In spite of the non-political atmosphere of the police-court, it is not difficult to divine the respective prejudices of those concerned in this discussion. Presumably the magistrate would approve of "honey" such as that supplied to Continental hotel tables! It is cheaper than the real article, and might be advocated on the humanitarian grounds of saving the bees from work. But a gentleman who is so evidently misled by a slight similarity of sound as to know no more of the difference between healthy sugar-cane and dire beet than he does of diabetes and the diet of beetles (*vide* report) should, in my opinion, be beaten with many canes until the knowledge crystallises once for all in his sweet thoughts.

Hampshire Moors (page 315).—It is cheering to hear of such good prospects in the South. I wonder how they have turned out. Here with us the Whithy moors seemed to promise fairly, but the promise has not been fulfilled, and the expense of moor-going looks like wasted money. The Wharfedale moors are very poor, and Mr. Albert Wilson, a well-known botanist, tells me that the bloom is the worst for twenty-one years. His opinion was that the severe winter frosts had materially affected the heather, as it was unprotected by snow.

Foundation and F.B. (page 316).—Have the old combs remained free from disease? If so, the evidence seems to

point to a possible danger in foundation, although we are assured of none. Was a piece of the batch of foundation saved, so that a proper test might be made? The after-history of this hive is of some importance. In the case of many B.B.J. reports a second report would be often valuable. After-events may show that surmises have been unfounded, or some important detail may have been overlooked.

Introducing Virgins (page 324).—Isn't it a little late to do this in the middle of August? In such a year as this has been I fear that failure would be foredoomed, for the drones were killed off in very good (or very bad) time.

Current Topics (page 326).—What is a scraper if it be not a tool? And how can one "stand up for a scraper as for its proper use"? Is not the writer of this getting rather into a verbal scrape? His facility with the three-edged scraper and the two-edged sword has led him to handle the mightier pen in the same fashion. But "D. M. M." must reason with him.

Getting the Honey of Sections (page 327).—It is not easy to see the connection between honey-flow and hive-levelling. Surely a fair statement of the case should be "levelled or not levelled" under similar conditions. Why, I feel that I could almost dare, with a dash of Dutch courage (and honey), to challenge the most skilful bee-master in the world, and allow him sole right to all the advantages that appliances can give, if only he will consent to keep his bees at the North Pole. But what exactly is a "hair's-breadth" in hive-levelling? There is no doubt they would be "fine combs" which were adjusted to this level-headed nicety, and they would have no difficulty in retaining their contents by "capillary" attraction.

Notices to Correspondents.

* * Notice.—*Isle of Wight Disease*.—We should be glad to receive specimens of bees that are known to have died from this disease for bacteriological examination. They should be quite fresh.

J. L. M. (Buxted).—*Bees Starting Queen-cells*.—1. The queen sent is a virgin. 2. The queen evidently did not satisfy the bees, and they were preparing to supersede her. It is not uncommon to find bees persisting in building queen-cells when they have been cut out, especially during the swarming season.

W. F. S. (Weybridge).—*Treatment of Foul Brood*.

—There is no need to burn all the things you mention so long as you thoroughly clean and disinfect them according to instructions in "Guide Book." Extract the honey from the sections and give them to the two hives having foul brood, to clean up. You can then melt up the combs. As you have not sorted your sections it would not be safe to give those coming from diseased colonies to healthy ones. As your outbreak is a mild one there is all the more need for care.

M. O. (Carnarvonshire).—*Brown Sugar for Bee-food*.—The sample is quite unfit for autumn bee-food. Use only white lump cane sugar, as recommended on page 197 of "Guide Book," or white cane crystals.

NOVICE (Hants).—*Race of Bees*.—1. Both specimens are common English bees. 2. Rapid feeding should be finished by end of the month. 3. The "Guide Book" tells you on page 112 how much sealed honey there should be. If there is not this quantity, feed with syrup to make it up. The bees will not require candy until the spring, and only then if they are short of provisions.

G. A. (Stamford Bridge).—*Name of Insect*.—It is the female *Sirex gigas*. The ovipositor is used for perforating the bark of fir trees, in which the larvae are deposited.

G. R. T. (Barnes).—*Peculiar Effect of Stings*.—It is seldom that stings have such an effect as you describe, and it is usually due to the state of health of the person at the time and the poison mixing with the blood. Sal volatile in water is the best remedy; but a small dose of brandy and water is sometimes useful.

HEATHER (Glasgow).—*Name of Flower*.—It is *Erica vulgaris*, a good honey-producing plant.

YORKSHIREMAN (Hedon).—*Pure Cane-sugar*.—The sample of sugar sent is not suitable for bee-food, even if it is cane-sugar. The best kind to use is white lump cane-sugar (see "Guide Book," page 197). Equally suitable would be white crystals, provided they are guaranteed pure cane. If you are unable to get these in your neighbourhood, they can be obtained through this office.

A. A. (Highgate).—*Removing Bees from Box*.—As the bees have made a few combs in corner of the box, you can transfer them to a frame-hive, preferably in the spring. If at present they are short of food, they must be provided with sugar syrup, made according to instructions on page 197 of "Guide Book." As you are a beginner and have never kept bees, your best plan is to study the "Guide Book," and anything you do not understand we shall be pleased to explain.

Honey Samples.

S. M. (Surbiton).—The honey, on granulating, will become lighter, but it will depend upon your being able to find a market for dark honey whether it is worth bottling. The sample is rather thin, but otherwise the flavour is not unpleasant, and would probably please some palates.

J. A. (Easterhouse).—The honey is thin, from mixed sources, and discoloured by honey-dew. It would be classed as medium-coloured, and should be saleable.

A BEGINNER (Dorset).—The honey arrived in a smashed state. That in the section is very good heather honey. The piece from brood-chamber is also principally heather. The dark cells contain pollen, stored by the bees for food.

APIS MELLIFICA (Canterbury).—The honey is thin and has a decided flavour of fruit syrup. It is quite clear and free from honey-dew.

H. M. S. (Canonbury).—Sample is of very inferior quality, from mixed sources, not gathered this season. Flavour and aroma are poor, and the honey has granulated very coarsely. It is worth about 4d. per lb.

J. D. (Denbighs).—No. 1 is a light honey of good colour, with rather an unpleasant flavour and aroma. It is probably from turnip or rape. No. 2, though dark, is of good consistency and of better flavour than No. 1. No. 3 very similar to No. 2 in quality, but contains a little honey-dew.

G. B. (Omerley).—Fruit-blossom honey of good flavour, though dark in colour. It also contains a little honey-dew.

A. B. SELF (Norwich).—Very nice honey, from clover and limes. Good in colour, flavour, and consistency.

Suspected Combs.

X. Y. Z. (Sevenoaks).—There is no brood of any sort in the comb sent, and the one sealed cell contained a fully-developed bee.

G. R. (Denbigh).—The comb contains odourless foul brood.

H. M. J. (Birmingham).—Foul brood in an advanced stage.

W. (Sevenoaks).—Nos. 1 and 2 are both badly affected with foul brood in a very advanced state. In view of the lateness of the season, if there are sufficient bees, make an artificial swarm of each lot and unite them. Confine in a straw skep for forty-eight hours, and follow the instructions given on page 180 of "Guide Book."

J. H. (Penrith).—Incipient foul brood in cells. As there are only a very few of these and the hive is strong in bees, you might try placing in the hive $\frac{1}{2}$ oz. of a 10 per cent. solution of formalin in a tray covered with perforated zinc, and three balls of naphthaline on floorboard. Feed with medicated syrup, and if this does not cure treat in spring as recommended in "Guide Book."

R. S. H. (Wanstead).—Cells of comb sent contain foul brood of old standing.

Special Prepaid Advertisements.

Twelve words and under, Sixpence; for every additional Three words or under, One Penny.

Advertisements for current issue must be received by first post on Tuesday.

FEW LOTS HEALTHY DRIVEN BEES FOR SALE, 2s. lb., good Queen.—CHARTER, Tattingstone, Ipswich. u 41

2 STRONG LOTS DRIVEN BEES, 4s. 9d. lot; boxes free.—MULLIS, Egerton, Kent. u 58

HEALTHY DRIVEN BEES, with Queen, 5s.; ditto, on 4 Frames, Honey and Brood, 10s. 6d.; Queens, 2s.; carriage paid.—BLAKE, Knowstone Vicarage, South Molton. u 51

WANTED, 1 dozen Sections of good Honey. Moderate price.—H. E. ORAM, Lark Hill, Worcester. u 53

WANTED, Offer for 4 strong healthy Stocks, 3 in "W. B. C." Hives. Cash or exchange for whole or part.—HUMPHREY, Sub-postmaster, Shamley Green, Guildford. u 61

DRIVEN BEES, with 1909 Queen, 3s. 6d. lot, boxes free; Pure Black Queens, young and fertile, in introducing cages, 2s. 6d. each.—WITHEY-COMBE, Docks, Bridgwater. u 60

STRONG STOCKS, good natural stores, 1909 Queen, 12s. 6d., 13s. 6d.; Driven Bees, with fertile Queen, 5s., 6s. lot; all guaranteed healthy. Exchange good letterpress or extracted honey.—W. A. WOODS, Normandy, Guildford. u 50

LOOK SHARP IF YOU WANT ANY.—Few fertiles, Blacks, left, 1s. 6d. each.—FINDLER, Ardleigh, Colchester. u 40

HONEY, in 1 lb. screw jars, 7s. 6d. dozen; $\frac{1}{2}$ lb. ditto, 4s. 6d. dozen; Honey in bulk.—75, Moffatt-road, Thornton Heath. u 49

DRAWN-OUT SHALLOW WORKER COMBS, containing pollen, grand for driven Bees, 8d. each.—ALUN JONES, Bryn Awel, Haikyn, Flintshire. u 48

GOOD FERTILE SURPLUS QUEENS, from driven stocks, 2s. 6d.—R. MANLEY, Potcote, Towcester. u 47

WHAT OFFERS? Driven Bees, 4 lb. lots, with young Queens.—JAMES BAILEY, Swan-lane, Evesham. u 46

FEEDERS.—Ours are the best. Six secondhand Extractors cheap.—MEADOWS, Syston. u 57

Editorial, Notices, &c.

THE GROCERS AND KINDRED TRADES' EXHIBITION.

(Report concluded from page 372.)

The honey exhibited was undoubtedly the finest display brought together in Great Britain this year. The fact that these competitions were omitted from the Confectioners' Exhibition was no doubt instrumental in bringing about this happy result, and never before has so fine a honey show been seen at the Agricultural Hall, which is astonishing considering the adverse season. Unfortunately, room being limited, the exhibits were placed right across the west gallery and partly along the north side, two of the largest classes being quite away from the rest, which rather minimised the effect of the display as a whole, while a corner bay had to be taken in to accommodate three of the trophies. Not only bee-keepers, but grocers and dairymen are realising more and more the advantages of exhibiting honey, prize produce always realising a good price. This is the only show held on purely trade lines which enables tradesmen to exhibit their purchases made from bee-keepers; and the advantages gained by bringing producer and buyer together should not be under-estimated by bee-men who wish to make their hobby a profitable one.

The scarcity of honey was shown by the numerous inquiries at the office of Mr. W. Herrod, who was in charge of the honey section, for bulk honey, not only by shopkeepers, but also by bee-keepers who, though their harvest had failed, were anxious to obtain supplies to retain their regular customers.

On the stand of the Irish Agriculture Organisation there were a number of sections and jars of Irish honey, but, considering the fine season bee-keepers have had in Ireland, the exhibit hardly did justice to them. We have seen much better honey from Ireland, and there was not a sample that could compare with the beautiful displays in the gallery of honey in suitable form for a tradesman's window.

South Australia exhibited honey in cans, and also in jars, labelled "Extra Quality" and sold at 6d. per lb. jar. The honey is dark and of the usual coarse flavour, and cannot compare with the fine flavour and aroma of British honey. Australia is making an effort to secure a market in England, and no doubt some will be sold where cheapness is the first and only consideration; but the British product has nothing to fear from the competition, and will always command a higher price as a table honey.

A brief review of the honey and wax classes may interest readers. Only two entries were made in the class for beginner's outfit—a rather surprising result considering the number of appliance dealers in this country, that it is the slack season, and the amount of prize money offered.

Six fine honey trophies, however, were staged, the first and second prize exhibits especially being excellent both in design and quality of honey. The third prize was awarded for a very nice display, rather formal in style, but very suitable for a grocer's window, the fourth-prize winner being, like the third, put up by a new hand and containing some splendid honey. The remaining two were very nice exhibits, both tastefully arranged.

Both light and medium honeys were well represented, the class for twelve 1-lb. jars light extracted containing thirty-eight exhibits of splendid quality, and the medium class thirty-six; while the dark honey class showed only nineteen, many of which were tainted with honeydew.

The classes for heather honey in jars and sections were very satisfactory both in the number of entries and in quality of exhibits staged. Some of the honey was last season's produce, but on the whole both showed a decided improvement on last year. The granulated honey was also a very fine class, all the honey shown being of splendid quality, and representing bee-keepers from all parts of the country. Fourteen entries were made in the beeswax for sale class, the exhibits being excellent samples of this valuable product. Beeswax judged for quality alone showed sixteen entries—a very good display, the first-prize exhibit being a perfect specimen. The wax classes this year were staged in glass cases—a great improvement, as the whole were thus kept clean and fresh.

The sale classes were not well patronised owing to the scarcity of honey.

The weight of honey staged altogether totalled 2,649 lb., which will give some idea of the labour involved in staging and re-packing the exhibits. Good as the show was, there ought to have been far more entries considering the amount of prize money offered and the low entry fee.

SOMERSET B.K.A.

ANNUAL SHOW.

The Somerset B.K.A. held their annual show of honey and wax at Brislington on August 25. The weather was ideal, and a splendid collection of apiarian produce was exhibited, a special feature of the show being the uncommonly good flavour of the dark honey shown. Mr. James

Brown carried out the duties of show secretary in a most able manner, and also kindly gave flowers to increase the attractiveness of the tables. The judges, Messrs. S. Jordan and L. E. Snelgrove, awarded the following prizes:—

MEMBERS' CLASSES.

Six 1-lb. Sections.—1st, G. W. Kirby, Knowle; 2nd, H. Kingston, Whitechurch; 3rd, M. A. Exon, Knowle; c., R. P. Knight, Whitechurch.

Six 1-lb. Jars Light Extracted Honey.—1st, M. A. Exon; 2nd, H. Kingston; 3rd, G. W. Kirby; h.c., R. P. Knight.

Six 1-lb. Jars Dark Honey.—1st, G. W. Kirby; 2nd, R. P. Knight; 3rd, M. A. Exon; h.c., H. Kingston.

OPEN CLASSES.

Collection of Honey.—1st, G. W. Kirby; 2nd, H. J. Moore, Radstock.

Twelve 1-lb. Jars Extracted Honey.—1st, H. W. Saunders, Norfolk; 2nd, A. J. Brocks, Stockbridge; 3rd, J. Garratt, Lutterworth; h.c., G. W. Kirby, and A. J. Lucas, West Town; c., W. Pierce, North Petherton.

Twelve 1-lb. Sections.—1st, A. J. Brocks; 2nd, G. W. Kirby; 3rd, H. J. Moore.

Single 1-lb. Jar Extracted Honey.—1st, R. W. Lloyd, Norfolk; 2nd, A. J. Brocks; 3rd, T. George, Henbury; 4th, W. Patchett, Lincoln; h.c., A. G. Pugh, Beeston; c., G. W. Kirby.

Single 1-lb. Section.—1st, H. J. Moore; 2nd, T. George; 3rd, A. J. Brocks; 4th, G. W. Kirby; h.c., C. R. Smith, Ipswich; c., H. G. Kemp, Frome.

Collection of Bee-hives and Appliances.—1st, Brown and Sons, Bristol.

Exhibit of a Scientific Nature.—J. Brown, Redland.

Beeswax.—1st, T. George; 2nd, G. W. Kirby; 3rd, W. Pierce.

Observatory-hive.—1st, L. E. Snelgrove, Weston-super-Mare; 2nd, G. W. Kirby.

Three Shallow Frames.—1st, F. G. Hales, Wellow; 2nd, W. Pierce; 3rd, H. J. Moore; c., Mrs. B. B. Fox, Brislington.

Honey Products (Confections, &c.).—1st, G. W. Kirby.

Three 1-lb. Jars Granulated Honey.—1st, H. J. Moore; 2nd, G. W. Kirby; 3rd, J. Spiller, Wilton.

Six 1-lb. Sections.—1st, T. George; 2nd, H. J. Moore; 3rd, Miss E. Doggett, Nailsea; h.c., W. Pierce; c., G. W. Kirby.

Six 1-lb. Jars Extracted Honey.—1st, G. W. Kirby; 2nd, Mrs. Carpenter, Compton Bishop; 3rd, H. J. Moore; h.c., W. Pierce; c., T. George.

Six 1-lb. Sections and Six 1-lb. Jars.—1st, W. Pierce; 2nd, G. W. Kirby; 3rd, Miss R. A. Sheppard, Chewton Mendip.

Four 1-lb. Sections.—1st, T. George; 2nd, G. W. Kirby; 3rd, W. B. Barratt,

Bishopston; h.c., A. J. Lucas, West Town; c., H. J. Moore.

Four 1-lb. Jars Extracted Honey.—1st, G. W. Kirby; 2nd, W. Pierce; 3rd, Mrs. Carpenter; h.c., J. Spiller, Wilton; c., H. J. Moore.

NOVICE CLASSES.

Three 1-lb. Sections.—1st, T. George, Henbury; 2nd, F. G. Hales, Wellow; 3rd, W. B. Barratt, Bishopston; h.c., F. Nicholls, Shepton Mallet; c., H. G. Kemp.

Three 1-lb. Jars Extracted Honey.—1st, Rev. A. VeEVERS, Wington; 2nd, H. G. Kemp; 3rd, F. G. Hales; h.c., F. Nicholls; c., T. George.

LIABILITY OF BEE-KEEPERS.

A CANADIAN DECISION.

By E. A. C. Lloyd, Barrister-at-Law.

Since writing the article which appeared in the B.B.J. for April 29 on the responsibility of bee-keepers for injury inflicted by their bees, a Canadian decision on the point has come to our notice.

This decision, which is, of course, not binding on the English Courts, is yet one which the English Courts would consider if a similar case occurred here, and would to a certain extent be guided by it and the law laid down therein.

The facts in the case were these. The defendant was the owner of 160 to 170 hives of bees, which he placed in a small yard situate within about 20 ft. of the highway. Immediately opposite this yard, on the south side of the road, was the plaintiff's property, consisting of a field of about eight acres, which was in oats, and beyond it another field in buckwheat. In August the plaintiff was in the oat-field with a pair of horses and a binder for the purpose of cutting the oats, when the horses were attacked by a large number of bees.

The horses took fright and ran away to the other end of the field with the binder. The plaintiff followed them and endeavoured to free the horses, but he himself was similarly attacked, and only made his escape by immersing himself in a pool of water.

One of the horses died almost at once, and the other succumbed within two or three days.

Several questions were left to the jury:—

1. Were the plaintiff and his horses injured by bees in ordinary flight or work or by the swarming of a colony of bees? Answer: Ordinary flight.

2. If they were injured by bees in ordinary flight and work, were these the defendant's bees? Answer: Yes.

3. If the plaintiff and his horses were injured by the swarming of a colony of bees, had the bees swarmed from defendant's colony? No answer.

4. Had the defendant reasonable ground for believing that his bees were more dangerous than ordinary bees? A.: Yes.

5. Had the defendant reasonable grounds for believing that his bees were, by reason of the situation of the hives or their numbers, dangerous to persons or horses upon the highway or elsewhere than on the defendant's premises? A.: Yes.

6. At what sum do you assess the damages of the plaintiff, if the defendant be liable for damages? A.: \$400.

On this finding the defendant appealed, but the verdict of the Court below was upheld.

For the defendant it was contended that it was not proved that the bees which attacked the plaintiff were the defendant's bees. They may just as probably have been another neighbour's bees. It was also urged that the bee was a harmless domesticated animal not prone to attack men.

For the plaintiff it was argued that bees are *feræ nature*; they are not domesticated, but may be cultivated; the owner harbours wild animals at his risk.

Mulock, C.J., in his judgment, said: "The right of a person to enjoy and deal with his own property as he chooses is controlled by his duty to so use it as not to affect injuriously the rights of others, and in this case it is a pure question of fact whether the defendant collected on his land such an unreasonably large number of bees, or placed them in such position thereon, as to interfere with the reasonable enjoyment of the plaintiff's land. I think the reasonable deduction from the answer of the jury to Question 5 is that the bees, because of their numbers and position on the defendant's land, were dangerous to the plaintiff, and also that the defendant had reason so to believe. . . . If he was making an unreasonably use of his premises, and injury resulted therefrom to the plaintiff, he is liable. It was the defendant's right to have on his premises a reasonable number of bees, or bees so placed as not to unfairly interfere with the rights of his neighbour; but if the number was so unreasonable, or if they were so placed as to interfere with his neighbour in the fair enjoyment of his rights, then what would otherwise have been lawful becomes an unlawful act."

CUMBERLAND B.K.A.

MEETING AT CARLISLE.

A meeting of visitors to the show of the C.B.K.A. was held on September 1 at Chisam's Temperance Hotel, Carlisle. A very pleasant evening was spent, during which many interesting points were raised by those present. Mr. John Vicars presided, and other speakers in-

cluded Rev. T. Featherstone, Messrs. Macdonald, Crawshaw, Price, Bouch, Wakefield, Mrs. Pearman, Dr. Arnott, and the Secretary. The speeches of the judges and others on the relative merits of heather honey and sugar-syrup for wintering were listened to with great interest. The question of a Foul Brood Bill was also before the meeting, and comment was freely made on the unanimous opinion of Cumberland and other Northern bee-keepers in favour of such a measure. It was mentioned that the C.B.K.A. had this season taken the votes of the bee-keepers in the county for and against compulsory powers, and the result had been an overwhelming majority in favour. Votes of thanks were passed to the chairman, the committee, and the judges.—G. W. AVERY, Hon. Sec.

BRITISH BEE-KEEPERS' ASSOCIATION ANNUAL CONVERSAZIONE.

We should like to draw the attention of members of county associations to the annual October conversazione of the B.B.K.A., to be held on the 7th prox. at 105, Jermyn Street, London, S.W. A cordial invitation is offered by the parent association to its affiliated societies and to friends interested in bee-keeping. The meeting opens at 5.30 p.m. The subjects prepared for discussion are (1) "Beneficial Results from the Fertilisation of Fruit-Blossom by Bees"; and (2) "Some Recent Investigations in Connection with Diseases of Bees."

Correspondence.

The Editor does not hold himself responsible for the opinions expressed by correspondents. No notice will be taken of anonymous communications, and correspondents are requested to write on one side of the paper only and give their real names and addresses, not necessarily for publication, but as a guarantee of good faith. Illustrations should be drawn on separate pieces of paper. We do not undertake to return rejected communications.

WASPS AND FLIES.

[7615.] I am inclined to lean to the side of "W. G. C., Rugby" (7605, page 367), and would like to preserve what I may call the "balance of power" in the insect world by saying a word for the wasp, the fly's natural enemy. Please give him a chance against that desperate plague of the human race, the common house-fly. I find that the possession of a bald head provokes the fly's attention to a degree that is unendurable, and had the Egyptians been given an option—wasps or flies—I am sure they would have given wasps the preference. The wilful encouragement of fly-breeding by allowing filth and garbage to remain exposed is criminal. How much annoyance we

should escape by making our houses fly-proof, as they do in the United States. Still better were we to attack the nuisance in its breeding-grounds by not exposing putrefying refuse, and calcining nearly all we consign to that domestic abomination the dust-bin. I am surprised that our sanitary authorities are not more alive to the danger to life and health attending the multiplication of *Musca domestica*. But it was with the intention of expatiating on the wisdom and virtues of the Vespidae that I began writing. What are termed the socials of the order are all paper-makers by trade, and, moreover, all makers of hand-made paper (Eynsford is famous for its hand-made paper). The wasps know paper, too, when they see it. You, Mr. Editor, may remember greatly interesting me recently by pointing out on the platform of Norton Fitzwarren Station a large advertisement claiming the charms of Cheltenham from which the wasps had removed all the white or uncoloured surface—but had entirely rejected the coloured or printed portion—for nest-building material.

My friend Mr. Withycombe, of Bridgewater, some years ago kept wasps in captivity, and supplied them with newspapers of quite opposite politics—the *Daily News* and the *Globe*. One is white, the other pink. The wasps are eclectic Conservatives, if they have any politics, taking from each just what they find useful, like true utilitarians. The result in Mr. Withycombe's interesting experiment was a parti-coloured white and pink nest! We are not so wise as the wasp, for there are people who would not read a particle of the *Times* at any price, and there are others who will swallow anything and everything from the columns, we will say (only, of course, for example), of the *Daily Mail*. The wasps of Norton Fitzwarren only took the unvarnished or the true stuff, and even that they thoroughly digested before applying it. What a lesson for us! The *Daily Mirror* has recently published the portrait of a lady with whom the wasps are in love. They press her hand, but do not sting, and she in turn caresses them. Like the wasps of Norton Fitzwarren, they clearly have the discriminating and discerning faculty, for they select the lovable, and love (as most know) begets love. Our particular favourite, *Apis mellifica*, though country cousin to *Vespa vulgaris*, is nothing like so amiable. My bees will sometimes sting me in the most gratuitous fashion, and also my dog, who takes it much more to heart than I do, and my gardener more than either, for they go out of their way to sting him, the most pacific of men; in fact, the *entente* in his case has never yet been established, and never will.

Wasps never sting without provocation.

The Psalmist in his suffering speaks of his enemies compassing him about "like bees" (not like wasps) mercilessly. Piers Plowman in his "Vision" says:

Ther is no waspe in this werlde that will wilfull-
oker styngen,
For stappyn on a too of a styncande frere!

I hope, Mr. Editor (despite the damage to your greengages), that you will not be too hard on "Master Wasp." Gay, the poet, is a little like you in being a trifle patience, so I will stop.—E. D. TILL, Eynsford.

Of all the plagues that Heaven has sent,
A wasp is most impertinent.

But my pleadings have, I fear, passed the bounds of your space and your patience, so I will stop.—E. D. TILL.

A PLEA FOR THE WASPS.

[7616.] Seeing a letter in this week's B.B.J. on "a plea for the wasps," I should like to know where all the wasps have gone to in this part of the country. I have not seen a wasp for more than a year, and on asking others get the same story. Now, in the early summer of last year one could see queen-wasps in very large numbers, but my idea is they were only virgins, having failed to mate the previous autumn owing to inclement weather conditions, and were thus unable to form a brood-nest. Some paper nests were found about the size of half an egg, but they never got any bigger, and they contained no brood. Last year a correspondent gave a recipe for the destruction of wasps in bottles, but by that time Nature had already stepped in and made a clean sweep of the whole of them. No doubt there are still wasps in the country, and it will be interesting to watch their progress next year.—ALEC LOW, Newmachar, Aberdeenshire.

THE SEASON IN SUNDERLAND.

ITALIAN BEES.

[7617.] The season has been a complete failure here so far as honey-getting is concerned. The hives were simply teeming with bees, and the weather was so bad all the time that they could only just keep themselves going. One of my hives (hybrids) nearly filled one rack of sections during the few fine days we had; but as bad weather set in again they carried all unsealed honey down, and in the end I only got eight finished sections from them.

I have some Italians, but I wish now I had not got them. They were a fancy of mine, so I re-queened a hybrid stock last autumn with a queen direct from Italy; she has proved a regular hummer as far as breeding is concerned, and the

bees are very quiet to handle; in fact, I began to think they were stingless bees, but had to change my mind when one day half a dozen got under my shirt-sleeves during manipulations. These are their good points, but the bad ones are, first, that a hive simply teeming with bees on eleven frames did not store one ounce of honey in supers, compared with hybrids half their strength, which gave 8 lb.; and their other fault is that they are robbers. Yes; they are the most determined robbers; in fact, they are a perfect nuisance if there is a weak hive in the vicinity—they simply wipe it out. When I examine my hybrid stocks, the moment the hive is opened they make an onslaught in thousands, which so annoys the stock under examination that it makes it almost impossible to handle them. They also poke their noses into other apiaries near to my own. On the other hand, for defending their own home they are simply splendid, and no strange bee has a chance of getting as much as a smell of their alighting-board. I divided the stock, which made two good strong ones, and sent for a hybrid queen. She was properly introduced in a cage, but they promptly killed her when she was released, and raised one of their own, to my disappointment; but I hope she will have been crossed with one of my dark drones. No more Italian queens direct from Italy for me.—JAS. CARRUTHERS.

AN IMPROVISED RAPID-FEEDER.

[7618.] The present being the time to feed up stocks rapidly for winter, I venture to send the following notes about a feeder which I have used successfully for two seasons. One often finds in an apiary of moderate size (such as my own) that the number of rapid-feeders is much less than the number of hives kept, and in a poor season, when all stocks have to be fed, we wish that we had sufficient feeders to supply all the hives at the same time, and had not to move the same feeder from one hive to the other every two or three days. This was the "necessity" that led to my "invention." Sweets are now largely supplied to grocers in 7-lb. free tins, and these can often be had for the asking. With very little work they can be converted into first-class feeders. They are round tins with lever lids, holding about 12 lb. of syrup, and when inverted over the feed-hole in quilts there is a space of about $\frac{3}{4}$ in. under the lid, where the bees have ample room to help themselves through a number of small holes previously perforated with a bradawl or an ordinary wire nail. The only precaution necessary is to see that the tin is perfectly air-tight before filling it with

syrup. Sometimes the folded joints around the bottom and up the side are not soldered, and all that is necessary is to run a little molten beeswax along the joints. When stocks have 10 lb. or 12 lb. of natural stores, one filling of this feeder is enough to carry them through the winter.

I hope the hint will prove as useful to brother bee-keepers as it has been to myself.—T. ALLEN JONES, Halkyn, Flintshire.

QUEEN-MATING DIFFICULTIES.

[7619.] The following notes of a virgin queen's difficulties in the deplorable summer of 1909 may be of interest to some of your readers. A small observatory-hive, home-made, with three frames running parallel to one another, afforded me the opportunity of observing and recording the movements of this queen, which emerged from the cell on June 12. For a day and a half the guard bees in charge of the one other sealed queen-cell in the hive were successful in repelling her onslaughts, but finally she eluded the guards and achieved her purpose in destroying her piping rival. Even if she had contemplated such a thing, the weather from June 13 to June 17 made any mating-flight out of the question. On the 17th the queen made three reconnoitring flights, each averaging half a minute in duration. On the 18th, during fitful gleams of sunshine, she made seven short excursions lasting on an average about three-quarters of a minute, her earliest appearance being at 10.27 a.m. On the 19th—another day of weather samples—she flew on five occasions, never for more than a minute at a time, and her last outing was at 4.20 p.m. On the 20th observations were suspended for some time, but the weather was too unsettled for a successful nuptial flight. The 21st provided one opportunity for an airing lasting one minute. The 22nd was a day on which even the most venturesome of workers would take no risks. On the 23rd our prisoner had a half-minute flight during one of the few sunny intervals. The 24th, 25th, and 26th were blank bee-days here. Finally, on the 27th, *i.e.*, fifteen days from her emergence, and after at least seventeen flights, she was successfully mated and was laying on the twenty-eighth evening.—C. H. M., Lincs.

TWO QUEENS WITH ONE SWARM.

[7620.] I am very pleased indeed to observe from a recent B.B.J. (page 347) that such an authority as Mr. Crawshaw took notice of my former letter (page 305), and I must say it is most gratifying and edifying to have any expert's views on a

matter of the kind. It gives us new beginners more zeal for the craft. I am at a loss to know what came over the first "Golden" virgin introduced, although I kept a sharp watch at the entrance, more particularly on the off-chance of seeing the queen come out on her wedding flight. All I saw, however, were one or two of the attendant bees cast ruthlessly from the hive. I introduced another "Golden" virgin, after leaving the old mother for a week or two, which has been accepted all right, but, although she has developed into a magnificent-looking queen, she has not deposited an egg, and as the old one did not lay since she came off with the swarm, the colony is reduced to a mere handful. I have, however, got a driven lot to unite with them, which I expect will put the stock in good condition for next season. The above-mentioned queen has been in the hive since August 14, and as there are no eggs deposited, would you, Mr. Editor, please inform me if you consider the queen has been fertilised and has not started ovipositing owing to the lateness of the season, or is she still a virgin? We have had a few very fine, warm days since she was released, and plenty of drones on the wing. The season has been a very poor one, and although I had all my colonies (except the one already mentioned) working on two racks of sections, not more than a dozen out of the forty-two are completed in the best cases. One lot gave me three completed sections from two racks, and all the others were drawn out and had some honey stored in each. I am closing down for the winter, and I hope, I suppose like all other bee-keepers in similar circumstances, for a better summer next year. I enclose a cutting from the *Glasgow Weekly Mail* which may be of interest to those who have not seen it. Is this a new source of revenue for surplus brood?—W. F. I., Ballindalloch.

CANNED BEES FOR EATING.

It has remained for the Japanese to introduce canned bees to the market—that is to say, the larvæ and young bees of a certain wild species (known as "jibachi") which dwell in holes in the ground. They are esteemed a delicacy, and are put up in tins like canned meat, the price asked being about sixty-five cents a pound.

The method whereby this kind of insect food is gathered consists of setting fire to small quantities of gunpowder at the entrance to the subterranean hives, in autumn—the fumes spreading through the underground chambers occupied by the bees and stupefying them. Then no time is lost in digging up the brood-combs, which are promptly covered with a cotton

cloth and placed for a moment in hot water to kill the insects.

Not only in Japan, but also in China and India, the larvæ of bees have long been considered a delicacy, the brood-combs containing the young grubs being greatly relished. In our own country such provender is likely to continue to lack proper appreciation—a fact not at all surprising when it is considered that we allow the great bulk of our possible bee-products to be lost.

These products in the United States represent a value of about twenty million dollars a year. Yet it is reckoned by trustworthy authorities that they would be worth at least ten times that sum if a sufficient number of bees were kept. A vast amount of honey and wax, unfortunately, is annually wasted for lack of bees to gather them. The bee-keeping industry, indeed, would easily yield two hundred million dollars a year, it is estimated, if its possibilities were utilised. And, incidentally, there would be an immense gain through the better fertilisation of plants which (in fulfilling their office as pollen-carriers) these useful insects effect.

The value of the beeswax output is by no means appreciated—this product being utilised for making artificial flowers, phonograph cylinders, ointments, pomades, and leather dressings, for beautifying floors and embalming the dead, and, by dentists, for taking moulds of people's jaws. One of its most important employments is in the manufacture of church candles, which must be of pure beeswax and no other substance.

[The probability is that the queen has failed to become mated: not at all an uncommon circumstance this season.—Ed.]

BEE-APPLIANCES AT COUNTY ASSOCIATION SHOWS.

[7621.] Seated by the sad sea waves, far away from the busy mart where we run a bee-appliance dépôt as a side line, writing on a desk formed by this year's issues of B.B.J. tied loosely together, I take up my pen to write and call attention to the fact that in several recent issues of the B.B.J. reports have appeared of the annual shows of various county associations. These reports give a full account of bees, honey, honey beverages, beeswax, &c., but no reference is made to bee-appliances, and as at one of these shows our firm displayed upwards of two tons of modern appliances, probably at other shows equally good exhibits were made and not reported.

An extensive show of bee-appliances is educational. Page 218 of the "Guide Book" says: "It would save much dis-

appointment, time, and money to many if advantage is taken of a chance visit to the 'Royal' Show . . . or failing that to any good county B.K.A. show, wherever held, before making a start with bees." Also, as the next paragraph suggests, a show of honey and appliances is the best background for the bee-tent. Truly a high commendation from one of the leading authorities in the world.

A display of appliances assists the expert, who, without any trouble to himself or the parent society he so ably represents, obtains the loan of a "W. B. C." or other up-to-date bee-hive, explains best methods of using same, and at the close of the lecture says: "Ladies and Gentlemen,—In the adjoining tent you will have an opportunity of inspecting a good show of modern bee-appliances," which being displayed near honey shown in its most attractive manner, interest is aroused, catalogues are distributed, and sales are effected, to the mutual benefit of all concerned. A display of bee-appliances also adds variety to the honey-tent; it just gives that comfortable feeling of all the space being fully occupied; it certainly represents much thought, preparation, and real hard work, as well as the investment of a considerable amount of capital, and is well worthy of notice in this journal, so ably devoted to the interests of our craft, to which source of information many bee-keepers prevented from personally visiting the show look for a full account. I enclose my name for reference.—APPLIANCE DEALER, Sutton-on-Sea.

A BEGINNER'S EXPERIENCES.

[7622.] I send the following account of my first year "with the bees," thinking that perhaps it might be interesting to readers of the B.B.J. I purchased a stock last season from a bee-keeping friend which came through the winter well. On May 9 they sent out a prime swarm, which I hived on seven frames of foundation. I very soon had to make these up to ten, and this evidently was not enough, for on June 17 another swarm issued, which I hived on six frames. They well covered these, and I thought after this I had done with swarms, but found I was mistaken, for on July 1 the original stock swarmed a second time. This made me think that the result of my first year would be plenty of bees and no honey, but in spite of the swarming propensity I have taken 60 lb. of honey, and this in a very bad season.

My friend above mentioned has a stock headed by a sister-queen to the one he sold me, which did not swarm at all, and he was able to take off three supers of shallow frames and two racks of sections, in all, I believe, about 110 lb. of honey.

Needless to say, I have got the "B.B.K. Guide Book," and with its help and (undoubtedly) the *right* strain of bees I have been able to make my first season a success.—C. FARMBROUGH, High Wycombe.

WAX-GATHERING IN MALAYA.

(Concluded from page 378.)

[7623.] "With the cessation of prayer work was commenced in earnest. The reason of the hundreds of pegs became apparent. Two feet from the base of the trunk a pair of pegs, standing abreast and a foot apart, driven well into the soft bark, formed the first rung of a ladder. Two more were quickly added at a height of eighteen inches. The man using a wooden mallet mounted his ladder as it grew, standing on the pegs and clinging by one hand as he drove a second pair above his head. The men relieved each other in turns, and the peg-driving went on quickly till from base to crown the smooth trunk was marked perpendicularly by an easily-negotiable ladder of pegs.

"From a waiting group of men, who had hitherto only watched the proceedings, the first of the hive-gatherers sprang forward, mounted the ladder, and, shining out for a great lateral branch, hauled up with a rope he had carried with him a large basket, which he slung to the limb beneath the first hive selected.

"The next step was to light a torch, which in burning gave off a thick cloud of white smoke. The bees had not yet waked from their slumbers: but when the man, holding his torch close to the orifice of the hive, rapped smartly on the waxen wall with a scimitar-shaped wooden knife, we could hear the angry buzz-z-z of the insects from where we stood a hundred feet below as they emerged in an out-rushing swarm. A rain of dead bees, meeting the fiery death of the torch, fell on our upturned faces. The great majority of those that escaped, stupefied by the narcotic fumes of the dammasoaked torch, were practically harmless. The man's body, too, had been carefully rubbed with a pungent essence, distilled from the leaves of the wild pepper-tree, peculiarly repellent to all the bee-tribe, and only about a dozen bees succeeded in getting home on him.

"Working the point of his knife between the rim of the hive and the wood, the hunter dropped the hive into the suspended basket, and it was quickly lowered to the group below. Far overhead was the noise of a myriad enraged insects, shrill and fierce.

"Fifty hives were taken on the first night, the men working in relays, and as with the dawn the million bees from out

of the hives, fully awakened, would be ready and eager for business; and as signs of the coming day were apparent, it was decided to leave the remainder to be brought in on a future occasion.

"The men below had not been idle. As each hive reached the ground the honey was quickly pressed from the wax, which was at once packed in bales for transport on the bearers' heads. No attempt was made to save the honey, nor did I see any eaten, though, even while hard at work, the men, scooping them into their mouths in handfuls, gorged great quantities of young bees, of which they are inordinately fond.

"Malays are splendid climbers, and, considering the hazardous nature of the work, accidents in the actual hive-gathering are remarkably few, though from a careless use of the torch or an insufficient anointment of the oil cases sometimes occur of a man, paralysed by many stings, meeting his death by a fall from a tree.

"The weight of wax in an average hive is eight or ten pounds, and from a good tree as much as a thousand pounds of wax is frequently obtained.

"In our case, the fifty hives secured on the first night yielded considerably over four hundred pounds, which, on our return to the village in the morning, was taken to the palace, weighed and valued, the Rajah finally distributing among his faithful subjects a sum equal to about one-quarter the value of the whole.

"The bee-hunting industry of Malaya gives annual employment to some thousands, and although little heard of outside those countries where it flourishes, and its market quotations find no place in the money-columns of the newspapers, it is, notwithstanding, a business of no mean importance in the Far East, and it is to the profits arising from the industry that the native rajahs and other potentates look for large part of their revenues. The wax, being of superfine quality, commands a ready sale in the China markets at a price equal to a shilling or eighteenpence per pound."

In drawing attention to this article on "Wax-gathering in Malaya," it occurs to me to put the query as to what race of bees these are. Wallace, in his "Malay Archipelago," mentions only one kind—*Apis dorsata*—and in a rather short notice of these infers that the colonies only build one comb measuring three to four feet. Mr. Frank Benton spent several years in the East investigating the capabilities of the various races of bees, and he reported on the "Giant" East Indian bee (*Apis dorsata*). He says: "All the varieties of these bees build huge combs of very pure wax, often five to six feet in length and three to four

feet in width, which they attach to overhanging ledges of rocks or to large limbs of lofty trees in the primitive forests or jungles. When attached to limbs of trees they are built singly." Query: Can we infer from this that this race of bees build several combs when their nest is under ledges of rocks?—R. WHYTE, Glasgow.

AMERICAN AND COLONIAL PAPERS.

EXTRACTS AND COMMENTS.

By D. M. Macdonald, Banff.

Judging Honey.—Here are Mr. Hutchinson's points for judging honey. Out of 100 he gives flavour 50, body 30, colour 20, when dealing with extracted. When judging comb-honey completeness of filling gets 20, flavour 15, straitness of comb 10, freedom from propolis or travel-stain 15, uniformity 10, neatness 10. It may be interesting to place alongside this the points likely to be given by good judges in this country:—Flavour 40, aroma 15, density 15, condition 15, colour 10, general appearance 5, equal 100. Sections:—Cleanliness and colour 30, completeness 20, capping 20, clearness of honey 20, get-up 10, equal 100. These are Colonel Walker's points. If we group flavour and aroma, then density and condition, and finally colour and appearance, we have a very close approximation on both sides as to what constitutes good extracted honey.

A Bee's Foraging-flight.—The editor of the *Review* says:—"The farthest I ever knew bees to gather honey was a trifle over two miles. Much may depend upon circumstances, but I believe that at least three-fourths of the honey in the market is gathered inside of a mile from the hives." That is the other extreme of Mr. Doolittle's five or six miles from choice.

Long Tongues and Energy.—"Bees reached down the tube of red clover with a determination to get at the nectar. If a few hundredths of an inch signifies much cannot the bee with energy and determination depress the top of the tube enough to reach the sweet?" The writer pleads that it would be better to breed energy in the bees and leave their tongues alone.

Honey-dew.—This is reported as very prevalent over a wide area of the U.S., and it is advised that bee-keepers should not try to sell this for honey, on account of the injury it would do to future sales, and because the bee-keepers would make themselves liable to prosecution. I trust the first reason will be a sufficient deterrent in this country.

Robber Traps.—Mr. Root is enthusiastic over a robber-trap he has invented:—"An ordinary hive is so arranged that

the bees can enter but cannot get out. Sweets are placed inside to bait all would-be robbers, who starve to death." Just so! But won't you punish the innocent with the guilty? All bees love sweets. Many bees with no thoughts of making predatory excursions against their neighbours will scent the hidden sweets, get trapped with the real robbers, and die ignominiously.

Queen-excluders.—Mr. Louis Scholl in *Gleanings* writes:—"Years ago I had to have queen-excluders to keep the queens down. Later I found that I was not only keeping the queens down, but the *honey also*. Since that time no excluders for me, and, although managing more than a dozen apiaries, I have not a single queen-excluder. I know that they are 'honey-excluders'" Recently I quoted Mr. Townsend's opinion, given in much the same words. If one studies out the cause of a queen going above, he will find a reason for her doing so, and the hives should be manipulated in such a manner that this is prevented.

Swarm v. Stock.—I am one of those who believe in the "superabounding energy of a swarm compared with the more sluggish working of even a strong stock." The words are Langstroth's. I quote from *Gleanings*:—"The greater energy of a natural swarm has been admitted by practically all authorities and writers. We have time and again noticed how a natural swarm will outstrip a colony of equal strength and of the same strain of bees." The foregoing quotations might be weighed carefully in the balance by a critic who recently took exception to similar words of mine.

Light Retarding Granulation.—A bee-keeper who retails about 15,000 bottles of honey annually, having trouble with the granulation of his produce, has adopted the plan of heating his honey under glass in the sun to such a temperature that in a week's time it will not granulate again. "Stenog" also found that bottled honey thus treated did not granulate, and he believes that light will at least retard granulation. Some who are now dealing with such honey might place an experimental half-dozen of bottles in a greenhouse or under a cold-frame cover and report if the heat of the sun has any appreciable influence in this way.

A Conference Number.—The July issue of the *Australian Bee-keeper* is entirely devoted to the Melbourne Conference, over forty delegates meeting and discussing numerous phases of the pursuit as carried on in the Southern Hemisphere. The most noticeable feature is the fact that the Ministers of Agriculture and Lands were both of them very sympa-

thetic, and promised to do everything possible to aid apiculture.

Young at Eighty.—Our (almost) octogenarian friend Dr. Miller has become Associate Editor of the *American Bee Journal*. Every one of our readers will rejoice to have his smiling face bound in the current volume of our JOURNAL. "Why is it that you don't paint your hives?" asks a querist of the venerable doctor. The reply is:—"I think there is better chance for the moisture to dry out of unpainted hives than out of painted ones." Never mind the authority you quote, doctor, but please explain the reason why you think so. Is it that the wish is father to the thought? Now, I am ready to contend the opposite. Damp, moisture, or mould is far more likely to find its way in, and stay there, in an unpainted than in a painted hive, other things being equal.

Echoes from the Hives.

I thought perhaps you might like to hear the result of my present season's "take" of honey in this district (North-west Norfolk), and I think you will agree with me that it is a very good yield for a year like the present one. I had eight stocks at the beginning of the season, and put on supers during the second week in May, with the result that I have taken 132 lb. of honey from my strongest stock, and from the eight stocks altogether I have taken 660 lb. Please stop my advertisement in the B.B.J. now, as I have sold all my honey.—W. H. RACEY, Wisbech.

Well-filled sections are very scarce. Highest "take" from one hive, from 40 lb. to 60 lb.; average much less; quality very good. Heather in small quantities. Retail prices for flower honey, 10d. to 1s. 3d.; heather much dearer.—ALEC LOW, East Aberdeenshire.

Notices to Correspondents.

H. E. S. S. (Cheltenham).—*Stores for Winter.*—1. A stock destitute of stores should be fed rapidly with 30 lb. of syrup (see "Guide Book," page 112). 2. The strong stock which has just lost its queen by accident should have one introduced at once, or be united to another colony having a queen.

A. R. C. (Connah's Quay).—*Bees Fed with Beet-sugar.*—You can do nothing now that the bees have been fed up and have six frames filled, and can only hope that a favourable winter will enable them to get through without much loss of life.

H. W. S. (S. Woodford).—“*Alexander*” Feeder.—We do not see your object in attaching this feeder permanently to the eke, seeing that this is generally brought into use after feeding has been finished, and when bees are being arranged in their winter quarters.

INQUIRER (Greenock).—*Thomson's Essay on Bee-keeping*.—We presume you mean “An Essay on Bees” by “Pan,” which was written by W. Thomson in 1882 as a prize essay for the Highland and Agricultural Society of Scotland. It was published in pamphlet form in 1884 by W. Munro, 50, Gordon Street, Glasgow.

J. P. T. (Trowell).—*Wintering on Shallow Frames*.—1. It is very risky wintering a small lot of driven bees on shallow frames. Keep the bees well protected, and place a frame filled with candy on the outside of cluster, putting the empty combs in centre. With the four full combs they should be sufficiently provided until the spring, when, if they have survived, you can slip a cake of candy under the quilt and renew it when consumed until they are able to collect enough for their wants. 2. They can be allowed to transfer themselves in the way recommended for bees in skeps (see page 150 of “Guide Book”).

MEL ROSÆ (Yarmouth, I.O.W.).—*Name of Plant*.—*Escallonia rubra*.

C. L. (Chichester).—*Parasite of Bee*.—It is probably *Braula cæca*, or blind louse, figured and described on page 169 of “Guide Book.” If you will send us a specimen we shall be able to tell. This parasite can be dislodged by strong fumigation of tobacco, after which the floorboard should be thoroughly washed several times with carbolic solution.

Honey Samples.

NEWCASTLE (Northumberland).—The bottle containing the honey arrived smashed and the contents had run out, so that we were not able to judge the quality. The season has been a bad one, and the honey-crop very poor in most districts, so that it is not surprising you have had so little honey, especially as you had eight swarms from your twelve hives. A great deal of honey has been discoloured by more or less honey-dew, and it is probable that yours has been so too. A small quantity does not injure the honey, but in large quantities it gives a disagreeable flavour, and it is then not marketable.

BURNT OAK (Surrey).—The honey is from mixed sources, rather dark, but good flavoured.

BACHELOR (Macclesfield).—No. 1 good-flavoured clover-honey with some lime. No. 2 was broken and all the honey lost.

YEO (Barnet).—Thick honey of fairly good quality, principally gathered from

limes. Contains a very small quantity of honey-dew, which has caused the dark colour.

R. A. (Oxford).—No. 1 is a pale white clover honey of good quality, though somewhat unripe in flavour; probably this is caused by the wet season. No. 2 is a beautiful sainfoin honey; very good indeed on all points. No. 3, very good honey, appears to be a blend of clover and sainfoin. All three samples are first-class honeys.

W. H. (Warwick).—Honey is poor in quality, being quite spoilt by honey-dew. It is not unfit for human food, though not very palatable, but should not be given to bees.

W. F. S. (Weybridge).—1. Honey very thin in consistency, almost like sugar syrup, and is intensely sweet. It contains no honey-dew, and could be used for the table, but possesses no distinctive flavour. 2. Most probably you are right as to the source of the light honey, but we cannot say without seeing a sample.

H. J. W. (Lancs).—Sample is a dark-coloured thin honey with a rank, unpleasant flavour, similar to that gathered from ivy. It contains no honey-dew, and could be used for the table if the flavour is not objected to. Might improve if granulated.

INQUIRER (Dulwich).—Sample is a light-coloured, thin, syrupy honey, with a pronounced flavour of limes.

INEXPERIENCE (King's Heath).—Dark honey of good flavour and consistency. It contains no honey-dew; the dark colour is the result of the sources from which it was gathered.

Suspected Combs.

H. I. M. (Rochester).—Foul brood in an advanced stage.

Special Prepaid Advertisements.

Twelve words and under, Sixpence; for every additional Three words or under, One Penny.

Advertisements for current issue must be received by first post on Tuesday.

WANTED, 200 1-lb. Sections or Screw Jars Pure Honey.—BAKER, Kingsley House, Tarvin, near Chester. u 64

SEVERAL NICE LOTS OF DRIVEN BEES, with young Queens, 5s. per lot.—SHELDON, Monmouth. u 67

ENGLISH HONEY, in any quantity. What offers? Good quality. Rather dark.—HASTINGS, Welcombe, Stratford-on-Avon. u 68

35 STOCKS OF BEES FOR SALE, as land must be vacated, 25s. each; also some empty Hives, including “Ford-Wells,” 20th Century Combination, &c., all standards; Section Crates, with Sections, 2s. each; with “W.B.C.” Frames and Sections fitted, 3s. Inspection invited. Will be present in Apiary Wednesday afternoons and Sundays.—T. HANSEN, Gardener and Bee Expert, c/o Mr. May, 2, Gladstone-cottages, Norwood Green, Southall. u 70

Editorial, Notices, &c.

THE BEE IN THE EARLIEST AGES.

Our correspondent Mr. J. Smallwood, in his interesting letter on page 394, asks: "Were there bees in the Garden of Eden?" We cannot say, but we do know that bees appeared on the earth before man. Those who are geologists know that the earth has been gradually fitted for its present inhabitants, that it was not always in its present state, and that many thousands of years elapsed before man appeared. The different periods in the world's history are clearly defined, and geology teaches us all that has taken place from the first dawn of life on our globe to the present day. Although it is impossible to give dates, it is possible to give the periods of the appearance of certain plants or animals. The geological formation called "Miocene" is wanting in England, and it is a more recent formation than our "Eocene," but both are referred to the Tertiary formation. In this formation are found the fossil remains of plants such as would be suitable honey-producers, and this for the first time in the world's history, as in formations of an earlier date than the Tertiary these plants do not occur, which shows that the climate of the earth was not suitable for them. As many of these plants depend upon insect agency for fertilising the blossoms it is natural to expect that insects capable of performing these functions would also exist, and as a matter of fact we find the fossil remains of numerous *Hymenoptera* also for the first time appearing. At Æningen on the Lake of Constance, where the Miocene strata are well represented, many of the fossil plants found there have a great analogy with the flora of the present day. There no fewer than 465 out of a total of 747 species have been found. The flora of the Miocene was much richer than that of the present day, and Professor Heer supposes that there must have been at least 3,000 flowering plants in the Miocene district. The quarries where these fossils have been found belong to the communes of Wangen and Schienen, but as the fossils were first made known through the monks of Æningen, the name of that place has been conferred upon them. The upper quarry, which is 700 ft. above Lake Constance, is the chief source of the fossil plants. We gave in the B.B.J. for March 15, 1884, page 94, a long list of plants found here which would have been frequented by bees, as well as a list of Hymenoptera found along with them, but what is of most interest to us as bee-keepers is that the honey-bee (*Apis adanatica*) also existed even at that early period, hummed about the flowers, and

without doubt lived in large societies in trunks of trees, built waxen combs, collected nectar and pollen, and fed its young as bees do now, for it is so like the living species (*Apis mellifica*) that it can hardly be regarded otherwise than as an ancestor of that species. Thus we see that at a very early date, previous to the appearance of man upon the scene, the honey-bee enlivened the world by its presence, and continued through subsequent geological periods to the present day without any change of habits. From the nature of the plants the climate of that time must have been considerably warmer than at the present day, and bees must have had a longer period of activity.

SURREY B.K.A.

SHOW AT CRYSTAL PALACE.

The fifteenth annual exhibition of the Surrey B.K.A. was held at the Crystal Palace on September 16, 17, and 18 last. The show was in every respect an admirable one, notwithstanding the drawbacks incidental to the past unfavourable season, and the display of bee-appliances, hives, honey, and honey produce was one of the largest seen at any exhibition this year. An interesting exhibit was one of educational value staged by the hon. secretary, and not for competition, illustrating every phase of bee-keeping from the first step to be taken on entering upon the industry. There were also very fine collections of hives and appliances, the exhibitors being Messrs. J. Lee and Son, Highbury; E. H. Taylor, Welwyn, Herts; C. T. Overton and Son, Crawley; and Mrs. Seadon, Bromley. A novelty was exhibited in the shape of a "bee-vaccinator," a contrivance for applying bee-stings for the cure of rheumatism. The instrument was fully explained and demonstrations given by Mr. F. B. White, the hon. secretary, on each day the show was open to hundreds of visitors.

Mr. C. T. Overton gave lectures and demonstrations in the association's beehive, situated in the transept, during each day.

The judges were Messrs. H. Jonas and J. Garratt, who made the following awards:—

MEMBERS' CLASSES.

Twelve 1-lb. Sections.—1st, W. F. Smith, Weybridge; 2nd, E. Bontoft, Caterham Valley; 3rd, C. D. Parish, Addington; v.h.c., Capt. Walsh, Bletchingley.

Six 1-lb. Sections.—1st, W. F. Smith; 2nd, Mrs. Trewby, Brixton Hill; 3rd, C. D. Parish; r., Miss Cochrane, Windlesham.

Six 1-lb. Sections Heather Honey.—1st, A. Seth-Smith, Cobham; 2nd, G. C. Bullen, Cobham; 3rd, Miss Unwin, Churt.

Three Shallow Frames of Comb Honey.—1st, H. Tobutt, Wallington; 2nd, W. E. Hamlin, Surbiton; 3rd, J. Kaehler, Woldingham; v.h.c., T. Earl, Horley.

Single Shallow Frame Comb Honey.—1st, A. Seth-Smith; 2nd, C. H. Moulton, Lingfield; 3rd, G. C. Bullen; r., H. Tobutt.

Single Standard Frame Comb Honey.—1st, F. B. White, Redhill; 2nd, C. H. Moulton.

Twelve 1-lb. Jars Medium-coloured Extracted Honey.—1st, A. E. C. Mumford, Redhill; 2nd, J. Birch, Windlesham; 3rd, C. D. Parish; v.h.c., John Kaehler.

Six 1-lb. Jars Light-coloured Extracted Honey.—1st, P. W. Worsfold, Shalford; 2nd, W. Holmes, jun., Windlesham.

Six 1-lb. Jars Extracted Heather Honey.—1st, M. J. Lamboll, Chiddingfold; 2nd, W. Hollands, Bagshot; 3rd, G. C. Bullen; v.h.c., A. Seth-Smith.

Six 1-lb. Jars Extracted Honey (Heather Blend).—1st, A. Baines, Bagshot; 2nd, W. Holmes, jun.; 3rd, M. J. Lamboll; v.h.c., W. Hollands.

Six 1-lb. Jars Dark-coloured Extracted Honey.—1st, P. W. Worsfold; 2nd, Miss G. Cochrane; 3rd, H. Tobutt; v.h.c., M. J. Lamboll; S. Silvester, Worcester Park; h.c., C. H. Moulton.

Six 1-lb. Jars Granulated Honey.—1st, P. W. Worsfold; 2nd, C. D. Parish; 3rd, M. J. Lamboll; v.h.c., H. Tobutt.

Six 1-lb. Jars Granulated Honey (Heather or Heather Blend).—1st, J. Birch; 2nd, A. Seth-Smith; 3rd, G. C. Bullen.

Display of Bee-products.—1st, F. B. White.

Beeswax.—1st, C. H. Moulton; 2nd, J. Birch; 3rd, A. E. C. Mumford; r., E. Bontoft.

Articles of Food in which Honey is an Ingredient.—1st, A. Hedger, Caterham Valley; 2nd, A. E. C. Mumford; 3rd, T. Earl.

OPEN TO MEMBERS WHO HAVE NEVER TAKEN A PRIZE FOR HONEY.

Six 1-lb. Jars Extracted Honey.—1st, W. J. H. Whittall, J.P., Godalming.

Six 1-lb. Sections.—1st, W. F. Smith; 2nd, C. F. Drabble, Belmont; r., Mrs. Dean, Windlesham; v.h.c., H. A. Cary, Leigh, Reigate.

OPEN CLASSES.

Six 1-lb. Sections.—1st, E. C. R. White, Newton Toney; 2nd, R. H. Baynes, Cambridge; 3rd, A. P. Short, Thornton Heath; r., G. Ingram, Broughton, Hants; h.c., John Rumball, Welwyn, Herts; E. B. Blaker, Worthing.

Six 1-lb. Jars Light-coloured Extracted Honey.—1st, W. J. Pritchard, Andover; 2nd, John Rumball; 3rd, R. H. Baynes; r., H. W. Saunders, Thetford; v.h.c., Rev. M. Osmaston, Dover; A. Brightwell,

Liphook; W. Holmes; h.c., A. P. Short; R. J. Sprake, Chale, Isle of Wight.

Three Shallow Frames Comb Honey.—1st, E. C. R. White; 2nd, H. Tobutt; 3rd, C. H. Curling, Chiswick.

Single Shallow Frame Comb Honey.—1st, H. Tobutt; 2nd, A. Brightwell; 3rd, Rev. C. H. Buxton, Thornton Heath.

Beeswax.—1st, E. C. R. White; 2nd, J. Rowlands, Pwllheli, N. Wales; 3rd, A. P. Short; r., John Rumball.

Observatory-hive, with Bees and Queen.—1st, Goodburn Bros., Millfield, Peterborough; 2nd, Mrs. Seadon, Bromley; 3rd, A. E. C. Mumford; r., C. Greenhill.

HIVES AND APPLIANCES.

Collection of Hives and Appliances.—1st, C. T. Overton and Sons, Crawley; 2nd, Mrs. Seadon; 3rd, J. Lee and Son, Highbury.

Complete Frame-hive.—1st, E. H. Taylor; 2nd, J. Lee and Son; 3rd, C. Greenhill; r., C. T. Overton and Sons.

Most Suitable Outfit for a Beginner in Bee-keeping (price not to exceed £110s.).—1st, E. H. Taylor; 2nd, Mrs. Seadon; 3rd, C. T. Overton and Sons.—F. B. WHITE, Hon. Sec.

Correspondence.

The Editor does not hold himself responsible for the opinions expressed by correspondents. No notice will be taken of anonymous communications, and correspondents are requested to write on one side of the paper only and give their real names and addresses, not necessarily for publication, but as a guarantee of good faith. Illustrations should be drawn on separate pieces of paper. We do not undertake to return rejected communications.

AMONG THE BEES.

"TO PASTE IN YOUR HAT."

[7624.] "Amongst his counsels on practical manipulations he ever enjoined *Forethought*—never to touch a hive without a definite object, then to have all needful appliances ready at hand; *Caution*, which includes a quiet and gentle, but none the less firm method of getting to work; and *Thoroughness*, or never to leave work until it has been thoroughly and completely done in every particular." [These wise words were written by our Senior Editor in regard to our late Junior Editor, "W. B. C.," when introducing him as the conductor of the *Record*, nearly twenty years ago.]

According to computations made by Professors Marey and Landois it may be estimated as not far from the truth to say that bees can fly about thirty miles an hour, and that during their absence of twenty minutes from the hive they may fly about ten miles. Most practical bee-keepers, however, believe that they rarely journey further than one or two miles from home when foraging." ("Science and Practice.")

There are only two varieties of bees worthy of consideration for use in the United States (or this country), and they are the Italians and the Germans, or blacks, as they are commonly called. ("Advanced Bee-Culture.")

Every bee-keeper who has had experience with several strains of the same variety knows that some are far superior to others. With "scrub" stock the cost of hives, combs, and other appliances remains the same. It is no less work to care for such stock. They consume as much honey. No investment brings the bee-keeper greater profit than *superior* stock. (*Ibid.*)

The beginner should never attempt to start on a large scale. He should commence with one or two hives, increasing the number as he gains knowledge and experience. ("Guide Book.")

The successful management of bees depends on having every colony strong, and strong at the right time. (*Ibid.*)

All intending to keep bees should bear in mind the important fact that bee-culture is a business to be learnt like any other trade or profession, and success depends in a marked degree upon knowledge and experience. (*Ibid.*)

The culture of bees in Britain has never yet arrived at anything near the degree of perfection to which it is capable of being brought, and it is practicable to increase our bee-hives twenty-fold, if not to fifty times, the present number. (Bonnar.)

In doubling the population for wintering I naturally expected that we must also double the quantity of food, but to my great astonishment, when I weighed them in spring, I found that the united lots had not consumed more than each would have done singly, and this result followed hundreds of similar experiments. (Gelieu.)

At my initial start in bee-keeping I purchased "Langstroth on the Honey-Bee." What a gold-mine that book seemed to me as I read it. Never was romance so enticing, and, best of all, right at my own home I could live out and verify all the wonderful things told therein. (A. I. Root.)

Violent handling of bees is simply an evil. Bees of all creatures love cleanliness and peace. Therefore handle them leisurely and quietly, and you may do with them what you will. (Lawson.)

Keepe none weake, for it is hazard with losse, therefore put two weake swarmes or lots together. (*Ibid.*)

I would advise you to disturb your bees as little as possible during winter, for it does much mischief if they are disquieted. (Maxwell.)

With some little care and attendance, which need be no hindrance to other business, but rather a delightful recreation, bees bring in a store of sweet delicacies most wholesome both for meat and medicine. For cleanliness and neatness they may be a mirror to the finest dames. (Butler.)

A bee amongst the flowers in spring is one of the cheerfulest objects that can be looked upon. Its life appears to be all enjoyment, so busy and pleased is it. (Paley.)

The most incomprehensible part of the process is that increasing the size and changing the direction of the cell and feeding the larva with a more perfect food should not only allow the sexual organs of the insect to be fully developed, but should alter the shape of the tongue, the jaws, and the sting, deprive her of the power of secreting wax, and obliterate the pollen-baskets. (Bevan.)

No other branch of husbandry will return so large an interest with so small an expenditure. (Keys.)

Bees are a nation of chemists to whom Nature has communicated the rare and valuable secret of enriching themselves without impoverishing others. (White.)

Swarm from your best stock. This is a golden rule too often forgotten. You thus get a good queen for the swarm, and her good qualities will be continued in her successor. Swarming from a poor stock is perpetuating the progeny of an effete queen and keeping the apiary under a star of ill-omen. (Cheshire.)

Feed when necessary to save the existence of a stock. As an ancient writer quaintly puts it, "Don't lose a hog for a halfpennyworth of tar." or you may lose a good stock with 60 lb. of honey. This is to be penny wise and pound foolish with a vengeance. (Warder.)

If a weak colony in spring or autumn is found to be queenless it is at once broken up, brood and bees being given wherever they may be needed, and I heave a sigh of relief to think that I am rid of a weakling. (Dr. Miller.)

From my record-book I can tell more or less of the history of every colony since I began bee-keeping. I can do a good deal of my work in the house with my book, studying and planning. The memoranda are ever at hand at the home or out apiary. (*Ibid.*)

All eggs which come to maturity in the two ovaries of the queen-bee are only of one and the same kind, which, when they are laid without coming in contact with the male semen, become developed into male bees, but, on the contrary, when they are fertilised by the male semen, they produce female bees. ("Parthenogenesis," Dzierzon.)

Through good and bad, early and late, for steady, dogged industry, invincible hardihood, tangible results, the black bee has outdistanced all competitors. ("Lore of the Honey-bee.") — Collated by D. M. M., Banff.

WERE THERE BEES IN THE GARDEN OF EDEN?

[7625.] "The honey-bee, through its useful products, has been known and cared for by man for centuries. Philosophers have written about it, poets have sung its praises, and naturalists have studied it during past ages, until there is probably no other insect with which man has so intimate an acquaintance." — Comstock, "Studies of Nature."

Turning over the pages of American publications anent insect life, I came across the above quotation. How interesting it would be, methought, to see what poets and philosophers have written and said about bees! But what an abundance of riches! I found I could only skim the cream, for it would seem as if all writers had something to say about them and some comparison to draw from them. "To point a moral or adorn a tale" of perseverance and industry the busy bee was always at hand.

But to begin at the very beginning. Those learned in euneiform characters maintain that chronicles written in them existed even before Scripture. For my purpose the latter is sufficiently ancient. At the time when the Almighty created everything after its kind, when the sea drew away from the land, and each became populated with its inhabitants—fishes in the sea, and on earth animals and creeping things—then first winged its melodious flight the bee. Milton tells us how first came the emmet:

Swarming next appeared

The female bee, that feeds her husband drone
Deliciously, and builds her waxen cells
With honey stored.

Reference to "Paradise Lost" naturally tempts the question, "Did bees dwell in the Garden of Eden?" Of a certainty it is difficult to say. Neither Adam nor Eve has left a record, but there must have been, for Milton again narrates how our first parents entertained the Archangel Raphael, offering the choicest fruits of Paradise, and we all have read how Eve was tempted to eat of the apple. Now, without bees flowers—the precursors of fruits—would not have been fertilised. We can only argue from such circumstantial evidence, but the testimony is sufficiently strong for me to claim that I have proved my case.

An incident of a later date helps to strengthen my theory. When, wandering in the desert, the Israelites clamoured for

food they were fed with manna from heaven, "and the taste of it was like wafers made with honey" (Ex. xvi. 31). It is generally assumed that the Garden of Eden was in the celestial plains of Heaven. Without bees, it is needless to say, there could have been no honey. Is not this convincing?

The paradise promised by Mahomet to the faithful follower of Allah is filled with palaces where houris of ravishing beauty minister to his wants; the Indian who roams the prairies dies contented in the thought that he passes to happy hunting-grounds where buffalo and deer abound; and the bee-keeper—will he be able to pursue his hobby when he arrives in the Better Land (and may they be legion)? Will he find numberless hives untainted with foul brood, and will there be bee-associations and a bee-journal? But I fear I am approaching a delicate question. Wisdom warns me not to pursue it further until I am better informed.—J. SMALLWOOD, Hendon.

BEE-KEEPERS AND COUNTY ASSOCIATIONS.

[7626.] Referring to this interesting subject, I must say that, to me, "Beginner's" letter (page 295) is rather absurd. Why did he not report the expert to his county association and get his explanation before making public so grave a charge? I will give one of my own experiences as expert on tour as an instance of the other side of the case. In our association we have various branches, and early in 1908 the hon. secretary wrote asking if I would visit a member and add his name to my branch. The member lived about sixteen miles from my home, but I accepted, hoping to obtain more members in course of time. I made one visit on May 30 and another early in September, when he gave me a list of beekeepers in the neighbourhood. I organised evening C.C. lectures, cycling over to the first, at which there were sixty present. This year I sent him a postcard as usual, and visited his apiary on May 29, but found him from home, having left no instructions. I again sent a postcard in July to notify a visit on July 30, but I was overtaken by rain and had to return home. I sent a postcard notifying a visit on September 4, and again found him from home. On reaching home I found a card saying he had ceased to be a member, finding he could obtain help in his village. Results were: 190 miles' cycle ride for 3s. 9d., to association 1s. 3d. (twice getting wet through), and on no occasion was I offered refreshment. Very encouraging to have members in any county association like this.—EXPERT, Somerset.

CARRYING BEES ON MOTOR-CYCLE.

[7627.] I enclose a photo of my motor-cycle, which I use for long journeys to fetch driven bees or swarms, though it is equally suitable when used for short distances. Finding the ordinary pedal-bicycle very tiring in the busy season, when a number of lots have to be carried at a time, I decided to fit a suitable carrier to my motor-cycle (a 6 h.p. "Bat"). This was made to project about 2 ft. 3 in. out at the back, and in the cross stays of the top of carrier were drilled a number of screw-holes. I then made three boxes, each 7 in. high, 9 in. wide, and 1 ft. 2 in. long; these are laid crosswise on the carrier, secured with screws from the under side; perforated zinc is fixed on either end of the boxes, one end being movable

CURRENT TOPICS.

[7628.] *What is a Strain?*—Speaking of a driven lot of bees Mr. Woodley says: "I shall perpetuate that strain next year by breeding from them." Is not this rather a loose way of using the term "strain"? For how can a casual lot of driven bees be properly so called? I should be inclined to define the term as follows: A strain is a race of domesticated animals which have been carefully line- or pedigree-bred through a number of generations for certain points of excellence (real or "fancy"), and, if possible, with no admixture of alien blood. Now, supposing, for the sake of argument, that Mr. Woodley has hitherto kept his stock without such alien admixture, and consistently bred from his best honey-gather-

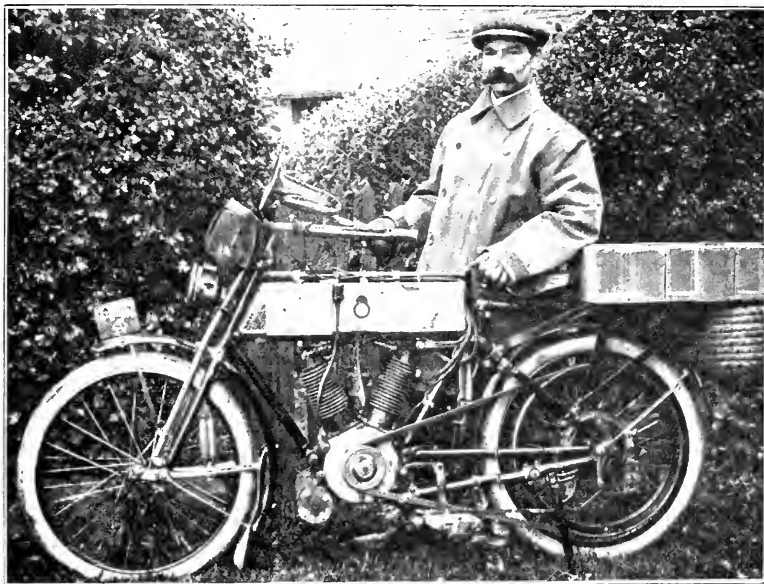

CARRYING BEES ON A MOTOR-CYCLE.

for getting the bees in and out. To make this operation more rapid I generally carry a zinc hopper (made in sections to screw together). The bees are shaken into this; they then slide into the box, and the lid is on before they know what has happened. The skip shown underneath at the back is to carry the tools, and for use as a driving skip. If, however, more bees are driven than the boxes will accommodate, one or two lots are left in the skip, the mouth covered with strainer cloth, and strapped under the carrier the other way up.

In conclusion, I may say the "Bat" motor-cycle is fitted with spring frame and spring forks, which remove all fear of too much vibration, as they run much more smoothly than the pedal-cycle.—
F. E. MATTHEWS, Northfield.

ing stocks, he is then in danger of destroying the work of years by introducing a factor without, in all probability, knowing anything about its breeding potentialities, but solely because the stock in question has proved itself good at honey-getting during the current season.

Many queen-breeders also speak of their "strain" of bees, although, even if they could control fertilisation, their practice of continually introducing imported queens precludes their ever having a just title to the use of the term. For there can be no pure strain of bees till the breeder is able either to control fertilisation or to ensure the perfect isolation of his apiary.

A Plea for the Wallflower.—Now is the time to plant out these in their permanent quarters. I think every bee-keeper with a good-sized garden should

grow a few hundreds, or, better, thousands, of these charming spring flowers. Their delightful scent and richly-variegated blossoms will well repay the labour entailed in their culture, to say nothing of the pleasure of watching the bees work on them when the days are lengthening. For are not flowers one of the very few things *purely* reminiscent of a lost Eden? Well for us all would it be, then, if we oftener bore in mind the words of Goethe: "Take care of the beautiful, and let the useful take care of itself."

A Threadbare Topic.—No, Mr. Crawshaw (page 379), the writer of the words you do *not* quote aright has not, I think, got into any "verbal scrape." But may I ask, O Most Potent Juggler with Words, *why* you have conjured away the small, but in their place important, words "so much" in the mutilated sentence you quote? Or, to put the matter in another way: How can you, having taken "so much" *out* of the sentence, reasonably expect "much" (sense) *to be left in*?

Glazing Sections.—Thin starch is generally recommended for this purpose, but it should not be too thin, only thick enough to "jelly" when cold. Its sticking powers will be improved by adding a little *white* glue. Brown glue should not be used, as it is liable to impart a yellowish tinge to the paper.—SAML. P. SOAL, Rochford, Essex.

YOUNG QUEEN TWICE MATED.

[7629.] I send you some notes taken on the above subject, which has exceedingly interested me.

On June 25 I made a baby-nucleus hive with a section and two pieces of glass over the sides, so that I could see all that was going on within. In this I placed two to three table-spoonfuls of young bees and a young virgin queen. I placed this little hive in the window of my workshop, making a hole in the window-frame for the bees to go in and out, and as the whole of the front of my workshop is of glass I was able to watch carefully all the movements of the bees.

On June 29 I saw the young queen come out of the baby-nucleus hive five times. She flew round the entrance for a few seconds and then darted off, staying away only a few minutes, but the last time she left the hive she was away for five minutes, and returned mated; this was at five minutes to four o'clock. The fact of her having mated was so unmistakable that a friend who stood by watching her flying in and out noticed it, although knowing nothing about bees. It was on this day when she re-entered the hive that I heard her distinctly trumpeting. I saw the worker-bees crowd around and examine her with the greatest interest.

On June 30 I saw the young queen fly out five times; the longest flight lasted only five minutes. On July 1 she came out twice for short flights; then she came out again at 4.20, and returned after having been out twenty minutes. On this occasion she returned mated a second time. Thinking that this possibly might take place, I called the gardener, who was working in my garden close by, to watch with me for her return. Again the marks of her having been mated were most distinct, and we both saw it as she entered the little hive; then she crouched her body on the comb and trumpeted, which the gardener, who was standing near, also noticed. The bees showed the greatest interest in her condition. I may add that the air was alive with drones from my fourteen hives—some yellow, some dark, but the majority of them dark this year. In all, this young queen was seen by me to leave the hive thirteen times.

July 2 was cloudy and not so warm; so also the following days.

I did not notice the queen leave the hive again. She began to lay some days afterwards; the young bees produced seemed to be all dark. I noticed very little commotion in the little hive when the young queen flew out; with other hives the bees seem to me to get into a great state of excitement on those occasions. The above supplies to me a satisfactory explanation of what has been so long a perplexity. I have found the same queen the mother of brown and yellow workers, and I believe also of brown and yellow drones. Had this queen mated at one time with a brown drone and then with a yellow she would have had a mixed progeny, I should suppose. As it was, she must have mated each time with a dark drone, for, as I have already said, her progeny were all dark. This also has been the case with three other young queens from the same hive. The mother of these was a yellow queen; the grandmother was one of Mr. Sladen's golden bees. Now it seems to me, according to the law of parthenogenesis, that these four young queens should produce yellow drones next year, although all the worker-bees that they have produced this year are dark. If I find that this is not so, and they all produce dark drones, I shall feel still more doubtful than I feel at present as to this supposed exception and that of the aphid to the general law of Nature.

Fertile Workers.—Is it not possible that many workers may be fertilised, but not in the same way that a queen is, and that such workers only lay eggs under certain conditions?

When looking over the hive from which I took those young queens in September of last year I was surprised to observe a

single drone. In some way it must have been passed over at the general massacre, and I expect would have been permitted to live on through the winter: in this way drones may be flying at any time of the year when weather permits.

Bees in the Orkney Islands.—I have noticed plenty of humble-bees there, but I never saw hive-bees, nor yet in the Shetland Islands. I understood at the time that they had been introduced to Orkney, but could not stand the climate. I refer to some thirty years ago. I think they would do well for two or three months in the summer. It would be a good place for the raising of any special strain of bees, as they would be completely isolated. So also would Ailsa Craig, which lies about ten miles from the mainland off the Ayrshire coast.—HUMBLE BEE, Bridge of Allan.

[A queen need not be mated in such an exceptional manner by two different drones to have a mixed progeny. A yellow queen mated with a black drone will produce both yellow and black workers, and a queen reared from her will produce not only mixed workers, but drones also. It was not necessary for your queen to be mated to a black drone to produce dark workers, as her mother was probably mated to such a one previously, and she was consequently not pure. This queen and the three others are the granddaughters of your original yellow queen, and as their mothers had already mated with dark drones, it will be quite natural, according to the law of parthenogenesis, for them to produce black drones next year. The anatomical structure of a worker's ovaries makes it impossible for them to be fertilised by a drone, and as they start laying when there are no drones in a hive, it is proof that they do not mate with one. It is not unusual to find a drone in September, especially in queenless hives, but we have never had an instance of drones being kept through the winter in hives in a normal condition.—ED.]

ROBBER TRAPS.

[7630.] Mr. D. M. Macdonald, in his "Extracts and Comments" (page 388), refers to the trapping of robbers, and pities the poor innocent bees who get trapped with the marauders and are destroyed. I think the sympathy is entirely wasted, as the bees which enter a robber-trap, which generally takes the form of a hive, are bees who have the tendency to become robbers, and if allowed to fall into temptation would in an extraordinarily short time teach some of their companions to rob as well. Anyone who has had a large number of hives in an uproar through an oversight will not waste

pity on a few bees which have the robbing tendency, but will take every precaution to prevent robbing starting. I passed through such a trouble in my early days, and never will risk another experience of the same kind.—D. G. TAYLOR, Ilminster.

HIEROGLYPHS OF THE BEE.

[7631.] I was very interested in the article which appeared in the B.B.J. of July 8 (page 264) under the title of "Hieroglyphs of the Bee," and forward for your inspection an ancient coin on which a bee is clearly delineated.

This coin is a drachm from Ephesus, and dates from the fifth century B.C. It



is a scarce coin, as are all small denominations from the East. Its weight is 48.1 grains. On one side is $\text{E}\phi$, or bee; on the reverse side an incense square, which shows great antiquity. The square wings

of the bee are to be noted.

It is hardly necessary for me to add that the bee was a symbol of the old Asiatic nature goddess (Artemis of the Greeks and Diana of the Romans). Head, in "Historia Numanorum," writes: "The high-priest of the temple of the goddess was called the King Bee, while the virgin priestesses bore the name of 'Melissæ,' or bees."—(MRS.) E. A. B., Devon.

CAPPINGS OF COMB.

BY L. S. CRAWSHAW, NORTON, MALTON.

Bees and Pollen (page 334).—This interesting letter is a welcome contribution to our knowledge. Many of us get into the bad habit of taking for granted the truth of what we are told. Even if it be true, there is a personal gain in putting it to the test. Belief by experiment is far more our own, and correspondingly useful, than a mere acceptance of dogmatic teaching, however true. I am much interested by Miss Betts's ingenious method of obtaining the pollen. I have often missed a much-desired bee close to the entrance as it has hastened from my clumsy fingers. But this light-fingered highway robbery would hardly discommode the travelling bee, whose surprise may be imagined when, safe at home, it discovered its empty trousers pocket!

Night and Morning Work (page 338).—Many bee-keepers, even those with spare time, might obtain better results if they would confine their manipulations to the evening. Robbing would be avoided, and stocks would settle to a full day's work after the night, instead of being upset for hours when the honey should be rolling in.

Robber-trap (page 344).—I have had one of these for several years. It is exactly like an ordinary hive when complete, as it takes the usual lifts and roof. But the inside body, which takes standard frames, is thoroughly ventilated, and a dropping floor board allows the insertion of a wide super-clearer the reverse way. I see that E. R. Root recommends that trapped robbers should be destroyed; but I have kept them confined for several days, or a week, introducing a queen in the meantime, and later treating as a nucleus with success. In fact, I have often made nuclei by the simple process of allowing the trap to replace a stock for a short time.

Jar or Far (page 346).—Oh, wicked comp.! It is fortunate for thee that thou art so far, or thou shouldst indeed know the meaning of jar! I would give thee "a good hard knock in a minute." For thou hast further obscured an already sufficiently obscure title. Not that I am blameless! My f's and j's are no doubt much alike, and some of the letters of my hastily-written copy may be already so far gone as to be easily made into jargon! Therefore I pray thee of thy charity, if thou be a judge of fudge, remember my f's and j's as thou wouldst thy p's and q's, and I will discard my much-loved "J" pen for a good F pencil so that there may be no more discrepancy between "fist" and "gist."

A Remarkable Stock (page 357).—Is it possible that this stock did so well *because* of its treatment and not in spite of it? Latest advices from America advocate shaking as a stimulant. Every two or three hours is about the right time to do the work, and once or twice extra in the night-time should you happen to be wakeful. It keeps the bees from going to sleep, and they work far the harder the harder the jar. (Please be careful, Mr. Comp.) An appropriate label for these honey-jars might be, "We press the bees, and they don't do the rest."

Chaff and Corns (page 367).—It is not everyone who desires to have his mental meal entirely separated from the lighter products of the grain, or that it shall come ready peptonised in the most concentrated form. Believe me, digestion should be a pleasure, or the organ should be given a rest. I am sorry that Mr. Martin does not appreciate the value of chaff, for it is just possible that I may be one of the offenders, although I cannot, of course, be sure of this! But he is mistaken in supposing that chaff is unconnected with bee-keeping. It has often been eulogised for the purpose of keeping the heart of the hive warm, and the present chaff has the same beneficent purpose towards the bee-keeper! We know that chaff is not so valuable as

grain, but even chaff has its value, although it should not be intended to go against the grain! Even the good ground grain itself may be as dry as dust until we introduce the ferment that will lighten it for easier consumption. But it is a question of the spirit of the thing, or of the letter, if you like, for chaffing should never be chafing, even in the heated threshing out of much-discussed kernels.

Queries and Replies.

[3972.] *Amount of Stores for Wintering*.—Respecting the instructions in the "Guide Book" that about 2 square feet of honey is sufficient for winter stores, I do not think this can be laid down as a general rule. Last winter a local bee-keeper left six frames of solid honey as stores, but found when he opened the hive in the spring that the bees were dying of starvation. Is it possible that some bees are gluttons, and "take no thought for the morrow"? The race in question were ordinary blacks. I have a very nice late swarm on six frames. These have stored a quantity of honey from flowers and the feeder, but are rather slow in capping it. I suppose they will do this before the cold weather comes on? Your remarks in the B.B.J. in due course will oblige.—PHILIP F. JONES, Gloucester.

REPLY.—You are referring to an old edition issued in 1901, since which time there have been 24,000 copies of the "Guide Book" published (the last edition being entirely rewritten), in all of which it has been recommended to leave 30 lb., or 3 superficial feet, of sealed honey, as it was found, owing to the carelessness of some bee-keepers in preparing their bees for winter, and a want of judgment in others, the smaller quantity could only be relied on in the hands of the experienced. On page 113 of the "Guide Book" are given very full directions as to the amount, and it is added for those not able easily to estimate by appearance that the bee-keeper may judge approximately by having the two outer combs well filled and sealed and six other frames about half-filled with stores. We have always found this more than sufficient for safe wintering, if other conditions are carefully attended to. Keep the hive warmly covered and confine the bees by means of division-boards to as many combs as they can comfortably cover. If fine weather continues they may seal over some more cells.

[3973.] *Fertilisation of Queen*.—Being a constant reader of the B.B.J., would you kindly explain the fol-

lowing peculiar movements of a queen? I had her in a small nucleus hive, and observed her flying one warm sunny day about seven times, and she returned to the hive after each flight. She must now be over five weeks old, and, although I saw no signs of eggs, I put her and her bees into a queenless hive. She seemed to be accepted by the other bees, as the next afternoon we saw her running about on the frames. However, the following afternoon I saw her on the floor-board of her old nucleus hive. What would be the explanation of her acting like that? I returned her to the queenless hive this afternoon, the bees seeming to make no objection. I am afraid she may come out again and get lost. The queenless hive I put her into had been so for six weeks, and, thinking the queen would require some young bees, I put a frame with brood in different stages into the hive also. Would this have made the bees expel her? There are a great many drones in the hive, and if the bees have started a queen-cell will the queen get fertilised?—STROMA, Aberdeen.

REPLY.—The explanation seems simple, as the queen does not appear to have mated. She was reared the third week in September, and flew out from her nucleus without mating. After your introducing her to the queenless colony, on flying out again she returned to the old spot, previously marked, which she had become used to. If still unfertilised she is quite likely to return to the nucleus again if she flies out. It is sometimes very difficult to get queens fertilised so late in the season, but as there are drones in the hive she may yet meet one. It is too late to expect a queen to be hatched from the brood you have given the bees, and to have her fertilised.

Notices to Correspondents.

Letters or queries asking for addresses of manufacturers or correspondents, or where appliances can be purchased, or replies giving such information, can only be inserted as advertisements. The space devoted to letters, queries, and replies is meant for the general good of bee-keepers, and not for advertisements. We wish our correspondents to bear in mind that, as it is necessary for us to go to press in advance of the date of issue, queries cannot always be replied to in the issue immediately following the receipt of their communications.

DERBIENSIS (Derby).—*Fertile Worker and Drone-breeding Queen.*—A worker-bee becomes an egg-layer without fertilisation by a drone. An unfertilised queen only lays eggs which produce drones, and such drones have the power of reproduction. The question of parthenogenesis was very fully discussed on

pages 51 and 62 of this year's B.B.J., and you will also find it in "The Honey-Bee," page 143.

L. N. D. (E. Yorks).—*Honey in Brood-combs.*—1. Such honey is not fit to eat without being extracted, as the midrib, being brood-foundation, would be too thick and tough. 2. Sections can be easily extracted if the cages of the extractor are wide enough to take them.

G. T. G. (Aldershot).—*Uniting Bees.*—1. You can unite English bees to the nucleus without caging the queen if you follow instructions in "Guide Book" and thoroughly dust the bees with flour. 2. Make an artificial swarm of all the bees in the queenless stock. Dust the other stock, and proceed as recommended in second paragraph on page 107.

NORRS (Stapleford).—*Granulation of Honey.*—The white frothy appearance is due to the air not escaping and the shrinkage of the honey during granulation. It can be avoided by stirring the honey while it is granulating, thus causing the air-bubbles to rise to the surface.

E. G. (Peterchurch).—*Wintering Bees.*—The section-crate with calico tacked on the bottom will do very well, but we would prefer chaff to the wood shavings (see page 191 of "Guide Book").

BEE-KEEPER (Cornwall).—*Fumigating Section-racks.*—Burning sulphur will answer if it is thoroughly done, and you should afterwards paint the racks with the carbolic solution No. 10 ("Guide Book," page 198).

H. L. D. (High Wycombe).—*Dealing with Foul Brood.*—As yours is a slight attack, you should remove combs that are affected and leave the bees for treatment in the spring when they have commenced brood-rearing; then you can follow directions in "Guide Book." As you have mixed up your racks, you should disinfect them all. The disease cannot be in a forward condition, as you have had a swarm and 60 lb. of honey from the hive.

HORNET (Hineckley).—*Rapid-feeding.*—Feeding should be finished now, but if you have to do it give the syrup warm, and the bees will seal most of the cells. Unless there is much unsealed comb it is not necessary to remove it, as the bees will first consume the honey from the open cells. If, however, there is a good deal, the combs containing the unsealed syrup should be removed.

J. W. L. (Keswick).—*Name of Plant.*—The balsam is *Impatiens roylei*.

INQUIRER (Teddington).—*Queen-fertilisation.*—The spermatheca was quite clear, showing that the queen had not been fertilised.

MANNOD BACKS (Festiniog).—*Name of Wasp*.—It is a queen, *Polistes gallica*.

T. A. B. (Tarvin).—A *New Bee-tree*.—The tree alluded to by "P. Hilarbor" is *Saphora japonica*, and he has given the gist of the article in his description "in ye auld King's English," so that you do not lose anything by not understanding the extract in the original.

E. W. D. (Ilford).—*Hive Construction*.—Half an inch below the frames is quite sufficient during summer. For wintering it is advantageous to raise the hive on to a 3-in. eke.

J. R. (Consett).—*Variety of Bees*.—The bees sent are common black bees.

A. A. H. (Alresford).—*Suspected Disease*.—The bees appear to be perfectly healthy, and excrement normal. They arrived in good condition, with not a single dead bee in the box.

E. M. G. (Ventnor).—*Diseased Bees*.—We are much obliged to you for the bees. The plan you propose could be tried, but we doubt if anything can be done so late in the season. Earlier bees could be treated in this way and encouraged to build new combs with some hope of success.

Honey Samples.

S. J. (Stafford).—We should not call it first-class honey, although there are some who would like the slight heather flavour, and the consistency is good.

E. M. (Wolverton).—Both samples are medium in colour. No. 1 is of fairly good flavour, but lacking in consistency. No. 2 is a very nice dark honey of good flavour and consistency. The wax is not of sufficiently good quality to exhibit: it is very dark and the aroma only fair. Mr. Cowan's book "Wax Craft" gives directions for refining wax.

BATCHELOR (Macclesfield).—Sample is of good colour and flavour, but lacking in consistency. From limes and clover.

J. F. F. (Muswell Hill).—A dark honey of good consistency, with a flavour of limes. The colour is spoilt by a small admixture of honey-dew. Quite fit for table or for feeding the bees.

LINDSEY.—Sample is a light honey from clover and rape. It is rather thin, and has a slightly watery taste (probably due to the wet season), but otherwise the flavour is good. Would be a better show honey if granulated.

D. C. (Hertford).—Nice-flavoured granulated honey, rather coarse in grain. From mixed sources, but partly from limes.

L. C. (Leyland).—An almost white honey of little flavour and thin consistency. Probable sources mustard and rape.

BANBURY. No. 1 is a very light-coloured honey from mustard or rape. Begin-

ning to granulate; flavour rather insipid. No. 2 is a much better honey, of good flavour and colour, but lacking in consistency.

CARRINGTON.—Sample is a dark honey of fair flavour, but thin and almost watery in consistency. It contains no honey-dew.

F. H. B. (Stechford).—Honey of nice flavour and fairly good consistency. Though dark in colour it contains no honey-dew, but the particles of wax should be strained out if intended for show purposes.

F. J. M. (Wokingham).—Light amber-coloured honey of fairly good flavour. It is beginning to granulate, but if quite liquid we should think it would be rather thin.

E. J. S. S. (Birmingham).—1. The three samples are good in colour and of fairly good flavour, but of poor consistency. There is no well-defined flavour about any of them. The uncapped honey is starting to ferment, and as it is in this condition and contains a little honey-dew it should not be given to bees now. If you can keep it until the spring it might be used if boiled and mixed with thick syrup. 2. Wasp stings are often most dangerous to human beings, sometimes causing blood-poisoning and even death, as these insects are scavengers, and not clean feeders like the honey-bee.

W. S. W. (Birstwith).—The honey is of very poor quality, and contains enough honey-dew to render it unfit winter food for bees. It could only be sold for manufacturing purposes at a very low price, and even then you might have difficulty in finding a purchaser, as so much of this unsaleable honey has been gathered this year.

A. M. (Woodford).—The honey is dark and thin, and has been discoloured by honey-dew. It would, however, do for making Scholtz candy for use in the spring. The flavour is agreeable and quite palatable.

Suspected Combs.

J. A. C. (Thankerton).—Cells in comb sent contain foul brood. As you have drawn-out combs, you can remove the bees from present hive and confine them for forty-eight hours in a box or skep, and then put them in a clean hive on the drawn-out combs, and feed with warm medicated syrup. It will be sufficient to disinfect hive and dummies, but destroy coverings (see "Guide Book," pages 180 and 181).

J. G. C. (near Birmingham).—The comb is affected with black brood.

** Several important letters, &c., are in type, but held over from pressure on our space.

Editorial, Notices, &c.

BRITISH BEE-KEEPERS' ASSOCIATION

The monthly meeting of the Council was held on Thursday, October 7, in the board-room of the R.S.P.C.A., 105, Jermyn Street, when Mr. T. W. Cowan presided. There were also present Mr. W. F. Reid, Mr. C. L. M. Eales, Mr. G. Hayes, Mr. O. R. Frankenstein, General Sir Stanley Edwardes, Mr. A. G. Pugh, Mr. E. Gareke, Mr. T. Bevan, Mr. J. B. Lamb, Mr. E. Walker, Mr. E. D. Till, Rev. H. R. N. Ellison, Mr. A. Richards, and Mr. W. Herrod (acting for the Secretary).

Letters expressing regret at inability to attend were received from Miss Gayton and Colonel H. J. O. Walker.

The minutes of the previous meeting were read and confirmed.

A candidate for first-class certificate attended for the purpose of delivering an impromptu lecture, but failed to deal with the subject to the satisfaction of the Council.

Reports upon examinations of candidates for third-class certificates held in London, Swanley, and Notts were received, and, acting upon the recommendations of the examiners, it was resolved to award certificates to the following candidates: Misses Dyer, W. Garlick, Holmes, Milne, Naef, Rolleston, Verster, Walters, Boyd, H. Garlick, Hammond, Kirby, Neate, Owens, Hopkins, Adair, Dell, Everitt, Lane, Phillimore, Mrs. Crabtree, Messrs. A. E. Smith, W. J. Owers, and S. Marshall.

It was decided that the examinations for second-class certificates be held on November 12 and 13.

A letter was read from Capt. Sitwell, of Wooler, stating that a district association had been formed, and asking to be affiliated, and the Secretary was instructed to communicate with the Northumberland and Durham Association.

It being stated that Mr. E. H. Young was still unwell, a resolution of sympathy was passed, and Mr. Herrod was asked to convey this to him.

Mr. Till moved, and Mr. Lamb seconded, that a small committee be formed to consider generally the present position of the B.B.K.A., and to report what measures should be taken to improve the same.

The following were elected on the committee: Messrs. W. F. Reid, E. D. Till, Lamb, Gareke, Eales, and E. Walker.

Mr. Gareke moved, and Mr. Bevan seconded, that the Secretary write to the Board of Agriculture and ask them, when they are making their distribution, to make the Association a grant.

The next meeting of the Council will be held on November 18.

CONVERSAZIONE.

On the conclusion of the Council meeting, a short adjournment was made for light refreshments, the members assembling at 5.30 for the usual *Conversazione*, over which Mr. T. W. Cowan presided.

Amongst those present were Mrs. Ford, Mrs. Pearman, Mrs. Elsi Russell, Misses W. Baizley, R. Bond, Carr, L. M. Carr, D. Greenberg, V. Kirby, La Mothe, M. Millard, D. B. Ranger, R. Saunders, D. Sankey, E. Scott-Walker, and Hilda Turner, General Sir Stanley Edwardes, Messrs. W. L. Abbott, T. Bevan, W. Barnes, B. E. Buckwell, L. Belsham, H. G. Ceiley, C. W. Daniels, E. F. Dant, Geo. Dow, C. L. M. Eales, H. R. Ellison, W. Emerton, M. Edwards, W. W. Falkner, F. W. Frusher, O. R. Frankenstein, W. Ford, J. J. Fortman, E. Gareke, J. Garratt, L. L. Goffin, W. Gee, Geo. Hayes, C. Hayes, F. D. Hills, L. F. Hake, W. Herrod, R. S. James, H. T. Jolly, G. W. Judge, T. Ketteridge, J. B. Lamb, R. Linde, Robert Lee, W. P. Meadows, J. C. Mason, N. Mulley, A. Meredith, W. J. Owers, A. G. Pugh, E. H. Pankhurst, J. Pearman, W. F. Reid, Arnold Richards, J. Smallwood, T. E. Stone, J. Silver, T. D. Sinfield, V. Eric Shaw, A. E. Smith, A. W. Salmon, H. W. Seymour, G. H. Skevington, J. Tinsley, E. H. Taylor, J. Turner, E. D. Till, N. S. Toms, H. J. Upton, T. W. Watts, W. Ward, E. Watson, E. Walker, J. Waterfield, A. Willmott, J. Willard, T. W. White, and W. G. Fischer-Webb.

Mr. Cowan, speaking from the chair, said that he would like to welcome all those present that evening, especially as there were many new faces, as well as members who did not often favour the meetings with their presence. There were two subjects for consideration, both of which he had been asked to introduce, and after opportunities had been given for discussing the same, there were some inventions for exhibition, which he was sure would be interesting to all bee-keepers.

Mr. Cowan, in introducing the subject entitled "Beneficial Results from the Fertilisation of Fruit-blossoms by Bees," said:

There is no doubt that this country, owing to its temperate climate, is particularly well suited to growing certain kinds of fruit, but for various reasons we import them from other countries. We are receiving fruit from Australia, New Zealand, South Africa, Canada, and the United States of America to supply our demand, and most of it could be easily grown here were the same attention paid to its cultivation as is done in other countries. There is frequently no

attention given to the sorts grown, and acres are covered with varieties that are simply cumbering the ground. It is not my intention to go into all the reasons why we do not make the most of our orchards as other countries do by scientific cultivation, as that would be more appropriate to a horticultural audience, but I wish to show that fruit-growing, to be successful, should be combined with bee-keeping, and that without bees large crops of good fruit are not to be obtained.

The horticulturist in his work has to deal with two groups of insects—those which are injurious and those which are beneficial. The injurious insects which destroy our fruit-trees, our garden and farm crops have received the most attention, and this is quite natural, because the fruit-grower or gardener sees the damage done to his trees and crops, while he does not observe the quiet and successful work of beneficial insects. For convenience we can divide these into two groups—those which are indirectly of benefit, such as the “lady-birds” and parasitic hymenoptera—which by their habits prey upon injurious insects—and those which are directly beneficial by creating useful commercial products, such as the silkworm and honey-bee.

The relation of bees to fruit-growing has not received much attention from the average orchardist; but there are, of course, exceptions, and many could be mentioned who are thoroughly convinced that insects are absolutely necessary to fertilise the flowers if any great success is to be obtained in fruit-growing.

All fruit-growers must have noticed trees covered with a profusion of blossom, but which set very little fruit, and many have found their orchards unprofitable for this reason. The failure to set fruit may be due to a number of causes, which sometimes is an advantage to the fruit-grower, as it saves thinning, but when this failure becomes general it entails a great loss and demands attention. The causes that sometimes make trees unfruitful are (a) vigorous wood-growth, (b) unhealthy condition and lack of vigour, (c) fungus attacks on the blossom, (d) frosts, (e) bad weather during the flowering season, and (f) lack of bees to fertilise the blossoms. The first three concern the horticulturist only, but we are particularly interested in the three last.

Unfruitfulness is sometimes due to injury by frost, and when the blossom expands the stamens and pistils are shrivelled, and are thus not capable of being fertilised, and do not attract bees. Some apricots, apples, and pears, especially Duchesse d'Angoulême, are subject to this injury, and in general trees that

bloom early are the most liable to this damage.

Rain during the blooming season is a frequent cause of unfruitfulness, and in California it is estimated that more fruit is lost from this than from all other causes combined. Continuous rain may wash away the pollen, and it may lose its vitality, but the principal cause of unfruitfulness at such times is due to the fact that insects, and particularly bees, which promote cross-fertilisation between varieties are absent.

Unfruitfulness may be due to a scarcity of bees. I could mention several instances where orchards had proved unprofitable until bees were introduced. As a case in point, I can mention that when visiting a friend at Penryn, in California, some years ago, who had forty acres of “Alexander” peach trees, which are generally supposed to be shy bearers, he complained that he could hardly get any fruit from them, and was about to cut them down and plant some other variety. It was spring, and the trees were a magnificent sight, being in full bloom. As we were going round I noticed that there were no bees of any sort on the blossoms, and therefore asked my friend how far was the nearest apiary. He told me it was at Newcastle, five miles from where we were. I said those bees were no use to him at all, and advised him to give the trees another season's trial, and to get some bees at once, and if then the trees did not bear fruit he could replant in the autumn. He was an intelligent man, took my advice, and obtained two colonies of bees, which he placed in the centre of his orchard. Of course, by that time more than half the blossom was over, but for all that he got a fair amount of fruit, the trees nearest the hives having the most on them. This was the first fruit my friend had obtained from his trees, and he was so well pleased that instead of destroying the trees he got more bees. On visiting him the next year he took me out to see his orchard, which was a perfect sight, and showed the bees' work, for the trees were so laden with fruit that, although they had been thinned, the branches had to be supported by strong wooden props. Needless to say, there were no further complaints about these “Alexander” peaches being shy bearers, for here was ample proof that only bees were required to make them fruitful.

Some trees are full of blossom every year, but set little or no fruit even in the best of seasons. In commercial orchards such trees are usually in solid blocks at a distance from other varieties, but if these are planted near they are made fruitful. Such trees are called self-sterile, and are unable to set fruit when

planted alone, but must have some other variety planted near to become productive. The reasons are (a) that the pollen of a variety is unable to fertilise the pistils of that variety, and (b) the stamens and pistils may not mature simultaneously. The pollen of a self-sterile variety may be produced in abundance and be perfect, as, for instance, in Williams' Bon Chrétien pear. If two trees of a self-sterile variety are planted together both will often be made fruitful, because the pollen of each, although unfruitful in itself, is fruitful on the other. It has also been found that although the pollen may fertilise another tree of the same variety, the pollen from a different variety is prepotent, and the result is seen in the quality of the fruit.

As an example, I would state that in an orchard in New York State, which originally contained 22,000 standard Williams (Bartlett) pear trees, through failure from one cause or another many of the trees were removed, and, according to custom, they were replaced by a considerable number of young trees. Except in a few places the trees, although flowering profusely, were sterile, showing that something was wrong. Formerly there was a small variety orchard on part of the large one, and when it existed a good crop of fruit was obtained. In planting the new orchard two Clapp's Favourite trees had been put in by mistake, and it was found that where there was any fruit at all the Williams pears

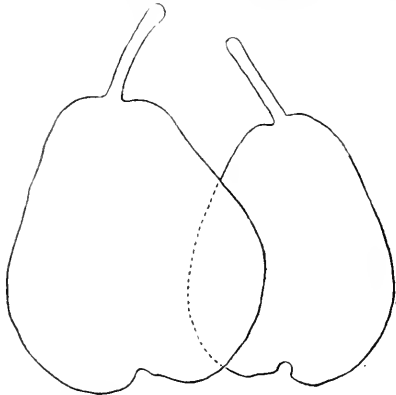

WILLIAMS PEARS—CROSS- AND SELF-POLLINATED.

round these fruited heavily. The same thing occurred at another place surrounding a Buffum tree. Here was the needed proof that it was the pollen from another variety which bees must bring to render themselves useful to the flowers.

Where fruit is grown only for home use, or in small areas for local markets, and a number of varieties mixed, there is

not likely to be serious loss from imperfect fertilisation; but in large orchards where whole blocks of one variety are planted general unfruitfulness may cause a serious loss.

Williams' Bon Chrétien (or Bartlett, as it is called in America) is known to be generally self-sterile, and requires the pollen from another variety to make it fruitful, although sometimes it is also self-fertile.

Experience has shown that there is no

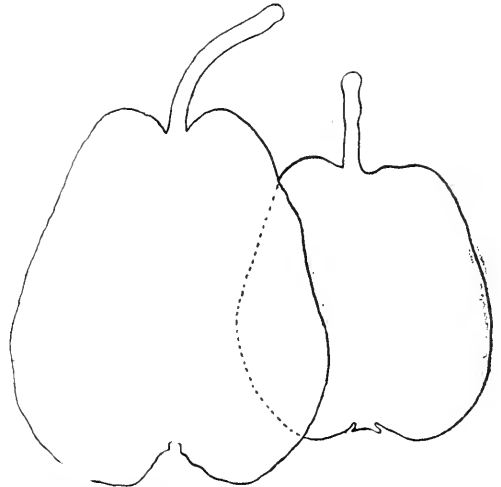

ANGOULÊME PEARS—CROSS- AND SELF-POLLINATED.

doubt about the improvement of fruit by cross-fertilisation. If we take as an example the Williams pear, from a large number of experiments it was found that out of thirty-seven clusters of blossoms on one tree covered with bags, so that bees could not get at them, there were only eight fruits, or 2.8 per cent. of flowers which set fruit; while from thirty clusters not covered there were seventy-seven fruits, or 34.2 per cent. of flowers which produced fruit. These experiments showed that this pear was not entirely self-sterile, but was immensely benefited by cross-fertilisation.* The same tree had eleven clusters pollinated by hand with Angoulême pear pollen, which yielded twenty-nine fruits from forty-four flowers, or 6.5 per cent. Another pear, the Beurre Clairgeau, is entirely self-sterile, for out of fifty-six covered clusters not a single fruit was obtained, while from thirty-two uncovered clusters there were fifty-four fruits; so that in the Clairgeau we have a completely self-sterile variety. Hand-crossing with Angoulême showed the usual

* The illustrations of pears are drawn to scale and are half size, the larger being in every case cross-pollinated and the smaller self-pollinated.

beneficial results of cross-pollination, for seven clusters produced five fruits. I might mention a number of trees that are self-sterile, but the above examples are sufficient for my purpose.

Not only has cross-pollination a good effect on the quantity of fruit produced,

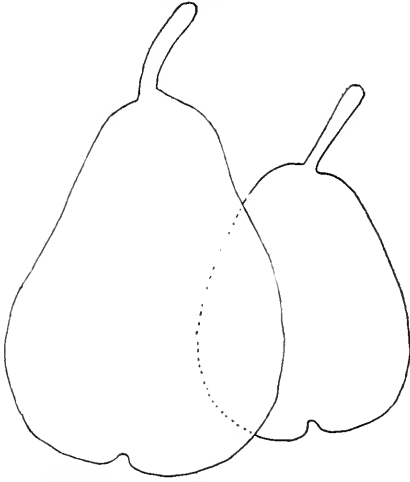

WILLIAMS PEARS CROSSED WITH EASTER AND SELF-POLLINATED.

but the influence of the pollen affects its character and quality.

It was also found that cross-pollinated trees produced larger and better-flavoured fruit, as well as more perfect seeds. The self-pollinated Williams produced a few seeds which were usually abortive, while the crosses were well supplied with sound seeds, the best being, both for quality of fruit and quantity of seed, a cross between Williams and Easter.

In view of the fact that some varieties are self-sterile, it is the practice in California to plant every fourth or fifth row

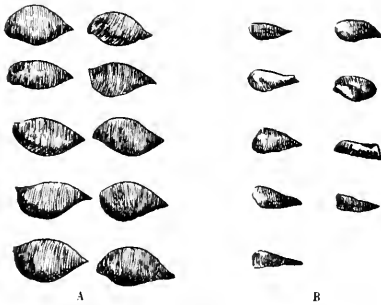

SEEDS FROM (A) CROSSED AND (B) SELF-POLLINATED WILLIAMS PEARS.

with another variety as a polliniser, and in selecting pollinisers varieties blooming at the same time are chosen, and whose pollen will give larger fruit.

Now this cross-fertilisation is entirely dependent upon insects, which transport

the pollen from one tree to another, and it has been shown that in the spring, when fruit-trees are generally in bloom, there are twenty bees flying and visiting blossoms to one of any other kind of insect. The effect of climatic conditions on the abundance of insect visitors is an exceedingly important matter. Warm, sunny weather favours insect visits, while cool or rainy weather interferes seriously with them. We had an instance mentioned in the BRITISH BEE JOURNAL, on page 376, by Mr. W. E. Zehetmayr of a tree visited by bees on one particular day yielding abundantly; and I remember one year when strawberries were exceedingly scarce in the neighbourhood of Horsham we had an abundant crop because our bees were able to get at the blossoms whenever the sun shone, while they did not go to those at a distance. Rain not only drives insects away, but it also spoils the pollen, which is then impotent to fertilise. The amount of nectar secreted by flowers is also affected by the weather, and varies enormously from almost

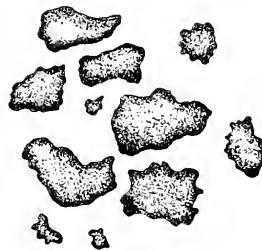

POLLEN DAMAGED BY RAIN. Much magnified.



POLLEN OF WILLIAMS PEAR. Much magnified.

nothing to very large drops, and this strongly influences the visits of insects.

The number of insect visitors in any orchard determines to a great extent the amount of cross-fertilisation carried on. The pollen of the pear and apple is not produced in sufficient quantity, nor is it of the right consistency, to be carried by the wind, and the pollination of the trees is therefore dependent on the activity of insects. In small orchards there may be in an ordinary spring sufficient insects in the neighbourhood to cross-pollinate the trees, but in the case of large orchards, especially where several are close to each other, there is not a sufficient number of insects for cross-pollination when the main body of trees are in bloom. In such cases, if there is no apiary close by, each orchardist should keep a number of beehives, as we have seen that honey-bees and other members of the bee-family are the best workers in cross-fertilisation.

What I have said with regard to pears applies equally well to apples, plums, peaches, and apricots, and I could give

you many examples, did time permit, but I think I have said enough to show you that not only beneficial results are obtained by cross-fertilisation, but that there should be enough bees in the neighbourhood or within a couple of miles to visit the flowers properly. Few, if any wild bees can live in a well-cultivated orchard, hence the necessity of keeping bees as aids to cross-pollination.

(Continued next week.)

THE DAIRY SHOW.

The thirty-fourth annual exhibition of the British Dairy Farmers' Association opened on October 5 at the Agricultural Hall with one of the poorest shows of honey ever staged, only eighty-seven entries being made, and of these thirteen exhibits failed to arrive. The classes, though numerically small, were good, especially the trophy class, which contained five very good displays, and had it not been for these it would have been but a sorry show.

The position of the honey this year was changed, it being brought out from the wall into the centre of the Gilbey Hall, where a good light made it look very well, and had the quantity of the honey equalled the quality the whole would have formed a very attractive section of the show. It is unfortunate that this great Metropolitan exhibition of country produce should be so badly supported by exhibitors in the honey classes, as the dairyman is usually a large buyer of the bee-man's crop; there must be another reason than the half-crown entry fee to account for it.

Mr. E. Walker, of London, judged the exhibits, and made the following awards:—

Twelve 1-lb. Jars (Light) Extracted Honey.—1st, R. W. Lloyd, Thetford, Norfolk; 2nd, R. Morgan, Cowbridge, Glam.; 3rd, H. W. Saunders, Thetford, Norfolk; 4th, T. G. Hillier, Hurstbourne Tarrant, Andover; v.h.c., J. Pearman, Penny Long Lane, Derby; R. H. Baynes, 51, Bridge Street, Cambridge; J. Waterfield, Kibworth, Leicester; A. J. Brocks, Nether Wallop, Hants; and Jas. Lee and Son, Highbury, London.

Twelve 1-lb. Jars (Medium) Extracted Honey (other than Heather).—1st, R. H. Baynes; 2nd, E. C. R. White, Newton Toney, Salisbury; 3rd, F. W. Frusher, Crowland, Peterborough; 4th, Jas. Lee and Son; v.h.c., Jas. Pearman; Mrs. Turner, Broadway, Amersham; and F. Harris, High Ferry, Sibsey, Lincs; h.c., Mrs. Seadon, Bromley, Kent.

Twelve 1-lb. Jars (Dark) Extracted Honey (including Heather Mixture).—1st, J. T. Wilson, Shirebrook, near Mansfield; 2nd, Jas. Pearman; v.h.c., R. H. Baynes;

Wm. Dixon, Central Road, Kirkgate, Leeds; and F. W. Frusher; h.c., E. C. R. White; c., Jas. Lee and Son.

Twelve 1-lb. Jars Extracted (Ling) Heather Honey.—1st, Jas. Pearman; v.h.c., J. Southwell, The Bakery, Lockerley Green, Hants.

Twelve 1-lb. Jars Granulated Honey of 1908 or any previous year.—1st, J. T. Wilson; 2nd, F. W. Frusher; v.h.c., J. G. Nicholson, Langwathby, Cumberland; and J. Pearman; h.c., Mrs. Seadon; c., Jas. Lee and Son.

Twelve 1-lb. Sections of Comb Honey.—1st, R. H. Baynes; 2nd, Jas. Pearman.

Six 1-lb. Sections of Heather Honey.—1st, J. Pearman; 2nd, W. Dixon.

Display of Comb and Extracted Honey.—1st, Mrs. Turner; 2nd, R. H. Baynes; 3rd, Jas. Lee and Son; v.h.c., Mrs. Seadon.

Beeswax (not less than 2 lb.), Judged for Quality.—1st, A. Hiscock, Loddington, Northants; 2nd, E. C. R. White; v.h.c., R. Morgan and F. Harris; h.c., Jas. Lee and Son.

Beeswax (not less than 3 lb.) in Marketable Cakes suitable for the Retail Trade.—1st, F. Harris; 2nd, Jas. Pearman; v.h.c., F. W. Frusher and E. C. R. White; h.c., Jas. Lee and Son.

Interesting and Instructive Exhibits of a Practical or Scientific Nature.—1st, Jas. Lee and Son.

HONEY IMPORTS.

The value of honey imported into the United Kingdom during the month of September, 1909, was £1,726.—From a return furnished to the BRITISH BEE JOURNAL by the Statistical Office, H.M. Customs.

Correspondence.

The Editor does not hold himself responsible for the opinions expressed by correspondents. No notice will be taken of anonymous communications, and correspondents are requested to write on one side of the paper only and give their real names and addresses, not necessarily for publication, but as a guarantee of good faith. Illustrations should be drawn on separate pieces of paper. We do not undertake to return rejected communications.

NOTES BY THE WAY.

[7632.] With the month of October bee-work in the apiary should be over, so far as regards preparation for the winter months. Any feeding which has been neglected or postponed from some unavoidable cause should be attended to at once, and a comb of sealed honey which can be spared from another hive will be the best way of feeding stocks which have not enough to carry them through the winter. If no frame of honey can be spared, feed with thick warm syrup, wrapping up the feeder with some soft,

thick material to keep the syrup warm, so that the bees can store it rapidly. All feeding should have been completed last month, as the early fed syrup is sealed over by the bees.

See that the roof of every hive is rain-proof, and where necessary provide a waterproof covering without delay. I have used unbleached calico laid on wet paint; this when painted with one or two coats of paint makes a good, cheap waterproof covering, but it does not last many years. Hives treated in this way have passed into the lumber-yard, while others which were covered with thin sheet zinc are still in use and in serviceable condition now, so that anyone who is looking forward to profitable bee-keeping will find that zinc proves the cheaper in the long run.

Wasps have been both numerous and destructive in our district this season. Netted fruit may be secure from birds, but netting is of no avail against the wasp: he helps himself to the best and sweetest, be it bush or tree fruit, and when opportunity offers invades the hives and steals the honey stored by the industrious inhabitants for their winter food. If the entrances of hives are nearly closed the bees are able to defend their stores, and they can be opened wider for ventilation when the danger from this source is over.

When packing up for winter see that the first quilt lies well and evenly on the frames, especially around the edges; this, when other wraps or cushions are laid on, keeps all down firm and secure and prevents draughts during the winter. Winter passages should not be forgotten; it is essential that the bees should be able to pass over the frames to the food beyond the cluster. I find that two or three strips of split wood placed side by side an inch or so apart answer the purpose very well; but those sold by our appliance dealers are, of course more neatly made, and, used with care, will last many years.

After the extracted combs are cleaned out by the bees, wrap each super up separately in paper, first dropping in one or two balls of naphthaline, and store in a dry place; this will keep them clean and prevent the moth spoiling them.

Floorboard Feeders (7611).—I may add that my old friend the late Mr. John Walton, of Leamington, used a similar contrivance many years ago, the only difference being that the "Walton" feeder was in the centre of the floorboard, and was partly drawn out to allow the syrup to be poured into it. A shutter of perforated zinc followed the trough, and prevented the bees getting into the space left when the feeder was drawn out.—W. WOODLEY, Beedon, Newbury.

WASPS AND FLIES.

[7633.] Having read with interest the letters which appeared on wasps in B.B.J. for September 30, may I be allowed to put in a further plea for them? I do not think that anyone who has at all studied the subject can be in any doubt as to the utility of these insects. This summer I have had a nest of *Vespa vulgaris* under close observation, and while watching the insects that entered and left the nest I was much struck by the number which, returning from their forage for food, brought back various insects, but more especially flies, in their jaws. At times their victims were so large that they quite weighed the wasps down, and they had in some cases considerable difficulty in getting them into the nest.

After constant countings, I reckoned that the wasps were entering the nest at an average of sixty-one a minute, and, allowing that only ten of these brought in insects, that still brings the number up to 600 an hour, so that the total number killed during the day would be something considerable, and we can readily understand what an efficient check they keep on their dipterous prey. Wasps may also be often seen searching the meat hung in butchers' shops for the flies' eggs laid on it, and in this way they more than compensate for the toll of meat they may also take. Yet because they possess a sting, which they sometimes use (though never except in self-defence), they receive unceasing persecution at our hands, more particularly *Vespa vulgaris* and *Vespa germanica*, the two species which most constantly invade our houses. But those who have learnt the secret of keeping quiet when a wasp alights on them know there is nothing to fear; and, anyway, it is surely better that a few people should be occasionally stung and the obnoxious members of the Diptera kept in check than that the wasps should be destroyed wholesale, and thus upset the "balance of power" by removing one of the chief enemies of the fly. Few people realise the full extent of the evil that flies do, which are, as your correspondent Mr. E. D. Till, says, "a danger to life and health." I wish that everyone would read A. E. Shipley's splendid chapter on this subject in his "Pearls and Parasites." I do not deny that wasps damage our fruit to some extent, but I maintain that this is *much* more than compensated for by the very appreciable services they render us in ridding us of noxious insects and in fertilising flowers.—M. B. H., Andover.

WASPS.

[7634.] I was somewhat surprised to read in the B.B.J. (page 367) that it is folly

to kill wasps. I enclose a cutting taken from the *People* of September 26, and I expect the writer would like to have had a hand in the so-called folly. I have myself been killing wasps by destroying their nests for the past twenty-five years, but I do not think I ever lived in a place where nests are so plentiful as in this locality. For the past eight years I have destroyed over thirty nests on an average each year. Highest number destroyed in one year (1907), fifty-six; lowest, twelve nests (1908). This year my number at present is thirty-four, and still they are so numerous as to be almost a plague. They have not done much harm to my bees, but good crops of peaches, nectarines, plums, and gooseberries on walls outside have been ruined by them, and, worse still, they have made a raid on the grapes in the vineries under my charge, the wasp-net which is placed over the ventilators and doors being of no avail in keeping them out. This is partly due to the ventilators being sliding lights; therefore the net does not make them wasp-proof. They settle on the glass and walk up under the net—a distance of more than a yard—until they reach the open ventilators. I do not myself think they devour much fly, or how is it both greenfly and wasps have been so numerous at the same time? My opinion is that they visit where greenfly is for the sticky substance which it creates or deposits.—GARDENER, North Bucks.

“DESTRUCTIVE WASPS.—Not only have wasps been destructive to the fruit this year, but they have attacked my bee-hives with an amazing courage. Yesterday, on examining two straw skeps which I had placed inside box-hives, I found that wasps had entered through the bee-escape in the roof and drilled large round holes, like mouse holes, through the straw skep to get at the honey in the fixed combs. This shows the necessity of closing even the ventilating holes in the roof, for I know of one small holder who has had two hives destroyed by wasps this year.—YEOMAN.”

CURRENT TOPICS.

[7635.] “*Weighed in the Balance*” and *Found—Fictitiously Heavy!*—Imagination is surely somewhat of an interloper in works of science and of practical utility, for, while she often illuminates principles, she sometimes exaggerates facts. The phrase “superabounding energy of a swarm,” as written by the venerated Langstroth, seems to me to rather overstate the fact, and especially do I think this is so if, as “D. M. M.” would seem to believe, it applies to the whole of the current season. There is a striking analogy between a natural swarm placed

in an empty hive and an emigrant with limited capital taking up his 160 acres of Canadian wilderness. They are both impelled by the necessities of the case to work hard. They both have houses to build and furnish before the winter overtakes them. In the case of the human emigrant, he is driven by his necessities and lured by his hopes to put forth the best that is in him; but, having built his house and barns, fenced his land, &c., the novelty of the life begins to wear off, and too often, it is to be feared, he finds that things are not altogether as he anticipated: the sanguine hopes which gave the very snows of his first winter a roseate tinge fade not merely to the white, perhaps, but even to the grey. Still, though the first warm enthusiasm has passed, he must settle down to steady work for a living. In like manner the instinctive needs of a new swarm stimulate them to work their best until their brood-nest is furnished, which in a good honey-flow will only occupy from ten days to a fortnight, after which period their condition approaches that of a stock (save in the one important matter of strength); the extra incentive to work has in a great measure disappeared, *because it has in a great measure been satisfied.*

In “D. M. M.’s” second quotation the words “We have time and again noticed how a natural swarm will outstrip a colony of equal strength” simply beg the whole question, for, as a matter of fact, swarms never are the equal in strength of good average stocks.

To sum up, I think: 1. The extra impulse to work of a newly-hived swarm is fairly counterbalanced by the fact that it has a complete brood-nest to furnish. 2. It is further handicapped by the fact that it is dwindling for nearly a month, while the stock during the whole of that time is increasing by hundreds (some would say thousands) daily. 3. The stock is stronger in bees (often very much so) when the swarm is hived. 4. The stock will already—in a good season—be at work in supers. 5. Actual results in honey-production prove the foregoing conclusions to be true, and justify the repeated attempts made to control or prevent swarming ever since the modern system of bee-keeping was initiated.

Queen-excluders (page 389).—There is one advantage in the use of these which seems to be generally overlooked—viz., they entirely prevent brace-combs on the bottoms of sections next the brood-nest. Whenever I have worked sections without excluders I have generally found several sections spoilt with brood, and always these intolerable brace-combs, which have to be removed from bottoms of sections before the latter will even stand level on a table. I cannot imagine how bee-keepers

can put up with this nuisance, and personally am quite sure that if ever I discard excluders it will only be to use some kind of slatted honey-board in their place.

Judging Honey by a Scale of Points (page 388).—I think any judge who attempted to judge honey by using a fixed scale of points would find the use of the latter a hindrance rather than a help. Take a class of, say, 500 sections at a good show, and it will at once be seen that quite 80 per cent. are "out of the running," and, so far as any chance of winning a prize goes, might just as well have stayed at home, and this quite irrespective of the quality of honey they contain or of the neatness and finish of their "get up." These points count for next to nothing when (as is always the case) there are half a dozen lots which are very much better filled and sealed. The latter points are ever the paramount ones which swamp all the rest. Of course, it is not to be inferred from this that a dozen sections filled with black honey-dew could by any possibility come into competition at all, even though they were filled and sealed to perfection. A good judge will therefore take the general appearance first. This will enable him to at once select the few lots which are at all likely to figure in the prize-list. Then from these one lot will probably stand out as regards the filling, sealing, and transparency, with which the quality of the honey will almost certainly concur. This lot then takes first place, even though some of the others contain honey which the judge on the whole prefers. Let anyone pay a visit to a show such as the Grocers' or Dairy Farmers', and he will find in every case that the best-filled sections are the winners, proving, as stated above, that this point—if the honey is of average good quality—dominates all the rest, and simplifies judging enormously.—SAML. P. SOAL, Rochford, Essex.

HONEY-DEW.

[7636.] As honey-dew has been a serious menace to the bee-keeper's harvest this year, I beg to enclose a rather interesting cutting taken from the *Western Morning News* of September 21 last, by kind permission of the writer, the Rev. F. M. Massey, Buckfastleigh.

I have been a constant reader of the B.B.J. for the past fifteen months, and have obtained much valuable information from it, and in my copy of the "Guide Book" may be found many interesting cuttings taken from the "Weekly Guide Book" (otherwise known as the B.B.J.), securely gummed to their proper chapters for easy reference.

I trust many novices, like myself, will find Mr. Massey's letter of considerable interest, and also that I am not encroaching too much on your valuable space.—J. J. L., Bere Alston, Devon.

"SIR.—In answer to the queries of your correspondent on this subject, I may say that from reports received from different parts of the country dark honey is prevalent this season. It comes from several causes. All the flowers do not secrete nectar of the same quality and colour. Thus Dutch white clover, which is the principal source of light-coloured honey in England, has almost completely failed this year owing to adverse conditions of temperature, whilst other sources like apple and lime honey have yielded an abundant crop. Fifty stocks have given us 3,300 pounds of honey from the latter sources. It is dark in colour, but rich in flavour and substance, and has been declared excellent for table use by the greatest authority we have in England on such matters. Bee-keepers, therefore, need not scruple to make use of dark honey if it be derived from floral nectar. There is, however, another cause of dark honey; it is the so-called honey-dew, or extra floral nectar. This is of two kinds—honey-dew from the trees and honey-dew from the aphides. We know that sugar accumulates not only in the flower, but also in the nectariferous tissues in different parts of the trees. In the flower that sugar finds a natural outlet, which will attract insects and secure their co-operation in the great work of fertilisation. In the case of trees, under certain weather conditions, the accumulated nectar forces itself through openings called stomata, or, where these are wanting, through the cuticle of the plant, thus producing honey-dew. This honey-dew, like the nectar from flowers, undergoes a chemical change after being gathered by the bees, and therefore becomes honey, though of inferior quality. But it gives the honey a dark and dirty appearance, and has often a rank taste. I have noticed it was prevalent mostly in June and July, after a long drought, on many trees like oak, beech, willows, &c. Sometimes it was so abundant that all the objects under the trees were besmeared with it. Another kind of honey-dew is produced by insects called 'aphides.' They feed in great multitudes on the sap of the trees and secrete a sweet liquid, which the bees gather. Of course such a stuff spoils not only the colour of honey, but, if stored in any quantity, affects it to such an extent as to render it unfit for human food. This pest has been very common this year, and therefore only an expert

could decide in each individual case whether the dark colour is due to it or to some other agency."—F. M. MASSEY, O.S.B., St. Mary's Abbey, Buckfastleigh.

Queries and Replies.

[3974.] "*Claustral*" Hives.—In your issue of February 23, 1905, at the end of description of above, you mention: "We have also in preparation a series of illustrated articles describing the system more fully." 1. Can I obtain them through you, or from whom may they be had? I am anxious to try this system for wintering, and I have a notion, if carried out, it will answer well. 2. Also I am wanting to join the B.B.K.A. To whom can I apply? *Re* local association, I cannot find enough *esprit de corps* in this district, as my bee-keeping neighbours do not seem sufficiently interested to join or help to form one. The great idea is "something for nothing." Very poor season as a rule; the heather a dead failure. I shall be pleased to do anything for you down this way if occasion should arise. Thanking you in anticipation.—H. C., Charmminster.

REPLY.—1. In addition to the illustrated article which appeared in the B.B.J. for February 23, 1905, there was a full description of this hive and system on page 121, March 30, 1905, which we gave at a *Conversazione* of the B.B.K.A. Specimens of the "claustral" hive were shown, and as the illustrations were produced on pages 72 and 73 it was not deemed necessary to reproduce them. The "claustral" hive is also illustrated and described on page 50 of the "Guide Book." 2. You should apply to the Secretary of the B.B.K.A., 12, Hanover Square, London, W., who will send you a form of application for membership, which you will have to fill in and return to him.

Notices to Correspondents.

BEGINNER (Worsley).—*Transferring Bees*.—It is too late for bees to transfer themselves from skeps to frame-hives, and you will see on page 150 of the "Guide Book" that this should be done in April. It is also too late to drive the bees, except for uniting with other colonies. 1. The time when the queen will go below will depend on the strength of the colony and the amount of stores coming in. It can only be ascertained by removing skep and examining the combs in frames. The queen is sure to descend sooner or later

when the skep becomes too crowded. 2. You can fix excluder as soon as you ascertain that the queen is down. 3. You can place super-clearer and remove skep as soon as all the brood is hatched out, which will be three weeks after the queen has ceased laying worker-eggs in skep. Should she have laid drone-eggs, three days longer will be required for them to hatch.

ALPHA (Dublin).—*Black Brood and Feeding Bees*.—1. It is a case of black brood, and the treatment should be the same as for foul brood. You must not use naphthol beta solution any stronger than that recommended on page 194 of the "Guide Book," otherwise you will do more harm than good. Three or four balls of naphthaline, if pure, will not harm bees, but beware of using some of the substances which are sold as naphthaline. Treat according to instructions in the "Guide Book." 2. It is impossible to say if your bees will live through the winter, as this depends on the strength of the colony and amount of stores the hive contains. 3. If you are not able to give your bought bees combs of sealed honey, and they have no food at all, you must give them frames filled with candy (see page 195 of the "Guide Book"), one being placed on each side of brood-nest. The bees must also be supplied with a cake of candy on the top so long as they are not able to collect stores.

C. L. (Chichester).—*Name of Parasite*.—It is *Braula caeca*. Shag tobacco is sufficiently strong for fumigation, and should be well lighted and put in the smoker. Blow in at the entrance and give the bees a good dose of smoke. We have found this causes the parasites to fall on the floorboard.

S. C. P. (Gloucester).—*Race of Bees*.—1. From your description we should judge your bees to be Carniolans, but could tell better if you sent description. 2. Seven pounds of honey is not enough for a strong colony (see page 112 of "Guide Book"). 3. The yellow stuff bees are carrying in is pollen for feeding the young brood (*ibid.*, page 15).

ROBIN HOOD (Bristol).—*Size of Swarm-box*.—A well-ventilated box 17 in. by 9 in. by 9 in. would be large enough for an ordinary swarm of 4 lb. or 5 lb.

ALPHA (Rugby).—*Bees in Skeps, &c.*—1. Lift the skep and place the naphthaline on floorboard. 2. You should give driven bees in a skep at least 25 lb. to 30 lb. of syrup, as they have to make their combs. You will have to feed them also in the spring. 3. There is no necessity to wrap anything round the skep. 4. The exact amount of wax to pollen in the cappings of brood-cells has not been

determined, and varies. 5. The bee does not eat the covering, but cuts a circular slit; the capping frequently drops, and is used up again. 6. Maeterlinck is wrong about there being a drop of formic acid in each honey-cell. This is 200 times more than is actually found in the honey. You will find an article on this subject on page 231 of B.B.J. for June 11, 1908, entitled "Origin of Formic Acid in Honey." 7. The two-and-sixpenny is a cheap edition on thin paper and in imitation cloth binding. 8. The next *Conversazione* will be held in March, 1910. The monthly meetings are Council meetings for the transaction of business, at which delegates of affiliated associations are entitled to attend.

NOVICE (Hants).—*Ailing Bees*.—Bees sent appear to be suffering from abdominal distension, the yellow contents being undigested pollen.

REV. J. G. SHATTON (Northumberland).—*Affiliation to B.B.K.A.*—Application should be made to the secretary, Mr. E. H. Young, 12, Hanover Square, London, W., who will send a circular stating conditions and privileges of affiliation.

K. M. (Filey).—*Price of Honey*.—1. Best-quality honey, wholesale, 7d. to 8d. a pound; retail, 10d. to 1s. a pound jar. 2. Feeding must be discontinued now (see "Guide Book," page 112). If insufficient stores, make up with candy. 3. Probably there was nothing for the bees to collect, which would be the reason of no honey in supers. It is evident the bees did not swarm, or they would not have been in the super.

A. J. (Tarpurley).—*Effect of Bee-stings*.—It depends very much on the constitution how bee-stings affect different persons. The poison of some bees seems to be more virulent than that of others. Some constitutions get used to bee-stings and suffer no ill-effects from them, while others experience such symptoms as you describe. As you have not been affected in this manner previously, a temporary constitutional derangement may be the cause. A good remedy in such a case is sal-volatile in water.

Honey Samples.

M. E. G. (Griffithstown).—Sample of honey is partly spoiled by honey-dew, but could be used for the table if the colour and flavour are not objected to. It should not be given to bees as winter food.

WEMBLEY.—Both samples are good in colour and of fairly good flavour, but of poor consistency. No. 2 is almost as thin as water, and both should be ripened by keeping in a warm place.

W. H. (Swaffham Bulbeck).—A bright amber-coloured honey of rather nice flavour. It is rather too thin to be called a good honey.

W. MOULTON (Prestbury).—Honey from clover and limes of very good colour, but rather lacking in consistency. Apart from this defect, it is a very nice honey.

W. J. J. (Herefordshire).—A very dark honey of fair consistency and fairly good flavour. It contains a little honey-dew.

W. AMATT (Matlock).—No. 1 is a nice-flavoured honey, rather dark in colour, and beginning to granulate. Nos. 2 and 3 are of equal quality, fairly good in flavour, but contain a little honey-dew. These also are beginning to granulate.

P. B. R. (Birmingham).—Sample is a thin honey of fairly good flavour; the colour is poor, partly caused by a small admixture of honey-dew.

H. M. S. (Canonbury).—Honey of fairly good flavour gathered from spring flowers. We cannot report on colour and consistency when granulated.

Suspected Combs.

A. B. (Ayrshire).—The comb is affected with black brood, which resembles foul brood in being highly contagious.

M. E. W. (Plympton).—Specimen is drone-comb, and the "dusty" appearance is only mould caused by damp. The bees may not have been numerous enough to cover all the combs.

AMATEUR (Bradpole).—Comb is infested with wax-moth. The only safe plan is to melt down the combs as advised in the "Guide Book."

J. W. (Durham).—There is no brood in comb, but, judging from the one or two cells containing almost fully-developed bees, we suspect black brood is present in the hive.

. Several important letters, &c., are in type, but held over from pressure on our space.

Special Prepaid Advertisements.

Twelve words and under, Sixpence; for every additional Three words or under, One Penny.

Advertisements for current issue must be received by first post on Tuesday.

FINEST CLOVER HONEY, 28 lb. tins, 15s.; Screw Cap Jars, 8s. 6d. dozen, f.o.r.—M., 68, Chelmsford-street, Lincoln. v 4

RAPID FEEDERS, Lee's, 39, once used, large, 2s. each, 20s. per doz.; Excluder Zinc, 4d. each; Lee's "Universal" Feeder, 9d. each, 8s. per doz.; Spring Crate, for travelling Sections, 3s.—CHARTER, Tattingstone, Ipswich. v 5

WALLFLOWERS, plant now for early blossoms, 1s. 6d. 100; extra strong, 2s. 6d.; carriage paid.—NURSERIES, West End, Southampton. u 96

Editorial, Notices, &c.

BRITISH BEE-KEEPERS' ASSOCIATION

A special meeting of the Council was held at the offices of the B.B.J., 8, Henrietta Street, Covent Garden, London, W.C., on Wednesday, October 13. Present: Mr. W. F. Reid (vice-chairman), in the chair, Mr. C. L. M. Eales, Mr. O. R. Frankenstein, Mr. E. Gareke, Mr. J. B. Lamb, Mr. A. Richards, Mr. E. D. Till, and Mr. E. Walker.

Letters of regret for absence were received from Mr. R. T. Andrews, Mr. T. W. Cowan, General Sir Stanley Edwardes, Rev. H. Ellison, Miss Gayton, Mr. H. Jonas, Mr. A. G. Pugh, and Mr. G. H. Skevington.

The Council requested Mr. Lamb to act as secretary at this meeting.

The notice convening the meeting was then read, also correspondence referring to it.

Mr. Till reported on his visit to Mr. E. H. Young that afternoon, and had found him still in the same condition. It was resolved that a cheque for a quarter's salary be sent him.

It was resolved that the cordial thanks of the meeting be offered to Mr. W. C. Young and to Mr. Harcastle for the assistance they had rendered, and the chairman of the meeting was requested to send the letter which was then drafted to Mr. W. C. Young in reference to handing over the books, papers, and other property of the Association. It was resolved to ask Mr. W. Herrod to serve as acting secretary *pro tem*. Mr. Herrod, who attended, consented to do so.

The Chairman was desired to write to Mr. Cowan to ask him to communicate with the bankers, and also if he would put in a notice in the BRITISH BEE JOURNAL that Mr. Herrod had been appointed acting secretary for the time being, and that all correspondence might be addressed to 8, Henrietta Street, W.C.

The secretary was requested to write an official letter to Mr. Herrod informing him of his appointment as acting secretary for the time being, and authorising him to take charge of the books, papers, letters, and other property of the Association.

It is requested that all communications for the B.B.K.A. be addressed for the present to Mr. W. Herrod, care of the BRITISH BEE JOURNAL, 8, Henrietta Street, Covent Garden, London, W.C., and that those correspondents who may not have received answers to their letters should write again.

BRITISH BEE-KEEPERS' ASSOCIATION

CONVERSAZIONE.

(Continued from page 405.)

Mr. Sander thought that Mr. Cowan had not referred to one point in connection with this subject, and that was that fruit-blossoms which had been fertilised by bees were better able to stand frost than those unfertilised. One year when the gooseberry crop failed in his district his own gooseberry bushes were laden with fruit almost to the point of breaking down. The failure was attributed to the fact that just after the blossoms came out a frost followed. In the case of his own fruit fertilisation took place before the frost set in, and in consequence the trees were able to stand the hard weather. He would be glad to know whether that explanation was a correct one.

Mr. Willard said that if the stigma of the flower was ripe for fertilisation and became fertilised, it was marvellous how soon that operation took effect and the stigma began to dry up, when the frost would have little or no effect. On the other hand, if the stigma was waiting in vain for fertilisation before the frost set in, then its chances of life were lessened. Immediately after fertilisation had taken place the energies of a plant would cause the growth to become vigorous and better able to resist the weather than the one that waited fruitlessly for fertilisation. As to bees being kept near fruit-trees, it was common knowledge that they did not travel far in uncertain weather; therefore it was important to have them near at hand.

The Rev. H. Ellison said he would like to mention instances showing the value of bees to flowers. Five years ago, when he lived in Kent, he found that the peaches in the houses in Lord Hothfield's gardens bore very irregularly; one year there was a large crop and the next a very poor one. He persuaded the head gardener to put a skep in one of them. The bees seemed to have no trouble in finding their way home all right, while the percentage of mortality was very low indeed. Last year it was found that the vine produce (the Muscats especially) developed so badly that there was a proposal to put in new trees. Instead of doing this a skep was placed in the house, and the bees began to work immediately, with the result that the bunches had to be thinned out very much, the Muscats in particular giving an enormous crop.

Mr. Hayes said he would like to ask, with regard to putting bees in green-houses and vineries, where they would have abundance of food, whether they gave off a swarm. His experience in such cases was that, although the fruit-

blossoms might be well fertilised, the majority of the bees were lost.

Mr. Ellison replied that he did not find that swarms were prevented when the bees were taken out again. He did not, however, think they ever swarmed when in the houses, because peach blossom, as everyone knew, came early in the season, and when the skep was taken out again the weather was still cold. Very few bees were found dead about the greenhouse. He expected there would be a lot, and the first year there were a good many, but considerably fewer afterwards. He often watched the bees, who soon found out the arrangements of their new abode, and never made any attempt to get out by the glass.

Mr. Reid said he would like to offer a suggestion which might explain the fact that bees in a skep placed in a greenhouse did not suffer much. Their home was in the building, consequently they had no cause to go out, and this possibly was the explanation of their immunity from injury or loss. The Chairman had so fully gone into the question of the fertilisation of fruit-trees that there was very little else to say. Most of those present were concerned in the production of fruit, and what was required was not fruit merely, but *good* fruit. Many had seen misshapen apples and pears—fruit which contained little woody knots here and there, and had as well an inferior taste. That was due to non-fertilisation of some of the pips, while if they were fully fertilised not only was the fruit more symmetrical, but the flavour very much better. At the Horticultural Show at St. Louis, where he acted as vice-chairman of the international jury of that section, some pipless apples were exhibited, but they had very little flavour and that coarse skin which always seemed to become fixed between the teeth in chewing. Apples and pears must be fertilised to obtain the highest quality, quite independent of the question of yield. In the case of trees that required crossing, scarcely any fruit at all could be obtained if the bees could not get at them and there were no other insects to carry on the work of fertilisation. Many of the nests of wild bees in a district were destroyed in ploughing the fields, and unless something was done to redress the balance then one of Nature's most important operations was lost and horticulturists were deprived of the benefit thereof. It was extremely interesting to isolate certain branches of trees and watch the result. He had this year enveloped black currant, red currant, and gooseberry bushes in muslin, and believed at the time that he had succeeded most effectually in excluding any outside influence. The raspberry beetle generally emerged before

the raspberries were out, and then it fed on gooseberry bushes. It appeared that in covering up one bush he had overlooked one of these beetles, which probably had hidden under a leaf. The result was that in that one case there were a few gooseberries on the bush, while the other completely isolated ones yielded nothing. Without that one little insect there would no doubt have been no fruit at all, while all the other gooseberries in the garden that were given free play were full of fruit. With regard to the red currants, which were easily fertilised, the isolated bushes certainly bore a few currants, dotted here and there, and some single ones on single stalks, but in the case of the black currants on a big bush there were only two currants. This latter was entirely in accordance with observations, which proved that very few insects relished the scent of the black currant, which the bee did. Clearly people who complained about not having a good crop of black currants should keep bees. Mr. R. Brown, of Somersham, found that when he brought his hives into the orchard the first year's yield showed a fourfold increase of fruit, independent of the honey crop, showing the importance of having the hives near the trees. He (the speaker) had received a letter from that gentleman saying that apples this year in his district had been very scarce, excepting his own orchard and those immediately adjoining it. Then, as to neighbourhoods, England seemed to be almost a network of cities. In fact, it was fast becoming one large city, and in consequence there was a good deal of smoke in the atmosphere, and it would be absolutely necessary for those who wished to grow fruit to have bees nearer the towns. At present one had, as a rule, to go a good way out of London before there was a sign of a bee. Smoke did not prevent fruit-trees from blossoming, and it would not prevent them from producing good fruit if bees were present. A friend of his had about five acres of ground in the vicinity of Clapham Common, and it was only since becoming an apiculturist that he had had two large crops of fruit. There were many beautiful pear trees in and near London which yielded no fruit. This was often ascribed to weather conditions, but the temperature in London was one or two degrees higher than outside. The subject of fertilisation and cross-fertilisation was an extremely fascinating one. He was afraid the public generally did not sufficiently appreciate the value of bees. The production of honey and wax, good as it might be, was only a trivial matter compared with the enormous good that bees conferred on agriculture and horticulture, and the more that knowledge was

spread among the people the more would the staple industries of the nation reap the benefit.

Mr. Willard said he had tried the experiment of keeping bees in a peach-house, and if he were asked as to the advisability of putting them under glass he would say "Don't." He had too much regard for the bees. As the day advanced the sun came out, which meant that the houses must be ventilated. Gardeners were in the habit of closing these outlets early—probably long before the bees had given up work. Consequently a good many were shut out for the night, with disastrous results. He had never found a hive come out of the house as strong as it went in, and, in his opinion, there was no need to put the bees to such inconvenience when peach and other hot-house fruits could be fertilised by hand.

Mr. Bevan said he remembered one of the oldest bee-keepers carrying forty hives into the greenhouses, but his experience was not satisfactory. The difficulty that Mr. Willard spoke of regarding bees being left out all night could no doubt be got over by the use of wire netting. He did not, however, think the system was to be recommended, although it might save a lot of hand labour. With regard to carrying the pollen from one tree or shrub to another, he had known bees take it as far as 400 yards. When he was young, gardeners were taught to collect the pollen, bottling and keeping it for a month or six weeks, which he had done on many occasions. That could not be carried out with fruit pollen; it was too soft and would not keep, but turned mouldy. He quite agreed with Mr. Reid that unfertilised fruit was usually unsymmetrical, hard, and of inferior taste, which qualities unfitted it for commanding a good price in the market. That could no doubt be obviated by the presence of bees. He kept his bees under the trees, and they certainly did a great deal of good. Without them his crop would have been poor and very uncertain, while with them there was generally no anxiety as to the result. At the same time, it must be realised (all fruit-growers knew it) that perhaps a succession of abundant crops would be followed by a season with little, if any, produce at all. The truth was that tired Nature wanted a rest, and must have it for the purpose of recuperation. The fruits sent over from the Colonies, the necessity of which might be largely discounted if there were more bee-keepers, were grown specially for the English market. They possessed hard, stiff skins, and such varieties were chosen for travelling purposes. Again, he had neighbours who grew an immense quantity of hyacinthus for sale, and they wished him far

away with his bees, which they said spoiled the hyacinths. The bees got into their greenhouses and fertilised the flowers, which as a consequence soon faded, and in two days would be useless for market purposes. If a particular strain of flowers was required, it was necessary to keep them covered up in muslin bags and ticketed, away from any possible cross-fertilisation, otherwise the true stock would be perverted. In spite of this slight drawback, he was strongly of opinion that the B.B.K.A. could not do better than propagate the idea that bees were indispensable to the attainment of good fruit-crops.

Mr. Salmon asked whether it was not possible that the strength maintained by the skep was due to the particular time at which it was put into the house. Some gardeners found a lot of dead bees the first year, but in the second year, when they put the stock in earlier than necessary, the bees seemed to get used to the new conditions, and kept in the house rather than go out through the ventilator. It was obvious that the presence of the bees there must save a lot of labour, and he thought it an excellent way of securing the fertilisation of peaches.

Mr. Herrod said he did not think it necessary to put bees in the houses. Eight years ago, at Swanley Horticultural College, they had a gardener who, like many others, hated bees. One year was very bad for melons. The crop was a dead failure excepting one house, where the bees got in through the ventilator. The same results had happened this year with regard to melons where the bees could not get at them. As Mr. Willard had said, if bees were placed in the houses there was bound to be a considerable loss, while if they were allowed to go in through the skylight, supposing they did become imprisoned temporarily, they would live till the next morning and then go out. He thought the placing of hives in greenhouses involved an unnecessary sacrifice of bee-life.

Mr. Hill said he would like to ask if bees injured cucumbers, as for some few years he had had the privilege of placing his bees in a nursery garden, but since new people had come into possession he was given notice to quit forthwith, on the ground that the bees spoiled the fruit in the greenhouse.

Mr. Bevan said that no doubt the presence of bees would cause a mixture of varieties of cucumber, which was what the grower did not want.

Mr. Sander remarked that an unfertilised cucumber was nice for the table, but a fertilised one was like a sponge.

Mr. Willard explained that a fertilised cucumber swelled out at the bottom end, which spoilt its shape; but the important

fact to bear in mind was that if cucumbers were not fertilised there would soon be none left at all, as there would be no seed, when growers would be in a worse plight.

Mr. Reid felt that Mr. Bevan had referred almost too much to the defects of their little friends, while failing to suggest a remedy for these slight drawbacks. There was a very easy one. Nurserymen who were up to date covered, when it was necessary, the open parts of their green-houses with wire netting. A special form of this was made extensively in the United States, which excluded house-flies, mosquitoes, and bees. It was also used at sugar factories and other places, where it was important to keep out house-flies, which, as was well known, were great disseminators of disease. He thought this wire netting should be much more generally employed than it was.

Mr. Bevan agreed that this precaution was necessary for the preservation of true stocks.

Mr. Richards asked whether age had anything to do with fruit setting on a tree. As to Blenheim Orange apples, he believed that they must be several years old before they would bear fruit. He would like to know whether waiting was inevitable, or whether the fact of there being bees in the orchard would do away with the necessity of it.

Mr. Bevan was of opinion that the existence of bees in the orchard would hasten the production of fruit in such cases. He planted a Blenheim Orange tree himself six years ago, and had had a bushel of fruit off it two or three times already.

Mr. Willard thought that the discussion had not sufficiently brought out the amount of good bees do. The talk had been mainly about fruit. But besides that, people ought to consider the benefits they confer not only on horticulture and agriculture, but on floriculture too. Very few persons stopped to reflect on this, but it would be brought home to them if such a phenomenon could happen that all the bees died.

The Chairman said they had heard a great deal about fertilisation by bees and the damage to blossoms thereby. He thought that on the whole the advantages far outweighed the disadvantages, because without the bees they would not have the flowers to damage. Mention had been made about frost injuring blossom. As a rule the stigma of the pear ripened before the stamens, except when the blossom was retarded by wet weather, when the stigma remains enclosed by the petals until the stamens have reached maturity or even discharged their pollen. That pollen, however, would be impotent to fertilise the blossom, as it is not dry

and dust-like at first, but holds together, and unless removed by bees remains attached to the anther for a day or more. Mr. Reid had referred to pipless apples. He (the Chairman) had seen seedless apples and oranges which in some cases appeared to be lovely fruit; but there was a core inside which was not at all pleasant, and those trees could not produce seed, so that new and improved varieties could not be obtained. The grower had to depend entirely upon propagating such trees by grafting, and if it were not for cross-fertilisation fruit trees would die out altogether. As to cucumbers, tastes differed. Here, unfertilised cucumbers were preferred, while in America the opposite was the case, the people liking cucumbers with seeds in them, and contending that they had a better flavour under those circumstances. With regard to Blenheim Orange apples, Mr. Bevan had said that young trees would bear if the bees had access to them. He quite agreed, but thought that the unfruitfulness of such trees was due to too vigorous wood growth, and not being grafted on a dwarfing stock. This, however, had to do more with the horticulturist than the bee-keeper. Mr. Willard had remarked that no reference had been made to the fertilisation of flowers. Certainly he had dealt only with fruit trees, and even restricted that to pears. It would have taken up the whole evening to discuss apples as well as pears. A good many could be named which fertilised themselves, while others could only become prolific by cross-fertilisation, but all were benefited by it. It was very well known that without bees there would be no seeds. That was proved in regard to clover, which, when covered over, and the bees prevented from visiting it, yielded no seeds.

The Chairman then invited Mr. Lamb to make a communication regarding the B.B.K.A.

(Continued next week.)

Correspondence.

The Editor does not hold himself responsible for the opinions expressed by correspondents. No notice will be taken of anonymous communications, and correspondents are requested to write on one side of the paper only and give their real names and addresses, not necessarily for publication, but as a guarantee of good faith. Illustrations should be drawn on separate pieces of paper. We do not undertake to return rejected communications.

AMONG THE BEES.

LOCALITY AND SURPLUS.

[7637.] Two instances came under my observation this summer showing the influence location has in securing a large or small take of surplus honey. My own apiary is situated among the hills at an altitude of about 750 ft. above sea-level.

During June and July we had a few fine days with bright sunshine, but the wind blew persistently from the north or east, with sometimes a stiff nor'-easter. Bees rarely left the hive, apparently fully conscious of the fact that with wind a fixture between these two points the flowers forget to secrete nectar, even in tolerably fair and sunny weather. Lower down near sea-level in sheltered spots bees were exceedingly busy improving each shining hour and gathering a good supply of excellent honey. The distance as the bee flies would be under thirty miles, yet some of these latter hives had four racks of sections on, while mine had only one on even the best.

My second example is even a better illustration of location, accounting for a variation in surplus returns. One apiary contains about thirty hives, the other only two; yet from the smaller number more surplus honey was secured than from the larger. The distance dividing them is barely four miles. In the one case the bees had to roam considerably afield; the others had foraging sources almost at their doors; hence mainly the success of the one and the semi-failure of the other apiary. Any amount of white clover lay all round the small apiary, and limes in thousands bloomed in close proximity. The bees of the larger apiary had to travel over two miles to this source. This last feature illustrates the fallacy of those who believe that bees successfully forage far from home. On close examination it is my firm belief that it would be found bees gather 80 per cent. of their nectar within a radius of one mile of their hive, and all but the other 20 per cent. by covering a second mile.

In another case my informant stated that his bees devoted their whole time and attention to honey-dew within a quarter of a mile of the hives, neglecting healthy, wholesome nectar not more than a mile distant from their doors.

Robber-traps.—Would Mr. Taylor (7630) scatter sweets about and expect bees to eschew them? What right has he or any bee-keeper to tempt innocent bees to their destruction? Would he leave his purse filled with golden sovereigns in the open a prey to any chance passer-by? The inborn instinct in the bee is not to steal, but to sip sweets wherever they are exposed to notice. To expect *Apis mellifica* to have reasoning powers equal to differentiating between *meum* and *tuum* in such a contingency is to place her intellectually above not only savage man, but also the genus *homo* in a civilised community. The bee-keeper who needlessly *makes* robbers deserves to be drummed out of the ranks.

Comments.—These, when they secure

any correction, emendation, explanation, or elucidation, are to be welcomed, but mere verbal criticism or destructive finical or microscopic analysis can profit little:

Nothing new was said, or else
Something so said 'twas nothing.

Several recent comments, in my opinion, fall into the latter category. For example: (1) (page 326) Why should not my hive tool have three edges as well as Mr. Soal's triangular one? *It has!* So it will be seen his "two edges better" is chimerical, and has no existence in fact. (2) In two apiaries I know swarms have again outdistanced established stocks, even in this poor season. I never set this down as an invariable rule. I gave it, and again give it, as a *fact*. (3) I thought the subject of dead levelling of hives was dead. Mr. Soal practises careful levelling. I advise it as *one of the factors* going to secure perfect comb. We both practically agree. Why, then, should he occupy a full half-column beating the air? By the way, whoever introduced the word "dead" into the controversy erred, as all hives should receive a gentle tilt to the front. (4) (page 374) My cone escapes are admirable appliances and perfectly efficient for the purpose. I never knew of a single wasp finding an entrance. (5) Swing-windows, in spite of my critic's depreciatory remarks, are an excellent contrivance, and are, moreover, thoroughly trustworthy, notwithstanding his fancy picture of their inefficiency. A single motion of the hand will clear out not only his imaginary hundred, but a full thousand, bees, if any apiarist is so poor a bee-master as to carry in so many. There is nothing to hinder a "Porter" bee-escape or even a ventilator escape being fitted in as a supplement (both are excellent adjuncts); but above all have the swing-window. (6) My commentator is playing with words when he plays with the advice I gave in regard to "play" of roofs, &c. Many factory-made hives possess the fault, and it is begging the question to say they can be cured. Of course they can, but why trouble novice or veteran with doctoring hives? (7) With all deference, I think the remarks on judging honey (page 408) are puerile. Any judge with a head on his shoulders would weed out the defective sections, from whatever cause, and apply tests to only a few. I do not think any leading judge does slavishly use a rigid scale of tests, jotting down each percentage, and then totting up to one-half per cent.! But still a scale is an admirable contrivance in the way recommended by Colonel Walker (see B.B.J., 1904, pages 121 *et seq.*). All exhibitors and judges should read and carefully digest these pages. (8) Readers can weigh Mr.

Seal in the balance against either the venerated Langstroth or Mr. Ernest Root. I leave myself out, as I am a light-weight. (9) With well-made racks brace-combs should very easily be formed on bottoms of sections (I know they appear at times). But this is a minor ill when pitted against the fact that a queen-excluder is a *honey-excluder*.

"*Cappings of Comb*."—Mr. Crawshaw is so very fond of "jarring" that the "comp." was to be excused on page 346 for taking it for granted that here was another. He believes in the "shaking" plan, and practises it in and out of the apiary with a view to energising bees and men. Although he is so fond of "chaff," and chaffs so diligently and pointedly, it is really to secure the sound grain. So his jarring, shaking, and chaffing seek to work for the good of bee-keeping, which he has so much at heart. With the new year (not far away now) he is to give us at least 75 per cent. of solid nectar and no honey-dew. That is a reliable prophecy by one who knows!—D. M. M., Banff.

THE SPIDER PLANT, WASPS, AND HONEY HARVEST.

[7638.] Whilst looking through last year's B.B.J. (page 469) I was reminded of an inquiry I made and afterwards forgot to carry further. "D. M. M." wrote about the "spider plant" as a bee-plant, and asked if it is grown in this country. I made inquiries at Daniels', but they could not find out what plant I meant. Would "D. M. M." or any other reader enlighten me with the Latin name, as I should like to get some of the seed from a reliable firm?

Wasps.—I note there has been a lot of discussion about this abominable pest lately. I hope those who have been taking the part of the wasp will never have the experience that I have had this year. During the last week in August and the first week in September these little brutes (I can call them nothing else) gave me such an amount of trouble that I had to close, to all intents and purposes, every entrance in my apiary, as they were fighting with the bees to such an extent that the ground in front of my hives was strewn with dead bees and wasps. On the farm nearly fifty nests were done away with, and even then we did not notice any difference. No fewer than five in the immediate vicinity of the hives were found and destroyed. Hardly a day went by during those two weeks without someone being stung. One man in Norfolk this year was dead less than twenty minutes after being stung behind the ear. Now, I will ask, who would protect such pests as these? I cannot see how any

sane person can defend them, especially if he is a lover of bees. They may kill flies, but they also kill bees. I watched a wasp kill a bee. It first ate the head and then the thorax, after which my finger killed the wasp, thus having my revenge.

I should also like to ask if anyone has had a similar experience to mine, and if you can give the cause. This year one of my hives has given me fifty-nine sealed sections, all of which were light honey, while none of my other hives have gathered anything but dark (not honey-dew). Again, when placing my shallow frames back to be cleaned up by the bees they started to store honey in them, then sealed over some in two hives, only managing finally to clear hives on Thursday, the 30th ult., the weather, in addition, being against them for storing honey.

I sent a report to the B.B.J. in the early part of this year saying how forward my bees were, and now that everything is cleared off I do not think I ought to grumble, having taken 104 lb. from one hive (extracted), and in all getting 424 lb. of extracted and 168 sections. Three of the hives also swarmed; two of these I kept, and sold the other. These stocks did not do as well as I expected, but I got surplus from all. One stock became queenless and stored no surplus, but I am pleased to say it is very strong now, and another I did not get any surplus from. I cannot say why, as I am away at business all day; but on the whole I do not consider this year's result at all bad.

I thank you for all the information I receive from your valuable little paper, which I send my brother in Natal. He is the Government apiarist at Cedara, and considers it a great help to him in performing his duties.—B. J. MITCHELL, Kirby Bedon.

[The "spider plant" or "flower" is *Cleome pumgens*, syn. *spinosa*. It is a native of the West Indies, and requires stove treatment in this country. The hardy species are *Cleome speciosissima*, which is a very showy flower, and *Cleome serrulata*, called Rocky Mountain bee-plant by American bee-keepers. This could easily be grown in this country, and is a useful bee-plant, as well as ornamental. Notwithstanding the injury caused by wasps, which is very great, there is no doubt of their usefulness. The reason why some sections were light-coloured was because the honey was collected from other sources than the dark, and at different periods. It has not been uncommon this season to find the centre of combs in shallow frames filled with light honey, while the outer parts of the same combs contained dark honey, showing that the latter was stored at a later date than the lighter honey.—ED.]

THE SEASON IN ROSS-SHIRE.

[7639.] The season of 1899 was a memorable one in this district, a year to be remembered above all others for its enormous yield of honey. Now the lapse of a decade has brought us from zenith to nadir, for the past season must rank as the worst on record. Bees started off strong and gathered honey from June to September inclusive, but in dribbles only sufficient for their own needs, so that twelve stocks gave me less saleable surplus than one hive often piles up in a fair season. I note Mr. Woodley complains of a poor yield, and then refers to an eight-frame stock in his apiary completing three racks of sections. Well, our contracted colonies gave something like three finished sections apiece, while the more powerful expanded hives failed to complete a single rack. For instance, a doubled hive having fifteen frames of brood in mid-June was contracted to a single story, with the entire population crowded on to eleven selected frames. They made no attempt at swarming, and fully occupied two supers, but on removal in mid-August only the centre rows of sections were found completed, the others tapering off to untouched foundation. In a good season this strong stock would have given a 100-lb. surplus.

Poor as the clover harvest was, heather turned out even worse. The brilliant weather of early August came between the two crops, with no forage available but some few distant lime-trees yielding a thin greenish nectar distinctly inferior to clover-honey. After that rain and frost combined to destroy all hopes of success at the moors. Personally, I made a special bid for fortune at the golden heather, but the most powerful united colonies on restricted brood-nests and having young queens did no better than the veriest weakling. In fact, I did not get a single heather section completed. Store-combs in the brood-nest are rather light, and this, along with a paucity of late-reared bees, promises a lot of trouble with "weaklings" in the coming year.—J. M. ELLIS, Ussie Valley, N.B.

"TO PASTE IN YOUR HAT" (?)

[7640.] "D. M. M.'s" letter "Among the Bees" in the B.B.J. I never miss, but the collection of odds and ends to "paste in your hat" (page 392) contains some statements that are not quite so axiomatic to me as they appear to be to the writer. Take that quotation from Cheshire: "Swarm from your best stock. This is a golden rule too often forgotten. You thus get a good queen for the swarm, and her good qualities will be continued in her successor. Swarming from a poor stock is perpetuating the progeny of an

effete queen and keeping the apiary under a star of ill-omen." Is there not something wrong here? How could one get a swarm from an "effete" queen? The very fact of breeding to the extent of swarming rules out of consideration any question of being effete (barren, exhausted, worn out).

If Cheshire had said, "Don't bother with a queen which cannot raise her colony to the point of swarming," there might be something in that, although the workers in a hive can as a rule be depended on to see to the deposing of a queen of this kind. I incline to the belief that the internal economy of the hive can quite well be left to the bees themselves. By this I mean one can with all safety leave the re-queening, fertilisation, breeding, and brood-rearing to the bees, and confine one's sphere of management to the feeding and external manipulations of the hive. Outside influences can greatly assist the egg-laying powers of a queen. For instance, if bees are poorly wintered, the colony and queen suffer, and the queen of a badly-wintered stock seldom, if ever, recovers from the weak condition which bad wintering entails.

If one ensures that his bees come through till spring-time in proper condition very little grumbling about effete queens will be heard.—R. WHITE, Glasgow.

RAILWAY CHARGES.

[7641.] On September 16 I sent to a show twelve sections of honey and twelve jars, and although I sent two assistants with this small quantity the railway company insist upon charging 1s. 2d. carriage for this, as they contend it is not passenger's luggage. Can you inform me whether they are justified in this, as I want to resist the claim, but shall be glad to know if I have any chance in a law court on this point? You may publish this in your columns if you think it worth while, as perhaps other exhibitors have met with the same treatment. Thanking you in anticipation.—JOHN CARVER, Salop.

[The railway company are quite justified in making a charge, as honey is not passenger's personal luggage, and is classed as merchandise.—Ed.]

WERE THERE BEES IN THE GARDEN OF EDEN?

[7642.] I was much amused and interested in Mr. Smallwood's letter (page 394) under the above heading, and will just assist him a little by telling the story of the first kiss!

"It was on a beautiful morning that father Adam returned to his dwelling and found Eve fast asleep. He bent down

over her, and observed that bees flew round her head, alighting on her mouth! He bent down lower and lower, and at last touched her mouth with his lips, and found that it was so sweet, so sweet!"

Can anybody deny, after this apodictic proof, that bees existed in the Garden of Eden?—ALEX. SCHRÖDER, Trieste.

CAPPINGS OF COMB.

BY L. S. CRAWSHAW, NORTON, MALTON.

Comb-foundation (page 374).—Let Mr. Soal rest himself in peace in that I carefully examined the point before driving it home. As this is by no means a boring subject, it is a sign of good augury that he intends at some time to follow up the point!

Leveling Hives (page 374).—Lots of small, cheap levels are far from correct, and such an error as that stated—viz., $\frac{1}{8}$ in. in 20 in.—is only $\frac{1}{30}$ in. in a 4-in. level. I have seen such levels in use, and when used across the frame-tops the result is by no means accurate. Such levelling, however careful, is useless if the frames be unscrapped or the top bars of different thickness; and many home-made hives are sufficiently untrue to give more than the stated error when levelled on the wood. This, too, I have seen in my travels through the great and glorious bee-world. By the way, it might be as well, in these days of positive-negatives and Polar controversy, to assert that we find the bee-world by no means so zetetic as some would have us believe!

Swarms and F.B. (page 374).—Mr. Soal has at least seen the point that proof is difficult, if not impossible. I tried to make this clear (page 347). But he does not even attempt the task. He offers no chapter and verse, nor does he say how long after having his swarms developed disease. Instead of this he appeals to Simmins; so unto Simmins he must go. I find on "page 119" of "A Modern Bee-Farm" no direct evidence in favour of the contention, only a guarded exception. Of course, it is conceivable that germs might be in the honey-sacs of the swarm, but I have already dealt with that probability (pages 298 and 347). Mr. Simmins's whole argument seems to be that flying bees do not carry infection, and that germs do not run about seeking what they may devour. Which last theory seems to be Mr. Soal's fear in his "flight-room" experiment. The weight of authority appears to be against him—authorities, by the way, against whom he tilts, and to whom he appeals when asked for his own personal evidence!

Plain Cone Escapes (page 374).—I thoroughly agree with Mr. Soal about these. They are a delusion and a snare. Better have a few bees trapped in a roof than

have an outlet which can undoubtedly be found and used as an inlet by persevering robbers. It does not need much ingenuity to fix a light—a very light—spring to existing cones to make them safe. But the plain brass cone would be improved if the punched holes were large enough to admit the head and not the thorax of a worker-bee.

Hybrids (page 385).—If I may advise "Jas. Carruthers" it would be to the effect that he should not let this Italian strain spread into his present stock of bees. That is, if he values his strain at all and has expended any work upon it. The faults will be perpetuated, if not intensified, with deterioration of temper in the resulting hybrids, and he will perhaps wish that he had made the first loss the least. To trap all drones and re-queen in the spring is the substance of my advice.

Wax-gathering in Malaya (page 388).—This vividly-written account presents a striking picture of Malayan "apiculture." It is hardly surprising that hammering a tree "six or eight feet thick" failed to either rouse or subdue the bees! But it is no wonder that the natives left the vicinity at dawn, taboo or not taboo. For, if the bees are anything like our own, imagine, in addition to their outraged sanctity, their fury over the honey wrung out in the forest clearing. The average weight of honey is not stated in this extract, but this tropical race of bees may use their combs principally for brood-rearing, in which case the honey may be largely inferior.

To Paste in Your Hat (page 392).—Now what size in hats does that man of Scotland think we Sassenachs wear? Here are something over a score of slips to be put 'twixt the hat and the hat-band. Those who, like myself, habitually wear their hat on their shoulders, snuffer fashion, may manage it. But even I find it difficult, for I recently met this kindly son of the clan Macdonald, and so many nice things were said to me that my head swelled until the very hat would hardly contain it.

Bees in Paradise (page 394).—I am told that the negroes have a tradition of their origin to the effect that Adam was stung by a bumble-bee, which caused him to turn black. I don't know if this can be relied upon as evidence! But Mr. Smallwood's map of Eden must be wrong, for whilst we know that honey, when we do get any to dispose of, is "simply heavenly," there could have been no bees in the Garden, or Adam and Eve would never have left it. Therefore, Eden is not in Heaven. To premise an "H.B.J." is to suppose that there will still be difference of opinion, and a lot more to learn,

in Heaven itself. I hope there will, but may it be a long time before those we know in the pages of the B.B.J. take their contributions elsewhere.

A *Verbal Scrape* (page 396).—After much re-perusal of Mr. Soal's mutilated sentence I begin to get a glimmer of his meaning. So in fairness I give it here with all its sense in full: "I do not stand up for a scraper as a tool, so much as for its proper use." I omitted the words I have italicised, not in sheer wickedness, but to show the weakness of the comparison and in an endeavour to arrive at what the writer really meant. And it must have been due to my lack of deftness that I had a wheel left over after attempting to clean his grammatical clock, which ran very well until I touched it! I should at least have returned the wheel with the clock, so here it is.

Echoes from the Hives.

"Your paper at the *Conversazione* on cross-fertilisation is the best contribution to the subject which I have seen. The honey harvest has been a failure this year with us. None from the clover and only a small quantity from the limes, which had a slight admixture of what I take to be honeydew, as at that time the bees were very busy around the oak and the beech."—J. G., Bridge of Weir, N.B.

Bee Show to Come.

November 11 and 12, at Exeter.—Devon B.K.A. Annual Show of Honey, Wax, and Appliances, &c. Open classes. Schedules of R. W. Furse, Hon. Sec., Woodbury. **Entries close November 2.**

Notices to Correspondents.

W. R. A. (South Norwood).—*Exhibiting at Dairy Show.*—Honey in the trophy classes can be shown in jars of any size or shape, and although granulated honey in narrow-mouthed bottles would have to be liquefied before being used, there is nothing in this fact to disqualify such an exhibit.

REV. F. V. W. (Gloucester).—*Ripening Honey.*—Honey must be run into a deep vessel, or a ripener such as is shown on page 88 of "Guide Book." No spirit-lamp is required, but the honey must be kept in a warm, dry place for a few days to allow it to settle and ripen. The time it will require will depend upon the temperature of the place. During this time the thick honey settles at the bottom, and is then fit for bottling, while the liquid honey, with the particles of wax and pollen, will float at the top, and would be no good for bottling. 1. Yes; unripened honey is inferior, and will not keep. 2. It

would certainly command a lower price in the market, even if saleable.

J. M. D. (Cheshire).—*Changing Race of Bees.*—1. Pure Carniolans are very quiet and not inclined to sting, and your best plan, if you wish to change your black bees for these, is to introduce Carniolan queens as early next season as you can obtain them. 2. Take the extractor to pieces, and wash all the parts with boiling water, wipe dry, and keep in a dry place.

C. E. A. (Martock).—*Name of Plant.*—The flower sent is that of *Arbutus unedo*, or strawberry tree, so called because the fruit resembles a strawberry. It is one of the prettiest trees in flower at this time of the year and when the fruit of the previous year is ripening. It is indigenous in the West of Ireland, but is of little value for bees in this country.

R. H. O. (Birmingham).—*Uniting Driven Bees.*—Driven bees act like swarms and mark their new location when hived; therefore the plan you have carried out is quite feasible. The best plan, however, would have been to make an artificial swarm of the queenless stock and unite it with the driven bees from the skep, dusting both lots with flour and allowing them to run into the hive together (see "Guide Book," page 107).

F. H. F. (Gloucester).—*Wintering Bees.*—1. If the hive-rooms are already rain-proof there is no necessity to have corrugated zinc. Calico, well painted, makes a good light covering (see "Guide Book," page 42). 2. The best

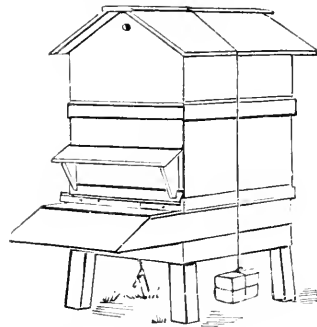

way to secure hives in exposed situations is to have the roofs weighted down and made fast to the hive-bodies, as shown in illustration. A stout peg is driven into the ground in an oblique direction on one side of the hive, and a cord attached to this with a heavy stone or bricks at the other end is all that is necessary.

G. M. (Hindhead).—*Extracting Honey from Skeps.*—If the honey is so thick that it will not run out in an ordinary extractor, and you have not got a "Rymer" press, your best plan will be

to cut the combs into small pieces and crush them. Then strain through muslin or a fine hair sieve. If kept in a warm room the clear honey will not be long in passing through.

E. R. ST. H. (Barnard Castle).—*Disinfecting Hives and Wintering*.—1. If the frames are parallel with the entrance and hang too low for the bees to pass, it would account for the dead drones not being removed. 2. The animals enclosed are dipterous larvæ, probably of *Volucella*, parasitic in nests of bees. 3. Thoroughly scrub the hives and boards with soap and hot water, and paint with solution No. 11 (page 198 of "Guide Book"). 4. The wire queen-excluder will not do as a substitute for winter passages, which should be at least $\frac{3}{8}$ in. high. 5. If you give the bees thick syrup warm they may probably get some sealed yet, although feeding should have been completed by the beginning of this month. If weather turns cold give only candy (recipe No. 2, page 195 of "Guide Book").

WEST HANTS (Andover).—*Granulated Heather Honey*.—You cannot market granulated comb honey as "run." In order to separate the wax which has amalgamated with the honey you will have to add water and apply heat until it has all dissolved, when the wax will rise to the surface. After removing the wax the honey must be evaporated to the proper consistency in a temperature not exceeding 170 deg. Fahr., but even this temperature will affect the flavour. Heather honey should always be pressed from the combs, without applying heat, as soon as it is taken from the hives, and should not be allowed to granulate.

M. M. L. (Oxford).—*Moving Bees*.—You must allow free space over the frames even if you do not use perforated zinc, otherwise the bees will very soon make holes in the canvas. If you do not want to go to the expense of having frames made, you had better fix an empty shallow-frame super on the top of each hive and cover it with strong coarse net, but be careful to leave no opening where the bees could get out. An eke on the bottom would be an advantage for giving additional air-space. The hives can be prepared at any time, but the canvas should be put on the day before removal, and the entrances closed the last thing when the bees have ceased flying.

F. C. R. (Cambridge).—"*Ryder*" *Honey-board*.—1. It can be used for both shallow frames and sections. 2. A queen-excluder is not generally used with it, and occasionally the queen will get through. 3. By placing the openings across the frames the board can be left on all the winter, thus providing winter

passages. 4. To prevent propolisation, the joints which the bees are able to get at should be rubbed over with a rag moistened with a small quantity of vaseline. 5. Albo-carbon is the same as naphthaline.

DEESIDE (Aberdeen).—*Wax-mould*.—1. A little oil rubbed on with a rag will prevent wax from adhering to a tin mould. 2. We do not think bees are likely to spread foul brood by gathering artificial pollen together.

Honey Samples.

A. A. H. (Airesford).—A very nice-flavoured honey, mainly from clover, but, like most of the light honeys this year, it is a trifle thin. The section was smashed in post.

F. V. R. (Thornton Heath).—Sample is of good colour and consistency, but there is no predominating flavour. It is rather sweet and insipid.

W. G. A. (Elgin).—There is no heather flavour or aroma in sample, and as it is partly granulated it does not seem to be too thin. A very nice-flavoured honey.

MID-KENT.—Honey of inferior quality: not good enough for the show-bench. Colour medium.

A. B. (Yorks).—Sample has a strong flavour and aroma of wallflowers. It contains no honey-dew, the dark colour being caused by the sources from which it was gathered.

A. S. L. (Moreton-in-Marsh).—Honey of poor colour and flavour. It contains a small quantity of honey-dew, and has no predominant flavour, being gathered from mixed sources.

R. WHITE (Glasgow).—Very good light honey, quite up to show standard. The only fruit-bloom honey of such light colour is that obtained from raspberries.

J. H. TOM (Truro).—Sample is thin in consistency, though beginning to granulate. Gathered from mixed sources. Flavour fair.

Suspected Combs.

F. M. S. (Bexhill).—1. There is no brood at all in the comb, which appears quite healthy. 2. Messrs. Jas. Lee and Son, 4, Martineau Road, Highbury, sell a bee-vaccinator, but we cannot say if this is the one you refer to.

GOMER TALOG (Edenbridge).—The comb is infested with wax-moth (*Galleria cerana*). You had best burn the combs if they are all as bad as the one sent, and thoroughly cleanse the hive. If hives are strong, they are usually able to keep this enemy out, but empty hives containing combs should not be left with entrances open, and all odds and ends of wax should be melted down into cakes, or they will become a breeding-place for these moths.

Editorial, Notices, &c.

BRITISH BEE-KEEPERS' ASSOCIATION CONVERSAZIONE.

(Continued from page 414.)

Mr. Lamb said that his object in addressing the meeting on the earliest possible occasion after the termination of the honey season was to call attention to the special appeal made in May last, and to thank those who had already generously responded to the Council's request, and also for the letters of encouragement and sympathy that had been received. He had had to deal with widely different kinds of bee-keepers. Some said: "Your Association is a business concern, and therefore you ought not to go to the public for help." Another class said: "We shall be pleased to help all we can if you will say what you want us to do." If there was one man more than another who had steadfastly worked through good and evil times for the promotion of the Association it was their Chairman (Mr. Cowan). He (the speaker) would read half a dozen lines from the "British Bee-keepers' Guide Book," 19th ed., 1907. After referring to the great strides made in modern bee-keeping, the author said: "There is no doubt that this progress is primarily due to the educational work of the British Bee-keepers' Association, an entirely philanthropic body, whose efforts are devoted to the furtherance of the pursuit as a rural industry, advantageous to small farmers, cottagers, artisans, and others. In view of what has been stated above, it is much to be regretted that the usefulness of the British Bee-keepers' Association is restricted by insufficiency of funds for the increasing work it is called upon to do." He (Mr. Lamb) was sure the old members of the Society would agree that the Association was a philanthropic body striving to educate the public in their best interests, and as such had a right to ask for public support. It had done excellent work in this direction already, and could accomplish a vast deal more but for the limited funds at its disposal. If the Government would only make a grant of £500 per annum towards the funds their anxieties and difficulties would vanish. But, failing that, he suggested that those who were interested in the success of the institution and acknowledged its benefits, and were able to afford it, should increase their annual subscription from 5s. to 10s. 6d. or £1 1s. The usual subscription to such societies as theirs was 10s. 6d. or £1 1s., but when the B.B.K.A. was founded the fee was for some reason or other fixed at 5s., and that rule had remained ever since, so that subscribers did not give any more. He hoped many

would increase their contributions. Some had done so, several having given even more than a guinea. It should be borne in mind that there always occurred at some time or other a period of depression in societies of this character. It generally happened about thirty or forty years after the institution was founded, and was explained in this way. Many, perhaps most, who joined the Society in the early days had reached old age by that time and departed from the ranks, their enthusiasm being difficult to replace. The late Baroness Burdett-Coutts, a most generous supporter of the Association's funds, was always willing to help whenever the Council were in difficulties and wanted money, but it was far better to have a number of small subscribers than an equivalent amount from a large one. This view was once well expressed at a meeting by Charles Dickens, when he said: "Money in lump is a good thing in its way, but the life blood of a hospital flows most safely through its guinea and two-guinea subscription list when that is large and steadily maintained." Precisely the same argument applied to the B.B.K.A., and he (Mr. Lamb) begged those who had not yet responded to the appeal kindly to increase their subscriptions next year. He was not going to ask anyone to sign a form now, but if any present would like to fill in the forms proffering additional help these could be obtained from Mr. Cowan at the B.B.J. office or from Mr. Herrod, and they would eventually reach his (Mr. Lamb's) hands.

Mr. Cowan then proceeded to introduce the next subject, on "Some Recent Investigations in Connection with Diseases of Bees." He said:

The prevalence of disease and the necessity for having bees perfectly healthy is my excuse for introducing this subject, which is of the utmost importance to the bee-keeper.

During recent years we have been subjected to diseases which were not known formerly, and the importation of foreign bees has probably been the means of introducing dangers from which, owing to our insular position, we have been hitherto free. In particular I should like to call your attention to some diseases that we know very little about, but which are becoming more prominent every season. One of these has been called the Isle of Wight disease and another May-pest.

Closely related to these, I wish to point out some of the investigations that have been made during the last two years by Dr. E. Zander, of the Royal Apicultural Institute, Erlangen, Bavaria.

One of the recent discoveries of science respecting diseases has been the fact that

in man and other animals, not only are the lower or vegetable forms of bacteria a cause, but that microbes belonging to another family of the higher bacteria may also play an important part. Diseases like malaria, sleeping sickness, and some others are now known to be caused by such unicellular microbes. Up to the present we have only known the lower forms of bacteria in bees, such as the different bacilli found in foul brood and a streptococcus present in sour brood. Dr. Zander found in 1907 in the chyle-stomach of dead bees a large number of egg-shaped microbes, which reminded him of the higher bacteria of other insects. On further investigation they were proved to belong to the *Nosema* family.

The *Nosema* are parasitic in different animals, and one well known and much dreaded, *Nosema bombycis*, is the cause of the disease in silkworms called "pebrine." This disease has been a serious drawback to the silk industry, and since 1867 has entailed a loss of over a million millions of francs.

The particular organism, which has also been identified with the silkworm parasite by Professor Dosleiu, of Munich, has been named *Nosema apis* by Dr. Zander, its discoverer.

Its life-history is very simple. It is, like its relatives, a cell parasite, capable of multiplying in living matter and not outside the body of the bee. It is confined exclusively to the chyle-stomach, and when it has filled the cells and exhausted

spores, and are what we usually see when a preparation is examined under the microscope. Dr. Zander has been good enough to send me photographs of these preparations, which distinctly show the spores. They are about $\frac{1}{200}$ mm. long and $\frac{1}{300}$ mm. wide, and are distributed singly or in groups. When one of these spores enters the chyle-stomach of a healthy bee the outer membrane bursts

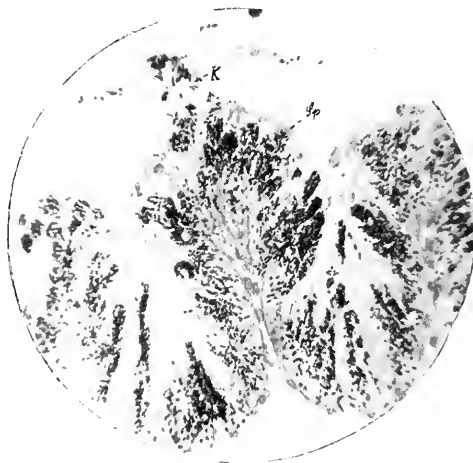

SECTION THROUGH CHYLE-STOMACH OF DISEASED BEE, ENLARGED 300 TIMES.

Sp. *Nosema* spores in stomach-cells.

K. Disintegrated infected cells, which are voided with the excrement.

and the minute parasite escapes, and commences to bore into the stomach lining, where it grows and multiplies at the expense of the cellular tissue, and in less than four days these parasites turn into spores. Generation follows generation so rapidly that in a short time the stomach lining is completely choked with spores, its structure is destroyed, and a section made of it shows that the spores have replaced it.

In healthy bees the chyle-stomach has a clear reddish tinge, but the increase of *Nosema* spores gives it a cloudy and milk-white appearance. The spore-filled stomach-cells, as they become disintegrated, are evacuated along with the fæces, and in this way, coming in contact with food, may convey the disease to healthy bees. Dr. Zander has been able to prove this by feeding bees on honey mixed with these excreta. Bees thus attacked are beyond recovery. They fall from the alighting-board on to the ground, and are unable to rise, and sooner or later die.

According to Dr. Zander, this parasite is the greatest bee-enemy known, and thousands of colonies have been destroyed by it every year without the bee-keeper suspecting the cause, and he deems it far worse even than foul brood.

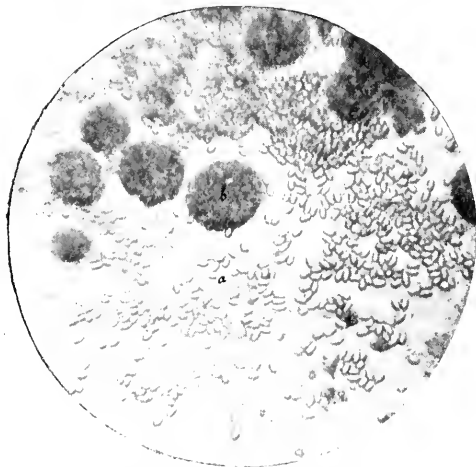

CHYLE-STOMACH OF DISEASED BEE, ENLARGED 500 TIMES.

a. Single spores of *Nosema apis*.

b. Cells filled with spores.

the nourishment it surrounds itself with a membrane, and in this condition, even if dried, is able to survive for long periods outside the body of the bee. These egg-shaped bodies are generally called

In studying diseases he has found this parasite in large numbers in dysenteric bees and in their excrements. In twenty-two out of twenty-five cases examined last spring he did not find a single bee free from it. Most bee-keepers do not consider dysentery a serious disease, and if certain precautions are taken it seems to disappear, but here Dr. Zander points out that there are two forms of dysentery. One is a mild, harmless form, and can be cured by the bees having a cleansing flight, a warm dwelling, and good food. In this form the faeces are coarse-grained, have a sour smell, and mixed with water, produce a yellow pulp which consists principally of pollen. Of the twenty-five cases examined by Dr. Zander, he found this mild form in only three of them.

The second, or virulent, form is more frequent, and is also more dangerous. During last spring Dr. Zander says it destroyed more colonies round Erlangen than foul brood has done in the whole kingdom of Bavaria. In this disease the discharge of faeces is not a regular, but an occasional, accompaniment, and some bee-keepers have even noticed what they call "dry dysentery," which they dread even more than the other.

During the progress of the disease there are all the symptoms of an infection with *Nosema apis*. Colonies may not be queenless, may have abundant stores, may pass safely through the winter, and have their proper cleansing-flights, yet they die off rapidly in the spring. Being at its worst in May, the disease has received the general name of May-pest (*Maikrankheit*). Microscopical examination of such bees shows the chyle-stomach to be milk-white and filled with *Nosema* spores. The evacuations, which are at first liquid, dry to hard brown scales, have a peculiar smell, and, diluted with water, make this muddy, and show numberless spores. As a result of the infection the cells cease to act, and as the food consumed goes to support the parasites the bees suffer from hunger, which also causes thirst.

The principal means of spreading the disease is by the evacuations, which soil the combs and, owing to their fluidity, get mixed with the honey. As the bees take their cleansing-flights the whole neighbourhood of the apiary may be infected by their excreta, which are frequently found on the alighting-board and sides of the hive. The interchanging of soiled combs is also a means of infecting a healthy colony. An infected colony, except in rare cases, dies out sooner or later, as Dr. Zander has found that even the queen may become diseased, although up to the present he has not found any diseased drones. He has observed several cases in which colonies became cured, and says that a cure only takes place when the

queen escapes infection, the weather being warm, and stores coming in plentifully.

The disease seems to run its course in about four weeks, as virulent dysentery in spring, as May-pest in May and in June. In early spring, when bees are not able to fly, they soil their combs; but in May and June their excreta are not noticed, as they are evacuated during flight. Dr. Zander here remarks that the outward symptoms are similar to those noticed in the disease that was epidemic in the Isle of Wight, and also in Brazil. He cannot say yet if the disease in these places is also produced by *Nosema apis*. Dr. Malden found a bacillus in the Isle of Wight disease, which he has named *Bacillus pestiformis apis*, but has not yet established its relationship to the disease. I have recently been able to send Dr. Zander diseased bees for examination, and we shall be interested to know if he is able to trace *Nosema* in them.

Dr. Zander has carried out a series of

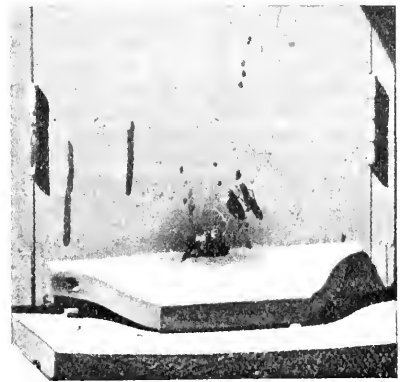

SOILED FRONT OF HIVE OF EXPERIMENTAL COLONY EIGHT DAYS AFTER INFECTION WITH "NOSEMA" SPORES.

experiments, and has been able to infect healthy colonies with the disease by mixing the excreta with diluted honey and feeding the bees with the mixture. After three days the mortality commenced, and on microscopic examination after eight days it was found that the chyle-stomach of the dead bees was white and filled with *Nosema*, while the general condition of the stock showed the characteristics of May-pest. Every day a large number of bees came out of the hive to die, while the mortality after a rainy day increased. In four weeks the colony had only a handful of bees left.

The important consideration is how to combat this disease. To cure diseased bees is impossible, but by taking precautions an epidemic can be averted. First we must bear in mind that colonies mildly affected may recover if the queen remains

healthy and there is a good honey-flow; and, second, that soiled combs are the principal means of spreading the infection. Dr. Zander therefore recommends that the combs should be removed, the bees put into clean hives, and started on comb-foundation. Any combs containing brood should be placed on one side and removed as soon as the brood has hatched. The bees must be kept warm and fed liberally. Later they can be re-queened, as generally the queen of a diseased colony succumbs the following winter.

The soiled hives must be scrubbed with a hot solution of washing-soda. The combs must be melted, and the bees encouraged to make new ones. The renewing of combs is the main principle of all cures of bee-diseases. Using old combs year after year is one of the great mistakes of bee-keeping in movable-comb hives. Bees kept in skeps are much healthier, because the swarm has to make new combs; it is its first work, and is a necessity for the well-being of the bees.

I have given a brief outline of Dr. Zander's work, and although I cannot say if there is any connection between it and the Isle of Wight disease, I hope his investigations will enable us to observe more closely the different symptoms, and take the proper measures for stamping out any similar outbreak in our apiaries.

(Continued next week.)

Correspondence.

The Editor does not hold himself responsible for the opinions expressed by correspondents. No notice will be taken of anonymous communications, and correspondents are requested to write on one side of the paper only and give their real names and addresses, not necessarily for publication, but as a guarantee of good faith. Illustrations should be drawn on separate pieces of paper. We do not undertake to return rejected communications.

NOTES BY THE WAY.

[7643.] The weather continues very unsettled, and is likely to remain so for a time. It is an unusual sight to see corn still standing in shocks in the fields so late in the year; in fact, I saw the reaping machine at work to-day (October 25) cutting oats. It is many years since the ingathering has been so late. A neighbouring farmer told me he had to re-make his ricks, as the rain had penetrated them before they were finished, with the result that in the centre the corn was rotting. The bee-keeper's plight is not so bad as that, though we have good cause to grumble over the shortage of the crop and the poor quality of the bulk, it being reduced in value by honey-dew.

The unsettled weather prevents the final touches being put to the packing up for winter and the general tidying-up of the apiary (often much needed at this period),

so that the legs of hives may be free from weeds, which keep them damp and engender rotting. A small piece of broken slate is better than either brick or tile for the legs of hives to stand on, as it does not absorb so much wet.

The long evenings will give those who have leisure an opportunity of reading up the spring and summer numbers of our BEE JOURNALS, and noting for future reference those items which may prove stepping-stones to success another season; or we may review our own work in the apiary, and see if we have done all we ought to secure that measure of success possible in even a poor season. While these items are fresh in the memory is the time to jot them down for future guidance.

Those bee-keepers who possess out-apiaries will have been able to judge where the best honey is secured and in the largest quantities. These points will help in deciding where the largest number of hives shall be located next season. Another point is the best style of hive suited to the requirements of the apiarist. For myself I still vote for the "Combination" hive. With me, another season has proved its merits, and I prefer it to any other.—W. WOODLEY, Beedon, Newbury.

BRITISH BEE-KEEPERS' ASSOCIATION

[7644.] I have noticed in the B.B.J. at different times during the past twelve months various suggestions for making the B.B.K.A. more efficient and popular, but no practical solution seems to have yet been found.

After all the mother Association has done to foster and help the craft throughout the British Isles in the years gone by it is a blot upon bee-keepers that its work should be hampered by want of funds to extend it.

In all the letters I have read and from my own experience I am of opinion that no one has touched the weak spot, and yet it must be patent to a great many besides myself. An association of any kind cannot succeed unless it has a good leader. Now I contend that no association, so far as the real head is concerned, can approach ours in the person of our chairman, who has done, and is doing, all that mortal man can to help on the Association; nothing is too much trouble for him, and we never appeal to him for help of any description in vain. The Council has also now young and enthusiastic members. This does not suffice, for there is one official who can do more than all the rest for its success. Without a good, energetic secretary, one who has enthusiasm and a real love for his work, as well as a thorough practical knowledge of apiculture in all its branches, so that he can

help members with advice in any difficulty, the Association can never hope to maintain its position, let alone attain the prominence which is its just due. This is the weak spot, for, through no fault of his own, but the misfortune of ill-health and overwork in other directions, our secretary has not been able to carry out his duties in a satisfactory manner for some time past, and consequently the parent society has been losing touch with the affiliated associations; hence its present position. This is patent to a great many. Such being the case, why not face the difficulty and try to remedy it? Has not the time arrived when it is important—nay, even a kindness—to relieve him of the work, and try to find another secretary willing and able to put his soul into the work, and, with the help of the energetic officials we now have, pull the Association together again?

I do not point out defects without being able to suggest several ways in which they can be remedied and the Association made more efficient and a real help to its members and affiliated associations. In the first place, the valuable library should be made accessible. I have been a member of the B.B.K.A. over fifteen years, and have not yet even seen a list of the books it contains. The office should contain at least one room where the library can be properly arranged on shelves, so that any members visiting London could go up, see, and read them, or take them home for that purpose for a period. The room should also be nicely furnished, so that they might use it as a meeting-place for their friends, or for business purposes. Also the table should be provided with foreign bee-journals and other literature for their use. Any new invention might be placed here for inspection, together with all the leading appliance manufacturers' catalogues; in short, make this room into a miniature club with very little expense. Then let us have again those quarterly Conversations we used to enjoy so much, with papers from our leading lights and discussions thereon. Further, the secretary should be able to attend, and if necessary speak at, meetings of county associations, thus bringing them in direct touch with the parent. I would also suggest that occasionally meetings of the Council be held in various parts of the country, especially the North and West, and delegates from the associations in the vicinity of the meeting-place be invited to meet them for discussions and to put suggestions before them.

Very often county associations are strong in members and subscribers, but die out for want of a secretary (as an illustration, take the county of Kent). In such a case the parent Association should

adopt the method of friendly societies when one of the branches becomes weak—take up the work and foster the association till the right man is found to carry it on again. I could name several associations which are in this position at the present time. By method and organisation this could easily be done. I am sure that if the Association showed its sympathy in such a practical manner there would be no lack of support in funds. Take, for instance, the Utility Poultry Club, which worked on similar lines; it was only necessary to appeal to members to double their subscriptions when a large percentage of them did so. We could also have Fellows of the Association—say at one guinea each—and give them more privileges than ordinary members, who ought to pay not less than half a guinea.

I would also add one of Mr. Garcke's suggestions, that expert certificates be granted on the condition that upon the holder ceasing to be a member they are returned to headquarters.

Many more suggestions present themselves to me, but I have already trespassed far too much upon your valuable space, so will close, hoping this letter will bring out other ideas, and result in the adoption of some of them, thus giving us an Association equal to, or better than, that of any other country.

Wishing all brother bee-keepers the long-looked-for bumping season in 1910, I send name for reference and sign myself—LIVELY BEE.

[Our correspondent will see that this matter is at present occupying the attention of the Council. At their meeting on October 7 a committee was appointed "to consider generally the present position of the B.B.K.A., and to report what measures should be taken to improve the same," and no doubt this committee will give due consideration to the above suggestions. Also at the special meeting of the Council on October 13 Mr. Herrod was appointed acting secretary for the time being, owing to the continued ill-health of Mr. E. H. Young.—Ed.]

[7645.] Though I have not taken any prominent part in bee-matters lately, yet my interest is none the less keen as regards both the pursuit of bee-keeping and the welfare of the B.B.K.A., of which I was for some years a member of the Council. I have been sorry to observe for some time past that the Association has been getting into low water, and it is with much pleasure I note in this week's BEE JOURNAL that there is evidently going to be a change, which will, I sincerely trust, result in a speedy turn of the tide. I refer to the appointment of Mr. W. Herrod as secretary *pro tem.*, as I consider this to be a most excellent move on

the part of the Council, who are evidently determined to remedy matters. I have known Mr. Herrod for a great many years as a good and faithful servant of the B.B.K.A. His promptness and keenness in his work, his business capabilities and knowledge, his readiness to help one and all, and, above all, his popularity amongst bee-keepers throughout the country, of which, as hon. secretary of the Essex and Suffolk B.K.A. for many years, I had ample opportunities of judging, make him, in my opinion, the right man for the position. I shall esteem it a favour if you can find room for this letter in the BEE JOURNAL.—W. J. SHEPPARD, Matching Green Apiary, Harlow, Essex.

BEEES NEAR COPPER-SMELTING WORKS.

[7646.] Referring to M. Bertrand's report (page 331) of the destruction of bee-keeping in the vicinity of new smelting works on the Continent, I notice in the Engineering Supplement of the *Times* of September 15 an interesting description of a new process by which fans, operating on the copper fumes emitted from the furnace, prevent to a great extent the noxious smoke issuing from the shafts, with such destructive effect on animal and vegetable life. It is found that as much as 75 per cent. of copper, arsenic, and other products, dissipated at present and poisoning the atmosphere, can be captured, and the process is not only said to be remunerative, but likely to bring about the "scrapping" of those huge and costly chimneys one of which at Great Fall is 500 ft. high and 60 ft. in diameter at the base. It will indeed be a glad day when this reported revolution in treating "copper smoke" becomes generally successful. Not only will it be welcome to the genus *apis*, but equally so to the genus *homo*!

Some people are already prophesying that we shall soon build houses without chimneys, owing to the improvements in smoke-prevention, by promoting perfect combustion of fuel and with it a perfectly clear atmosphere.—E. D. T., Kent.

NOTES FROM NORTH BUCKS.

[7647.] *Wasps*.—A trap for wasps that answers well with me consists of a box about 4 in. by 6 in. and 2 in. deep; in the bottom is an ordinary "Porter" bee-escape, with a piece of glass for a cover or top. Some moistened sugar is placed inside, and I find quite 100 wasps are trapped to one bee. I place the box on a hive, with about half the entrance to the escape overhanging. It appears to me that once a wasp gets into a hive it will keep on robbing hives as long as it lives. It is annoying to see them try the

entrance of one hive after another till they find one comparatively unguarded, when in they go.

More than One Queen with Swarm.—During the last week of May I artificially swarmed three or four lots, and intended to cage some of the queen-cells about the twelfth day; but what with other business and the unsettled weather I delayed the operation till June 13, which was fine and warm. I noticed casts coming out of two or three stocks, and on starting to hive them several others came out, till just as I had hived the third lot another settled in the same place. On hiving these, I picked out and caged three queens. I had the cast on ten frames of combs and full sheets of foundation at right angles to the entrance, and shall always believe there were then two more queens, for the bees seemed to divide themselves into two lots inside the hive. They seemed to settle down in their new quarters, but although it was not "swarming" weather during the next two days, they decamped on the evening of the 15th.

Cleaning Tops of Brood-frames, &c.—I find a "pointing" trowel with blade about 5 in. long and 2¼ in. wide in the widest part (the edges should, of course, be fairly sharp) is about as useful a tool as any. It can be used for many other purposes besides scraping tops of frames.—A. HARRIS, Wavendon.

BEE-KEEPING IN MEXICO.

[7648.] As regards the bees in this part of Mexico, after 295 days with only one shower the rainy season broke on us on June 30, since which date torrential rains every two or three days beat down the flowers and wash away any nectar, so that the long drought, followed by the rainy season, has given the poor bees a very hard time, so much so that drones were turned out of the hives at the beginning of March, which speaks for itself.

I thank you for your kind instructions as to preparing leaves of plants for transmission to avoid decomposition, and when the season comes round I will endeavour to send you some of our "salvia."—FRANK W. BREACH, Chinipas, Chihuahua, Mexico.

BEEES IN THE COTSWOLDS.

[7649.] I am a young Cotswold bee-keeper of two years' experience, and send a few notes from this district which may interest your numerous readers. The weather, like that in most parts of the country, has been heartbreaking. The abundant bloom of sainfoin and white clover would have gladdened the heart of any bee-keeper, had not the weather been so wet and stormy that, with the exception of the few brilliant days in

August, the bees were unable to take advantage of it. Of course, the average "take" of honey in this district has been a small one, but I have managed to secure some well-filled sections and frames with honey of excellent quality. Up to the present I have been able to save thirty-three lots of bees from the sulphur-pit, but this has not been accomplished without many a long, wearisome ride on my "bike," with five or six boxes strapped on behind containing the bees. Very often, on arriving home late at night, I have been obliged to transfer the bees from the boxes to their new homes by the flickering light of a candle. Many of the lots, having young queens, have drawn out six frames of foundation and stored 20 lb. of syrup, whilst the healthy patches of brood and eggs show that the queen has not been idle. Commencing the spring with six stocks, my apiary has increased fourfold, and is now ready to face the winter in a sheltered position in the vale.—A CONSTANT READER, Cheltenham.

EXAMINATIONS FOR CERTIFICATES IN SCOTLAND.

[7650.] I often see reports in the B.B.J. of examinations for certificates being held in England for bee-keepers who are interested in the craft and anxious to hold a diploma. Now, bee-keepers in the North of Scotland find it a long and expensive journey to take before they can try an examination. Would it be possible to get a qualified person for the North of Scotland? If so, might I suggest your valued contributor "D. M. M." as local examiner, as I understand he would be capable, if willing, of undertaking the task?—A. Low, Aberdeen.

[If there is a demand for examinations in Scotland, no doubt the Council of the B.B.K.A. would arrange to appoint qualified examiners.—Ed.]

BEE-STING CURE FOR RHEUMATISM.

AN APPEAL TO BEE-KEEPERS.

[7651.] I am writing to you hoping you will be able to help me in obtaining some bees to use in trying to cure myself of rheumatism. I have been unable to work this last two years, and I am not in a position to pay for them. The doctor says it is the only thing left for me, as I have had all the drugs known for the complaint. I have tried bee-stings while the fine weather was in, and should like to give them a good trial.

Believe me, I should be very grateful if you or any of your readers could let me have a weekly supply.—WILLIAM ANSELL, 4, Malmesbury Road, Small Heath, Birmingham.

"WILKES" EXCLUDER.

[7652.] Would any reader of the B.B.J. who has used the "Wilkes" excluder during the past season be kind enough to give his experience of it as compared with the zinc excluder?—A. P., Sussex.

WHAT THE BEES THINK.

(See B.B.J., page 333, &c.)

Can anybody tell us why diseases of to-day Which troubled not our grandams, now their thousand-thousands slay? We're always taking nostrums, but we're only growing worse, And we're sick of being treated, so appeal to you in verse. Our sinking hearts misgive us as to where the treatment ends; Will anybody take our part and save us from our friends? There's phenyle, and there's naphthol b. and formic-aldehyde; There really isn't anything that someone hasn't tried. With salicylic acid they've "preserved" our little lives, Until the experts call to treat the poor long-suffering hives. They burn our combs and honey, with the brood and the disease, Then tie us up and starve us till they nearly kill the bees. They talk of disinfection, and they talk of final cure; They wash the hive with phenol till it most resembles sewer. They spray with coal-tar products, with all sorts of funny names, And curse their next-door neighbour, and consign him to the flames. They fire us out from hearth and home, and scorch it with a lamp, And leave a pan of quicklime to remove the after-damp. They dose us for paralysis, and doctor us for germs; We rather think that somebody once treated us for worms! We've looked for some protection to the menfolk of our kind, But it wasn't any use because they hadn't any mind: So we upped and fell upon them, and we killed the hapless drones, And they're resting in the chlorine which is whitening their bones. We've groped through noxious vapours, and we've breathed a horrid haze, Till we've almost been reminded of the good old sulphur days, When we built our comb all crooked, and a lot of it was drone; But we had this great advantage—that you left us quite alone.

L. S. CRAWSHAW.

AMERICAN AND COLONIAL PAPERS.

EXTRACTS AND COMMENTS.

By D. M. Macdonald, Banff.

Winter Stores.—Mr. Buehne, in the *Australian Bee-keeper*, rightly says that bee-keepers in the past have not attached sufficient importance to this subject, which has so much to do with the health

and well-being of the bee, and he instances honey from two trees, both late bloomers, which makes bad winter food. His conclusion is: "Their honey is unsuitable only when it comes late and under certain climatic conditions." He also draws attention to the fact that certain honeys in other countries are unhealthy as bee-food, and produce unfavourable wintering results. Even heather honey has been placed by some in this country in this category, but I deny the soft impeachment, unless some other factor comes in. There!

"*Jumping Frames.*" — Readers may benefit if I explain that this euphonious term is an equivalent of our phrase "spreading the brood." A leading American writer advised this operation in spring management. An Australian bee-keeper and writer in the *Bee-keeper* lamely criticises this advice, adding, "Others condemn it. Who is right?" Why, *both* are right, as every advanced bee-keeper should know: but there is a right and a wrong *time* to carry out the operation.

Foul Brood in Canada.—"More in sorrow than in anger" I revert to this unsavoury subject. Mr. Hurley has devoted a large part of several issues endeavouring to put an extinguisher on me and my plea for disinfecting hives, and, sad to say, he has been partially supported by two other editors. It appears to me that they are referring to something else—*some other disease than virulent foul brood*. In support of my original statement I will quote two or three leading Canadians. Mr. Holterman has put on record that frequently outbreaks follow the orthodox mode of cure, which was just my contention. Mr. McEvoy, in the August issue (page 294), writes: "My method of treatment is a *thorough cleansing process*, and where it is fully carried out will cure any apiary of any kind of disease." That phrase *thorough cleansing process* reads as if he had repeated my very words. Mr. Byer, in the *American Bee Journal*, reprinted in the *Canadian Bee Journal* (page 344), lets in some light on the subject, and proves the virulence of the disease I dealt with, and incidentally tears his editor's arguments to tatters. His words are: "Under this disease's insidious methods of attack we are almost entirely helpless. What we knew in the past is a mere bagatelle compared with this disease, which, while it yields temporarily, is *liable to break out again.*" Let me quote yet another authority of Mr. Hurley's—viz., Dr. White, of the Apicultural Bureau: "We shall expect that disinfectants will be much more readily effective."

Now let me deal with another phase of the subject. Mr. Hurley reprints a letter

written to our JOURNAL on "Disinfecting Hives," by Mr. S. P. Soal, and in a footnote he jubilantly exclaims: "Our British friends seem hopelessly at sea in the cure of foul brood." Now our system must be misunderstood by some on the other side, because it is even *more* drastic than the American or Canadian plan. It consists in a destruction of all internal fittings by fire in a bad case, plus a thorough *disinfecting* of the hive. For a milder case we advise shaking the bees off combs and restarting them, after a period in quarantine, on new works in a new or *clean* hive. We take no risks! Yet this Canadian editor claims, "We can teach the British how to cure foul brood"! I hope as he grows in years and experience he will take a broader and more cosmopolitan view of apiculture. I have no desire to say one word against Mr. McEvoy. He has worked strenuously for the good of Canadian apiculture, and I respectfully doff my cap to him. But (and Mr. Hurley's "spread-eagle" footnote leaves me no other alternative) *we* knew and practised this method of foul brood cure before the present editor of the *Canadian* was out of leading-strings as a bee-keeper, and even before the existence of the *Journal*, and yet *we* were not its originators. Shirach, a German bee-master about 1760, practised the "shaking" method as a cure, and wrote in favour of it. Again, turn to an American author writing in 1866, but of experiences extending back to 1836. At page 212 of Quinby's "Mysteries of Bee-keeping" will be found these words: "The only effectual remedy is to drive out the bees into an empty hive." He found to his loss that milder measures cost him dear. Again, Mr. Alexander is recommended as the author of the plan of dequeenning until a certain time has elapsed, although our Mr. Simmins has put in a prior claim. Let me supply the name of an earlier claimant. I quote the revered Dzierzon (page 274): "The queen must be kept caged until all the honey has been used up. To put a stop to the evil, immediately catch the queen as soon as the foul brood cells have been observed." New-old theories and plans should be sifted, and possibly if the foregoing facts had been known to Editor Hurley he might not have crowed so loudly. When Canada produces anything original really good I for one will gratefully acknowledge it.

As other American editors seem to have hazy notions about the British plan for curing foul brood, I would respectfully refer them to pages 180-181 of the latest edition of the "Guide Book," by Mr. T. W. Cowan. There he advises in a bad case to "burn bees, combs, frames, and quilts," plus a "thorough disinfection of the hive." In a milder case "make an artificial swarm, &c." What Canadian

system is better? As the editor of *Gleanings* says in the last number to hand: "Foul brood is too terrible a disease to take any chance with." Therefore we on this side disinfect hives and thoroughly cleanse them.

Drugs have been named in a condemnatory way. I never used a drug in any of my hives; but I believe in them, not as cures, but as preventives. That is why they are used in this country—not as cures, I repeat. It should be thoroughly impressed on bee-keepers that although there are two kinds of foul brood—a mild and a virulent (a fact known to Dzierzon nearly fifty years ago)—one should always guard against the worst. That is the sensible view taken by the Apicultural Department of Canada in a late circular.

WEATHER REPORT.

WESTBOURNE, SUSSEX.

September, 1909.

Rainfall, 3.57 in.	Minimum temperature, 38° on 2nd and 3rd.
Above average, 1.33 in.	Minimum on grass, 30° on 2nd and 3rd.
Heaviest fall, 1.25 in. on 28th.	Frosty nights, none.
Rain fell on 18 days.	Mean maximum, 60.1.
Sunshine, 148.8 hours.	Mean minimum, 48.6.
Below average, 27.4 hours.	Mean temperature, 54.3.
Brightest day, 3rd, 11.5 hours.	Below average, 1.5.
Sunless days, 4.	Maximum barometer, 30.239 on 3rd.
Maximum temperature, 68° on 6th, 12th, and 17th.	Minimum barometer, 29.713 on 7th.

L. B. BIRKETT.

SEPTEMBER RAINFALL.

Total fall, 3.25 in.
 Heaviest fall in 24 hours, 1.51 in. on 28th.
 Rain fell on 15 days.
 Above average, 1.55 in.
 W. HEAD, Brilley, Herefordshire.

Bee Show to Come.

November 11 and 12, at Exeter. — Devon B.K.A. Annual Show of Honey, Wax, and Appliances, &c. Open classes. Schedules of R. W. Furse, Hon. Sec., Woodbury. Entries close November 2.

Queries and Replies.

[3975.] *Death's-head Moth* (?).—On opening one of my hives last week I found under the ends of the frames a caterpillar about 2 in. to 2½ in. long and of a reddish colour. I believe on the underside it was a bright red. Its head was strongly marked with black. Would this be the caterpillar of the death's-head moth? If not, would you kindly tell me

what moth it would be related to?—
 F. W. DUKE, Woodford.

REPLY.—It is impossible to identify the caterpillar from the description which you give, but it cannot be that of the death's-head moth, which is the largest of all European caterpillars and attains 4½ in. in length. Its colour is lemon-yellow, which changes into green on the sides and belly. From the fourth to the tenth ring it is ornamented laterally with seven oblique bands of azure blue, tinted with violet and bordered with white on the side. The body is dotted with black, having at the extremity a yellow horn curved back like a hook and covered with tubercles. The head is green, and marked laterally with a black stripe. It lives on the potato, and buries itself in the earth, to change to a chestnut-brown chrysalis.

[3976.] *Curious Behaviour of Bees.*—

Having been a reader of your valuable paper the B.B.J. for some time, I shall esteem it a favour if you will kindly explain through its columns the conduct of a stock of bees in a very weak condition, after being united with driven bees to strengthen them. A friend of mine, like myself not very experienced in the craft, asked me to assist him in examining a stock which had been decreasing in numbers for some time past. I did so, and on opening brood-box I found it queenless, and the few remaining bees (about half a pint in all) in a very weak condition, so much so that numbers of them fell from the combs (which contained a small quantity of sealed honey) into the hive. I advised my friend to at once obtain a few pounds of driven bees and a fertile queen to unite with them, and in the meantime to feed the stock with warm syrup, which he did; but they were apparently too weak to come up to fetch it, for it remained untouched. In due course the driven bees arrived, and were at once united, following instructions given in "Guide Book" (page 107), and they appeared to unite peaceably together. Next day, however, I found numbers of bees (apparently from the weak stock) crawling about the ground and dead in front of hive. I watched for a time, and saw many crawl from the hive on to alighting-board and fall to the ground, appearing quite unable to fly. There seemed to be no fighting. What I would like to know is: Were the superior strength and energy of the driven bees too much for the weak stock, causing them to drop from the combs, crawl out of the hive, and then fall exhausted to the ground?—F. B. MITCHAM.

REPLY.—It is evident that the few bees remaining in the queenless colony were weak, and most likely old also, as brood-rearing must have ceased a long time for

the colony to have become so depopulated. Such bees were really not worth the trouble of uniting with the strong and vigorous driven bees. It was probably only a question of a few days' existence for the weak lot, and the energy and bustle of the driven bees no doubt hastened their departure from the hive, as weak or sickly bees generally leave their hive to die.

Notices to Correspondents.

MEDICO (Nottingham).—Treating Colony Affected with Foul Brood.—The comb is affected with foul brood. 1. It is too late now to treat the colony, and your best plan is to give the bees candy, as there seems to be a shortage of stores, and leave the treatment until the spring. 2. You had better remove all the diseased combs and allow the bees to winter on three or four of the best. You will then be able to keep your golden queen until spring, when you can utilise her elsewhere. You could not very well keep her caged all the winter. 3. The treatment can be commenced early in spring, following the instructions on page 180 of "Guide Book." 4. The wax is dark, but could be refined in the manner described on page 83 of "Wax Craft."

C. R. P. SLEIGHTS (Whitby).—Naphtha in Syrup.—If mineral naphtha has been used by mistake instead of naphthol beta, it is quite likely to have an injurious effect on the bees if they take it, and the syrup containing it should not be given them. Feeding with syrup should be discontinued now, and if the bees are short of stores supply them with candy.

F. R. C. (Calverley).—Queen Turned Out.—Microscopic examination shows the spermatheca to be perfectly clear, consequently the queen was not fertilised.

S. F. R. (Truro).—Bees Refusing Syrup.—1. Your colonies are either weak or the syrup is too cold for the bees to take it freely. In the autumn only thick warm syrup should be given (see "Guide Book," page 112). 2. and 3. If there are insufficient stores you should now give only candy. 4. Each colony should have about 30 lb. of stores to pass the winter safely. 5. No; impure naphthol beta will not do at all. You had better get a packet of the pure, and mix it yourself according to directions in "Guide Book" (page 194). 6. Thick twilled calico, as recommended on page 110. Such a feeder, however, is not suited for autumn feeding, as the syrup in so small a bottle gets cold too soon.

J. E. F. (Co. Galway).—Name of Insect.—The insect you send is often mistaken

for a bee, but is a fly belonging to the order *Diptera*.

A. B. (Yorks).—Objection to Bees.—1. Bees do not disfigure either flowers or fruit by their excrements. We have our hives right in the midst of trees and shrubs, and have never found them affected in any way. 2. When "honey-dew" is prevalent bees do not spread blight to unaffected trees by contact. Your friend evidently does not understand the nature of honey-dew, or he would not make so absurd a complaint. 3. Nor do bees tear flowers to pieces, and the only way they are likely to reduce the market value of flowers is by fertilising them. When they have become fertilised the object of the blossom has been accomplished, the flower fades, and the petals drop. This fading takes place sooner in fertilised flowers than in those not fertilised. However, if fertilisation did not take place seed could not be produced, from which only it is possible to obtain new varieties.

J. W. D. (Fareham).—Drones Late in the Season.—1. The drones were probably retained longer than usual for the purpose of fertilising the queen, and, this being accomplished, they are no longer needed, and are being driven out. 2. Sections with foundation in them can be stored in a dry, warm place, and should be fit for use next season. 3. You will find full directions for preparing bees for winter on pages 190-192 of "Guide Book," to which please refer.

G. B. (Tring).—Re-queening Late in the Season.—When queens are introduced so late in the season, very frequently they do not lay for some time. As you know that the queen was successfully introduced, and you found no eggs seven days afterwards, it is no reason for supposing that she has been destroyed. Leave the bees alone now, and look for eggs in the spring.

Suspected Combs.

A. C. (Aviemore).—The specimen of comb is affected with foul brood, and as the stock is so weak it is almost certain that the bees will succumb during the winter. It will be the safest plan to destroy bees, combs, frames, and quilts, and thoroughly disinfect the hive.

Honey Samples.

Boy (Birmingham).—Honey is of inferior quality, gathered from mixed sources.

G. H. (Camden).—Sample is fairly good in flavour, its chief fault being the dark colour. It probably contains a small admixture of honey-dew, but not sufficient to spoil the flavour. Granulation has evidently improved it.

S. WELLARD (Grays).—Sample must have been lost in post, as we have not received it.

Editorial, Notices, &c.

BRITISH BEE-KEEPERS' ASSOCIATION

CONVERSAZIONE.

(Continued from page 424.)

Mr. Reid thought it was rather difficult to discuss the subject, since so little was yet known about it. No doubt the disease was an extremely serious one. They knew what had happened in the Isle of Wight, and he had had occasion to observe cases of the kind only two or three miles from where he lived. The bees came out in thousands on a very fine day, and seemed to be unable to fly. They fell upon the grass, but were too weak to rise again. They then clustered together and died during the night. When examined it was found that their bodies were distended, and contained the refuse from pollen-grains. The most unfortunate fact was that no remedy was known, while the mortality was greater than resulted from foul brood. A whole apiary would die out speedily; therefore on the slightest indication it was important to try some palliative. Before a cure could be found they must know the cause of the disease, and in Mr. Cowan's remarks it appeared that a valuable discovery had been made in that direction. He thought it was necessary without any delay to commence careful scientific experiments for the purpose of devising a cure. Apparently the materials and substances used for foul brood did not act in this case. In Switzerland some authorities advocated feeding, on the ground that if the bees were fed up they would be strengthened to resist the attacks of the disease. Then a German observer had found good effects ensue from giving the bees Glauber salts. These were suggestions merely, and were, of course, empirical, not being based on scientific knowledge. It was quite possible, on the principle of setting a thief to catch a thief, that experiments might reveal other bacilli which would overcome and neutralise the bacillus which was causing all the trouble. Great publicity had recently been given to the organism of massol, advocated by Metschnikoff as a specific to ensure longevity. That might be a very useful organism; it was said to produce lactic fermentation in milk, and if it could be transferred to the honey on which the bees were fed the benignant organisms might overcome the malignant bacillus. To ensure success it would be necessary to isolate the queen and cause her to be fed with a culture of the friendly bacillus. One point was: Were the eggs tested to find out whether they were free from the organism? [The Chairman intimated that the disease had

only been discovered in adult bees.] The question in his (Mr. Reid's) mind was whether, by the isolation of the eggs and discovery of which were free from the germs of the disease, and the elimination of them from the hive, it might be possible to eradicate the evil. Only by the use of pure eggs was it possible to get rid of the disastrous scourge which broke out among silkworms, and he thought it important that the eggs should be examined, because it was clear that if the queen were thoroughly infected the eggs were not likely to be free from taint. It would be quite useless to breed from such a queen, but if she could be cured, and the bees be put on fresh combs, there might be a chance for the hive. Some of the affected bees did survive in the Isle of Wight, and if in any apiary afflicted with the malady a stock should survive, it would be a good plan to breed from that stock, the offspring of which bade fair to be immune, for it was no good buying new swarms, getting them inoculated, and letting them die off. At any rate, there was much more likelihood of immunity in stocks bred from those bees which had survived than there would be in the importation of fresh bees from a new neighbourhood. In the apiaries of Northern Italy foul brood was endemic, but plenty of honey was produced, and although the plague flourished the bees seemed none the worse for it; while if a queen was brought to this country the scourge seemed to find suitable soil, and developed accordingly. He believed bees might in time become so accustomed to this disease that it would gradually lose in intensity. At all events, he could not but think there was some hope of fighting the malady on rational lines, and he merely offered suggestions for combating this disease, of which they knew so little.

Mr. E. Walker said his bees had suffered badly from the disease. This year he had lost twenty stocks, so he was entitled to say he had had a little experience. He could also claim to have cured a stock in spite of the bees all round being infected. A gardener brought six or eight stocks into the district, and so far these bees had remained perfectly healthy, while his (Mr. Walker's) and all his neighbours' bees were infected, some so badly that they were not allowed to die out, but, there being no hope, were destroyed. He had experimented with a cast, probably from the gardener's bees, and tried to give it the disease. After resisting it for some time, the bees finally took it in a mild form. About four combs of bees gradually dwindled to two and a half. They were simply fed with syrup. Naphthol beta was given in ordinary proportions, also syrup without any naphthol beta. Either did equally well. He had

great hopes that feeding would bring about a cure in the infected districts. He knew another apiary in which the disease broke out in every stock but one. The bee-keeper believed in feeding, and kept on feeding all through the summer every stock save the one in question, but the bees gradually dwindled. He re-queened most of the hives, and when he (Mr. Walker) saw him at the Dairy Show he reported that every stock had recovered, and the one that did not contract the disease had given a good surplus. So that, as all stocks did not catch it, there was hope of breeding it out of the bees, and he thought that might be done eventually. At all events, the right thing to do was to feed the adult bees. The grubs did not contract the evil, and his opinion was that the bees did not do so until they began to take raw honey. He had found drones, which probably had never flown before, on the ground in their first attempted flight. The cause of the plague had been attributed to starvation, which in certain cases was more or less true, for the adult bees gradually died off; they left the hive, and were not able to return. Consequently, as the stores became exhausted the remainder of the bees died. Very often stocks would die out even with plenty of food in the hive. One important thing to do was to keep up the population of young bees, so that there were continual relays of them, and trust to their vitality overcoming the disease.

Miss Lamothe said her own apiary was situated within three miles of a very decided case, which broke out this summer. She took certain preventive measures, and her bees had not so far been attacked. She thought if everybody who had suffered by the disease, or had even used preventive measures of any kind with apparent success, whether verified or not, would give the meeting the benefit of their experience, some good would be attained by making it known. Everybody naturally wished to cure rather than have to kill the bees, which had had to be done on a large scale at Winchfield (fifteen miles from her residence). A week before the stocks became attacked the bees had sent off an enormous swarm. For a fortnight the bee-keeper hoped they might survive, but he found hardly any bees left in the six hives, and they were then destroyed. Directly she discovered the Isle of Wight disease in close proximity to her hives she caused to be sprayed in the latter a 10 per cent. solution of formalin. That may have had something to do with her immunity from attack. Last season was a bad one as regards weather. She did not take the supers off, but used a syringe, spraying in different directions, and puffing in smoke in case there was any

danger of the queen being on the bottom combs. At Winchfield a good many stocks in the immediate neighbourhood of the affected ones were treated in a similar way, and a few escaped altogether. Some supposed that the disease could be overcome by feeding, but one hive that was destroyed had a full super of sealed sections just previous to the outbreak. Yet that stock developed it to such an extent that it had to be destroyed immediately. There were 17 lb. of good ripened honey there; and so the feeding suggested seemed to be a little puzzling.

Mr. Lamb said that an eminent bacteriologist who had examined the dead bees afflicted with the disease was not able to isolate the bacillus that caused the evil.

Mr. Salmon said he was asked to go to see a stock of bees which had been condemned by the Board of Agriculture as suffering from the disease. This was a week after the report, and he found the brood healthy, the stock a fairly strong one, and the hive containing some unsealed honey. Apparently there was nothing the matter with the bees. The explanation was that about ten days before there had been some very cool weather, and the bees had fought because the honey was taken. He found many lying on the ground—chilled no doubt. They appeared to be in a paralysed state, but there were no symptoms of disease. He believed this stock was now going on satisfactorily. He was of opinion that many cases were exaggerated, and some were not due to the disease at all. At Lord Stradbroke's, where he was a month ago, the gardener told him that when the bees visited the silver lime and had gorged themselves with nectar they seemed intoxicated, and dropped from the tree on the ground, and never got back to the hive. The phenomenon had occurred this year, but never before to the gardener's knowledge. Mr. Elwes, the authority on trees, could not account for the action of the bees. It was a most interesting case, and he thought probably due to some of the toxins formed in the plant owing to rain. He had not come across any other cases attributed to the Isle of Wight disease. He hoped for some light shortly on this matter, and it seemed to him desirable, in the absence of any definite remedy, to medicate syrup and use formalin tablets. It was certain that where the food was always medicated the bees were in a much more thriving and healthy condition than otherwise.

Mr. Richards said there appeared to be two diseases, the May and the Isle of Wight disease. He did not quite understand whether they were identical or not. Certain remedies had been mentioned, and,

although not cures, they would be very useful in tackling the disease where it was found, and the best way apparently from the knowledge gained up to the present time. If the adult bees declined in numbers, obviously there was not sufficient population to keep up the heat, and it was essential that the fresh healthy bees should be fed as rapidly as possible. But they could not ignore the evidence which showed that bees had died in spite of the fact that there was a lot of honey in the hive. It might be that artificial feeding with warm syrup when the population was low would keep the hive up where feeding with ordinary honey would not have the same effect. He was resolved, if his own bees were attacked, to spray them with formalin or some other germicide, and feed them with warm syrup. Undoubtedly the best thing to do now was to experiment for a remedy.

Mr. Tinsley understood Mr. Reid to aver that foul brood was more contagious abroad than in England. If so, bee-keepers were promoting contamination by introducing foreign queens from Northern Italy.

Mr. Reid replied that the disease was so prevalent in Northern Italy that bee-keepers took no notice of it. It was no doubt milder there than here, because the bees were able to put up with it and live and produce honey.

Mr. Richards said that if the introduction of foreign queens into this country was likely to promote a disease which would develop more strongly in England than in Italy, it was a question whether the B.B.K.A. should not warn bee-keepers against the importation of them.

Mr. Tinsley said that out of 20,000 colonies he had inspected, not one colony headed by a foreign queen was found diseased. He did not think it was possible to find a pure strain, but the black bee was very different in different localities. Climate and conditions of vegetation no doubt operated for or against the development of disease. As a body of educationists discussing a serious matter, he thought they ought to try to confine their remarks to the subject at issue. They needed scientific opinion, the result of observation, inquiry, and experiment in this matter, and he would be grateful to hear the views of the Chairman.

Mr. Frusher lived in a locality where foul brood first appeared in 1900, when no steps were taken to combat it. It reappeared in June every year. The owner of the hives whose bees were attacked thought the matter had better be kept secret, but he (the speaker) was going to stir it up, which he believed would be the best way to set about getting rid of it.

He lived within 150 yards of the man whose stocks were thus affected.

Mr. Salmon thought that Mr. Tinsley could not have been in districts that he had visited, or he would have known that stocks headed by foreign queens often contracted the disease.

Mr. Reid said, with reference to the remarks of a previous speaker, that he was sure the members were glad to hear the views and experiences of anybody present, whether scientific or not. He thought Mr. Walker had made an extremely valuable contribution to the debate. Observations might not be immediately useful, but there was always something to gain from the experiences of others. Records of failures even were interesting, because they helped to prevent failures in future. Besides, this was a conversazione, and therefore an opportunity for a general interchange of opinion, especially of young bee-keepers, who perhaps needed the assistance of their more expert brethren. Of course, other meetings were held where apicultural matters were dealt with in a more scientific way. With regard to the observation of greater mortality from bee-paralysis during certain days this might be explained by the fact that the bees during cold weather were confined to the hive, then on the first sunny day they all came out together, fell to the ground (being unable to fly), clustered together, and died in the night from exposure. As to mongrels, he was afraid the British bee was of a somewhat mixed breed, but that would right itself in time, and, according to the Mendelian theory, the stock would go back to the original. If foreign queens, which brought over so much disease and crossed all their stocks, were to be excluded, the latter would revert to the original British breed in the course of a number of generations. It was a difficult matter to say whether they ought to prevent the importation of foreign bees. The Board of Agriculture might be asked to allow only those bees to enter which had been subjected to quarantine. At the Cape nothing was allowed to be imported except under the strictest conditions. The United States Board of Agriculture were most careful in their regulations to prevent the chance of conveying disease into that country. England always moved slowly in these matters, but he hoped in time she would follow the example of other countries.

The Chairman desired to reiterate the fact that the disease in question was not a disease of the brood at all, but a malady of the bees themselves. According to Dr. Zander, the chyle stomach was attacked, and became disintegrated, and, as it was impossible to provide a new stomach, the

bees died. He (Mr. Cowan) was very pleased to hear what Mr. Walker said with regard to curing even one stock by feeding. That entirely corroborated Dr. Zander's statement that it was possible to cure stocks, though not individual bees. As to formalin, which Miss Lamothe had tried, it was no doubt useful in a hive, but whether it would have the slightest effect on the bees actually diseased he did not know, but thought not. The affection was not a vegetable parasite, but an animal one, which required a much stronger disinfectant to destroy it, and if effective would also kill the bees. Mention had been made about the importation of foul brood with foreign bees. Many years had passed since it was first imported, and he was afraid it now had firm hold in the country, although not necessarily every queen brought over was diseased. In his own case it was entirely through bringing Italian bees into his apiary that foul brood broke out, because prior to that his hives were entirely free from it. He had queens direct from Italy, and foul brood started in the hives to which the queens were introduced. Not every imported queen brings the disease, but it must not be supposed because disease was not found amongst imported bees now that it had never been imported. In some parts of Italy the complaint was endemic and existed in a mild form. He thanked all present for the reception that had been accorded him, for the way in which the subject had been discussed, and for the information forthcoming respecting it. It was necessary for them to take observations of every phase of the case, and remember all that had been heard that evening and act upon it. Of course a great deal more had been said than bore strictly upon the matter, and many cases had no doubt been attributed to the Isle of Wight disease which were not connected with it at all, and at that late hour he would not deal with them. He was not in the least afraid that they would be unable to stamp out the disease or eradicate it altogether in the course of time. It was a matter of time; all new diseases required investigation and study before their nature could be properly diagnosed, which was the necessary preliminary to finding a remedy. Just as they had discovered how to deal with foul brood, so, he believed, would an antidote to the other diseases be found out.

On the motion of Mr. Reid (who acknowledged the indebtedness of all bee-keepers to Mr. Cowan for his able assistance rendered to them at various times), seconded by Mr. Bevan, a hearty vote of thanks was accorded the Chair-

man for the important contributions he had furnished that evening.

The Chairman, in reply, said he always felt it a pleasure to be among bee-keepers, and it was especially so that night when so large a company, all keenly interested in apiculture, had assembled. His gratification was the greater at seeing so many ladies among the audience. He had been asked to bring the subject before the meeting, and as the report of Dr. Zander's work had only just been published, the matter was quite new. He (Mr. Cowan) would be pleased to write to the Doctor and tell him how cordially they had received the communication he (the Chairman) had made.

(Concluded next week.)

HOMES OF THE HONEY-BEE.

THE APIARIES OF OUR READERS.

Mr. H. L. Attridge, whose home-apiary we reproduce, may be called *the* pioneer, or at any rate one of the earliest pioneers, of modern bee-keeping in South Africa.

His early instruction in bee-culture was acquired in England, his father being a friend of the late Mr. Chas. N. Abbott and fellow pupil in bee-keeping under the late Dr. Coster, an advanced and enthusiastic bee-keeper of that time. Mr. Attridge's apiary was favourably situated a few miles to the west of London amongst market gardens, orchards, and meadows abounding with clover, and, notwithstanding the inroads of foul brood again and again, very good results were obtained.

On arriving in South Africa some twenty years ago, the subject of these notes commenced the study of the South African bee, making known the results of his investigations in the agricultural papers of that country, and endeavouring by different means to stimulate an interest in the subject and induce others to take up the pursuit on modern lines. Honey was easily obtained from wild bees domiciled in trees, rocks, &c. Very little attention had previously been paid to domestication. Where this had been done, packing-cases, tar-barrels, oil-cases, &c., were the usual hives adopted; but the knowledge of bee-life was of the most rudimentary character, two of the common errors of the time being that queens were called kings, and drones were known as "water-carriers." Dr. Stroud, of Port Elizabeth, who in 1884 published his book on the honey-bee, was endeavouring to put forward the scientific side of bee-life at that time, and exported a few South African queens for trial in England.

Colonial bee-keepers were fairly humane in their treatment of bees, simply smoking them back to one end of the packing-case or other hive while removing the honey. Of course, queen-excluder zinc being unknown as yet, a quantity of brood was removed with the honey. The brood was not destroyed, but looked upon as a choice morsel by the coloured assistant and much appreciated.

About 1890 Mr. H. L. Attridge brought out his first little pamphlet, entitled "South African Bees and their Practical Management in Movable-Comb Hives," which had a large circulation and gave quite an impetus to modern methods. He also introduced demonstrations and lectures at agricultural shows, commencing with an observatory-hive and later giving

diseases obtaining an entrance to South Africa, and it is satisfactory to know that stringent laws are now in force to prohibit or regulate the importation of foreign bees, honey, and beeswax, including comb-foundation and second-hand appliances. The Department of Agriculture for the Cape Colony have recently issued a book on "South African Bee-keeping," written by Mr. Attridge, which is now being circulated in the English and Dutch languages. We drew attention to this book a short time since, and the notice will be found on page 232.

The apiary illustrated is situated about thirteen and three-quarter miles from Cape Town on the main line (Cape to Cairo). Table Mountain can be seen in the distance.



HOME-APIARY OF MR. H. L. ATTRIDGE, STIKLAND SIDING, CAPE COLONY.

practical manipulations with live bees in a bee-tent, which has now become a recognised feature at the larger shows. The Colonial Government, also recognising the importance of the subject, appointed Mr. Attridge Lecturer on Apiculture at the agricultural colleges, thus further assisting in the dissemination of useful knowledge, many of the agricultural students of that time now being successful bee-keepers in different parts of South Africa.

Of recent years bee-keeping has made good progress; there is now a South African B.K.A., which Mr. Attridge hopes to see shortly affiliated to the B.B.K.A.

Mr. Attridge, with others, has worked hard to prevent foul brood and other bee-

Correspondence.

The Editor does not hold himself responsible for the opinions expressed by correspondents. No notice will be taken of anonymous communications, and correspondents are requested to write on one side of the paper only and give their real names and addresses, not necessarily for publication, but as a guarantee of good faith. Illustrations should be drawn on separate pieces of paper. We do not undertake to return rejected communications.

AMONG THE BEES.

HONEY-DEW.

[7653.] This *bête noire* of bee-keepers has been very prevalent in this country, on the Continent, and in America during the past honey season, and many an enthusiastic bee-keeper has had reason to curse its presence, while others may have still further

cause to rue its contaminating influence before next season opens. Assuredly, manifesting itself in quantity in any hive will not tend to successful wintering. Not that all honey-dew is so very bad, for there are at least two kinds of it, differing considerably in composition. One is a saccharine juice, which exudes under certain climatic conditions from the leaves of various trees, amongst them being oak, chestnut, lime, beech, ash, conifers, and fruit trees. Now, as is well known, there visits these "sweating" leaves an aphid which feeds greedily on this sweet substance. It, like the bee, has something in the nature of a honey sac, quite separate from its ordinary stomach, from which, when the sac gets overcharged, it regurgitates, or rejects, "aphidian honey" by means of two tubes used for *no other* purpose, fortunately for the bees and their keepers. In itself this fluid, which is a secretion, *not* an excretion, would not be wholly unpalatable. It looks like a bright sparkling clear drop of liquid when held up against the light, and tastes by no means harsh. But, unfortunately, a soot fungus grows on the leaves, making them appear as if they had been coated with this substance. To the sorrow of the bee-keeper and to his serious loss, this gives a black inky appearance to the saccharine matter when it is gathered and consigned to the cells, and when extracted it looks dark and muddy, sometimes resembling in colour blacking or coal tar. Much of it in the admixture thoroughly injures the sale of the honey, and even a little of it goes far to deteriorate the quality and flavour.

The following method may be used to test the amount of real honey and the proportion of honey-dew: Place a large spoonful of slaked lime in about two pints of water, and stir the compound thoroughly. Allow the lime to settle at the bottom, and then pour off the clear liquid into another bottle. Place a teaspoonful of the inky honey into a tumbler nearly full of this lime-water, and give it a good shaking or stir it smartly. If the mixture remains clear you have pure honey: if partly cloudy you have a small mixture of honey-dew; but if it turns very muddy it is largely contaminated.

The eye at once detects its presence, however, as the honey assumes a muddy, cloudy, dark appearance unknown in flower nectar. The sense of taste aids the eye, and to the initiated not only clearly proves that it is present, but pretty well gauges its proportion. Aiding these two senses comes that of smell. The odour of honey-dew is something apart from that of any true nectar secreted by *Flora's* offspring.

The very worst type should be sold to the blacking manufacturers, or it might be used as a lubricant. Large quantities of

inferior honey are annually purchased by biscuit manufacturers, and honey-dew can, if not too strongly flavoured, be substituted if sold as such. For those who have a trade in low-grade honey a blend of honey and honey-dew will sell easily under a suitable name at a low price. Foreigners and a certain class in great parts of our larger cities would not object to the pronounced flavour if they got it cheap. A blend, if honey-dew is not in the ascendant, might be allowed to granulate, and can then be sold cheaply in this form as honey-dew honey. If there is only a slight colouring many would purchase at a small figure if the home market is worked up. Those having a large quantity much contaminated should preserve it carefully till spring, and feed with a view to stimulating. For turning into bees it is as good as the very best and choicest grade on the market. Another use to which I wonder somebody has not advised it should be put is to draw out new combs. With a glut from honey-dew a large number of combs could be built in a few days. Honey-dew is a saccharine substance, but it contains a residue. This latter the bees would carefully eliminate in changing the liquid into a solid, so that the combs would be perfectly sweet and clean. It is possible, however, that they might be of a darker shade, or assume something of a green tinge. With a heavy flow on from this source, remove regular shallow-frame bodies, and replace them by full-depth frames fitted with full sheets of foundation, and they are drawn out as if by magic. It is not generally known, but it is a fact all the same, that far more perfect combs are constructed in surplus-chambers than can be obtained in the regular body-box, and with a heavy flow and a full force of bees they can be got flat as a board.

This has been an uncommonly bad season for honey-dew, and an undue proportion of the little genuine honey gathered has been spoilt by the admixture. Fortunately, the plague in its worst form is not of frequent occurrence. The year 1907 was bad, 1898 was worse, but these are the only really bad seasons, I think, for over twenty years. Dr. Miller records that he had only one vile year in forty-eight. Mr. Carr, in 1898, described that season as the only really bad one he had experienced in over twenty-five years, and for over twenty years I have never had its presence made offensively manifest. Ancient writers set a higher value on honey-dew than we do, and Pliny called it the spittle of the stars, while others called it a dew from heaven. I should like to impress on readers that, although it is frequently associated with the presence of aphides, cocci, &c., they are a result of it, and not it of them; and, further, I would desire to emphasise as a fact that the "aphidian" honey is not an

excretion, but simply an exudation from the leaves, or an ejection from "honey sacs" by peculiar organs of these insect pests, and that the black inky shade is due to the mould, or fungus, and not to the insect or the "dew."—D.M.M., Banff.

THE B.B.K.A. AND ITS SECRETARY.

[7654.] Many readers of the JOURNAL will note with regret the retirement of Mr. Young from the secretaryship of the B.B.K.A., especially under the circumstances. Let us hope that his recovery from his illness may not be far distant.

An item of interest gleaned from the report of the last Council meeting is that Mr. W. Herrod has been appointed secretary *pro tem.* A secretary so energetic and so well qualified for the post will be a most able substitute, and now that we have lost Mr. Carr, and temporarily Mr. Young, the present secretary is, among the officials of the B.B.K.A., the only familiar figure to Northern bee-keepers. Mr. W. Herrod, I know, has a warm feeling for the North Country and its bee-keepers. His ready sympathy and his firm grasp of all the details of our craft, whether it be in the show, the bee-tent, at meetings of bee-men, or as a travelling expert, are well known, and no doubt he will be quite at home in the important office he is now called upon to fill. Much has been said and written of late about the position of the B.B.K.A., and the last contribution to the subject in the JOURNAL (page 424, 7644) (unfortunately from the pen of an unknown writer so far as readers are concerned) seems to suggest that this is partly due to a lax attendance to his duties by the secretary, and attributes the present position of the parent society to the fact of its having "lost touch with the affiliated associations." This is not quite borne out by hard facts, as I find, on referring to the annual reports for the last ten years, that in 1901 fourteen associations paid their affiliation fee, in 1904 twenty-seven paid, and in 1908 twenty-five paid. How then does your correspondent come to the conclusion that the present position of the B.B.K.A. is attributable to any falling-off by the county associations?—G. W. AVERY, Hon. Sec. Cumberland B.K.A.

[7655.] I regret to see from B.B.J. of October 21 that Mr. Young is still ill and unable to fulfil his duties of secretary to the B.B.K.A., and that steps have had to be taken to fill his place. I am pleased that the Council have chosen Mr. Wm. Herrod as secretary *pro tem.*, and I think the choice could not have fallen upon anyone better able to fulfil the duties attached to the position. Since 1895 I have watched his

career. When in our county as expert that year and the following, I was brought constantly in contact with him in my official capacity. His readiness to help, the pains he took with members, and his promptness in dealing with his clerical work both then and since convince me that he is the right man in the right place. I sincerely trust, and many of our members with me, that, if a vacancy occurs, the appointment will be made permanent.—FREDERICK H. TAYLOR, Hon. Treasurer Lancs B.K.A.

[7656.] It is with pleasure I note in B.B.J. of October 21 the appointment of Mr. W. Herrod as secretary *pro tem.* of the B.B.K.A. From a wretched experience of this department in the past, I welcome the transfer of the work to one whom I have always found most capable.—J. H. HADFIELD, Hon. Sec. Lincs B.K.A.

CURRENT TOPICS.

[7657.] *Brace-combs Attached to Separators.*—Two reasons are generally given as the cause of these—namely, that the lives are out of level or that the remains of old brace-combs have not been removed. Now, while I do not intend to deny that both these defects, and especially the last-named, may possibly operate in the way indicated, all will agree that they are well within the power of every bee-keeper to prevent. But what I wish to point out is that brace-combs occasionally occur when neither of these defects is present. To what, then, are they due? I venture the opinion that they are in most cases mere freaks of comb-building for which no reasonable cause can be assigned, and, further, that they are produced by small independent or semi-independent clusters of bees which are often at work building these secondary combs at the same time that the main cluster is "drawing out" the foundation; for these brace-combs often encroach considerably on the space which should have been occupied by the main comb, their midrib is generally at right angles to the latter, and they are sometimes quite detached from it, leaving a bee-way between.

Comments (page 415). — "These," "D. M. M." says, "when they secure any correction, emendation, explanation, or elucidation are to be welcomed," and I am sure that all will endorse this sentiment: but what if the writer of the things commented upon refuses to be corrected or emended, and, to elude this emendation, contradicts his own words! Thus, on page 254 he says, referring to a new scraper, "It is simply a small garden draw-hoe with a perfectly straight edge."

This is sufficiently explicit, but on page 303 he places the matter of the single edge beyond all doubt by referring to the same tool as "the single-faced ["edged," I presume, is meant] one I this year found so convenient," and yet on page 415 he asks: "Why should not my hive tool have three edges as well as Mr. Soal's triangular one? It has"!

"D. M. M." has tilted at several more of my "windmills," but so far from "tilting" them over he has not even flicked the dust from the walls.

Cone-escapes (pages 374, 415, and 418).—"None of these ordinary short cones are effective" (Soal). "They are a delusion and a snare" (Crawshaw). "My cone-escapes are admirable appliances and perfectly efficient" ("D. M. M."). In face of dogmatic and conflicting statements like these, what can one do but offer readers the well-known showman's advice: "Pay your money and take your choice"! Nevertheless, the facts I have given (see 7607, page 374) in regard to these cones I vouch for as absolutely correct. Repeatedly have I seen wasps fly straight to the mouth of the cone and enter "as if to the manner born." But I am inclined to think that in all probability "D. M. M." will not be troubled with one-tenth the number of wasps that plague us here in the South. Has he ever experienced, for instance, anything at all approaching the overwhelming plague of these insects recorded by Mr. B. J. Mitchell on page 416? Brace-combs (page 416) not only "should be" formed on bottoms of sections in "well-made racks," but, were it not for Mrs. Tupper's well-known axiom, it would be scarcely too much to say that they are always so formed in cases where racks are placed in direct contact with the frames and filled in that position.

"A *Queen-excluder* is a *Honey-excluder*."—Let us examine this statement a little. It is generally conceded, even by those who dispense with excluders under sections, that their use is desirable when working for extracted honey. Now why should it be more difficult for a loaded bee to pass through excluder-zinc when taking a load up into sectional supers than when conveying a similar load to extracting-boxes? Is not the difficulty of the passage, and consequent "exclusion" of the honey (if any), precisely the same in both cases? Whatever hindrance excluders may be to the bees in passing to and fro—and it is only reasonable to suppose that they are some hindrance—the fact remains that vast quantities of honey have been, and will again be, stored through them. Perhaps I may be allowed to cite a personal experience as bearing on this question. My

present location must be classed as only a very "moderate" one. Few fruit-trees, still fewer limes, no sainfoin, no heather, only an occasional field of sown white clover or mustard (and these sometimes more than a mile away), entail conditions which make any record-breaking in honey-production quite out of the question. Yet some six years ago more than one of my stocks yielded between 130 lb. and 140 lb. of extracted honey (from sealed combs for the most part), every drop of which was taken through excluder-zinc. I had "purchased" swarms the same season, which gave three to four racks of sections each, also stored through excluders. Would that I might have a "honey-exclusion" like this every year, and I would gladly put excluders between every rack if by so doing I could ensure a similar harvest!—SAML. P. SOAL, The Old Rectory, Rochford, Essex.

THE W. B. CARR MEMORIAL FUND.

[7658.] I notice with regret that the above fund has not yet reached £60, and falls far short of the £100 hoped for by the promoters. Probably some intending donors are waiting to see to what use the money is to be put; but they may rest assured that the Council of the B.B.K.A. will use it to benefit bee-keepers in such a manner as would have met with the approval of the late Mr. Broughton Carr. The fund should have been closed on October 31, but I am sure there are many who would like to be included, though they have overlooked the notice in the B.B.J. May I make a further appeal, and ask them to send their contributions without delay, so that the fund may reach as high a figure as possible? I shall be open to receive sums up to the next Council meeting on November 18. All contributions are welcome, whether large or small.—W. HERRON, Acting Sec. B.B.K.A., 8, Henrietta Street, Covent Garden.

BEE-KEEPING IN SOUTH AFRICA.

[7659.] In answer to inquiries by two correspondents in the B.B.J. about bee-keeping in South Africa, I may say that there are practically no large apiaries here capable of employing a man as assistant. Bee-keeping is only just merging from a hobby into something more serious.—J. L. TAYLOR, Pretoria.

CAPPINGS OF COMB.

BY L. S. CRAWSHAW, NORTON, MALTON.

What is a Strain? (page 395).—Mr. Soal airily propounds this stressful conundrum, but he cannot have read this column lately, or he would certainly have come across a few answers to his ques-

tion! In fact, I can hardly imagine its perusal at all *without* one!

Twice Mating (page 396).—Careful observation like this will go a long way towards solving our questioning on this subject. A tiny nucleus-hive made up of a glazed section is an admirable observatory, for it does not block the outward vision, and the quarters are so limited that either side may be quickly seen. The movements of the flying bees can be well seen from behind a window, and the person of the observer is not a disturbing element. Will "Humble Bee" kindly say if the sun was allowed to shine on this nucleus, and whether the queen was confined to the hive when unobserved? I think that a good many observations of this kind are needed to establish multiple fertilisation. For it is quite conceivable that a first mating might for some reason be abortive, in spite of the evidences. It has been claimed that fertile queens have mated again—that is, subsequent to having laid female eggs; but properly attested evidence of this is extremely difficult to obtain in that the occasion cannot very well be anticipated.

Life of Calico Roofs (page 406).—I see no reason why these should not last a lifetime with an occasional coat of paint. They do not do so well under the drip of trees, but perhaps it is not fair to any hive to place it in such a position.

He, She, or It (page 406).—Mr. Woodley settles the sex of the wasp in somewhat the same fashion that we used to speak, as children, of the sun and the moon as the father and mother of the stars! That was in the bygone and regardless days when the dog was a "he" and the cat was a "she," whatever their own opinion. Dogma, or catma, was good enough for us then, however empirical. "It is, I know it is, mother says it is, and if mother says it is, it is, whether it is or not!" Just why the worker-wasp is a he is not so clear, unless it be that his heart is desperately wicked. Thus he is *male*, or evil; hence, being evil, he must be a male! Militant Suffragettes will please note.

Swarms versus Stocks (page 407).—Mr. Soal seems to have a good many sweeping statements here. Thus, "swarms never are the equal in strength of good average stocks." There you are, verbatim. But what is a good average stock? If he would not mind expressing it in pounds of bees, potential and actual, we shall no doubt be able to find a swarm to match him at the weights. 2. I believe that the increase in the number of bees is generally over-estimated. "Thousands daily" is rubbish, and is about equivalent to a swarm a week! It is not that bees are not reared, but that there is an appalling compensatory

loss of bee-life. It would be, perhaps, an exaggeration to say that bees do little more than make up for the winter losses in the whole of the season at their disposal, but, generally speaking, there is a good deal of truth in it. 3. "The stock is stronger in bees when the swarm is hived." Is this the stock that threw the swarm? In that case, and if strength means honey-production, why would a practical man give the supers to the swarm to be continued? 5. Some good judges think—oh, yes, I am inclined to think so too!—that the best "actual results" are obtained by a system of combined swarming and controlled increase.

Brace-combs on Sections (page 408).—Why attempt to stand the sections on to brace-combs? Try them the other way up. But why not use frames to hold your sections, and so dispense entirely with the trouble?

(Continued next week.)

Notices to Correspondents.

B. E. J. (Shatton).—*Moring Bees*.—1. Wait until cold weather sets in to keep the bees indoors for three or four weeks at a spell, when they could be moved without difficulty. Any time in December or January would be suitable. If you are not able to wait, move the hives now and make some alteration in the appearance of those moved by putting a small branch of a tree on flight-board, so that the bees may notice the change in location on taking wing for the first time from the new stand. 2. It would not be necessary to close entrances with zinc. 3. South or east is preferable, although entrances may face in any direction.

REV. F. H. F. (Gloucester).—*Late Gathering of Pollen*.—Strong colonies may still be rearing brood, but this is not in conflict with the advice to "complete all arrangements for wintering by the beginning of October." Our own bees were prepared for wintering by that time, but are still carrying in pollen, and will do so while ivy blossom lasts and they are able to get out. Pollen is not only required for brood-rearing now, but will be stored for that reared early next season before bees are able to collect any. There is no danger of hives getting too crowded, as old bees die off more rapidly at this time of the year than young ones are reared. Colonies should be wintered on eight frames if there are enough bees to crowd them, and the careful bee-keeper will use his best endeavours to get his bees strong enough to do so. If there are not sufficient bees, a smaller number of frames may be used, but there should certainly be no fewer than six

- frames in any case. A colony not able to crowd six frames at the beginning of October should be united with another or strengthened with driven bees. Although colonies may be wintered on six frames, there is no question about the advantage of having them strong enough to occupy eight.
- G. S. S. (Plympton).—*Partially-filled Sections*.—1. If you can store these in a perfectly dry and warm place, you may keep them until next season and use them as bait-sections. As some are not sealed over the honey should be run out. As you have no extractor, you can get the honey out by uncapping the sections and placing them, with the openings of the cells downwards, on a dish or other convenient vessel, and putting them into an oven, taking care that the temperature does not exceed 113 deg. Fahr. The honey will then run out clear of the combs, but a higher temperature would soften the wax and cause the combs to collapse. 2. It is not unusual for bees not strong in numbers to bite holes in foundation when stores are not coming in plentifully to enable them to attend to their business. You can use such sections next year, and if your colonies are strong and nectar is abundant the bees would draw them out properly. 3. Bees properly wintered should not require feeding in winter. The sections are sealed down with propolis, not wax, and, of course, the tops of the frames should be scraped when preparing bees for winter.
- A. B. (Hendon).—*Providing Winter Passages*.—Two $\frac{5}{8}$ -in. pieces of wood for winter passages should be provided, and it would not hurt the bees if you were to lift the quilts on a fine sunny day and put them under on the top of the frames. The operation should only occupy a few seconds.
- G. D. (Cambuslang).—*Books on Fruit-growing as a Business*.—The following books would suit: "The Fruit Garden," by G. Bunyard and O. Thomas, 13s. net; "Fruit-growing for Profit," by G. Bunyard, 2s. 9d.; "Profitable Fruit-growing," by J. Wright, 1s. 2d.; "Practical Fruit-culture," by J. Cheal, 2s. 9d.
- C. S. R. (Newmarket).—*Improving Pasture and Moving Bees*.—1. White clover is the best bee-forage you can have for your bees. Spring is the right time to sow it. 2. You will find full instructions for moving bees on pages 116 to 120 of "Guide Book." If you want simply to transfer the frames from one hive to the other, bring the hives close together and take out the frames from one and put them into the other in the same order in which you find them. You can only do this in fine weather,

and it is late for doing anything to bees now, so you should defer it until next spring.

- D. J. (N. Wales).—*Race of Bees*.—Cross between Italian and black.
- E. P. (Surrey).—*Wax-moth in Sections*.—1. You can keep out wax-moth by fumigating the sections with sulphur, putting them in a box, and pasting paper on the joints to prevent moth from getting in. 2. The honey is good-looking, probably clover with an admixture of buckwheat, which gives it the strong flavour.
- LEARNER (Leicester).—*Proper Temperature for Candy-boiling*.—The sugar will be sufficiently boiled when the thermometer registers 335 deg. Fahr.
- L. BIGG-WITHER (Somerset).—*Dr. Fleischmann's Work on the Honey-Bee*.—Up to the present only three parts of this work have been issued by Theodor Weippl at Klosterneuburg.
- CONSTANT READER (Yorks).—*Candy-feeding*.—1. If you have frames of sealed honey at your disposal you could not do better than give them to the bees. Failing this, candy is the only suitable winter food, as it does not cause excitement like syrup-feeding. Frames can be filled with candy and placed next the cluster, as well as a cake over the frames. 2. If you have subscribed to the Association for the *Record* and have not received it, you should complain to the district secretary and ascertain the reason it is not sent to you.
- CAIRNCROSS AND ZILLEN (Pretoria).—*Retarding the Hatching of Egg*.—At a low temperature the hatching of the egg may be retarded for about twenty-four hours. As the development of the embryo within the egg commences from the time of its fertilisation, undue retardation of the hatching affects the vitality of the future insect.
- R. L. W. (Beverley).—1. Sample is not a first-class honey, being too thin and somewhat watery in consistency. If nicely granulated it should be quite up to show standard, as in other points it is good. 2. Bees are not wintered indoors in this country; it is found that to protect the hives from wet, and provide plenty of wrappings inside to preserve the warmth, is the best plan for keeping the inmates in a healthy condition. 3. Try Abbott Bros., Southall, who specialise in these jars.
- T. C. B. (Stratford, Ontario).—Write for particulars to the secretary of the Ontario Bee-keepers' Association, Mr. P. J. Hodgetts, Department of Agriculture, Parliament Buildings, Toronto.

* * * Several important letters, &c., are in type, but held over from pressure on our space.

Editorial, Notices, &c.

PROMINENT BEE-KEEPERS.

MR. WM. WOODLEY.

Readers of the BEE JOURNAL will welcome with exceptional pleasure the picture we present this week, as Mr. Wm. Woodley is one of the oldest as well as one of the best-known contributors to our pages. His wide experience of bee-keeping, extending from boyhood, gives to his writings a special interest, his articles being not

midable antagonist on the show-table, and the uniform excellence of his exhibits usually placed him in the front rank of winners. His exhibits also had an educational value, proving how much success depends on care and neatness in preparing honey for exhibition.

Mr. Woodley was born at Oxford on March 9, 1846, and six years later he was, on the death of his mother, placed in the care of a great-aunt living at Stanmore, a small hamlet of Beedon, near Newbury, Berks, who was one of several bee-keepers of the old school who kept



MR. WM. WOODLEY.

merely theoretical, but containing sound practical advice which is much appreciated by all, but particularly by beginners in the art of keeping bees.

Mr. Woodley is equally well known as an exhibitor, and a few years ago his name appeared prominently in the prize list of every important show held in England. The reason for this was not far to seek. Located in a district the flora of which yields honey of very excellent quality, this natural advantage, along with his admirable style of preparing his produce for staging, made him a for-

merely theoretical, but containing sound practical advice which is much appreciated by all, but particularly by beginners in the art of keeping bees. When the boy William was considered capable of walking two miles to the village school, he was duly installed as a scholar therein; and upon reaching the age of seven his services were requisitioned during the six or seven weeks of each succeeding swarming season for the purpose of what the old lady called "mindin' the bees." He may thus be truly said to have begun bee-keeping early in life, and no doubt his early experiences among bees have stood him in good stead since, for none make better bee-keepers than those who have gained

their first knowledge of the pursuit in boyhood. Many are the exploits Mr. Woodley can detail of bee-doings at this period of his life; how he assisted the chief bee-man of the place—who, like the great Huber, was blind—in recovering swarms from tall trees, the boy mounting the trees and being "shown" how to manage by the directions called out from below by the blind old bee-keeper.

In 1859 Mr. Woodley was apprenticed to a firm of grocers at Chieveley, Berks, his evenings being devoted to educational self-improvement, and seven years later he left the firm and removed to another employment at Slough, Bucks. While here he began to take an interest in photography; finally, being naturally of a mechanical turn of mind, he displayed a special fondness for handling watches and clocks. This proving a more congenial occupation than the grocery business, and having gained a fair insight into the subject, he returned to Beedon, and started business for himself in the watch and clock trade. The venture brought about a renewal of old acquaintanceships, and the old pursuit of bee-keeping was resumed in a small way, this time on his own account, and with straw skeps, of course. It was, however, not till 1878 that he adopted the frame-hive, and three years later he took first prize at the exhibition at South Kensington, his fine glass super becoming the talk of the neighbourhood at the time. Since that date the growth of Mr. Woodley's apiaries has been steady and constant, the number of stocks now kept varying from 140 to 200. His fame as an exhibitor was recorded in our pages for many years, but he has now given up showing to any great extent. On one occasion, in 1889, a sample of his success in the art of bee-keeping was presented by the B.B.K.A. to her late Majesty Queen Victoria at Windsor, in the shape of a large and handsome design in honey-comb.

Mr. Woodley married in 1872, and his wife was, up to the time of her death in April, 1904, his most able and trusted assistant in the apiary. After Mrs. Woodley's death their daughter took up the home duties and helped with the bees, performing such duties as folding and fitting up sections, glazing them when filled for market or the show-bench, hiving swarms, making candy, and undertaking other business connected with the working of a large bee-farm. On her marriage Mr. Woodley himself married again, a lady whom he had known from childhood. She took to the bee-work with enthusiasm, and has since rendered most valuable help in his bee and honey trade, which has largely increased of late years, the customers being located in all parts of Great Britain.

Like many other successful honey-

producers, he relies entirely on the old native black bee, and believes in no other; and, while endeavouring to improve his strain, no foreign blood is allowed to mix with it. He has also so far been successful in keeping foul brood at a distance.

Mr. Woodley is highly esteemed among his poorer neighbours, and for nearly forty years has been their adviser, will-maker, and trusted counsellor. His opinion is also generally sought on matters of importance occurring in his neighbourhood, and he has the management of a flourishing benefit society.

In addition to managing his private business, he has many calls upon his time in the public interest, having been Guardian and District Councillor for the last fifteen years. He also holds the office of Overseer of the largest parish in the Wantage Union, is chairman of the Parish Council and trustee of the Parish Charities, a member of the local Small Holdings Committee, of the Old-Age Pensions Committee, and holds several other public offices. His zeal and conscientiousness in performing the above duties are shown by the fact that he has not missed a Parish Council meeting for fifteen years, though he has to walk three miles to attend them.

We are sure readers will join us in wishing that Mr. Woodley may long be spared to continue the good work he is doing for bee-keeping and in many other ways which the limits of this short sketch preclude us from detailing.

BRITISH BEE-KEEPERS' ASSOCIATION CONVERSAZIONE.

(Concluded from page 434.)

The Chairman said there were several appliances which he would like those present to examine. The first was one sent by Mr. E. Nuttall, of Wolverhampton, which he calls a combined queen-excluder and bee-escape. It consists of two excluders sliding over each other, and there are two escapes at the sides. The advantages claimed were that when once placed on the hive the supers were under complete control. There was no risk from stings when removing or examining surplus. The bees could be shut out of the supers at any time without opening the hive. The bee-escapes could be seen at work, and are easily accessible should they become clogged. When honey-dew was prevalent access to the supers could be closed without disturbing the bees.

The appliance was handed round, examined, and considered very ingenious, but the opinion generally expressed was that the main objection was the great number of bees that would be cut in halves in sliding the zinc, as there would be a great many bees continually passing to and fro. It

seemed also that great care would have to be exercised in making it so as to get the openings to fit accurately over each other. The escapes being covered with perforated zinc would also be a cause of excitement to the bees, who would be trying to get out, and thus block the passage. The space above the zinc was also considered too deep, as it would cause combs to be built down from the frames. The idea was all right if these objections could be got rid of in practice.

Mr. J. E. Short, of Somerton, showed an adjustable gauge for cutting boards for bee-hives, &c., to any length desired. It consisted of a board on the edge of which there was a 2-ft. measure. A shorter adjustable board, working on slides, is used for holding the wood down, and the gauge can be fixed to any length required. When this is once done any number of boards can be cut to the same length without further adjustment. The gauge consists of two plates, between which the saw slides. If the teeth are not open the edges of the board remain smooth. The appliance will cost 10s. 6d., and should be useful to amateurs who make their own hives, as it will save considerable time and trouble in measuring and marking out.

Mr. F. W. Watts, of Dulwich, submitted an ingenious invention of a queen-cage, which had been registered and named "Watts's 'Simplex' Queen-Cage." Its construction was quite simple. There was a lower compartment, with a movable glass lid, which ensured the safety of the captive insect. He contended that not only was all danger obviated by the use of the "Simplex," but the operation of moving the queen was rendered quite easy and simple, although carried out by the use of one hand only. The lower portion of the cage was first pressed into the comb, after which it required no further handling. The lid was then held in the palm of the hand, thus leaving the fingers quite free to take up the queen and place her in the opening of the cage, already fixed. The lid was then put in position, effectually securing the bee, whose movements could be plainly observed through the glass. He claimed as another advantage for the cage that the bee-keeper would be able to attach it to a piece of spare honey-comb, catch a few bees, and take them indoors for minute examination, which, by the aid of a magnifying glass, would make the insects appear very large and easy to inspect. It might also be used for various other observations, such as upon wasps and the humble-bees. It would cost from 10d. to 1s., and be placed on the market by Messrs. Lee and Son, and he hoped all enthusiastic bee-keepers would give it a trial. The cage was passed round for inspection, and appeared to

secure general approval, the Chairman describing it as a clever and ingenious invention, likely to prove very useful to bee-keepers. The idea and fulfilment thereof were extremely creditable to a young bee-keeper like Mr. Watts.

Mr. Herrod explained an invention by Mr. J. Gray, of Glasgow (which had been exhibited at the "Royal" Show), for uncapping combs. The tray had a double bottom, and contained water, which was kept hot by means of a lamp underneath. The cappings, with the honey falling into the tray, were melted. There were two outlets at different heights, and it was intended that the wax and honey should separate and run out of the different exits. The invention was commented on, but some members, before passing an opinion, thought it would be desirable to know how the machine worked in practice.

The Chairman said he had used this tray, and found that two exits were not necessary, as both honey and wax came out of the same outlet. If the receptacle were kept warm the wax would float on the top of the honey, and could be taken off when cold.

The business on the agenda being now concluded, Mr. Bevan reported that it was proposed to hold a horticultural and agricultural exhibition in Brussels next year. He had been appointed on a commission formed for the purpose of securing the co-operation of this country, and would be very glad if the Association could see its way to take part by furnishing a national exhibit at so important a show. There should be some assistance given towards the expenses to be incurred, which, of course, would be heavier than if the event occurred in their own country. This was the first time that the British Board of Trade had intervened with the idea of organising the representation of any trade products at an international exhibition on the Continent or elsewhere, and had offered pecuniary help to intending competitors from this country. They had bracketed three exhibitions together—that of Brussels for next year, and Turin and Rome for 1911. Bee-keeping exhibits were specially asked for, and enumerated in the schedule of the exhibition among the objects to be displayed. He thought this a good opportunity of putting an important British industry in the best light before the nations of the world, because he was quite sure that in this, as in every other pursuit adopted by Britons, they feared no competition. He had spoken on the subject to many, but they had replied that as individual tradesmen it was not worth their while to embark on such an undertaking, which could not be expected to yield an adequate return for the outlay. He would be glad to know whether the B.B.K.A. thought it possible, in the

circumstances, to organise an exhibit. Of course, this was a matter for the Council's consideration, but probably the Chairman would be willing for the meeting to express an opinion thereon.

Mr. Reid heartily agreed with Mr. Bevan's proposal. It was quite true that the Government were now starting to do what other Governments had done fifty years ago. He believed a special branch was arranging everything for the British exhibitors, and he did not doubt that if the Council of the Association decided to support Mr. Bevan's request as the representative of British bee-keeping the Board of Trade would grant the necessary funds to assist the scheme. He thought there was a good opening for British appliance manufacturers on the Continent, where their productions were in very high repute. No doubt the Board would frank all the cost of sending goods to and fro, so that individual exhibitors would incur much less expense than otherwise they would have to meet. He had great pleasure in moving the following proposition, which would no doubt satisfy Mr. Bevan's wishes: "That this meeting begs the Council of the B.B.K.A. to take the necessary steps to ensure the display of a national exhibit worthy of British bee-keeping at the forthcoming Brussels Exhibition."

Mr. Till thought they ought to commit themselves at once to the venture. He would like to move as an amendment: "That the B.B.K.A. authorise Mr. Bevan to say that they would prepare a good exhibit for the Brussels Show."

The Chairman (interposing) said that it had already been proposed that the Council should take the matter in hand. That was as far as this meeting could go. No doubt its expression of opinion would have great weight with the Council.

Mr. Bevan remarked that the exhibition would cover 250 acres of ground, and there would be quite room enough in the British section for the display of live bees.

The proposal being seconded by Mr. Till, the resolution was carried unanimously, upon which the Chairman said that Mr. Bevan would no doubt take the initiative, and himself bring the subject before the Council at their next meeting.

Mr. Reid desired, before the members separated, to say that he was responsible some years ago for introducing celluloid quilts. He then advocated a certain thickness, but had found by practice that a thinner quilt was advisable, in order to prevent buckling and ensure the covering lying flat on the hive. He then produced the quilt now in use, which got rid of the objections named. In summer and winter the bees could thus always be looked at through the transparency.

The proceedings then terminated.

SOUTH OF SCOTLAND B.K.A.

ANNUAL SHOW.

The annual exhibition of the South of Scotland Bee-keepers' Association was held, in connection with the Galloway Dairy Produce Show, at Castle Douglas on September 16.

The exhibition was a very creditable one to all concerned, and many excellent samples of both run and comb honey were staged. In the open classes, considering the season, the quality was very good, and the quality all over excellent. There were also staged two honey trophies, both of which were tastefully arranged and contained excellent honey. There was also a good display of beeswax.

English exhibitors secured a good share of the prizes in the open classes.

The Rev. R. McClelland and Mr. Wm. Hogg acted as judges, and made the following awards:—

OPEN CLASSES.

Three 1-lb. Jars Extracted Honey (other than Heather).—1st, John Ross, Barkerland, Dumfries; 2nd, Q. Aird, Hardgate School House, Dalbeattie; 3rd, E. W. Sherwood, Netherwallop, Hants; v.h.c., H. W. Saunders, Thetford, Norfolk; K. Dobie, jun., Queen Street, Dumfries; h.c., Alex. F. Borland, Old Cumnock; W. Patchett, Cabourne, Lines.

Three 1-lb. Sections of Comb Honey (other than Heather).—1st, Alex. F. Borland; 2nd, G. Ingram, Broughton, Hants; 3rd, Miss Wilson, Dunmow, Essex, and W. Patchett (equal); v.h.c., James Cruickshanks, Paxton, Berwick-on-Tweed.

Single 1-lb. Jar Extracted Honey.—1st, John Ross; 2nd, Q. Aird; 3rd, G. Ingram; v.h.c., E. W. Sherwood.

Single 1-lb. Section of Comb Honey.—1st, K. Dobie; 2nd, H. W. Saunders; 3rd, John Ross; v.h.c., John McDonald, Lochfoot, Dumfries; h.c., James Cruickshanks.

Beeswax (cake not less than 1 lb.).—1st, J. M. Stewart, Mollance Gardens, Castle Douglas; 2nd, W. Patchett; 3rd, J. Ross.

MEMBERS' CLASSES.

Display of Honey.—1st, John McDonald; 2nd, Q. Aird.

Super of Honey (other than Heather).—1st, Andrew Tait, Spottes, Dalbeattie.

Super of Honey (other than Heather) under 15 lb. gross weight.—1st, William Tait, Spottes, Dalbeattie.

Six 1-lb. Sections of Comb Honey (other than Heather).—1st, K. Dobie; 2nd, Robert Beck, Lochfoot, Dumfries; 3rd, Q. Aird; v.h.c., Alex. F. Borland.

Three Sections of Comb Honey.—1st, John Ross.

Six 1-lb. Jars Extracted Light-coloured Honey.—1st, Alex. F. Borland; 2nd, John Ross; 3rd, Q. Aird; v.h.c., James McNaught, Dunscore, Dumfries.

Six 1-lb. Jars Extracted Medium-

coloured Honey.—1st, K. Dobie; 2nd, J. Ross; 3rd, Q. Aird; v.h.c., J. M. Stewart.

Two 1-lb. Jars Extracted Honey (other than Heather).—1st (silver challenge cup and gold medal), J. M. Stewart; 2nd, Q. Aird; 3rd, John Ross.

Two 1-lb. Sections.—1st (silver challenge cup and gold medal), John McDonald; 2nd, K. Dobie; 3rd, J. Ross.

Three 1-lb. Jars Extracted Heather Honey.—1st, J. Ross; 2nd, W. Ovens, Torr, Auchencairn.

Three 1-lb. Sections Heather Honey.—1st, J. Halliday, Slogarie, New Galloway Station; 2nd, W. Ovens; 3rd, Jas. Morton, jun., Clavemont, Dumfries.

Six 1-lb. Jars Extracted Honey (other than Heather).—1st (silver medal), Jas. McNaught; 2nd, Jas. Morton.—Q. AIRD, Secretary.

W. B. CARR MEMORIAL FUND.

We should like to remind readers that the Council of the B.B.K.A. have decided to close the above fund on the 17th of the present month, and we therefore ask those wishing to subscribe to send their donations without delay to this office.

Amount already acknowledged	£	s.	d.
Jos. Thomson (Dundee)	0	2	6
R. Grose	0	2	6
J. C. Mason	0	2	6
J. Berry	0	2	6
R. Godson	0	2	6
J. Henderson	0	2	0
T. A. Flood.....	0	2	0
A. L. (Aberdeen)	0	2	0
H. G. Ceiley	0	1	0
	£59	5	6

HONEY IMPORTS.

The value of honey imported into the United Kingdom during the month of October, 1909, was £1,809.—From a return furnished to the BRITISH BEE JOURNAL by the Statistical Office, H.M. Customs.

Correspondence.

The Editor does not hold himself responsible for the opinions expressed by correspondents. No notice will be taken of anonymous communications, and correspondents are requested to write on one side of the paper only and give their real names and addresses, not necessarily for publication, but as a guarantee of good faith. Illustrations should be drawn on separate pieces of paper. We do not undertake to return rejected communications.

A POOR SEASON IN LANARKSHIRE.

[7660.] I have been a reader of your journal for several years, and now venture to send you a few notes on the season which may now be said to be past.

In the district in which my bees are

located high east winds as a rule prevail until well on in June, so that the only surplus obtained is from the clover and heather. This year, however, May was a little drier and milder than usual, and all-round swarming was expected by the end of the month—a hope that was not realised, as the weather became cold and wet during the last week, and seemed to damp the swarming fever. In June, though the weather was fairly good, there was little for the bees to gather, and when the clover began to bloom early in July the weather again broke, and continued so cold for the remainder of the month that our hives were poorer at the end of July than they were at the end of June. Worse remained, however, for when we packed our bees for the moors in the second week of August we were again full of hope, as the heather had to some extent made up for the clover failure. But it was the same old story over again; we got no sunshine till September 13, about which time the heather was on the wane, and with the hard frosts every morning there seems to have been no secretion of nectar; so for this year we have to confess that we have drawn a blank.

Since writing the above my attention has been drawn to the attached paragraph from a recent issue of the *Glasgow Herald*, which you may have seen. The only comforting thought is that we are no worse off than our neighbours.—J. T., Lanarkshire.

To bee-keepers, says a correspondent, the season just closing is the poorest on record. Although 1888 was a colder year, there were a few favoured bee-men who obtained a small return, but the present season presents the unparalleled failure of this minor industry throughout Britain. What the exact cause of this may be is difficult to say, but probably the prevailing north and north-west winds, coupled with a low barometer (29 in.), answers the question. In the Central Highlands the summer opened with some promise, as during May stocks pulled up considerably, and by the end of the month bees were fairly numerous. June and July were dry months, the heavy rains which fell elsewhere passing over the central area of Scotland. Although not cold, there was no genial warmth, which resulted in a poor show of clover quite devoid of honey. Hopes were entertained that the limes would supply the deficiency, but on these trees the forage was meagre and nectar nil. August opened with the only hot days of the season. Unfortunately this spell was of short duration, the rest of the month being cold and wet, and heather only coming into bloom towards the end of the month. In the Pitlochry district 'there is no surplus whatever. Bee-

keepers are preparing to feed heavily, bees not having gathered enough to supply their own wants.' In this connection it is estimated that a bee-keeper who owns about 100 hives will have to expend between £20 and £30 in sugar ere he can expect his colonies to safely go through the winter. The season in Blair Atholl has been an entire failure, there being absolutely no honey for sale. Bees have done little during the season but hang about the doors ready to sting anyone approaching. There was also apparent a disposition to quarrel among themselves. Kinloch Rannoch dismisses the inquiry as to the season's yield in two words, 'complete failure.' Farther north the same depressing state of things exists. Writing from Grantown-on-Spey, a well-known bee-expert says: 'Briefly summed up, 1909 has been the worst season I have known in my bee-keeping experience. Spring opened cold, and stocks had to be fed up to the end of June. Clover blossom was plentiful in July, but cold sunless days and wet weather kept bees indoors. The little honey gathered only kept hives going, practically nothing finding its way to the surplus. August opened bright, with higher temperature, but the time was too brief to appreciably alter matters, the only result being a few unfinished sections. A good deal of feeding will have to be done if the spring count is to tally with that of autumn.' The opinion is general that bees will have to be fed on a large scale if they are to see another summer."

BRITISH BEE-KEEPERS' ASSOCIATION

[7661.] I have noticed in the B.B.J. recently two important matters—namely, the present position of the B.B.K.A. and the increasing honey imports, and I take the liberty of sending my humble suggestions to improve the first and prevent the second.

The value of honey imported into the United Kingdom during the year 1907 was £31,644, which, reckoning the value of the honey at 10d. per lb., makes the total bulk equal to 339.04 tons. In 1908, £31,769 worth was imported, or 340.37 tons. Up to the end of September this year the imports have reached £37,025, or 396 tons. Taking this for three-quarters of the year, by the end of December the value will probably rise to over £49,000, or over 400 tons.

Now, Great Britain, with her opportunities of bee-keeping and the excellent honey she can produce, should not be in a position to be obliged to import over 400 tons of foreign honey a year to meet the demand, but ought to produce all the honey needed, and have sufficient to export.

The question is: How can we bee-keepers raise the extra 400 tons a year? One county could not do it, and the only way it can be managed is by all bee-keepers working together with their respective associations.

On page 311 of the B.B.J. it is stated "the associations have about 6,500 members. This figure represents only about 10 per cent. of the estimated number of bee-keepers in the counties represented by the associations," and "about 6,200 members pay an average subscription of 3s. per annum." That is to say, there are 65,000 bee-keepers in Great Britain, and the first thing to do is to get the remaining 58,500 to join their county or the British Bee-keepers' Association. To enable this to be done, may I suggest that the subscription to all associations be reduced to 2s. 6d. per bee-keeper? This at first appears impossible if the associations are to continue in a prosperous condition. But may I remind your readers of the fact that the same sort of thing was felt in 1839, when Sir Rowland Hill proposed penny postage? That has proved a wonderful success; then why not this? Again, the 6d. hansom cab instead of the former 1s. one, only tried this year in London, is proving a success, as one can see by reading the papers. The one has induced thousands to write letters, and the other is making more people use hansom cabs. Then why should not a lower subscription make more bee-keepers join their county associations? As subscriptions are reduced the donations ought to be larger. Many bee-keepers would like to join their county association as well as the B.B.K.A., or *vice-versâ*. They may feel more inclined to do this if they only have to pay 5s. instead of 8s. or 10s. The low subscription will bring all bee-keepers on the same level, as far as superiority goes in the matter of associations, and we ought not to have any more complaints in the B.B.J. like 7545 (page 295), 7584 and 7585 (page 337). Bee-keepers will have the same chances to work for the cause—viz., to produce enough English honey to supply the demand in Great Britain. So much for the bee-keepers; now for the associations.

As the English climate is very changeable, it might easily happen that in one year one county may be in a very prosperous condition, while another might be the reverse. The following year the positions may be changed. It is well known that for success one must have all colonies of the same strength. Could not this rule be applied to associations? I think it could in this way—viz.: Every association should put all its money into the B.B.K.A. at the end of one year, and the next draw out the necessary money for

expenses. All the counties would then be on a level financially, and have the same chance as the bee-keepers to work for the cause. The B.B.K.A. will thus again take the prominent place it should do.

Some prosperous counties will no doubt object to this scheme. If they do, may I refer them to their own bees? Do not they all contribute their individual wealth to the common share? And are not they successful? If each bee kept all the wealth that she obtained for herself there would certainly be no bee-keeping associations or anything else connected with them; but as each bee contributes all she possesses to the common store, there is enough honey for herself, her companions, and a very big balance, which the bee-keeper takes charge of. Fortunately for the associations, there is no big person to take all the balance from them, but it will be used in making things more pleasant for the county associations as well as the parent society.

This plan will make the associations and bee-keepers more comfortable, but it will not produce the extra 400 tons of honey required. This will have to be done by the bee-keepers themselves. Every bee-keeper should try to make somebody else start bee-keeping and join an association. If he is successful in doing so, he should help all he can till the novice can manage his bees by himself. If he is unsuccessful, he can then try again. When the new bee-keeper can manage his own bees, he should in his turn make another bee-keeper. If everybody does this there will soon be sufficient bee-keepers and bees to produce the extra 400 tons. Honey is steadily coming more into favour, as can be seen by the figures quoted, and it is to the interest of all to produce enough British honey, which is the finest there is, to supply the demand, and so oust the foreigner.

If this were carried out everybody would prosper—the bee-keeper in getting a market for his honey, the associations in growing larger and more prosperous, the orchards and flowers in having more bees to fertilise them, and the purchaser in getting first-class honey.—W. G. COATES, Chelsea, S.W.

THE B.B.K.A. AND ITS SECRETARY.

[7662.] Whilst very much regretting the causes that have compelled Mr. Young to relinquish the duties of secretary, which for so many years he has carried out in such a satisfactory manner, I am delighted to see that the Council have succeeded in finding a most capable man to take his place—for the time at least. But I hope the Council will make the appointment a permanent one. What is wanted to revitalise the B.B.K.A. is a

strong, energetic secretary, full of enthusiasm for the craft, and one who is well known to bee-keepers all over the kingdom. The secretary is the mainspring of all societies and associations, and I think Mr. Herrod would be able to make many suggestions and innovations which would be beneficial to bee-keeping throughout the country. Personally we are under an obligation to Mr. Herrod for a very kindly act. Only recently he happened to be in Oxford, and looked in at our little show in Headington Hill Hall Park. One of our members happened to mention that we were having a bee-demonstration, and he spontaneously volunteered and gave us one of the most interesting lectures one could have wished to hear. Subsequently one of the committee of the Horticultural Society met me, and remarked that he had learned more about bees in that half-hour than he had learnt before in his whole life, and he was a bee-keeper too.—H. M. TURNER, Hon. Sec. Oxon B.K.A.

[7663.] In the B.B.J. for October 21 we were agreeably surprised to see the appointment as secretary *pro tem.* of our old friend Mr. W. Herrod. We are wondering if this is to be permanent, and sincerely hope that is the case, as amongst all the prominent bee-keepers, we know of no one who would fill the post better. As old exhibitors we are grateful for many kindnesses shown to us, and consider that his management of honey competitions is all that can be desired. His masterly and tactful handling of the "Royal" this year under great difficulties is still fresh in the minds of the exhibitors and officials closely connected therewith. Never has the department been so well managed.—R. BROWN AND SON, Flora Apiary, Somersham, Hunts.

[In addition to those we have published, we have received letters commending the action of the Council from Messrs. J. P. Phillips (Hon. Sec., Worcester B.K.A.), James W. Bold (Hon. Sec., Lanes B.K.A.), G. R. Alder (Hon. Sec., Essex B.K.A.), G. Hayes (Hon. Sec., Notts B.K.A.), F. Fowler (Hon. Sec., Bishop's Stortford B.K.A.), G. W. Judge, R. Hefford (Hon. Sec., Northants B.K.A.), J. L. P. Howard (Hon. Sec., Hertford and Ware District B.K.A.), J. Roberts, W. J. Kitson, A. Wilcott, W. Dixon, H. Spencer, T. E. Hancox, J. Bates (Hon. Sec., Crayford and District B.K.A.), R. Mackender, A. W. Allen, J. L. Brierley, W. A. Simkins, J. C. Hedley (Hon. Sec., Northumberland and Durham B.K.A.), E. Loxley, M. E. Osborne, A. H. Wilkes, and the Rev. A. D. Downes-Shaw.—ED.]

[7664.] May I ask you to allow me a little space in your journal to thank all those kind friends who have written congratulating me on taking the temporary position of secretary to the B.B.K.A.? I had no idea I possessed so many friends in all parts of Great Britain, and their good wishes will make a hard task much lighter. Much as I should like to write a letter to each, it is impossible with the amount of work I have on hand. Will they therefore accept the will for the deed, and take this as the best I can do in the circumstances? — W. HERROD, Luton.

THE "WILKES" QUEEN-EXCLUDER.

[7635.] On page 427 of the issue of your instructive and interesting journal of October 28, I notice a correspondent, "A. P., Sussex," asks for information respecting the "Wilkes' Free-way" queen-excluder as compared with the old pattern. I have used zinc excluders for two or three years, and last season tried the "Free-way" excluder. I take the liberty of giving my experience for the benefit of "A. P." or other interested readers. I suppose every bee-keeper admits the advantages of using a queen-excluder, and the zinc pattern did its duty very well in most cases; but it is very apt to be propolised down, and when taken off after the honey-flow the bees are often irritated by the efforts made in trying to unstick it from the frames to which it has frequently been fastened with propolis. Many bee-keepers, including myself, also discontinued its use under section-racks, as it was found in some cases to hinder the bees taking to them. Now I first saw the new wire excluder at the annual meeting of the Warwickshire B.K.A. early last spring, and after thoroughly examining it I decided to order one immediately from the makers. This I placed under a rack of sections in May; in June I placed another rack under the first, and this hive yielded me thirty-five good 1-lb. sections of honey. Taking the season and district into account—Erdington being only four and a half miles from Birmingham—I consider it a very good result. Another "Wilkes" excluder I placed in May under a rack of shallow frames, and the stock yielded me 20 lb. of extracted honey. I think these facts speak for themselves as regards the efficiency of the new excluder. Having no flat edges, it cannot get propolised to the frames, and on taking the excluders off in August both were found quite free from propolis, though they had been in place from three to four months.—W.M. F. WIEMANN, Third-class Expert, B.B.K.A., Erdington.

[Many other letters have been received in reply to our correspondent "A. P.,"

and in thanking the writers we may say that all speak very favourably of the new excluder.—ED.]

POLISTES GALLICA.

[7666.] I was interested in seeing *Polistes gallica* mentioned in an answer to a query from Festiniog in B.B.J. a few weeks ago. If a live specimen of this non-British wasp has been taken at Festiniog, it would be of great interest to hymenopterists. I believe one or two captures have been reported in this country, but they have been regarded as accidental introductions.—F. W. L. SLADEN.

CAPPINGS OF COMB.

BY L. S. CRAWSHAW, NORTON, MALTON.

Late Feeding (page 406).—It is perhaps ridiculous to talk about this as a possibility, for of course no one does neglect his bees, or allow a stock to be short of winter stores. But should anyone be caught napping, it may be difficult to get the bees to take syrup from a feeder. Rapid-feeders are of no use in cold weather, for the bees will not journey far from the cluster. If the weather permits of opening a hive at all, a comb of warm syrup stores may be slipped into the cluster. Half the cluster-frames are slid bodily away, sufficiently far for the insertion of the food-comb, and then closed up to it. The syrup may be poured into the comb from a jug at a slight elevation, or may be syringed into the cells, using gentle pressure only.

How Doth the Bee (page 415).—A perusal of Mr. Cowan's paper (page 402) suggests that the well-known line used here by "D. M. M." is really more pregnant with meaning than perhaps even the good Dr. Watts realised. Viewed from this vantage highland, the little busy bee is seen to effect a very real improvement in the shining hour. It is now a long time ago—even longer ago than the halcyon days when Adam's ravished ear first listened to the sunlit bee-music—pre-faced far back in the all but defaced pages of the great earth-book, that the plant first bribed the insect to help it climb with certain foot this most important cross-rung in the evolution ladder. Pollen, nectar, and cross-fertilisation by other agencies no doubt preceded the bee—certainly preceded the hive-bee—but to-day it is the bee which pre-eminently serves our table with the goodly fruits of the patiently-tilled earth.

Good Resolutions (page 416).—Such a testimonial from our good friend "D. M. M." is no mean tribute to this foolish and irresponsible column, the value of which I have often seriously doubted. And I will paste it in my hat

against the rapidly-nearing midnight when I shall turn over that fresh leaf of good resolutions. Next year—ah, next year—who knows what it may have in store? Old Khayyám says:

To-morrow?—Why, To-morrow I may be
Myself with Yesterday's Sev'n Thousand Years.

But it is kind of "D. M. M." to give some respite, making, no doubt, some kind allowance for a season like this. It is exceedingly difficult to prevent a percentage of honey-dew from finding its way into the extractor, and the general dearth means that, even so, many of the "jars" must remain empty. But it is unfortunately these same empty jars which make the most noise, and life will indeed become quiet if we are to abandon the poor consolation of using them for the musical glasses! If the music be sometimes meaningless or inharmonious, good time need not be spoiled in the attempt to fathom its meaning or to resolve its jarring notes. So, with "D. M. M.," bumpers to the coming year!

Light in Darkness (page 416).—A stock like this which can keep itself unspotted from the world, and can show three racks of light sections, or rather heavy sections of light honey, whilst surrounded by honey-dew, is worth propagation. These are evidently bees of taste, and if their history were known it would probably be found that they, or their immediate progenitors, had visited a honey show in an observatory-hive within earshot of the judges' remarks. No. 7638 will be well advised to split up the stock into as many nuclei as possible the next time it swarms. I, too, have had the experience he mentions, of very late honey stored in the returned racks. I did not send the whole of the prepared hives to the heather this year; white and red clover bloomed so profusely afterwards that it proved much more profitable to leave these bees at home than to take them to the moor.

An Effete Queen (page 417).—Mr. Whyte's criticism, fair as it is, simply shows how easy it is to be misled as to the meaning of words by undue reliance upon the dictionary. *En effet*, as the Triton would say, may I point out to him that this word, more suitably spelt Ephete, hardly bears out his argument? A brief reference to the admirable letter (No. 7631, page 397) will show that Eff, or properly Eph, was the Ephesian symbol for a bee, and the rest of the word clearly comes from the Greek Etos—the year. Hence, a bee of the year, or yearling bee. Such a bee—a queen-bee—could by no means be considered barren or exhausted. There is, I admit, some doubt as to whether the term was originally applied to the queen, since a reference to the illustration (page 397) makes it clear that this is a king-bee,

or drone. But due allowance should be made for this, in that the old belief was that the hive was governed by the male.

A Retrogressive Step (page 417).—I cannot allow Mr. Whyte's discouraging dictum, that breeding and brood-rearing can be safely left to the bees, to go unchallenged. Breeding, perhaps; but brood-rearing, never. Surely he is mistaken in thus criticising the teaching of the best standard works on the subject. Are we to revert to the let-alone system of our forbears, who forbore to interfere at all with the internal economy of the hive? I am loath to believe that the many happy hours I have spent in feeding the pearly babes with painfully secreted food, or the time so gladly given to washing their darling faces and undressing their outgrown clothes, has been waste effort. Never, never!

WEATHER REPORT.

WESTBOURNE, SUSSEX,

October, 1909.

Rainfall, 8.66 in.	Minimum temperature, 27° on 30th.
Above average, 4.77 in.	Minimum on grass, 19° on 30th.
Heaviest fall, 1.67 in. on 28th.	Frosty nights, 3
Rain fell on 26 days.	Mean maximum, 59.1
Sunshine, 94.6 hours.	Mean minimum, 46.
Below average, 28.3 hours.	Mean temperature, 52.5.
Brightest day, 6th, 9.6 hours.	Above average, 3.6.
Sunless days, 10.	Maximum barometer, 30.273 on 9th.
Maximum temperature, 63° on 3rd.	Minimum barometer, 29.430 on 27th.
	L. B. BIRKETT,

OCTOBER RAINFALL.

Total fall, 5.27 in.

Above average, 1.03 in.

Heaviest fall in 24 hours, .61 in. on 10th.

Rain fell on 24 days.

W. HEAD, Brilley, Herefordshire.

Notices to Correspondents.

* * *Erratum.*—Reply to "Learner, Leicester," page 440 of last week's B.B.J., should read "235 deg.," not 335.

A. M. B. (Reading).—*Bees Thrown Out of Hive.*—The chyle-stomach of the bees sent was congested, and contained undigested pollen, and also showed signs of decomposition after death. Porto Rico sugar is not suitable for bee-food, and should not be given to bees. Only white lump, cane, or crystals should be used.

L. B. (Nelson).—*Dead Bees on Alighting-board.*—The three dead bees which you have found on the alighting-board reached here perfectly flat and dried

up. No doubt advantage was taken when the sun was shining to carry out the dead. Finding a few dead bees is no indication of disease, as many of the old bees are constantly dying off in the autumn. They are black crossed with Italian.

STROMA (Aberdeen).—Packing and Moving Bees.—Presuming that you mean to put the hives on top of ekes, and not into them as you say, you can pack them in the way you propose, and make two parcels of the eight stocks, provided you keep the bees of each colony separated and ensure thorough ventilation. Why, however, adopt such a complicated plan by putting four colonies together when a smaller package is not only more easily handled, but is in every way preferable?

READER (Eccles).—Feeding Bees in Straw Skep.—The bees should have been fed up before this if they needed food. If they are short of stores, you can only give them candy now. Remove the perforated zinc which is over the hole in the top, and place the candy on it, covering up carefully.

J. D. (Newcastle Emlyn).—Dead Bees Carried Out.—You do not give any description of the conditions under which the bees have been carried out, but as those sent are filled with sweets we can only assume that they have been smothered or killed in fighting. There appears to be nothing the matter with them.

W. R. (Sussex).—Bees Dying.—The bees you send have their chyle-stomach and intestine loaded with pollen, and appear to be suffering from constipation. Although the outward symptoms you describe are similar to those in the Isle of Wight disease, we have not been able to detect either Dr. Malden's *bacillus* or the *nosema* of Dr. Zander. At this time of the year it is very difficult to do anything that is likely to cure the colony, as the main point is to renew the combs and induce rapid brood-rearing; therefore, rather than run the risk of the malady, whatever it may be, spreading, we would advise the destruction of the colony.

J. PEARMAN (Derby).—Experts' Certificates.—You should make your protest in the same paper in which the statement appeared. To take notice of such vaporish attacks on the B.B.K.A. in the B.B.J. would only give the writer undue prominence and attach importance to valueless utterances. It is not an uncommon thing for people, especially such as are not able to obtain certificates themselves, to think they can give advice to experts.

M. M. (Chorlton).—Making Candy.—1. Lime honey, good colour, but thin.

There is no honey-dew. 2. Candy rather under-boiled, and will become brittle and hard. A thermometer is not necessary, as full instructions are given in the "Guide Book" on page 195 how to make proper candy without one. If a sugar-boiling thermometer is available, the proper temperature is 235 deg. Fahr., and it may be allowed to reach 240 deg. without doing harm. Very few minutes elapse between these degrees, so that the sugar must be watched closely during the boiling at this point so as not to over-boil it.

E. C. (Atherstone).—Medicated Syrup.—The syrup is much too thin, has an acid taste, and has been probably made with impure sugar. You do not say what foul brood remedy you used in it.

B. C. (Little Ouseburn).—Soft Candy.—Sample is an excellent candy and in perfect condition. If made in 1908, it reflects great credit on the maker.

Honey Samples.

S. W. (Grays).—Sample is a nice light honey of fairly good flavour and aroma, but rather watery consistency. It appears to have been gathered from mixed sources, but partly from clover.

A. B. C. (Ware).—Tree-blossom honey, free from honey-dew. Flavour and consistency both good; its colour is its worst point.

E. G. G. (Hinckley).—A thin, watery honey, with so strong a smell of oil as to obliterate the aroma and flavour.

W. G. C. (Chelsea).—1. From clover and dandelions. 2. Very fair flavour. 3. About 56s. a cwt. bulk and 9d. to 10d. per lb. retail would be a very moderate price. 4. Light honey class.

L. (Ayrshire).—The "pure Scotch" is a nice - coloured and mild - flavoured heather-blend honey, its chief fault being its thin consistency.

A. ROLLO (Blackford).—Sample is a nice-flavoured honey, which, though of a dark colour, contains no honey-dew. We notice no bitter flavour, but perhaps the honey has been over-warmed to increase its density or reliquefy it. In this case the flavour and aroma would be affected.

W. H. F. (Leicester).—Honey of fair quality, rather thin, and dark in colour. No particular flavour or aroma; we should say it has been gathered from mixed sources.

J. N. (Langwathby).—Yes; the honey is rather insipid and flavourless, but it is pure, or it would not have granulated.

*** Several important letters, &c., are in type, but held over from pressure on our space.

Editorial, Notices, &c.

REVIEWS.

The Children's Story of the Bee. By S. L. Bensusan (London: Mills and Boon, Ltd. Price 5s. net).—Here is a book specially designed to interest young people, which, although not intended to teach bee-keeping, is written by an enthusiast, who owns an observatory-hive in his chambers in the Temple, and is one of the few bee-keepers in the City of London. He found this hive a source of recreation and delight, and while the hum of the City was audible, with the rattle of trams on the Embankment and roar of motor-omnibuses on the Fleet Street side, he watched his bees pursuing their labours as happily as though they were in the orchard from which they were brought. Mr. Bensusan writes his story in a pleasant and attractive manner, and says that he does not seek to add to the store of knowledge that experts have collected, but that his effort is rather directed to rousing an interest in the story of the bee among those who have never yet turned to consider it. He is right in saying that the hive-bee might be found in thousands of gardens where at present it has no place, and that the store of honey our well-flowered country yields annually is not one-hundredth part of what it could and would yield if the study of bee-keeping were more generally taken up. As there are many comprehensive books at the service of the bee-keeper, the author only indicates important questions that have been dealt with at great length and skill elsewhere. He thinks there was more bee-keeping in these islands some centuries ago, when the printed book was unknown, than there is to-day, when so many counties have their own bee-keepers' association, and modern hives have reduced the labour of bee-keeping to a minimum and increased the production of honey threefold. He gives this as an excuse for another very interesting contribution to the subject. The illustrations by Carton Moor Park add greatly to the interest of the book, which we are pleased to be able to recommend, with the hope that its perusal may induce some to become bee-keepers.

The Patent Road to Fortune. By a Successful Traveller on It (London: A. Brown and Sons. Price 3d. net).—The anonymous author tells us that while many pathways to fortune are open to the capitalist, there are few open to the man of small means, and amongst these—open to all—the "patent road" stands supreme. This little book is intended to show that most of the successful inventions of the present day have been originated by

men of one idea, and not necessarily clever men, who saw a want, and by plodding strove to supply that want. He gives several illustrations, and in suggesting what to invent advises small articles of utility for the multitude. Such inventions are much easier to get adopted, and if there be any good in them are almost immediately taken up on good royalty. He then explains what constitutes an invention, and gives particulars how to obtain a patent. As the Patent Laws have recently been altered, we recommend any wishing to become acquainted with the subject to get this little book, which also contains information respecting registration of designs, trade marks, "patent medicines," and the law of copy-right.

ISLE OF WIGHT DISEASE.

Dr. W. Malden, of the Pathological Laboratory, Cambridge University, lectured before the members of the Museum Association on November 5 in the Art Gallery of the Castle Museum, Norwich. The lecture was illustrated by lantern-slides, and after referring to the history of bee-keeping and the anatomy of the bee, Dr. Malden described some of the diseases affecting bees. Referring to the new disease which had appeared in the Isle of Wight, unknown till five years ago, he said there was not a single stock now which was in the island before that time. When he was there last summer he saw the only two remaining of the original stocks, and since then both had been destroyed by the disease. Unfortunately, it had reached the mainland, having appeared in Hampshire, Sussex, Berkshire, Hertfordshire, and, he believed, also parts of Essex. The Board of Agriculture having asked him to study the disease, he had set about doing so. Bee-diseases were extremely difficult to investigate, for one could not interrogate the patient. He had been unable to make out a single distinctive symptom. There was a group of symptoms which generally occurred, although they were not always present. He was sure that this was an infectious disease, almost positively due to a microbe. He had been able to find a certain bacillus which did not occur in healthy bees, and was only present, as far as he could discover, in diseased ones. He had described it in the report which he sent to the Board of Agriculture last spring. It was a remarkable fact that the queen was never known to suffer from this disease, so far as he knew. He had several times found all the workers dead and the queen alive and all alone. There was probably some difference in the food which enabled the queen to survive when all the rest of the stock had died. He could

hold out no reasonable hopes as to the treatment of the disease. When once it was attacked a hive was never spared, and the only treatment he knew of was destruction. The only hope seemed to be to establish a race which would be immune from the disease. That was the way in which human diseases came under control, and so we were now able to regard measles as a trifling complaint, though we know that it is extraordinarily fatal when introduced among the South Sea Islanders.

RESPECTING PARTHENOGENESIS.

[The following is the last communication we received from Mr. E. L. Pratt before his death in March last. In writing to us he said that the discussion on this subject had induced him to send these notes, which were intended to appear in the German edition of one of his books. As they are the result of observations by such a keen and expert queen-breeder, it is well to have them placed on record in the columns of the B.B.J. as corroborating the experience of practical beekeepers on the subject.—ED.]

As further proof of the soundness of parthenogenesis in honey-bees I take occasion to cite here a case that by chance fell under my observation in the year 1905. A number of ripe queen-cells were placed in an upper story of a strong colony, each cell in a transfer cage with its supply of food, as usually practised by me. I neglected to make a record of these cells, and as a consequence they were entirely forgotten for fifty to sixty days. In examining the colony I found twelve fine virgin queens fully developed and as spry as you please. The outsides of the cages were covered with young bees, which were evidently feeding the queens through the meshes of the fine wire covering the cages. At least three of the queens were heavy with eggs, and on further examination I discovered that in two of the cages were eggs in large numbers, literally piled up on the bottom of the cages, where the queens had dropped them; some were attached quite naturally to the sides and bottom of the cages and looked quite fresh; other eggs were dried, which indicated that the queens had been at egg-laying in their close confinement for several days. The queen-and-drone excluding honey-board being in place between the brood-chamber and super containing the cages, not one drone could possibly get at the young queens. Therefore these eggs were laid by unimpregnated females, females that had in no way come in contact or even in touch with males.

In my queen-rearing experience I have noted that partially-developed females—

that is, queens that have been reared in run-out baby-nuclei—are capable of being impregnated by drones and will produce both male and female progeny. As is well known, insufficiently-nursed queen-cells will produce females of so scant development that they can hardly be distinguished from workers by the casual observer. I have had such undeveloped things mating and laying eggs; which goes to show that the line between perfect and imperfect females is very closely drawn in honey-bee life. On several occasions I have detected these semi-perfect females, and have hardly been able to detect a difference between them and the imperfect—yet there was just that amount of difference to make them attractive to the drones and satisfying to the workers. I am of the opinion that the workers that first turn fertile in a queenless colony are those which were in the early stages of the grub over-supplied with food, which gave them a little further development towards the perfect than the mass of the worker-bees. Just what point in development will permit of mating and pregnancy I have not as yet been able to determine. I shall be watchful, however, and make further report later.

I am entirely convinced that both the queen and the drones are stimulated to nuptial flight by the workers when they have arrived at ripe age, not only by feeding, but by grooming and communication as well. I have been closely watchful of this, and have gathered some data which may be interesting to the student. By repeated experiment I have found that if a colony is entirely made up of old bees—so old that they are incapable of nursing—it becomes impossible for them to create in a virgin that desire to fly and mate. She may fly, but she does not seem to be attractive to the drones, as she repeatedly returns unsuccessful in her flights. As a result of the above condition the virgin simply lives among the bees as a worker-member lives, not even becoming a drone-layer, owing to the lack of nurse-bees to develop her ovaries by feeding. Even young larvæ given to such a colony will be neglected, and will frequently die of starvation. If emerging brood is given, however, young bees will hatch, and at length begin to feed the queen, and in time the queen may begin to lay; but, having passed the mating-age, she will not mate, so becomes a drone-layer. These experiments have proved to me that it is necessary for even a drone-layer to be fed and nursed by workers before it is possible for her to produce eggs. As a conclusion, I believe that young bees are absolutely needed at the three fundamental stages of a queen, viz.: First, to produce the abundance of food needed fully to develop their queen in her

cell; second, properly to stimulate her to flight for the purpose of mating; third, to develop the eggs in her ovaries after impregnation. Further, as has been previously mentioned in my papers, it is also necessary for the drones to receive their share of attention from the nurse-bees in order that they may become at all potent.—E. L. PRATT, Swarthmore, Pa., U.S.A.

NEW DISTRICT B.K.A. FOR BECKENHAM AND BROMLEY.

A meeting was held on Thursday, November 4, at New Beckenham to consider the advisability of forming a bee-keepers' association for Beckenham and Bromley districts.

The chair was taken by Mr. Oliver, and it was proposed by Mr. Barnes, seconded by Mr. Watts, "That an association of bee-keepers be formed for Beckenham, Bromley, and surrounding districts, under the title of 'The Beckenham, Bromley, and District Bee-keepers' Association,' and that there be a meeting of members every alternate month at Beckenham and Bromley." This resolution being carried, the subscription to the association was fixed at 5s. per annum for ordinary members and 2s. 6d. for cottagers.

Mr. White was then elected hon. secretary and Mr. Watts hon. treasurer.

It was arranged that a preliminary meeting should be held at Bromley, Mr. Seadon kindly consenting to lend them a room for the purpose. The meeting is to take place at 8 p.m. on the 18th inst. at Mrs. Seadon's apiary, Stanley Road, Bromley, and bee-keepers are cordially invited to attend.

Subscriptions to the amount of 30s. from those present were handed to the hon. treasurer, and it was suggested that the first general meeting should be held at Bromley on Saturday, the 27th inst., and that Mr. Herrod, the B.B.K.A. expert, be asked, if possible, to give a lecture.

The hon. secretary will be pleased if all who are interested in the scheme will communicate with him at 9, Guydor Road, Elmers End, Kent.

CRAYFORD B.K.A.

ANNUAL MEETING.

The annual meeting of the Crayford and District Bee-keepers' Association was held in the Parish Room, Crayford, on October 18, Mr. E. R. Stoneham presiding over a large attendance.

Mr. J. M. Bates, hon. secretary and treasurer, read the annual report, which stated that there had been satisfactory progress. During the past year several new members had been enrolled, and the membership now numbered about eighty.

Through the kindness of Mr. Stoneham the funds were in a flourishing condition, but the secretary certainly thought they ought in the near future to become more self-dependent. The summer lectures were, if anything, more successful than the previous year. The honey show, in spite of a bad season, proved both successful and popular. In conclusion, the secretary hoped the members would endeavour during the year before them to do their share, and thus ensure still greater progress.

The balance-sheet showed that the receipts for the year came to £17 9s. 4d., and the expenditure to £13 10s. 6d., leaving a balance of £3 18s. 10d.

The following members of the council of the association were elected for the following districts:—Dartford, Mr. Upton; Belvedere, Mr. Nelson; Bexley, Mr. G. P. Baker; Crayford, Mr. Steven-ton and Mr. Firmin; Erith, Mr. Simpson; Rochester, Mr. Bryden; Hawley, Mr. Judge; and Sidcup, Mr. Dewey. The following are vice-presidents:—Mr. J. Roper (Slade Green), Mr. H. Lane (Bexleyheath), Mr. A. M. Fleet (Darenth), and Mr. G. P. Baker (Bexley), while the chairman and president is Mr. E. R. Stoneham.

A lantern lecture was delivered by Mr. W. Herrod, who was listened to with great interest and attention.

Two of the members, it may be mentioned—Mr. J. Roper and Mr. Judge—gained, during the autumn, the third-class expert certificate from the B.B.K.A.

The next meeting of the Crayford and District Bee-keepers' Association will be held at the Parish Room on Monday, December 6.

Correspondence.

The Editor does not hold himself responsible for the opinions expressed by correspondents. No notice will be taken of anonymous communications, and correspondents are requested to write on one side of the paper only and give their real names and addresses, not necessarily for publication, but as a guarantee of good faith. Illustrations should be drawn on separate pieces of paper. We do not undertake to return rejected communications.

AMONG THE BEES.

A GOLDEN RULE.

[7667.] "Swarm from your best stock." We would now say *re-queen* from your best colony, for it must be remembered that we have advanced considerably during the last thirty odd years. Mr. Whyte (page 417), will now, no doubt, subscribe to this universally-taught doctrine in the practice of apiculture. Using the eggs, larvae, or queen-cells from a hive headed by an effete queen would be a suicidal policy. The farmer purchases

at a high price a highly-bred sire, with confidence that it pays. The poultry-breeder is keen on investing in a good strain. Even seeds and plants, to compete successfully at a modern flower-show, must be of a superior type for generations. Those farmers who invested last spring in high-priced seed from a distance secured their corn crops earlier by a fortnight in this wretched autumn than those who used their own effete seed. I might multiply examples, but let these suffice. Now take my own small apiary in the coming season. I know that whatever queens I shall rear—and I trust the season will allow a reasonable success—will all be bred from half a dozen stocks, and possibly from not more than three. My reasons for this preference are framed on sound lines, and I have no doubt the resulting queens will amply justify the selection. This, I think, in brief, is Cheshire's reasoning in the axiomatic quotation selected by Mr. Whyte for special condemnation, by me for special commendation. Viewed thus, few, if any, readers will object to my designating this a golden rule—*Re-queen from your best stocks!*

Influence of Weather on Honey.—Good healthy stores are one of the prime requisites for safe wintering. When these stores are gathered is a point of great importance. Compare clover honey gathered in a fine season during a dry spell of bright, sunny weather with a sample of pure clover collected by the same bees in a cool, dull period of inclement weather, and I venture to assert the veriest tyro would find a distinction and a difference between the two. Possibly they would differ even in colour, and certainly they would in flavour and consistency. Now compare two samples of heather honey. Suppose one has been garnered in glorious August, when Old Sol shines in an unclouded sky, and nectar comes in in an unceasing stream all day long. What a brilliant shade, what a dense gelatinous mass, what a rich and delicious flavour, what a penetrating aroma has this luscious sweet! Now take that gathered on the same hills in a season of gloom and misty vapour. Does not the colour assume a dull, depressing shade, and the density suffer from a partial absorption of the mist? The flavour, if not insipid, lacks its full richness, and the odour is, as it were, diluted. I think, if chemically analysed, it would be found to differ slightly, but I know it has something in its constitution which it should not possess, or it wants something else which it were well it should have. One thing it contains, perhaps because the bees, from climatic conditions over which they have no control, were unable to evaporate it—viz., a superabundance of

moisture. May this be the secret of occasional bad wintering? Does this foreign substance help it to sour, or granulate, or both?

Take Care of the Smoker!—With proper care, the life, or rather the existence, of a smoker may be doubled. I sin in this respect, but I know many worse sinners. Here are some hints: "Give the leather of a new smoker a good soaking of castor oil, and you will find the article wonderfully improved and its life doubled." If the leather becomes hard from being left lying about in all weathers outside, coat it well with vaseline, and then oil it. If it gets hard and dry after being soaked with rain it cracks readily, but with periodic oiling it can be kept in good order. Should one of these cracks open up, the hole can be neatly patched in the way the tube of a bicycle is mended. Even if worn out, a new piece of soft, pliable leather can be purchased cheaply, and any amateur can cut it to shape and tack it on, making the appliance act and look almost as good as new.

When the smoker clogs, scrape the grating with a knife, to allow a full current of air to flow freely out at the nozzle. Scrape the inside when the sooty deposit is dry, and it will fall off in flakes. It may be burned off, with care, but a soaking in warm lye, rubbing the encrustation when moist and rinsing out clean, makes it all right. When a sooty, oily semi-liquid accompanies the outrush of smoke, it is time to clean it out, as this is very nasty when it touches the clean wood of sections, and the bees dislike it about their home, while the bee-keeper should detest blotches of it about his hands or garments. A free-working smoker adds considerably to the pleasures and enjoyments of bee-keeping, and it is worth a little care to keep it in good order.

Crude Criticism.—On page 437 is a sample of the microscopic criticism I banned, I think with good reason. My live-tool (on page 254) *had* one cutting-edge. On page 415 it *has* three. My superfluous critic cannot reconcile the two statements! Why? For both are *facts*. Why waste printer's ink and valuable space on trifles such as these? Mr. Soal can give us something better, and it will be welcome.

There are no "conflicting statements" in what Mr. Crawshaw and myself wrote about cone-escapes. Each of us recorded the fruits of his experience, which perhaps, from using different styles of cones, diametrically differed. My location is not a good one for wasps. I sometimes wish that I had more! With an "overwhelming plague" I know they can play up antics. But this I will say: if they

once went in at a cone of mine they would never again come out alive.

On top of page 416, fourth line should read: "With well-made racks brace-combs should very rarely [not easily] be formed on bottom of sections." The word "easily" is a manifest misprint. The closing paragraph on page 438 is written in a triumphant tone. One swallow does not make a summer, and singling out one good year is no argument. It is a well-known fact that in certain seasons bees will store honey *anywhere*. Even had Mr. Soal secured the same results *every* year, I would rather base my conclusions on my American authority's emphatic testimony, founded on the experiences of a long series of years with an extensive apiary. I never use excluders, but I would not dream of saying to Mr. Soal "Don't!"—D. M. M., Banff.

TITS AND BEES.

[7668.] We have had a wretched season in the Midlands, the honey-dew com-

place over it. There are two compartments, which can be used separately for water, syrup, or candy, as desired. Compartment c is shown arranged for rapid-feeding and d for slow-feeding. The improvement claimed consists of the part marked e, which is the slow-feeding device (E 1) in position, (E 2) removed. In this part there are three slots down which the bees can go, one or more of which may be opened at will by the sliding tin indicator. The feeder is filled by means of a funnel at the holes F F, which are closed by the tin cover shown. Compartments A and B are for disinfectants. In the sketch the side of the feeder is partly cut away to show the internal arrangements.—R. GROSE, Cornwall.

ISLE OF WIGHT BEE-DISEASE (?).

[7670.] I have to thank you for sending me the bees suspected to have died from the Isle of Wight disease, and also for your reference to my investigations (page 421 of B.B.J.). Although I examined the

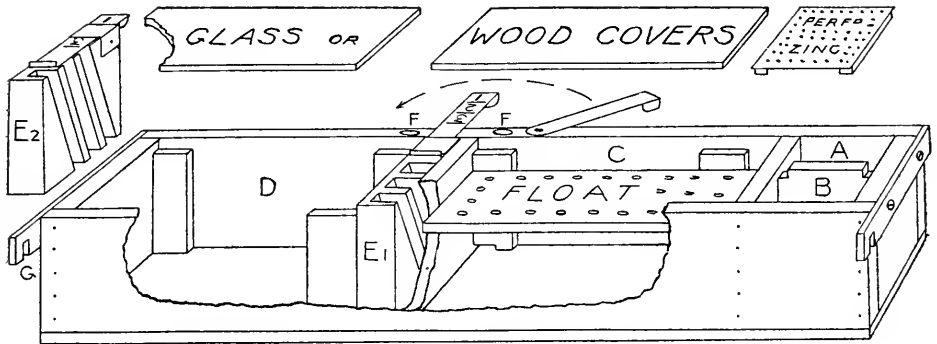

IMPROVED FLOORBOARD FEEDER.

pletely spoiling the sale of honey, and a great many stocks have had to be fed. A good plan to prevent tits and sparrows from doing so much damage to the bees is to place a stick at the side of a few of the hives, with a fork at the top or side. At the bottom of the fork tie a crust of bread, and then, wetting the fingers to prevent them from sticking, rub some birdlime on the stick each side of the bread. Two or three birds caught will act like magic in preventing others from coming near.—A FRIEND OF THE HONEY-BEE, Four Oaks.

IMPROVED FLOORBOARD FEEDER.

GROSE'S COMBINED FEEDER.

[7669.] The above sketch shows the feeder referred to in B.B.J. of September 23 (page 376), which is intended, as explained, to affix to the back of the floorboard (by means of the hooked straps marked G), when the hive-body is slid backwards into

bees you sent very carefully, I could find no *Nosema* spores in them. The symptoms also, so far as I could observe, in the dead bees were somewhat different from those of nosema infection. The chyle-stomach was not white, but brown to nearly black. The absence of spores, however, is not a conclusive proof that the disease is due to another cause. The spores appear in the last stages of the development of *Nosema apis*. The initial stages cannot, however, be recognised in dead bees, as the vegetative stages change very rapidly after death. To see them, the chyle-stomach of a live diseased bee must be carefully dissected and preserved in a solution of mercuric chloride, and then very thin sections made of it. At this stage of the disease the chyle-stomach has not undergone any change, but the intestine is filled with faecal matter, just as in the bees you sent from the Isle of Wight. It is quite possible, therefore, that they may be in the earliest stages of

the infection. This is only a supposition, as the bees you sent did not admit of a more critical examination. I hope this communication may be of some service to you. Perhaps there is someone in your country who will investigate the disease from this point of view. I am quite willing to co-operate for the purpose of solving the question. For your assistance, I am sending you some bees that are virulently infected with *Nosema* spores.—DR. ENOCH ZANDER, Erlangen.

[We sent Dr. Zander bees suspected to be diseased from the Isle of Wight, Hampshire, Bucks, Derbyshire, and Middlesex, but as they were dead he was not able to make a satisfactory examination of them. On examining the bees which Dr. Zander has kindly sent us, we find the chyle-stomach to be milk-white, characteristic of the infection with nosema.—ED.]

BEEES IN HANTS.

[7671.] I should like to let your readers know how bees have fared in this part of Hampshire during the season of 1909. As far as honey gathering is concerned, it has only been fair, my average being 20 lb. per hive, and much of this honey was tainted with honey-dew.

The honey gathered here in May was very good both in colour and flavour, and that obtained during the first and second weeks in August was very similar. I took two stocks to the heather, and secured some 30 lb. more surplus. The hives were brought home on September 25 and placed on their stands, but were not examined until some ten days later to see what their condition was as regards stores, queens, &c., before packing down for winter. I found, when making this examination, the queen being "balled," and exactly the same thing occurred last year under the same circumstances. I did not save her last year, but this time I was looking for the occurrence. I immediately caged her as soon as "balling" commenced, and introduced her so that the bees might liberate her when all was quiet. What is your opinion of queen-"balling"? Do you think it is likelier to occur when there is no brood or eggs in the hive?

I think there are very few queens laying in this neighbourhood now, but hives in general are well stocked with bees and stores. I have not given my bees an ounce of food, but in 1907 I fed in hundredweights. My best stocks this season were headed by pure Italian queens imported direct, and I cannot speak too highly of them for work in supers. This is my second year's experience with Italians and my ninth year of bee-keeping on modern lines, and I find these bees just right for early districts; they quite left my blacks in the rear, although all were nearly equal at the start. I have im-

ported sixteen queens this season, so intend to give them a good trial. If your correspondent in Sunderland (page 384) is so disgusted with Italian bees, I am willing to send him blacks in exchange for his pure Italian queens. The bad points he complains of I have yet to discover, but am not over-anxious to do so. I know of bee-keepers who "scorn the foreign yoke" (bee), but it is quite possible that they owe the working qualities of their own stock to some enthusiastic or enterprising fellow bee-keeper who has introduced the foreign blood into their district. I am not going to say that the native bee is to be condemned, but I prefer Italians to any other race.

It has been an exceptionally bad year for queen rearing and mating. I have had several queens in nuclei mated seventeen to twenty-one days after being hatched, and two did not mate at all, owing to strong winds that prevailed during the last week in April and beginning of May. Wishing your valuable B.B.J. all due success and a better season for 1910.—HORACE H. HALL, Bishop's Waltham, Hants.

SCRIPTURAL BEES AND HONEY.

[7672.] My previous letter, written with a desire to interest bee-keepers in the ancient literature of our cult, has been honoured with an editorial. I have only ventured to seek information from the tablets and parchments of man (save the inspired writings of Scripture), but our Editor goes deeper. He brings into evidence those "sermons in stones" written by the Great Architect. It would be interesting to study this subject. There are several great thinkers who have written copiously of that period when vegetables and animals became fossilised, but I have enough matter for the present, and I can live in the hope of coming back at a future date to their interesting chronicles.

To come back to my first love. Apart from its value as an historical work and the *lex scripta* of Christianity, the Bible also has high merit as a book written in singularly beautiful and poetical language; and naturally so, for it was written by kings and prophets, scholars of an Eastern race, whose kindling eye and dusky cheek reveal the romantic soul. Kindred to that nation for whom Mahomet wrote the Koran, their ideals are not to be measured by the cool temperament of a Northern people; consequently Holy Writ abounds in simile and metaphor. When spies were sent to search the Promised Land, they, returning, spoke of it as a "land of milk and honey," and so apt was the comparison that we find it used in sixteen similar cases, as, for instance, "a land of milk and honey," of

"olive, oil, and honey." and in Job xx. 17: "He shall not see the brooks of honey and butter"; and Jeremiah xli. 8: "We have treasure of honey in the field."

We might search in many books, lands, or tongues for word-pictures which could portray so vividly scenes of verdant plains deep with pasture, rich with flowers, wandering lowing kine, woods jewelled here and there by the deeper green of the olive-gardens, and in due season by the brighter colours of the orchard. But methinks I hear the bee-man, who is eminently practical, asking: "This wonderful honey-flow—what facilities had they for gathering it? Did they know anything of our bee-lore?" Here, again, is an interesting study.

Although reference is so frequent to honey, of the bees but little is said. One of the best known is the story of Samson, who, meeting a young lion in his path, rends him in twain, hurling on either side the divided carcase. Returning in a few days, he finds in one of the portions a swarm of bees and a honey-comb. We are accustomed each spring to see in the BEE JOURNAL records of "swarming vagaries," yet none so strange as this. But this narrative almost seems to have an affinity with Virgil's description of the mode of procedure in order to create a swarm of bees. You are told to take and kill a steer of two years, strew it with flowers,

Broken boughs and thyme
And pleasing cassia, just renewed in prime.

The tainted blood, in this close prison pent,
Begins to boil, and through the bones ferment.
Then, wondrous to behold, new creatures rise,
A moving mass at first, and short of thighs.

The grubs proceed to bees with pointed stings.

That perhaps used to happen when butcher's meat was cheaper than bees now. "A steer of two years old" is much dearer than a swarm of bees.

What a veritable mystery the interior life of the hive, the "increasing and multiplying," was to the ancient writers! In his history of animals, "De Animalibus Historia," Aristotle writes in Greek (I am tempted to give the title in the original, but am uncertain of the Greek type in stock at the BEE JOURNAL's printery) [There is plenty of it.—ED.], but he is in a "fearful fog." He claims for bees divine origin, they have such wisdom; but he is careful—"he has his doubts," as they say north of the Tweed. "All are not of the same opinion" are his words. There is the theory that bees are created without generation. "Some, indeed, deny the intercourse of the sexes, and that they bring forth, some say, their young from the branches or from reeds; others, again, from the olive flowers." But,

there, I am digressing. Aristotle is quite worthy of a chapter to himself, and, the BEE JOURNAL being willing, I may at a future date inflict him on its readers.

A remarkable expression occurs in Isaiah vii. 18: "And it shall come to pass in that day that the Lord shall hiss for the fly, and for the bee that is in the land of Assyria."

Who would recognise in this garb the antecedent of the frying-pan and doorkey symphony? But it was the custom to "hiss" a swarm to induce it to settle, accompanied also by the beating of earthenware vessels, as Pliny states. And the context prophesies abundance, "for butter and honey shall everyone eat that is left in the middle of the land," because, in response to this call, "they shall come, and shall all rest in the torrents of the valleys, in the holes of the rocks, all places set with shrubs, and all hollow places." Wild bees must have been exceedingly numerous, for in many places allusion is made to "honey out of the rock."—J. SMALLWOOD, Hendon.

HIVE-SCRAPING TOOL.

[7673.] With regard to the recent discussion in the B.B.J. on one-, two-, or three-edged tools for scraping frames, &c., and their manufacture, the following may be of interest. Passing along a street recently I noticed a painter scraping off the old paint from wood with a triangular three-sided tool with sharp edges, upright, and with handle attached. I asked the name of his tool, recognising it as the very thing for bee-keepers, and learnt it was a "painter's shaving-hook." In a very few minutes I had been the round of the ironmongers, and at one of them obtained the desired article at a cost of 8d. The hint may be of interest to other "scrapers" as well as myself.—CRYP, Sleights.

THE "FREE-WAY" EXCLUDER.

[7674.] As information for your correspondent "A. P., Sussex" (7652, in B.B.J. of October 28), I beg to say I have during our last miserable honey season used the "Wilkes' Free-way" excluder, and although my gross takings of honey were much below average, I am pleased to say the two hives so fitted gave me my best show frames and honey; they were also the heaviest racks of an otherwise poor lot. But, as my experience so far goes (and I have also used the same wire principle of fence separators, with excellent results), I am quite prepared to fit all my hives with them in future. The freedom with which one can see down among the frames when this excluder is on is very marked, and often avoids the necessity of removal when examining stocks. The

bees' passage through the smooth bars, whether vertical or horizontal, is also very striking, and was often noticed and commented on at our county show, where I had my observatory-hive fitted with one of these excluders.—DINGLE, Chester.

SOPHORA JAPONICA.

[7675.] With reference to the letter (7608) in your issue of September 23 last, over the signature "P. Hilarbor," I think it right to warn your readers not to be in any hurry to plant *Sophora japonica* in the hope that it will flower in their lifetime. Experts with an experience of over forty years, I am told, have never seen one in flower—in England, at least.

There are some at Kew, I am informed, over a hundred years old, which bloom fairly regularly, but which, like many other blossoming trees, failed this year.

It would be hopeless to expect flowers on trees less than thirty or forty years old at the least.—DULWICH.

Echoes from the Hives.

"I find Carson's 'Plastine' painted over an excellent preparation for stopping up cracks in the roofs of hives."—F. H. F., Gloucester.

"The season here has been better than some readers of the BEE JOURNAL have experienced, though not on the whole up to the average. One bee-keeper, however, got 120 lb. of honey (including some sections) from one stock, besides a swarm. This, I think, quite beats the average, especially as the honey was free from honey-dew."—F. A. MORTON, Latchingdon, Essex.

Queries and Replies.

[3977.] *Books on Bees.*—I shall be up in London till next spring, and I wish to spend my spare time in reading old and modern books about bee-keeping, and also in trying to find out as much as I can about other species of bees. I have asked for a permit to photograph the bees in the Natural History Museum; till I get the permit I am trying to find out how many species there are and their names. I have looked through four dictionaries and a good many books on bee-keeping, and all the authors give about three names and then end up with "&c." In "The Honey-Bee" it is stated that there are nineteen genera, but only three are mentioned. I also saw in another dictionary that there were forty species of *Bombus*, and in Cheshire's "Bees and Bee-keeping" that there were sixteen

species of *Apis*. I quite understand that it would be hopeless to give the whole list of bees in one book on bee-culture in general, but I should like to know of some book or some person who could tell me the rest. So far, of the *genera*, I have got the following:—*Bombus*, *Xylocopa*, *Apis*, *Osmia*, *Megachile*, *Colletes*, *Prosopis*, *Sphecodes*, *Halictus*, *Andrena*, *Nomada*, and *Anthophora*. The total is twelve, out of the nineteen. Of the genus *Apis* I have got *mellifica*, *fasciata*, *dorsata*, *ligustica*, *Adansonii*, *unicolor*, *caffra*, *scutellata*, *nigritarum*, *indica*, *florea*, *zonata*. Total twelve, out of the sixteen. Of the genus *Bombus* I have got *terrestris*, *lapidarius*, *muscorum*, *pratorum*, *elegans*, *subterraneus*, *virginialis*, *vestalis*, *apathus*. Total nine, out of the forty. Would you be so good as to tell me whether the above-mentioned names are right, and also in their proper orders (*genera*); and also tell me of any book that I can obtain which mentions the remaining hundreds, or, if there is no such book, could you give me the name and address of any bee-keeper you know who does possess all this list of names? An answer in B.B.J. would oblige—W. G. COATES, London, S.W.

REPLY.—Books on bee-keeping are generally confined to the honey-bee, and other bees are only mentioned incidentally. "The Honey-Bee," as its title indicates, deals with this insect only, and in the table three names are given simply as examples of *genera*, although there are a great many more, and, including foreign *apidae*, over fifty. There are fifteen species of *Apis*, although only one—viz., *mellifica*—is indigenous to Great Britain. It would take too much room to print a complete list of all the *genera* and species, and we would refer you to the catalogue of hymenopterous insects in the collection of the British Museum, by F. Smith, Part I., *Andrenidæ* and *Apidæ*, and Part II., *Apidæ*. In addition to this there is "Descriptions of New Species of Hymenoptera in the Collection of the British Museum," by F. Smith. This contains a list of all *genera* and species not enumerated in the other two books. There is also the catalogue of the British Hymenoptera *Aculeata*, by F. Smith, published by the Entomological Society of London. To your list of genus *Apis* add *socialis*, *delessertii*, *Perottetii*, *Peronii*, and *lobata*. *Florea* and *zonata* belong to other *genera*. F. Smith mentions seventy-nine species of *Bombus*, *virginialis* being syn. of *lucorum*, and *vestalis* that of *apathus*, or *psithyrus*. *Elegans* and *apathus* belong to other *genera*. For studying British bees you could refer to Shuckard's "British Bees" and to the more recent work by E. Saunders, "The Hymenoptera *Aculeata* of the British Islands." You

could also consult "Monographia Apum Angliæ," by W. Kirby, published in 1802 in two volumes.

[3978.] *Extracting Honey*.—I shall be glad to have your opinion upon the following *re* extractor. I had two racks of shallow frames, the gross weight being 72 lb. After extracting, racks and frames weighed 25 lb., and after giving them to bees to clean up, the weight was 12 lb. This shows that the quantity of honey left in combs after going through extractor was 13 lb. It seems to me to be too great a quantity to lose, and I took all out I could by continuous and prolonged driving. The "Guide Book" says a few turns ought to clear the combs. Is it, then, the fault of the extractor (no multiplying gear), or is it, as I suspect, because combs are too thick in consequence of having used the long metal ends? Would not a better result be obtained if the ordinary length metal ends were used? Your remarks will be appreciated by—AMATEUR SCOT.

REPLY.—Too much honey was left in the combs, and it is evident from this that the temperature was not high enough to make the honey flow freely. Probably the combs were not extracted as soon as they were taken from the hives and while still warm. If not extracted at once when removed, supers should be brought into a warm room the temperature of which should be over 90 deg. Fahr. At this temperature honey becomes thinner and leaves the combs more easily. The combs are not too thick, as they are cut down level with the frames when uncapped. More honey is obtained by using the thicker combs, and there is less wax used, as there are only eight midribs instead of ten of the thinner combs. An extractor with multiplying gear is certainly more rapid and efficient than one not geared.

[3979.] *Bees Refusing to Work in Sections*.—Can you or any of your readers tell me how it is I am unable to get my bees to go into the sections? I have kept bees for three years, and have three hives placed in different parts of London and the country, and instead of putting honey in the sections they would keep swarming, although I have done all I can to prevent it. I may mention that I wrapped up the case containing the sections with plenty of warm material, as I thought that cold might be the cause. Hoping to see a reply in your interesting BEE JOURNAL.—A. M., Colchester.

REPLY.—Several reasons may prevent bees from working in sections: 1. The racks may not be put on at the proper time, and when bees have once commenced preparations for swarming it is very difficult to prevent them from doing so. It is as detrimental to put on the

sections too soon as not soon enough. 2. The sections may not have been kept warm enough. 3. The colonies not being strong enough at the right time and having plenty of room below. 4. Scarcity of forage and bad weather. 5. Improper treatment of the swarms, which should have the sections placed on them as soon as hived, the swarm taking the position of the parent hive. This prevents further swarming and induces bees to work in the sections.

Notices to Correspondents.

J. M. (Pembroke).—*Best Material for Quilts*.—There is nothing better than a layer of unbleached calico, with a chaff cover, as recommended on page 191 of "Guide Book," for which a shallow-frame super can be used. If you prefer, you can put several layers of felt on the calico instead of the chaff cover.

S. A. M. (Brixton Hill).—*Detecting Foreign Honey*.—It is possible to do so when it is gathered from sources not available in this country. It can frequently be detected by its appearance, granulation, aroma, and the pollen-grains found in it.

LEARNER (Eccles).—*Feeding with Candy*.—1. If you can push the candy under the quilt you need not smoke the bees. 2. Presuming that the bees have insufficient stores, candy should be supplied when the previous lot has been consumed. 3. In strong colonies breeding usually commences in January.

W. E. M. (Natal).—*Sterilising Wax*.—For the certain destruction of spores of foul brood it is necessary to heat wax to a temperature of 212 deg. Fahr. for two and a half to three hours, according to their age.

D. H. (Abington, N.B.).—*Candy as Winter Food*.—1. The candy will do, but it is not so fine in the grain as it should be. 2 and 4. Bees winter better on good thick honey or syrup than they do on heather honey. 3. Syrup is best, but candy is given as a makeshift to repair the neglect in supplying syrup at the proper time.

CONSTANT READER (Worcester).—*Studying Foul Brood*.—1. You have done right in destroying the bees, as the combs sent are affected with foul brood. 2. You can just see bacilli with a $\frac{1}{3}$ th object-glass, but a $\frac{1}{2}$ th oil-immersion objective is the one generally used for their study.

BEE (Epsom Downs).—*Bees Cast Out*.—There is nothing the matter with the three bees sent except old age, from which they have apparently died, and they were all filled with sweets.

F. V. W. (Gloucester).—*Plants for Bees, and Queen-rearing.*—1. If colonies are worked on the principle explained on page 62 of "Guide Book," excluder-zinc is not necessary, although it may be used. Anything placed between brood-nest and supers impedes work to a certain extent, but the advantages of using excluder exceed the disadvantages. You were fortunate in that the queen did not go up into your sections, but you cannot make sure of her not doing so unless you use an excluder. 2. Box is useful for pollen and yields a little nectar. *Phacelia tenacifolia*, *Limnanthes Douglasii*, and borage are all excellent nectar-yielding plants. Laurestinus is of no value to bees, as it is a winter-flowering shrub. 3. What is said in "Guide Book" about Italians is quite correct, but for all that they are not suited for all districts, and their early development is sometimes detrimental. Crosses, as a rule, are more vicious, but better workers. If you had a pure fertilised queen you would not require to place drone-excluder over entrance to keep her pure, and any young queens reared in hive would have to fly out to meet a drone. 4. You can raise queens in the way you propose so long as each nucleus is separated with close-fitting division-boards and contains the right sort of combs—viz., one of honey and pollen and two of brood.

H. A. V. (Rye).—*Storing Combs.*—1. If you can preserve your frames of comb in a dry, warm place, they would be useful for spring feeding. 2. As you have no extractor, please refer to answer to "G. S. S. S." on page 440 of B.B.J. for November 4.

W. J. S. (Hoyland).—*Caterpillar in Combs.*—1. No doubt it is the larva of the large wax-moth, *Galleria cereana* (page 165 of "Guide Book"). 2. Barbados sugar is not suitable for bee-food at this time of the year. You should give the bees candy made from white cane sugar, placing it on the top of the frames, and renewing it when used up. Frames can be filled with candy and put next to the cluster.

J. B. C. (Loughborough).—*Successful Candy-making.*—The candy of "C. B., Little Onseburn," was made by carrying out the instructions given in "Guide Book," page 195. We suppose in ninety-nine cases out of every hundred the candy is properly made, and it is only when there is something wrong with it that it is sent to us for our criticism, the successful cases not coming to our notice at all.

AMATEUR (Market Harborough). — *Echinops phærocephalus.* — Opinions differ as to the honey-yielding proper-

ties of this plant, some readers having tried it with disappointment. On the other hand, many have written favourably of it, and it seems to be a plant that differs greatly in its nectar-secreting properties according to the soil it is grown in.

G. M. (Hindhead).—*Bees Cast Out.*—Common black bees. They are quite dried up, and have evidently been dead some time. It is impossible to say if they are healthy from the five bees you have found dead; but you should watch the colony, and if you notice any great mortality send a few live, but dying, bees for examination.

J. M. (Hampstead).—*Transferring Bees from Straw Skeps.*—You cannot transfer bees from straw skeps at this time of the year. When the skeps arrive, place them on the stands they are intended to occupy, and allow the bees to fly. Protect them from the weather, and in the spring let them transfer themselves to frame-hives in the way described on page 149 of "Guide Book."

H. F. (Offord).—*Winter Bee-food.*—Sample resembles barley-sugar, and though it can be used for bees, it is not so suitable a food as soft candy.

G. F. Y. (Pembrokes).—*Cane Sugar.*—The sugar is lacking in sweetness, and we should say it is not cane, but beet sugar. If you cannot get any other you must use it, but there is risk of causing dysentery and other ailments among the bees.

Honey Samples.

C. J. B. (Brooklands).—A rather thin honey, principally gathered from limes. It contains a very small admixture of honey-dew, but is quite palatable and wholesome. Its unattractive appearance and poor consistency make it worth only a low price.

J. G. N. (Langwathby).—Sample is a mixed blend from heather, lime, and other sources. The colour and lack of density are quite unlike honey gathered from ling, while the rich flavour is very much more pronounced in real heather honey.

F. A. A. (Tunbridge Wells).—Honey of inferior quality from fruit blossoms principally. It is contaminated by honey-dew.

Suspected Combs.

R. R. (Northumberland).—Comb is unmistakably affected with foul brood.

A. R. M. (Worcester).—The stock is suffering from foul brood.

*** Several important letters, &c., are in type, but held over from pressure on our space.

Editorial, Notices, &c.

BRITISH BEE-KEEPERS' ASSOCIATION

The monthly meeting of the Council was held on Thursday, November 18, in the board-room of the R.S.P.C.A., 105, Jermyn Street, when Mr. T. W. Cowan presided. There were also present: Mr. T. Bevan, Mr. C. L. M. Eales, Mr. O. R. Frankenstein, Mr. E. Gareke, Mr. J. B. Lamb, Mr. W. F. Reid, Mr. A. Richards, Mr. G. H. Skevington, Mr. E. D. Till, Mr. E. Walker, Colonel H. J. O. Walker, and Mr. W. Herrod (acting secretary).

Letters expressing regret at inability to attend were received from Miss Gayton, Mr. H. Jonas, and Mr. A. G. Pugh.

The minutes of Council meeting held October 7 and of special Council meeting held October 13 were read and confirmed.

The Chairman explained that after the last Council meeting Mr. Reid wrote to Mr. W. C. Young requesting him to hand over the books and other property of the Association to Mr. Herrod, in accordance with the resolution passed at that meeting, and he got his brother's (Mr. E. H. Young's) authority for doing so on October 18, but since then nothing had been heard from Mr. W. C. Young, and although he (the Chairman) as well as Mr. Herrod had written to him, no notice had been taken of any of these communications. The business of the Association had practically come to a standstill, and as Mr. Herrod could not get access to the books it was not possible to notify the representatives of the county associations of the present meeting, as the list was in Mr. Young's possession. Mr. Young had not been to his office from October 22 to November 15, and only sent on the accumulated correspondence on the 16th. As nothing could be done without the books, he (the Chairman) came up to London to see Mr. Young on the 16th, and as he was not at the office he wrote to his private address, appointing the next morning for a meeting, pointing out that the Council would meet on Thursday and that the Finance Committee would require him to present a statement of accounts since the last meeting. He was not at the office at the appointed time, but he (the Chairman) was able to see him later, and obtained the bank pass-book and statement of receipts, and an undertaking to send on the other books. Mr. W. C. Young resented the letters which he (the Chairman) had written, and expressed no regret for the inconvenience which he had caused by detaining the correspondence and property of the Association. He hoped this explanation would enable those whose letters had not been answered to understand the difficulties with which the

Association had had to contend. It would be necessary to arrange for another examination in consequence of the letters being detained by Mr. Young until after the examinations had been held, and great inconvenience had been caused by Mr. Herrod not being able to get at the necessary papers.

The Chairman having read the correspondence, it was moved by Mr. Reid, seconded by Colonel Walker, and carried unanimously, "that this Council, having heard the letters written by Mr. Cowan on behalf of the Association, hereby confirm the action of the Chairman."

The report of the Finance Committee was presented by Mr. Eales, showing an available balance in bank of £60 15s. 10d., and cheques were drawn for £46 12s. 6d. for payment of salaries and other accounts. The Chairman stated that the account was a provisional one, as he had only received the cash book that day, and had not received the petty cash book or other books necessary to check the accounts. He had been to the bank, and had found the balance as stated correct. He had also invited Mr. Young to attend the Finance Committee meeting, but he had not done so or given any explanation.

The report of the special committee appointed October 7 "to consider generally the present position of the B.B.K.A., and to report what measures should be taken to improve the same," was presented, and it was moved by Mr. Gareke, seconded by Mr. Reid, and carried, that it be received. It was also resolved that copies be sent to every member of the Council and representatives of affiliated associations, with a view to its consideration at the next meeting of the Council, and that the committee be thanked for their work.

The Secretary reported that twenty-four candidates had entered for the second-class examination.

The following new members were elected:—Mr. J. E. Lockwood, School House, Hunstanton North; Mr. J. H. Marshall, Cavena, Crockenhill, Swanley, Kent; Mr. G. M. Armstrong, Hardriding, Bardon Mill, Northumberland; Major E. Barnes, Winton Hill House, Stockbridge, Hants.

The Chairman stated that the Royal Agricultural Society required the schedule arranged for the show at Liverpool in 1910, but as they had not been able to get at the papers he could not bring the last schedule before the Council for suggestions, and recommended that a committee be appointed to deal with it. It was resolved to leave the matter in the hands of the Chairman and Secretary.

An application was read from Lancashire B.K.A. to be allowed to have a class for Lancashire honey at the show, and it

was resolved to allow this on the same terms as the Lincs B.K.A. in 1907.

Proposed by Mr. Reid, and seconded by Mr. Lamb, that as the Council no longer require the use of 12, Hanover Square as their address, the Chairman be requested to give Messrs. E. H. and W. C. Young notice to this effect, and to have the board removed and sent to Mr. Herrod, with the remainder of the property of the B.B.K.A.

The Chairman read a communication from the Natal B.K.A. respecting examinations, and was authorised to draft and send reply with the papers asked for.

The Chairman stated that the W. B. Carr Memorial Fund now amounted to £60 12s., and it was decided to keep it open till the end of the year in case of anyone wishing to contribute towards it.

Proposed by Mr. Skevington, and seconded by Mr. Till, that the Council accept with pleasure the offer of the treasurer of the Medical Society of London to allow the use of 11, Chandos Street, Cavendish Square, W., as the official address of the Association, and to permit the Council meetings and conversaciones to be held there in future.

Mr. R. H. Coltman attended to lecture before the Council on a subject, prescribed at the time, connected with apiculture, and it was resolved to award him a first-class certificate.

The next meeting of the Council will be held on December 16.

W. B. C. MEMORIAL FUND.

Amount already acknowledged	£	s.	d.
G. Thomas	59	5	0
W. A. Simkins	0	5	0
J. Nightingale	0	2	6
C. P. Hawkes	0	2	6
W. Freeman	0	2	6
J. Rowlands	0	2	6
R. Gray	0	2	6
A. Firkins	0	2	0
S. Dennis	0	1	0
H. J. Feingbell	0	1	0
	£60	12	0

DEVON B.K.A.

ANNUAL SHOW.

In conjunction with the Devon and Exeter Horticultural Society's exhibition, the Devon Bee-keepers' Association held their annual show of honey, &c., in the Lower Market, Exeter, on Thursday and Friday, November 11 and 12.

Notwithstanding the bad season and the prevalence of honey-dew this year, the exhibits were of splendid quality, the strongest class being that for light extracted honey.

Several interesting objects connected more or less with apiculture were on show, attracting considerable attention, one being an azalea bush in which a swarm of bees had built their combs, exhibited by Mr. McCullah, of Dunchideock. An observatory-hive was shown by Mr. Southcott, of Gittisham, and a nest of hornets by the hon. secretary, Mr. R. W. Furse, Woodbury.

The judge (Dr. Phillpotts, of Kingswear) pronounced as excellent the exhibits of confectionery in which honey was used as an ingredient, and hoped to see a larger class next year. The mead was also very good, and Dr. Phillpotts expressed surprise that more was not made, it being such an excellent and wholesome cordial.

The show was well attended by members and friends from all parts of the county, and was very successful. The following were the awards:—

Six 1-lb. Sections.—1st, W. T. Trineman, Saltash; 2nd, R. H. Baynes, Cambridge; 3rd, A. J. Brooks, Stockbridge; v.h.c., J. Salt, Saltash; h.c., A. McCullah, Dunchideock.

Three Shallow Frames of Comb Honey.—1st, R. W. Furse, Woodbury.

Best Single 1-lb. Section.—1st, J. Salt; 2nd, Miss Burr, Ebford, Topsham; 3rd, A. McCullah.

Six 1-lb. Jars Light Honey.—1st, W. T. Trineman; 2nd, T. G. Leigh, Broughton; 3rd, A. J. Brooks; v.h.c., W. Sherwood, Stockbridge; h.c., J. Salt.

Six 1-lb. Jars Medium-coloured Honey.—1st, C. Squire, Morteohoe; 2nd, W. T. Trineman; 3rd, C. R. Lowe, Bolham, Tiverton; v.h.c., J. Salt.

Six 1-lb. Jars Dark Honey.—1st, W. T. Trineman; 2nd, R. W. Furse; v.h.c., J. Salt.

Six 1-lb. Jars Granulated Honey.—1st, C. Squire; 2nd, R. W. Furse; 3rd, Miss Tavender, Woodbury Salterton.

Beeswax.—1st, A. Hiscock, Kettering; 2nd, R. Morgan, Cowbridge; 3rd, W. Tucker, Bickington, Chulmleigh; v.h.c., Miss Tavender; h.c., C. Squire.

Amateur Hive.—1st, A. McCullah.

Mead.—1st, R. W. Furse; 2nd, C. Lowe.

Natural History.—1st, R. W. Furse; 2nd, A. McCullah.

Confectionery.—1st, Miss Tavender; 2nd, F. W. Hunt, Tipton St. John.—R. W. Furse, Hon. Sec.

CROYDON AND DISTRICT B.K.A.

ANNUAL SHOW.

The above association held its annual show at the Horniman Hall on September 8, and in spite of adverse weather there was a good attendance of members and friends. The honey shown totalled

400 lb.—a very creditable display considering the poor honey-season.

From reports of members at the show, it appears that those apiaries located among fruit and lime trees have done much better than those in country clover districts, two or three instances being mentioned of "takes" of 50 lb. or 60 lb. from single hives where fruit and lime trees are plentiful.

Mrs. Seadon, of Bromley, Kent, and Messrs. Jas. Lee and Son, of Highbury, London, both staged good collections of the most up-to-date bee-appliances, which were much admired.

Mr. H. W. Brice acted as judge, and made the following awards:—

Display of Honey, suitable for a tradesman's window.—1st, C. D. Parish, Addington.

Six Sections of Comb Honey, gathered within three miles of the Town Hall.—1st, A. E. Barnes, Anerley; 2nd, G. T. Horn, Croydon; 3rd, J. Dotteridge, Croydon; c., G. Lowery, Croydon; H. Tobutt, Wallington.

Six Sections of Comb Honey.—1st, A. Wood, Mitcham; 2nd, C. D. Parish.

Six 1-lb. Jars Run Honey, gathered within three miles of the Town Hall.—1st, W. G. Fischer-Webb, Croydon; 2nd, W. J. Knott, Croydon; 3rd, A. E. Barnes; h.c., W. R. Allen, South Norwood; c., J. F. L. White, Elmers End.

Six 1-lb. Jars Light-coloured Extracted Honey.—1st, A. Wood; 2nd, F. W. Watts, Dulwich; 3rd, W. G. Fischer-Webb; c., C. D. Parish.

Six 1-lb. Jars Medium-coloured Extracted Honey.—1st, W. J. Knott; 2nd, A. E. Barnes; 3rd, W. G. Fischer-Webb.

Six 1-lb. Jars Dark-coloured Honey.—1st, Miss W. Benzon, Sanderstead Hill; 2nd, H. Tobutt; 3rd, W. G. Fischer-Webb; c., J. F. L. White and A. Wood.

Six 1-lb. Jars Granulated Honey.—1st, H. Tobutt; 2nd, C. D. Parish; 3rd, Rev. C. H. Buxton, Thornton Heath.

Two Shallow Frames.—1st, H. Tobutt; 2nd, Rev. C. H. Buxton; 3rd, A. E. Barnes.

Three Shallow Frames.—1st, H. Tobutt; 2nd, A. E. Barnes; 3rd, F. W. Watts.

Beeswax.—1st, W. G. Fischer-Webb; 2nd, A. E. Barnes; 3rd, W. J. Knott.

One Shallow Frame, Two Sections, and Two 1-lb. Jars of Run Honey.—1st, H. Tobutt; 2nd, A. E. Barnes.

Single 1-lb. Jar Extracted Honey.—1st, A. E. Barnes; 2nd, W. G. Fischer-Webb; 3rd, C. D. Parish.

Single Section of Honey.—1st, C. D. Parish; 2nd, Mrs. Hewitt, Purley; 3rd, G. Levry.

Observatory-hive with Bees and Queen.—1st, A. Wood; c., G. T. Horn.

Objects of Interest in Connection with

Bee-keeping.—1st, G. T. Horn; 2nd, A. Wakerell; 3rd, F. W. Watts.

Best Exhibit of Food in which Honey is the Chief Ingredient.—1st, Mrs. A. Wood; 2nd, Mrs. A. Wakerell; 3rd, Mrs. Hewitt.—(Communicated.)

Correspondence.

The Editor does not hold himself responsible for the opinions expressed by correspondents. No notice will be taken of anonymous communications, and correspondents are requested to write on one side of the paper only and give their real names and addresses, not necessarily for publication, but as a guarantee of good faith. Illustrations should be drawn on separate pieces of paper. We do not undertake to return rejected communications.

HEATHER SECRETION.

[7676.] The question of the secretion of nectar and the influence of atmospheric conditions on its production is one which must always have a considerable interest for bee-keepers. It was thought that some observations which have been made on this subject might be of interest to the readers of the B.B.J.

Before any conclusions can be formed one must have some definite data to work on, and it appeared to me that the simplest method was to record the daily changes in weight of a good average colony, and that at the same time an observer should be in the locality to record the atmospheric conditions, and note also the hours and nature of flight of the bees, and any other observations that might bear on the question. I accordingly arranged to keep such a record during the heather harvest of 1909. Mr. J. N. Kidd kindly volunteered to take observations from August 17 to 29 while he was staying on the moors, and the writer is responsible for those made from August 29 to September 18.

The heather flow is a particularly good one to study, as its secretion is notoriously intermittent, being sometimes slight and at others extremely heavy, and also because when bees are at the moors the heather is the sole source of any nectar gathered. Where there are several plants in flower at the same time the problem is naturally much more intricate.

The observations made by Mr. Kidd and myself have entirely upset many of our personal preconceived ideas of heather secretion. This may be largely due to the abnormal season, the heather harvest in the North of England and Scotland having been practically a dead failure, and certainly the worst for many years. Not only has the weather been bad, but the heather itself has not grown as much or been as full of flower as in other years. As the chart on page 465 shows, there was only a heavy flow on four days in the

period under review—namely, on August 27, September 2, 3, and 5. Yet no single day was a good one from the bee-keeper's standpoint.

On August 27 the maximum shade temperature was only 61 deg. Fahr.; the wind from the N.W. The bees worked from 8 a.m. to 5 p.m., but the work was stopped several times owing to the passage of banks of clouds. The scales showed a gain of 6½ lb. from the weight of the previous evening; probably, if the night loss is allowed for, the gain may be taken to have been one of 7 lb.

September 3 was the best day, showing a gain of 10 lb. The day began with a very heavy hoar frost, a shade temperature of 34 deg. Fahr. rising to 58 deg. Fahr. at midday. The wind was due north and very cold, so that, in spite of a cloudless sky until 2 p.m., it was too cold to sit in the open air unless sheltered from the wind. The bees began gathering at 8 a.m., with a shade temperature of 48 deg. Fahr., a very heavy flow continuing until 10 a.m., when the temperature had only reached 52 deg. Fahr. After this the nectar intake rapidly slowed down, though carried on until 3 p.m. A suspicion of north wind or a hoar frost we had always regarded as fatal to heather-secreting.

September 3 proved milder, but the wind was in the north-west, intermittent sunshine culminating in a heavy shower at 1 p.m. Honey was gathered from 9 a.m. until 1 p.m., and a gain of 8¾ lb. was shown.

September 5. Minimum temperature, 38 deg. Fahr., rising to 58 deg. Fahr. Wind, N.E. veering to N.W.—a cold, biting wind, but light. The day began with a brilliant sun, which became overclouded at noon. The bees worked from 7.15 a.m. until 3 p.m. Gain, 7 lb.

On September 2, 3, and 5 the bees were noted to be coming in until 10 a.m. with fully-distended honey-sacs, many falling short of the alighting-boards, and those on the outskirts of the alighting-boards having to rest before they could walk into the hive. After this, although they worked freely, they returned to the hives with obviously very much lighter loads, not alighting until just at the entrance and then scurrying in in the active way we know so well. On none of these days was the temperature above 52 deg. Fahr. until after 10 a.m., when the flow had markedly lessened.

These observations suggest that the possibilities in the gain of weight in a working day with ideal climatic conditions must be very large—possibly double the amount recorded on the best day under observation. They also suggest the tremendous quantity of nectar available

from a small area of a heather moor, as one ton must have been gathered on that day by the hives within half a mile of the one on the scales, if 10 lb. was the average gain per hive.

Temperature.—The temperature during the period under review was extremely low for the time of year, the maximum recorded being 63 deg. Fahr. On one day the maximum was 49 deg. Fahr., twice 50 deg., and once 51 deg. On many of the days in which a maximum of 54 deg. to 58 deg. is given it was not until midday that the mercury went above 52 deg. Fahr. in the shade, and then only for a short time. The minimum also was very low, as the accompanying chart shows. It has always been thought that warm nights were essential to a honey-flow on the following day, yet on three out of the four best days the preceding night-temperature was distinctly below the average; the figures were 41 deg., 34 deg., and 39 deg. Fahr. respectively.

The chart shows well how no two days were alike by the extraordinary oscillations of both the maximum and minimum temperature lines. In settled weather these lines ought to be almost straight and horizontal.

Weather.—One of the features of the weather was the persistency of northerly winds, the very few days without showers, and the many days of almost continued rain. There was no day on which the sun shone all day. It was noticed that colonies lost strength on the moors much more quickly week by week than is the experience in most years. To anyone present on the spot the explanation was very apparent. With each shower many of the hurriedly-returning workers, both young and old, were beaten down on to the ground. The short grass in front of the hives was often covered with benumbed and drenched bees, which, owing to the very cold winds, never recovered. The position of some of them was marked, and we were thus able to prove the truth of our supposition. It has been proved that working bees have the power of recovering from long hours of chilling—even of snow—if it is followed by warmth, but this year there were no hot days.

Weight.—As the chart shows, after September 1 a morning and an evening weighing were made—before and after the flying of the bees. During the period under review there was practically no brood-rearing in the hive, although the queen was young, this being the condition in the vast majority of hives. It will be noted from the chart that while the bees were in a state of activity in the supers there was a nightly loss of about ¾ lb. This, of course, was increased after any good flow, and depended on the amount

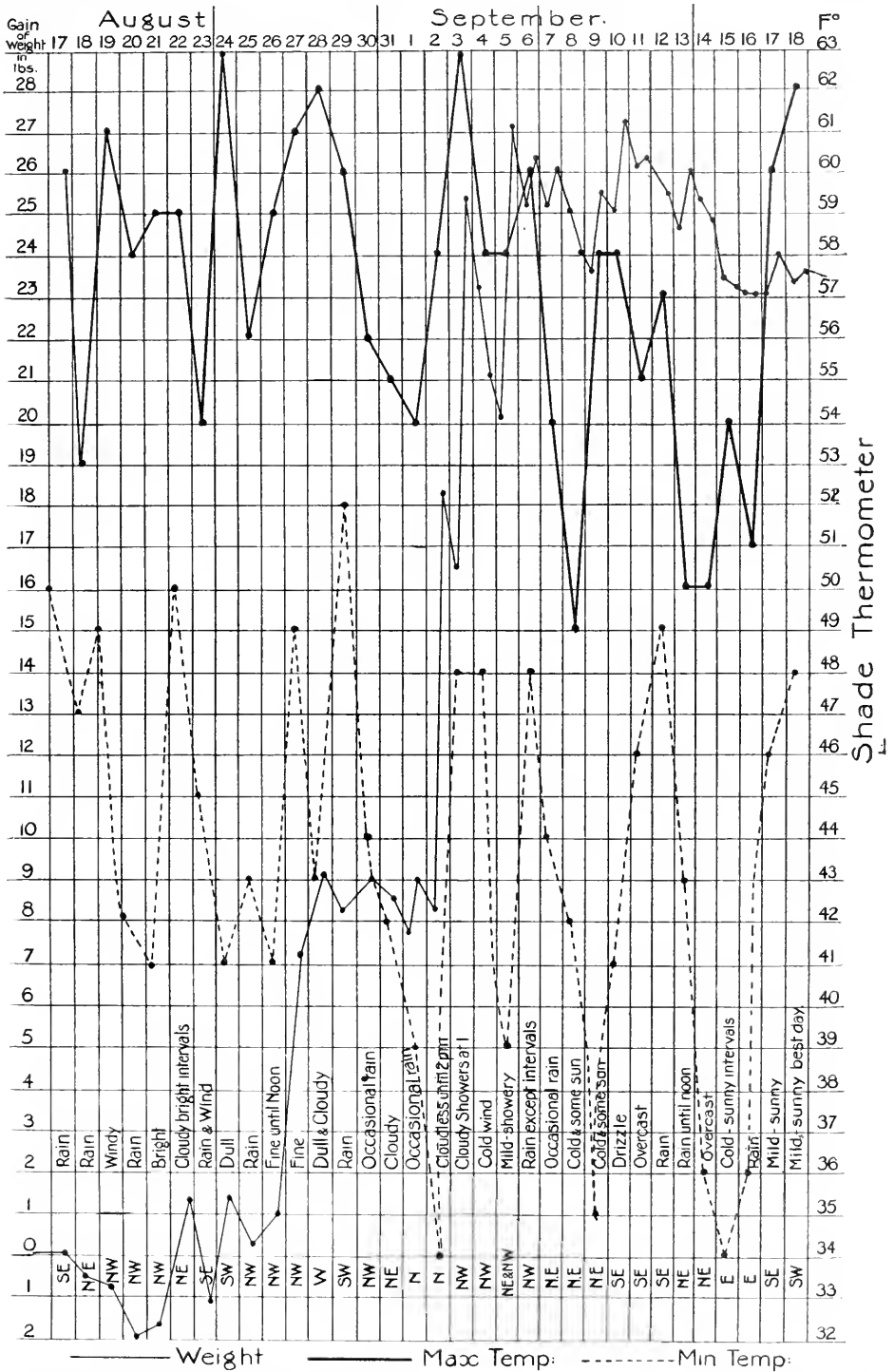

of that flow. During the thirty-six hours following the two good days—September 2 and 3—no bees flew, and during that time there was a loss of 5 lb. (see chart). On the other hand, from the morning of

September 15 to that of the 17th, during cold weather and after several days of a falling weight, the weight remained almost stationary. At this time the bees were lethargic as if in winter quarters.

Secretion.—We have been forced to the conclusion that, at any rate in a bad year, the problem of the secretion of nectar is much more complex than we had thought. We expected that on any day with the wind in a northerly quarter, or a low shade-temperature, or after a hoar frost, no flow of nectar could be expected, yet on our best day all these factors were present. It is also stated that rain washes out the nectar from the flowers, yet on one day there was a tremendous shower at 7 a.m., but the bees were at 10 a.m. exceedingly busy, and returning to the hive so distended that many "fell short." One point about this season was quite definite, and that was that a heavy flow was only of short duration (one to two hours) on any one day, and this was the first hours of the morning, this being apparently independent of the temperature during the previous night. We noted among other points that in one respect heather and clover secrete nectar quite differently. Almost invariably, when bees were flying at all, they were able to work on the heather to some extent.

Ten minutes' sunshine would result in the heather being full of the busy little people, although on an unfavourable day they seemed to return to the hive as light as when they set forth; yet when the weather is unsuitable there may be at the hive doors acres of clover in bloom without a bee on it, while at the same time they are bringing in a supply from other sources. The fact of bees working on clover indicates a definite flow, which scales could reveal, but with heather the same does not hold good.

On the last two days recorded the conditions appeared the most favourable of the series, and the bees worked most industriously, but there was only a total gain of $\frac{1}{2}$ lb.!

We must apologise for the incompleteness of our records and conclusions, as we feel that they have only made more clear to us the complexity of the question. They have, however, pointed out fresh possible lines of investigation. These we hope to be able to carry further another year, when we trust that a good season will present quite a different set of problems.—MEDICUS, Newcastle-on-Tyne.

HAS THE B.B.K.A. OUTLIVED ITS USEFULNESS?

[7677.] This question has of late been forced upon us by the evident lack of support afforded by the general public as well as by the great army of bee-keepers known to exist in Britain. As at present constituted, there is not wanting evidence that the B.B.K.A. has passed the meridian of its sphere of usefulness as a

national association. In 1874, when the Association was started and the name "British" was given to it, no doubt its claim to be the association representing the bee-keeping industry of Britain was a good one, and since then an enormous amount of good has been done by the Association in spreading over the country a knowledge of the craft of which it can fairly claim to have been the pioneer. Now we have the spectacle of the premier association steadily falling behind, while bee-keeping becomes annually more popular both as a pleasure-giving pursuit and a lucrative side industry. At the same time, county and other associations are on the increase, some of them having more than double the membership of the B.B.K.A. itself. Some of the county associations could undoubtedly undertake most of the work now performed by the parent society, while their prestige is as great over nearly as large an area. From all this it is evident to lovers of our craft that unless something can be done to make the parent association more popular its existence as a national and educational institution will cease. This would be a regrettable event to those who remember its past services to bee-keeping, and, while recognising the futility of appealing to bee-keepers solely on sentimental lines, the B.B.K.A. itself should put forward strenuous efforts to justify its continued existence as the head of the British bee-keeping industry.

Many suggestions have been made for aiding the B.B.K.A. to a better position financially, and, if I may say so without giving offence, some of them are so evidently impracticable as to show a very limited knowledge of the subject. Before any remedy can be effectually applied, the cause of the trouble must be known, and in my opinion the weakness is not recognised yet. Your correspondent Mr. Coates (7661, page 446) quotes statistics to show the amount of honey imported, and suggests means to aid in producing the honey at home and at the same time raise support for the B.B.K.A. Reckoning the value of all imported honey at 10d. per lb., he arrives at the probable weight imported at the end of the current year as 400 tons. This will be a low estimate, as the average price of all foreign honey on arrival here will probably be nearer 5d. per lb. than 10d., and that doubles the estimated weight of imported honey, making the total 800 tons.

Assuming Mr. Coates's figures to be correct, and that we could raise the extra 400 tons next year, would the money now sent abroad be kept at home? I think not. Would not the extra honey produced be put on the market to compete with what we already produce? If so, then the only logical result would be a

glutted market and a general lowering of prices, unless the British public could be induced to eat more honey. The low price of this foreign stuff commends it for many uses to which British honey at double the cost will never be applied, and if you materially reduce the price of the home production by increased competition you hamper the producer, which cannot help the bee-keepers' associations. Further, we have no guarantee that the foreigner could or would not also meet competition by lowering his price.

With regard to Mr. Coates's proposal to reduce the subscription to *all* associations to 2s. 6d., this obviously applies to the B.B.K.A. only, as all, or nearly all, other associations accept 2s. 6d. as the membership subscription. If the county associations were not receiving the higher subscriptions from kind supporters, who give from 5s. to a guinea or more, they could not possibly contribute the amount they do now to the funds of the B.B.K.A., which amount last year was nearly £35, or considerably more than one-third of the total received by the parent association in subscriptions. With regard to the Socialistic proposal—more than once put forward—of levelling the finances of all the associations by pooling their revenue with the B.B.K.A., no progressive county would entertain it. Mr. Coates refers objectors to this plan to their own bees, pointing to a single hive for an illustration of his idea. This is sentimental. We will instead take each county to represent, not a bee, but a colony, all sprung from the parent colony, the B.B.K.A. Would your correspondent, as a good apiarist, hamper his good colonies—the “hustlers,” to use an Americanism—in order to give to his dwindlers stores which they could not accumulate themselves? The B.B.K.A. needs something more than an appeal to sentiment to raise it to the position it ought to hold among the associations.

If bee-keeping is to receive the impetus necessary to keep pace with growing requirements, the dwindling parent association must be resuscitated—a new association must rise, phoenix-like, from the ashes of the old.

In the present article I confine myself to making one suggestion out of several which occur. I could refer to another great national association which a short time ago, in order to avert disaster, had to set its house in order and make some drastic changes from within. May it not be necessary for the B.B.K.A. to look at home for some of the causes of decay? No institution has a chairman of the council better qualified for the office he holds than the B.B.K.A., and the new secretary has a good knowledge of bee-keeping over a wider area than any of

his colleagues; only his power is limited, as he has no vote on the Council. Of the Council as a body I wish I could say more. Many of their names are not even known to bee-keepers living remote from London. They may be good bee-keepers and willing to serve the Association well, but a Council chosen almost entirely from London and the surrounding counties cannot be representative of British bee-keeping. Some of those who have recently been elected figure as subscribers to the Association this year for the first time. Again, the attendance of several cannot be said to be satisfactory, although all Council meetings are held in London within easy reach of most of the members. On this account the meetings are of little interest to distant bee-keepers. I would suggest the necessity for electing a more representative Council, and so revising its constitution as to bring the B.B.K.A. into touch with bee-keepers over a wider area, and make it in reality as well as in name the British Bee-keepers' Association. I would further suggest that the B.B.K.A. put off some of its parental dignity, and take its offspring, the county associations, more into its confidence, not treating them as sleeping partners, but enlisting their support in order to back up the legitimate demand of the united body of bee-keepers for State aid in advancing the condition of the industry. With all due respect to the present Council, I would point out that a small body of ladies and gentlemen drawn from London and its neighbourhood, representing an association consisting of some 250 members, who reside mainly in the home counties, is but a poor lever with which to move the strongest Government in the world to bestow aid on the important craft to which they belong. They need the weight of the majority of British bee-keepers behind them. Speaking as one familiar with the opinion of the majority in several counties, I believe a representative Council, who would respect and put forward every effort to give effect to the demands of the majority of those they represent, would assuredly receive their full measure of support.—G. W. AVERY, Hon. Sec. Cumberland B.K.A., Carlisle.

[When the Council was elected from members residing at a distance from London it was found that they rarely attended, and to carry on the business it was absolutely necessary to recruit the Council from members who could reasonably be expected to attend. Our correspondent has overlooked the fact that affiliated associations have the right to appoint a representative member of the Council, and that sixteen such representatives are actually members of it, our

correspondent being one of them. It is hardly the fault of the Council that they do not attend, and it can therefore be reasonably assumed that they are satisfied with the work of the B.B.K.A., or they would not leave it all to those living near London. Since its election this year the Council has met eight times, and of the sixteen representative members of the Council one attended on April 22, one on July 15, two on August 5, and one on September 16 and October 7. At three of the meetings there was not a single county representative. A seat on the Council is no sinecure, as there is a large amount of business to get through, which frequently occupies three to four hours, and is such as can be carried out only by a parent association. We are quite sure that the B.B.K.A. would only be too pleased to elect members of the Council from a distance if there was any prospect of their attending the meetings, but unfortunately the experience has been quite the other way.—Ed.]

A BEE-CANARD.

[7678.] Boyd Alexander repeats in his "From the Niger to the Nile" (vol. i., page 163) the old Samson story that bees feed on dead carcasses. He says:—"Thousands of butterflies feeding in bunches upon the road were a very remarkable sight. Butterflies in Africa, and bees also, are often to be found feeding on rotten carcasses, from which they fly up in crowds on being disturbed. I suppose the scarcity of flowers, in the dry season, has cultivated the more robust taste in them." How ignorant some people are of the habits of the busy bee!—READER, Loughborough.

BEEES IN GLOUCESTERSHIRE.

[7679.] The season here has been a very poor one. Bees did very well in early spring, but in June and July cold winds predominated, with rain and little sunshine, with the result that any surplus gathered was consumed, and in most places we had nothing but empty supers to take off. Stocks had to be fed heavily for safe wintering, and though a few bee-keepers secured some surplus, in most cases it was mixed with honey-dew.

Regarding Italian bees, I was pleased to see in this week's B.B.J. (page 456) your correspondent Mr. Hall giving a good account of them. I think, however, he would do better to have his queens raised from imported Italians and mated with native drones. Bees of this cross are rather given to swarming, but this propensity can be easily overcome by hiving the first swarm on the old stand, and if swarms are not desired raise a queen from them again. Or, say they are four genera-

tions back from the imported mother in the first place, each successive queen being mated with a native drone—which will be the case if there are plenty of same about—they will lose their swarming propensity, and, of course, their colour. They will be found a good all-round strain of bees, vigorous, good honey-gatherers, and, as a rule, no worse in temper than the native blacks. I find, on the other side, that the progeny of a native queen mated three or four generations back with Italian drones are very much given to swarming; they are good-tempered, taking them all round. A mixture of the two races is best; they will beat any pure blood as honey-gatherers and disease-resisters. At any rate, this is my experience, but I should like to hear that of others.—O. K., Gloucester.

THE "FREE-WAY" EXCLUDER.

[7680.] In answer to your correspondent "A. P., Sussex" (7652, B.B.J. of October 28), there is no doubt that the "Free-way" allows a freer passage for the bees. I placed one under a rack of shallow frames in a crowded hive, and when I examined it later to see how the honey was coming in I found the frames more than half full of drone-brood. I discovered the old queen above the "Free-way"; she had been superseded by a young queen in the brood-chamber below. I took away the excluder, and upon testing found in places that it was possible for a queen to pass through.

I also know of another instance in which a trial was given to the "Free-way." In this case the bees carried enough pollen to spoil five shallow frames. I am pleased to see your other correspondents have had much better results, but for the present I shall retain the old zinc excluder, which with me has never failed.—T. CARD, Edmonton.

ZINC QUEEN-EXCLUDERS.

[7681.] Are those who complain of excluder zinc hindering the passage of the bees careful to lay it on *right side up*? Years ago I saw this mentioned in B.B.J., and found the necessity for it, as there is a slight burr from punching on one side, and this should always be placed uppermost, as I expect many bee-keepers know.—W. E. BURKITT, Hon. Sec. Wilts B.K.A.

CELLULOID QUILTS.

[7682.] Referring to Mr. Reid's remarks, reported on page 444, I should be glad if he would inform me the exact thickness of the celluloid which he advises. Perhaps also he would be kind enough to indicate where it can best be obtained.—A. E. B., Northfield.

SPLIT CANE FOR SKEP-MAKING.

[7683.] Can any B.J. reader inform me where I can get split cane for building skeps? I have been unable to obtain it from bee-appliance dealers.—G. F. Y., Pembroke.

AMERICAN AND COLONIAL PAPERS.

EXTRACTS AND COMMENTS.

By D. M. Macdonald, Banff.

From "Australian Bee-keeper." — "Honeys taken in a warm, dry climate show less tendency to granulate than those taken in a moist atmosphere. The greater the density of honey the less tendency there is to granulate." I feel that there is truth in the first sentence. If the latter is true, heather-honey should not granulate.

He said my bottom-board had been "found wanting." I consider his one an "infernal nuisance" (page 61). Over the page the latter ertic adds:—"But there is no need to 'fall out.' We can't all think alike, thank heaven!" Shakespeare described seven stages of quarrelling. I wonder in which division the foregoing should be classed.

Mr. Armour says:—"I find black bees no more inclined to swarm than Italians. When my bees get the swarming fever they forget what colour they are for the time being."

"Jumping brood-frames to the outside," says Mr. Beuhne, "to give the queen more room to lay may be all right sometimes, but it is dangerous as general advice." Excellent though the practice may be at times, it has been found to work so much evil that all reference has been left out of the latest editions of the "Guide Book" to the practice of spreading the brood.

From the "Review."—"Vestibules are used and recommended by a few of the men who successfully winter their bees out of doors. These men scarcely ever lose a colony." I should like to hear from some who use vestibules or "storm doors" in this country.

Mr. Townsend suggests the "standing of frames *on end* in the spring," because it would conform to the instinct of the bees, and then using them flat way down during the honey-flow. The idea is certainly a novel one! I have frequently intended asking if anyone in this country grows *sweet clover*. Here are some of its good points:—"It will grow most luxuriantly on railway cuts and embankments with soil too poor to start any other kind of vegetation. It blooms from June till September. It seeds itself and spreads so that it greatly improves the honey-flow in any locality. It makes the barren wastes round my home blossom as the rose." I wish I had some seed!

In California many bee-men move their apiaries back and forth from mountain to valley to avail themselves of the earlier nectar-flow from the valley plants, as well as the fine yield from the plants and shrubs of the mountain regions.

Mr. Elmer Hutchinson has a preference for the "Miller" feeder holding 15 lb. of syrup. If the weather is warm he works the feeder on the top of frames; if cold then he places it below.

From "Gleanings."—Here is a rough-and-ready bee-escape recommended by no less an authority than Doolittle:—"Pile the supers in the apiary with an empty super on top, over which spread a cloth, on which the bees collect. If the cloth is turned a few times you rid the sections of the bees."

Dr. Philips lately supplied data showing the value of the bee as a pollinating agent, and concluded:—"It is safe to say that the indirect benefit of the bee-keeping industry annually adds to the resources of the country considerably more than the amount received from the sale of honey and wax." Please read Mr. Cowan's address at the recent *Conversazione* and satisfy yourself that this is true.

One foul brood inspector in the course of a few years, in New York State, changed a loss of £40,000 from the evil effects of the disease into a loss of only £2,000. What a saving should be brought about by the fourteen employed by the Government of Canada! And yet they have foul brood!

Here is something from Mr. Doolittle regarding effete queens:—"In all the cases of supersedure which happened at the time spoken of, the queens were failing and soon died. This happened in nearly every case before the young queens began laying, so that the fewness of eggs was the real reason why she was replaced." Mr. Crawshaw, I think, early this season expressed a doubt when I used almost equivalent words.

From "American Bee Journal."—Mr. York is rather "on the fence" on the subject of foul brood, but he is coming round. He believes there is a tendency to suppress the knowledge of the presence of the disease, and states it is distributed more generally than is supposed. I note particularly that he acknowledges its workings are "insidious"; they are for the man who does not disinfect. He, quoting Dr. Cook, prints the following regarding honey-dew:—"Much aphid honey-dew is deliciously wholesome, and the honey from it is superior, but coccid honey-dew is dark and of an ill-flavour."

A writer in a popular weekly, it seems, has been black-balling honey, and disseminating what he calls *the truth*. He

should have first acquired the most elementary facts regarding the honey-bee before setting up as an authority. Why, the fellow says:—"He" (that is the bee—ye gods, think of it!) "makes bad honey." And it is no misprint either, because later on he speaks of "the bee *himself* capping the comb."

Mr. Byer, in comparing the super work of Carniolans, Italians, and blacks, concludes:—"I have no hesitation in saying that the long tongue idea, in so far as it refers to the different races, is pretty much humbug." His Carniolans collected most from the red clover just because they happened to be most populous at one time.

BEEES AND LUCKY DAYS.

From the following passage in Wang Shi-Chin's "Chi-pei-yau-tan," completed in 1691 (Brit. Mus. 1533 l. e. 3, lib. iii. fol. 3b), it is manifest that some Chinese of old entertained a belief in bees living in direct contact with the gods (cf. Mr. Gomme's work quoted at 10 S. ix. 433, col. 2):—

"The inhabitants of certain mountains south of Yau-yüe are all in a lifelong ignorance of the calendar, but in its stead they observe punctually every morning and evening the hives which every family keeps. Whatever day the bees happen to swarm is deemed unfailingly lucky, and business of all kinds is favourably transacted on it. Should some business chance to be unfinished in the day, it is put off till another occasion of bees swarming. On such a day also are celebrated ordinarily the ceremonies of marriage and of beginning buildings. Thus, swarm in whose house the bees may, the neighbours and servants go round the place with the news; indeed, the people never attempt to conceal the fact. Once upon a time a trading stranger came and sojourned in the locality for a year, and during this time he attentively recorded the days when bees swarmed, altogether numbering one hundred and odd. On his return home, he examined the calendar, and was astonished on finding those days without exception marked *dies albi*; whereas all other days on which the bees did not swarm were either unlucky or void of import. So wonderful is the mystic instinct of these animals, which enables them to communicate freely with the Creator."—KUMAGUSU MINAKATA, Tanabe, Kii, Japan.

Notices to Correspondents.

BEGINNER (Westerham).—*Winter Coverings*.—If you have a thick chaff-cushion on your hive it is not necessary to put on "twelve or fourteen layers of warm felt." In fact, they would do quite as

well without the felt if the chaff-cushion fits properly. As you have packed them well round with chaff this is all you need do, provided the colony is well supplied with stores.

NOVICE (Swanage).—*Race of Bees*.—The bee is a common English one. It is not unusual to find a few dead bees after a spell of cold weather, as they are usually carried out of the hive when bees have the opportunity of getting out.

E. M. R. (Wendover).—*Paroid and Neponset for Hive-roofs*.—We are sorry to be unable to give you the address of an agent in England, and should be glad if any reader could supply it.

A. R. D. (Harston).—*Feeding Bees*.—If bees are supplied with sufficient stores in September they should not require feeding. See "Guide Book," page 112, for quantity. There need not necessarily be anything wrong because bees do not fly out now, as they are not so inclined to do so as when brood is being reared in the early months of the year. You can push a cake of candy under the quilt without opening the hive and with very little disturbance to the bees. It is impossible to say if the stores are sufficient without looking into the hive.

STANBRIDGE (near Bristol).—*Working Nucleus*.—It is quite a common practice to work a nucleus in the way you propose, except that the entrance to it should be placed on one of the other sides. If you have it next the main entrance you would run the risk of the queen returning to the wrong hive and thus being killed. If you use a perforated dummy between the stock and nucleus, uniting would be quite easy.

O. T. (Holywell Green).—*Is Syrup Converted into Honey?*—The Rev. Theodore Wood, whose article you send, has evidently made a mistake and is not sufficiently acquainted with the subject, or he would not say "if a bee is fed with sugar and water instead of nectar, it will turn the sugar and water into honey in just the same way." A bee does not convert sugar and water into honey, and it is quite easy to detect the fraud when it has been resorted to by some unscrupulous bee-keeper.

H. R. (Swanley).—*Varying Colours of Honey*.—It is impossible to say why the colour of honey varies so much, except that it is due to the nectar, which varies in the different flowers. One variety of honey may be colourless, while another produced in the same district by the same bees and under similar conditions, but from other flowers, may be quite dark. Not only does the colour vary, but also the amount of water the honey contains. The proportions of levulose, dextrose, and sucrose also vary considerably.

Editorial, Notices, &c.

REVIEWS OF FOREIGN BEE-JOURNALS.

By "Nemo."

Remedy for Wax-moth.—Hardly a summer passes without complaints about the ravages of wax-moth, and when colonies are queenless it is not long before they are invaded by them. M. Coestin Schachinger gives, in the *Deutsche Illustrierte Bienenzeitung*, a simple remedy for keeping them away which he has found efficient. It is *Plectranthus fruticosus* (cockspur flower), which is cultivated as a house plant, owing to its property of keeping away moths. It belongs to the order *Labiata*, has a blue flower, and attains a height of 3 ft. to 5 ft. Stood in a bee-house or in a room where combs are kept, it is said to prevent moths coming anywhere near them.

Adulteration of Comb-foundation.—A. Shilling points out in the same paper that pure beeswax bleaches in the sun and becomes white. This fact may be made use of in order to detect the adulteration of comb-foundation. He says many manufacturers in Germany add ceresin, as it is 25 per cent. cheaper than beeswax. As ceresin is already white, it is generally coloured with curcuma. If such ceresin is added to the wax it will never become quite white, as only pure wax does so. It is not difficult to try the experiment in the sun. Take a piece of the suspected comb-foundation, and make a thin plate from pure yellow beeswax, and place them side by side in a light room. In a few weeks the action of the light will show that the pure wax is becoming bleached, while the adulterated hardly loses any of its colour.

Respecting Parthenogenesis.—Writing in *L'Union Apicole*, M. O. Bouquillon says he has been able to satisfy himself as to the correctness of parthenogenesis in bees, and he has also had demonstration in a colony which swarmed several times that the fertilisation of the queen takes place outside the hive. In this case a young queen, which was found to be incapable of flying, laid regularly in worker-cells, which resulted in nothing but small drones. He has also succeeded in keeping secluded virgins produced from a hybrid mother, the result of a cross between an Italian fecundated by a black, which produced only small black drones when the queen was confined to worker-comb, and normal-sized drones when she was placed on drone-comb. M. Bouquillon therefore does not think that the theory of Ulivi and others, who maintain that queens must mate in order to lay, is worthy of credence. He also says that every ob-

servant bee-keeper who knows anything about swarming may observe certain colonies or second swarms that have lost their queens on their wedding flight, which become queenless in consequence. In such cases drones are reared in queen-cells as well as in drone-cells. The first do not hatch unless they are protected by a cage. This rearing of drones goes on continuously until the population becomes extinct. On careful search, the "small fertile queens" which Ulivi has stated to exist are never found, but ordinary workers with more or less rudimentary ovaries are discovered, and those having them most fully developed produce the laying or fertile workers.

Do Bees Injure Fruit?—M. Sickingler shows conclusively in *Die Biene und ihre Zucht* that bees do not injure fruit. Last September, he says, a bee-keeper was asked by a neighbour to come and see how the bees were plundering the grapes in his vineyard. The bee-keeper really saw a number of bees busily sucking the juice from the berries, and asked M. Sickingler for advice. The latter told him to say that the berries had been bitten previously by wasps, as bees were not able to pierce the skins. The neighbour was sceptical as to this, so to convince him a perfect cluster of grapes was put in a strong hive on the top of the frames. After forty-eight hours it was found that not a single berry had been pierced, but that the bees had actually commenced to cover them over with propolis. M. Sickingler concludes that this is corroborative evidence that bees do not puncture fruit, and says when wasps do so in warm weather the juice ferments readily, exudes upon the neighbouring berries, and it is then that bees suck it up, generally to their own detriment.

AYRSHIRE AGRICULTURAL SOCIETY.

In connection with the above society's exhibition at Kilmarnock on October 21 and 22 a section was reserved for honey and bee-products. So far as the ingathering of honey is concerned, this has been probably the worst season for a series of years, and as a consequence the show in this section was a little disappointing. There were, however, some praiseworthy exhibits of heather honey.

The following were the awards:—

Six 1-lb. Jars of Extracted Honey.—1st, A. White, Glaisnock Street, Old Cumnock; 2nd, John Ross, Barkerland, Dumfries; 3rd, James Pearman, Penny Long Lane, Derby; v.h.c., W. F. Trineman, Saltash.

Six 1-lb. Jars of Extracted Heather or Mixed Honey.—1st, John Ross; 2nd, Alexander F. Borland, Glenberrie, Old

Cummoock; 3rd, John Henderson, Cairnview, Old Cummoock.

Six 1-lb. Sections of Honey other than Heather.—1st, James Pearman; 2nd John Ross; 3rd, K. Dobie, jun., Academy Street, Dumfries; v.h.c., J. G. Nicholson, Langwathby, Cumberland.

Six 1-lb. Sections of Heather Honey.—1st, John Henderson; 2nd, J. G. Nicholson; 3rd, A. White; v.h.c., James Halliday, Slogarie, New Galloway.

Six 1-lb. Jars of Granulated Honey.—1st, John Ross; 2nd, G. Nicholson; 3rd, R. Brown and Son, Somersham, Hunts.

Beeswax.—1st, John M. Stewart, Mollance, Castle-Douglas; 2nd, F. W. Frusher, New Road, Crowland; 3rd, John Rowlands, Pwllheli, North Wales; v.h.c., Allan Gibson, Parkend Cottage, Tarbolton.

Three 1-lb. Jars of Extracted Honey (competition limited to exhibitors resident in Ayrshire).—1st, A. White; 2nd, Alex. F. Borland; 3rd, John Duncan, Burnhouse, Galston; c., Allan Gibson.

Three 1-lb. Sections of Comb Honey (competition limited to exhibitors resident in Ayrshire).—1st, A. White; 2nd, Alex. F. Borland.

Two 1-lb. Jars of Extracted Honey.—1st, Robert Fergusson, Auldgrith; 2nd, John Ross; 3rd, P. J. Gibbs, Bärthlow, Cambs; c., James Smith, Netherholm, Dumfries.

Two 1-lb. Sections of Honey.—1st, G. Nicholson; 2nd, James Smith; 3rd, John Ross; h.c., R. Brown and Son.

MID-KENT B.K.A.

The above association held their first show on November 9 and 10 at Maidstone. The season having been a very poor one in the district, the entries were not so numerous as they would have been had the season been up to the average. Mr. W. Herrod kindly undertook the office of judge, and expressed the opinion that it was a very creditable show. The following were the awards:—

Six Sections and Six 1-lb. Jars of Honey.—1st, S. Burden, Headcorn.

Six Sections.—1st, S. Burden; 2nd, — Boulden, Boughton.

Three Sections.—1st, E. R. Nash, Smarden; 2nd, M. Richards, Loose.

One Section.—1st, E. R. Nash; 2nd, H. Dobell, Marden.

Single 1-lb. Jar of Honey.—1st, S. Burden.

Three 1-lb. Jars Medium-coloured Honey.—1st, M. Watts, Bearsted; 2nd, S. Burden.

Three 1-lb. Jars Dark Honey.—1st, S. Burden; 2nd, J. C. Roberts, Maidstone.

Beeswax.—1st, J. C. Roberts; 2nd, H. Dobell.

2 lb. of Candy.—1st, S. Burden; 2nd, M. Richards. — JOHN C. ROBERTS, Hon. Secretary.

Correspondence.

The Editor does not hold himself responsible for the opinions expressed by correspondents. No notice will be taken of anonymous communications, and correspondents are requested to write on one side of the paper only and give their real names and addresses, not necessarily for publication, but as a guarantee of good faith. Illustrations should be drawn on separate pieces of paper. We do not undertake to return rejected communications.

AMONG THE BEES.

FERTILE WORKERS.

[7684.] Riem, about a century ago, discovered that quite a number of worker-bees were able to lay eggs, but he seems to have made no investigation as to the why and wherefore of this strange anomaly. The patient and indefatigable Huber verified the discovery, and by diligent research proved that their origin is brought about in hives for some time queenless, which have failed to rear a fertile queen as a successor to the one lost or deposed. It is a well-known fact that an egg which would produce a simple worker can, by the bees' prescience, be converted into a queen if the workers begin a special treatment in time and enlarge the cell to one of royal shape and size. The royal jelly, by whose potent power this wonderful transformation takes place, is lavishly produced by the bees in their eagerness to rear a mother, and it is natural to think that some of the larvæ in cells in close proximity to the royal cradle may by chance or design receive limited supplies of this highly-concentrated food, with the result that their ovaries, dormant in the real worker, may be partially developed. The supply being only partial, full motherhood is denied them; but they have the marvellous power of laying eggs, out of which, however, only drones can be reared. So far they can act almost to the same degree as an unfertilised queen, which can lay only drone-eggs.

Fertile workers appear in hives more commonly than is generally known, but they are not allowed to exist when the colony is headed by a fertile queen. In queenless hives they may, and as a rule do, exist in considerable numbers, and become a nuisance, as the workers really treat them as queens, with the consequence that such hives will seldom accept a queen, however carefully she may be introduced. Possibly many rejections are due to this undreamt-of cause. Their presence in a hive may be discovered by the peculiar manner in which they deposit the eggs in the cells. They have a preference for drone-cells, but are not specially discriminating. Fertile queens lay eggs systematically in close batches, one in a cell, unless they are extra prolific, or bees are so few that they cannot cover them. In these cases they duplicate, but instinc-

tively keep in or near the cluster. Fertile workers roam over the combs, laying a few eggs here and there in a way no queen ever does. A good illustration of their style of ovipositing can be seen in the "Guide Book," page 13. Of course, as they can only lay drone-eggs, the stock pestered by their presence will quickly run down and soon become extinct; so it is well to discover some means of getting rid of these anomalies.

Some Cures.—1. Perhaps the best plan, and the one saving most trouble, is to break up the colony and place one frame in as many hives as they number. Important as the partly-developed would-be matrons assume themselves to be in a hive where they try to share the burdens of motherhood, they are nonentities where they now find themselves, and are either evicted or forced to desist from annoying the community. In any case, their presence fails to create any baneful influence. 2. Take the hive on a mild, sunny day to a quiet corner of the garden, spread a cloth or newspaper on a walk or level space, and dump the whole colony down thereon. Shake every bee off the frames one by one. Rearrange the frames in the body-box while the bees are still dazed by their unwonted treatment, and carry it to the home stand, placing everything in position as it was before the "earthquake" disturbed their equanimity. The shaken bees ("shaking" does good here), on regaining their senses and finding themselves not a farthing the worse, look about them, crawl a little to certify that no limbs are broken or out of joint, and then take wing. Naturally they all take a bee-line for home. The would-be matrons, not having been "fielders," do not know the way there, and if they attempt entrance into any hive are treated as undesirable aliens. 3. Such colonies are rarely inclined to accept even a fertile queen, but cling to these fertile weeds, even to their own undoing. Try this plan: Coat a queen with the honey from one of the frames which have been shut off for some time by double excluder-zinc at one side of the hive, and let her act as queen of that frame for some hours. Shift this frame to the centre of the hive late in the evening, with the adhering bees, the queen, and the eggs she has oviposited. The bees defend her majesty if the others molest her, but they rarely do. 4. Stupefy the bees, as was commonly done of old, by fumigation, or, another ancient practice, "drown" them, and let the queen run in with them on to the combs when they are resuscitated, and they will depose her rivals and accept her as their queen regnant (I do not strongly recommend this plan, as better means have superseded these old recipes). 5. I have left my best "wine" until the

last. Confine the bees of the hive to, say, five or six frames. Place a "Wells" dummy alongside of these, and carry a small nucleus lot of two or three frames and place them in the vacant space. Of course, the bees are headed by a fertile queen. I think in twenty-four hours the dummy may be withdrawn and all the bees treated as one stock; but to make matters more certain it would be better to add only one frame at a time daily to the nucleus.—D. M. M., Banff.

BRITISH BEE-KEEPERS' ASSOCIATION

[7685.] I think it is a pity that bee-keepers do not now come forward and state exactly on what lines they wish the B.B.K.A. to be reconstructed, as now, when the whole matter is *sur le tapis*, is undoubtedly the time to express one's views.

Mr. Geo. Hepburn (7468, May 27) makes good proposals in propositions 1, 2, 3, and 4, but I should not care to see proposal 5 carried out, as undoubtedly decentralisation would not improve the funds. The county organisations should be subservient to a central executive council. I should like to see the executive council do more than be responsible for grants obtained from County Councils, organisation of shows, and direction of county branches. I think they ought to be empowered to take up in the Law Courts the defence of cases in which bee-keepers as such become involved, assuming that there is good cause for their doing so. The same applies to the support of claims. Why could not the B.B.K.A. follow on the lines of the N.C.U. in such cases? In the event of dispute between two bee-keepers, they might, with the expressed wish of both parties, act as arbitrators, both depositing a fee.

The B.B.K.A. might also approach the Railway Board to obtain a reduction in railway rates, the present agricultural produce rate being a most excessive one for such an article as extracted honey. The C.T.C. were able in years gone by to get a reduction in the rate on cycles, and why not the B.B.K.A. on extracted honey? The B.B.K.A. would have to draw up rules as to how the honey should be packed for despatching.

Granted that the B.B.K.A. cannot promise procuring concessions in railway rates, yet if these last suggestions were in their programme there would, I think, be no need to cry over the lack of funds.

I would suggest subscriptions to be 4s. per annum for members owning any number of stocks up to twelve, an additional 1s. to be paid by those owning any number between twelve and fifty, a further additional 1s. to be paid for each multiple of

fifty above that number. A bee-keeper owning 250 stocks would thus have to pay 5s. for the first fifty and 4s. for the number above fifty, a total of 9s. A large bee-keeper, being benefited to a greater extent, would thus pay more.

The greatest stumbling-block I see is the grants from County Councils: if only all would make equal grants the difficulty would be solved. Would it do to have the grant of each C.C. kept strictly for the use of that county, to be expended only on lecturing, expert's visits, and for prizes at the annual show?

It is sincerely to be hoped that the reconstruction will soon be carried out, as undoubtedly it will not be long before bee-keepers will be urging another attempt at a Foul Brood Bill, some of the county associations having already passed resolutions in favour of one.

Several bee-keepers have written congratulating Mr. Herrod on his appointment as secretary *pro tem*. I quite fail to see it that way. It is the Association who are to be congratulated, as in Mr. Herrod we should have a secretary whom most of us know, whose permanent appointment would be extremely popular, and whom we should all feel to be the proper man to undertake the work. With Mr. Cowan as chairman and Mr. Herrod as secretary, we should have the foundations of a real live Association.

Personally I do not intend joining the B.B.K.A. for sentimental reasons, and there are others who, like myself, are only interested in bee-keeping as a business; but with a live Association on the above or similar lines I should be prepared to give my hearty support to it, and do my utmost to get others who are now holding back to do the same.

We Britishers are far ahead of the Yankees in most of our organisations, notwithstanding their talk, so let us have an Association even more active than their National, and one which will attract the great bulk of bee-keepers whom we have in the numerous small holders who are taking up bee-keeping as a business.—G. THOMAS, Pwllerochan Rectory, Pembroke.

BEEES AND CARRION.

[7686.] Under the heading "A Bee-Canard" (7678) a correspondent takes exception to the statement that bees feed on carrion. I think he is somewhat premature in condemning other people's ignorance when he himself appears to have a very narrow outlook. I have not read the book in question, but as far as I can see, the writer does not mention the "honey-bee" specifically, and as there are in the world many species of bees of allied genera, but of very diverse habits, I see

no reason why some species should not be fond of the diet in question.

For one thing I can personally vouch, and that is that butterflies *do* appreciate decaying matter. It is not necessary to go abroad to find examples, for we have one insect, a most beautiful species found now chiefly in the New Forest, which is extremely fond of putrefying animals. I refer to *Apatura iris*, the "Purple Emperor." Almost the only way to take the perfect insect of this species is to place a dead—not too recently dead—rat on the ground in its haunts. Time and place being suitable, the butterflies crowd round, and so absorbed do they become with the succulent mass that they may be picked off with the fingers.

I have also seen the common white butterfly regaling itself in large numbers at the edge of a most vilely stagnant pond.

Butterflies, as we all know, as a rule stick most scrupulously to the nectar of flowers, and an individual taste for something which appears to us so entirely different and so thoroughly objectionable is very interesting. There may be some analogy between the ultimate products of decomposition of animal bodies and the secretion of flowers. Perhaps some of our chemical friends can throw light on the subject. I for one await some information with interest.—H. G. MACE, Buckhurst Hill.

BEE-KEEPING IN NEW ZEALAND.

[7687.] I am glad you like the photographs, which you are quite at liberty to reproduce in your journal. In the one of Mount Peel, the building on the left is my cottage and that at the right is the honey-house. I also send you a copy of a paper read by me before the Canterbury Bee-keepers' Association, of which I am president, about the desirability of using queen-excluders, and it has been printed in several of the New Zealand papers. In addition you will find a few notes on spring management. Queen-excluders, although useful appliances in the hands of a skilled bee-keeper, are a hindrance to the work of the bees, and absolutely detrimental if not judiciously used. This being so, I decided upon trying another method, which, in my case, has proved a great success. All bee-keepers, I am confident, who have been running their apiaries for extracted honey, and have been in the habit of spacing their frames wide apart—a plan I strongly favour—have found the queen little inclined to enter frames so spaced. The reason is that the cells are too deep for her to fix her eggs at the bottom. This being so, I conceived the idea that frames

of a similar character might be used as a natural excluder. Having by me a quantity of wider half-frames, with combs fully drawn out, which I have had in use for some considerable time, I decided to try these as excluders.

queen remaining at the bottom all the time, where she should be.

To carry out this idea, take half-frames, such as are used for section-carriers. Fill them with medium brood-foundation, by whatever method you please; or it might



VIEW OF MOUNT PEEL, SHOWING MR. CLAYTON'S HOUSE AND HONEY-SHED.

I was this year in a position to fill ten half-supers with these combs, which were placed next to the brood-chambers, and not in a single instance did the queen pass through, while in two only did she deposit

be advisable to fill some with worker-comb until a few fitted with foundation are drawn out.

Now something about myself. I spent twenty-five years of my life in London,



PART OF MR. J. CLAYTON'S APIARY, PEEL FOREST, NEW ZEALAND.

any eggs, this as a result of the combs being thinned down by the bulging of the next one. These half-frames were left on throughout the season, and in some cases three full supers were placed above, the

removing to New Zealand in 1895. I have kept bees for a number of years as a hobby, and have been engaged here in a manufacturing business; but some time ago my health broke down, and my medi-

cal man advised a sea voyage, as he said nothing else would do me good. Unfortunately I was not in a position to take his advice, and he then said that I might improve if I could take up an outdoor occupation, so I thought I would try what the bees would do for me. I tried one or two locations near to town with more or less success, but soon came to the conclusion that to be a successful bee-keeper one must get far away from the madding crowd, so late last autumn I landed here with seventy-five colonies. I increased to 140, mostly by natural swarming, and took off three tons of honey, principally extracted. I may say this is an ideal spot for bees; there are good shelter, good water, and abundance of pasturage, about a thousand acres of native bush being within two miles of my apiary. Most of the native flora yields honey in abundance, and all the low-lying lands are full of white clover. The millions of early blooms are now coming out, and these will be followed by others up till the end of March. I finish my last extracting generally at the end of March, so you see we have a very long honey-flow. You will notice the dark patch under the snow-line on Mount Peel, in all about 500 acres; this is held by the New Zealand Government as a reserve.

I think I sent you a postcard photo of the straw hives which I got from Neighbour and Son, of your city; they are a great curiosity here. I am fixing up a rustic house to place them in, and I hope to send you a photo some day.—C. J. CLAYTON, Peel Forest, Rangitata, August 30.

TECHNICAL TERMS.

A PLEA FOR THEIR MORE PRECISE USE.

[7688.] "A bad and foolish imposition of words comes strangely to obstruct the mind" (*Novum Organum*). On more than one occasion lately I have endeavoured to show that technical terms of a precise and well-known meaning have been used in a very careless manner.

Thus your correspondents say "strain" and mean "a casual mongrel"; "honey-excluder" and mean "a slight hindrance to the passage of honey-laden bees."

Now I submit that no *true* "Science of Bee-keeping" can be built up on such crumbling foundations. Take, for instance, the term "strain." I have already pointed out (in an earlier letter) that this term cannot be properly applied to bees, because of want of control in the mating. Mr. J. H. Felch has indeed shown (by means of his line-breeding chart) that, in the hands of a skilled breeder, two good pairs of any breed of poultry may be line-bred for many generations without having recourse to a single "outside" cross, and with continually-

augmenting excellence in the points bred for. But line-breeding such as this, with its perfect control of mating, and its almost intuitive fore-knowledge (on the part of a skilled breeder) as to the results likely to accrue from such mating, is on an altogether different footing from that of the rearer of queen-bees.

I would also say a few more words on the statement that "a queen-excluder is a honey-excluder." Now, if the term "excluder" is not to be taken to mean precisely the same at the end of the sentence as it means at the beginning, why is it used? A queen-excluder means a device which *entirely* excludes queens from supers, and a modern queen-excluder fully justifies its name, for no normal-sized queen passes through. But it is stated that as an excluder excludes queens, it does honey also, which can only mean that honey is totally prevented from passing through. I need do no more than oppose to this very "exclusive" assertion the fact that thousands of tons of honey have been stored through excluder-zinc. Yet, to show that we users of excluders have far more than "one swallow" to our summer, I will quote the late Mr. Allen Pringle, formerly of Selby, Ontario, who says (in the B.B.J. for May 9, 1889): "After many years' experience without it [excluder-zinc] and nearly a dozen now with it, I would be exceedingly loth to part with it. Give me the 'excluder' every time, whether for comb or extracted honey. With it I can get more of both kinds, and of a better quality, than without it." Again, in the number for August following, he says: "Before he [Allen Pringle] ever heard of excluder-zinc he produced tons and tons of honey, and could do so still, but prefers now to lessen the labour of its production, while at the same time increasing its quantity, by using the modern improvement in the shape of excluder-zinc." Further, is it not recorded in Roots' "A B C" that Mr. McIntyre purchased no fewer than 480 excluders for use on his own hives, and the following season had 450 of them in use? Incredible! If every one of these articles excluded honey as well as queens!—SAML. P. SOAL, The Old Rectory, near Rochford, Essex.

ITALIAN BEES AND FOUL BROOD.

[7689.] I had much pleasure in reading in B.J. the report of *Conversazione* held on October 7, and to see the discussion on bee-diseases, including foul brood. I wish to tender my sincere thanks to Mr. Tinsley for his remarks in regard to Italian bees and foul brood. My practical experience of these bees exactly coincides with his. In my own case foul brood has been in the past the cause of a great deal

of trouble and anxiety, having purchased through inexperience a diseased stock of bees. To be rid of this pest I eventually burnt all the bees, but saved the hives, which, after being scoured and disinfected, are now in use. The stocks I have at present are headed by pure Italian queens imported direct, and I am pleased to say they are all in perfect health, with plenty of bees and abundance of natural stores. I cannot think why Italian bees generally are credited with bringing foul brood into this country. If it is correct that they do bring disease, why do our American cousins stick hard and fast to Italian bees? They would not tolerate our native bees at any price. In fact, they dub them mongrels and "scrubs." Such men as G. M. Doolittle, Dr. Miller, A. I. Root, and others must feel compassion for some of us in this country who talk so lightly about subjects which they have spent years of close observation in studying. My opinion of foul brood is that it came with bees out of the Ark, and will be present so long as there are bees, whatever may be their nationality, and as long as we are powerless to destroy stocks in trees and whatever places they choose to occupy. I firmly believe that if bees were kept on the same lines as our forefathers kept them, in straw skeps, and were sulphured in the same way, we should know no difference in the mortality from disease of Italian bees and "ye olde English bee." I am not interested in the sale of Italian bees, but speak from practical experience, which is the backbone of any profession.—HORACE H. HALL, Durley, Hants.

[That foul brood has been brought into this country with Italian bees there is no doubt, but we are not aware that Italian bees generally are credited with introducing the disease. We know from personally visiting breeders in Italy that where the disease is endemic there are many healthy colonies, and queen-breeders as a rule select these for queen-rearing. Does not our correspondent know that our American brethren are as much troubled with foul brood as we are? As the honey-bee is not indigenous to America, the disease must have been imported from Europe. Italian bees may suit many parts of America, but there are a good many Americans who not only tolerate blacks but prefer them; in fact, we have visited many more apiaries in Canada and the United States where blacks were kept than Italians. The gentlemen named no doubt know that a bee that suits one country is not necessarily the best for another. They have produced by selection a bee which they call Italian, and which suits their country, while our own breeders, as well as those in other parts of Europe, have by the same means produced hardy bees better suited to Euro-

pean conditions. There are districts in this country where pure Italians will do very well, but after over forty years' practical experience with them we fail to see their superiority to blacks, which by careful selection in breeding can be made to yield excellent results. The German Swiss have carried race-breeding to such perfection that Italian bees are no longer advertised in their journals.—ED.]

BEE-KEEPING IN THE ISLE OF MAN.

[7690.] I bought your "Guide Book" about twenty-five years ago when I was a bee-keeper and an exhibitor in Staffordshire, and I have kept it for lending to friends. It has travelled both in England and the I.O.M., and many successful bee-keepers have had their first lesson from it. It is now a wreck, so please send me a copy of the latest edition.

The I.O.M. is a good place for bees, and I should like to see a bee-association started here. I suggested forming one some years ago, but had to give it up disheartened, as bee-keepers here prefer to go their own way. One of the consequences is that at local shows judges are frequently appointed with no knowledge of the qualities which make a good honey, and beautiful exhibits are often passed over for those that are hardly fit for the show-bench. I speak from personal experience, but I have no feeling in the matter except regret that it should do more harm than good to hold shows where such laxity exists, and it discourages those who would help to advance the craft. The honey harvest has not been a plentiful one for the last two years, but I have had some of good quality, well spoken of by visitors, on the tables at Merridale House. Only my strongest stocks gave any surplus.

Two of the blessings we have here are less foul brood and no honey-dew. I have not seen the latter here yet. I speak of the district round Douglas. We had brilliant weather during the honey-flow, but the east winds upset the bees. A bumper season in 1910 is my earnest wish for all bee-keepers.—THOS. J. HORSLEY, Merridale House, Douglas, I.O.M.

BEEES IN CORNWALL.

[7691.] I have been a reader of your valuable journal for many years, having commenced when Mr. Abbott, I believe, was editor, and it was published fortnightly at 2d.

I have an old edition of your "Guide Book"—the one in which Bertrand's fumigator is shown in illustration—and I have not yet forgotten how delighted I was when I came across the first edition of your work.

It gave me great pleasure to read in B.B.J. an account of your travels in America and your visits to the American apiarists, which was particularly interesting and instructive. I am highly pleased with the illustration of my feeder in B.B.J. for November 18; it does the draughtsman credit.

It will interest you to know that I am applying my principle of slow feeding to all feeders, whether top, bottom, or division-board, and I can make them all observatory feeders like the specimen you have.

I am sorry the winter has set in, as the weather is very severe here at present, and has put a stop to all experimenting, except with candy. About a month ago I bought a stock of bees in a barrel from a neighbour. They had been in it for two years, and as the stock was a very strong one, absolutely free from disease, I transferred the bees and made them cover two ten-frame body-boxes. The combs are dark in colour, but I hope to renew them next season, D.V. I was particularly interested to see which way the bees built their combs in this barrel, and I found it was at right angles to the entrance, or on the cold system. The combs were (at the centre part) 18 in. long and 14 in. deep, the honey being stored at the extreme ends; they were about 2 in. thick, so I had about 20 lb. of surplus honey on transferring. It is, however, a little dark in colour. My own produce is usually of a light amber shade.

I am glad to say that my stocks are now in splendid condition for wintering, and well protected on the outside. I have during the past season had some of Mr. Sladen's strain of "British Golden" bees, which I find to be admirable, but I do not think they will beat my best strain of blacks.—Rd. GROSE, Bodmin.

SPLIT CANE FOR SKEP-MAKING.

[7692.] "G. F. Y., Pembroke" (7683), desires to know where he can get split cane for skep-making. If he sends the pattern of the size he wants to Messrs. M. Jacobs, Young, and Co., 265, Borough High Street, London, they will be able to supply him. It is sold by the pound in various sizes.—A. MACLAREN, Ledaig.

CAPPINGS OF COMB.

BY L. S. CRAWSHAW, NORTON, MALTON.

Notes by the Way (page 424).—Seasonable and practical as always, Mr. Woodley encourages us to keep our interest in the craft during the dull months. There is so much that can be done by way of preparation, even by those who have no further ambitions. Fortunate are those who can meet their equally enthusiastic fellows and discuss the knotty points. Old BEE JOURNALS are not just so much waste

paper, but when re-read will often come with surprising freshness. They contain much that is worth remembering, and a system for filing and indexing articles of special interest is a really good thing. "Notes by the Way" almost form by themselves a stimulative commentary on the season and its work. I could wish that Mr. Woodley would tell us some more about that "Combination" hive, so little known to most beginners—just how he uses it for his various purposes, and so on and so forth. I do not use it, but I have always owed it a lurking respect.

A Bumping Season (page 425).—Why "bumping"? Is this the shaking process which, "D. M. M." tells us, is to energise bees and men in the New Year, to which we have already drained our bumpers? Or is it shaking, which is to so bestir the Clerk of the Weather that we may say, "What ho! the season bumps"? Perhaps some seer, with weather eye wide open and of phrenological proclivities, will tell us, on ahead of Time, just what the season's bumps forecast.

Separating Swarms (page 426).—It is quite possible to save both queens by the simple expedient of putting the swarms into a large hive. A "Combination" hive is very suitable. A few combs should be placed at each end, and the bees dumped in the empty middle. The following morning will most likely find a swarm at either end of the hive. I don't know if this plan is infallible, nor whether it makes any difference to give unsealed brood, but it is worth trial the next time you are confronted with this particular difficulty and have a lot of other work on hand. Swarms do not always come on a Sunday!

I.O.W. Disease (page 431).—Theory and practice should be wedded to produce the best and legitimate results. Hand in hand they should walk, however fast, for theory ever outruns her fellow, leaving him deserted or divorced. Some of Mr. Reid's suggestions do not appear, to me at least, to be very practical. To eradicate this disease by eliminating the diseased eggs from the comb is surely unpractical, and is very like striking matches to see which are good ones! For diagnosis, however scientifically useful, would appear to involve destruction of the eggs. So far as I know, there is no simple egg-tester on the market! And his suggestion to isolate a queen and painstakingly cure her, whilst destroying the combs, and preserving, presumably, the adult bees, so that there may be "a chance for the hive" (*sic*), is to put a value upon the queen which she does not possess. Queens are cheap, or at least cheaper to buy than to cure. Of course, I may not have the scientific mind, but I know that this

is not practical or "rational" bee-keeping. For the disease is, so far, only known to affect the adult bees, and the larvæ appear to be quite healthy. And if one may reason from the fact that the bee-larvæ are unaffected, it appears likely that the queen usually escapes infection, probably by means of her special diet. Mr. Reid's reference to the silkworm is hardly analogous. If the disease to which he refers is *la pébrine*, it affects the larvæ, and, as Pasteur foretold, cures were effected by the destruction of the tainted stock and the importation of healthy eggs. I do not understand Mr. Reid to suggest this course, but, whether or no, it would be simpler to import the queen which laid the healthy eggs, which is the course he condemns.

In any case, the conditions of culture are so different that little practical comparison can be made between the bee and the silkworm moth.

Mr. Reid is upon sounder ground when he advocates breeding from those stocks which successfully resist the disease.

Brace and Burr Combs (page 438).—Attachments built from comb to comb, or to separator, are, generally speaking, combs proper, and such cross-combs are usually called brace-combs. They are properly so discussed in Mr. Soal's contribution on page 437. But those which we find under sections and frames (page 438) and those projecting knobs of wax on floorboard or hive are sometimes called burrs, or burr-combs. Such burrs are no doubt incipient, or actual, or moribund brace-combs, but the distinction appears to be useful and economical.

Honey-excluders (page 438).—Does not Mr. Soal rather miss the point here? Bees will, of course, store honey in a good season in spite of hindrances. But they are invariably (!) more ready to adopt shallow frames than sections, no doubt because of the freer and more intimate communication. Sections, without excluder, are almost safe from queen-intrusion, but not so shallow frames. And there is little doubt that the addition of excluder acts with greater detriment to the sections. If I may take Mr. Soal's own case cited, and suppose other things about equal, the shallow-frame yield was about double that from the sections. A big difference, to which, I have no doubt, the excluder-zinc contributed.

A USEFUL TOOL.

Several correspondents have written advocating different forms of useful hive-tools. We give an illustration of one that appeared in the B.B.J. some years ago, and was recommended for scraping propolis off frames and sections, and also for un-

capping combs. It is called a plumber's scraper, and is a triangular piece of flat steel, bevelled to a sharp edge on each side, which is about 2 in. In the centre

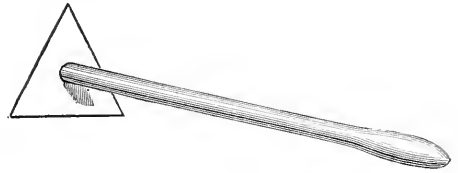

is fitted a wooden handle about 8 in. long. It may be had from any ironmonger, but care should be taken to ask for the triangular one, as there are oval and other shapes on the market.

Queries and Replies.

[3980.] *Indian Bees*.—1. I have two colonies of bees—one Italian and one black. From the beginning of this winter the bees have been dying off in large numbers. I am sending you a few bees under a separate cover. Could you tell me what is wrong with them and if there is anything that I can do to them? I fed the stock with syrup before packing them up for the winter. 2. I am interested in Indian bees. I have obtained from India specimens of natural comb of *Apis Indica* and *A. florea*, and I expect before long to get combs of *A. dorsata*. Could you tell me of a firm who will make for me foundation combs for these bees? I shall be much obliged if you will kindly answer my queries through the B.B.J., of which I am a regular reader. Thanking you in anticipation.—
MANNATHA K. RAY.

REPLY.—1. The bees sent showed signs of malnutrition, as the intestine was filled mainly with undigested pollen. You can do nothing now but see that your stocks are in warm, comfortable quarters and are well provided with wholesome food. Should the mortality continue, send some of the live bees for examination from the affected hive. 2. You would have to get foundation-rolls made expressly for the different sizes of comb of Indian bees, all of which differ from those of *Apis mellifica*. *A. Indica* has cells thirty-six to the square inch, while *A. florea* has them 100 to the square inch. Those of *A. dorsata* are considerably larger than those of the common bee. Probably the A. I. Root Company, Medina, Ohio, U.S.A., could supply you with the rolls to order, and any foundation-maker in this country could make the comb-foundation.

[3981.] *Fertilisation of Fruit-trees*.—Referring to your address at the Convegazione, published in B.B.J. of October 14, 1909, re "Beneficial Results from the Fer-

tilisation of Fruit-blossoms by Bees," will you please inform me of the name of a book which treats fully on this subject, also that of self-sterility? Is there, likewise, a book which gives the names of those of our fruit-trees (if any) whose pollen becomes ripe and is shed before the pistils are receptive? I have several fruit-trees from which, although there is a fair quantity of blossoms, I have not yet had any fruit, notwithstanding the fact that my hives stand near the trees. I trust you will favour me with a reply through the columns of the B.B.J.—READER, Withernsea.

REPLY.—We know of no book which treats fully on the subject, as the information was obtained from personal experience and experiments, and from information contained in articles appearing from time to time in various publications. The U.S. Department of Agriculture published in 1895 a report by M. B. Waite on the "Pollination of Pear Flowers" (Bulletin No. 5, Division of Pathology). This treats fully of the experiments made under the direction of the Chief of the Division of Vegetable Pathology. It also alludes to self-sterility of the different varieties of pears. You could consult "The Fertilisation of Flowers," by H. Müller, which gives a great deal of information about the ripening of pollen on different trees. In the gooseberry, pollen becomes ripe before the pistils are receptive, while the opposite takes place in the apple, pear, and strawberry. In the plum, cherry, currant, raspberry, and blackberry the stigmas and anthers ripen simultaneously, or nearly so, but there are other provisions for cross-fertilisation. The unfruitfulness of your trees may be due to other causes than improper fertilisation, such as a too vigorous wood growth, unhealthy conditions and lack of vigour, fungus attacks on the blossom, frosts, or bad weather during the flowering season.

Notices to Correspondents.

* * Mr. E. Powell, Clayton Nurseries, Hassocks, informs us that he has been appointed Hon. Sec. to the Sussex B.K.A., in place of Mr. W. Edwards, who has resigned.

G. M. (Hindhead).—*Suspected Disease.*—The bees sent appeared to be quite healthy, and from what you say they may have been chilled and died from cold. If you find the bees dying in large numbers, send a few, and we will examine them again. We have heard of disease being in your neighbourhood, so you must be on the watch and destroy any colony affected by it, as

nothing can be done to cure at this season of the year.

J. G. R. (Maidstone).—*Source of Honey.*—The honey contained mostly pollen-grains of lucerne and a few of chestnut, so it is most likely derived from a mixture of both.

G. H. (Worcester).—*"Apiculture Nouvelle."*—This is published monthly by E. Bondonneau, 56, Avenue Félix Faure, Paris, price 6 fr. 50 centimes a year.

W. A. (Southampton).—*Dead Bees.*—You are right in your conclusions as to the death of the bees.

E. G. F. (Minster).—*Peculiar Cells of Insect.*—The little mud cells you send are made by a species of *Osmia*, or mason-bee, thus named from the habit such bees have of agglutinating particles of sand or earth, or raspings of wood combined in the same manner, and of which they form their cells.

E. G. (Peterchurch).—*Books on Bee-flora.*—1. The only book on this subject in English is "Bee-Pasturage," by H. Dobbie, published by Jarrold and Sons, 11, Warwick Lane, London. It gives the approximate dates of flowering, and honey and pollen values of the plants. It was published in 1886, and has been, we believe, for some time out of print. 2. There is no society in England whose members carry out series of experiments connected with apiculture in the same way as the Swiss Bee-keepers' Society, which has observation stations in different parts of the country, and tabulates every year the results of observations and experiments. This is the only society that is doing systematic work of this sort.

Honey Samples.

S. R. (Surrey).—Very thin honey with an acid flavour. Microscope showed pollen-grains of aster, raspberry, radish, buttercup, and cucumber. Probably the flavour and want of consistency are due to the proximity of a sweet-shop or factory.

CARBOULD (Salop).—Fruit-tree honey, which seems to have been over-warmed when liquefying it. Flavour and aroma, though mild, suggest apple-blossom as the source.

G. M. S. (Leicester).—Honey is of a sickly flavour, which we cannot quite define, and it is also fermenting.

T. H. C. (Lewes).—1. The hon. sec. of the Sussex B.K.A. is Mr. E. Powell, Clayton Nurseries, Hassocks. 2. Honey of inferior quality, thin in consistency, and of dark colour. We should say the probable source is mainly ivy-blossom.

* * * Several important letters, &c., are in type, but held over from pressure on our space.

Editorial, Notices, &c.

REVIEW.

Ueber die unter dem Namen "Faulbrut" bekanten seuchenhaften Bruterkrankungen der Honigbiene. By Dr. Albert Maassen (published by Paul Parey, Berlin. 1.10 mark—1s. 2d.).—This is a second edition of the report of the Biological Institute, Dahlem, which we have on several occasions alluded to, and in it Dr. Maassen mentions his further investigations and observations, and confirms his previous work on foul brood in bees. This, he finds, is caused by three different microbes, known as *Bacillus alvei*, *Streptococcus apis*, and *Bacillus Brandenburgensis*. The disease is one of the alimentary canal of the larva, and occurs in two forms, in one of which the larvæ die mostly before the cells are sealed; while at the commencement of the attack hardly any die in the cells that are already closed, but the mortality in these increases in later stages of the disease. In this form of the disease *B. alvei* is found to be the cause, it being frequently associated with *Streptococcus apis*. In the second form of the disease the larvæ die only shortly after the cells are sealed over. Dr. Maassen finds this due to *B. Brandenburgensis*, and says in the earlier stages the disease is much more difficult to diagnose, as only single cells scattered here and there amongst the brood become affected, and these are easily overlooked by the bee-keeper. They can, however, be recognised on careful scrutiny by the slightly depressed cap-pings, and on old combs there may be seen minute perforations. On opening such cells the foul brood mass can be drawn out, or will be found as a dried-up scale in the older cells. This form of the disease is easily recognised in the autumn, when all the healthy brood has hatched, leaving the affected cells dotted over the combs. Sometimes both forms may be present at the same time, and may be associated with sour brood, in which is found *Streptococcus apis*. This last, however, as we have already mentioned, is generally found in company with *B. alvei*, and appears to struggle for supremacy with that organism. The prevalence of the one or the other can usually be recognised by the odour, that of streptococcus producing one similar to sour paste. Both microbes were found in large numbers mixed with undigested pollen in the alimentary canal of larvæ, and in later stages they permeate the body, the foul brood masses remaining being filled with cocci and spores.

Dr. Maassen calls the disease produced by *B. alvei* "stinkende Faulbrut" (strong-smelling or stinking foul brood)

and that by *B. Brandenburgensis* "nicht-stinkende Faulbrut" (odourless foul brood). He mentions that he found both forms of the disease present at the same time on the same comb. The danger of foul brood may be judged by the remarkable instance mentioned of the wonderful vitality of the spores of bacilli, as Dr. Maassen found them capable of germination after being dried for so long a period as twenty-two years. He also found the cocci alive after one and a quarter years' drying.

He describes the various ways by which the disease is propagated, such as indiscriminate mixing diseased with healthy colonies, interchanging combs, and promiscuously uniting bees. The best remedy he finds is starvation of the bees, removing combs, disinfecting hives, and making bees build fresh combs. The method advocated in this country of confining the bees for forty-eight hours is amply sufficient if carried out with the other instructions, as Dr. Maassen has found that a confinement of twenty-four hours is even enough if the bees build new combs. Combs, frames, quilts, and everything taken out of the hives should be burnt to destroy the spores. A good deal of space is devoted to methods of disinfection, and great stress is laid on this being done effectually. He recommends for hives and appliances that have come in contact with the disease disinfection with a hot solution of soda, the flame from a blow-lamp, quicklime, and soda mixture and soap. The best way of applying each is fully described. It is reassuring to find that Dr. Maassen's experiments show that there is little danger from the spores that may lurk in the wax, for when it is melted they become imprisoned in it, and as bees do not carry about wax the spores are thus rendered harmless. If, however, the wax is to be used for making comb-foundation, he recommends melting it at a temperature of 108 deg. Centigrade in a 30 per cent. solution of common salt, half an hour at this temperature being sufficient to destroy the vitality of the spores.

The work is beautifully illustrated, for, in addition to the photographs of the different microbes, there are enlarged coloured figures shown of healthy and diseased larvæ in open cells, and a section of dying larvæ after the cells are sealed over, giving their appearance when attacked by the two different bacilli. We have only given a brief outline of the work, but it is a valuable addition to our knowledge of the disease as it is found in Europe, especially as it agrees with the findings of Dr. Burri and Dr. Zander. We take this opportunity of acknowledging our indebtedness to Dr. Maassen for cultures of the three different microbes found in foul brood,

which he has been good enough to send us, and also for some microscopical preparations of *B. Brandenburgiensis*, showing clearly the *spirochate*-like flagella characteristic of this organism.

BREEDING THE BRITISH GOLDEN BEE IN RIPPLE COURT APIARY.

HOW MATING IS CONTROLLED.

By F. W. L. Staden, F.E.S.

Breeding together successive generations of bees that gather the most honey, with the object of obtaining and improving a variety that will gather more honey than ordinary bees in the British climate—which during the season of bee-activity is cooler, more windy, and more cloudy than that of other countries in which bees are bred—has been carried on in Ripple Court Apiary, near Dover, from about 1892 until the present time. The work was begun with English-Italian hybrids, these having been found often to produce larger honey-yields than ordinary English bees and the queens to be more prolific. During 1901, 1902, and 1903 these bees were crossed with a good strain of American Golden. Since 1903 none but queens bred in Ripple Court Apiary have been allowed to produce queens and drones there. In order to ensure the fathers being of selected parentage, it was found necessary to maintain the golden colour, because by no other means can the progeny of queens mated with drones of selected parentage be readily distinguished from the progeny of those mated with ordinary English black drones. A golden bee, differing in many respects from the American variety, has been the result.

One new generation is bred each year. About fifty golden-coloured queens, bred the previous season from the best honey-gathering parentages and producing mostly or only golden-coloured workers, have the honey-gathering characters of their colonies carefully compared in May and June, attention being also paid to hardiness and prolificness. As many drones as possible are bred from about six or seven of the best of these queens and the queens from three or four of the very best, a few queens and drones being also bred, chiefly earlier in the season, from a particularly good breeding queen or two of the previous year.

In recent years records have been made of the colouring of the workers produced by the queens mated at Ripple Court Apiary under various conditions. These records have shed some useful light on the conditions under which select matings take place, making it possible to secure them better and more easily than formerly.

The subjoined tables give the records of the matings of all the golden-coloured queens of known parentage, mated from,

and tested in, small nuclei in Ripple Court Apiary in 1908:—

QUEENS OF "V" PARENTAGE.

This parentage produced only golden-coloured queens and workers.

No. of queen.	Date (when appeared to have been mated).	Weather at this date.	Approximate proportion of golden to intermediate coloured workers produced.	Age mated.
1	July 19	R 10	golden to 0 intermediate	12 days.
2	" 22	R 8	" " 2	" 15 "
3	" 23	F 5	" " 5	" 16 "
4	" 23	F 0	" " 10	" 16 "
5	" 24	F 3	" " 7	" 9 "
6	" 25	F 8	" " 2	" 7 "
7	" 25	F 3	" " 7	" 7 "
8	" 28	F 5	" " 5	" 20 "
9	" 30	F 7	" 3 bright "	" 9 "
10	" 30	F 5	" 5 intermediate	" 9 "
11	Aug. 4	F 10	" 0	" 6 "
12	" 4	F 7	" 3	" 9 "
13	" 4	F 9	" 1	" 6 "
14	" 4	F 1	" 9	" 9 "
15	" 4	F 5	" 5	" 7 "
16	" 9	FR 0	" 10	" 14 "
17	" 9	FR 10	" 0	" 8 "
18	" 9	FR 8	" 2	" 8 "
19	" 9	FR 10	" 0	" 8 "
20	" 17	R 10	" 0	" 13 "
21	" 17	R 10	" 0	" 13 "
22	" 17	R 10	" 0	" 12 "
23	" 17	R 9	" 1	" 13 "
24	" 17	R 9	" 1	" 16 "
25	" 17	R 10	" 0	" 16 "
26	" 19	R 10	" 0	" 15 "
27	" 19	R 10	" 0	" 15 "
28	" 27	R 3	" 7	" 15 "
29	Sept. 6	R 10	" 0	" 13 "
30	" 6 to 8	R 9	" 1	" 25 to 27 "
31	" 6 to 8	R 9	" 1	" 19 to 21 "
32	" 8	R 10	" 0	" 15 "

QUEEN OF "D" PARENTAGE.

This parentage produced only golden-coloured queens and workers.

35	July 6	FR 8	golden to 2 intermediate	16 days
----	--------	------	--------------------------	---------

QUEENS OF "A" PARENTAGE.

This parentage produced about nine goldens to one intermediate.

34	July 12	FR 3	golden to 7 intermediate	18 days.
35	Aug. 4	F 3	" 7	" 6 "
36	" 4	F 8	" 2	" 6 "
37	" 4	F 8	" 2	" 6 "
38	" 9	FR 10	" 0	" 11 "
39	" 9	FR 9	" 1	" 11 "
40	" 9	FR 2	" 8	" 8 "
41	" 17	R 10	" 0	" 19 "

QUEENS OF "R" PARENTAGE.

This parentage produced about eight goldens to two intermediates.

42	July 6	FR 8	golden to 2 intermediate	10 days
43	" 12	FR 8	" 2	" 11 "
44	" 15	R 10	" 0	" 14 "
45	" 22	R 9	" 1	" 21 "
46	" 25	F 10	" 0	" 24 "

QUEENS OF "C" PARENTAGE.

This parentage produced about seven goldens to three intermediates.

47	July 24	F 1	golden to 9 intermediate	12 days.
48	Aug. 17	R 8	" 2	" 12 "
49	" 17	R 5	" 5	" 12 "
50	" 22	FR 0	" 10 bright	" 11 "
51	" 22	FR 10	" 0 intermediate	" 15 "
52	" 22	FR 7	" 3	" 11 "
53	Sept. 6	R 10	" 0	" 30 "
54	" 6 to 8	R 1	" 9	" 22 to 24 "

QUEENS OF "T" PARENTAGE.

This parentage produced about six goldens to four intermediates.

55	July	20	R	All b'tw'n golden and intermediate	17 days.
56	..	23	F	0 golden to	10
57	..	23	F	0	10
58	..	25	F	7	3
59	..	25	F	5	5

NOTE.—In most cases the goldens include some dark goldens, and the intermediates some bright intermediates. No blacks and very few dark intermediates were produced.

ANALYSIS OF THE ABOVE TABLES.

Mated in	Free Mating Weather (F.)		Less Free Mating Weather (FR.)		Restricted Mating Weather (R.)		TOTAL.	
	Golden.	Inter-mediate.	Golden.	Inter-mediate.	Golden.	Inter-mediate.	Golden.	Inter-mediate.
"V" Parentage	36	44	8	2	18	2	54	46
"D"	3	7	3	2
"A" ..	10	0	16	4	19	1	35	7
"R" ..	1	8	45	5
"C" ..	12	28	1	9
"T"	12	28
All Parentages	59	81	27	13	37	3	123	97
"V" Parentage	32	18	28	12	119	11	179	41
"A" ..	19	11	21	9	10	0	50	20
"R"	17	13	24	16	41	29
"C"
All Parentages	51	29	66	34	153	27	270	90
JULY, AUG., and SEPT.	110	110	83	47	150	30	335	187
All Parentages

PARTICULARS OF THE WEATHER ON ALL MATING DAYS AFTER JULY 4, 1908.

July 6.—Temperature, 67 deg. at noon, 65 deg. at 1 p.m., and 62 deg. at 3 p.m.; light S. wind and clear sunshine all day. (FR.)
 .. 12.—Temperature, about 70 deg. between 11 a.m. and 12.30 p.m., with light S.S.W. wind; intermittent sunshine till 12.40, then thunderstorm. (FR.)
 .. 15.—Temperature, 63 deg. at 12, 65 deg. at 1, 64 deg. at 1.30; fresh S.W. wind; rain till 12.40, then sunshine. (R.)

July 19, 20, 21.—Temperature, 63 deg. to 64 deg. at 11 and 1; fresh N.E. wind; intermittent sunshine. These days were almost exactly alike. (R.)
 .. 22.—Temperature, 63½ deg. at 1.40 and 63 deg. at 3.20; very light S.E. wind, with clear sunshine all day. (R.)
 .. 23.—68 deg. at noon, 70 deg. at 1.30, 71 deg. at 3.20; calm; sunshine all day, hazy in afternoon. (F.)
 .. 24.—Maximum temperature, 74 deg.; very light S. wind; sunshine all day. (F.)
 .. 25.—Maximum temperature, 77 deg.; calm, rather cloudy. (F.)
 .. 28.—70 deg. at 1 p.m.; light N.E. wind; sunshine almost all day. (F.)
 .. 30.—71 deg., with light S. wind at 1.20; sunshine all day. (F.)
 Aug. 4.—75 deg. at 11.30 and 1; light variable wind, almost continuous sunshine. (F.)
 .. 9.—72 deg. at 12.30, with fresh S.W. wind; 72 deg. at 1.45, with light S.W. wind; sunshine till 1.45. (FR.)
 .. 17.—63 deg. at 1.30; light N.E. wind, almost continuous sunshine. (R.)
 .. 19.—64 deg. at 12.30, 64½ deg. at 1.30, 64 deg. at 2; light N.E. wind at 12.30 and 2, almost fresh at 1.30; a few more clouds than on 17th. (R.)
 .. 22.—66 deg. at noon, with strong S.S.W. wind; 69 deg. at 1, with fresh S. wind; 70 deg. at 1.30, with light S. wind; 69 deg. at 2, with no wind; almost continuous sunshine from 1 to 3.30. This fine weather was in the centre of a deep storm, rough weather immediately preceding and following it. (FR.)
 .. 27.—68 deg. at 1.30; strong W. wind; intermittent sunshine. (R.)
 Sept. 6.—63 deg. at 12.30, with fresh W. wind; 65 deg. at 1.15, with fresh W. wind; 64 deg. at 1.30, with fresh W. wind; 65 deg. at 1.45, with light W. wind; intermittent sunshine. (R.)
 .. 7.—63½ deg. at 2.30, with fresh S.W. wind; continuous sunshine. (R.)
 .. 8.—65½ deg. at 11.30, with light S.W. wind; 66 deg. at 1 and 1.30, with fresh S.W. wind; sunshine interrupted between 12.20 and 12.30, and at intervals later. (R.)
 The thermometer was exposed in windy places in the shade outside the apiary; the temperature inside the apiary was generally about 1 deg. higher. Mr. S.

Miller has kindly allowed me to compare my notes of sunshine with the records of his self-registering instrument exposed at Deal.

The date a queen is stated to have been mated was calculated as being two days before the queen appeared to have begun laying, except when that day was an unfavourable one for queen-flight, and this was the case only in September, in which month some queens started laying several days late, and a few, apparently fertilised, did not lay at all. In many cases it was not certain on which of two consecutive days a queen began to lay.* The above-listed mating days were, without exception, more favourable for flight than the unmentioned days immediately preceding and following them.

Workers having the three basal segments of the abdomen clear yellow and the middle of the fourth segment yellow are classed as golden-coloured; those having the three segments yellow and the middle of the fourth black are also classed as golden. Bright intermediates have the abdomen coloured as in pure Cyprians, medium intermediates as in ordinary pure Italians, and dark intermediates as in a cross between Italian and English bees.

It was calculated that about 20,000 drones emerged towards the end of June in Ripple Court Apiary, about 30,000 during July, and about 5,000 in August—altogether about 55,000. Roughly, about 80 per cent. of these had the first four segments yellow. The remainder had only the first three segments yellow, and were probably a kind of bright intermediate; as such they would transmit some black "blood." A few dozen darker intermediate drones were produced in June and July. In May a few dozen black drones were produced from intermediate-coloured queens, but they were not seen in July or August.

The above tables, together with the records—unfortunately not preserved complete—of matings from a number of other hives in Ripple Court Apiary, and in isolated spots near it, show that the proportion of golden to intermediate bees produced varies as the result of several conditions.

Firstly, golden queens, bred from a parentage ("V") that gave all goldens, produced a larger proportion of goldens than did golden queens bred from parentages that gave some goldens and some intermediates. The difference in this respect between the parentage "V" and the parentage "C," which gave a large proportion of intermediates, was very noticeable in a comparison between

many queens of these two parentages mated in August and September, 1908, from other hives.

Secondly, queens mated in August and September produced a larger proportion of goldens than those mated in June and July. This has been noticed for some years, and I believe is due partly to the fact that drones in normal colonies in neighbouring apiaries are turned out to die at the end of the honey-flow (while in Ripple Court Apiary they are kept several weeks longer in colonies headed by virgins, &c., and by other means), and partly to another cause to be explained later.

Thirdly, a larger proportion of goldens is produced from matings that take place at a temperature of about 63 deg. on a calm and sunny day, or in a slightly higher temperature—namely, about 64 deg. to 68 deg.—if there is wind, than from those that take place in a high temperature—namely, about 70 deg. or more. This interesting fact was also noticed in 1907 and in the 1908 matings from other hives. The obvious reason for it is that the lower temperature and wind so restrict the flight of queens and drones that the drones of neighbouring apiaries cannot reach the queens of Ripple Court Apiary, these being mated close to Ripple Court Apiary by Ripple Court Apiary drones. It is evident that by selecting queens that have been mated in such restricting weather for testing and breeding purposes we have succeeded in breeding bees by selection. This fresh help in breeding bees by selection is likely to prove a valuable one.

The fact that queen No. 28 ("V" parentage), which was the only queen in the apiary that appeared to have been mated on August 27 (a very windy day), produced a smaller proportion of goldens than of intermediates is noteworthy. I hardly doubt that this queen was mated by a dark drone from Ripple Court Apiary. No. 54 may have been a similar case. Excluding No. 28, we get the remarkable total of 134 goldens to only six intermediates from the fourteen matings in restricted weather, and 116 goldens to only four intermediates from the twelve matings after the middle of August, of queens bred from a parentage giving all goldens. (To be continued.)

HOMES OF THE HONEY-BEE.

THE APIARIES OF OUR READERS.

The account of his early bee-keeping days contributed by Mr. F. W. Spratling will be found both interesting and useful, especially by those who have difficulty in disposing of their produce. If Mr. Spratling's business acumen and energy were

* It was only by taking this fact into consideration that a mating-day could always be found two days earlier. In some of the 1909 cases it was definitely ascertained that laying did not commence until three days after mating.

more often found among bee-men there would be no lack of buyers for the honey-crop, however large it might be. He says:—

"I could fill many columns of the B.B.J. with my experiences in bee-keeping since I started in 1894, but being of a retiring disposition I shrink from too much publicity. It is a genuine pleasure to me to render help to others and give to those engaged in this fascinating craft the benefit of any experiences of mine which may be useful. I started purely from a commercial point of view, without any previous knowledge of bees, but when a brand-new bar-frame hive came from the makers, and with it a 'British Bee-keepers' Guide Book,' the mystery and art of putting frames together, wiring, and the fixing of foundation were soon solved. The hive being put in

all that could be wished. But the neighbours did not eat honey, or did not like it. They found it useful for children if they had a cold; but they never thought of using it as a regular article of food. What a job I had to sell 7 lb. that winter, the remainder being sold to a confectioner at 40s. per cwt.

"Next season my stocks had increased to five, and No. 5 (for we began to number them) itself gave me 130 lb. of honey in the supers, and the surplus from the five stocks totalled about 3 cwt. The question now arose, 'How shall I sell it?' Having had a business training and possessing a liking for the wholesale line, I determined to have a week's travelling in some of the large towns and cities, and with my bag and samples of honey nicely got up, with the



APIARY OF MR. F. W. SPRATLING, HAGONBY, BOURNE, LINCS.

position and ready, the next step was the purchase of a swarm of bees, which rushed with gladness into their new, clean home. The next day, I remember, was sweltering hot—too hot for me—but the bees were rushing in and out, to and fro, seemingly in high glee, and working their very hardest. I said to myself, 'These are the boys for me. When it's too hot for me to work they are just in their glory. I'll get a hundred stocks, and they shall work while I wait on them.' My surplus at the end of the season was two full supers of honey, which I extracted with the Association extractor. We soon had some on the table, and found it of good flavour. But I had yet to learn that our rich fertile soil would not produce the high-grade honey that was in demand at a good price as a table delicacy. Locally my honey was considered

price-list arranged in a business-like manner, I soon sold out, and could have got rid of much more. I found an enormous demand existed for sections. Customers admired the jar and get-up of my samples, but were not quite sure about the quality of the honey. I felt certain, when I saw, smelt, and tasted a delicious sample obtained from one place at which I called, that mine could never compete successfully with it. I took home a jar of this honey and examined it from all points scores of times, wondering how I could get a sample like that. Eventually a plan was decided upon; new hives were made at home and stocked during that winter, bringing the number up to twenty-five. These were all ventilated for travelling, and in the spring sites and locations for out-apiaries were obtained in different villages and upon different

soils, extending over twenty miles. In this way I went on experimenting until the districts were found where honey could be obtained that would *make* customers and hold its own wherever it went.

"The accompanying view shows a portion of my present home-apiary, which varies in number from eighty to two hundred stocks. I both buy and sell, despatching bees to all parts of the United Kingdom. Many hundreds of stocks have thus passed through my hands. I send honey into nearly every county and require about 2 cwt. annually for my local retail customers—a decided advance on the first 7 lb. I sold. I also send to old residents who have removed into other parts of the country. I adopt throughout business methods in grading the produce, also in quoting prices, which vary with quantity and season. The last sunless season was disappointing here as elsewhere; but the one redeeming feature about a short crop is that it clears the market.

"All my stocks have gone into winter quarters in good form with plenty of stores. I should not be surprised to see dysentery rather prevalent in the spring. A lump of camphor on top of the frames I find a very good preventive of this complaint. With best wishes to all the craft, hoping for a good season in 1910."

Correspondence.

The Editor does not hold himself responsible for the opinions expressed by correspondents. No notice will be taken of anonymous communications, and correspondents are requested to write on one side of the paper only and give their real names and addresses, not necessarily for publication, but as a guarantee of good faith. Illustrations should be drawn on separate pieces of paper. We do not undertake to return rejected communications.

NOTES BY THE WAY.

[7693.] After a fairly fine November, cold, wet, and boisterous weather has returned, and I have no doubt that in exposed apiaries some stocks have suffered damage from storms. In my own apiary some of the covers were blown off and the wrappings saturated with rain, but no stocks were overturned, so that no serious harm resulted. After such a driving rain it will be wise to examine hives to see if the quilts are wet, and if so replace them with dry, warm material before colder weather prevails.

I can personally endorse "D. M. M.'s" opening paragraph on page 453. By following such lines I am satisfied I have gradually improved my stock of English bees during the past quarter of a century, and though I have produced some fine queen-cells by the "Alley" method in past years from eggs from selected queens (*i.e.*, queens of my best all-round stocks), I have found the queens reared naturally

by the bees of these stocks equal, if not superior, in every respect to those artificially produced.

Feeders.—May I remind readers that floorboard feeders are not suitable for winter feeding, and at this period food should be given in the shape of soft candy only, placed over the cluster of bees. I would here give a word of advice to beekeepers who have much honey-dew stored in the brood-nest. This is not good bee-food during the winter, when the bees are confined to the hives for long periods without the chance of a cleansing flight. A large cake of soft candy should be given to the stocks; this, if placed over the cluster, will be taken before the stores below, and help to counteract the effects of long confinement on a diet of mostly honey-dew. By and by, in the coming spring, when the bees get frequent opportunities of flight, the stores will have no injurious effects.

Mr. Soal (page 476) again refers to the use of the term "strain," and as I am one of the alleged offenders in this respect I should like to explain that when I mentioned my intention of using the queen of one of my best honey-gathering stocks this year for a breeding queen next season, I believe I stated that the stock was founded from a lot of driven bees the year before; but I ought to have added that these bees were from a swarm of my own bees the year previous, so that the pedigree of these good workers has been in my own stock for many years. I therefore claim I was justified in applying the term "strain" to them and deny that they are "casual mongrels."

As regards the zinc excluder, I always put it under shallow frames, but I prefer to be without it under racks of sections; others who work their supering differently may use it with satisfaction to themselves. My old friend of the past, Mr. John Walton, used it with sections, and did not consider it impeded the bees much.—W. WOODLEY, Beedon, Newbury.

HAS THE B.B.K.A. OUTLIVED ITS USEFULNESS?

[7694.] The answer to this question, asked by Mr. Avery in your issue of the 25th ult. (page 466), is, I should like to say, humbly yet emphatically, "No." I think the truth lies in the fact that the parent Association has been allowed to drift into the troubled waters in which many a county association has found itself through an incapacitated secretary, unfortunately in this case owing to his bad health.

No one knows better than your correspondent that the very life of our county associations depends on the choice of an energetic secretary—one who will do the work of the association faithfully and

persistently for the love of it; and I maintain that the Council of the B.B.K.A. has put its finger on the weak spot in its organisation and remedied the defect by securing the services of a most capable man to fill the post. I feel sure that if Mr. Herrod can be permanently installed in the office a new era will have dawned for the society, and its prolonged usefulness be assured.

One other suggestion I should like to make, the need for which is emphasised by the statistics given in the editorial note to Mr. Avery's letter as to the attendances at Council meetings of the representative members of the affiliated associations, and that is that the meetings of the Council should occasionally be held in other parts of the country than London. The Council cannot reasonably expect the members from, say, the North of England to attend its meetings held in the metropolis; time and expense prevent many who would otherwise attend. Think what it means for a Northern county representative to attend the London meeting of the Council. He must be away from his business at least two days, and spend about £3 in travelling and hotel expenses, which very few men can afford to do. If some of the meetings were held in, say, Carlisle, York, Liverpool, and Birmingham many county representatives would attend. One of our most enthusiastic members, speaking to me on this subject at Lancaster quite recently, said that, although he was only a working man, he would willingly attend a meeting held within reasonable distance, even though it meant the loss of one day and cost him a sovereign in expenses, and I am sure such men as this would prove as much a tower of strength to the Council in its deliberations as they are to the county associations. I know that on our county committees we owe much to these men, but we could not expect them to attend our meetings if we always held them in the same place, especially if that place was a corner of the county. By having monthly meetings in different parts of the county we get a fairly representative gathering each time. Let the B.B.K.A. Council consider this suggestion, and if acted upon I am certain they will have no cause to complain that the county representatives do not attend the meetings, and it will act like an infusion of fresh blood into the very vitals of the organisation.—JAMES N. BOLD, Hon. Sec. Lancs B.K.A.

[7695.] My contribution in B.B.J. of the 25th ult. called forth a footnote from the Editor, which I hope I may be allowed to answer before proceeding with any further suggestions as to the management of the B.B.K.A. There was a

time, it seems, when the Council was elected from members residing at a distance, but they did not attend the meetings. The main reason for this, as I pointed out in my last, was, I suppose, because the meetings were all held in London, and naturally members weighed the expense of attending against the benefit to be derived, and decided the game was not worth the candle. The Editor reminds me I am one of sixteen county representatives who might attend, but do not. It might be instructive to explain the reason for this, but before I do so let me say that it is a great trial to me to remain away from any meeting held for the purpose of discussing apicultural matters. The representative of Cumberland, if he fulfilled all his obligations as such, would find his position, in addition to being laborious, very costly as well. The work and expense, to say nothing of the responsibility, of his secretarial duties are very heavy, but over and above these his county expect him to represent them at B.B.K.A. meetings when necessary. Before he can exercise his full powers on the Council of the latter he must pay a subscription of not less than 5s., and also the whole of his expenses to the meetings in London. This would cost him over £30 a year for railway fares alone, to say nothing of other expenses. I am quite sure, if the Editor will look round among the sixteen representatives he refers to, he will find among them men who are giving evidence of being quite as eager for the advancement of bee-keeping as any member of the B.B.K.A. Council can be.

I cannot speak for any of my brother representatives, but I hope that the B.B.K.A. Council do not assume that because I stay away the county I represent is satisfied with the work they accomplish. We are satisfied thus far, that so long as the parent Association is content to move along in the same old groove it is useless to come all the way to London to help to do the usual routine which those near at hand are willing and able to do.

On one historic occasion only has the representative of Cumberland attended a meeting. Although a full number of the representatives the Editor refers to also attended, and almost unanimously laid a request before the Council for help in furthering what is universally held to be the most necessary reform for the advancement of bee-keeping in the counties, the result was such that the dissatisfaction then created remains still. This is sufficient to deter any more useless expenditure in that direction by the C.B.K.A. or its representatives.

Among the associations the position of the B.B.K.A. is unique, inasmuch as the

only information regarding its doings which reaches the public comes through the B.B.J. This paper, invaluable as it is to bee-keepers, has, though quite unintentionally, done the B.B.K.A. harm in the past. The B.B.K.A. is pointed to as the petted and spoiled child of the B.B.J. No mother defends a spoiled child from the slightest breath of adverse criticism so effectually, and anything not altogether laudatory of the B.B.K.A. is published under protest, with the result that a free public opinion of that body never finds expression. A fine feeling of regard for the Editor himself, mingled with a natural aversion to be "hauled over the coals" in a critical footnote from the editorial chair, overcomes the desire to criticise from a sense of public duty.

The Editor tells us that the meetings of the Council frequently last three or four hours. The rank and file of bee-keepers do not even know that there exists an association representing their craft and spending so much time on their behalf, and for this the Association alone is to blame.—G. W. AVERY, Hon. Sec. Cumberland B.K.A.

NOTES FROM BERKSHIRE.

[7696.] The thanks of readers are due to "Medicus" (B.B.J., November 25, page 463) for his able and instructive article concerning honey-secretion. The observations made do indeed upset some of our ideas in that direction. But I recollect some years ago Mr. S. Simmins, writing in B.B.J., stated that we seldom get a honey-flow with the wind in the north, but that when this does happen the bee-keeper will not soon forget the experience, so great is the quantity of honey stored.

Results from my own bees this year are not worse than usual, my "take" being an average one. Eighteen stocks yielded about 800 lb. of extracted honey, good in point of flavour and density, but dark in colour, though free from honey-dew. This locality is a poor one for honey, there being no clover or sainfoin grown, and no mustard. There are limes and heather about a mile away, plenty of hawthorn and blackberries, and a little clover by the roadside. When cool winds prevail in June very little honey is gathered, the bees storing only in corners of combs and along the top-bars. I have not worked for sections for some years, as the honey-flow is not abundant enough to produce good comb honey. Stocks are generally slow in building-up in spring, so that I have to unite regardless of the fate of queens. Two small lots (six or seven combs) united late in May usually turn out a splendid stock later. These are the ones that know their way about; they are out for honey, and honey they will

get while individual stocks may be doing little or nothing. The best results this year were from lots made up as stated, 60 lb. to 70 lb. surplus being taken off each, leaving them well stored below. Of course, this is but a proof of Mr. W. Woodley's contention (and that of other writers of experience) that an immense force of adult bees must be secured out of proportion to the quantity of brood.

The observations recorded by "Medicus" show that, though a heavy flow may be on for an hour or two in the forenoon, it can be almost nil later in the day. I was made aware of this fact myself when the weather improved in early August. There was a profusion of blackberry blossom half a mile distant, and from about 6 to 9 a.m. the roar of the bees overhead in their flight to and from this forage astonished the passers-by, the bees coming home with fully-distended honey-sacs. After the latter hour, however, the quantity of nectar carried fell away to almost nothing.—H. O. B., Swallowfield, Berks.

INTERESTING EXPERIENCES.

[7697.] In the hope of interesting readers of your valuable B.B.J., I venture to relate one or two incidents which occurred to me whilst "bee-keeping" during the past season.

A Starving Stock.—A friend started bee-keeping by purchasing two established stocks in the autumn of 1907. He took about 30 lb. of honey from them in 1908, and omitted to feed up for the winter, except that each stock was given a 2-lb. cake of candy in November. On the Thursday before Good Friday of this year I received word from my friend that one of his stocks was dead from want of food, and requesting me to go over and examine the other. I went as desired, and found the surviving stock in fair condition as regards the number of bees, but one small patch of sealed honey—not more than 3 in. or 4 in. square—represented all the stores they had remaining. There was a small disc of brood, all sealed, on one side of one of the middle combs only, and no unsealed brood or eggs were to be seen. I suggested waiting till evening when the bees had ceased flying, and then filling the hindmost frame with warm syrup. This we did, with the extraordinary result that the bees began to fly in and out of the hive as if it had been noon on a sunny day. I told my friend to examine the stock in about a week, and, if necessary, give a further supply of syrup in the same way. He did so after a lapse of ten days, and was surprised to find an abundant supply of brood in four frames, the response given by the queen being so

prompt that a considerable quantity of the brood was sealed.

The second supply of syrup proved sufficient to tide the stock over until it could support itself, and by June 1 the hive was teeming with bees, which gave 30 lb. of good extracted honey at the end of the season. This stock will not run short of stores during this winter; its owner has had his lesson and profited by it.

A Swarm Returning.—One day during the first week in June I was told that one of my stocks was swarming, and found the swarm settling on the branch of a pear tree. I soon noticed the cluster diminishing and the bees rapidly returning to the hive, and on examining the hive I found the queen with about a dozen attendant bees on a stone flag in front of the entrance. I placed her on the alighting-board, she re-entered the hive, and the bees soon settled down. About three hours later the swarm came off again, and settled in the exact spot on the same branch as before, but this time taking the queen with them. This appears to be a good illustration of the fact that the swarm leads the queen and not the queen the swarm.

A Curious Swarm.—About the middle of May I examined my strongest stock, and found several queen-cells, two of them apparently close on hatching. The hive was some distance from my home, so I requested a bee-keeping friend who lived near to keep a look-out for the swarm if it should come off. The weather became very cold and wet, and the stock did not swarm. On June 1 I examined the stock again, and found two empty queen-cells and removed the others. I paid another visit on June 3, and whilst there, about 2.30 in the afternoon, the swarm came off. The weather was cold and dull, and instead of clustering the bees alighted on the trees and shrubs and on the ground—everywhere but in a cluster. After some time the bees that had kept on the wing formed two distinct clusters, about 4 ft. apart, on a thorn hedge. All the other bees that had alighted returned to the parent stock. The two clusters, which would measure each about a quart, were hived into a skep and returned to the parent stock at dusk. Unfortunately the evening was too dark for me to discover the queen or queens, but I came to the conclusion that the stock was re-queening itself (the queen being in her fourth year), and that the delay in swarming was due to the unsettled weather. The stock gave me a rack of sections splendidly finished, and gathered sufficient stores for wintering without extra feeding.—S. R. P. FISHER, Preston.

WEATHER REPORT.

WESTBOURNE, SUSSEX,
November, 1909.

Rainfall, .99 in.	Minimum temperature, 27° on 24th.
Below average, 2.06 in.	Minimum on grass, 20° on 24th.
Heaviest fall, .58 in. on 29th.	Frosty nights, 10.
Rain fell on 10 days.	Mean maximum, 47.4.
Sunshine, 98.9 hours.	Mean minimum, 35.2.
Above average, 31.7 hours.	Mean temperature, 41.3.
Brightest day, 8th, 5.9 hours.	Below average, 2.2.
Sunless days, 2.	Maximum barometer, 30.425 on 24th.
Maximum temperature, 55° on 3rd.	Minimum barometer, 29.389 on 30th.
	L. B. BIRKETT.

NOVEMBER RAINFALL.

Total fall, 1.14 in.
Heaviest fall in 24 hours, .31 in. on 14th, from snow.
Below average, 1.84 in.
Rain fell on 16 days.
W. HEAD, Brilley, Herefordshire.

Obituary.

THE REV. E. DAVENPORT.

We regret to have to record the death of the Rev. E. Davenport, which took place at The Hoo, Knightwick, Worcester, on November 20, the immediate cause of death being cystitis.

Mr. Davenport had been a bee-keeper for more than fifty years and a subscriber to the B.B.J. from its commencement, as well as a frequent contributor to its pages. He was one of the first eight candidates who were awarded first-class expert certificates in 1882, the examiners on that occasion being the Hon. and Rev. H. Bligh, Mr. T. W. Cowan, and the Rev. G. Raynor, two of the three being now dead. In 1884 he was appointed travelling expert to the Hants and Isle of Wight B.K.A., and made two tours through the county, that and the next year; and in 1886, on his going to live at Stourport, he became the official expert to the Worcester B.K.A. He was for some time one of the representatives of this association on the Council of the B.B.K.A., and frequently attended the meetings.

Mr. Davenport was a Congregational minister, and held pastorates at Rushworth, Hants, Hungerford, Berks, and Stourport, Worcester, but retired from the active ministry in 1894, devoting his time after that to bee-keeping and lecturing. At the time of his death he was lecturer on bee-keeping under the auspices of the Worcester County Council, and has also lectured in Gloucestershire and Hants. He was a capable and fluent lec-

turer, and there are many bee-keepers who can testify to the usefulness of his work. He was one of the founders of the Wilts B.K.A. in 1881, and his name appears on its first committee; in fact, it was in Mr. Davenport's dining-room in Hungerford that all the preliminaries were settled with the Rev. W. E. Burkitt, of Buttermere, and others, on the occasion of the Marlborough and Pewsey Vale Agricultural Association holding their meeting in that town.

The Worcester B.K.A., whose expert he was for so many years, was represented at the funeral by Mr. Richins and Mr. Hooper, of Worcester. Mr. Davenport had rendered useful service to the craft generally, on whose behalf we offer sincere sympathy to the family for the loss they have sustained.

Notices to Correspondents.

J. F. P. (Bewdley).—*Making Soft Candy.*

—If you have not burnt it in over-boiling, you can dissolve the "toffee-like" mass in water and boil over again. It is only injurious to bees if burnt, but it would be too hard for them to use, and they might starve with it in the hive if it did not de-liquescence as they required it.

H. H. (Pitsea).—*Dead Bees.*—There does not appear to be anything the matter with the bees sent, and they have probably been removed from the hive during a spell of fine weather. They are common English bees, and you must expect some to die off at this season, as the old bees generally do so. Should you notice unusual mortality, send some live bees for examination.

M. G. B. (Woking).—*Isle of Wight Disease.*—Yes, the bees seem to be affected by this disease, but there is nothing in the honey to account for it. This honey is rather dark, but clear, and of good consistency. Amongst the pollen-grains a few from rhododendron were found.

CURIOUS (Olton). — *Naphthaline and Candy.*—1. Naphthaline balls are the best, but what you send will do if you are unable to procure the former, and are careful not to overdo the dose. 2. The bees had their honey-sacs filled with syrup, and the intestine contained undigested pollen, with the chyle-stomach congested, showing malnutrition from some cause. 3. The recipe for candy is quite correct. We verified it when you last wrote about it, and as large quantities of candy have been made successfully from it, which have turned out in every way satisfactory, it would not be advisable to change the proportions. As it takes one quart of water to dis-

solve 7 lb. of sugar, it is evident that one pint to 10 lb. would not do. The sugar has to be made into a syrup first, so that every particle is dissolved, otherwise there would be crystals of sugar in the candy.

J. S. (Charlton Mackrell).—*Painted Calico Quilts.*—These certainly would last the longest, but, not being porous, would not be so good as plain unbleached calico. This is so cheap that the bee-keeper can afford to get a new piece every season if necessary.

LEARNER (Worsley).—*Bees Flying Out.*—It is not at all unusual for bees to fly out on a fine warm day after several days of sharp frost, and yours have done so for cleansing purposes.

SYRIAN (Atherstone).—*Re-queening Hives.*—As you re-queened your hives in September with young queens, they will be in their first year next season and in their second year in 1911.

G. E. B. (Manchester).—*Dysenteric Bees.*

—1. From your description the bees are suffering from dysentery, owing to excitement from feeding now, which has kept them very active. It is a very bad sign for bees to be so excited at this time of the year, when they should be quiet, for if they are not able to fly out every day they are liable to have dysentery. 2. The bees you sent were crushed flat, but showed unmistakable evidences of this complaint. 3. You can join the B.B.K.A. by filling up an application form, to be obtained of the acting secretary, Mr. W. Herrod, 8, Henrietta Street, Covent Garden, who would also send particulars of examinations.

NOVICE (Sheffield).—*Chilled Bees.*—You were wrong in giving your bees as much as 10 lb. of candy on the top of the frames at one time immediately after rapid feeding. This has no doubt kept the bees excited, and has induced them to be as "wide-awake now as in August." When they are in this condition they must fly out, otherwise they are likely to have dysentery. You must on no account close the entrances with wire, as the bees may be smothered.

B. B. (Quinton).—*Removing Dead Bees.*

—1. On mild days in winter it is not at all unusual for bees to carry out any that may have died. 2. Twenty pounds of syrup would be sufficient if they already had some sealed stores, but a colony only covering six frames cannot be a very strong one. 3. The two bees sent were crushed beyond recognition, but from the remains they appear to be common bees.

E. A. C. (Brigg).—*Honey Sample.*—A very nice honey, mainly from white clover. A slight coarseness in granulation is its only fault.

Editorial, Notices, &c.

PROMINENT BEE-KEEPERS.

MR. ISAAC HOPKINS.

We have pleasure in presenting this week the portrait of Mr. Isaac Hopkins, late Government expert, and a pioneer bee-keeper of New Zealand.

Although we believe Mr. Hopkins was born in England, for upwards of

Manual," which awakened an interest in bee-keeping among the settlers of the colony, so that a second edition was called for in 1882. When this edition was exhausted Mr. Hopkins had to consider the greatly altered circumstances, and in issuing the third in 1886 he made it suitable to the new conditions and the advances made up to that time. This was published as "The Illustrated Australasian Bee-Manual," a book of some 300 pages, with which the previous work was incorporated, and in the compilation of which he was assisted by Mr. T. J. Mulvany, of Bay

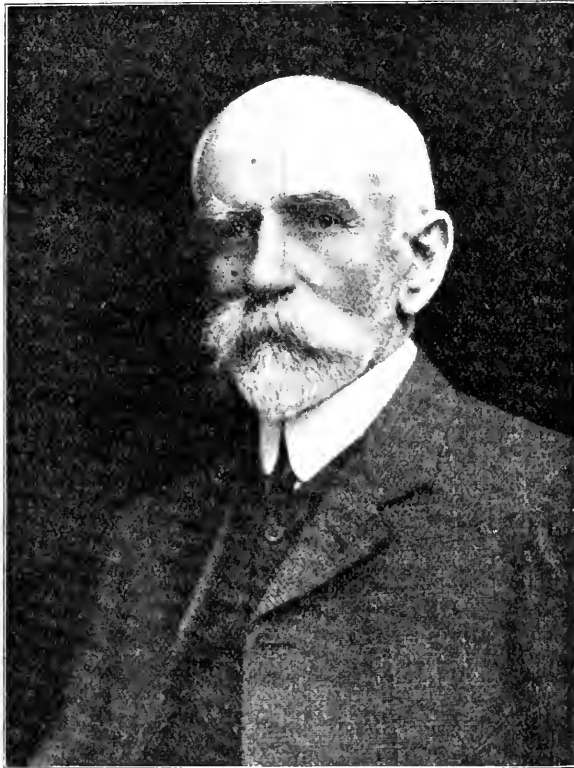

MR. ISAAC HOPKINS.

thirty years he has been an energetic and useful bee-keeper in New Zealand, and the progress of the industry in that colony is mainly due to his initiative, for he was the first to introduce modern bee-culture into Australasia. Previous to 1878 he had been trying different forms of frame, but in that year he became acquainted with the "Langstroth" hive, and has since then advocated it as the one best suited to New Zealand. As bee-keeping was being taken up the want of a manual suited to the requirements was felt, so in 1881 he published an excellent book of instruction, "The New Zealand Bee-

View Apiary, Katikati, the fourth edition being reached in 1904. Mr. Hopkins was manager for Mr. J. C. Birtch at the Matamata Apiary, Waikato, Auckland, for some time, and an incident at this apiary, in 1883, when there were about 200 hives, some of them two and three stories high, and in one case five stories, is worth recalling. This last was a swarm of the current year, and stored 240 lb. of honey, besides building out fifty sheets of comb-foundation. The parent colony gave another swarm, which produced 210 lb. This, together with about 100 lb. it had itself, made for the colony and its produce

460 lb. surplus honey—a result truly wonderful.

In 1891 we find him trading as Hopkins and Co., honey merchants, for which firm he compiled the pamphlet, "Honey, the Natural Sweet for Human Food." In 1883 he had supplied an article on bee-keeping to "Brett's Colonial Guide," which was enlarged in the second edition in 1897. He edited the *New Zealand and Australian Bee Journal* during 1883 and 1884, the two years of its circulation, and this brought him into communication with bee-keepers in all parts of the colonies.

In 1888, when secretary of the New Zealand B.K.A., he assisted in drafting a Bee-Pest Bill for the New Zealand Parliament, and though compelled by ill-health to abandon the scheme for a time, he never ceased to cherish it, and by dint of hard work up and down the country, during which he formed various bee-keepers' associations, he had the satisfaction to see the New Zealand Apiaries Act come into force on September 14, 1907. This Act is the most progressive and at the same time the most practical yet in force in any country. It grants no compensation for the compulsory destruction of diseased hives and stocks, and renders the keeping of the honey-bee in any dwelling except hives with movable frames an illegal and highly-penalised act. There could be no greater tribute to the energy and persuasive power of Mr. Hopkins, as also to the good sense of New Zealand bee-keepers, than the fact that the measure is popular from one end of the country to the other.

For the last few years Mr. Hopkins has been the New Zealand Government expert, with assistant experts under him. He set up the Exhibition Apiary at the Great International Exhibition in Christchurch in 1906-7, in which he was assisted by Miss Livesay, who holds the B.B.K.A. expert certificate. He has also established two Government bee-farms, and has produced for the Department of Agriculture two bulletins: that entitled "Bee-Culture," published in 1907, has this year reached the third edition.

Travelling in so large a colony, lecturing and forming bee-keepers' associations, must be hard work, and Mr. Hopkins has just retired from the Government service, to his well-earned rest at the age of seventy-two. Neither his record nor his portrait that we are pleased to reproduce encourages the idea that he will care to be an idle man, and we trust for years to come he may flourish as a firm supporter of the craft.

The prospects for commercial bee-keeping in New Zealand are now very bright. Many of the old bee-keepers had nearly given up bee-keeping because there

was no control over the careless and wilful box-hive men, who were propagating disease and causing continuous trouble and loss. With the advent of the present policy and the Apiaries Act bee-keepers took heart again, and the industry has since gone ahead by leaps and bounds, being now established on a thoroughly sound and commercial basis.

REVIEW.

Nature Through the Microscope. By William Spiers, M.A., F.R.M.S. (published by Robert Culley, 25, City Road, London. Price 7s. 6d. net).—In this book the author has aimed at supplying such information to lovers of Nature as will make their excursions in the country and by the seashore interesting and instructive. It is written in as simple language as the subject-matter permits of, and with the help of drawings and photographs it is hoped that the non-microscopical reader will be able to participate in the pleasures which are enjoyed by the microscopist. Only those who are in the habit of using the microscope can have any idea of the marvels hidden beyond the reach of ordinary vision, and of the wonderful beauty and some of the most perfect forms of the minutest structures that one comes across. How different from the work of man, which under the microscope shows its coarse imperfections, is that of Nature, which reveals its wonderful perfection the more it is magnified. The Rev. W. Spiers is known as a writer on microscopical objects, and in the work before us he has produced a book which should become popular, for he has avoided technicalities as far as possible while adhering to the methods of text-books. It begins with a chapter on the beautiful in little things, being descriptions and illustrations of desmids, which lie at the very first rung of the ladder of botanical classification. The following chapters advance step by step from the bottom to the top of the biological ladder, making it a pleasant introduction to botany and natural history in general. The 355 pages are divided into thirty-eight chapters, and bee-keepers will naturally be most interested in those parts relating to bee-structures, which are suitably illustrated. There are ten coloured plates, and in all ninety-nine, containing 300 drawings and micro-photographs of just such things as one wants to know something about. We have much pleasure in recommending the book to our readers as one suitable for a Christmas present for anyone wishing to know something about the microscope, the wonders it reveals, and the preparation of suitable objects for examination.

Correspondence.

The Editor does not hold himself responsible for the opinions expressed by correspondents. No notice will be taken of anonymous communications, and correspondents are requested to write on one side of the paper only and give their real names and addresses, not necessarily for publication, but as a guarantee of good faith. Illustrations should be drawn on separate pieces of paper. We do not undertake to return rejected communications.

AMONG THE BEES.

INVOLUNTARY WAX-SECRETION.

[7698.] Many bee-keepers believe that workers secrete wax only when it is necessary, as, for instance, when they take possession of a new home, when a sheet of foundation supplants a fully-drawn-out comb, or when a surplus-chamber is placed

either time or material. Everyone has observed small piles of wax-scales on the floorboard of a hive at times. May these not be the consequence of a residue of the garnered honey which has not been regurgitated into the cells, but retained by the bees, and without any volition on their part converted into wax? The point is an interesting one.

"Foreign" Honey.—A correspondent the other day sent me a postcard bearing the following:—"Would you draw Mr. W. G. Coates's attention (page 446) to the fact that *Scottish* honey could also be produced to supply the demand of Great Britain?" The point is worth passing on, all the more that from the name I presume the

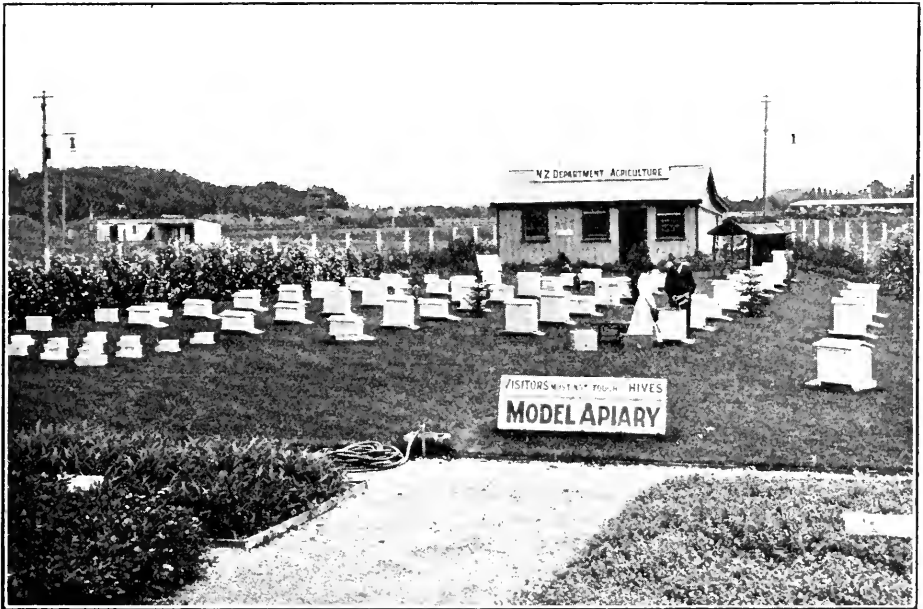

MODEL APIARY AT THE INTERNATIONAL EXHIBITION AT CHRISTCHURCH, NEW ZEALAND, 1906-7.

above a fully-occupied brood-nest. With a full flow on and weather suitable, they at once proceed to "make" wax and build out the cells from the foundation supplied as if it were the most natural thing in the world to do. Their volitive powers enable them quickly to fill up the void which, like Nature, they abhor. This is a mere truism. But while they voluntarily call these latent energies into play at their will, many bee-keepers believe that at other times wax is secreted *involuntarily*, and that bees have a desire to build comb when there is apparently no pressing need for it. If this is so, and if we can seize the psychological moment, then we may frequently secure the building of comb without much loss of

writer of 7661 is a Scotsman. I think it is only fair that we should get at least a look in. Mr. Coates, in paragraph 2, puts the price of foreign honey far too high in reckoning it at 10d. per lb. Mr. Avery, on page 466, points this out, and suggests 5d. as a more likely price, thus reducing it by one-half. I will again almost halve that, and quote it at just a little over 2½d. per lb. In inverse ratio, the quantity will go up. Mr. Coates suggests 400 tons; Mr. Avery raises it to 800 tons; I increase it to about 1,500 tons. A good deal of the honey imported is quoted in the Board of Trade returns at from 20s. 9d. to 24s. per cwt. One of our largest purveyors, I find, in a return now before me, sent us 580 tons at an average

of 2.56d. per lb. I find also that the imports have run up to 2,000 tons in one year. A thought strikes me! Mr. Coates might retain his 400 tons for England and pass us on the remainder. Another thought strikes me! Both writers speak of "imported" honey as *foreign*. I have just worked out a sum in partnership which assigns 52.5 per cent. of our imported honey to Greater Britain, leaving only 47.5 per cent. thereof to all foreign countries. Please note, with the major part of Mr. Avery's communication I am in full accord, and I heartily re-echo the sentiment expressed in his last paragraph but one. The future of the Association, when it is representative of the island from Land's End to John o' Groat's, is assured, and this I believe will soon be an accomplished fact.

Misapplying Terms.—Did the author of 7689 ever hear of any leading American writer dubbing our black bees either "mongrels" or "scrubs"? In all my reading, and it has not been limited, I never did. The three he quotes, I venture to assert, never used "so bad and foolish an imposition of words." Moreover, two of them, whom he pictures as viewing us with "compassion," do not themselves possess true Italians. Dr. Miller's bees may be described as a "mongrel" crew, inasmuch as they are *hybrids* of every degree; and most certainly the Doolittle "strain" is not true to the Italian type, being generally as yellow as wasps, a strain no one has condemned more strenuously than Mr. Root. As to *scrubs*, a well-known Ross-shire contributor, in writing me recently, characterised them, compared with his own, as *do-little* bees! In any case, a pure race cannot be described as "casual mongrels," and I know many Americans find them anything but scrub stock when well bred.

I take Bacon's dictum very lightly as applied in 7688. I may remind the writer (if he will not set it down to my professional ignorance) that terms are relative, and that there are degrees of comparison. To say that a queen-excluder is a honey-excluder does not imply that it excludes all honey far from it—but it excludes some, and thus lessens the crop. Every obstruction interrupts traffic, and so deducts from the total that might be gathered. The author of the "Guide Book," although he advises excluder-zinc for the novice, admits that "bees at times are unwilling to enter sections where excluder is used," and he agrees that those who disadvise its use "contend rightly enough that a free passage reduces the objection of bees to take possession of sections"; and, working for extracted honey, he advises (page 62) a free passage. This is 1909; Mr. Pringle wrote in 1889 twenty years ago.

Here is another authority. Dr. Miller, after "Forty Years Among the Bees," heads one of his divisions, "No Excluder under Sections," while he "has a lot lying idle." And here's another. In "Advanced Bee-keeping" I read: "In the production of comb-honey there is little need for a queen-excluder." The best Mr. Hutchinson can say of their use for extracted honey is that they "are a great convenience." These sentences were not written twenty years ago, and they are the conclusions of *advanced* bee-keepers.

I know that there are two "schools of thought" in apiarian circles, holding somewhat opposite opinions on this subject, but "progress is the law of life," and we do not stand where we did in 1889. I am quite willing to enter into the subject further, and at some future time shall be prepared to state several other objections to the too free use of excluder-zinc.—D. M. M., Banff.

TALES FROM ARISTOTLE.

[7699.] Three hundred years B.C. Athens and Greece were in a high state of civilisation and refinement. Philosophers and men of letters were numerous, but all the world was in darkness—absolute darkness—as far as bee-culture was concerned. Two thousand years and more had to roll away. Such trifles as the rise and fall of the Roman, the foundation of the Western Empire, the discovery of America had to have their happenings. At last came the Victorian era and the great awakening. In the fulness of time that which thousands of years had been unable to accomplish occurred in this age. An association for the encouragement of the study of apiculture and (for every idea has its organ now) a bee-journal came into existence. Think of the blind gropings of our ancestors, and then consider how comfortable it is to sit in your arm-chair, have bee-science turned on regularly by first post every Thursday morning, and at periodical intervals revel in a bee-conversation. What more can the warmest enthusiast wish? Stay, there is one thing more. The BEE JOURNAL actually saves the trouble of thinking. Mr. Amateur finds some event in his hive's which he cannot understand. Instead of investigating and seeing why Nature works in a certain way, he writes to the BEE JOURNAL, and gets a reply in a few days. Science in penny numbers.

Nor is this all the Victorian age has done for apiculture. Æsop, the learned slave, has, in his fable of the bundle of sticks (which separately could be easily broken, but when united resisted all efforts), shown the advantage of union. It was felt that if all the separate individualities of bee-keepers could be

gathered together into a society much could be done. Hence the British Bee-keepers' Association, now sailing in troubled waters, its efficiency being crippled by shortness of funds—a not uncommon complaint. Abraham Lincoln used to say: "Never swop horses when crossing a stream." But a "swop" has been forced upon the Association by the illness of the late secretary. Now for the moment cease advising impossible courses. Give the newcomer, Mr. Herrod, a chance to see what stuff he is made of. He seizes the reins at a difficult time, but I am impressed by his tact and courtesy.

I have digressed from the heading of my article to contrast bee-keeping of to-day with that of two thousand years ago, and to ask you to remember that in Aristotle's days they had not the appliances to chop a bee into parts, mount a leg or an antenna on a piece of glass, and study it under a microscope magnifying two or three hundred times. Aristotle wrote his treatise ΠΕΡΙ ΤΑ ΖΩΑ ΙΣΤΟΡΙΩΝ ("About the History of Animals") on sheets of wax stretched over thin boards, having a raised edge so that they might be folded—one, two, three, five pages, or more—without crushing the writing, and his pen was a stick of ivory or bone about 6 in. long, pointed at the end. The editions were necessarily limited, and cost rather more than the "Guide Book" at 1s. 6d. To collect his facts he had to accept the information given him by bee-masters of the time; therefore if some of his tales are "tall," remember that even anglers in our days, in their ardent desire to speak "the truth, the whole truth, and nothing but the truth," are sometimes carried away by their enthusiasm.—J. SMALLWOOD, Hendon.

[Anyone interested will find the wax tablets alluded to by our correspondent illustrated on Plate 3, facing page 17 of "Wax Craft." Ed.]

APICULTURAL NOTES.

[7700.] Judging from reports appearing in the JOURNAL, the past season has been to most bee-men a very disappointing one. In this district very little surplus honey was secured, and a great many stocks will die of starvation if not supplied with food till next season's honey is available.

Winter Feeding.—With proper management this should not be necessary. All the same, there are many bee-keepers who find themselves from various causes compelled to feed, especially after such an adverse season as the past one. In connection with this subject I was much interested in reading a contribution by the late E. W. Alexander in *Gleanings* a few years ago. After trying candy in various

forms with disastrous results, he found the following method most successful: "A frame of wood 2 in. deep is laid on the top of the frames, into which is put loaf sugar in inch cubes. A very small quantity of warm water should be sprinkled over, which the sugar will absorb; then cover over to prevent escape of heat." Mr. Alexander claims this as being much the best way of winter feeding. It is certainly simple enough, and would give less trouble than making candy. I mean to give it a trial, but will use a section-rack instead of the frame suggested. One point claimed for the cake of candy laid on the top of the frames is that it provides a winter passage for the bees. To take full advantage of this, the blocks of candy should not be more than 1 in. thick, and should extend about 12 in. over the frames, the length to be regulated by the number of frames in the hive. Six inches would be right for breadth. I have found a low, long box covered with glass or celluloid very satisfactory, as one is able to see at a glance without disturbing the bees the condition of the food-supply. The frame should be made $1\frac{1}{4}$ in. deep. One inch of candy poured into it would give a bee-passage, and, what I consider a distinct advantage, there would be no delay while the bees ate a passage-way; they would have it right away and all over the space covered by the candy. If an inch of candy is more than would be required, less can be put in the box; it will simply make the bee-passage deeper. When using celluloid, I tack it on to the frame and pour in the candy. With glass—which I now prefer—there is no need for fixing it in the wood. In making, cut the glass to exact size of the frame. Lay it on a table on a piece of paper, which should project $1\frac{1}{2}$ in. all round, lay the frame on the top of the glass, fold up the projecting paper, and tie a string round. Pour in the candy, and when it sets the glass will be fixed all right, and the paper can be removed. I prefer the glass this way to fixing in the wood, because it can be removed if necessary. This arrangement of a frame with a movable glass top would be admirable for the "Alexander" plan of lump-sugar feeding, as offering facilities for replenishing and re-moistening when required. I have an idea, too, that the glass would be better over the sugar than porous quilts or covers without it.

The opinions of some of our British experts on this method of winter feeding would be useful, as I for one should be glad to dispense with the disagreeable and uncertain work of candy-making.

The "Wilkes" Queen-excluder.—I am very much interested in the reports ap-

pearing in the JOURNAL regarding this new invention. I have not tried it yet, but I like the idea, and think it should be a great improvement on zinc perforations, provided the spaces are of the proper size. No doubt these excluders will have to be handled carefully and lifted off the hive, as directed by the inventor, to prevent the wires from being bent sideways. This liability accidentally to enlarge the spaces is, in my opinion, the only point where the zinc would have the advantage. Perhaps your correspondent (7680) in B.B.J. of November 25 may have used a faulty one when he found that "in places it was possible for a queen to pass through."—ALEX. REID, Balloan, N.B.

P.S.—Mr. Alexander did not mention that the frame of wood had any kind of a bottom, and I understood that the sugar was simply laid on the frames. There might be, however, some advantages in having a perforated bottom fixed preferably so as to give a bee-passage under. In this case the sugar could be put into the frame and moistened before putting on the hive, and in the event of having to remove any sugar not consumed, it would be more easily done. In using this arrangement as a candy-box as described above, the candy could be poured through the perforated bottom.—A. R.

BRITISH BEE-KEEPERS' ASSOCIATION

[7701.] "I do not intend to join the B.B.K.A. for sentimental reasons." So says Mr. G. Thomas on page 474, and so say many more of us. We want an association representative of British bee-keepers, not of a few in the London area.

Mr. Cowan and Mr. Herrod are the right men in the right places, but the Council should be one representative of the country as a whole, and the members should be *en bloc* the members of any county or local association. "British Bee-keepers' Association (Beckenham and Bromley Branch)" would read well for our new local society, and would be a title welcomed by all the members, as I am convinced a similar one would be by all county and local associations.

"Unity is Strength."—How can we expect legislation or anything else which will benefit the industry while each society is allowed to potter along its solitary way, without the slightest attempt at co-operative effort? Someone has said how difficult it is to get members of the Council from the country to come to the meetings in London. As the mountain would not go to Mahomet, I have always been told Mahomet went to the mountain.

The Royal Agricultural Society had to give up its pleasant quarters near London and commence its weary pilgrimage once more, and the sooner the Council of the B.B.K.A. find ways and means to do the

same the sooner will life be infused into the Association.

The National Union of Teachers during Easter week, and at a different town or city each year, has a conference of representatives from all over the country, at which all matters inimical to its welfare during the coming year are thrashed out. If "united" bee-keepers had such a conference—and we could have it quite easily by holding it at the same time and place as the Royal Agricultural Society's show—a different centre each year—I venture to think that then the B.B.K.A. would, Phoenix-like, rise from its ashes, and, like the N.U.T. and the R.A.S., become a powerful influence in the land.

A small executive committee elected each year at the annual conference would do more to breathe life into the Association than all the feeble efforts of the past ten years. There is no sense or reason in electing privately members of the Council and in allowing them to remain there until they die of old age.—ARTHUR SCHOFIELD, Beckenham.

[We hope our correspondent will allow us to point out that the Council are not elected privately, but at the annual general meeting of the members of the Association in accordance with Rule VII., which provides that "The Council shall retire annually, but they shall be eligible for re-election. Candidates other than retiring members must be nominated by two members of the Association, upon a printed nomination paper to be obtained from the secretary, and the election shall be by show of hands at the annual general meeting. The names of those to be proposed for election shall be printed in the notice of meeting which is sent to members of the Association before the annual general meeting. Any vacancy which may occur during the year shall be filled by the Council." As the Council are elected annually, it rests entirely with the members of the Association how long they remain on it, for members have the power of replacing any one of the Council at any annual meeting.—Ed.]

WHAT IS THE B.B.K.A. AND WHAT IS ITS CONSTITUTION?

[7702.] Is the B.B.K.A. a society in itself, or is it a combination of county associations? I should like to know. Surely it ought to be a combination of all, and membership of one ought to constitute membership of the central association. I notice that it cost our local association over 10 per cent. of its receipts for affiliation fee and delegates' expenses last year, and what do we gain by it, what benefits or advantages do we derive?

I am a strong believer in combination and thorough representation, which we do not seem to get.

The report of the November Council meeting in the B.B.J. is anything but pleasant reading, and certainly does not give country readers a very good impression, and, as Mr. Thomas says in the B.B.J. for December 2 (page 473), it is an opportunity to express one's views. In my opinion, representation should be on the following lines. Each county association should subscribe to the central body a given sum per member per annum, a minimum amount being decided upon for small associations. Each association should be entitled to elect and to send one or more delegates, according to the number of members, to an annual meeting, to be held in London or at some other convenient centre. At that meeting a committee of ten or twelve should be elected for the ensuing year, who with a chairman, secretary, and treasurer should meet monthly or quarterly, as required, to carry on the business of the Association.

BREEDING THE BRITISH GOLDEN BEE IN RIPPLE COURT APIARY.

HOW MATING IS CONTROLLED.

By F. W. L. Sladen, F.E.S.

(Continued from page 484.)

Ripple Court Apiary is a very favourable spot for restricted mating. The surrounding country is rather destitute of trees, and is much swept by cool winds, the prevailing north-easterly and south-westerly winds both blowing off the open sea, which is four and seven miles off in these respective directions. Perfectly calm days are rare. On sunny days in summer, when it is warm inland, the maximum temperature is generally about 5 deg. to 10 deg. lower and the wind stronger than in warm places inland. But there is more sunshine and the nights are warmer than inland.* The apiary is now sheltered

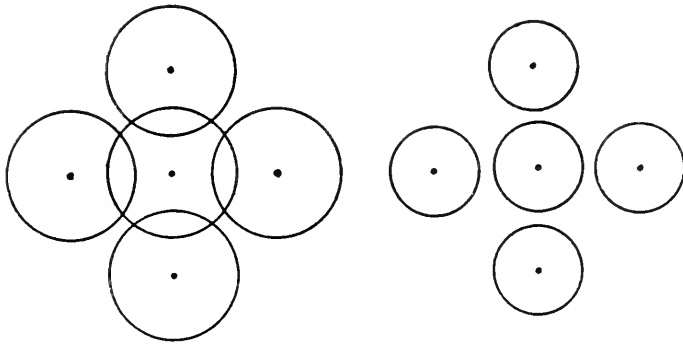

Diagram showing how a slightly restricted range of flight may completely isolate an apiary for breeding purposes. The dots represent imaginary apiaries and the circles ranges of flight. The ranges of flight of queens and drones are not shown separately.

Every individual member, through his county association, would then have a direct interest in the B.B.K.A. We should know what it was and what its constitution was, and I have very little doubt that a meeting of delegates as suggested would very soon decide what the duties of a committee or council should be.

There are many matters of importance to small bee-keepers that a representative council of this character could undertake—railway rates, for instance. I had occasion a few days ago to send a dozen 1-lb. jars of honey just over 100 miles. On taking it to the parcel office and declaring it as honey I was informed there was a special rate for honey in bottles—50 per cent. more than the ordinary rate! If I had declared it fruit it would have gone for half the ordinary rate. Surely this is a point a council might take up with the railway companies.

I am afraid I have trespassed somewhat on your space.—J. L. BRIERLEY, Astwood Cemetery, Worcester.

from wind by a belt of trees and shrubs, chiefly Austrian pine, goat willow, sycamore.

* To give some idea of the difference in climate between this coast and inland, the following figures have been extracted from the "Weekly Weather Report" of the Meteorological Office, 1906, Appendix III.

	35 YEARS' AVERAGE TEMPERATURE.			
	July.		August.	
	Average maximum.	Average minimum.	Average maximum.	Average minimum.
Dungeness...	67.1°	56.0°	67.5°	56.5°
Oxford.....	70.4°	53.6°	69.2°	52.9°

	25 YEARS' AVERAGE SUNSHINE.	
	July.	August.
Littlestone-on-Sea, 2 near Dungeness	251	201 hours.
Oxford.....	203	185 ..

On days that are warm and sunny inland the difference in maximum temperature between Dungeness and Oxford is generally much greater than these figures show, but on cold, dull days Dungeness generally has a higher maximum than Oxford. Notice that at Dungeness August is warmer than July, but at Oxford July is warmer than August.

The excessive sunshine, warm nights, and numerous wild flowers are very favourable for bee-rearing. Humble-bees are abundant, and many rare and tender species of solitary bees are to be found in the neighbourhood. A new bee to

more, and lime, planted round it twelve years ago. Whichever way the wind blows, there is a sheltered area just outside the apiary, in which I believe many queens are mated.

No bees are kept within half a mile of Ripple Court Apiary, and not many within two and a half miles. The nearest bees have been very little affected by the Ripple Court Apiary drones, most of them being still black, and no goldens have been produced. The queens are mated in June and early in July before many Ripple Court Apiary drones are on the wing.

As far as I have been able to observe, most queens in Ripple Court Apiary are

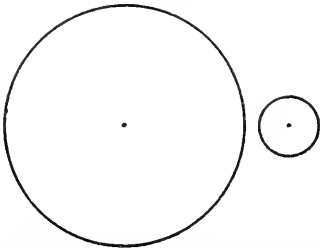

Diagram showing difference between a range of flight of 1 mile and one of $\frac{1}{4}$ mile (440 yards).

mated between 12.30 and 2.30 p.m., this being usually the warmest period of the day. On August 28, 1907, I saw a queen, aged twenty-one days, enter a hive, bearing the signs of having just mated, as early as 11.10 a.m. The temperature was then 65 deg., with scarcely any wind and a clear sky. The previous day was one of restricted flight, and it followed a long period unfavourable for flight.

The latest time of day I have seen a queen fly was at 5 p.m., on July 16, 1906.* There had been a very strong S.W. wind for four days, but on this day it moderated a little between 4 and 5 p.m., and the temperature, which had been no higher than 64 deg., rose to 65 deg. About 5 p.m. I also saw a number of drones circling and darting about in the air only four or five yards to the leeward of a colony in the apiary; they continued to do this for about five minutes, and were evidently looking for queens. This was an interesting case of extremely restricted amorous flight, which was no doubt fruitless, for no queens appeared to have been mated on that day.

In "free" mating weather a queen is seldom or never mated before the second day of flight. For a queen to be mated in restricting weather the preliminary flights usually extend over several days.

* Britain. *Sphæcodes rubicundus*, was discovered in the grounds at Ripple Court in 1895, and another, *Cilissa melanura*, at St. Margaret's Bay in 1897.

* It is possible that queens and drones might be induced to fly late in the day after other drones have retired by keeping the hives in a cool and dark place—for instance, a cellar or well—until afternoon.

The ages at which most queens in the tables (pages 482-483) were mated in "free" weather were six days and nine days after hatching; none were mated before the sixth day. In restricting weather most queens were mated on the twelfth, thirteenth, and fifteenth days, and none before the twelfth day. Owing to an unusually prolonged period of unfavourable weather in the early part of July, and to another in the latter part of August and beginning of September, many more queens were mated after the fifteenth day in 1908 than in most years.

To secure many cases of restricted mating it is necessary that the weather be seldom warmer than restricted mating weather, because queens and drones are very susceptible to a fall in temperature, and would not fly at low temperatures if they could get higher ones at intervals of two or three days. Drones will fly at a lower temperature, and probably have a wider range of flight, than queens. The lowest mating temperature is a degree or two higher than the lowest flying temperature.

I have never known mating to take place on a day with a maximum temperature below 62 deg., and believe that it does not readily occur at 63 deg. or 64 deg., unless there are a great many drones and also relatively many queens flying. When many queens are flying, the air near the apiary is full of drones darting about in all directions on their trail. Many of the drones follow one another, and they frequently form little knots or flocks, which break up after a few erratic swoops. If one lies on the ground about fifty yards from the apiary scanning the sky, the little flocks constantly appear, but at 200 yards they are seldom seen. The presence of so many ardent drones near the apiary must induce many matings to take place there and quickly. I think it likely that many of the matings on "free" days, and all on restricted days, occur within about 200 yards of the apiary.

In hunting for queens drones naturally select open fields, and specially like rising ground; they avoid shady places.

There is no doubt that on most "free" days flight is not altogether unrestricted. There is reason to suppose that the range of flight is smaller in August than in July, on account of the lessened honey-flow and activity.

It was noticed that during a period of restricted mating weather at the end of June, 1908, many queens failed to get mated; but during periods of similar weather in August and September almost all the queens were mated, despite the fact that the honey-flow had ended, which made mating more difficult. This seems to indicate that the young drones flying

at the end of June may not have been mature.

Restricted mating weather has undoubtedly aided the work of breeding bees by selection in Ripple Court Apiary ever since it began. I have found no evidence that fertilisation is not well accomplished when mating takes place in restricting weather. Of course, some queens are lost through adverse weather, but these are no doubt the weaker ones, and this process, continued for many generations, should result in the development of a very hardy breed of bees. There is every indication that this has been the case in Ripple Court Apiary. For several years past no colonies have been lost in winter, and there has been no spring dwindling.

(To be continued.)

CAPPINGS OF COMB.

BY L. S. CRAWSHAW, NORTON, MALTON.

La Bête Noire (page 435).—How are the mighty fallen? "D. M. M." indulges in a black beast of a pun! For shame, sir! There are, no doubt, other bee-keeping nightmares of this ilk, but his term of opprobrium for honey-dew is very appropriate. (N.B.—This is an accident.) "D. M. M.'s" useful article seems to fairly cover the aphidian field, and he makes the matter so apparent that, as in Nature, there is little need to turn over the leaf for more enlightenment. But do we understand you, sir, to claim that the aphides only collect the exuded sweat of the plants? Is this not an incomplete statement? No doubt in some cases the plant is willing to cede its succulence, but, generally speaking, the aphid would seem to come into its inheritance by a forced suck-cession! These little vampires are provided with beaks (*rostra*) which enable them to suck the leaf's life-blood, and their dead and dying victims were particularly noticeable this current year of black memory on the black currant bushes. The blight appeared only to cease with the exhaustion of the food-supply, so that these plants at least were by no means willing contributors.

Combs Built from Honey-dew (page 436).—I have had a good deal of comb built during this kind of a flow, and, so far as I could see, ordinary combs are no whit whiter. There was certainly no "green tinge." Sections filled with this delightful delicacy looked white as snow, appetising, and pure, until an examination against the light revealed their black heart within.

Brace-combs on Separators (page 437).—Mr. Soal suggests that these cross-combs are produced by independent clusters. This is exceedingly reasonable; in fact, it is almost certain that such must be the case. I have no observations

to support the suggestion, but I imagine that, when these occur on clean separators, they are built on the outward side, and that they are begun by the pioneer bees, which extend the cluster. Apropos of this, "D. M. M." says (page 436) that "with a heavy flow, and a full force of bees, combs can be got as flat as a board." I venture to suggest, further, that these cross-combs occur more frequently with the 2-in. section than with the narrower varieties, and that such a bee-keeper as the Rev. R. M. Lamb is seldom or never troubled with them. By the way, Mr. Soal appears to be as great a stickler for terminological exactitude as some other writers—who shall be nameless—so that he will not object to have his attention drawn to the fact that brace-combs which are "quite detached" can hardly be said to brace.

Cost of Feeding for Winter (page 446).—Is not this estimate of £20 to £30 for 100 hives rather excessive? Even if sugar costs 2d. per lb. (and it should be less for such a wholesale order), an average cost per hive of five shillings should provide 48 lb. of thick syrup, allowing 2 lb. of sugar to the pint. It is unlikely that the bees were entirely destitute, but, even so, it would seem as though one-half the above expenditure should suffice.

Cone Escapes (page 454).—It is quite likely that a difference in the angle of the cone may make a difference in its working. Mine are home-made from perforated zinc, and they are not infallible. Yet they are well made and of good shape, and closed at the mouth to a gauge which allows a worker-bee to slide its way out. But they do not exclude incoming bees when the necessity arises. Of course, it may not be the fault of the cones, but only that the inestimable advantage of association with their owner has made the bees exceptionally intelligent. The double cone escape is more effective, whether the second cone be turned inwards or outwards. Perhaps "D. M. M." uses traps of this variety.

Queries and Replies.

[3982.] *Railway Risks*.—Will you kindly let me know through the B.B.J. what is the custom when honey gets damaged in transit? I sent away fifteen 1-lb. bottles, seven of which got broken. I wrote to buyer to claim damages from the railway company. After about three months' delay the railway company refused to pay on the plea that it was sent at owner's risk. (It was sent at agricultural produce rate.) Who was the owner at that time? Who should

bear the loss—the seller, the buyer, or the railway company? What is usual in these cases? The honey was well packed.—J. W. S., Herefordshire.

REPLY.—It depends entirely on what conditions the honey was sent. If sent at ordinary rates the owner has to take the risk, and has to sign a risk note before the railway company will take the parcel, but if sent at the company's risk the rates are higher. Sections are only accepted at owner's risk. As to which of the two, the seller or the buyer, should bear the loss of damage will depend upon the arrangement made at the time of selling. If the seller agrees to put on rail for a certain price his contract is fulfilled when he gets the acknowledgment of its safe receipt from the railway company. If, on the other hand, he undertakes to deliver to the customer he would have to bear any loss from damage.

Notices to Correspondents.

- DARESSALAAM (East Ham, E.).—*Extracting Shallow Frames.*—If you can keep them in a warm, dry place, and prevent the honey from granulating, you could extract them in the spring. If you extract now you would also have to keep the combs in a warm, dry place, otherwise the honey adhering to them would ferment. You can, however, wash it out, afterwards drying the combs before putting them away.
- F. S. N. (Bexley Heath).—*Keeping a Supply of Fertile Queens on Hand.*—1. These can be kept in nuclei during the whole swarming season if necessary. A three-frame nucleus will do very well. 2. No doubt if water were contaminated by foul brood germs it would be injurious to bees, and might produce disease. 3. We are glad to hear that you have not been troubled with disease, and hope you may remain free from it.
- C. H. M. (Spilsby).—*Bee-Pest Prevention Act (Ireland).*—No official reports have yet been made as to the working of this Act. The Department of Agriculture for Ireland issued the regulations, which took effect from June 3, 1909.
- C. H. M. (Spilsby).—*Queen-introduction.*—If you refer to dealing with queenless stocks, you will find the plan mentioned on page 246 of B.B.J., and a further report of trial on page 315 (7564).
- D. L. J. (Suffolk).—*Candy-boiling.*—There should be no difficulty in coming to a conclusion when boiling should be stopped if the tests recommended are carried out. If you use a thermometer, the boiling should be stopped when the proper degree is reached. Messrs.

Negretti and Zambra, Holborn Circus, London, E.C., or any other thermometer-makers, could supply a sugar-boiling thermometer.

A. E. B. (Northfield).—*Snow on Hives.*—If the hives are buried in snow leave them alone, as it will not hurt the bees, for the air percolates through the snow, and they can get all they require while being protected from cold winds. Interference with well-prepared stocks will do ten times more harm than good. When a thaw comes it is time enough to scrape away the melting snow from the hives.

G. B. (Tring).—*Repeating Questions.*—The questions you ask were answered in B.B.J. for October 28, page 430, to which we must refer you.

F. H. T. (Chorley).—*Bees and Fertilisation of Fruit-trees.*—As we have had several inquiries, we intend to have the address on this subject reprinted in pamphlet form.

THEODOSIA (Pembrokeshire).—*Moving Bees.*—1. You can safely move old-established stocks in boxes at this time of the year and place them on the new stands. You will find full instructions on page 116 of "Guide Book," but as your bees are in boxes instead of skeps you will not require the "skep-carrier" shown on page 117. 2. We would certainly put all the five hives on the spot near the house, as the bees can just as easily get at the ling a quarter of a mile away as they would if put nearer to it. 3. Rats would be destructive if they had access to hives, but you should have them trapped. 4. To obtain a certificate you would have to show practical experience with the work in an apiary.

F. J. N. (Wokingham).—*Loss of Queen.*—You cannot get another queen at this time of the year, and must wait until spring to unite the colony with one having a queen.

T. C. S. (Merthyr).—*Using Non-Standard Frames.*—Your best plan to furnish your hives is by purchasing swarms in the spring (see "Guide Book," page 145). It is, however, a great pity that you are making a start with any other than a standard frame, as you will always be in difficulty in getting appliances, which would have to be made to suit your frame. Foundation would have to be cut specially, and you would have to get an extractor made to order. For all this you must pay extra, to say nothing about losing all the advantages of interchangeability and of the hives being valueless if you wish to dispose of them.

* * * Several important letters, &c., are in type, but held over from pressure on our space.

Editorial, Notices, &c.

SEASONABLE.

Christmas Day will be near at hand when the B.B.J. reaches our readers, and we cannot allow the festive season to pass without wishing all in the good old words "A Merry Christmas," and trust that it may be a time of peace, goodwill, and rejoicing in every household where the BRITISH BEE JOURNAL is read.

"NOW IS THE WINTER OF OUR DISCONTENT."

We are indebted to Mr. G. W. Avery, the genial hon. secretary of the Cumber-

the heavy falls of snow we had here in February of the present year. The apiary is situated in what was once the siding of the Allenwood paper mills close to Heads Nook Station, on the Newcastle and Carlisle branch of the North-Eastern Railway. Part of the ruins of the crane and warehouse are shown to the right in the picture. The line of hives faces south, and the photographer has just missed taking in the railway to the right. This ought to be specially noted by correspondents who write against keeping bees near railways, as over thirty passenger, besides a very large number of mineral and goods trains pass here every day all the year round. The apiary contains about forty stocks, which are kept in



"NOW IS THE WINTER OF OUR DISCONTENT."—A CUMBERLAND APIARY IN THE SNOW.

land B.K.A. (who is seen in the picture), for the beautiful photograph of his apiary, which forms so seasonable an illustration for our Christmas number; and we also have to thank Mr. John Sewell, president of the Carlisle Photographic Society, who took the photograph, for permission to reproduce it. At the successful exhibition held by the Cumberland B.K.A. at Carlisle in September last it was awarded a first prize, and anyone who has seen the original photograph will agree that it would be difficult to find a more beautiful picture of an apiary in winter. Mr. Avery kindly gives a few interesting particulars as follow:—

"The photo was taken during one of

hives of almost every known British make, but all are of the same inside dimensions, so that the standard frame is used only. I run my bees almost entirely for comb honey, in the production of which I have been very successful both before and since settling in this district. Queens of the native strain are also now extensively reared in the apiary, and mated in specially constructed boxes, which I will describe in a future number. All my stocks are annually transported to the heather some eight miles away on the end of the Pennine range, which can be seen from the apiary to the east, but which was enveloped in snow-clouds when the photo was taken."

BRITISH BEE-KEEPERS' ASSOCIATION

The monthly meeting of the Council was held on Thursday, December 16, in the board-room of the R.S.P.C.A., 105, Jermyn Street, when Mr. T. W. Cowan presided. There were also present: Miss K. M. Hall, Mr. C. L. M. Eales, Mr. G. Skevington, Mr. A. G. Pugh, Mr. W. F. Reid, Mr. J. B. Lamb, Mr. E. D. Till, Mr. T. Bevan, General Sir Stanley Edwardes, Mr. O. R. Frankenstein, Dr. T. S. Elliot, Mr. E. Walker, Mr. E. Gareke. County Representatives: Mr. A. W. Salmon (Suffolk), Mr. R. W. Furse (Devon), Rev. A. D. Downes-Shaw (Norfolk), Major A. W. Fair (Middlesex), Mr. D. W. Bishop-Aekerman (Berks), Mr. H. F. Jolly (Somerset), Mr. F. B. White, Mr. W. E. Hamlin (Surrey), Mr. T. W. White (Essex), Miss E. Scott-Walker, Mr. H. Edwards (Bucks), Mr. R. H. Colman (Derbyshire), and Mr. W. Herrod (acting secretary).

Letters expressing regret at inability to attend were received from Miss Gayton, Mr. H. Jonas, Colonel H. J. O. Walker, and Rev. H. R. N. Ellison.

The minutes of the Council meeting held November 18 were read and confirmed.

The Chairman stated that he had received a letter from Mr. E. H. Young resigning his position as secretary of the association; and it was resolved to accept the same, and that a letter be sent expressing the regret of the Council for the cause of his resignation, and thanking him for his past services.

The following new members were elected: Mr. W. W. Falkner, Ivy Cottage, Market Harborough; Mr. T. W. White, Fyfield Road, Upper Walthamstow; Miss A. D. Betts, Hill House, Camberley; Mr. J. N. Bold, Almond's Green, West Derby, Liverpool; Mr. A. G. Gambrell, Bagshot Road, Ascot; Mr. W. White, 455, Mile End Road, London, E.; Mr. T. E. Hancock, Steeple Aston, Oxon.

The report of the Finance Committee was presented by Mr. Eales, showing an available balance in bank of £85 ls. 1d.

The Chairman was requested to arrange the question of rental of 12, Hanover Square with Mr. Young.

A draft agreement with the Medical Society of London for the use of 11, Chandos Street, Cavendish Square, was presented, and after some discussion as to the limited accommodation for the secretary to do his work there, the Chairman offered the temporary use of a room at 8, Henrietta Street in which the secretary could do his work, and where the books and papers could be kept until suitable arrangements were made. This was accepted, and the Chairman was authorised to sign the agreement.

It was proposed, seconded, and carried that a small committee be appointed, consisting of General Sir Stanley Edwardes, Mr. Eales, Mr. Frankenstein, with Mr. Herrod, to make the best arrangements possible for office accommodation and to go through the papers of the Association.

A communication was received from the secretary of the Lancashire Bee-keepers' Association accepting the Council's offer of a class for granulated honey at the "Royal" Show, confined to members of their association only, upon the usual terms.

A letter was read from the Royal Lancashire Agricultural Society *re* medals. The secretary was instructed to write and inform them that as the late secretary had no authority for saying they would be granted, these could not be sent.

The report on the second-class examination was presented, and certificates awarded to the following: Mrs. Elsi Stuart Russell, Canema, Crockenhill, Kent; Miss H. H. Turner, The Pool House, Astley, Stourport, Wores.; Rev. H. G. Stanley, Marshfield Vicarage, Cardiff; Mr. J. W. Mason, 27, Arthur Street, Withernsea, East Yorks.; Mr. J. Smallwood, 3, Museum Street, London, W.C.; Mr. A. R. Moreton, Hallow, Wores.; Mr. A. Firkins, Colwall, Malvern, Wores.; Mr. E. A. Millward, Chaddesley Corbett, Kidderminster; Mr. G. Cook, Bastonford, Powick, Wores.; Mr. J. Baxter, Quinton, Birmingham; Mr. J. P. Phillips, Spetchley, Wores.; Mr. J. L. Brierley, Astwood Cemetery, Wores.; Mr. G. Richings, 2, Shrubbery Terrace, Worcester.

A communication was read from a centre where a third-class examination had been held during the summer, stating that though ten candidates had passed, the late secretary had omitted to report in the B.B.J. the names of five of the successful ones. The secretary was instructed to insert the following names in the minutes of the present meeting: Misses Marjorie Wake-Walker, Flora Hawtayne, Mary Deacon, Ina Frost, and Grace Glenny, all of the Flower and Fruit Farm, Thatcham, Berks.

Mr. Reid presented the report of the Special Committee, which, with the following covering letter, had been sent to all secretaries and representatives of county associations:

"DEAR SIR.—I enclose a copy of the report of the Special Committee which was appointed to consider the position of the British Bee-keepers' Association, and earnestly hope that you will make a special effort to attend the Council meeting on December 16, when this report will be considered.

"The scheme of reorganisation provides for the amalgamation of the parent society with the affiliated county associa-

tions, thus forming one bee-keepers' association for the whole of Great Britain. The parent society will become a central branch, and each county association will become a county branch, of the reconstructed 'British Bee-keepers' Association.'

"The interests of all branches will be identical, and all will share equally in the management of the Association; yet—and this is a special feature of the scheme—each branch will retain absolute autonomy, and in no case will the income of a branch be reduced by this scheme below that of the present year. On the contrary, all subscriptions received by the central branch from bee-keepers residing within the areas of the county branches will be transmitted in full each year to the secretaries of the respective branches, hence no friction or clashing of interests in regard to subscriptions can arise.

"A general council will be formed of delegates from the branches, with the addition of fifteen members to be co-opted from the body of 6,000 or more members. The funds to enable this council to carry on the general work of the Association will be provided by each branch subscribing (instead of the affiliation fee now paid) one guinea annually, plus a contribution of 5 per cent. on the annual subscriptions received from its members; but the latter contribution will not be payable until an increase in the receipts from members' subscriptions, as compared with the amount received for the current year, shall enable such contribution to be paid.—Believe me, yours very faithfully, THOS. WM. COWAN, Chairman of the Council."

(The report will be printed in a later issue of B.B.J. and also in the *Record*.)

The Chairman asked Mr. Gareke to briefly explain the scheme, and then called on the representatives to express their views.

Letters were read from the secretaries of the Lancashire, Lincolnshire, Stafford, and Cumberland associations adversely criticising the scheme.

The Rev. A. D. Downes-Shaw said that the decease of the Association or its crippling for want of funds would be an irreparable loss to the county associations. It was an acknowledged fact that a central authority was essential to the well-being of all trades, guilds, clubs, industries, and sciences, and it was a delusion to suppose that bee-keepers could do without one, and they could not disregard this fact. The function of the central body was scientific, advisory, and social. It should be the authority to which all questions could be referred and the recognised authority to deal with the Government. He thought they should take a higher estimate of their position, and

would like the title changed to the Royal Apicultural Society of Great Britain, and get Royalty to take an interest in the industry, with good men of title for vice-presidents, when he thought there would be no difficulty in getting the money. They could then show that apiculture was not merely a pastime, but a national necessity.

Mr. Pugh considered the scheme unpractical, and one by which the Association would gain nothing. He thought complete identity of interests already existed with the county associations, and the present arrangements could be improved without any fundamental alterations. There was nothing to prevent the present Council from working hand in hand with the county associations. Instead of increasing the finances, the scheme would decrease them if subscriptions from bee-keepers in the counties were sent back. They had splendid assets in subscribers, annual shows, examinations and certificates, reserve funds, library, lantern-slides, and a desire by the counties to have their representatives on the Council, all of which they would be throwing away. He was certain the failure was due to the middle the late secretary had brought them into, and the best thing was to set about putting their house in order instead of trying to introduce a scheme which would be useless.

Mr. F. B. White could express no opinion either way, but required time to bring the matter before his association.

Mr. Salmon was not in favour of the scheme, and thought it best before making any change to get matters straight and give the new secretary a chance to see what he could do in, say, twelve months.

Mr. Coltman thought under the scheme counties would be at a loss, because they would require forty new members to pay the £5, and they would be £4 out of pocket for extra experts' visits. He did not think it would do any good for the Council to hold their meetings in different parts of the country, as unless there was some regular attendance they could not keep in touch with the business. He did not like changing the name of the county associations, and doubted if it would be generally acceptable.

Mr. Edwards thought there had been too much haste in bringing this scheme forward; it would never pass, and he should oppose it as a representative of Berks and Bucks.

Mr. Jolly was in favour of some parts, but thought more time should be given for its fuller consideration, and it should be postponed to a later date.

Mr. Furse was instructed to vote for the scheme by his council, who thought, as they were a small society, it would do

them good to be part of a large organisation.

General Sir Stanley Edwardes agreed with the principles of the Rev. Downes-Shaw, and would like very much to see it a Royal society.

Dr. Elliot objected to the constitution of the Council as outlined in the scheme, and if the central branch returned subscriptions, where was the income to come from?

It was ultimately proposed by Mr. F. B. White, seconded by Mr. H. Edwards, and carried, "That in the opinion of this meeting the scheme should be put before the members and councils of the B.B.K.A. and of the county associations, and that a special meeting of the B.B.K.A. should be called for May for the consideration of the scheme, and that the members of committees and representatives of the county associations be invited to attend, and that sufficient copies be supplied for all members of each respective county association."

The Chairman and Mr. Gareke undertook to pay for the cost of printing extra copies of the B.B.J. containing the report of proposed scheme, for which they were thanked; and the secretary was instructed to write to the secretary of each association and ascertain how many copies he was prepared to distribute to those members not receiving the *Record*, in which the report would also appear.

A vote of thanks to the Chairman at 8.30 p.m. closed the proceedings.

The next meeting of the Council will be held on January 20, 1910.

Correspondence.

The Editor does not hold himself responsible for the opinions expressed by correspondents. No notice will be taken of anonymous communications, and correspondents are requested to write on one side of the paper only and give their real names and addresses, not necessarily for publication, but as a guarantee of good faith. Illustrations should be drawn on separate pieces of paper. We do not undertake to return rejected communications.

QUEEN-EXCLUDERS AND SECTION-RACKS.

[7703.] *Queen-excluders.*—The necessity for being "careful to place the excluder right side up" (7681, B.B.J., November 25) may be avoided by previously removing the burr from the rough side. I venture to submit that the dealers ought not to send out their goods in this imperfect condition, but as they do so the purchaser should at once remedy the imperfection by rubbing the rough side over with a piece of fine emery-cloth, which quickly removes the burr. The same should also be done with metal

separators. Another fault I have to find with the usual excluder-zinc is that the perforations are carried too near to the sides, thus leaving the plain margin so narrow that the racks must stand partly on the perforations, and thus afford the bees the opportunity of propolising them down. Personally, I obviate this by means of strips of thin zinc foil, or of paper which has been coated with paraffin wax; but the necessity for this dodging ought not to, and need not, exist.

Seeing that many of our leaders in the craft tell us they never use queen-excluders, I determined to try the experiment of doing without one on one of my hives this last season. The result was such that I do not feel tempted to repeat the experiment, for twelve sections were spoilt, and there was no excess of surplus in this hive beyond that yielded by the others to compensate for this loss.

Section-racks.—In his remarks on section-racks at the spring Conversatione (B.B.J., April 15, page 141) Mr. Herrod mentions many of the good points of the "hanging" rack, but omits one which I consider of much importance—namely, that it rests only upon the four sides which constitute its extreme outline, so that when placed upon the queen-excluder (having a proper clear margin) the rack does not touch any of the perforated part of the zinc, and consequently does not become stuck down, but can be lifted off with the utmost ease. With all respect to Mr. Herrod, I regard the rack having two slats across the bottom on which the sections rest as "anathema." These two slats running right across the excluder enable the bees to so securely stick the rack down, especially towards the autumn, that in order to remove it it is necessary to prise it up with a chisel or otherwise apply forcible measures.

Exception has been taken to metal girders on the ground that the sections cannot be brought close together, therefore cannot be squared up, and that the spaces between them become propolised. All this, however, is not the fault of the girder, but of the stupid way in which it is used. If the girder is fixed in this position, **T**, none of these evil consequences arise. The sections can be pushed up close together, and therefore kept perfectly square. Mechanically also the girder in this position is a stronger structure than when used the opposite way up—that is, as regards the load it is capable of carrying. Of course, the girder must not project down more than $\frac{1}{4}$ in. (or the thickness of the slats round the sides of the rack and on which the rack stands), and, whether it actually touches the excluder-zinc or not, the thin metal edge offers practically no hold to the bees to fasten it down, so that a rack thus con-

structed is also quite easy to remove from the hive.

The advantage of protecting the under side of sections, so that they come out perfectly white and clean, as with the "W. B. C." rack, appeals perhaps more strongly to some than to others. To me it is a point of much weight, and I have therefore constructed a rack which embodies this feature, and am gradually replacing all my other racks by it, except those on the "W. B. C." model. The bottom of this rack is boarded across with strips of wood cut so as to leave openings which exactly coincide with the bee-ways between the sections. Two sides of the rack are built double-walled, the other two become double-walled by virtue of the two followers when the rack is loaded, and the sections are then in the middle of the rack. The bottom strips are no thicker than the sections themselves, and in order to prevent sagging under the weight of the filled sections the longer follower is driven up, not by the usual spring blocks, but by means of two thumb-screws passing through the side of the rack. The sections are thus so securely held that the bottom is practically relieved of all weight.

I suppose there is no doubt that one of the most fertile sources of failure to get bees quickly up into section-racks in spring is that they do not fit down closely all round. Very slight unevennesses, which are almost unavoidable, give rise to air-passages between the rack and the excluder-zinc, and thus admit cold draughts. Anyone who has never tried the simple plan of gluing a strip of ordinary green baize all round the bottom of the rack (that is, the *tread* of the rack) will be surprised what a help it is. Of course, the precautions previously mentioned must be taken to ensure that the racks so felted do not rest upon the perforations of the excluder.—G. S. N., Godstone.

NOTES BY THE WAY.

[7704.] The closing month of the year inclines one to be retrospective, but as this is more properly our Editor's prerogative, I will pass on to the bee-doings for the past month. These, we all know, should have been nil, and if the advice given in the columns of the B.B.J. in the past has been heeded and put into practice, our bees will be safe in their comfortable brood-nests, and bee-keepers, I hope, will be as busy as we are at Beedon Apiary filling orders for honey for dispatch to all parts of England.

The near approach of Christmas Day, the time of the reunion of friends, brings memories of those who were with us a year or two ago, and throws a somewhat

melancholy shadow over the coming festival for us older people; but to the younger members of our families the season is one of joyous brightness, full of hope and pleasant anticipations; and we of older growth must not forget our duty lies in trying to make Christmas as joyous as we remember it was of yore when we were in the green leaf of youth.

To my many bee-friends I tender my sincere wishes that this Christmastide may be a joyous one around their hearths and homes.—W. WOODLEY, Beedon, Newbury.

HAS THE B.B.K.A. OUTLIVED ITS USEFULNESS?

[7705.] I have been much interested in the letters that have appeared recently in the JOURNAL, and especially those from the honorary secretaries of Cumberland and Lancashire, in which the question whether the B.B.K.A. has outlived its usefulness has been discussed. I think it still has some useful work before it. I quite agree with what these honorary secretaries have said as to the almost insuperable difficulties which face representatives in counties remote from London in getting to the council meetings of the parent body.

If the council would hold, say, two meetings each year in the counties—the meetings to be followed by a *conversazione*—I feel certain it would be the means of arousing such interest in the B.B.K.A. as there has never been before. Besides this, it would give the members of the county associations a chance of meeting the leaders of the craft and discussing matters relating to its welfare. Should the council adopt this policy, I can assure them of a most hearty welcome in Lincolnshire. I may say that during the past few years the Lincolnshire Association has held its annual meetings in different parts of the county with gratifying results.

During the past few years I have come in contact with a great many bee-keepers, and I find there is almost universal disappointment at the fact that no move is being made to get a Foul Brood Bill passed.

It is no use county associations spending money in struggling to get rid of this scourge so long as there are bee-keepers who will not make any attempt to rid their apiaries of the disease, so that they are a menace to all bee-keepers in their neighbourhood.

I think that the time is now ripe for renewed efforts in this direction, and funds would readily be forthcoming to carry on the campaign. Surely if the Irish Bee-keepers' Association, small as it is numerically, can get such a measure

passed, it ought not to be difficult for the British to do likewise. Let the council show that they are in earnest in this matter, and there will be no lack of support for the parent body.—JAS. H. HADFIELD, Hon. Secretary Lincs B.K.A.

BRITISH BEE-KEEPERS' ASSOCIATION

[7706.] Will you permit me to point out to your correspondents Mr. Arthur Schofield and Mr. J. L. Brierley, and also to others who have expressed their views in previous issues of your journal, that the scheme of reorganisation which is now under consideration by the councils of the various associations goes a very long way towards carrying out the various suggestions which have been made to improve the general organisation? The principle of the scheme is well expressed by the motto "Unity is Strength."—E. G., Berks.

ITALIAN BEES AND FOUL BROOD.

[7707.] When some years ago (1906) you spoke against Italian bees (as you have done again in the last few weeks), the editor of our bee-paper, *L'Apicoltore*, wrote as follows in October, 1906, page 192 (I translate a portion of it from the Italian):—"The illustrious president of the American B.K.A., C. P. Dadant, has sent us the following letter: ". . . In reply to that assertion [Mr. Cowan's], I wish to bring my witness in favour of Italian bees. I and my father have imported Italian bees regularly for years, but particularly from 1874 to 1880. During these six years we imported from Italy nearly 400 queens a year, and all were introduced into our colonies before being sent to all the States of the Republic and to Canada. We have never had a single case of foul brood, and never have we received a single complaint from any of our numerous customers: nor was the slightest suspicion expressed by anybody that our imported queens had brought foul brood. . . ."

Let me add to Mr. Dadant's declaration some lines of an article, "Foul Brood: How to Cure," by Mr. McEvoy, foul brood inspector for Ontario (Canada), in the Government employ, who says: "I was pleased to hear Mr. House, of New York, come out so strong in our convention in favour of the yellow bees. I judge that Mr. Wright, who is one of the inspectors for New York, is also an advocate of Italians for keeping brood-chambers clean and free from dead brood. I never found any race of bees that was as good as pure Italians to feed their brood." (*American Bee Journal*, Jan., 1909.)

In "A B C and X Y Z of Bee-Culture" Mr. Root says: "Mr. Alexander,

who has something like 700 colonies in one locality, reports that he was successful in eradicating this dreadful disease from his apiary by dequeening and putting in Italian blood; but before giving the new queen he keeps the hive queenless at least three weeks. . . . A young vigorous Italian queen is then introduced."

On account of your assertion ". . . They have produced by selection a bee which they call Italian," I must say that America imports every year thousands of queens direct from Italy, and that almost all my American customers are professional queen-breeders, who rear their Italian queens from imported mothers.

About the actual state of foul brood in Italy I am going to ask the Italian B.K.A. What I can assert is that the disease is almost unknown in this province. In my apiaries I have never had a single case of foul brood, and during the bee-season I can show anybody 400 healthy colonies and 500 healthy nuclei.

I hope that for the sake of justice you will publish my entire letter in B.B.J.—E. PENNA, Bologna.

THE PAST SEASON IN EAST SUSSEX.

[7708.] Not having seen any notes in B.B.J. about the past season in this part of our county, I should like you to have my experiences. The season here has been almost a total failure. The weather in May was splendid. Our hopes were at their highest pitch. Stocks were almost boiling over with bees, some of the hives having two and three racks on, and on the last day of May honey was coming in fast.

I took a completed super off one hive. Then came June, cold and wet, and though clover bloomed abundantly, the little workers were kept in their hives. Our hopes then began to droop. The weather in July was worse, and the season was practically over, for us at any rate. So far as I can gather, the average "take" was about 10 lb. per hive. Wax-moth has been very troublesome. We are hoping now for a better season in 1910, and send best wishes to the Editor and all connected with the craft. I would specially like to tender my best thanks to Messrs. W. Woodley, "D. M. M.," and that grand critic L. S. Crawshaw.—H. CLARKE, Icklesham, Sussex.

HONEY IMPORTS.

The value of honey imported into the United Kingdom during the month of November, 1909, was £1,983.—From a return furnished to the BRITISH BEE JOURNAL by the Statistical Office, H.M. Customs.

BREEDING THE BRITISH GOLDEN BEE IN RIPPLE COURT APIARY.*

HOW MATING IS CONTROLLED.

By F. W. L. Sladen, F.E.S.

(Continued from page 499.)

1909 RESULTS.

The 1908 notes were ready for publication in the BRITISH BEE JOURNAL in the spring of 1909, but the Editor kindly consented to defer their appearance until after another season's work, which I expected would make several details clearer. The summer of 1909, although unfavourable for bee-keeping in most parts of Britain, proved a better one for the par-

some definite evidence as to the value of restricted-mating weather. Fortunately the weather could scarcely have been more suitable, and the results, which are summarised below, clearly indicate the importance of restricted-mating weather. The figures speak for themselves, but it may be remarked that the strongest evidence they furnish in support of the value of restricted-mating weather is found in the fact that the twenty-two matings attributable to nearly a week of continuous restricted-mating weather at the end of July produced 27 per cent. more goldens than the thirty-three matings attributable to nearly two weeks of continuous



RIPPLE COURT APIARY.

ticular work carried on in Ripple Court Apiary than 1907 or 1908, and a larger number of queens were reared and mated than in either of those years.

Although two years' observation had convinced me of the usefulness of restricted-mating weather, the 1908 records that were preserved do not make it very plain. The successful matings recorded as occurring in July which seemed attributable to restricted-mating weather were very few, and it is not certain that all of them did take place in restricting weather. It is true that many successes resulted from matings in restricting weather after August 4, but there is no evidence to show how far these were due to mating late in the season. I therefore hoped that, with suitable weather in 1909, a larger number of matings might supply

free-mating weather in August, the law that July matings produce a smaller proportion of goldens than August matings having been, in these periods, overruled by the weather. The fact that these periods were preceded, separated, and followed by periods during which no matings were possible makes this result the more reliable.

Restricted-mating weather is an attribute peculiar to the British climate. It scarcely occurs in such great bee-keeping countries as the United States, Italy, and France. In England it reaches its best on the coasts and in high localities. There must be many good spots for restricted mating in Scotland and Ireland.

The 1909 figures also show how unreliable and sometimes misleading an insufficient number of observations may be in an investigation of this kind.

*Copyright reserved by the Author.

LIST OF THE MATING DAYS AT RIPPLE COURT APIARY IN 1909 AFTER JULY 5, WITH THE COLOUR RESULTS FROM THE 123 TESTED QUEENS THAT APPEARED TO HAVE BEEN MATED ON THESE DAYS.

Mating Day.	Weather on Mating Day.	Number of Queens apparently mated on this day.	Approximate proportion of Golden-Coloured and Intermediate-Coloured Workers Produced.		Percentage of Golden-Coloured Workers.
			Golden	Inter-mediate.	
July 9	FR	10	14 to 86	—	25% (in FR weather)
" 13	FR	4	13 " 27	54 to 166	
" 14	FR	8	27 " 53	—	65% (in R weather)
" 17	R	6	38 " 22	71 to 39	
" 18	R	5	33 " 17	—	41% (in FR weather)
" 19	FR	11	30 " 60	82 to 118	
" 20	FR	9	52 " 58	—	72% (in R weather)
" 27	R	2	7 " 15	—	
" 28	R	2	40 " 20	—	50% (in F weather)
" 29	R	5	46 " 4	158 to 62	
" 31	R	5	— " —	—	39% (in FR weather)
Aug. 1	R	9	65 " 25	—	
" 4	FR	7	42 " 28	—	50% (in F weather)
" 5	FR	6	10 " 50	65 to 97	
" 6	FR	2	6 " 14	—	93% (in R weather)
" 7	FR	1	5 " 5	—	
" 8 & 9	FR	0	— " —	—	93% (in R weather)
" 11	F	3	16 " 14	—	
" 12	F	4	26 " 14	—	50% (in F weather)
" 13	F	7	36 " 34	85 to 85	
" 14	F	2	7 " 13	—	15 Queens, evidently mated on these days, commenced laying on various dates in September.
" 15	F	1	0 " 10	—	
" 17	FR	0	— " —	—	140 to 10
" 28	R	15	— " —	—	
" 29	R	15	— " —	—	93% (in R weather)
Sep. 2	R	15	— " —	—	
" 10	R	15	— " —	—	93% (in R weather)
" 11	R	15	— " —	—	
" 12	R	15	— " —	—	

F = Free mating weather. FR = Less free mating weather. R = Restricted mating weather.

All the queens, except two, were bred from parentages producing only golden-coloured workers. Ninety-three of the queens were grand-daughters of "V" and twenty-eight were grand-daughters of "A" (see page 482). The conditions as regards isolation and drone-breeding did not differ materially from those in 1908. All the drones were bred from golden-coloured queens, and roughly about 80 per cent. of them from queens producing only golden-coloured workers.

The proportion of goldens to intermediates produced by each union could only be approximately estimated; moreover, it seemed to vary a little. Most of the 1908 unions producing golden majorities were re-tested by a more accurate method in June, 1909; it was then found that several of the 8 to 2 were nearer 7 to 3 or 2 to 1. The result from No. 55 (1908) was unique; probably a second testing would have shown it to be all goldens or all intermediates. It may be observed here that every year a few of the golden-coloured queens bred from parentages producing some goldens and some intermediates had the scutellum and the tip of the abdomen darker than in typical

golden-coloured queens and were evidently heterozygous.

Another question I set myself to investigate in 1909 was how far the greatest degree of isolation obtainable would affect results. For this purpose five virgin queens from parentages producing only goldens, and two or three hundred drones also from parentages producing only goldens, were placed in baby-nuclei at Hope Farm, a very isolated spot on the open downs close to the sea-cliffs, about midway between the villages of Kingsdown and St. Margaret's Bay. Careful inquiry in the neighbourhood failed to reveal the existence of any colonies of bees within a mile of Hope Farm, and as the spot is rather more than half surrounded by sea, it follows that there were fewer bees by more than a half living beyond that distance than in an equally thickly populated district inland. One of the queens appeared to have mated on August 4; she produced only intermediate-coloured workers. Two more queens appeared to have mated on August 7; one of them produced only intermediates, the other produced one golden to nine intermediates. The two remaining queens appeared to have mated on August 14; they both produced intermediates only. Evidently none of these queens mated with golden-coloured drones, the extent of isolation not being nearly sufficient to ensure pure mating.

I do not know how far queens and drones can fly—in America workers have been observed to fly four to seven miles in search of food*—but I would not rely on isolation for pure mating anywhere in Britain, except on an isolated island. Supposing three miles were the limit of flight of queens and drones, one would have to ascertain by careful inquiry that no bees were kept within a radius of over six miles, and then one could not be sure that no colonies existed in hollow trees or in buildings, or that swarms might not settle in the district.

(Concluded next week.)

Echoes from the Hives.

"I live within half a mile of where the 'auld bee-man' (Pettigrew) lived, and knew a number of the bee-keepers mentioned in the 'Young Bee-man's Book,' but the last of them died some years ago. When I have time and some honey to 'bounce' about, I'll maybe gie ye a bit screed, but us bee hams up here are kinna doon i' the win the noo, but ettling tae dae something gran' next year if the weather's guid."—P. M., Carluke, N.B.

* See *Gleanings in Bee-Culture*, vol. xxxvii., page 577.

CAPPINGS OF COMB.

BY L. S. CRAWSHAW, NORTON, MALTON.

Reform by the Ton (page 446).—I have read Mr. Coates's contribution with interest, and, he must forgive me, with some little amusement. Apparently we have a panacea for all the ills we suffer in 400 tons of British honey! A common purse for the associations—more bees and beekeepers—a land flowing with fruit and honey—and an extended market for the extra tonnage. The next thing, we know, we shall have the Board of Trade insisting on a "Plimsoll disc" for the overloaded hives! Man, but it's a fine dream! Just come to earth a moment whilst we whisper in your ear that 400 tons by no means represents the imports you are desirous of excluding. Teupence a pound! My good sir, I shall be surprised if it exceeds 2½d. per lb. So your tonnage must be multiplied accordingly. Now, sir, are you prepared to compete? As a matter of fact, British honey cannot close the door to the foreign honey, a good deal of which is only fit for manufacturing purposes. British honey, at its best, is an ideal table honey; and, whilst there is little real comparison possible between British and foreign, the former does suffer to some extent from the competition. So that it becomes not so much a question of how to produce the extra honey as how to dispose of the present crop.

NOTE.—Since the above was set up, I see that "D. M. M." expresses the same opinion as to the quantity of honey, and Mr. Cowan confirms this, as 27s. per cwt. is a usual price for imported Jamaican honey.

Heather-secretion (page 465).—This instructive chart is worth examination by those interested. Its value would be even greater, and some deductions might be drawn, had morning and evening readings been taken throughout, as in the second half. The night losses might be shown to bear a definite relation to the increase and to the quality of the honey, judged by the prevailing weather conditions. It is possible that a morning rain may stimulate nectar-secretion, whilst causing the nectar to be thin. The practical observations show that the returns would be increased were the alighting-boards taken to the ground; and the aspect of the hive is of some importance. Generally speaking, the early bee gets the nectar, and hives facing eastwards are astir the soonest.

Queries and Replies.

[3983.] *Cross-breeding of Bees.*—I have about a dozen stocks in my apiary, and up to the present year I have kept none but the ordinary black

bee. This summer, however, I got a swarm of British Golden from Mr. F. W. L. Sladen, Ripple Court, Dover. I also bought a swarm of Italians direct from Bologna, Italy, which arrived after the swarming season. Will you please say if it would be harmful or otherwise to leave the apiary as it is at present? Would there be too many cross-breeds? Would the cross-breeding make the bees extremely irritable and hard to work, and would it spoil them as regards the take of honey? Will you please let me know what the advantages or disadvantages would be in a case like this? If it would not be advisable to leave them as they are at present, I could send the Italians and Golden to some distance, and thereby prevent any cross-breeding. I should be obliged for advice on the matter. Also, what would be the shortest distance necessary to divide the stocks?—K. B. W., Mallow, Ireland.

REPLY.—The cross-breeding would tend to make the bees irritable and more difficult to manipulate, but as a rule such bees are very good workers, so that you need not fear about them spoiling the take of honey. If Italians and British Golden succeed in your district, we would recommend you to re-queen your black stocks with queens raised from them, and thus eliminate the black blood. It would be difficult to prevent cross-breeding by removing the bees, unless you can make sure that there are no other bees within ten or twelve miles of you.

Notices to Correspondents.

A CONSTANT READER (Cheltenham).—*Feeding in Winter.*—1. Thick syrup is not a suitable winter food for stocks and driven bees short of stores. At this season only soft candy ("Guide Book," page 195) can be safely given. If the candy is properly made, bees can use it without having to leave the hive to fetch water, as there is always sufficient condensation in the hive to keep it moist. 2. It is impossible to say just at what period and by whom the bee was first domesticated and brought into close contact with man. The history of bees is found written in hieroglyphics on the Pyramids of Egypt and on ancient tombs, long before writing was discovered, and this shows that the management of bees occupied the attention of man at the earliest period of which we have any record. The first indication of attention to bees is contained in the Old Testament, where in connection with honey and wax they are mentioned in no fewer than twenty of the books. In Genesis xliii. 11 the patriarch Jacob tells his sons to take with them into Egypt, among other

things, "a little honey." We are led to the belief that honey was an article of commerce even previous to this time from inferences drawn from Homer. There is no regular history of the science of bee-keeping before the days of Aristotle (300 B.C.), although prior to that time we read of persons having devoted many years of their lives to an investigation of the manners and habits of bees. As regards Britain, the extensive notice we find of "mead" and "metheglin" in the days of the Druids would lead us to believe that bees were domesticated by the Britons; but there are no authentic records, and the honey they used may have been collected by wild bees. No doubt the Romans when they came (A.D. 43) taught the Britons how to hive and domesticate the honey-bee.

GWENYNNWR (Glamorgan).—*Combs Built Across Frames*.—1. You were wrong in

living your bees in a frame-hive without foundation. The best thing you can do is to get them transferred into another hive next season, either in the manner described on page 150 of the "Guide Book" or drive the bees, make an attempt to cut out the combs and fit them into frames. 2. The honey was not properly ripened, which will account for the thin layer on the top (see page 87). 3. There is a pamphlet published by the B.B.K.A. on "The Adulteration of Honey," by Otto Hehner, price 6½d., post free. 4. The associations generally arrange the time when their expert should visit members. 5. The best time to prepare bees for winter is in October.

L. H. (Holmwood).—*Perforated Dummy*. You could use the perforated zinc as you propose, but the "Wells" perforated wooden dummy would be preferable.

H. D. (Long Melford).—*Wax-moth in Combs*.—There is nothing in comb sent but sealed honey and pollen. The comb is badly infested with wax-moth, and the colony must have been very weak for it to have obtained such a footing. It is very probable that the few bees in the hive left in consequence of wax-moth getting the mastery. Keeping colonies strong is the best remedy.

E. L. (Royston).—*Race of Bees*.—English bees are good workers.

H. S. (Llandebie).—*Source of Honey*.—The honey is very clear, of good consistency, and light coloured. It is from mixed sources, and contains pollen-grains of leguminosae, labiatae, compositae, and liliaceae. The strong flavour is derived from *Crocus sativus*, a very small quantity of this imparting the saffron flavour.

LOWER WARD (Renfrewshire).—*Bee-keeping in British Columbia*.—There are

a good many bee-keepers in the fruit-growing districts of British Columbia, but at the present time the industry is in its infancy. We know of no large bee-farms that are likely to need hired assistance, but if you write to Mr. E. F. Robinson, 16, Young Street, James Bay, Victoria, B.C., who is the leading and oldest bee-keeper in the colony, he might be able to give you the information you require.

E. G. (Peterchurch).—*Books on Bee-flora*.—There is no book in French devoted to this subject, but in the "Nouvelle Flore," by G. Bonnier and G. de Layens, plants visited by bees are marked with a star. The same is done in "Nouvelle Flore du Nord de la France et de la Belgique." Both are published by P. Dupont, 41, Rue Jean-Jacques Rousseau, Paris. In German there is "Unsere Honig- und Bienenpflanzen," by F. Huck, published by E. Freyhoff, Oranienburg, Germany. This is devoted entirely to bee-flora.

M. L. (Kent).—*Expert Certificates*.—A first-class expert certificate can only be held by one who has previously obtained the third and second class certificates. A third-class certificate can only be gained by one who can pass his examination in practical work and satisfy the examiners with regard to his ability to manipulate both skeps and movable-comb hives, and also show a general knowledge of bee-keeping. There are no more examinations this year, but next year apply for particulars to the secretary of the B.B.K.A.

Honey Samples.

A. E. H. O. (Montgomery).—Dark fruit-blossom honey, of fairly good flavour. It contains a little honey-dew, but not sufficient to make the honey unwholesome, and it could be fed back to the bees in spring without harm resulting.

C. C. J. B. (Northants).—Honey from limes, of fairly good quality. It contains very little, if any, honey-dew, and is quite fit for household use. If used for the bees in spring, no water need be added.

M. E. G. (South Wales).—The sample was gathered from mixed sources, and has no distinctive flavour. It is of fairly good quality, its worst point being thin consistency.

Suspected Combs.

ELLIOTT (Hants).—Lot No. 1. In this the comb is affected badly with foul brood. In No. 2 there is no trace of brood, stores, or pollen, and nothing to show the cause of death of the bees.

* * * *Several important letters, &c., are in type, but held over from pressure on our space.*

Editorial, Notices, &c.

REVIEWS OF FOREIGN BEE-JOURNALS.

By "Nemo."

Plurality of Queens in a Hive.—Abbé G. Bagard contributes to the *Bulletin de la Société d'Apiculture de la Somme* the results of his experiments with more than one queen in a hive. He concludes that the generally-accepted opinion that only one queen can live and lay in a hive is the correct one, and that it is only under exceptional conditions and in rare cases that more than one queen is tolerated. He admits that several queens may live in the same hive, and that both young and old queens may fulfil their duties without being "balled" by the workers, but such cases are rare. He shows that the new theory now being promulgated of the existence and simultaneous laying of several queens in one hive is a fallacy. He mentions a number of experiments which he has carried out, and shows clearly that it is only when they are separated and attended by their own group of workers that more than one queen may live in the same hive. He therefore concludes that: 1. Two queens as a rule cannot live together in the same hive and on the same comb. 2. Two queens may live in a two-story hive provided that it is large, so that each queen can form her own brood-nest separately. In this way we have the "Wells" method without separators, or in reality a natural "Wells" hive. 3. The day when the two queens, either from an artificial cause, such as transferring and uniting, or a natural cause, such as the expansion of the brood, find themselves in the presence of one another, one of them is bound to be destroyed.

Apple and Honey Beverage.—The following recipe is given in *Praktischer Wegweiser*: Cut up six ripe apples without removing the peel, and pour over them 1 litre (1 $\frac{3}{4}$ pints) of boiling water. Cover up, and allow it to stand for one day. The liquid is then poured off, the juice of one or two lemons added to it, and it is then sweetened with honey according to taste. It is an excellent remedy for a cough or cold.

BREEDING THE BRITISH GOLDEN BEE IN RIPPLE COURT APIARY.*

HOW MATING IS CONTROLLED.

By F. W. L. Sladen, F.E.S.

(Continued from page 508.)

CONCLUSION.

The foregoing evidence leaves, I think, no room for doubt that the British Golden bee is actually bred by selection

in the strict sense of the term that other animals in which improvement has been made have been bred by selection, the selection of the fathers having been effected by colour,* aided by (1) large numbers of drones, (2) isolation as far as is practicable, (3) restricted-mating weather, and (4) mating late in the season.

As was stated at the commencement of these notes, the breeding by selection has been carried on with the object of improving the honey-producing character in the British climate, and each spring the best honey-gatherers have been very carefully selected for breeding purposes from the pure stock bred the previous year. The result has been a steady improvement noticed, not only in Ripple Court Apiary, but in the reports received from people in different parts of the kingdom who have tried British Golden.†

Breeders of every kind of animal and plant are agreed that the best way to improve a character is to select and breed for that character only in every successive generation. Consequently I have had to rather neglect other objects, as, for instance, the improvement of temper. Yet the temper of British Golden has become gentle of its own accord, probably as the result of in-breeding, and it is doubtful if it could have been improved any better by selection: even the hybrids are better-tempered than ordinary bees. No attempt has been made to increase the golden colour, and it does not extend over so large a portion of the body as in some American Golden. There is, however, one character, the quality called "constitutional vigour," which no breeder can afford to ignore, and which I regard as of the greatest importance in bees. Fortunately, this character is closely associated with honey-production; it is also connected with hardiness, prolificness, and disease-resisting power, and all these good qualities have been worked for with success. There are many indications that British Golden are growing very hardy: the golden-coloured bees were noticed to be busily bringing in honey and pollen on several days in May, 1909, when the temperature was only 52 deg. to 54 deg. with a strong breeze; there was a marked diminution in the proportion of queens that failed to get mated in Ripple Court Apiary this year, and there is good reason for believing that several queens were mated at the beginning of September in a temperature of about 61 deg., which is lower than that noted in any previous year. No difficulty has been found in

* For details of this method of breeding by selection, see my papers in the *BRITISH BEE JOURNAL*, vol. xxxiv., page 132, and vol. xxxv., pages 21 to 23.

† See Sladen's "Catalogue of Bees and Queens," tenth edition.

maintaining great prolificness in spring, which is so valuable a feature in good Italians.

A great many good reports, some of them from very cold and bleak localities, have been received respecting the half-bred bees produced by British Golden queens mated to ordinary native drones.* In many cases these bees have proved extraordinarily industrious, hardy, and prolific. With bees, as with cattle, sheep, poultry, and fruit, the greatest profit is often obtained from half-breds. It is fortunate that this is the case, because, in ordinary circumstances, pure mating is so rare and uncertain that, in introducing a new breed into his apiary, the bee-keeper who works for honey is compelled to let it cross with the local variety. The crossing imparts energy, which seems to result from the blending of the golden and black colours, or of characters associated with them. This added energy, which means so much more honey gathered, would have been lost had the bred bee been black. Besides, it has been shown that it would be very difficult, if not impossible, to breed a black bee by selection in this country.

W. B. CARR MEMORIAL FUND.

Amount already acknow- ledged	£	s.	d.
Dr. Elliott	60	12	0
J. J. Asley	1	1	0
C. W. Dyer	0	10	0
T. Ewart	0	2	6
W. B. C.	0	2	6
G. A. Pimm	0	2	6
J. Hawes	0	2	6
H. Samways	0	2	0
J. Brown	0	1	6
"J. G." (Elgin).....	0	1	0
	£63	0	0

The above fund is now closed.

Correspondence.

The Editor does not hold himself responsible for the opinions expressed by correspondents. No notice will be taken of anonymous communications, and correspondents are requested to write on one side of the paper only and give their real names and addresses, not necessarily for publication, but as a guarantee of good faith. Illustrations should be drawn on separate pieces of paper. We do not undertake to return rejected communications.

BEE-KEEPING IN SOUTH AFRICA.

[7709.] Some time ago, being ordered abroad for my health's sake, I made inquiries of the Editor of the B.B.J. about the prospects of bee-keeping in South Africa. He kindly furnished me with the names and addresses of several of the leading bee-keepers there, and I have

been in communication with them. In the hope of being helpful to other bee-keepers in like circumstances, and perhaps of interesting others who enjoy the great blessing of sound health, and are not under the painful necessity of "tearing up the roots" and seeking a more genial climate, I venture to append a few notes on the subject, gleaned from the replies of my correspondents.

Mr. H. L. Attridge, Bellville, Cape Colony, in a very helpful letter, says: "Bee-keeping in South Africa, on modern lines, is still in its infancy. There are practically no large apiaries, and I question if any district will carry more than about fifty colonies profitably in a single apiary." Mr. Attridge, a photo of whose apiary appeared in a recent number of the B.B.J., goes on to say that the average yield per hive is not so good as in this country, and prices are very little higher, with the exception of Johannesburg, and there prices are falling. Colonists are not large consumers of honey.

I wrote chiefly for information from a health and commercial point of view, and Mr. Attridge replies: "With regard to employment in a large apiary, your chances are very remote. Providing a suitable district were obtainable, where bee-keeping could be conducted profitably, in nine cases out of ten it would be a district unsuited to your lung trouble. The districts where you would obtain the greatest benefit from a health point of view are the very parts where bee-keeping is practically unknown."

As Mr. Attridge has been settled a long time in South Africa, and is besides apicultural adviser to the Cape Department of Agriculture, his information can be thoroughly relied upon.

There appear to be no large apiaries in the Transvaal.

With regard to the prospects in Natal, the report of Mr. W. C. Mitchell, Government apiarist and secretary of the Natal B.K.A., is pretty much of the same tenor: "There are no large apiaries in Natal that would employ a European assistant. The largest I know of contains only 100 hives. Apiculture is as yet quite in its infancy out here, but a great improvement has taken place within the last few years, although it is likely that it will be a very long time before anyone takes up bee-keeping for a living."

From these reports it would appear that, while the industry in South Africa is a progressive one, it has not yet reached that stage where it holds out opportunities for qualified assistants or for one who hopes to earn a livelihood by bee-farming alone.

Those, then, who, like the writer, desire to gain a living by bee-keeping as

* Sladen's "Catalogue of Bees and Queens," tenth edition.

being a congenial and healthful occupation must look to other countries than South Africa.—LOWER WARD, Renfrew.

BRITISH BEE-KEEPERS' ASSOCIATION

[7710.] I have read with much interest the letters of Mr. Avery on the above subject (pages 466 and 487), and the reply by Mr. Bold, and think that the suggestion made by the latter, that the meetings of the Council be held in other parts of the country than London, will meet with the approval of bee-keepers on every hand, and would help to rouse a wider interest in bee-culture, without which we shall fare badly if the coming season is no improvement upon the last three. If one enthusiastic bee man or woman could be found in each district like the one Mr. Bold mentions, who would persistently strive for the upkeep and advancement of the craft with the work done by the Association, what a power for good it would be; for we must admit that no one could take up a more interesting or fascinating hobby, and it is one that caters for the public good, although people seem to be very slow to see it, but it is for want of knowledge of the value of honey and the work done by the honey-bee. This brings me to another point. Mr. Bold suggests Carlisle, York, Liverpool, and Birmingham as suitable places for meetings. Of course, much can be said in favour of holding them in large towns—the train service, &c.; but bee-keeping is surely an agricultural pursuit, and bricks and mortar do not make good honey, while townspeople would rather go to see a play than attend a bee-meeting. Would it not be better to hold them in country places—where the honey is gathered, amongst people who would consider it worth their while to attend? An example of the interest townspeople take in agricultural pursuits was shown when the Royal Agricultural Society held their show at great expense in London. The result was a complete failure.—M. L., Lancs.

BEEES IN BURMAH.

We have received the following interesting letter from Mr. H. Richardson, of Marlborough, which shows the curious superstitions which cling to bees in the South Shan States:—

DEAR SIR,—The following extract from a letter of a Burmese native is curious. Does a similar superstition exist in other countries?

"Some time ago a swarm of bees settled in my house, and I knew that trouble was at hand. Ten days afterwards my son died, then two cows, and then my sister; and I cleared out. If the bees had only swarmed in a rice-pot or a box I should have had good luck instead of bad. A man

in my town had a swarm in a rice-pot; so he rushed off to a gambling den and won a thousand rupees."

—Faithfully yours, L. E. C. EVERARD.

AMERICAN AND COLONIAL PAPERS.

EXTRACTS AND COMMENTS.

By D. M. Macdonald, Banff.

Honey-dew.—"If I had honey-dew once outside any hive of mine I would keep it there," wrote Mr. Holterman some time ago. Mr. Crane, commenting on this, says: "Hold, my friend! If I had honey-dew I would just carefully save it until spring, and feed it to hives short of stores or for stimulating brood, for which it is worth as much as any honey." Since my recent article appeared, I learn that there is a considerable diversity of opinion on this subject; but this has been always so since Virgil wrote of "heavenly honey" and Pliny of the "spittel of the starres." In America the same difference prevails. Firstly, as to the seasons in which it is most prevalent. Some States report a "dry," others a "wet," season. Secondly, as to *when*—all the months from and including March to October being named. Thirdly, viewed as a winter food, some would use it; others hold it is "very dangerous." Some consider it is not nectar, but "bug juice"; others say it is quite palatable, and one sample is described as "deliciously fine." Here is another idea. We have for long been taught that the granulation of honey is a test and proof of its purity. From Medina we now learn that "honey-dew granulates as readily as ordinary honey," and Mr. Dundas Todd, British Columbia, assures us that with him it seemingly granulated in *forty-eight hours!* Evidently, as one of my correspondents says, the "last word" has not been written about honey-dew.

Pollination.—Perhaps no other single feature of apiculture is more deserving of constant prominence than the inestimable benefit derived by flowers and fruit from the visits of *Apis mellifica*, and I rejoice that all over Beedom it is receiving full attention at present. An American fruit journal says: "It is proved conclusively that many varieties are sterile to their own pollen; that wind is not an important factor in pollinating; and that the bee is practically the sole agent in doing the important work." Mr. Root, in commenting on this, adds: "It is safe to say that practically all of our experiment stations and our most progressive fruit-growers have now come to recognise the importance of having bees located in orchards. If they cannot get a bee-keeper to locate his bees near them they are buying bees themselves and placing them there."

Mr. Beuhne, in *Australian Bee-keeper*, has an important article on this subject, and states: "The honey-bee is not only the most important factor in pollination, but the one insect which is best adapted for the purpose." His own orchards are very productive, and he has never any poor setting of fruit, just because he has so many bees. Mr. Isaac Hopkins, New Zealand, finds the same true: "Bees never harm blossoms, but are a tremendous aid through pollination, and in this way are far more valuable to the world than for their honey." How important the honey-bee is as a fertiliser may be gathered from Mr. Cowan's statement regarding a spring orchard, page 404: "Twenty bees are flying and visiting blossoms for one of any other kind of insect."

Apicultural Education.—In December *Record*, page 181, appears a picture of a "Nature study class and the bees," and it seems the work is "a great attraction" for the children, and that they "greatly appreciate" the opportunity of seeing live bees manipulated. *Gleanings*, for November 15, informs us that even in New York bee-culture is taught in the public schools, and that this Nature study stimulates the children to see, to think, and to love some of the useful creatures in this world of ours. The class teacher remarks: "In all my years of teaching, I have known nothing that would so develop a child's powers of observation and ability to relate orally or in writing a mass of true scientific investigation." This is true, as many teachers have remarked already. Here is another important feature of the bee-lesson: "It is worth something to get a crowd of boys in such a frame of mind that under no circumstances would one of them step on, or otherwise intentionally kill or injure, a useful insect." The editor emphasises this last sentence by printing it in italics. I sincerely believe the lessons would have this effect:

He prayeth best who loveth best
All things both great and small.

But I have yet one more sentence to quote. "Bee-keepers would do well to encourage and keep our teachers in this work, not alone because it will stimulate a demand for their product, but because it will open up to thousands a new world of thought and love for insects." Learn young, learn fair!

A Lively Imagination.—I thought that Mr. Doolittle was a *practical* apiarist, but now I have my doubts. He imagines drones have special "congregation places," where queens apparently assemble to be wooed by one or other of the "thousands, if not millions," of these would-be fathers of the hive. One year this spot was an Arcadian grove, but

another season it was on a hill. I thought till now drones sought queens; this implies the opposite.

Another statement fit for the marines appears in *Gleanings*, page 644: "Some years ago it was stated that, when buckwheat and clover are in bloom at the same time, black bees will work on buckwheat, while Italians will disregard the buckwheat and work on clover"! My only comment is the point of exclamation I have added.

About Queens.—At Roots' yards they liberate a balled queen by "squirting sweetened water from a spring top oiler on the mass of angry bees. All goes on well after." Introducing queens by shaking bees and dropping the queen amongst them as they run in "proved successful on the first lot of queens, but was a practical failure on the next lot." They raised nearly 3,000 queens last season. At a dollar up, what would that amount to?

Notices to Correspondents.

H. J. S. (Andover).—*Zinc Roofs.*—You can procure the zinc of any thickness you wish from any ironmonger, or wholesale of Messrs. F. Braby and Co., London.

C. J. A. (Heytesbury).—*Candy-making.*—1. Keep thermometer in syrup until the temperature reaches 235 deg. When it gets to this point it runs up rapidly in a very few minutes, and should be closely watched so that it does not exceed 240 deg. 2. As soon as the proper temperature is reached boiling should be stopped. 3. Yes, follow instructions in "Guide Book."

G. H. B. (Bath).—*Bees in Tree.*—You cannot get the bees out of the tree now, but as it is going to be cut down you could perhaps get the top above where the bees are cut off first. Then you should have the trunk cut below the nest, and remove the block to where you want the bees to remain. You can then either leave them to swarm or try to transfer them in the spring. You will find instructions how to do this in B.B.J. of April 8 (page 139).

G. B. W., JUN. (New Malden).—*Foreign Honey.*—As the object of the B.B.J. is to encourage British bee-keeping, in order to supply the demand for the superior British honey in place of the foreign product, we cannot recommend you wholesale dealers in foreign honey.

* * * In consequence of the *Index* occupying so much space this week, several important communications (already in type) are unavoidably held over till our next issue.



