

UMASS/AMHERST



312066 0333 3287 6

LIBRARY

OF THE



MASSACHUSETTS
AGRICULTURAL
COLLEGE

SOURCE...C

B



T H E

British Bee Journal,

BEE-KEEPERS' RECORD AND ADVISER.

EDITED BY

THOS. WM. COWAN, F.G.S., F.L.S., F.R.M.S., &c., AND W. BROUGHTON CARR.

VOLUME XIX.

JANUARY-DECEMBER, 1891.

PUBLISHED BY

SIMPKIN, MARSHALL, HAMILTON, KENT, & Co., LIMITED,
23 PATERNOSTER ROW, E.C.

LIBRARY

UNIVERSITY OF
MASSACHUSETTS
AMHERST, MASS.

LONDON:
PRINTED BY STRANGWAYS AND SONS
Tower Street, Cambridge Circus, W.C.

INDEX.

- Appliance dealers, 10, 45, 68, 90
Autumn preparation, 25
Amount of bees and food for winter, 28
Amateur hive-making, 33
Adding to warm wrappings, 50
Aged queens, 56
Another tall one, 72
Abnormal drones, 255
Alimentary canal, 196
Are bees a nuisance, 201
An early swarm, 242
Apicultural mems., 257
Ants in hives, 263
April swarm, An, 301
Advance in price of beeswax, 302
Appreciative, 312
Address on bee-keeping, 371
Autumn feeding, 413, 421; work, 437
Are the queens of foul-broody stocks diseased, 407
Another bee-case, 457
Average honey yields, 500, 513, 528
Amount of food for winter, 504
About bees, 509
Are we drifting from our moorings, 518
ASSOCIATIONS:—British Beekeepers', 15, 52, 87, 110, 135, 146, 194, 225, 229, 236, 273, 288, 307, 326, 427, 438, 450, 462, 485, 533, 581; Irish, 28, 184, 353, 462; Leicestershire, 40, 150, 184, 199, 347; Kent, 40, 307, 572; Nottingham, 52, 337, 367; Derbyshire, 88, 452; Northampton, 89, 357; Notts, 102; Middlesex, 111, 316; Essex, 138, 289, 464, 530; Ulster, 138, 291, 302, 358; West Cumberland, 163; Worcestershire, 184, 327; Scottish, 185, 348, 356; Bristol, 246; Warwickshire, 246; Hull and East Riding, 249; Hauts and Isle of Wight, 336; Lincolnshire, 346, 347; Yorkshire, 356; Berwick, 357; Bristol & District, 358, 549; Wigtownshire, 359, 428; Glamorganshire, 368; Buckingham and District, 368; Shropshire, 377; Wilts, 378; Goole and District, 379; Etwell (Derby), 379; Melrose, 380; Staffordshire, 390; Wotton-under-Edge, 402; Oxfordshire, 493; Lancashire and Cheshire, 414, 427; Jedburgh and District, 417; Herefordshire, 428; Berkshire, 535; Hunts, 559
Apology, An, 533
Average yields, 540, 554
Averages, Honey, 542
Asthma and Naphthaline, 545, 553
A reply, 561
An explanation, 582
A few mems. from recent readings in the *Bee Journal*, 533
A warning, 594
Bee-papers for winter reading, 2, 22, 25, 49, 73, 97, 134, 146, 158, 170, 182, 195, 206, 276, 513
Bee, associations in America, 29; clippings, 72; rumbles in Savoy, 76, 87, 100, 111, 148, 160, 171, 196, 218, 229; appliances, 106; flowers, 115, 242; association for North Wales, 130; houses, 139, 177, 201, 385, 430; and honey shows, 150, 166, 194; shows to come, 239, 247, 256, 282, 290, 303, 314, 322, 331, 353, 363, 366, 372, 380, 395, 410, 421, 434, 445, 453, 464, 483, 494, 505; experiences, 248; management, 281; association in the Midlands, 209, 327; show at Portsmouth, 311; Associations, County Councils, and Technical Education, 315; sugar, 328; season in the North, 361; and honey statistics, 386; Association for Sussex, 444; law, 501; Associations and County Council Grants, 502, 527; notes, 529; culture in Southern California, 530, 537; candy, Making, 534
Bees, in a blackberry bush, 21; perishing on snow, 68; refusing candy, 83; deserting hive, 119, 424; dying, 119; robbing, 119; and odours, 124; in Cumberland, 176; in a tree, 179; and red clover, 189; in Valencia, 210, 241; and fruit growing, 213, 491; and vaseline, 213; fighting, 231; and orchids, 245; fighting, 258, 272; and horse food, 281; fighting among themselves, 290; of the Old World, 295; in Scotland, 311; gathering from laurel leaves, 313; in a pillar letter box, 314; and superfluous wax, 321; refusing to enter supers, 323; in Canada, 329; settling on the right man, 332; The, 333; and fruit-growing for farmers, 335; attaching combs to separators, 352; and second-crop red clover, 353; casting out drones, 354; transferring themselves to lower hive, 375; not working in supers, 395; and hops, 443; attacking horses, 444; at the Wetherby Agricultural Society's Show, 453; for South Africa, 455; in hive roof, 456; and fruit, 457; in County Wexford, 479; in California, 479; mating, 483; as fertilisers, 510; and the production of heat, 513; in North Wexford, 542; the law of, 542; sending, by post, 543; Cyprian, The last of, 537; for South Africa, 563; near towns, 564; in South Africa, 575
Bee-keeping, for women, 29; near towns, 33, 57; in Spain, 43; and technical education, 150, 225, 236; in Kent, 164; for profit, 201; in Ireland, 231, 497; in the mountains, 331; from a man's standpoint, 372; in Middlesex, 455; extraordinary, 501; in South Australia, 515; in Lincolnshire, 554, 563; Technical Education, in, 551; The future of, 585; How to begin, 539; in South Australia, 596
Bee-keepers' Association for Scotland, 103
Beginner's query, A, 23, 83
Bnying bees, 70
Building up in spring, 76
British and Irish honey company, 23, 114
Brood nests and queen-excluder, 116
Bath and West of England Agricultural Society, 146
Biographies of bee-keepers, 170
Balance sheets, 175, 200
Beginning bee-keeping, 178
Beet sugar for bee-food, 186
Bruin, 208
Balling queens, 244, 445
Bacillus minor and bacillus depilis, 282
Buying honey for competition, 312
Bee-keepers, at Wakes Colne Rectory, 317, 326; special gathering of, 536
Boxes for carrying driven Bees, 354
Biter bitten, The, 370
Bird stung to death by bees, 371
Booming Punic (?) bees, 419
B.B.K.A., 533
Berkshire B.K.A., A, 535
Bee-culture in Southern California, 537
Bee Associations and County Council grants, 551
Beeswax, Taking care of, 555
Bee-decorations, 562
Bee-keeping, Skep, 563
Bacillus depilis, what causes it? 573
Bees and bee-keeping, Lecture on, 559
Bad-tempered bees, 594
Completing unfinished sections, 30
Cheap hives and appliance dealers, 33, 46
Cleansing flight, 34
Cheap hives, 53
Curious experience in queening, A, 67
Curing foul brood, 81, 441
Cutting down combs, 106
Curious wintering results, 116, 152
Clippings, 119
County Councils and technical education, 133, 425
Clipping queen's wings, 143
Cleaning the specimens, 147
Coloured plates of bees, 152
Changing hives, 167; and disinfecting combs annually, 178
Compound eyes, 208
Coming campaign, The, 216
Comparative weather report of 1891 and 1890 (first quarter), 233
Combs broken down, 243
Complaints of dealers, 250
Cane sugar, 259
Country visitors, 269
Conference of bee-keepers at Doncaster, 274, 279
Comb honey production, 275
Cheap feeder wanted, A, 282
Controlling swarming, 283
Carniolan bees, 288, 290, 301, 409
Cheap feeders, 291, 292
Cone super-clearer, 311, 370
Carniolan queens and swarms, 311
Cardboard wrappers for sections, 319
Carniolans as non-swarmers, 320
Covering for hives, 321
Clearing bees from supers, 325, 370
Cone-shaped super-clearers, 329, 330
Cork-dusk for winter packing, 330
Checking foul brood, 330
Curing foul brood, 352, 430, 432
Cure of foul brood, 359
Chloroforming and driven bees, 362
Completing unfinished sections, 363
Co-operative bee-keepers at the Crystal Palace, 367

1913 SEP 2

- Comb sometimes produced without loss, 373
 Comb foundation, 374
 Contracting hives, 421
 Cuban honey yields, 421
 Cleaning up empty combs, 445
 Crossing of races, The, 452
 Castle Douglas Show, 1891, 454
 Clover honey granulating, 458
 Chain sign, The, 464
 Careful handling of bees, 475
 Crowding the brood nest, 506
 Cleaning out shallow frames, 516
 Candy feeding, 531
 Caudy, Making, 534, 569, 576
 Cyprian bees, The last of, 537
 Completing winter packing, 545
 Comb foundation, Foul brood in, 550
 Curious bee-decorations, 532
 Cleaning up shallow frames, 576
 Combs for melting, 576
 Concentration of forces and non-swarming, 597
- Development in the honey-bee (continued), 6, 52, 101, 162, 209, 266, 333, 404, 488, 548
 Double and single-walled hives, 15, 63, 91, 95
 Doubling, spreading brood, &c., 22
 Double-cased hives, 28
 Dysentery and raw sugar for syrup-making, 39
 Death of a Scotch bee-keeper, 69
 Dysenteric bees, 83
 Direct hiving of swarms, 92
 Damp and mildewed wraps, 115
 Dr. Tinker's book on bee-keeping for profit, 119, 131
 Deserted hive, 119
 Dry mounting, 146
 Drying the specimens, 147
 Detection of rosin in beeswax, 190
 Dissection of insects, 195
 Dorsal vessels, 211
 Driving-sticks, 241
 Disinfecting hives and granulated honey, 251
 Death of 'A Renfrewshire bee-keeper,' 256
 Doubling for prevention of swarming, 273
 Deaf comb, 283
 Decoy hives, 292
 Death from arsenical poisoning, 363
 Dealing with foul-broody stock, 375
 Dome shape v. flap top, 385, 418
 Driving bees, 396, 421
 Dairy show, The, 403, 477
 Discontinued breeding, 421
 Difficulties of autumn feeding, 433
 Distance bees will go to heather, 446
 Destroying a hornet's nest, 455
 Dry food for bees, 469, 490, 514
 Drones and queen in hive at end of October, 492
 Disinfecting combs, 505
 Drone-breeding queen, 529
 Disinfecting hives, 550
 Damage from storms, 569
- Experiment in wintering, An, 8
- Echoes from the hives, 23, 35, 47, 59, 71, 83, 96, 106, 130, 143, 156, 167, 179, 202, 214, 224, 234, 243, 252, 262, 273, 283, 293, 303, 314, 322, 331, 343, 372, 386, 393, 419, 422, 434, 457, 471, 482, 494, 506
- Examining bees, 47
 English bees v. hybrids, 56, 64, 92, 95
 Early queen-wasp, An, 68, 154
 Excessive death rate, 70
 Experts' visits, 90
 Extracting, 98
 Entrances blocked in winter, 117
 Experts and their work, 129
 Experience, An, 129
 Excluder zinc, 169, 193, 201, 221
 Examination of honey by dialysis, 197
 Experiments in apiculture, 233
 Early sections, 258
 Experts' certificates, 301, 433, 504
 Early morning with the bees, An, 302
 Eucalyptus honey, 331
 Extracting heather honey, 364, 446
 Extracted honey for showing, 364
 Extracted combs, 409
 Examining stocks in autumn, 433
 Editorial amenities, 523
 Eucalyptus, Foul brood and, 534
 Experiences of uniting, 561
 Excluders, size of, 573
 Entrance during winter, Width of, 576
 Extracted honey, Shallow frames for, 583
- Foul-brood bacteria, The, 16
 Food and risks of starvation, 39
 Foul brood, 41, 166, 243, 249, 406, 444, 469, 497, 498, 505; and its remedies, 54, 283; in Canada, 66; and comb foundation, 155; and Naphthol Beta, 186; and influenza, 240; and foreign bees, 282; and driven bees, 362; and naphthalene, 393, 419; remedies, 438; in Scotland, 478; legislation, 521, 543; and eucalyptus, 534
 Few hints on fixing up bees in winter, &c., 105
 Floor for uniting, 114, 432
 Furniture polish, 162
 Foreign honey, 163, 340, 507
 Future of bee associations, The, 181
 Four bee-way sections, 224
 Fertile queens, 241
 Finding the queen, 300
 Finding queens, 312
 Forcing hives for clover harvest, 330
 Fatality at a bee-show, The, 346
 Foreign notes, 422
 Feeding up transferred stocks, 435
 Feeding up, 456; for winter, 459, 481
 Finding queens, 464
 Fair exhibits, 468
 First and second-class examinations for experts' certificates, 488; 488
 Fnel for smoker, 517
 Flour candy in winter, 519
 Foul-brood notes, 589
- Foul-broody hives, Winter treatment of, 555
 Feeding in skeps in December, 533
 Getting rid of fertile workers, 31
 Grading honey, 100
 Gardeners and bee-keeping, 187
 Ganglionic chain, 206
 Gleanings, 218, 451, 500, 517
 'Gleanings,' and its new cover, 438
 Getting bees into sections, 283
 Granulated honey, 523, 549
 Golden syrup for bee-food, 597
- Handling bees, 2, 5
 Horse apiaries and a new departure, 20, 33
 Hard bee-candy, 23
 Hive for wintering, 27
 How I use the Raitt honey press, 46
 Hive entrances in winter, 57
 Heavy winter loss, 130
 Hardness of bees, 153
 Horses and bees, 189
 Head, The, 208
 Huber's letters, 245
 Home-made, foundation, 274; simple queen-cage, A, 328; appliances, 449, 476, 514; feeders, 477; rapid feeders, 515
 Hive temperature, 300
 Hatching bees in incubators, 321
 Hiving swarms without guide combs, 384
 How to clarify black and dirty wax with sulphuric acid, 336
 Heating uncapping knife, 395
 Hairless bees, 396
 Handling hives instead of frames, 439
 Hiving driven bees, 444
 Hints, 445
 How to find a queen, 453
 Harvest in West Middlesex, The, 492
 How to make bee-keeping pay, 525
 Honey, companies, 43; granulating, 69, 435; producing, 97; imports, 100, 146, 170, 233, 268, 307, 343, 356, 393, 403, 455, 512, 560; comb designs, 131; and asthma, 189; bees of South-west France, 210; at the Dairy Show, 350, 362, 405, 473; from foul-broody hives, 387; or increase, 408; beverages, 506
 Hives in the flat, 542
 Honey averages, 542
 Humbug in the queen trade, 546
 Huber's letters, 547, 570
 Hives, Disinfecting, 550
 How to begin bee-keeping, 587
 How to find a queen, 591
- In the hut, 29, 89, 127, 174, 240, 299, 369, 465, 538, 555
 Is mead-making illegal? 33, 43, 55, 65, 67
 Importation of foreign bees into Germany, 35
 Is it dysentery? 59
 Incompleted sections, 67
 Importing foreign bees, 78
 Is bee-keeping a success? 139
 In an old garden, 179
 Inside measurements of frames and hives, 214
 Incontinent showing, 384, 407, 419, 431, 432, 477, 504
- Italians and Carniolans, 333
- Joining, bee associations, 233, 248; bees, 273
 Journey for queen-cells in South Devon, A, 319
- Killing queen-wasps, 272
 Keeping bees and fowls in orchards, 456
- Lecture on the honey-bee, 7
 Liquid fruit sugar, 40
 Lectures on bee-keeping, 102
 Lincolnshire notes, 113
 Labarraque's solution, 199
 Legal right to bees that have swarmed, 303
 Lessons of experience in bee-keeping, 309
 Let-alone system, The, 318
 Lady's bee-keeping, A, 341
 Late, mating of queens, 492; feeding, 498; drones, 516; syrup feeding, 519
 Law of bees, 542
 Lecturers and their critics, 552
 Lecture on bees and bee-keeping, 589
- Moth larvae in top bars, 23
 Moving bees, 34, 131, 189, 213, 457, 519; short distances, 23; in winter, 32; sixty miles, 364
 Mice, 34
 Making soft bee-candy, 51
 Meadows' new registered frame, 88, 155
 Mounting objects for the microscope, 91, 143, 153, 170, 182, 195, 206
 Metal ends, 153, 167
 Mounting in aqueous media, 182
 Mel sapit omnia, 187
 Muscles, 206
 Monthly combs, 234
 Malagasy bee, The (apis nicolor), 250, 259, 268, 279
 Marriage, of Mr. James Abbott, 256; of the Rev. Dr. Bartrum, 393
 Melting combs for wax, 283
 Making a swarm cluster and stay upon a stake in front of its hive, 332; beeswax, 45
 Metal screw tops, 353
 Methglin, 394, 419
 Marauding bees at sweet stalls, 397
 McNally, Ebenezer, 434
 Maltse honey, 482
 Memos. by a Cheshire Bee-keeper, 503
 Mead-making and wax-extracting, 517
 My average yield, 554
 Moist sugar for wintering on, 564
 My honey report, 558
- Natural aptitude for bee-keeping, 2
 Nomadic, bee-keeping and Monte Rosa honey, 8
 National honey competition, 79, 258
 Naphthalised bee-candy, 67
 Naphthol, 91, 255; for foul brood, 68
 Native bees v. foreigners, 154
 Naphthaline and foul brood, 291; and asthma, 545, 553
 New section box, The, 312, 320
 Nil desperandum, 341
 Novel bee-arrangement, A, 343

Native bees in India, 350
 New hive, A, 351
 Naphthol Beta and Naphthaline, 401
 New, heather honey press, 402; wax extractor, A, 419; twin dovetail hive, 453
 Norfolk bee-keepers, To, 431
 Notices to correspondents, 24, 36, 48, 60, 72, 84, 96, 107, 119, 131, 144, 156, 168, 180, 191, 203, 214, 224, 234, 244, 254, 263, 274, 284, 293, 303, 314, 323, 333, 343, 353, 364, 375, 387, 398, 411, 423, 434, 446, 459, 471, 483, 495, 507, 519, 531, 543, 555, 567, 579, 591
 Notes, by the way, 18, 34, 44, 55, 65, 78, 94, 104, 115, 128, 142, 151, 175, 185, 200, 242, 223, 232, 247, 271, 290, 310, 327, 359, 381, 405, 429, 442, 475, 503, 528, 552, 560, 574, 595; 'by village bee-keeper, 41; on wintering, 117; on bee-keeping, 165, 489; from Ireland, 249; on bee-keeping in Hunts, 257, 382; in the country, 269; from North Yorks, 383; from North Kent, 418; from South Devon, 454; from North Devon, 490; on robbing, 492; from my diary, 516
 Nominal one-pound bottles, 542, 553, 575
 Notes for winter management, 545
 Not a bad result, 553

OUR PROMINENT BEE-KEEPERS:—John H. Howard, 13; John Love, 37; Pastor Paul Schönfeld, 61; Rev. J. Lawson Sisson, 85; Miss Macdonell of Glengarry, 122; Richard Atkins Grimshaw, 157; J. Denner, 557
 Our library table, 11, 26, 572
 Odd thoughts, 177
 Overdosing, with salicylic acid, 201; bees with naphthaline, 280
 Ovary of queen, 207
 On, the loss of heat in hives, 216; the way to the moors, 362
 Old railway carriage for a bee-house, 433
 Overstocking bee districts, 513
OBITUARY:—Alfred Neighbour, 1; Rev. J. M'Neene, 69; John McDowall, 69; J. M. McPhedran, 258, 285; C. C. Piffold, 512
 Observations by an outsider, 541
 Our nineteenth volume, end of, 592

Protection from stings, 4
 Preventing, swarming, 22, 368, 432; granulation of honey, 492
 Photographs, of apiaries, 95; of honey displays, 363
 Proposed Scottish Bee-keeper's Association, 113
 Painting, hives, 118, 178, 321; insides of hives, 70
 Proposed conference of bee-keepers at the Royal Show, 151
 Preparing bee-food, 154, 414
 Process for detecting paraffin in beeswax, A, 163

Preventive measures against disease, 169
 Pure cane-sugars for bee-food, 194, 205
 Prospects of the season, The, 288
 Perils of bee-keeping, The, 322
 Preserving sections, 333; store combs, 497
 Preventives against foul brood, 346
 Punic bees, 390, 408, 434, 445; and golden Carniolans, 392
 Poisonous honey plants, 455
 Patent hives, 459
 Prevention of swarming, important to all, 478
 Prizes at the Dairy Show, 488
POETRY:—In an old garden, 179; to 'X-Tractor,' 250; The bees, 333; Natural history from the classics, 446; Stung, 482; The swarm that deserted its hive, 543
 Perforated zinc, 553
 Preserving old combs for melting, 576

Queries and Replies, 22, 34, 47, 59, 69, 82, 95, 106, 118, 130, 143, 154, 167, 178, 189, 201, 213, 224, 234, 243, 251, 261, 273, 283, 292, 303, 312, 320, 330, 342, 352, 362, 371, 384, 395, 409, 420, 433, 444, 456, 480, 494, 504, 517, 529, 543, 555, 564, 576, 588
 Queen, rearing, 81, 105; injured, 273; rearing in full colonies without first removing the brood, 273; catcher and holder, A, 464
 Queens, and excluderzinc, 118, 259; passing through excluder zinc, 176; failing to mate, 342; from foul-broody stocks, 462; fertilised in full colonies with a laying queen, 596
 Quieting bees, 3
 Queen-excluding boards, 558
 Queen-excluders, Size of, 573

Reviews, 11, 24, 47, 190, 253, 261
 Royal show at Doncaster, 40, 206
 Review of, German Bee Journals, 47, 589; of the Bee Journals of Germany and Austria, 322, 589; of French and Belgian Bee-papers, 493
 Royal show prize schedule, 57
 Restless bees, 59
 Raw sugar syrup and dysentery, 59
 Removing, bees, 82; glass supers, 321; surplus, 345; supers, 364; propolis, 444; bees from a hive roof, 495
 Returning, second swarms, 118; swarms, 375
 Report of recent researches, &c., 190
 Re-queening hives, 330, 353, 354
 Robbing, 345, 366; the brood nest, 461
 Remedies for and prevention against foul brood, 366
 Renewing combs in brood nest, 447
 Ripening honey, 451
 Resin cerate or basilicon ointment, 483
 Roofs blown off, 483
 Recipes, Standard, 545
 Re-queening for stopping robbing, 545

Repairing damage from storms, 569

Snows:—Bath and West of England, 229, 265; Royal Agricultural Society, 295, 306; Scottish B.K.A. at Stirling, 317, 348, 356; Hants and Isle of Wight, 336; Nottingham, 337, 367; Lincolnshire, 346; Leicestershire, 347; Yorkshire, 356; Northampton, 357; Berwick, 357; Bristol and District, 358; Ulster, 358; Irish, 358; Wigtonshire, 359, 428; Glamorganshire, 368; Buckingham and District, 368; Shropshire, 377; Wilts, 378; Goole and District, 379; Etwell (Derby), 379; Staffordshire, 390; Wotton-under-Edge, 402; Oxfordshire, 403; Lancashire and Cheshire, 414, 427; Castle Douglas, 415; Wrockwadiene Bee Club, 416; Bridgewater, 427; Hereford, 428; Edinburgh, 429; Derbyshire B.K.A., 452
 Seasonably appreciative, 11
 Sections in frames, 33
 Selling honey, 34
 Spring, management, 45, 47; dwindling, 50; overhauling, 50; report, 104; work, 109; flowers, wax extracting, &c., 188; wasps, 214
 Stimulating, or building up, 49, 255
 Spreading brood, 51
 Sudden death of an Irish bee-keeper, 69
 Specific gravity and melting point of beeswax, 69
 Securing well-filled sections, 81; frames for travelling, 144
 Syrup from raw sugar, 82; for spring feeding, 244
 Single, or double-walled hives, 15, 63, 91, 95, 143; egg in comb, 420
 Single-walled hives, Thin, 152, 164, 187
 Suspected foul brood, 95
 Sawdust for pollen, 117
 Sugars for bee-food, 118
 Shallow frames for extracting, 155
 Size, of standard frames, 155; of the Laysen and Dadant frames, 213; of hives for the North, 248
 Super-clearers, 188, 305, 343, 360, 361, 365, 395, 443
 Sting, 206, 208, prevention, 283
 Salivary glands, 206
 Section, cutting, 207; folding, 222; cases or wrappers, 329; boxes, 481
 Sending queens by post, 215
 Swarming, 235, 250; in Scotland, 301; and its anomalies, 312
 Supering, 235, 305
 Sweetness and light, 242
 Size of hive for the North, 248
 Self-hivers, 271, 287, 290
 Salted syrup for bee-paralysis, 280
 Swarms, 287, 305; returning, 313; taking possession of empty hives, 323
 Separating, queen from bees and brood, 293; queen from brood, 341
 Swarm inside a hobby-horse, A, 319

Swarm-catchers and bee-veils, 407
 Should bees be transferred from skeps in July, 320
 Surplus honey, 325; queens, 389
 Sad lightning fatality at a bee show, 336
 Second swarms supposed queenless, 363
 Sticking to old notions, 374
 Straining honey, 387
 Season's experience, The, 406
 Special query (disqualifying exhibits), 454, 467
 Storing away stock combs, 461
 Space below combs, 462
 Successful producer, The, 463
 Shakespear on bees, 495, 507, 519, 598
 Stocks queenless, 505
 Smacking, 517
 Season, The, at Easter Ross, 370; in Stratbaty, Perthshire, 394; in Mid-Cornwall, 444; in Switzerland, 469
 Standard recipes, 545
 Spores of foul brood in foundation, 550
 Skep bee-keeping, 563
 Sections, Getting bees into, 564
 Surplus chamber, Size of excluder for, 573
 Surplus chambers, Leaving on, 576
 Skeps, Frame hives versus, 575
 Shallow frames, Cleaning up, 576
 Superseding old queens, 579
 Seasonable, 581
 Sad accident to a bee-keeper, 581
 Shallow frames for extracted honey, 583, 588
 Syrup, Utilising surplus, 588

To, correspondents, 40; our Scottish readers, 87; Cambridgeshire bee-keepers, 131; 'Extractor,' 250
 Transferring bees, 96; to clean hives indoors, 253; bees and combs from old skeps, 375; from skeps to frame hives, 385; bees to frame hive in Autumn, 434
 Thin single-walled hives, 103; 126; 164; laths for quilts, 326
 Trade catalogues received, 119, 179, 202; 292
 Trachea, 206
 Tongue and mouth-parts, 208
 The prospects of the season, 289
 Timely help, 301, 333
 Truant swarm recovered, 310
 Taking bees to the heather, 391
 Talk about bees, A, 466
 Tipping bees as burglars, 518
 Technical education in bee-keeping, 551
 Things I have noted, 566
 Tunisian bees, 570
 Transferring bees to frame hives, 576
 The future of bee-keeping, 585

Useful Hints, 15, 39, 63, 76, 86, 109, 123, 145, 169, 193, 215, 235, 255, 287, 305, 325, 345, 365, 389, 413, 437, 461, 497, 545, 569

- Uncleanness is disease, 80
 Using, combed sections, 243;
 naphthaline, 253, 457;
 queen-excluder, 255; car-
 bolised sheets, 321
 Utilising, driven bees, 342,
 420; weak colonies in the
 spring, 374; surplus syrup,
 588
 Unnecessary stimulating, 386
 Unting, stocks in autumn,
 456; bees, 505; An experi-
 ence of, 561
- Virgin, queens, 64; swarms,
 371
 Vagabond swarm, A, 154
 Vaseline, 193, 215, 221; for
 use in hives, 211, 231; a
 sting-preventer, 248; and
 bees, 248; in hive, 252
 Vagaries of bees, 254; of a
 swarm of bees, 308; of
 swarms, 313
 Visit of the B.B.K.A. to
 Wake's Colne Rectory,
 Essex, 302
 Varieties of heather, 352
 Vicious bees, 353
 Ventilation, &c., 462
 Vaseline for stopping rob-
 bing, 515
- Weather, The, 11, 15, 39, 63,
 86, 109, 145, 169, 193, 215,
 235, 255, 287, 305, 325, 345,
 365, 389, 413, 437, 461, 497;
 report for 1890, 21; reports,
 69, 82, 84, 131, 178, 189, 233,
 256, 273, 308, 363, 405, 433,
 455, 481, 509, 513
 Warning, A, 21
 Wax extracting, 22, 69, 154,
 361; furniture finish, 84;
 polish, 84
- Wintering bees, 25, 153, 175;
 318; report, 68, 95; on
 natural stores, 117; bees in
 North Scotland, 139; bees
 in collars, 232; in skep,
 421; a small swarm, 480;
 bees in outhouses, 596
 Width of top bar in frames
 for extracting, 45
 Working for extracted honey,
 97
 Willesden card for hive roofs,
 152
 Water for bees, 221
 When doctors and professors
 differ, 239
 Webster's carbolic fumigator,
 244
- Why, bees fight among them-
 selves, 271; do we smoke,
 417
 Wood laths for quilts, 323
 Wild bees, 330
- Wilful destruction of bees,
 355, 462
 Wearing bee-veils, 383
 Wildman on bees, 469, 477
 Winter passages, 495
 World's fair of 1893, 533
 Winter treatment of foul-
 broody hives, 555
 Wintering bees in outhouses,
 564, 587; Moist sugar for,
 584
 Weather reports, 565
 Wax secretion, 567, 577
 Weather, 569
 Width of entrance during
 winter, 576
 Which hives swarms come
 from, 584
- Year's experience of bees, A,
 152
 Ye experience of ye Spread
 Eagle, 222

ILLUSTRATIONS.

- Hauling frames of bees, 5
 Bee, veil, 5; houses, 140, 141,
 178; rambles in Savoy, 161,
 172, 178, 219, 230
 Feeders, 26
 Ekes, 27
 Bottom boards, 27
- Body-boxes, 27
 Quilt adjusters, 23
 Bacillus, 62
 Stomach mouth, 62
 Packing, sections of honey,
 74; run honey, 75
 Uncapping combs, 29
- Braula cœca, 144
 Excluder zinc, 176
 Queen-box (for sending queens
 by post), 215
 On the loss of heat in hives,
 217
 Section folding, 222
- Bees and orchids, 245, 246
 Comb-honey production, 275
 to 278
 Queen-cage, 329
 New, hive, A, 351; heather
 honey press, 402
 Rack for store comb, 498

PORTRAITS.

Alfred Neighbour, 1
 John H. Howard, 13
 John Love, 37

Pastor Paul Schönfeld, 61
 Rev. J. Lawson Sisson, 85

Richard Atkinson Grimshaw, 157
 J. Dennler, 557

THE British Bee Journal,

BEE-KEEPERS' RECORD AND ADVISER.

No. 445. Vol. XIX. N.S. 53.]

JANUARY 1, 1891.

[Published Weekly.

Editorial, Notices, &c.

THE LATE

MR. ALFRED NEIGHBOUR.

Just a year ago we had to record the death of a well-known bee-keeper, and now it is our painful task to make known to our readers the loss of another widely known and greatly respected bee-keeper and appliance manufacturer, whose name has been associated with bee-keeping for more than half a century. Mr. Alfred Neighbour, who passed away on the 19th of December, was born in High Holborn, London, on the 24th October, 1825, and was therefore sixty-five years of age. He was the son of Mr. George Neighbour, and a partner in the firm of George Neighbour & Sons. His father established the business in Holborn about 1814, and in 1852 the firm acquired business premises at 149 Regent Street, possession of which was retained till recently, when they were required for Government purposes. In 1824 Mr. Thomas Nutt, the inventor of the Collateral hive, offered Mr. G. Neighbour the agency for the sale of his appliances, and in 1827 published the first edition of his work, *Humanity to Bees*. He was in the habit of periodically visiting his patrons who resided in the neighbourhood of London, and Mr. Alfred Neighbour frequently accompanied him in these excursions, and wit-

nessed his fearless manner in manipulating with bees. These were practical lessons that young Mr. Neighbour derived much benefit from, and thus in early life he acquired a taste for bee-keeping. Mr. Neighbour for many years kept a public apiary in the Zoological Gardens, Regent's Park, principally in Nutt's hives, but later on Observatory hives were substituted, as being more attractive to visitors. The Royal princes and princesses when children were accustomed to pay frequent early morning visits to the gardens, and also gave the bee-house its share of attention. On one of these occasions Mr. Neighbour happened to be at the apiary, and had the honour of pointing out the queen, and explaining the mode of working the hives.

The first opportunity of making a display of hives was at the Great Exhibition of 1851, when Messrs. Neighbour and Mr. John Milton exhibited living bees in glass hives and a collection of bee-furniture side by side. In those days the movable comb hives constructed in England were those of Dr. Bevan, Mr. Golding, and Mr.

H. Taylor; but these had top bars only and the combs had to be severed from the sides of the hives whenever required to be drawn out and inspected. The success of this exhibition caused other exhibitions to follow, and Mr. Neighbour was a regular attendant at these, and was usually seen superintending the arrangements.

Mr. Neighbour was very closely acquainted with Mr. Henry Taylor, author of the *Bee-*

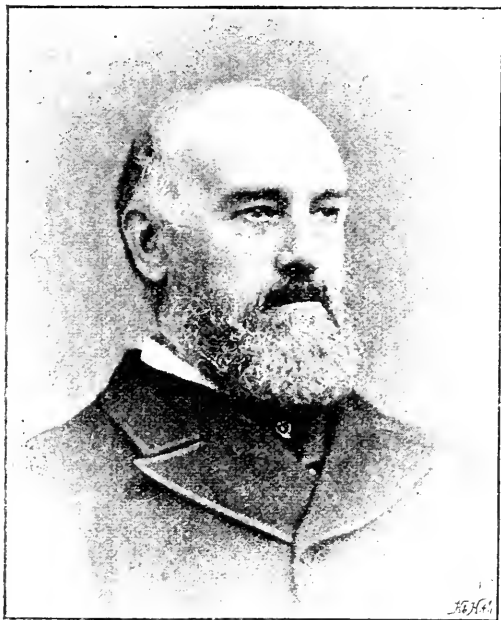

ALFRED NEIGHBOUR.

keeper's Manual, who was frequently a guest of Mr. George Neighbour at Dorking, whither the latter gentleman retired when he was released from business. Mr. Taylor persuaded Mr. Neighbour to apply to Mr. Hermann in Switzerland for a Ligurian queen-bee, as he had offered to send one to Mr. Woodbury—an offer that gentleman availed himself of. The two queens arrived simultaneously. This was the commencement of a new era in bee-keeping, and with the introduction of Ligurians into this country, there sprang up an acquaintance between Mr. Woodbury and Mr. Neighbour, which continued till the death of the former in July, 1870.

Soon after the introduction of the Ligurian bee, Mr. Langstroth published his work *The Hive and Honey Bee*, describing his invention of hives with frames, and at the same time frame hives were brought to the notice of bee-keepers in Germany by Baron von Berlepsch. Mr. Woodbury, grasping the advantages of his idea, soon adapted the combs of his bar hives to it, and constructed what he called the 'compound frame.' Messrs. Neighbour were the first vendors of the Woodbury hives, and resorted to frames as originally planned, and which have been in use ever since.

Mr. Neighbour was engaged, with the aid of Mr. Duncan Keir, who was introduced to him by 'The Renfrewshire Bee-keeper,' in packing and forwarding humble-bees to New Zealand during winter in a torpid state, for the purpose of fructifying red clover.

The importation of Cyprian, Syrian, and Holy Land bees also claimed much of Mr. Neighbour's attention, and he was the first to introduce Carniolan bees into this country.

At the German Department of the Exhibition of 1851, Mr. Neighbour purchased the improved metal plates for making wax foundation, and it was with these that the foundation we used when we first commenced bee-keeping was made—a very different article to what is now used.

Mr. Neighbour enjoyed unusual opportunities of becoming acquainted with the leading apian celebrities of the day: amongst others, Rev. William Charles Cotton and Dr. Coster.

In 1880 Mr. Neighbour attended, in company with Mr. S. Stutterd, the translator of Dzierzon's book, the German meeting of bee-masters at Cologne, and received the State silver medal. Here he was introduced to most of the leading bee-keepers attending the Congress, which included Dzierzon, Vogel, Baroness von Berlepsch, Dr. Pollman, and many others.

Mr. Neighbour kept bees for some time at Dorking, but 'foul brood' broke out there, and a convenient plot of ground offering at West End, Hampstead, he began afresh in London. Over twelve years' residence at Hampstead was brought to a close in consequence of the ground being required for building purposes, so he removed to Buncefield, Hemel Hempstead, where the apiary is now situated.

Mr. Neighbour was a member of the B.B.K.A. from the commencement, and also a member of

several of the County Associations. At most of the exhibitions he received prizes, medals, or certificates, and all goods turned out by his firm were of a high class as regards manufacture.

Mr. Neighbour was the oldest established hive manufacturer in the kingdom, being in the business long before the *British Bee Journal* was thought of. He was also the author of a work on bees, entitled *The Apiary; or, Bees, Bee Hives, and Bee Culture*, which has passed through three editions. He also had a very extensive library of books on bees and bee-culture, many of them being of great age and very rare. He was extremely affable, and always ready to assist any one in bee-keeping. His strict integrity caused him to be trusted by all who had the pleasure of knowing him. He had been suffering for some time from rheumatic gout, and had been to Aix-les-Bains for the baths, where we heard about him when we visited the place. However the disease was too deep-rooted to give way to this treatment, and, although he returned better, it was not long before he was again laid up, and after being confined to his bed for six weeks, he passed away on the 19th of December, 1890. He was married in February, 1885, to Mrs. Johnson Bromley, who survives him, and with whom we deeply sympathise in the loss sustained by all who knew him.

BEE-PAPERS FOR WINTER READING.

No. 1.—HANDLING BEES.

NATURAL APTITUDE FOR BEE-KEEPING.—In the whole range of the practice of apiculture there is no one feature of such paramount importance in attaining success as that of knowing how to handle bees properly, and judiciously, and well. Indeed, to the man who is by temperament and habit hasty, jerky, and rough in his method of doing things—who bangs about him in 'now then, hurry up' style—who emphatically says, *Don't keep bees*. Such a one will never make a successful bee-keeper, but will only go from bad to worse in his 'hardling' if he makes the attempt, and assuredly end in giving up in disappointment and disgust. It is most curious to note the varying feelings with which different men regard bees: we have seen a military officer—a model soldier in physique, and, as we were told, plucky enough to face anything in the shape of man or beast—so nervously afraid of the stings of bees that he could not be induced to look on at the opening of a hive, though offered a bee-veil and gloves for protection. Again, we have enjoyed a good laugh at a big farm labourer, about six feet high, running away along the road a couple of hundred yards because he fancied a bee was after him. In these cases an innate fear of bees would very properly deter either man from attempting to become a bee-keeper.

Then there is a class of unpromising candidates for success in the pursuit who possess

no natural aptitude at all for it, and who should never attempt to engage in it. One of these well accounted for his failure when he remarked to us: 'My bees were awfully savage the other day; but Jack was as good as his master, and I gave it them *hot!*' And very 'hot' indeed had he given it them, for on lifting the quilts the number of dead bees we saw lying with their crushed bodies flattened on the top bars fully attested the warmth of his 'handling.'

On the other hand, any man or woman possessed of an ordinary amount of gentleness, patience, and firmness, and having no actual *distaste* for the work, may become skilful in handling bees, as well as a successful bee-keeper, by intelligently applying the knowledge which is nowadays within the reach of all. Courage, in the ordinary sense of the word, is not needed, only just that small amount of nerve which will save the operator from starting, as if shot, or dropping the frame he happens to be holding, should a misguided bee chance to sting him. Some men are more successful than others in handling bees, because of their natural aptitude and liking for the work; but almost any one may by experience and practice gain sufficient control over their bees and themselves to remove the unpleasantness and annoyance which, in nineteen cases out of twenty, is caused either by want of knowledge or by mismanagement.

It is just as necessary that the bee-keeper should know when to leave the bees alone, as it is to do the right thing at the right time; and he who persists in carrying through operations at the wrong time, and while the bees determinedly resent it, not only acts unwisely, but lays the foundation of further trouble. Gentle handling at all times, and judicious waiting for 'another chance' to carry out operations if the bees are disposed to be 'awkward,' will have a remarkable effect in preserving the bee-master's control of the apiary, and in maintaining that order therein which is so necessary for comfort and for success.

QUIETING BEES.—Without an efficient means of quieting or controlling the vast army of little workers under his charge the bee-keeper's occupation would be gone, or at least it would become impossible so far as management by modern methods is understood. And so, for the purpose of subduing bees and rendering them amenable to control, one of two agents is used, as preferred, viz., smoke from burning or smouldering rags, &c., or the fumes of carbolic acid, the latter being administered in several forms, while the former is universally applied by means of the 'Bee-smoker,' an implement too well known to need description here.

But for the fact that carbolic acid, as used for quieting bees, is so useful in quite another direction, viz., as a disinfectant and preventive against disease, we should advise the using of no other implement than the ordinary smoker and smouldering rag for manipulating purposes, for, spite of all that is urged in favour of the fumes of carbolic acid or of creosote, we must confess

to an all-round preference for a good smoker and a bit of dry fustian. Bearing in mind, however, the favour with which some regard the use of carbolic acid, and appreciating its value as a disinfectant, we give particulars of the three distinct methods of using it for bee-purposes, as advocated by the late Rev. George Raynor, Mr. W. B. Webster, and Mr. John H. Howard respectively. Mr. Raynor for more than twenty years dispensed with smoke and smokers, using instead a solution composed as follows:—

1½ oz. Calvert's No. 5 carbolic acid,
1½ oz. glycerine,
1 quart of warm water.

The acid and glycerine to be well mixed before adding the water, and the bottle to be well shaken before using.

Formerly Mr. Raynor applied the solution by means of a feather, first round the entrance and over the alighting-board of the hive, then to the tops of the frames, smearing each top bar as the quilts were removed. In later years, however, he seemed to prefer his second plan of using the carbolised sheet, which was simply a piece of open cheese-cloth, seventeen inches wide, and long enough, when it had tacked on to it at each end a light wooden roller, to hang over the hive sides when stretched across the whole of the frame tops. This cloth, when in use, was kept moist with the acid solution, and when manipulating the quilts were quickly stripped off and replaced by the cloth before the bees had time to fly. They would immediately retreat below, and then the operator gently rolled back the cloth, uncovering as many frames as desired on one side, then covering up again and beginning on the opposite side in the same way. Considering that so reliable an authority as Mr. Raynor chiefly attributed his immunity from foul brood for more than forty years to the constant use of carbolic acid in this way, its advantages are worth considering. Great care, however, is required in using it, not only on account of its highly poisonous character, but from the painful effect it has on the skin if the solution is made too strong, or without glycerine, besides the objectionable odour it conveys to honey if used carelessly. The quiet style of handling bees and the orderly care so characteristic of Mr. Raynor were admirably adapted for the successful use of carbolic acid about bees and honey. His carbolised sheet, neatly rolled up in a piece of American cloth, glazed side in, was always ready for use and never objectionable; nor was his honey ever 'redolent of carbolic,' as often is that of some who use that useful but not savoury-smelling antiseptic too freely in the apiary.

Next we have the carbolic fumigator of Mr. Webster, who describes it as follows:—'This is a zinc cylinder mounted upon, and in direct communication with, a bellows. At one end of this cylinder is an inverted cone, from the lowest part of which a nozzle protrudes: covering over the hole at the back of this nozzle is a shield, to prevent anything but air or vapour being blown through; the other end of this

cylinder has a cover, the inside of which is furnished with four hooks holding a piece of sponge. The sponge is saturated with carbolic acid, creosote, and water. At the back of this sponge a piece of carbonate (the common hard or crystal form) of ammonia is placed; when so prepared the fumigator is ready for use, and will last, according to the amount of work, for weeks or months, without any further trouble.

The fumigator is used exactly in the same manner as an ordinary smoker, and those desirous of trying the carbolic fumigation method may, according to Mr. Cheshire, improvise a good substitute for the orthodox implement by forming a roll of the corrugated brown paper used for packing purposes, saturating this in the solution and inserting it in an ordinary smoker.

Next we have the 'carbolicised spray,' first used by Mr. Howard to quiet bees. This consists of one part (not more) of Calvert's No. 5 acid to ten parts of rather hot water, the solution to be shaken till the brown, oily globules disappear, and the acid is thoroughly merged in the water. It is used warm, and before spraying the bees the bottle is again well shaken. A strong atomiser, like those used by hairdressers, is best for the purpose when spraying; the nozzle should not be pointed at the bees, but directed so that the solution will fall on them in a fine spray as the quilt is turned back. Sometimes a second application is needed to subdue a strong stock, but the bees generally retreat from the spray just as they do from smoke. Judiciously applied—and only in spring and autumn work—this spraying with carbolic acid must be of great value if foul brood is about, seeing that in application it disinfects hives, bees, implements, clothing, and everything it comes in contact with. There is, of course, always the danger of a careless person making the solution too strong, or so drenching the bees with it as to half kill them; otherwise the carbolicised spray has much to recommend it, especially when disease is being fought with, but as a bee-quieter it is obviously more suitable for the use of experienced bee-keepers than for the ordinary amateur.

Beyond those enumerated above, there are several other quieting agents used for protecting the hands when handling bees, notably Grimshaw's 'apifuge,' Shipman's 'pirasodo,' &c., which have the excellent effect of giving that confidence so helpful to the timid beginner.

PROTECTION FROM STINGS.—We cannot entirely agree with the oft-repeated assertion that 'bees will never volunteer an attack, nor sting 'except in self-defence.' Neither is it quite correct to say that 'after a little practice and experience no protection is required;' indeed, it will usually be found that in apiaries of any extent, where the bees are 'natives,' and possessing the 'grit' and the healthy vigour requisite to make good returns possible, there is not that complete immunity from the risk of an occasional sting which some would have us believe. As a matter of fact, in all our acquaintance with successful bee-men, we never yet found one who hadn't a veil somewhere in

the house, and who didn't wear it at one time or another. Personally, we almost invariably have our veil on when working among bees, not always pulled down over the face, but ready on the hat for instant use on an emergency. It lessens the risk to have it so, and a sting in the eye is at no time agreeable.

On the other hand, there is no bee-keeper who does not fall considerably in our estimation (as a bee-keeper) when we drop in unexpectedly on a hot day and find him among the bees, topcoated, tightly muffled up, with bee-veil tied on 'to stay,' long stockings drawn over his hands and arms, gloves over them, trousers tied inside his socks: in fact, rendered hot and perfectly wretched with the defensive precautions taken against being stung. In such a costume he takes no care in handling his bees. They cannot get at him, and he 'gets at them' instead, and gets on badly in consequence. This is the other extreme, and extremes are to be avoided in bee-keeping as in everything else. It is perfectly true that many become so conversant with the ways of bees, and so fully aware of how to avoid their stings, that it gives rise to the idea, in the minds of inexperienced persons, that some men possess a special power over bees quite unattainable by others; while, as a matter of fact, the 'power' arises from the simple knowledge of certain peculiarities in the character and temper of the insect, which may be acquired by any one. A personal experience of our own may serve to convey a lesson while illustrating this. A few years ago we consented to do some manipulating in the apiary of a gentleman very enthusiastic over his bees, but not very conversant with their ways. Quite a company had been invited to be present, and when we arrived our friend hastened to explain that he had inadvertently left a recently emptied honey cask right in front of the hives, to be cleared by the bees of the honey left on the sides of the tub; and, said he very apologetically, 'The tub is full of bees; whatever shall we do to get rid of them before beginning operations?' 'Clear them out,' was our reply: and, without using either veil or smoker, we at once seized the tub with both hands and banged it from one side to another, till the poor bees, gorged and frightened, and, as any bee-man would know, harmless as flies, arose in a perfect cloud about our head, and scampered off to their respective hives in thousands. The onlookers were, of course, amazed, but we knew that any among those who gazed, wondering at the 'power' displayed, could have done the same thing themselves. Under the peculiar conditions existing at the time the bees were perfectly harmless, and the idea of stinging the rude disturber of their feast would never enter their little heads—or tails either, for that matter. Knowledge first, confidence afterwards, are the main points in handling bees, and those possessing any aptitude at all for the work may soon acquire these; but it is just as important to know when and under what circumstances it may be risky, if not a little

dangerous, to take liberties with bees as it is to know when they may be handled roughly with impunity. In any case analogous to the one described above, it is only necessary to bear in mind the fact that bees, when carrying off food they have had no hand in storing, or when appropriating honey belonging to their neighbours, *i.e.*, 'robbing,' will stand any amount of rough driving off without resenting it. Wives of bee-keepers especially should remember that a roomful of bees which have found their way into the 'honey-room' of the house, as sometimes happens in harvest-time, may be driven out by a child without it receiving a sting. The beginner must first wear a bee-veil and gloves. The latter may be such as are sold by dealers, *i.e.*, a pair of thick woollen ones, with a second pair of thin cotton to slip over these. If the hands thus gloved are dipped occasionally in water and vinegar while working, bees will seldom attempt to sting. Rough, home-made gloves of American cloth, made with the glazed side out, are also a good protection for the hands. Thick woollen ones, covered on the outside with silk, say the cover of an old umbrella, also answer capitally during the elementary stage of the learner's experience. But gloves of any kind should be discarded at the earliest day when confidence is gained, and once cast aside, they will rarely be resumed. Their place should then be taken by a pair of 'sleevelets,' made from strong black 'silesia,' such as is used by tailors for the backs of vests. The form and size will be seen at once in the cut (Fig. 1). No further

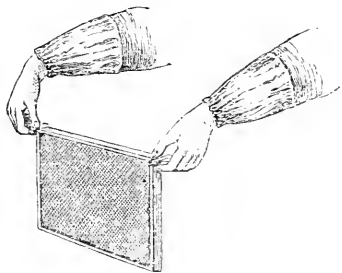

Fig. 1.

description is needed beyond saying they are about nine inches long, and wide enough to slip easily over the coat-sleeve, with a band of elastic run into the hem at the bottom, and a rather longer band of the same material in the top edge. These keep the coat clean and prevent the possibility of bees getting up the arm or being crushed while on the wrists by the coat-sleeves. We much prefer them to the usual elastic band passed round the sleeve at the wrist.

These sleevelets and a veil are all the protection necessary for any and every operation required in bee-keeping. For the veil get a good one, take care of it, and it will last ten years or more. The best material for the purpose is fine black silk net; next to this, and less expensive, of course, is fine Brussels net.

These materials, though not so cheap as the ordinary coarse net or leno, are so much preferable to the latter, and withal so light and pleasant to wear, while hardly obstructing the vision at all, that any *careful* bee-keeper may invest in a veil of the right sort, though its cost is more than double that of a common one, for the material is so durable that it becomes cheap in the end. Our own veil weighs less than half an ounce, and may be carried unnoticed in the waistcoat pocket. Use no colour but black, and let it be simply a bag without covering top or bottom, about half a yard across and eighteen inches deep. Into a hem at the top edge insert a band of light elastic to slip over the hat. Notwithstanding the almost invariable advice given to have the lower side of the veil open for slipping beneath the coat collar, we much prefer to have a long piece of elastic (a narrow tape will answer, but not quite so well) run in the lower edge of the veil, not tight enough of itself to draw the veil close round the throat, but loose, so as to require pulling out in front while the veil is pressed back close to the throat with the hand. Worn so the veil hangs loose and clear of the face, while it is held close round the neck, as in the cut (Fig. 2).



Fig. 2.

It is safer, cooler, and pleasanter to wear thus than when the lower side requires tucking in beneath the coat in the ordinary way.

HANDLING BEES.—It is a well-known truism that if bees had no stings we should soon have no bees, and the fact that these little weapons are always 'about' and ready for use is never lost sight of by the experienced bee-keeper. It trains him in ways of gentleness while handling his bees, and they show their appreciation of his method as surely as they will emphatically resent the rough usage of an unskilful operator. The learner must also bear in mind that there are times when outside influences—such as the weather, season, &c.—have so great an effect on the temper of bees that operations which may be carried through in comfort and without disturbance at one time, may, if persisted in at another, cause an upset in the apiary and be troublesome to a degree.

We may indicate in a general way how this peculiarity should be met, but experience and watchfulness are the best teachers. Besides, we shall have occasion to refer to this variation in temper among bees in future papers, when

treating of special operations, and why our bees are more amenable to handling at one time than at another; but, broadly speaking, it may be stated that when honey is being gathered freely in spring they are rarely troublesome, while on some hot days in summer (at times even though honey may be plentiful) they are quite jealous of interference and resent it strongly. Again, in autumn, when surplus honey is being removed, some days it can be done as easily as lifting a roof off, and on others, especially when all the bees are indoors and no work to do, they will not yield up their stores without a very forcible protest. On these occasions, if convenient, don't persist; defer the job till another day, when the bees may be as quiet as need be. With these few general observations we pass on to the actual work of opening hives and handling bees.

The different way in which an inexperienced bee-keeper proceeds in his first attempts at manipulating when contrasted with the method of an old hand at the work is of course very marked; but it is a hopeful sign when we see him sufficiently cautious and deliberate in his movements while betraying no nervous dread of the insect. Assuming that the ordinary smoker and smouldering fuel of some sort is used for quieting the bees, the first thing is to see that both smoker and fuel are in order—the former clean and the latter quite dry. Make a loose roll almost thick enough to fill the tin cylinder of the smoker, and, after igniting, thrust the burning end in, adjust the nozzle, and work the bellows rapidly till a good volume of smoke issues. Set the smoker down, always with the nozzle pointing upwards, slip on the sleevelets, adjust the veil—see that it is drawn close round the neck—thrust the end of the elastic band, or of the tape, in between the vest-buttons, and you are ready to start work with no fear of taking harm except the trifling risk to the hands. We regard this latter risk as a positive advantage, as having the excellent effect of inducing greater care and caution in handling the frames and bees. If the day is a 'quiet' one, give no smoke at the entrance to the hive before removing the roof. If the bees are a bit spiteful, a couple of puffs as a beginning may be necessary. Then quietly lift off the roof, causing no jar in doing it, and being careful not to kick the legs of the stand as a preliminary: lay the roof, end up, on the ground, and removing all quilts save the one next the frames, deposit them on the roof, and, with the smoker in one hand, with the other gently fold back the quilt, while puffing in a little smoke as the bees become exposed. After uncovering two or three top bars pause a moment to see how the bees are disposed to act, and give no more smoke than is needed to frighten and keep them down; set the smoker down on the folded-back edge of the quilt, and with a small screw-driver (or a common oyster-knife answers admirably) gently loosen the dummy, or whatever is used to gain lateral space, and lift it up right out of the hive. If there are any adhering bees a down-

ward jerk or two will shake them off back into the hive, and when cleared it is set down on the ground. The first frame is then loosened and drawn quietly apart from its neighbours towards the operator, or lifted up for examination as required. In raising frames the 'lugs' or ends of the top bars are held between the fingers as in Fig. 1, and for inspection the frame is lifted to a level with the eyes, while held over the open hive. After examining one side, the comb is turned half round away from the operator; the furthest end of the top bar is then pulled over towards him while lowering the nearest hand, so that the comb is turned over on its edge, the reverse side being inspected while held bottom upwards. The same movements are gone through before returning the frame to the hive, and after a little practice even tender honey-laden combs may be examined, which would assuredly break away from the frame if turned round in any other way than on their edge or base. In lifting and returning frames no crushing of bees either beneath the frame ends or against the hive sides must occur, and while operating an occasional puff of smoke may be needed just to keep the bees quiet. As each frame is examined it is returned to the hive by placing it close against the side next the operator, and when as many have been gone through as necessary they are pushed up *en bloc* into their former position, and the dummy replaced. He only who succeeds in covering all up without killing or crushing a single bee completes the job as it should be done.

This paper has already taken up more space than we intended, so we must leave further information on 'handling' to be gathered later on, and conclude by observing that as 'bees do nothing invariably' it is impossible to work entirely by rule of thumb: but intelligent observation and practice will soon teach the bee-keeper what to do and when and how to do it.

[The above series of Papers will be continued fortnightly.—EDS.]

DEVELOPMENT IN THE HONEY-BEE.

By R. A. H. GRIMSHAW.

(Continued from p. 577.)

Much interest has been aroused by the observations of Darwin, Grant Allen, and others, in the subject of the cross-fertilisation of flowers by insects, and the effect of such cross-fertilisation on the colours of the flowers; indeed, the whole subject is really a history of that development of colour in flowers which has proceeded coterminously with the development of both the flower itself and the insect world, conspicuous amongst the latter being the results of the efforts made by nectar-getting bees of many kinds to maintain and improve their position on the graded ascending and descending ladder they find themselves placed upon by their ancestors; in other words, to live on, struggle for existence, and reproduce

their kind, handing forward to posterity the results of their own life—these newcomers in their turn being better or worse (as the case may be) enabled to maintain their hold on the ladder-rung than were their ancestors, but all, I suppose, being in absolute ignorance of the why and wherefore of their acts. In the case of the honey-bee, it does not know, nor can it care, whether or not it performs for the plant a service (in return for the nectar it takes) so vital and essential that, without it, in many instances the plant would at once cease to produce seed and succumb in the wrestle for room always going on in the vegetable world; in other cases self-fertilisation would be accomplished without insect visitation, and the subjects failing to partake of such benefits as are believed to result from crossing varieties, would not be able in time to hold their own in competition with more successful rivals, and would ultimately be crushed 'out of nature's garden into the barren rock wastes,' where only a mere existence is maintained (the *Equisetum* comes to my mind as a suitable example). In still further instances the plants would in all probability revert from cross-fertilised to wind-fertilised, then to self-fertilised forms, losing their colours and perfumes as the degradation process proceeded. Of course, as I said, the honey-bee knows nothing nor cares anything of all this, nor of the future *status* of her race. It is nothing to the queen whether her eggs result in queens, drones, or workers—she mechanically lays eggs, that is all; nothing to the drone what becomes of his whole fraternity so long as he is successful in his heated noontide flight; the worker cares and knows nothing about the past or future of her home and its contents so long as she, during her own life, can fulfil her own instinct-guided mission of incessant work. But all these things, animal and vegetable, work in wondrous folds of intricate harmonious interchange, weighing and counterbalancing each other in a most admirable warp and weft of woven complications which appear threads of inextricable confusion to the eye of man, yet to the gaze of the Great Weaver the whole comes out of His loom perfect in design, accurate in execution, admirable in completion. He sees that it is good! Still every unit, every living atom in the fabric, is sent forth with the mission to revel in its existence, to live and enjoy life, for itself in the first place, and secondly (if endowed with sufficient intelligence to comprehend the thought), for those of its surrounding kind; higher still, to sacrifice its own pleasure for others; and yet further, to try and obtain some faint inkling, some dim glimmering and glimpse, of the great design of the Grand Artificer. In this desire men of science dive and probe into the unwritten history of the earth's past, analyse and scheme amongst the chemical mysteries of the present, speculate and wonder into the probabilities of the hidden future. Each in some special and favourite walk; the mycologist amongst fungi, the bacteriologist amongst minute germs of life, the

botanist deep in the chemistry of the plant-cell: the astronomer, at the other extreme, seeks to unravel the truth in the immensities of space, whilst (perhaps most insignificant of all) the student of insect life finds his life-pleasure in trying to recognise the threads in nature's garments unwittingly spun by the numberless forms of winged life which come under his notice; amongst these we find our honey-bee.

Let us speculate upon the colours of flowers, since they play such an important part in the life of the bee, by attracting it with their brilliancy to come for the stores of nectar secreted in various parts of the flower. I do not believe there is such a substance as colour; it is simply an effect upon the eye caused by light falling at such an angle upon substances which have such various chemical peculiarities that the ray is refracted and broken up. The particular colour we see is the one rejected and reflected by the cells composing the flower-petal: the other colours are absorbed by the cell-contents, remembering, as we must, that in a white ray of light there is every colour, and that such substances as appear to us black absorb the whole of the colours composing the white ray, whilst white substances reflect them all. If, then, the cells of flower-petals are so arranged side by side, and are so superimposed in layers at various angles, each cell being perfectly transparent, or semi-transparent in degrees until we get almost total opacity, and in these cells the contents are of very varying chemical composition, it is not hard to imagine that the colours of flowers owe their diversity more to chemical matters drawn from the soil into the sap by the roots, than to the commonly supposed causes, such chemical substances being acted upon by sunlight in the presence of a perfect circulation of air in conjunction with the peculiar powers possessed by the plant of perfecting varied characteristic products. Thus in the green parts of plants we find the colour owing to minute grains of chlorophyll floating about in the white cell-sap, this chlorophyll absolutely requiring for its increase both the presence of iron in the sap and of light shining upon it.

(To be continued.)

LECTURE ON THE HONEY-BEE.

At Castlewellan, in County Down, there is a flourishing Literary and Scientific Society, before the members of which Mr. Paul McHenry, hon. secretary of the Ulster Bee-keepers' Association, lately read a paper on the 'Anatomy and Physiology of the Honey-bee.' The meeting was presided over by Clatworthy W. Murland, Esq., J.P., Ardnabannon, and was very well attended by the local gentry and shopkeepers, in addition to the members of the Society. The essayist illustrated the subject with the diagrams published by the British Bee-keepers' Association, and kept his audience thoroughly interested for nearly an hour. So much interest has been stirred up that Mr. McHenry has been asked to

repeat his paper, a number of working men in the Ansbrough Mills being anxious to hear it. It is intended to follow this with an exposition of the practical part of modern bee-keeping, and in Mr. McHenry's hands it is certain to be done well. Bee-keeping with bar-frame hives has received such an impetus in the district that quite a number of bee-keepers purpose starting the pursuit next year, for which the locality is remarkably well suited, lying as it does between a wide stretch of cultivated and pasture land and heather-clad mountains.

Correspondence.

The Editors do not hold themselves responsible for the opinions expressed by correspondents. No notice will be taken of anonymous communications, and correspondents are requested to write on one side of the paper only, and give their real names and addresses, not necessarily for publication, but as a guarantee of good faith. Illustrations should be drawn on separate pieces of paper.

Communications relating to the literary department, reports of Associations, Shows, Meetings, Echoes, Queries, Books for Review, &c., must be addressed only to 'The Editors of the "British Bee Journal," 17 King William Street, Strand, London, W.C.' All business communications relating to Advertisements, &c., must be addressed to Mr. J. HUCKLE, Kings Langley, Herts (see 1st page of Advertisements.)

*** In order to facilitate reference, Correspondents, when speaking of any letter or query previously inserted, will oblige by mentioning the number of the letter, as well as the page on which it appears.*

AN EXPERIMENT IN WINTERING.

[493.] My hives, about thirty in number, are situated in two rows at the north side of a wall some five feet high. The sun shines over the wall on the outer row at midwinter, and on the inner row only till October, and not again till March—that is, not at all during the winter months. I observed the outer row gave the best returns in bees and honey, and to prove the certainty of this, and find out the cause, I tried the following experiment. I placed a dome-shaped skep well provided with bees and stores on a low stand close under the north wall, entrance facing due north, with no protection from that quarter, covered the hive well up with hay, and over this a sheet of zinc weighted down. I also placed a ten-framed, half-inch, single-walled hive in the sunniest place in my outer row, painted it black, entrance facing south-east, and a fence at back protecting it from the north.

The bees in the skep lay dormant all winter. I observed they only once came out in numbers till late spring. When all other stocks were carrying in pollen those were still quiet. At last, on a close, warm day, when all were out for a fly, those came out the strongest, and apparently as numerous as when put into quarters in October. Later on, when inverting the skep into a box, over which I placed a ten-framed hive, which gave fifty pounds extracted honey during the season, I found very little of the winter stores consumed.

Those in the thin single-walled hive, on the other hand, were out every day the sun shone during the winter. I expected a strong case of

spring dwindling—they had been only a single driven lot of bees well fed up—but in place of this they were the first to find out and bring in pollen, the first to show signs of overcrowding; a box of ten frames additional underneath was not too much for a brood nest, and at honey-flow time twenty frames additional overhead were too few for surplus. I took 90 lbs. extracted honey from it in eight days of the memorable three weeks' 1839 honey-flow. A box of ten standard frames taken off on a Monday were full again of sealed honey on the Tuesday week following. Altogether it gave 112 lbs. surplus, with a sufficiency for winter, a good artificial swarm, two nuclei, and four young queens. Again, in the past season this hive, with a new young queen, was in advance of the rest of my hives, giving 25 lbs. extracted, my next best only 10 lbs. The past was a much worse season with us here than 1888.

The lesson to be learned from this experiment is, if desirous of sparing the bees, saving the stores, and economising the brood-producing powers of the queen, place the hive under a north wall and cover up warm, and if anxious to get the best returns from bees put them in a warm, sunny place, in a thin single-walled hive, painted black. There is very little doubt but that the sun's heat has a beneficial effect on bees in winter. Mr. Simmins, in one of his writings, refers to it thus: 'That it enables them to change their place and move to fresh stores in the hive, and there is no doubt whatever that it stimulates both queen and bees in the production and rearing of brood in spring.' The winters of '88 and '89 were very mild, snow but once in '88, none in '89, and very little frost in either. My half-inch walled hive required no extra covering outside. It is very different this winter, and I have a strong idea the bees are the better for the sugar-bag, tarpaulin, and straw around it at present. These come away from the front when the great cold goes, to admit the sun's heat; and the hive I might recommend as being neater and nearly as effective as this thin single-walled is one composed of the $\frac{3}{4}$ -inch inner and outer case of the 'W. B. C.' hive and the $1\frac{1}{2}$ -inch top bar of the 'Cowan,' with metal ends or tin plinth to cover ends of frames. This enables the two cases to close together, and equals a $\frac{3}{4}$ -inch single-walled hive, with many additional advantages. I have several of these now in use, and expect good results from them.—W. B., *Patrickswell, co. Limerick.*

NOMADIC BEE-KEEPING AND MONTE ROSA HONEY.

[494.] In view of the large production and consumption of honey in England, Germany, France, Switzerland, and Austria generally, but especially in the United States of America, both for trade purposes, as well as in connexion with medicine and food, I thought I would try to promote this industry in Valsesia, not only for home use of honey, but also for export abroad.

Returning from abroad in 1867, where I had opportunities of seeing bee-keeping carried on in all kinds of hives, I at once cleaned out the cobwebs from an old apiary that I had inherited, and then began to purchase bees with a view to stocking it again. The task, although at first, to all appearance, an easy one, soon began to be surrounded by a great variety of difficulties, for owing doubtless to the peculiarities of our climate, coupled with telluric, hydrographic, cosmic, and other influences, rapid breeding was evidently less easy than it had probably been in former days.

Again, the presence of the eating-chestnut tree, more or less conspicuous all over the middle and lower part of our valley, and producing as it does a rather coarse honey, difficult to separate from that obtained from other plants, made our natives look with indifference upon the produce of their beehives as an ordinary article of food.

Pondering how this indifference could best be overcome, I thought of the many millions of pretty little flowers I used to see and admire on the slopes of our high mountains during my Alpine excursions, not only interesting in themselves, but also sought after by botanists, and I argued that the exceedingly fine perfume with which they filled the air was to my mind a sure index of their value as honey producers.

I thereupon made a trial on a small scale, the result being fairly satisfactory. But although the honey thus secured was of a superior quality, the trouble and expense incurred were out of all proportion with the amount realised. True, many of these drawbacks have since been removed; but I do not feel that I have succeeded in placing this industry upon a purely self-supporting basis. Nor am I sure that it will be sufficiently rooted to hold its own after I have passed away.

After a long series of trials and experiments, I decided upon a novel *modus operandi*, the plan of which consists in the concentration of the whole strength of 100 stationary stocks into thirty nomadic ones, without suppression or division, thus acting on the principle that better results are to be obtained from one single strong stock than from five or six weak ones. Once supplied with the brood, combs, bees, and the choice queens of the other seventy, these thirty stocks are removed, at the proper season, to Mount Rosa, where they are in a position to put forth the whole of their strength in the collection and storage of honey, without loss of time, and giving as good results, if not better, than 100 ordinary stocks would give.

It is now several years since I adopted this—what I may call artificial—means of obtaining a natural product, the development of which can, of course, be further extended by increasing the number of stocks so treated. Nay, I believe that with the exception of unfavourable seasons—not infrequent of late years—when weather and temperature seem to combine and act adversely against agriculture generally,

efforts in this direction would be crowned with fair results. I will now relate how I proceed with the strengthening of my stocks, in order to render them capable of collecting the greatest possible amount of honey in those high regions.

I winter my stocks as strong as possible, and then, by supplying them with plenty of stimulating food mixed with honey in the early spring, I promote rapid breeding. I then select the best, and add to their strength by giving them well advanced brood from others, so that when blossoms begin to appear, and the time for removing to Alagna, on Mount Rosa, has arrived, they may be full of adult workers, already used to the collection of honey. Here they are situated at about forty kilometres from the other stand.

The removal is done on vehicles at night, when every precaution, learned at my cost or by experience, is taken with them.

When we consider that the lives of millions of delicately constructed insects are at stake, the difficulties of the task can be easily imagined.

How often have I exclaimed, with a deep sigh, when undertaking this work:—‘Oh, happy the bee-keeper who can always keep his bees by the side of his residence!’

Arrived at our destination the stocks are placed, in numerical order, in an Alpine chalet, the shape of which makes it well adapted to that purpose; then overhauling them, a super, in the shape of another hive, is placed upon each. This additional hive or super is supplied with fifteen combs of worker cells, so that no time may be wasted for building purposes, knowing that, besides the loss of time, about eight kilos of honey are sacrificed for every kilo of comb built. Then again, I do not want drones fed upon honey that had better be stored away.

Gradually, and as the season and breeding advance, I add, where necessary, additional boxes or supers of same size on the top of the others, thus forming a roomy body-hive without divisions of any sort. In this way, in some, although rare seasons, several of my stocks bring their population up to over 80,000 bees, covering sixty frames of our Italian standard size. A medium-sized stock serves me as a nectarmeter. This is placed on a weighing machine, and by its daily rising or falling I can tell exactly how the collection of honey is progressing. If I see that there has been a conspicuous decrease in weight, owing, more often than not, to a sudden change of temperature, I feed immediately and without stint, so that my bees may always have plenty of food for themselves and for their little ones as well, which in the height of the season may average from 15,000 to 30,000 in each stock. I look upon this liberal feeding as a *sine quâ non* if the strength of my stocks is to be kept up. If, as it will occasionally happen, this perversity in the state of the weather lasts a long time, several hundred-weight of inferior honey is consumed as food by my bees, and this feeding is done with the double object of keeping up the breeding of the queens as well as preventing the bees from con-

suming the exceptionally fine honey they have collected in the locality, this being the only quality I sell to my customers.

I find that if bees are fed liberally in this way, when little or nothing is to be had from flowers, they resume work with increased vigour when circumstances permit, and new generations of flowers are blooming and succeeding each other until about the end of August, when I begin extracting from every comb, except those close to the brood nest, which has by this time decreased in size. After this I remove my bees to the heather, near Varallo-Sesia, where they are allowed to winter.

The honey obtained in this district—one of the highest of Alpine districts—has a purely crystalline appearance, particularly when it is, like mine, extracted by an extractor from combs worked on the 'cold' system, and is in every other way prepared with every possible care, and when still fresh it will run like oil. Later, according to the season, it gradually becomes more dense until granulation sets in, commencing with the appearance of small specks, which are often mistaken by customers for bits of comb or wax. Honey thus put up will keep for an indefinite length of time—its beautiful aroma, which distinguishes it from all other honey, gaining it the praise not only of connoisseurs, but also of hygienic celebrities, and the medical faculty as well. It is now generally known as '*Monte Rosa Honey*,' and is much in demand by English and German visitors who come to spend some of the summer months in Valsesia. It has also been awarded the highest prizes wherever it has been exhibited (including the recent Italian Exhibition held in London), and has had the honour of being selected by His Majesty Humbert I., King of Italy.

Now, from the above explanation it will be easy to form an idea of the work and trouble involved in this system of nomadic apiculture, to say nothing of the valuable time taken up by the removal of the bees to great distances and to such altitudes.

But in my love for this industrious insect, whose labour man should turn to better account, as well as for my native valley, to the trade of which I should like to add another item of export, I have been induced to persevere, and will do so still, in the hope that ere long the honey yielded by our great Monte Rosa will become better known in commerce.

It will not be out of place to give here the result of the analysis made in the agricultural testing laboratory of Turin, viz:—

Water	16.00
Saccharine substances	2.37
Dextrose	33.70
Levulose	43.60
Ash	0.21
Other undefined substances	0.412
	100.00

Such a composition shows that the honey is absolutely pure and free from all foreign matter. Moreover, microscopic examinations have shown

that this honey is entirely free from dust, starch, particles of wax or of insects, thus showing that also as regards purity it is as perfect as it can be, and consequently a good article of food.—GIACOMO BERTOLI, *Varallo-Sesia, Italy, September 20th, 1890.*

APPLIANCE DEALERS.

[495.] It appears that my letter (No. 471, p. 582) has not been altogether unnoticed. Presumably Mr. Woodley (No. 477, p. 591) was thinking of my complaint, as well as that of others, when he suggested the desirability of ascertaining whether the delay of goods is due to the negligence of the railway company or of the dealer 'before rushing into print.' In my case it was plainly the dealer's fault, as his own invoice and the goods arrived almost simultaneously. To Mr. W. B. (No. 484, p. 605) who accounts for my trouble on the score of 'inattention' to the repeated advice given in the *B. B. J.* to order early, let me say I had relied on getting my supplies from a local dealer, but finding his prices higher than others advertised I decided, unavoidably, in the last moments to order from the last-mentioned source, with the result already related. But can any impartial person exonerate the dealer in question from a charge of want of common courtesy in not, at least, apologising for the delay of goods? much less for sending goods value 5s. less than P.O. remitted at the first, exclusive of the discount of 1s. 6d. in the pound? My apparent want of attention I think hardly justifies Mr. 'Dealer' in *thus* taking advantage of me, and yet this is the inevitable inference of Mr. W. B.'s theory. Delay was not the only thing I complained of. A loss of 6s. 6d. meant something to me, though it might be of no importance to my friend 'W. B.'

Again, 'T. F. L.' (No. 486, p. 606) speaks disparagingly of cottagers making their own hives properly. My advice in No. 471 was for '*mechanically-inclined* bee-keepers,' and of these I could name several in this neighbourhood, which is quite a country place, who could make a hive in all its parts as accurate as need be for all practical purposes. There is, in my opinion, a great deal of hair-splitting in many of the instructions for hive-making, which only tend to mystify the whole business, and discourage many from trying to make their own hives, &c., who would like to try but for fear of failure. In my humble judgment, however, while a few hives might be spoiled at the outset, a sufficient degree of proficiency would, in most instances, be attained after a few trials, for 'practice makes perfect.' There are no insuperable barriers to the man who has a will. Still I am thankful for 'W. B.'s' offer of putting me, or any one else, into communication with an honest dealer, also to 'T. F. L.' for his suggestion of getting a cheap hive in the flat, &c., which is certainly something to the point: but, as will be seen by my address, it does not benefit me anything, living out of the reach of Associations and such-like, the same as

many others, for whose especial encouragement these remarks are penned.—G. J., *Ashfield Lodge, Cootehill, Ireland, December 22nd.*

[We quite endorse our correspondent's views as to cottagers and others 'mechanically inclined' making their own frame hives. It always adds to the interest with which a bee-keeper regards his hives when they are the work of his own hands; but we should never advise any amateur joiner to attempt making bar-frames. It seems to us almost like trying to save money by making one's own nails, when accurately-cut, machine-made frames can be had for about a penny each; and on this ground we always recommend amateurs to 'make your hives and appliances by all means if you can, but draw the line at frames and sections.' Buy them, and save money, time, and temper, and secure efficiency by so doing.—EDS.]

SEASONABLY APPRECIATIVE.

[496.] The opening chapter of your *British Bee Journal* last week contains a modest opinion that not a bee-keeper in a hundred would care one jot what 'Mr. Useful Hints' might have to say at Christmas-time. The postman brought my *Journal* on Christmas Day, just after the annual turkey, pudding, and mince pies had been disposed of, and with dessert on the table: but oranges, apples, preserved fruit, walnuts, and a good glass of port had to wait a few minutes, so far as I was concerned, until I cut open my bee-paper. Not very polite to the company, you will say. Well, perhaps not; but being my own family circle, who know I am 'mad' on bees, they would forgive me readily enough. There is a something irresistible about the *Journal*. Again and again, when I have been on the point of writing to you to ask for some information, the very thing I wanted to know has been anticipated in the next number. Personally I look forward to my *Journal* every Thursday with the greatest interest, and there is an uneasy look on 'father's' face if he comes down to breakfast and does not see it lying on the table. No! a better conducted paper there could not be; and I feel sure I am right in saying that every bee-keeper is under a great obligation to the editors for the infinite pains and trouble they take.—AMATEUR, *Newcastle-on-Tyne.*

[Many thanks for your kindly appreciation.—EDS.]

THE WEATHER.

[497.] I am relying on your teaching when you tell us to leave the bees untouched though the hives are snowed over. My six stocks lie on low ground just under a hillock, and the snow has completely covered them in. I trust they will not be suffocated.—A NERVOUS ONE.

[Rest assured that the bees will take no harm.—EDS.]

Reviews.

OUR LIBRARY TABLE.

If the amount of bee literature produced every year is any indication of the progress of bee-keeping, the advance made in 1890 should be very great, judged by the number of books that have accumulated on 'Our Library Table' and are waiting for notice. There are some good, others indifferent, and the only wonder is how some of these books ever get sold. It is true that in Germany and France an edition does not frequently consist of more than 1000 copies, and sometimes not even more than 500, so that a comparison of the different editions with our own does not give any idea of the actual number produced. There are exceptions, of course, to this rule, and such standard works as the *Conduite du Rucher* for example, by M. Bertrand, finds a ready sale even though a couple of thousand copies compose an edition. First among the books we have to notice is

Conduite du Rucher: Calendrier de l'Apiculteur Mobiliste. Par Ed. Bertrand. 6me edition. Revue et augmentée (Published by R. Burkhardt, Geneva.)—This is a new edition of this popular work, which we have already alluded to. We are pleased to see that it has been considerably improved by being issued in a more convenient form, and can now be easily carried in the pocket, a convenience which bee-keepers anxious to learn will appreciate. The work has been entirely revised and brought up to the times: a number of new illustrations have also been added. On page 171 there is a chapter on 'The Management of an Isolated Apiary,' by M. G. de Layens, in which he describes the hive and appliances used. The hives are very large, and M. de Layens only visits them twice a-year, in the spring and autumn. This simple method of bee-keeping yields satisfactory results, although, of course, such large harvests cannot be expected as are obtained by other methods; but it is a plan that would commend itself to those who have only very little time to spare. At the end of the work, which contains 284 pages, is given a list of hive manufacturers and appliance dealers, and a folding sheet containing details and dimensions of the two most popular hives in Suisse Romande, viz., the Layens and the Dadant. The work is full of practical information, and an indispensable guide to the bee-keeper. We recommend it to those acquainted with the French language.

Guide de l'Apiculteur Anglais. Par T. W. Cowan, F.G.S., F.L.S., &c.; traduit par Ed. Bertrand. 2me edition. Pub. R. Burkhardt, Geneva; R. Gaiel, Paris; and J. Lebègue & Co., Bruxelles.—This is the second edition of the translation by M. Bertrand of the *British Bee-keepers' Guide-book*. Although written principally for English bee-keepers, this book has been pretty extensively read, and we found every bee-keeper amongst the Savoy mountains whom we visited thoroughly well posted up in

its teaching. This edition consists of two thousand copies, and is got out in the same careful style that characterises all M. Bertrand's productions.

South African Bees and their Management in Movable Comb Hives. By Henry L. Attridge, bee-master, lecturer on Apiculture to Government Apicultural College. Pub. Times Office, Wynberg.—This is a useful little pamphlet of thirty-five pages for bee-keepers in South Africa, where bee-keeping on improved methods is being taken up, although there is a great deal of prejudice to contend against. Mr. Attridge says the South African variety of the honey-bee does not appear to be a distinct race, but that many of the characteristics of the black bee, the Ligurian, and other races are combined in this variety. The colour, markings, and size of the South African bee vary considerably, and most notably with the worker. Those showing the greatest preponderance of yellow are perhaps the most docile, and the smaller and darker bee is generally the most vicious. Probably this latter is the variety introduced some time ago into this country, and found to be very vicious. South African bees are also liable to have fertile workers, and our author has found them appear in colonies, having both eggs and young worker larvæ. Descriptions of hives and appliances are given, although no particular make is recommended, Mr. Attridge insisting only that the hives should have movable combs. He also strongly deprecates the introduction of foreign races into the country, fearing the importation of the germs of foul brood, which at present is not found in South Africa. If this be so, we think our author is right, and should try to improve the race by means of other bees in the country. He says South African bees are hardy and healthy, and we hope they may long continue so. The pamphlet is well worth reading, especially by those who take an interest in foreign varieties of bees.

Die Wachsmotten. By J. Denmler. Published by Schwetschke & Son, Braunschweig.—This is a pamphlet containing eight chapters, and is devoted to the subject of the wax-moth, with an introduction by M. Gravenhorst. It is illustrated with a number of engravings taken from Langstroth on the Honey Bee, and with which most bee-keepers are now pretty familiar. The ravages committed by the wax-moth are well shown in the illustration on page 18, where it has evidently got the mastery of the bees and taken complete possession of the hive. M. Denmler is known as a frequent contributor to our pages, and his facile style of writing makes all his productions interesting reading.

Guia del Apicultor Español, o sea. 2^a edición de La Apicultura Movilista en España por Francisco F. Andreu. Mahon, Minorca.—This is, as its title implies, the guide of the Spanish bee-keeper, and is a second edition of *Bee-keeping with Movable Combs in Spain*. This edition is a great improvement on the former one, being much larger and containing much

more information. English methods seem to have taken root in Spain, probably owing to the *British Bee-keepers' Guide-book*, which was translated into Spanish, having had a large circulation there. Anyhow, M. Andreu describes English hives and recommends our methods of management. The fact that this is the second edition of this book shows that bee-keeping is making progress in Spain, and we hope it may continue to do so under the careful guidance of M. Andreu, who is also the editor of the *Revista Apícola*, a journal that has also been considerably enlarged since it was first started.

La Fausse teigne ou Teigne des Ruchers. Description et Moyens de la Combattre. Par A. de Rauschenfels; traduit par Ed. Bertrand, Nyon.—This is a translation by M. Bertrand of a pamphlet by M. de Rauschenfels, editor of the Italian bee journal, *Apicoltura*. It contains a history of the wax-moth and reference to works published regarding it. It also goes fully into its effect upon hives and the manner in which it destroys the combs, where it is allowed to get a footing. The methods for its prevention and extermination are also described. In Southern Europe, where the wax-moth is much more prevalent than it is here, greater care has to be exercised to keep this enemy away from the hives, and this pamphlet must do much good in this direction, and be very useful.

Modern Bee-keeping. A Hand-book for Cottagers issued by the British Bee-keepers' Association. Published by Longmans, Green, & Co., London.—Very little need be said about this popular little hand-book, which is now so well known and so highly appreciated. This is the fifty-fourth thousand, and we know of no other book about bees that has had such an enormous sale. The present edition has been revised and brought up to the times, and should be in the hands of every cottager who keeps bees.

The Busy Bee: its Mission and Domestic Economy. By J. W. Stroud, M.D., F.L.S., F.G.S., Pretoria, S.A.R.—This is the title of an excellent paper in the *Cape-Farmer's Own Vade Mecum; or, South African Agriculturist's Almanac* for 1890. It is written for farmers, and is specially intended to give a thorough knowledge of the natural history of bees. Dr. Stroud is a deep thinker and able writer, and his paper shows that he has studied the subject thoroughly. He treats of the natural history of the bee and its relation to flowers.

Der Honig und Seine Praktische Verwertung. By Max Pauly, assisted by Tony Kellen. Published by Moser, Graz.—Describes the methods employed in different countries for obtaining honey in a marketable form, and also the commercial uses of honey. It contains a large number of recipes, in which honey forms a principal ingredient in cookery, wine and liqueur making, and in pharmacy.

* * * Several other books have been received, a notice of which will appear next week.

THE
British Bee Journal,
BEE-KEEPERS' RECORD AND ADVISER.

No. 446. Vol. XIX. N.S. 54.]

JANUARY 8, 1891.

[Published Weekly.

Editorial, Notices, &c.

OUR PROMINENT BEE-KEEPERS.*

No. 29.—JOHN H. HOWARD.

Mr. John H. Howard, whose portrait we have pleasure in presenting below, may fairly claim a

place among the leading practical apiarists of the day. Born at Huntingdon, on July 18th, 1848, he is now in the prime of life, and is probably as fine a specimen of our kind as will be met with in the bee-community. More than once have we heard his joking claim for indulgence: 'You know an Irishman is always allowed to speak twice;' but we were as much surprised as doubtless our readers who knew him will be, to learn that, through his parents, Mr. Howard has substantial grounds for claiming kinship with the Green Isle. His father was a King's County man, who did long and faithful service for his

Queen and country, and his paternal grandfather was also of the same nationality; so that our good friend 'John'—as he usually signs himself

* In deference to the wishes of several gentlemen whose portraits we hope to present to our readers, we have on the commencement of the new volume slightly altered the title of the series as above.—Eds.



JOHN H. HOWARD.

—instead of being the thorough-bred burly Englishman we always supposed him, is possessed of Celtic blood, and with it a large share of the impulsiveness characteristic thereof.

His early schooldays were passed at the Huntingdon county school, from whence he was elected to a seat in 'Walden's School' at the same place. We can well understand his deep-rooted objection as a boy to occupy a 'back seat,'

when we remember how strong is his determination, as a man, not to occupy that unenviable position. In fact, John was by nature intended to be seen and heard, and in furtherance of this design she has fitted him with a decided 'presence.' Large of body, and possessing a fine, strident voice, he says what he means with such sledge-hammer force as fits a man six feet high and weighing about sixteen stone. Can any one who knows him realise the possibility of John Howard *whispering*—save in what he would himself call 'an Irishman's whisper?' No! we can no more fancy him subduing his voice than diminishing his size; and

so, when among men, he is, as we have said, generally both seen and heard.

But to hark back to his early days. After leaving Walden's school, his mind—ever active as his body—began to expand in various directions: first, taking up a love of flowers and gardening; next, music; then he became great on fishing; and while pursuing Old Izaak's 'gentle art' on the banks of the Ouse from the sheltered

nooks on the river's margin, views of the Roman bridge, the church of Godmanchester, and his own church of St. Mary at Huntingdon, filled the youngster's mind with wonderment as to how piles of wood and stone like these could be got to 'stand together.' Hankering after knowledge of this kind, we find him at the age of thirteen and a-half years undergoing his final examination, in which he graduated second boy, losing first place by three marks only. After leaving school he followed the bent of his own inclination, and was apprenticed to the trade of joiner and builder.

It gives us an idea of the irrepressible activity of Mr. Howard's mind to learn how his early years were passed; and, whether as leading choirboy, a member of the volunteer band, or as an assiduous student at the science and art classes, his determination was to reach top place if he could, and, aided by his natural perseverance, he made good progress in all he undertook. His term of apprenticeship over, he at once started business in a modest way 'on his own account,' and at the early age of twenty-one manfully added to his worldly cares, and his responsibilities also, by taking to himself a wife. So things went on for nine years, during which time our friend was accumulating knowledge, while steadily gaining the necessary practical experience in the building trade—then, as now, an important branch of his business. Then came his first domestic trouble in the death of his wife, and he was left with a family of one boy and two girls. Troubles seldom come alone, and within two years Mr. Howard lost his own father, mother, and sister, and suffered a severe business loss by taking a contract for the extension of the Hunts Waterworks at what turned out a very unremunerative figure, and, in consequence, all his hard-earned savings went to benefit the Huntingdon ratepayers.

Not easily cast down, however, he made the best of this serious reverse, and resolutely worked away against some continuous ill luck about this time, until in 1873 Mr. Howard was selected from among several candidates by W. Wells, Esq., lord of the manor of Holme Wood, near Peterborough, to do the general building work of the Holme Wood Estate. This appointment necessitated his removal to Holme, and the handing over of the business at Huntingdon to his brother. After remaining a widower between four and five years he again married very happily, and bee-men not a few, who have spent a night beneath the Holme Wood roof-tree, bear hearty testimony to the warmth of the welcome there met with at the hands of John Howard and his good wife.

A few years after establishing himself at Holme, his natural taste for gardening reasserted itself, and our friend began to turn his thoughts to pleasure-giving hobbies outside his regular business. In this way he began flower-growing—of which he is especially fond—and along with it he began bee-keeping, his earliest possession in this line being skeps purchased with the traditional pieces of gold without which it was

deemed impossible for the bees to prosper. It appears that he first became inclined favourably towards bee-keeping about twenty years ago, when on visiting London he saw some beautiful sections of honey-comb in a shop-window there. Prior to that time he had rather an antipathy towards bees by reason of their stings; but he resolved to overcome his dislike if he could but produce honey-comb such as he saw. On his return home he was not long in making a start. Like others who have gone before him, he had his failures and successes; he went through the craze for foreign bees, spending many pounds in giving them a fair trial, and has ended by refusing them a resting-place in his apiary. It may be readily supposed that Mr. Howard's joinery business has connected itself with his bee-keeping, and he is now one of our largest manufacturers of bee-appliances. Nor is he one of the standstill sort; he is incessantly on the 'think' as to what can be done by way of improving the appliances in use, and not a few of the valuable things used by bee-keepers owe their origin more or less to him. His specialities are the 'Paragon hive,' the 'Howard section' and method of fixing comb foundation, the 'carbolised spray-diffuser,' 'comb-filler,' &c. All Mr. Howard's originations bespeak the thoroughly practical bee-keeper. A thorough manipulator, he often does the work of lecturing, &c., in the bee-tent at shows, and he can handle bees thereat as well as any one. Besides this his own apiary is one of the most extensive and best appointed in the kingdom. And nothing ever gave him more pleasure than when our late friend Wm. Raitt—on the occasion of a visit to Holme—dubbed it the 'model apiary,' a title it has borne ever since. An hour or two among the bees under the guidance of our genial friend is not only instructive, but his enthusiasm is catching, and the visitor usually departs full of very pleasurable feelings regarding the 'hobby.'

Want of space—as well as a desire to avoid saying anything which might be construed as savouring of advertisement—compels us to touch but lightly on Mr. Howard's excellencies as a manufacturer; but we cannot help remarking that his productions bear the impress of the practical bee-man who labours largely among bees himself, and who, with his workshop surrounded by scores of colonies of bees in 'full blast,' has the opportunity of speedily testing anything new he is desirous of bringing forward, and so finding out faults as well as good points by practical experience under his own hands.

In acquiring materials for this slight sketch of Mr. Howard, we have been enabled to gather much information bearing out our high estimate of his character, and attesting the certainty that he will always be found in the forefront among his neighbours. A Past Master of the local lodge of Oddfellows, M.U.; Overseer for the parish of Holme; Assessor of income tax for the Norman-Cross Division; Rector's churchwarden; Hon. Sec. Holme Constitutional Association; hon. member and counsellor to the Holme Benefit

Club; will-maker and general adviser to the humbler villagers; umpire at the village sports, &c., &c., our friend's public work proves that he is neither idle nor selfish: and we trust he may long be spared not only to his own family, but to that larger family of neighbours and friends by whom he is surrounded.

BRITISH BEE-KEEPERS' ASSOCIATION.

Nominations of Members of the Association for election on the Committee for the year 1891 must be made not later than Saturday, January 31st: forms for such nominations may be obtained upon application to the Secretary. The Annual General Meeting of the Members of the Association will be held on Tuesday, February 24th. Notice of Motions for this meeting must be made not later than January 31st.

Subscriptions for the current year became due on January 1st.

USEFUL HINTS.

WEATHER.—What a subject to start off with is the one which—according to the character we Britons bear among foreigners—is supposed to be uppermost in our thoughts! Why, we have had nothing *but* weather ever since our last 'Hints' appeared a fortnight ago; and so fantastic have been the tricks displayed by 'the clerk' that we can read a bit like this (written, bear in mind, at Wick, in the far north of Scotland, and not many days ago:—'We have had no snow this season; you have had a lot. We have in the garden roses and all sorts of flowers in full bloom, and strawberries full size (but not ripe). I never saw the like before.' While at the same time we are enjoying, or enduring, from ten to twenty-five degrees of frost in the south of England! Our personal experience of the weather prior to this winter has been confined to the north of England, and certainly we never there felt anything like the severe frosts we have experienced since removing southward. The reports from day to day, as given in the public press, establish the fact that the present winter is the severest which has been experienced for very many years. We have had the Thames frozen over, and ice seven inches thick in some of the Metropolitan parks, while nearer the south-eastern seaboard as many as thirty degrees of frost have been recorded. Fortunately the ground is everywhere covered with snow, and thus the tender growths, which a few weeks ago looked so forward,

will be protected from blight. Bees also will, we trust, have felt the benefit of the protecting snow, wherever entrances have been left untouched after being snowed up. One night, we remember, about ten days ago, the north-east wind and the driving snow was a veritable blizzard in intensity, and of such terribly cutting keenness as to try the vitality of men, to say nothing of bees; in fact, how the latter, if left with wide entrances, exposed to such a blast, could stand it, we are at a loss to tell; but it is to be hoped few were subjected to such a trial. The curious effects of what is called oceanic warmth have also been very marked, as shown by the following observations of a correspondent of the *Standard*. After giving the varying temperature of each day for fifteen days, ending December 24th, at London, York, and Stornoway, which shows a mean temperature of 26·2° at London, 30·8° at York, and 42° at Stornoway, he says that—owing to the oceanic warmth—not only has the climate in the outer Hebrides been milder—sixteen degrees warmer than London—but it has also been more equable. This warmth at the northern stations has been felt also, more or less, on the east coast of Scotland; and even so cold an inland station as York has been nearly five degrees warmer than London during the period.'

On page 21 a Lincolnshire correspondent gives us a very interesting weather report for the year 1890, and here it will be seen that the minimum temperature of the last two months of November and December has been so exceptionally low as twenty-eight and thirty degrees of frost respectively.

DOUBLE AND SINGLE-WALLED HIVES.—It will be both interesting and instructive to observe how bees in the various kinds of hives in use will come through so severe a winter as this. Not that we consider the form or type of hive by any means the most important factor in wintering bees, but the almost Arctic conditions which now surround us, if of frequent recurrence, would have the effect of thoroughly testing the efficiency of our present system. This is just what we desire to see, for the sake of the lessons to be gathered therefrom by bee-keepers of colder countries than our own. In America, for instance, where bee-keeping is followed as a speciality and on a scale quite unknown here, no expense is grudged nor labour spared in providing

scientifically constructed winter cellarage for bees; and in spite of all, these costly shelters are not uniformly successful or even satisfactory—indeed, the death-rate among the bees is much higher on the average than in this country. So that something besides mere protection from cold is required, and we believe that after all, to winter bees on their summer stands is by far the most natural plan, and most likely to succeed in any and every country.

We have been led into this line of thought by reading in American bee journals of the interest being taken just now in hives with loose outside cases, and not without some amusement do we read of such hives being dealt with as something new; but that need not trouble us. We trust they will give such hives a trial, and that they will also find them as advantageous as we have done for the last fifteen or more years back.

PREPARING FOR A BEE-FLIGHT.—While all is so quiet in the apiary, and the frost, in spite of fitful thaws for a few hours, still hold out, it must not be forgotten that when the bees are really set at liberty once more by the warmth there will be a great 'turn out,' and this should be prepared for by clearing away all soft snow from entrances.

THE FOUL-BROOD BACTERIA.

TREATMENT OF FOUL BROOD BY THE USE OF NAPHTHOL β .

[Although nothing can be done to cure bees of foul brood at this season of the year, we think it a good time to carefully study the subject, so that at the opening of the season proper steps may be taken for the prevention or cure of this disease by those who are willing to try. With this object in view, we have much pleasure in giving our readers a translation from the *Revue Internationale* of a paper by Dr. Lortet, who has for some time been making experiments and observations upon this disease. There are many points quite new, and which throw considerable light upon the subject, and the remedy proposed is simple and, from reports, encouragingly effectual. We wish our readers to particularly note that the naphthol is that known as naphthol β (naphthol beta), and not the ordinary naphthaline. As it is perfectly harmless, there is no danger in its application.—EDS.]

Thanks to the publicity you were good enough to accord me in the columns of *La Revue*, I have received from a number of your readers pieces of foul-brood comb or bees exhibiting more or less advanced stages of the disease. I have,

therefore, during the last year been abundantly supplied with material for my researches, and have been enabled to clear up a good many obscure points in connexion with this virulent affection, and to formulate a course of treatment based on careful laboratory experiments.

As was demonstrated in the contributions by Mr. Cheshire (*Revue*, August, 1884) and Dr. Klamann (*Revue*, January, 1889) foul brood is in reality produced by rod-shaped bacteria which develop rapidly in the brood cells and soon die, and produce in putrefying an odour which is altogether unmistakable.

Before beginning my observation of foul-brood larvae, either during the disease or after death, and of adult insects already infected, I turned my attention to perfectly healthy bees, as well as various other species of hymenoptera, such as wasps, humble-bees, carpenter-bees, &c. After a patient and minute course of dissection I have arrived at the following results, which are based on an intimate acquaintance with the ætiology of the disease.

I.—I find that various hymenoptera, besides adult bees, whether healthy or diseased, *invariably present*, through the whole of the lower part of the digestive tube, a very large number of bacilliform bacteria, which are probably called upon to perform important, though at present unknown, functions in connexion with the chemical changes which take place in the food introduced into the digestive canal.

In the bee, to mention only the species which immediately interests us, whether healthy or diseased, as well as in the digestive canal of the brood, whether in health, in disease, or after death, I have invariably discovered two normal bacilli, the presence of which has, without doubt, led some people astray.

The more numerous of these bacteria are of a large rod-like shape, broad, thick, short, and bear a striking resemblance to certain bacteria which are frequently met with in soft water. They are never arranged in chains, but propagate themselves by means of binary fission; in the early stages they are often united in couples. When fully developed they become slightly rounded at the extremities, which swell perceptibly. These bacteria retain very well the stain communicated by Fuchsin, and after staining, the club-shaped ends show a much darker tint than the central space of the body. In this state the bacteria present the same appearance as may be observed in the bacteria of malignant œdema.

This species is most easily cultivated, especially in liquid media, less easily in nutrient Agar-Agar glycerine-gelatine. When injected into the cellular tissue of guinea-pigs it fails to produce any harmful effect.

II.—Another normal bacterium is also invariably found in the digestive canal of the bee. It is smaller, thinner, and short, its length being only equal to twice its breadth; it is not rounded at the extremities, which are shaped almost at right angles. These bacilli do not form chains, but frequently remain united in pairs for a long

time. In this state they nearly resemble diplococci, though perceptibly more elongated than these latter. In cultivation they often group themselves into *zooglea*, and in this case arrange themselves very regularly. These microbes multiply without difficulty in both solid and liquid media, and take a strong stain from Fuchsin, or Methyl, or Gentian violets.

III.—Lastly, in the digestive canal of dead or diseased brood, as well as of adult bees already infected with the disease, but in the digestive canal alone, a third kind of bacterium is found, which is without doubt one of the forms that have been examined by Mr. Cheshire. It is thin, and frequently extends in filaments. It thrives well in sterilised veal-broth, and it is therefore comparatively easy to obtain a supply of perfectly pure specimens for purposes of inoculation. In this nutritive element filaments appear in a few days, and after staining the fine granular elements of the formation become apparent owing to the differences in colouration.

In the digestive canal of the adult the bacteria appear to maintain their rod-like shape for a considerable period—perhaps, indeed, always; whereas in the digestive canal of the larvæ, probably owing to the influence of albumenoids, which pass by osmosis through the walls of this tube, the bacteria, as in the case of cultivations effected in unsalted veal-broth, are rapidly transformed into very fine, virulent granulations, which invade all the tissues, and soon bring about the disorganization and rapid putrefaction of the larvæ.

The adult bee, on the other hand, even when the foul-brood bacteria have taken possession of its digestive canal, seems to be able to live for a certain time. It is, however, none the less apparent, once the infection has taken firm hold, that the animal is diseased. The digestive canal, and especially the surrounding glands, end by being invaded by an enormous number of the rod-shaped organisms; the insect loses its vivacity, grows languid, and finally perishes after a more or less protracted interval.

Virulent granulations cultivated in salt veal-broth or on plates of glycerated Agar-Agar produce bacillary bacteria, which, when given in food to the larvæ, undergo in their turn segmentation into virulent granulations, whereas in the case of the adult bees they still probably retain the bacillar form for a long time, though they do not fail in the end to cause its death.

The culture and transformations of the foul-brood bacterium cannot take place in the honey; so much is certain. Still, I may mention that in diseased hives the honey and wax are always more or less infected on the surface by bacilli, virulent granulations, excrements, &c.

I have on several occasions succeeded in reproducing the whole series of phenomena mentioned above experimentally, and have, without difficulty, infected insects which had been perfectly healthy and vigorous up to the moment of the experiment. My mind is, therefore, quite free from doubt in the matter. It is the adult bee which is first infected in its digestive canal by

a foul-brood bacterium obtained from some unknown source. In feeding the larva it infects in its turn the digestive tube of this latter, and here, owing to the action of the albumenoids, the bacillar bacteria are transformed into virulent granulations, which invade the tissues and finally bring about the death of the insect.

Contaminated honey may be a cause of the propagation of foul brood in the sense that, being polluted by foul-brood bacteria or by virulent granulations, the healthy adult bee which allows this substance to enter its digestive canal is rapidly attacked by the disease, and will even itself soon communicate the infection to the brood. Experiment in such cases gives the most convincing results. Still, in the case of foul brood, as in the case of virulent affections which attack vertebrate animals, certain individuals seem to enjoy exceptional immunity, and resist the infection. Is this due to previous inoculations, or to some individual predisposition? This is a point which I am not at present prepared to decide.

I had only once an opportunity of examining the queen of a hive infected with foul brood, the property of M. Matthey, of Bassins. The eggs of this insect were healthy, and contained neither bacilli nor virulent granulations. The queen herself was perfectly healthy, a point which I was able to place beyond a doubt by means of a careful post-mortem. I hesitate to draw any conclusion from this isolated instance, though I confess that, judging from the course the disease takes, I do not believe that, as a rule, the malady can be propagated by the rearing of larvæ produced from infected eggs.

In my opinion, therefore, it is always the digestive canal of the nurse-bee which is infected, and it is always by the act of feeding that the adult bee infects the digestive canal of the larvæ, the death of which latter is the speedy result of such inoculation.

Therefore, a knowledge of the above facts leads me to the following conclusions:—

1. The bacteria of the third form described, as already shown by Mr. Cheshire, are in effect the true cause of foul brood. They are the active agents of contagion and of the propagation of the disease. Numerous laboratory experiments, too long to be described here, prove this beyond the shadow of a doubt.

2. Seeing that the foul-brood bacteria must necessarily kill all brood the digestive canal of which is inoculated by the act of feeding, it appears to be absolutely useless to endeavour to cure these larvæ, as all their tissues are rapidly invaded by the virulent granulations* into which these bacteria resolve themselves.

3. Adult bees, whose digestive canal is infected by the foul-brood bacteria may frequently survive for a considerable period. Some even,

* I employ the word granulations purposely in preference to the term *spores*, which is used by several writers. I cannot bring myself to believe that true sporulation, similar to that observed under certain conditions in bacteria of anthrax and in that of blood from spleen, really takes place in foul brood.

owing to special circumstances, seem to resist the virulent stage of the malady. We must therefore direct our efforts to the digestive canal of the worker-bees, the feeders of the queen, if we desire to attack at its source the evil which may spread with lightning rapidity among the rising generation of larvæ, which is the sole hope of the colony.

IV. The treatment, then, ought to be internal and as energetic as our little patients are willing to allow. External treatment, by means of fumigations or sprayings of any kind, are (I do not for one moment deny) also helpful, since these methods contribute largely to the disinfection of the hives, combs, and tissues of the bees, &c. It is even possible, under certain circumstances, to succeed in diminishing the virulence possessed by the bodies of the larvæ after death during the process of desiccation. But I must repeat that such external treatment can only be useful as an auxiliary, and I greatly question whether it has ever been successful in curing of itself a hive attacked by a well-authenticated case of foul brood.

The foul-brood bacterium seems to be very fastidious with regard to the conditions of its existence. The media in which it can be developed are rendered sterile by the introduction of infinitesimal quantities of well-known antiseptic substances. We are, therefore, justified in supposing that these same substances, if the bees can be made to absorb them, will prevent the invasion of the digestive canal and the surrounding parts by the bacillar bacteria, will destroy those that may have already lodged there, and will thus prevent the infection from spreading to the brood in the act of feeding.

The space at my disposal is too limited to permit of a detailed description of the numerous experiments which led me to fix on an antiseptic of the first rank, introduced some years back as a valuable antiseptic remedy in the case of intestinal derangements in man. This substance is naphthol β , which owes its introduction into general practice to the valuable researches of M. Bouchard, professor to the Faculty of Medicine of Paris. This excellent antiseptic cannot injure the bees, and they take to it the more readily as it is not very soluble, and therefore is not easily absorbed by the intestinal walls. Notwithstanding this, even when administered in minute quantities, *e.g.*, in doses of 0.33 grammes to 1000 of liquid, it effectually prevents all fermentation, decomposition, or other changes caused by the micro-organisms. The media most favourable for the development of foul-brood bacteria are rendered perfectly sterile when treated with a proportional quantity of naphthol.

Lastly, thanks to experiments made with some full hives partly attacked by the malady, which have been kindly forwarded to me by some of my correspondents, I have ascertained that a syrup medicated by a dose of naphthol in the proportions mentioned above is amply sufficient to rid foul-broody bees from the parasites contained in the digestive canal. In cases where

the infection has not laid too strong a hold of the parts surrounding the intestine, the cure seems to be speedy and complete. Even in captivity and under very adverse sanitary conditions, the insects soon regain all their old activity and liveliness. The treatment which I venture to recommend to the serious attention of apiculturists is as simple and rational as possible:—

In the early spring, before eggs are laid, administer to the diseased hives as large quantities as possible of sugar syrup containing 0.33 of a gramme of naphthol β . The naphthol should be first dissolved in one litre of pure water, with one gramme of alcohol added to facilitate its solution. The liquid thus obtained is employed in making the syrup in the usual manner. I am quite certain that with this dose the bees will readily take to the syrup, which is in itself a powerful antiseptic. I need scarcely add that first-rate hygienic conditions are also necessary if we desire to give the bees the vitality and recuperative power which play so important a part in enabling living organisms to resist the inroads of virulent microbes.—DR. LORTET.

We have received from the trustee of the estate of Mr. S. Simmins a notice of his intention to apply to the Board of Trade for his release from the official position held by him in connexion with the estate, together with a declaration of a first and final dividend of seven-sixteenths of a penny in the pound. The notice declares that the debtor's estimate of the amount expected to rank for dividend was 2869*l.* 19*s.* 7*d.*, and that the actual amount realised was 46*l.* 4*s.* 7*d.*!—a discrepancy altogether beyond our comprehension.—EDS.

Correspondence.

The Editors do not hold themselves responsible for the opinions expressed by correspondents. No notice will be taken of anonymous communications, and correspondents are requested to write on one side of the paper only, and give their real names and addresses, not necessarily for publication, but as a guarantee of good faith. Illustrations should be drawn on separate pieces of paper.

Communications relating to the literary department, reports of Associations, Shows, Meetings, Echoes, Queries, Books for Review, &c., must be addressed only to 'The Editors of the "British Bee Journal," 17 King William Street, Strand, London, W.C.' All business communications relating to Advertisements, &c., must be addressed to Mr. J. HUCKLE, Kings Langley, Herts (see 1st page of Advertisements).

*** In order to facilitate reference, Correspondents, when speaking of any letter or query previously inserted, will oblige by mentioning the number of the letter, as well as the page on which it appears.*

NOTES BY THE WAY.

[498.] The weather still continues very severe; in this district cold of the greatest intensity has been experienced, the thermometer registering from 12° to 29° of frost during the week ending December 29th. Snow lies thickly on the ground, protecting the tender grass-plants from which our busy bees will gather the next crop of honey, and, fortunately also, the tenderer plants of our principal cereal crops, from which we make the

bread to eat our honey on. The apiary presents a very wintry appearance, some entrances to hives without porches are snowed up, and the rude blustering of Boreas is thereby filtered of its icy keenness ere it reaches the fortunate inmates who are snowed in. Others, whose doorsteps were swept clean by the wintry blast, have been blocked in by a shovelful of loose snow, laid on with the greatest care lest it should get crushed into lumps, and so lose that fleecy lightness which gives protection along with ventilation, as does the snow which has fallen from the clouds in a natural way.

Tits have been very bold and troublesome for the last few days, and where the sun has melted the snow from the doorways and they could get to the entrances of the hives, many poor bees have been called out to certain destruction, either to be mutilated by the tits or to a not less certain but perhaps more humane death from extreme cold. I always feel sorry to have to resort to extreme measures with the beautifully marked birds of the 'tit family,' but to see day after day the legs and other remnants of one's bees strewn on the snow under the greater portion of the trees in the apiary was more than I could bear, so the spring trap was baited with the morsel of suet, and very soon four tits—three tom-tits and one blue-tit—paid the penalty for bee-killing with their own lives.

As soon as we get a thaw—and I would rejoice 'let it be soon'—hive roofs and wraps will require examination, and where the snow has drifted in, or the snow-water has percolated through the roof, repairs should be attended to promptly, or the 'fault' may be forgotten, and a recurring frost freeze the poor bees; and a second examination later on may discover them not embedded in amber, like the specimen of the *genus api* which has been preserved to us from the vasty depths of the great past, but embedded in ice.

An old rhyme on Christmas falling on a Thursday, says:—

'If Christmas Day on Thursday be,
A windy winter ye shall see;
Wintry weather in each week,
And hard tempests strong and thick.
The summer shall be good and dry,
Corn and beasts shall multiply.
The year is good for lands to till,
For bees to swarm and hives to fill!'

I should suppose that our crop of honey gathered in 1890 is practically cleared out, and that for the next few months those who want honey will have to look to the foreign supply to fill their wants. I am driven to this conclusion from the inquiries for honey—more frequently for extracted honey than for comb—that have come to hand lately. This, I think, is calculated to teach us the lesson to improve our methods of production and to extend our apiaries to meet the increased and constantly increasing demand for our commodity. Where is our friend Mr. Bellairs, who for so long has given us glimpses of the value of foreign honey

imported into this country? This information I have always looked on as the key to the development of our industry; and although, to the shame of the British farmers and poultry-keepers, we import vast quantities of eggs of a value of over 3,000,000*l.*, let it never be laid to the charge of apiculture that we have to import honey in an ever-increasing quantity and value to make up for the, shall I say, supineness or laziness of our rural population?—who, notwithstanding all that has been done to teach them a better method of bee-keeping during the last decade, seem to be giving up rather than increasing. I allude to the cottager class generally, whose fathers and grandfathers kept bees in much larger number than is now the case.

Why is there a falling off of bee-keepers amongst our rural population? This is a problem with many and wide ramifications, requiring more space for its full discussion than the Editors of our *Journal* could well grant; but I will briefly touch on a few of the salient points that, in my humble opinion, have helped to bring about this decline of cottage bee-keeping. Our rural population now, in comparison with even their fathers or grandfathers, are in a state of constant mobility. Bees, even in straw skeps, are not easily transportable chattels; the consequence is that, after a move or two of the bee-keeper from village to village, the bees either get jammed up in a general smash of the combs, or are perhaps suffocated by too close tying, or are so damaged in some way that the apiary ceases to be profitable, and the bee-keeper decides when 'taking-up' time comes again he will 'take'—*i.e.*, smother—the lot, and not be bothered with them again. Then another, and perhaps more potent, factor in closing up the bee-branch of the cottager's business is the 'wife' of the period; there is, I am sorry to say, but a very small percentage among them who will do anything about bees or bee-keeping compared to what their grandmothers would and did do in that way. I suppose it arises from the fact that our working classes are in a better position than formerly, and that there is less necessity for our modern housewife to take up with outdoor pursuits to help eke out the scanty wages of the labourer.

Yet another reason for the decline is the difficulty in selling their honey. They (at least, in this part) had been in the habit of putting their produce in large red-ware pots of, say, twenty to thirty pounds. This sold well a few years back to the chemists, or to the 'higgler,' who used to come round and buy up all the honey and wax in the district; but since modern bee-keepers and honey depôts and companies have bottled up in small quantities, and people can go to the nearest grocer and get a pound at a time as wanted, these old markets are closed to the cottage bee-keeper, and he is very slow to take to new methods, and put his honey up in small quantities likely to meet with a sale in his immediate neighbourhood.

Then another salient point is the method of

straining the honey, that places him at such a disadvantage unless he has embraced in some measure the modern method of 'grading' the honey by keeping different qualities apart as it is broken up in the sieve or strainer cloth. The whole of the comb that contains honey, of whatever colour or quality, and altogether irrespective of patches of brood or comb heavily clogged with pollen, is broken up into one conglomerate mass, and the consequence is the honey is so impregnated with pollen grains that it is so strong as to be unsaleable for table use. This applies to some bee-keepers; but others, who I may say are the older hands, are more careful, and the product of their apiary is nearly equal in flavour to honey extracted from combs by centrifugal force.

These are only a few of the many reasons for the decline of bee-keeping amongst cottagers, but they are ample to show the necessity for Bee-keepers' Associations—that the work of teaching modern methods to our rural cottager class of bee-keepers is only in its infancy. In a future number I will give a few hints how to reach the cottager.

The consideration of the above 'notes'—if we are to keep pace with the increasing demand for honey, impresses on my mind the prime necessity of modern bee-keeping being taken up by specialists—men of enterprise, and who are prepared to invest a certain amount of capital in the business, after the manner of our American cousins. I have no doubt that by the end of this century bee-keeping in this country will be carried on on very similar lines to the system of apiaries and out-apiaries as practised at the present time on the American continent.

Wishing every writer of the *B.B.J.* a happy and prosperous bee-year, I am, &c. — W. WOODLEY, *World's End, Newbury.*

HOUSE APIARIES AND A NEW DEPARTURE.

[499.] One word I should have been delighted to have seen added by your correspondent on p. 613 of last year's issue, so appropriate at the changes of the season—'Future.' I wish he had signed himself a 'Bee-keeper, Past, Present, and Future.' He refers to the Editor of the *Bee-keepers' Guide*, viz., 'Winter Management:—Disturb the bees as little as possible.' Keeping the outside of my single hives warm does not disturb them; they have not been touched since being put to rest 'to winter' the 15th October, and will remain so undisturbed until the middle of March.

He continues: 'The natural cause for bees in winter is to cluster, and by that means they keep one another warm.' Evidently a bee-keeper of the Past, not even allowing this for a bee-keeper of the Present. The words of my grand German bee-master are, 'Our bees are summer birds.' The natural cause referred to

is not the cause,* but the natural consequences and in consequence of being obliged to cluster to keep the artificial warmth up, on account of the temperature outside being below 40°, they have of necessity to consume the extra amount of food, unnaturally more food, in consequence of the cold and the additional heat required, and to keep alive they must feed to keep the warmth up, which can only be retained by clustering together, coddling up to keep one another warm—thus the artificial heat. Is it unnatural to keep these 'summer birds' warm enough to prevent them gorging themselves unnaturally to create the warmth absolutely required to secure their existence? On the very same principle I warm my greenhouses, which contain summer plants, in winter. The outer temperature of my single-walled hives is kept up to 45° and 50° in the beehives, say, 13° to 18° of warmth above freezing point, when I register in the open outside 18° to 20° of frost below freezing point, a difference of some 30°: or, for sake of argument, allow a difference of 15° in milder weather than we are now experiencing, and they do not consume the unnecessary food, as your correspondent writes, to keep one another warm, therefore do not require the cleansing flights, as our Editor states himself in reference to my letter, page 142, March 20th: 'If the proper temperature is kept up, the bees do not require to take cleansing flights and void dry feces.'

If they are 'unnaturally heated, and in that way disturbed,'—can this mean keeping summer birds on summer temperature and undisturbed for four or five months simply on a temperature of our own sleeping apartments, on the outside of their single-walled hives? In March and April I fire up to 76°, 75°, and 80°, when brood-rearing is going on and in full progress, and the outside temperature perhaps much milder. In a temperature below 40°, the bees do not go outside; they are not restricted altogether if inclined to do so, the door is not closed altogether in winter, but they do not do so, preferring to remain in their comfortable quarters, not needing those cleansing flights caused by unnaturally gorging themselves to keep the heat up to warm one another. No dirty, soiled combs, nor filthy interiors of hives. The results of their clustering are clean hives; healthy bees, which do not require to go outside. This has been proved a mistaken idea—an old bee-keeper's notion. The few bees crawling out at this season never to return, are old ones dying—a natural cause—whose instinct leads them out at the entrance when still able to do so, to die, if possible, outside of their hives.—J. G. K., *Grove House, Southborough, Tunbridge Wells.*

[We would refer our readers to some of the opinions of German bee-keepers who have tried the heating system, on pages 588 and 589 *B. B. J.*, Dec. 11, 1890, before they launch out extensively in this experiment.—EDS.]

* Our correspondent—inadvertently no doubt—misquotes the sentence referred to. It should be 'the natural course,' not cause.—EDS.

Queries and Replies.

[290.] *Preventing Swarming.*—Suppose I wish late in spring to increase the number of frames in a hive (with its full complement of ten frames already in) to prevent swarming. I presume my plan would be to place a similar body-box upon the lower one, and add the extra frames two or three at a time, according to circumstances. What I wish to ask you is how should I block the remaining space in the upper hive? A dummy would partition it off laterally, but to keep the bees out some sort of floor, resting on the tops of the frames in the lower hive, would be wanted also. As afterwards other frames might require to be added one at a time, the space would require to be lessened. I was thinking of using rebated slips of wood, each the width of a frame and $14\frac{1}{2}$ inches long. Upon these strips folded quilts could be laid easily, and when extra frames were added the requisite number of strips could be removed to make way for them. Would a *bee-master* do it in this way?—C., *Bideford*.

REPLY.—Your plan would scarcely commend itself to a 'bee-master.' You would find the rebated slips of wood an intolerable nuisance; indeed, they would be unworkable. Instead of giving room as proposed, endeavour to keep the ten frames of the lower hive as fully occupied as you can with brood only; and allow neither food or pollen to occupy more cells in the brood nest than necessary. Then, as soon as the outside combs are occupied with bees, give them some comb-building to do by adding surplus chambers above. If the ten frames are preserved almost exclusively for brood, and the bees are not allowed to use them for storage, they will suffice, unless the queen is unusually prolific, in which case a second brood chamber may be necessary. Timely surplus room is the main preventive against swarming.

[291.] *Wax Extracting.*—I would be glad to have directions for the best way of melting down beeswax from combs, &c.—M. BLAND, *Bideford*.

REPLY.—Except for the expense, a good wax extractor of the Gerster pattern is perhaps the best; but if only a few combs are to be dealt with, they may be placed in a fine sieve over a pan of water, and put into the oven. The wax, as it melts, drops into the water, and may be removed in a cake when cold. The subject of wax-extracting will be dealt with more fully in the 'winter papers' now appearing.

[292.] *Bee-papers for Winter Reading.*—When so many suggestions are being made as to literary and educational articles on apiculture during the winter months, I think it would be most interesting to many *B. B. J.* readers to have a few selections culled from the old masters, who seemed to study the bee even more closely than many of our bee-keepers of modern times. Some of these have already

been quoted, but I do not remember having seen in the *B. B. J.* the beautiful description given by Virgil in the fourth book of the *Georgics*, and I feel certain your readers would appreciate it, especially those who have not an opportunity of seeing it elsewhere.—E. McNALLY, *Harrington*.

REPLY.—It is open to doubt whether more than a very few readers would care to see 'selections culled from the old masters' included in our winter papers. However, we are open to receive opinions on the subject.—Eds.

[293.] *Doubling, Spreading Brood, &c.*—While wishing you and the readers of the *B. J.* a very happy and prosperous new year, I respectfully ask your advice as follows:—1. *The Bee-keepers' Guide Book*, p. 165, says, 'Double those colonies intended for extracting;' *A Modern Bee Farm*, p. 44, says, 'Strengthen your stocks about ten days before honey season is expected to open.' Supposing I have a stock on ten frames full of bees and brood ready for honey gathering, do you consider it necessary to add that stock to another of same strength for extracting, or would the two stocks worked separately gather as much or more honey as when doubled? and if you advise doubling or strengthening the stocks, would a swarm, added to a stock, answer as well as doubling stocks (of course allowing only one queen)? Again, *A Modern Bee Farm*, p. 44, says, 'With prolific young queens, brood-spreading is not necessary.' As there are differences of opinion, I ask (2), Would you (having young queens) advise leaving the nest entirely to them, or cautiously spread the brood? 3. Looking at my hives yesterday morning, I noticed the moisture that had run out at the entrance of the hives had frozen on the alighting-board. Is the moisture running out of hives at entrances a good or bad sign at this time of year? and if not a good sign, what would you advise as a remedy if it is a bad sign? 4. Will you please say what quality you consider the enclosed honey is, and which (No. 1 or No. 2) is the best quality?—F. G., *Stafford, December 30th, 1890*.

REPLY.—1. You should read the paragraph referred to in the *Guide Book* in conjunction with Chap. 10 in same work on 'Doubling and Storifying,' and if it is decided to give that system a trial, work according to the directions given. Some bee-keepers succeed much better in adopting this plan than others, and therefore you might try 'doubling' on a small scale, together with the second method described in the context on page 57, and extend your practice in the direction which yields you the best results. 2. Excepting in the hands of cautious bee-keepers with experience to guide them, we do not advise 'brood-spreading,' though it is of great advantage at times to practise the plan when you thoroughly 'know how.' 3. So many things may have produced the appearance referred to, we will not venture to 'diagnose' the case. Write again if the same appearances are

seen later on, and when you can be certain it is condensed moisture. 4. No. 1 is by far the best sample of honey for flavour, but No. 2 has probably been the best in colour prior to granulating. The former is very fair in flavour, the latter not so good.

[294.] *Moth Larvæ in Top Bars.*—Please advise how to fill the crevices of the *divided top bars* which hold the foundation sheets. I find our enemies the wax-moths deposit their eggs and make a fine nest on the upper side of the frames, where the top bars are 'sawn through' (see *Record*, page 5, January, 1890), and where the wax sheets do not always and altogether fill the cuts in the frames. There they find a quiet and undisturbed corner where the bees cannot extricate them. Can you recommend some cement to fill these crevices bodily up? I have some 800 frames and shallow frames which I must seriously look to. For body-boxes, &c., I know of a very fine thing, viz., Portland cement and gas-tar mixed to the consistency of paint: but the notion is rather against my taste—and the bees', too, probably—to put it on the top of frames and wax-combs, especially as long as any smell of tar exists, and running them full of wax is rather wasting it.—J. G. K., *Grove House, Southborough, Tunbridge Wells.*

REPLY.—The split top bar is now so generally used by bee-keepers that it would appear the mischief of which you complain is not of frequent occurrence. Certainly we have had as many frames of comb through our hands as most bee-keepers, and we never had any trouble in that way. Wax-moths should have no place in strong stocks of bees. However, the trouble will be easily overcome by filling up the space above the foundation with common putty.

[295.] *A Beginner's Queries.*—As I am anxious to commence bee-keeping this year, I should be glad if you will say:—1. Do you consider the combination hive a good one for a beginner to use? 2. Which are the best bees to keep—the native or a foreign variety? 3. Is it best to commence with a swarm or to purchase a stock?—H. T. ATKINSON, *Abbots Langley.*

REPLY.—1. Personally we do not use that form of hive, but it is undoubtedly a good one. 2. Natives. 3. If you could be quite sure of getting a strong and healthy stock, with fairly new and straight combs, there is no objection to starting that way: otherwise a swarm and a new hive are best.

[296.] *Moving Bees Short Distances.*—I have bought seven stocks of bees, and they are now located about three or four hundred yards from my home; when is the best time to move them, and how should I set about the job? I do not want to take them two or three miles away, as is usually advised, if it can be avoided.—ALFRED ROWLEY, *Martley.*

REPLY.—Move the bees at once, before they begin to fly after their long confinement to the hives. As the distance is so short, a couple of

men could carry them at three journeys; and if moved after dusk on a handbarrow—or a couple of poles made to serve the same purpose—the change of location may be effected so quietly that the bees need hardly realise that they have been moved at all. Should you find it necessary to cover the entrances with perforated zinc—which is not likely—remove it the same night when all is quiet.

[297.] *Hard Bee Candy.*—1. Please give recipe for making hard candy, stating when it should be used for feeding. 2. To-day I gave four stocks short of stores a cake of candy which weighed $1\frac{1}{2}$ lbs.: how long ought this to last them? I cannot examine them this weather, but comb at top of frames seems empty, and for this reason I consider supplies must be short. 3. When may stimulative feeding be commenced?—R. DE B. SAUNDERSON, *New Ross, December 27th, 1890.*

REPLY.—Under the conditions described you should give each stock a good-sized cake of soft candy, say about three pounds in weight, and renew it as required. Hard candy is used for stimulating in early spring. 3. About the beginning or middle of March.

Echoes from the Hives.

North Leicestershire, January 1st, 1891.—My bees were in full flight on November 22nd, but have been invisible ever since until to-day, when I had to move them about a quarter of a mile. I was delighted to find them all alive and altogether void of any symptoms of distress.—E. B.

Honey Cott, Weston, Leamington, January 3rd, 1891.—It is now a little over a month since my bees had a chance to fly, and the frost has been very severe, the thermometer having one day registered 20 degrees of frost, although it has not continued at that long together. Some of the bees on the outside combs have suffered considerably. I have gone round the hives, and with a wire hook (made out of an old umbrella rib) pulled out dead bees. This afternoon there is a partial thaw, so I have looked at some of my driven lots of bees, and on which I had placed two or three of Marshall's candy cakes, and amongst them the only lot I had in a half-inch hive, and which I mentioned in my last echo. I am glad to say they are all right, and looked quite bright and lively. When I turned up the corner of the quilt, they seemed quite comfortable, and looked as though they were enjoying themselves, although they had had no chance to fly since December 3rd. I shall be very glad to see a thorough thaw, as no doubt others will the same, as the bees always seem to get on better if they are not confined more than two or three weeks at a time. Now is the time to be looking up all odd jobs and getting them done, so that all will be ready for the good time we, all hope will come, and to whom I wish a happy and prosperous new year.—JOHN WALTON.

Reviews.

Bee-keeping for Profit; or, How to get the Largest Yields of Comb and Extracted Honey. By Dr. G. L. Tinker, of New Philadelphia, Ohio.—In this little book, which contains practical information from cover to cover, Dr. Tinker explains his new system of management. He is a strong advocate of protected hives, *i.e.*, double-walled hives with the space filled in with shavings or other such protection. His experience is that in such hives one-third more brood is reared, and it is reared at a saving in stores of not less than ten pounds of honey to each colony. Bees in unprotected hives are weakened by the greater labour required to maintain a proper temperature for brood-rearing. In this way he is able to get strong colonies, which fill his two-story hives by the time the honey-flow begins. His brood chambers are large, and he does not attempt to prevent swarming, but utilizes them in a method by which he prevents increase. He works on the storifying principle, and we are glad to find throughout the book he only uses the good old English words *storify* and *storifying*, which more correctly describe the system than the modern term of *tying*, so frequently used. Early swarms, or those before the 1st of June, are treated as so much increase, and are hived, being able to take care of themselves; but swarms that issue at the opening of the honey-flow are the ones that, if allowed as increase, take largely from the crop of surplus, and are therefore dealt with according to Dr. Tinker's new system of management. At this time the colony consists of two body-boxes and supers. Should a swarm issue, the supers are taken off and also the second story of the hive, and placed behind temporarily. A new empty brood chamber is placed close at one side of the parent colony, with the entrance facing the same way. Then the brood frames are taken from the lower storey of the parent colony, and placed in this, the brood combs being replaced by empty frames with foundation starters in the old hive. On this a queen-excluder is placed, then the supers, after which the swarm is introduced. The second story removed is placed on the new brood chamber, and a cover put on, when no further attention is given for seven days. After seven days bees are shaken from their combs down in front of the swarm which is thus strengthened. In this manner comb-building and honey-storing in the sections proceeds with great rapidity, and the natural inclination of swarms to build comb rapidly is fully utilised. These are the principal features of the new management, which we recommend for trial by some of our bee-keepers. In a short notice of this sort it is impossible to give all that the book contains, but we may have to allude to it again, and in the meantime recommend our readers interested in the subject to procure the book, in which they will find much useful information.

Der Schweizerische Bienenwater. Von Jeker, Kramer, and Theiler. Published by Sauerländer, Aarau.—This is a second edition of the *Swiss Bee-keeper*. As authors it has the three leading bee-keepers in German Switzerland, which is a sufficient guarantee of the practical nature of the work. It is profusely illustrated, many of the illustrations being taken from the *British Bee-keeper's Guide Book*. The Cowan hive is there described as the American hive, an error which occurred also in the first edition. Anyway, whatever small failings of this sort there may be, the book is quite up to the times, and contains much practical and valuable information. We hope it may have as rapid a sale as the first edition has had.

Notices to Correspondents and Inquirers.

Letters or queries asking for addresses of manufacturers or correspondents, or where appliances can be purchased, or replies giving such information, can only be inserted as advertisements. The space devoted to letters, queries, and replies, is meant for the general good of bee-keepers, and not for advertisements. We wish our Correspondents to bear in mind that, as it is necessary for us to go to press in advance of the date of issue, queries cannot always be replied to in the issue immediately following the receipt of their communication.

All queries forwarded will be attended to, and those only of personal interest will be answered in this column.

C. F. PLUNKETT (Barnstaple).—*Honey and Extractors*.—We do not think there is any risk whatever of the honey acquiring a poisonous character through standing in the extractor; in fact, it is quite usual to use the cylinder of extractors as storage vats for honey, drawing it off as required. Nothing is required beyond washing the machine well with hot water before putting it away till next wanted. *Separate Entrances to Supers*.—For several reasons it is not advisable to allow bees an entrance to supers beyond that effected in the usual way through the hive.

DUNCAN GREY (Winchester).—There is no agent in this country for *Gleanings in Bee Culture*, but you can have it sent direct and post free for 1 dollar 18 cents per annum by addressing A. I. Root, Medina, Ohio, U.S.A.

J. C. (Ballyshannon).—1. A queen three years old next summer is not too old to raise queens from. 2. The young queen bred drones only because she had never been fertilised. 3. Fertilisation is sometimes delayed by adverse weather, &c., as long as three weeks after the young queens hatch. Usually, however, they are fertilised and begin to lay in six to eight days after birth. 4. A cross between the Ligurian and black is generally supposed to make better honey-gatherers than the pure variety. 5. Full instructions for candy making are printed in the *B. J.* for October 23rd, p. 514.

CHAS. H. CUNDALL.—If the unsealed syrup in the spare combs has not granulated or become unwholesome by fermentation, it will be quite suitable to give to the bees.

* * * Several letters are in type, and will appear next week.

THE
British Bee Journal,
BEE-KEEPERS' RECORD AND ADVISER.

No. 447. Vol. XIX. N. S. 55.]

JANUARY 15, 1891.

[Published Weekly.]

Editorial, Notices, &c.

BEE-PAPERS FOR WINTER READING

No. 2.—WINTERING BEES.

AUTUMN PREPARATION.—To the bee-keeper with a fair amount of practical experience to guide him, the absolute necessity for carefully preparing bees early in the autumn for the long period of inactivity and confinement before them is so very obvious as to admit of no dispute; but at the same time it will be admitted that, given a colony of bees, with a good sprinkling of young ones among them, covering ten or a dozen 'standard' frames at the beginning of October, well furnished with good, wholesome food, and they will almost defy the most careless packing and the worst form of hive for wintering in that can be imagined. Therefore it is that all our careful instructions with regard to the precautions deemed necessary for preparing bees for winter, or 'winter packing,' as the phrase goes, are just so many plans for bridging over the gap between the ideal mentioned above and the actual condition in which bees are usually found at the close of the year's operations.

It has puzzled bee-men ever since apianian doings have been chronicled to account for the curious variableness of the returns from stocks of bees located side by side in the same apiary. In spite of equal care and all-round watchfulness, they cannot make their stocks all yield alike. An odd colony here and there will return a harvest of one to two hundred pounds of honey in a season, while lives a yard or two away, with equal advantages at the start, so far as can be judged, will not return anything like one half that amount. We look at our maximum yield, and we ask ourselves, Why is it that all are not equally good? and we put forth every effort to make them so, *but we fail!* This is why the average returns in a large apiary fall so very much below the quantity got from odd single stocks here and there, and an amount of credit for exceptionally clever management quite naturally attaches itself to the owners of the latter to which they have no real claim. It is the bees and the location which yield such splendid results, while the bee-keepers' share consists in seeing that proper facilities are given for the storage of all the nectar brought in.

Plain facts like these are exactly what create the difficulty which, as bee-advisers, we experi-

ence in controverting the assertion, not seldom made, that bees come out stronger when no care at all has been expended in preparing them for winter, than after the most elaborate precautions according to modern methods. We have ourselves been taken to see a couple of special stocks in an apiary in the finest possible condition in spring, which had been wintered with no covering at all to the frames save that afforded by the part protection of a small bag made of coarse canvas, which had been loosely filled with a few pounds of Porto Rico sugar, and put on the previous autumn. The bees had fed themselves from this sugar as it oozed through the canvas on the under side, and had thriven famously on it. They had free access to the roof, as no quilts at all were used, and the result seemed to point to the folly of following any other method of preparing bees for winter than that under our eyes. Viewed, however, in the light of experience, the case before us was but a repetition of the one where an old straw skep, rotten with age and the damp position it occupied, infested with wood-lice and other objectionable things on its outside, and with a cold flag for a floor-board, was seen by us in just as prosperous condition as the above-named ones at the same season of the year. Exceptionally prolific queens and other favouring circumstances rendered these isolated stocks strong enough to withstand any amount of rough treatment, and apparently to flourish under it. But will any sane man attempt to argue that bee-keeping conducted on such lines would end in anything but failure? We trow not; and the conclusion arrived at by all who have studied the subject in the light of practical experience is that preparing bees for passing safely through winter by following out certain rules is what will yield the most—indeed, the only—satisfactory results in the end.

Then comes the question, What is the best method to adopt under all the circumstances?—and the answer is not an easy one. If we detail the course of action we have personally found to yield the best results, it looks like 'grinding one's own axe.' If we give most prominence to the plans followed by others, we become responsible for a sin of preaching what we do not ourselves practise; and so, while allowing that plans other than our own may be quite as successful, we must perforce favour the method we have found best, and solicit a trial of it. We make no claim to the merit of doing more than adapting all the good which can be

gathered from the experience of others and tacking on a few 'fads' of our own.

The first thing, then, in autumn preparation is *begin early*. So soon as surplus chambers are removed, body-boxes must be examined, and the amount of food they contain approximately computed. In making this calculation, a liberal estimate should be made in favour of the bees—too much food is far better than too little.

This point noted, no time ought to be lost in setting about giving the required quantity of food to each stock; but in the method of administering this, some regard must be paid to the season, which varies so as to require modification in the method adopted. After a short and poor season, ending sometimes with July, or even earlier, as in 1888, bees should be slowly fed from the second week of August until the end of September. On the other hand, after a good year, when honey will probably be gathered quite on till the end of August, or even into September, the last week of the latter month is the proper time to start, and any food required should then be given as rapidly as possible, in order that all may be sealed over before cold weather sets in.

There are the two methods, known as 'slow' and 'rapid' feeding, the former being carried out by means of the regulating feeders of the well-known type sold by all dealers, or, where cost is an object, by a simple substitute like Fig. 3, which any one can make for themselves.

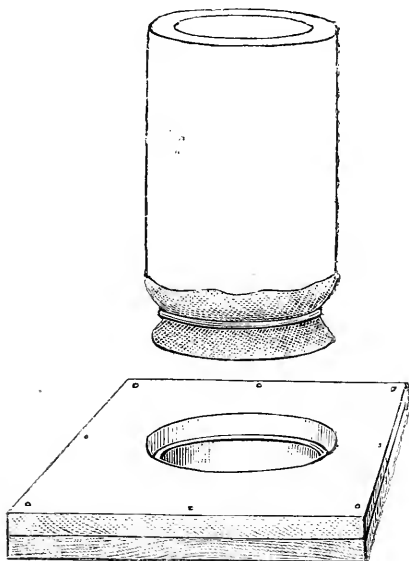

Fig. 3.

The syrup jar in this is one of the common glass jars in which 'sweets' are sold; it holds over four pounds of syrup, and costs twopence, a covering of *thick twilled calico*, doubled if necessary, preventing the bees from carrying down the food too fast. The feeding block, in

which the syrup jar stands, is made from two pieces of $\frac{3}{4}$ -inch wood, five inches square, nailed together opposite ways of the grain to prevent warping; in each of these is cut a circular hole, that on the upper side of the block being large enough to take in the mouth of the bottle easily when covered with calico, and the hole in the lower square a little less in diameter to form a ledge, which raises the feeding jar three-eighths of an inch above the surface of the quilts. When the stage is set over the feed-hole in the latter, a square of tin is kept at hand for slipping in below the jar mouth to prevent the escape of bees when removing it for replenishing.

For rapid feeding quite a different appliance is used—a good form, of the many now on the market, being that shown in Fig. 4. It is a

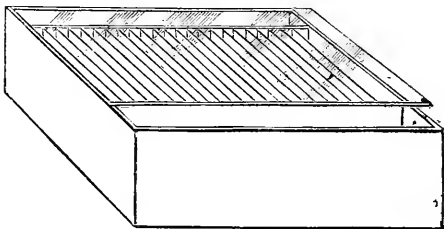

Fig. 4.

water-tight box, the centre portion of which is partitioned off into a number of compartments, on the sides of which the bees stand when feeding: thus great numbers can take the syrup at the same time, and the food when given them warm is carried below with astonishing rapidity. A $\frac{3}{4}$ -inch space on the under side of the feeder allows the bees to enter the food chamber at the end opposite the trough on the near side, into which the food is poured, and from whence it passes into the partitioned portion by a space too narrow to allow the bees to escape. The central or partitioned part is removable, and the feeder, minus this, can be used for giving scraps of broken comb, &c., for bees to clear out, the glass covering preventing any escape of bees meanwhile. Feeders of this type are made to hold from ten to twenty pounds of syrup, and when perfectly water-tight, as they should be, form an excellent appliance for the purpose, far better than the older forms of rapid feeders. In warm weather the feeder may be placed directly on the frames after removing quilts, &c., but we have found it answer so well when laid over the feed-hole, without disturbing the covering—especially with our 'top boards' in use—that we never trouble to do more than place it so; besides, it lessens the chance of an upset among the bees when quilts are undisturbed. When giving syrup rapidly in autumn a little care and caution will prevent any of the demoralisation and robbing among bees which is otherwise almost sure to result. The hive should be prepared beforehand for the feeder, and the food given *warm*. After dusk, proceed, syrup can in hand, to the hive, and pour in a teaspoonful of the warm syrup at the feed-

hole—if 'top boards' are used, we sprinkle a little on them to entice the bees up—then set on the feeder and fill to the desired amount, cover the glass with a quilt and leave it. In less than a quarter of an hour, if the job is properly done, quite an uproar will be heard at the mouth of the hive, but in the darkness not a bee will take wing, and by morning the feeder will be empty and the hive quieted down to its usual condition. So much for the manner of feeding. For the food itself, the best for autumn use is syrup made from pure granulated cane sugar (not raw sugar) in the proportion of twelve pounds to six pints of water, and allowed to boil gently for one minute. On removing from the fire, stir into this quantity of syrup a teaspoonful of salt, a tablespoonful of vinegar, and two tablespoonfuls of salicylic acid solution, or a proper proportion of such other antiseptic as may be preferred.

HIVE FOR WINTERING.—Our next consideration is the condition of the bees and the form of their domicile, together with the need for special treatment adapted for general use. We would, however, first express our conviction that no packing, or manipulation, or preparing whatever for safe wintering is necessary if all the *natural* conditions needed for the health and prosperity of a stock of bees are present. Our late friend William Raitt's words, 'The best winter packing for bees is *bees*,' will always be true; and we believe that a colony well provided with a good hive, natural food, a prolific queen, and plenty of bees, will, nine times out of ten, come out stronger in spring if left entirely undisturbed than if all the 'management' possible is bestowed upon it. But in these days of high pressure, when so few things are left 'unimproved,' we work our bees so as to get more than a natural amount of labour out of them, and in consequence feeding and a certain quantum of judicious 'coddling' become a real necessity with the modern bee-keeper. Not very long ago a general impression prevailed that bees, to winter in perfect health, must be so prepared as to allow a gentle upward ventilation, without draught, all through the close winter-time. Along with many others, we adopted this idea, and followed it out for several years; but, after trial, we have reverted to the older idea of impervious top covering and ventilating from below, owing to the saving of labour and other advantages secured therefrom, with no accompanying disadvantages that we have been able to discover. Ventilation from below, while allowing the bees to follow their own 'sweet will' in persistently stultifying all our schemes for giving it to them overhead by propolising every space, crevice, and cranny above the cluster, has proved itself to be the safest, and withal the easiest, in our hands; so we prefer it, and to secure it nothing we know of surpasses the three-inch 'eke' (Fig. 5). By its means the combs are raised three inches above the floor-board, allowing the bees to cluster, if necessary for warmth, below the combs, and causing no obstruction or stoppage of passage-

ways to the outside, even if so many as a quart or more of dead bees should accumulate on the floor-board. But along with this vacuum below

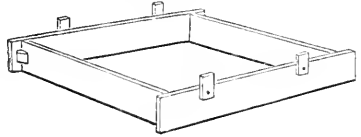

Fig. 5.

the combs there arises the necessity for doing away with the full-width entrances, now regarded as indispensable when non-porous coverings are used above the top bars, and the bees are wintered with only the ordinary distance between the frames and the floor-board; and we regard it as one of the best points in a hive with outer case that a full-width entrance and its accompanying advantages is practically secured, while the doorway to the outside, of only half an inch in width, keeps out piercing cold winds and driving snow, and guards against robbing at the same time. This point is made clear by reference to Fig. 6, which represents the floor-

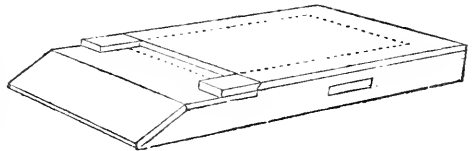

Fig. 6.

board of a hive for use with outer case, the dotted lines indicating where the eke—and on it, of course, the body-box—rests when in position; then, when the lower part of the outer case (Fig. 7) is slipped over all, the sliding entrance

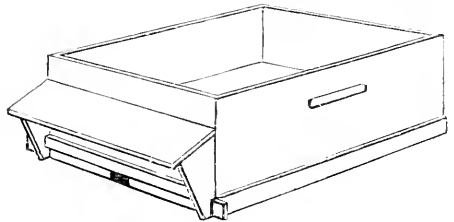

Fig. 7.

is nearly closed, as shown, and secures the desired result. In such a terribly trying winter as the present one none will deny the advantage gained in this way.

Experienced bee-men will have had occasion to observe how remarkably well a colony of bees—say a very late swarm—will winter on partly built combs. If food holds out they will hang clustering between and below the combs in a closely packed cone-shaped mass some distance above the floor-board all through the winter, and come out in perfect health and vigour in spring. This is a strong argument in favour of space below the combs in winter, but the reason for its

conducting to the bees' health is not far to seek. They pack themselves in overlapping fashion in winter, that is, each one nestles with its head and thorax tucked under the abdomen of its neighbour above, and so they utilise the warmth of that, the warmest, part of each other's bodies. They rest, as it were, on each other's shoulders, and in that position can pass the food down to the bees hanging quite below the honey cells. Of course we know that food is the fuel which maintains the life-giving heat, without which the bee cannot move, and when food fails they creep into the cells and die there. But so long as the cluster remains intact, and does not become parted by the bees shrinking closer together in opposite directions on separate combs in severe frost, the food can be and is passed round to such portions of the cluster as are some distance away from the 'cupboard.' But if the cluster 'parts,' as mentioned above, it sometimes results in whole seams of dead bees being found between combs at the early spring examination. To avoid disaster of this kind hives are usually contracted to as many frames as the bees cover at the end of October, the contracting being accomplished by removing the surplus frames, pushing all up to one side, and inserting a close-fitting dummy-board on the other.

We like to see hives full of bees from side to side, excepting the two outside combs; when this condition is present at 'packing for winter' time, there is no need to do any contracting at all until breeding is started in spring, and then only when the population has suffered severely.

AMOUNT OF BEES AND FOOD FOR WINTER.—As already said, the most important points to be borne in mind, when picturing an ideal stock of bees as regards preparedness for wintering, are plenty of bees and an abundance of good food at the end of September. To fulfil these conditions, there should be eight standard-size combs, well covered with bees, in a hive of ten-frame capacity—practically nine seams of bees, as the spaces between the two outer combs and the hive walls are seldom occupied in cool weather. The food should be stored in about eight frames; four (two on each side of the hive) being fairly well filled and sealed on both sides, and the centre four should contain not less than two inches of sealed food along the top of each comb. This will form a winter supply, weighing twenty-five to thirty pounds, which is ample for all purposes. Any uncertainty on the point of food supply can be very advantageously remedied by a cake of soft candy, weighing, perhaps, two pounds, which, if moulded in circular form, thick in the centre and tapering down—like a reversed saucer—at the edges, may be covered by the simple 'St. Beuno's' device (Fig. 8), made from a strip of an American cheese-box, as this raises the quilts in a cone shape and forms a warm feeding-place, and the bees will have food at hand, just overhead, while the candy lasts; and the nearer every stock in the apary

approaches this ideal the more likely is it to winter safely and yield good results the following season.

It must not be supposed that thirty pounds of

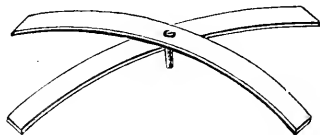

Fig. 8.

food are necessary for every stock—we have often wintered colonies well on about fifteen pounds—but where there is some approach to that weight it saves anxiety and labour in spring. Nothing is more unwise, from every point of view, than extracting all honey from brood chambers in autumn and feeding back syrup in its stead. There is no excuse for such a proceeding; it is troublesome, worrying to the bees, leads to robbing, and, moreover, it doesn't pay.

DOUBLE-CASED HIVE.—We have elsewhere expressed a strong preference for a light form of hive, with an outer casing of similar light wood and a pretty roomy space between it and the hive proper. It is just a question whether our views regarding the need for this space being filled with warm material or not will require modifying, but so far we have deemed anything beyond the simple air-space itself unnecessary. And the terribly severe winter through which our bees are now passing—unprotected by anything except the bare hives and outer cases—will surely test the point thoroughly. We never liked the littery mess a bushel of chaff or cork-dust makes when removing it, and hence our dispensing with it—so far without bad results; and if the bees are all right this year, we shall consider that chaff packing may well be dispensed with.

Just one word of advice in conclusion:—Never attempt to winter a lot of weak colonies. Six strong stocks will do far more work than a dozen weak ones; therefore, when stocks cover less than five frames in September, join two together before packing up for winter.

IRISH BEE-KEEPERS' ASSOCIATION.

The Committee met on the 6th inst. Present: Rev. Canon Sadleir (in the chair), Mr. Croasdaile, Mr. Read, and the Hon. Secretary. It was resolved to continue the free loan to members of spring crates and tins for the conveyance of honey on the same conditions as before. The annual general meeting was fixed for the Thursday in Easter week, 2nd April, at noon; and on the same day there will be a meeting of the Special Committee to inquire into the best means for combating foul brood.

BEE ASSOCIATIONS IN AMERICA.

BEE-KEEPING FOR WOMEN.

At the late meeting of the International Bee Association it returned to its first love, and is now known as the *North American Bee-keepers' Association*, embracing the United States and Canada. This Society is following in the footsteps of our good friends across the briny deep in getting local and district societies to affiliate with the National. An effort is now being made to obtain life members, and to get the society incorporated under State laws, so as to be in a condition to ask assistance from the Government, and to treat with the managers of the Columbian Exposition.

A pleasing feature at the late meeting of this Association was the presence of so many practical bee-keeping women, full of enthusiasm and love for their calling. One woman proudly told that she had extracted 5000 lbs. of honey last summer, which was a very poor one, except in some favoured localities. She was then exhibiting samples of this year's honey, and sending it to different cities in order to ascertain where the best prices could be obtained.

A lady was in attendance at this meeting who had a German girl in her employ as a maid of all work, and this girl had taken such an interest in bees that her employer purchased several colonies for her, telling her that the bees were her own, and the product from them. The girl could not attend the meeting until her work was done, but her employer attended continually, desiring to acquire all the information possible, in order to be able to converse intelligently with her on the subject. The lady explained to the meeting that they owned some lots in the city of Koekuk which she was going to give the use of to her to keep her bees upon. The girl says that she is never going to marry, but be a bee-keeper—marry bees in lieu of a man!

BEE-KEEPING FOR WOMEN.—The strong point in favour of bee-culture for women and girls is that it is something that can be performed at their own homes. It requires no great outlay of strength at one time, but the faithful performance of many little items in order to reach the goal of success. In this country (I hope that it is not so in the British Empire) women are required to accept less remuneration than would be given to men for doing the same kind of work. A woman, who was a tailor by trade, came to this city disguised in the garb of the opposite sex, and sought and obtained employment at her trade, where she served her employers satisfactorily for several months. She was burdened with a worthless husband, who followed her and traced her to the shop where she was employed, and notified the police, who arrested her. When brought before the magistrate, that worthy inquired of her 'why she dressed in men's wear?' She replied, 'I only wear it in order to obtain the same wages that they get for doing the same work.' Her employer gives her the same work to do as heretofore, but she must take

women's wages. Now, as a contrast to this, when women sell a pound of honey there are no questions asked whether the product is the result of men's or women's labour, but it is sold according to quality.—MRS. L. HARRISON, Peoria, Ill.

Correspondence.

The Editors do not hold themselves responsible for the opinions expressed by correspondents. No notice will be taken of anonymous communications, and correspondents are requested to write on one side of the paper only, and give their real names and addresses, not necessarily for publication, but as a guarantee of good faith. Illustrations should be drawn on separate pieces of paper.

Communications relating to the literary department, reports of Associations, Shows, Meetings, Echoes, Queries, Books for Review, &c., must be addressed only to 'The Editors of the "British Bee Journal," 17 King William Street, Strand, London, W.C.' All business communications relating to Advertisements, &c., must be addressed to Mr. J. HUCKLE, Kings Langley, Herts (see 1st page of Advertisements.)

* * * In order to facilitate reference, Correspondents, when speaking of any letter or query previously inserted, will oblige by mentioning the number of the letter, as well as the page on which it appears.

IN THE HUT.

'Death arriv'd,

Is passed; not come, or gone—he's never here.'

[502.] What evil fate is it that seems to attend us each year—at Christmas-time, too? Alfred Neighbour gone now. Amongst dear, kind-hearted bee-keepers who have passed away surely he holds a firm place in our memories, as a truly prominent bee-keeper first, as a kind, considerate friend, and as a man whose peaceful, unostentatious career all who knew him cannot but admire, whose steady and quiet life and work convince us that—

'God does not lose us in the dust of Death.'

Raynor, Raitt, Henderson, Neighbour; we have their portraits in our *Journal*, we have their memories in our hearts: let us keep these as—

'Green spots in memory's waste of years.'

Let us have each falling year an '*In Memoriam*' notice of men we have known and loved. I treasure now letters I wisely kept from these lost friends, thinking some day mayhap I shall value them, and now they become heirlooms. Now, as 'the dead make the living dearer; let us look forward with as bright a countenance as we can assume.

King Winter is not dead, nor old and effete. He, too, is laying his hand somewhat heavily upon the bees, as his attendant and master is upon the bee-master; but after all it is ultimate kindness to us to give us a constant steady stream of cold in the two months when mild weather would be positively disastrous to our stocks. What we want in this land of mixed climate is a continuity of seasonable weather:—

Keen winter—November, December, and January.

Mild, genial spring—February, March, and April.

Clear, hot summer—May, June, and July.

Sultry autumn—August, September, and October.

These are the bee-keepers' quarters, and given seasonable winter, a genial spring may reasonably be reckoned on. This also happening makes a hot summer almost a certainty. Who does not remember all our schemes upset in the winter of 1885-86? I refer to the *British Bee-keepers' Practical Note-book* (which, by care, lasts me four seasons at the expense of 1s.) and find the following entries:—

'Temperature of winter season:—Maximum, 52°, December 25th, 1885; minimum, 20°, March 7th, 1886—at hive porches.

'March 1st, 1886.—Heavy snow and gale: entrances and foot-boards buried.

'March 2nd.—Heavy snow and gale continued. Some bees came out and died.

'March 6th.—More snow in night, and sun-thaw in daytime.

'March 7th.—Hoarfrost on two feet of snow.

'March 7th to 13th.—Frost every night. Light snow falling on one foot of old snow.

'March 16th.—Still snowing.

'March 21st.—Grand flight of bees. Snow wasted away with ground-thaw.'

But this was a phenomenal time for snow-storms, following a mild December, January, and February, so that bee-keepers can take heart of grace and promise themselves for 1891 one of the best seasons on record. If I am wrong in my forecast, please some one cast it in my teeth in autumn. Here, in the Hut, we have had continuous winter from November 28th to January 10th, with scarcely a break from frost, and always snow on ground, whilst in Dublin I found, on January 7th and 8th, dry, mild weather had been the rule during that time, with only two slight snaps of frost. Draw a line from Dublin to Newcastle, and imagine the positions of the country reversed. North has had the weather rightly belonging to the south, and *vice versa*: London has had the climate of Thurso and Wick, and *vice versa*. We, in the north Midlands, have had the mean pivot of average, a magnificent, seasonable time.

Let me compliment your printers at last on the exceedingly good likeness of Howard of Holme Wood.

'Some said, "John, print it;" others said, "Not so;"

Some said, "It might be good;" others said, "No."—(BUNYAN.)

'X-Tractor' is sure that the sketch you give will stimulate the young bee-keeper to hope some day to achieve the same prominence. And this brings me to the felicitous change of title you now make from '*Eminent Bee-keepers*' to '*Prominent*.' Men in the front rank need not at all be eminent, and, *per contra*, many eminent bee-keepers are not prominent at all. I take it, eminence is reached by such as Huber, Langstroth (will you let me say Cowan and Abbott?), prominence by Raynor, Root, Blow, and Howard, and so on. Surely many of the portraits of '*eminent*' you have given have evoked a slight sneer with many of your readers?

Although I have no desire to join in the correspondence on the question of going down on a frosty night to 'fire up' for your bees as you would for your hothouse, I cannot help saying that when our science gets so advanced that, like 'J.G.K.' we have 'in March and April to fire up to 70°, 75°, and 80°,' there will be one Huttite at least who will prefer remaining with his feet on the fender *on the old lines*.

'X-Tractor' dreads anathematising from the editorial chair for again suggesting more trouble to you: Mark 'good bits' as the year goes on in the *B. B. J.*, and give us them in our Christmas Number (or issue a Christmas Number by itself, like other publications, something at sixpence or a shilling): such bits as the rhyme on page 19 in Mr. Woodley's interesting '*Notes by the Way*.' Your special Christmas Number might contain a photograph, almanack, weather chart, tales, and witty bits, &c., which would be very acceptable as we quaffed our cold tea, sipped the condensed milk, or sucked the acidulated drop round the gas stove at merry Christmas-time, which, being translated, meaneth roasting our corns before a roaring fire, toasting absent friends, and smoking the pipe of peace, as does—X-TRACTOR.

COMPLETING UNFINISHED SECTIONS.

[503.] I must ask you to give me a little space in your valuable *Journal* to reply to the letter of Mr. Blankley (No. 485, p. 605), and will say at once that I had not the slightest intention to question that gentleman's honesty, neither did I think that he intended to get his sections completed with syrup, or that he had any other object in view in giving his '*theory*' to the readers of the *B. B. J.* than that of furthering the cause of bee-keeping. But I would remind him that—

'Evil is wrought for want of thought
As well as want of heart;'

and I certainly think that bee-keepers should pause before they put theories in the columns of *B. B. J.* which they have not themselves tested, and which in the hands of novices and bee-keepers who have made little or no study of bees and bee-keeping may do much mischief.

If Mr. Blankley will read my letter (No. 469, p. 580) carefully he will find that I did not construe his '*theory*' to mean that feeder and sections were to be on the hive at the same time. What I said was, that 'were he to fix a feeder,' &c.—not thinking for a moment that he or any other bee-keeper worthy of the name would do so.

No, it is not Mr. Blankley, but his '*theory*' that I condemn with all the force I can command, because I am fully convinced that if put into practice it would do incalculable injury to our cause, and I wished to show as forcibly as I possibly could how it would work itself out in the hands of ignorant and dishonest bee-keepers.

I pass by Mr. Blankley's remarks as to what

he has done for the cause of bee-keeping, &c., simply remarking that there are many other humble bee-keepers who possibly have done as much as he, in a quiet and unostentatious manner, without ever thinking of 'blowing their own trumpets' in the columns of *B. B. J.* Indeed, I think bee-keepers, as a rule, are the most unselfish of men, at any rate as far as bee-keeping is concerned, freely giving the benefit of their study and experience to all who seek it.

The question at issue is, whether bees under the circumstances described will carry up the syrup into the sections; and to make the matter clear, and to help us to come to a correct conclusion, I will quote the 'theory' as given by Mr. Blankley in No. 450, p. 559, which is as follows:—'When the clover is about three parts over take off sections, place on a Canadian feeder well charged with warm syrup (possibly a strong stock would take down sufficient in one night to fill up the brood chamber). If put on at six p.m. the feeder might be removed in the morning early, replacing it with a crate of partly finished sections with no storage-room below. All must go above deck, and with warm wrappings my theory is (not "experience" yet, for I failed to find time to test it this season) that more sections would be got finished in a poor season this way than any other.'

This, then, is the theory; let us examine it. Be it remembered the idea is to fill up all empty and partly filled cells in the brood nest or body-box, so that there will be no room for the honey the bees gather from the clover, which must therefore go into the sections. Now, I say that the bees, having a quantity of unsealed syrup below, will carry a lot of it up into the sections when they are replaced on the hive: at least, I know my Welsh bees would do so. Possibly Mr. Blankley's may be of the Punic breed, which are said to do such remarkable things, and may act differently! Let us proceed to sum up the evidence as far as given, and leave the readers of the *B. B. J.* to give the verdict. Our highly respected editors say, 'Personally, we have already expressed our fears that the syrup will be carried into the sections above by the bees.' Mr. Walton, whose experience is greater than Mr. Blankley's and mine put together, says (No. 473, p. 590): 'My idea is that a lot of the syrup will be carried up from below into those sections, and if so, what is the good of being at the trouble to take them off and put them on again, &c.? Besides, what would folks say who knew what we had done?' Mr. Woodley says (No. 477, p. 592): 'This is a game that won't pay for the candle.' 'X-Tractor' (No. 481, p. 603) says: 'I would only advocate again my proposal in such cases as when the heather is "on," and to those who are dubious about the result I say, When you feed up a few days before the trip, use extracted honey.' This is a very different thing from feeding up with syrup, and he is evidently of opinion that the bees would carry it up into sections, for he proceeds

to say—'and such as is hoisted upstairs will be mixed with the heather, and give what to my mind is the *crème de la crème* of delicious honey.'

Mr. Blankley is thus left the sole parent of his 'theory,' and let us see what he says (No. 485, p. 606): 'I am quite alive to the danger there would be to a novice working on the above plan, but that might be kept in check until some safe lines had been discovered through experience. Neither do I overlook the possibility of the bees carrying up the syrup out of the brood combs into the sections. But surely that propensity of the bees may be overcome if the principle itself is likely to be an advance and help to bee-keepers. There is, to my mind, more than one way out of that difficulty.'

Now, I think Mr. Blankley, seeing the danger to novices, should have given his cheek along with his theory, and not keep it back until the mischief has been done; and that he should also have given us the way to prevent the bees carrying up the syrup. I know one sure and simple way, which I strongly advise all bee-keepers who wish to secure nothing but pure honey to adopt. It is this: Keep the syrup in the syrup can, and out of reach of the bees, until the honey harvest has been secured, when, if necessary, it may be used for feeding up for winter. Seeing that the theory has been condemned by all who have expressed an opinion, and strangled by its own parent, I have no wish, and think it quite unnecessary, to pursue the matter further, feeling sure that no bee-keeper who values his own reputation, and who wishes to secure nothing but honey of the best quality possible, will ever put it into practice. In conclusion, I would strongly recommend every bee-keeper to read and well digest the able letter of Mr. Grimshaw (No. 487, p. 606), and the 'leader' in the same number on 'Liquid Fruit Sugar,' as much of it will apply equally to feeding with syrup during the honey season. I would also suggest that one of the promised 'Papers for Winter Reading' be devoted to 'Feeding,' for I think the subject has not had the attention paid to it that it deserves in the columns of the *B. B. J.*, as there is no doubt but that much mischief is done (in most cases quite innocently and unintentionally) through errors in feeding.—CYMRO, *Builth Wells, Breconshire.*

GETTING RID OF FERTILE WORKERS.

[504.] A few days ago I procured your very interesting and instructive book, *The Honey Bee*, &c.

On page 6, plate 1, you give a drawing, illustrative of the progress of the bee from the one-day-old egg till the grub is sealed over. I am not aware that the changes in the position of the egg have ever been noticed before, and it is very interesting. In the plate in my copy of the book, the fourth-day egg, or grub, is considerably darker than the three first, and as this reminds me of an incident in one of my hives last spring, and as it may be interesting to

some of your readers I will mention it, and perhaps you will kindly give your opinion.

Early in March I watched my bees flying out and in, and from what I saw I was quite satisfied that they were healthy, and had queens. I was confined to the house for some weeks with a cold. On again looking, I found one hive in a weakly state. This was about May 1st. There were a few drones flying, and comparatively few workers. They were coming in with pollen; but they loitered at the entrance. I examined the hive. I could not find a queen, but plenty of drone brood, two or three eggs in each cell, and the large lumps of pollen were not pressed down in many cases. There may have been a drone-breeding queen; but most likely a fertile worker. I thought from the number of worker-bees that there must have been a healthy queen in the early spring. I determined to procure a half-bred Carniolan queen, and accordingly wrote to Messrs. Neighbour, who offered to send one as soon as the season would allow. I explained my position to a bee-keeper well acquainted with apiculture. He said, 'Don't get a Carinolan queen, as my hive, with a Carniolan queen, swarmed and flew right away without settling. Perhaps a half-bred one may do better; but,' he added, 'remove your hive to some distance, brush off all the bees from the combs, and return it to its place.' I did so as quickly as possible with an assistant, and in a few minutes the bees were again in their old place, having flown home. I could not discover on the short grass afterwards that any bees were left behind, but there must have been young drones. In a few days the half-bred queen came, and I decided to put her into this hive. I may here state that I kept my bees in a beehouse, two hives in each. The bees enter into two separate entrance chambers, seven or eight inches square, and perhaps eighteen inches to twenty inches from front to back. The two hives front to the sides of the two chambers, and there is a slide which can be opened or shut, so as to cut off the hive from this chamber altogether if wished.

On receipt of the queen I again examined the hive. I brushed off the bees from the combs, and they flew home; but the slide was in, and the bees crowded the entrance chamber. It was evident that a first operation, a few days before, had disposed of the fertile worker. There were no fresh-laid eggs, but there were about two inches square of dark-looking large eggs, on both sides of one comb. They may have been chilled in the last operation, or they may have been in the state shown in the Fig. 1 of my copy of *The Honey Bee*. I felt at the time the eggs had been chilled, and I hoped it was not a commencement of foul brood. However, I decided to join the new queen. The home-coming bees had not got into their hive, but were crowded in the entrance chamber. I placed the new queen among them, and she was at once fed, and I hoped all was right. I pulled out the slide, the bees at once entered, but not so the queen; she

ran about, and as I was afraid she would fly, I secured her. I lifted the lid to put her into the top of the hive, and left her for a few minutes. I found her balled, so I put on my glove, which was saturated with diluted carbolic acid, and pushed a finger in amongst them. All but one bee and the queen departed at once. The one bee returned again and again to her, but finally I got the queen caged under a pipe-cover cage on the comb and left her. In twenty-four hours I looked again; she was dead. I saw no more of the dark-coloured eggs. I then added some worker eggs from another hive, but the bees made no attempt to raise queens from them, and I then left them alone, there being still a number of workers. I joined my first swarm, and moved the hive to another bee-house. As far as I saw, none of the old bees returned; and though owing to the very bad season there was no honey, yet they became very strong in bees, and threw off a swarm in September, and in a few days afterwards a cast. As far as I remember, this has been my only experience of a fertile worker.

Later.—I would say a word in answer to your correspondent who writes on page 20 (No. 499), and has evidently misread my letter (page 613, No. 491). I am an old bee-keeper, but I have my spectacles on, and the word printed in my copy of the *Bee Journal*, December 24th, is 'course,' and not 'cause.' I have said what I think. If your correspondent in his very laudable efforts to keep his bees warm succeeds in keeping them healthy, we shall all rejoice to follow his example.—A BEE-KEEPER, PAST AND PRESENT.

MOVING BEES IN WINTER.

[505.] I moved my two hives this afternoon in accordance with your kind advice, and with as much care as possible, though they nevertheless got several knocks and shakes going through doors, &c. Consequently when they arrived at their destination one could hear a decided buzzing inside. I then made the mistake of opening the door of one of them too soon, and a number of bees crowded out, some of which fell upon the snow, resulting in the death of, say, ten or twelve bees.

Some days since I noticed that from the door of a combination hive there was quite a trickling of water, which had frozen. I therefore slightly raised the back of the floor-board, to let moisture run out more freely. To-day I found that the entrance (say one and a half inches) was nearly closed with ice, in which a few bees were frozen. On raking the full size of the entrance to about two inches inwards, I drew out quite fifty or possibly more dead bees, and they all appeared wet. I have accordingly again tilted the hive slightly forward, but in doing so I could hear a good deal of life inside. Can you account for all this wet? The coverings are three or four thicknesses of felt, and a cork cushion, say two

inches thick, and there appears no way in which wet can penetrate. Do you suggest my doing anything when the weather changes? I presume I can do nothing now.—EAST DULWICH.

[In so severe a season, there is sure to be more or less condensed moisture in a hive containing a strong colony, though it should not become so excessive as to result in blocking the entrance with ice. Keep the entrance clear, and so long as there is 'a good deal of life inside,' all will be right.—Eds.]

AMATEUR HIVE-MAKING—SECTIONS IN FRAMES.

[506.] After reading the apparently excellent advice of 'T. F. L., Brondesbury' (486) of the 18th ult., *re* 'buying body-box with dummies and frames complete, making the outer cover and floor-board oneself,' I must ask him to accept my thanks for this, to a beginner, very useful suggestion.

At page 47 of the *Guide-book* are mentioned sections $4\frac{1}{2} \times 4 \times 2$ inches. Can these be fitted into the standard frames, and, say, one body-box containing them be placed over another body-box without using crates for sections, or are the crates desirable?

I am sorry to have to ask what would appear, at least to many, perhaps, such a simple question, but as a beginner I like to start without a doubt of any kind.—RECRUIT.

[The $4\frac{1}{2} \times 4\frac{1}{2} \times 2$ -inch section is so generally used that any other size of one-pound section is now very seldom made; besides, it is found so much better to work sections either in the ordinary racks or in hanging frames made specially to take three one-pound sections in each frame, that it is not advisable to use any other.—Eds.]

CHEAP HIVES AND APPLIANCE DEALERS.

[507.] Referring to No. 495 (page 10), as 'the proof of the pudding is in the eating,' I have written by this post to Mr. J. H. Howard, instructing him to send a 'W. B. C.' body-box in the flat, with frames, &c., by parcels post to 'G. J.,' and I will let you know the cost, including postage.

I hope that 'G. J.' will do me the favour of accepting this hive (or rather body-box), and will let me know from actual experience what he thinks of the suggestion I made in my last letter.—T. F. L., Brondesbury.

Later.—Mr. Howard reports that he has sent off the 'W. B. C.' body box to 'C. J.' by parcel post, and the cost is 3s. and 1s. $1\frac{1}{2}$ d. postage—total 4s. $1\frac{1}{2}$ d. for hire in the flat with necessary nails, also frames, &c., complete.—T. F. L., Brondesbury.

[Our correspondent demonstrates his confidence in the soundness of his advice in very practical fashion; and we are glad to know that the sample box he sends for 'G. J.' to deal with is going into such good hands.—Eds.]

BEE-KEEPING NEAR TOWNS.

[508.] Passing strange it may appear, yet the sentiments expressed by 'Amateur, Newcastle-on-Tyne,' *re* what Mr. 'Useful Hints' might have to say at Christmas-time, are an echo of my own. Every week I look forward and anticipate the arrival of my *Journal*, and each issue seems to add a little to my 'small' knowledge of bee-keeping.

A friend of mine and I were having a chat the other day on bee-matters. He made a remark anent his knowledge on the subject which I thought pregnant *re* apiculture, viz., 'The more I know, the less I know.' It is some consolation to know we have a *Journal* now within the reach of all where he that runs may read.

But I am digressing from the point uppermost in my mind now, and has been since I read letter No. 496. It is this. Knowing Newcastle and its suburbs fairly well, I wondered in what part of the 'Northern Metropolis' are his pets kept. I have wandered along the moor edge and Jesmond Vale, also on toward Bentick; never a hum heard nor a bee have I seen. Living out here in the country one cannot realise the fact of any one keeping bees in Newcastle, the surroundings seem so unfavourable. Perhaps in the future he may favour us with an account of his success, and give us a little hint as to the locality of his apiary. Very heartily do I wish him every success and good luck in 1891.—ROMAN WALL, *Haltwhistle.*

IS MEAD-MAKING ILLEGAL?

[509.] Would you kindly oblige by stating in the *Bee Journal* if bee-keepers are legally allowed to make mead of their honey, as the exciseman here informed me it is not lawful to do so, and that he should come down upon any one and fine them for making mead. I want to know if it is right or wrong?—H. LANGDON, *Godshill, Isle of Wight.*

[We are not aware of any excise officer in these realms ever before displaying such anxiety for the revenue of our good lady the Queen, as to threaten pains and penalties to the humble bee-keeper who would fain discourage the publican's trade by making his modest glass of mead at home, from the produce of his own bees. Is your friend the exciseman a descendant (in the direct line) of Shakespeare's 'Dogberry?' or has he become dyspeptic through partaking of something stronger than mead at this festive season? In any case, make your mead, and drink it too, in peace. We should like to see the name of the magistrate who would convict for so heinous an offence as this; and if you *are* convicted we will gladly pay the fine if you will allow us to do so.—Eds.]

HOUSE APIARIES AND A NEW DEPARTURE.

[510.] Many thanks for your foot-note on page 20 with regard to my mistaking the word 'course' for 'cause,' and also for drawing my attention to it. There is also another mistake,

made perhaps also in consequence of my being a foreigner writing in a foreign language. It is in line ten from the finish, and should have read 'not'—i.e., 'the results of their *not* clustering are,' and again on p. 20, *bee-hive* should read *bee-house*, which makes all the difference in the meaning.—J. G. K., *Grove House, Southborough, Tumberidge Wells.*

NOTES BY THE WAY.

[511.] The weather in this district up to the present continues cruel. Wind remains steady in north and north-easterly quarters. The frozen snow, drifting into hollows and filling lanes and roads that are across the current of the wind, makes locomotion very difficult; sleighs travel on the hard frozen snow much easier and better than traps, and some of our leading lights are driving them. One, I hear, has driven along the frozen surface of the Kennet at Hungerford; and the Thames is frozen over at Abingdon. This has not happened before since 1813-14, though severe winters seem to run in a cycle of about ten years and at the close of each decade. The years 1860 and 1870, 1880 and 1890, have all closed with hyperborean weather. Can any of your readers give their experience of the honey seasons following these periods of intense cold? I notice in the *Bee Journal* for July, 1881, in the 'Editorial Notices'—'Honey everywhere,' and I expect that the Editor of the *B.B.J.* then, as now, was behind the scenes, and knew what was going on amongst progressive bee-keepers from Land's End in Cornwall to John-o'-Groats.

Clear the gangway! The entrance of every hive in our home apiary has been kept banked up with light, porous snow, especially those that felt the keen wind sweep the alighting-boards. This must add to the comfort of the inmates when the weather is so very cold; but when a thaw sets in, with a possible return of frost during the night, then we shall want to attend to the entrances, or probably the entrances may get frozen up with ice from the melted snow; also on the first change don't omit to clear out any dead bees that may block up the entrances of the hives with the usual wire bent at one end.

Mice.—Those who still have bees in skeps will do well to take off wraps and hackles when a thaw comes, and see if any mice have chosen the warm, snug quarters offered under hackles, &c. These must be trapped, or before the winter is over they will be eating through the skep and destroying the colony.

Selling Honey.—Having been written to re this question must be my excuse for referring to the subject so shortly after a previous note relating thereto. I think the best answer I can give to the question is—Aim at a high standard of commercial integrity; that is, always send in the bulk of an order equal, if not superior, to the sample. This will inspire confidence between buyer and seller. Don't, if you wish to

hold your customers, put all the best sections at the top of the case; or if in open-sided travelling crates, don't put all the best-filled ones of the whitest capping next the glass, but let the whole be of uniform quality. Don't forget that a pleased customer is one of the best and cheapest advertisements you can have. Don't forget that your large customers, as a rule, buy to sell again, and if inferior sections are sent to them, they will have to be sold at a cheaper rate to clear. This means loss of confidence between the contracting parties, and is not likely to lead to business another year. For myself, I would rather hold one old customer by mutual confidence than gain two new ones whom I did not know anything about and have to deal with them on the 'deposit system.' These remarks leads on to the only system that can inspire that confidence referred to above, and that is, grading your honey. At the end of the honey harvest all the produce should be graded, a system I have practised from my first start in bee-keeping. I have as first grade all well-filled sections of good colour; as second grade, sections sealed both sides, but not so well filled, and any that are of a darker colour; and as third grade, sections that are sealed perhaps on one side and not completely on the other, and those sections that weigh just over twelve ounces. These lower grades, of course, are not uniform in colour, and have to be sold for what they are worth: this can be easily ascertained by balancing a piece of board on the scales and weighing them in dozens, then charge fairly according to weight, colour, and quality.

Cleansing Flight.—Our bees after this long spell of frost will need a cleansing flight; and as a preventive to wholesale destruction, it will be a good plan to sweep the snow away for a distance of a few yards in front of the hives, if it is not melted before the bees begin to make an appearance. When bees alight on the snow—attracted, no doubt, by its whiteness—they seldom rise again, or if they do, it is only to settle down again a short distance away, and after a few struggles, die from chill. But if the ground is clear of snow, and they alight on the ground to rest, they rise again and reach home all right.—W. WOODLEY, *World's End, Newbury.*

Queries and Replies.

[298.] *Moving Bees.*—Will you kindly tell me:—1. Whether it is safe to remove my bees at this time of the year? It seems that they will have to be taken from their present locality, as the person who cares for them is leaving her house. 2. If not safe to remove them now, when? 3. What is the safest mode of removal?—G. B., *Craven Terrace, W.*

REPLY.—1 and 2. After so long a frost the bees may be removed, for preference, at once. If they have had a few airing flights before it is convenient to change the location, the chances

of losing bees are greater. 3. The *safest* way is for two men to carry the stocks singly on a hand-barrow, or a couple of poles pushed below between the legs.

[299.] May I ask a word of advice concerning my two stocks of bees? I opened them up the other day and found a large number of them dead on the floor of both hives—maybe 100 in each hive. I fed them up each with twenty pounds of syrup, and plenty of clothing.—A SUBSCRIBER, *Pontypridd*.

REPLY.—There is no cause for alarm: the dead bees indicate no very high death-rate for so severe a season.

Echoes from the Hives.

Bridgham, Harley, January 10th.—My results this last season were as follows:—I had ten hives (holding thirteen frames each) including one swarm. I had them carefully watched, and every swarm except the aforesaid was taken and replaced at night. I have tried every possible way to prevent swarming, but the only successful way, I find, is to be patient. I replace the bees as often as they come out. Three of the hives came out three times each, two came out once, and the others not at all. They required very little feeding. I only had twenty-five pounds of sugar throughout the year. I extracted honey round the brood nests continually up to the middle of July, the total result for the season being 570 lbs.—viz., 167 completed sections and 403 lbs. from the extractor. I have only one super on each hive, and never kill the queens, either when returning a swarm or when adding bees from villagers' skeps in the autumn, leaving them always to fight it out. Last year (1889) I took just over 1000 lbs. from the same ten hives. The chief secret of success in bee-keeping, in my opinion, is simply constant attention.—WILFRID BLUNT.

IMPORTATION OF FOREIGN BEES INTO GERMANY.

LECTURE GIVEN BY MR. DENNLER AT THE APICULTURAL CONGRESS HELD AT STRASBURG.

The President invited Mr. Dennler, of Enzheim, to give his address on the importation of foreign bees into Germany.

'I chose for the subject of my address,' said Mr. Dennler, 'the importing of foreign bees into Germany, since of late this question has again been raised by Mr. Weygandt, a pastor of Hesse, and because it is of great importance to our bee-keeping. Every year thousands of marks are sent out of our country to purchase foreign bees, and generally for the purpose of repairing the losses that have been suffered. Is the German bee, then, degenerated, weakened, and incapable of producing lucratively?'

'Let us first consider the origin of the dif-

ferent kinds of bees, and then perhaps we shall find the solution of this question.

'According to the opinion of some entomologists our "honey-bee" is a native of India, whence some thousands of years ago it undertook a kind of emigration towards the west, to spread itself partly in Europe and partly in Africa.

'Let us now follow those bees that chose Europe for their country, of which some established themselves in pushing forward successfully towards the mild, temperate shores of the Mediterranean, where they were favoured by a sky always blue and a delicious flora; whilst others chose for their home the sides and valleys of the high mountains, such as the Styrian Alps and those of Carniola, where little by little they became accustomed to a climate more severe; others still peopled the great plain of Central Europe, from the steppes of Russia as far as France and England.

'Climate, habits, and other local conditions have, in course of time, exercised a certain degree of influence on the qualities and exterior characteristics of our winged travellers. In the sunny countries and in the islands of the Mediterranean the colour of their bodies has by degrees become lighter. From these originated Italian and Cyprian bees, whose activity has in reality been much praised, but which, on the contrary, conforming to the irritability of character of the southern people, can be terrible in their anger, especially the Cyprians, who use their stings like little demons, and often put to flight bee-keepers who are engaged in removing them.

'In the Austrian Alps we find the birthplace of the present race of the Carniolan bee, with grey body, and which is distinguished by the great fertility of the queens and by its gentleness of character.

'The native bee, called German, which dominates the whole of the central plain of Europe, is well enough known to us, a part of this race having already, from the earliest ages, found its way beyond this limit towards the northern regions, where it has since remained, in spite of the most unfavourable conditions of climate.

'It is only fifty years since Dr. Dzierzon introduced the first Italian queen into Karlsruhe. This Italian, of a light yellow colour, had decidedly captivated the grand-master of bee-keeping, and from that moment the Italian bee became a favourite. In a short time the whole of his apiary became Italianised, and sufficiently populated to allow him to furnish all the countries of the world with Italian queens of his own rearing. At this time there was a real craze for Italian bees, and everybody wished to have some in their apiaries; it was even quite the correct thing to have at least one hive of pure Italians.

'There is no need to refer, especially in Germany, to the notable services rendered to the study of natural sciences by the introduction of this fine race of bees, and we are full of

gratitude to the honourable grand-master bee-keeper for the disinterestedness he showed in this connexion.

‘But as to the superiority of Italian bees and of their crosses with the German bee, in respect to production, such a pretension has been in advance of proven facts. I might just as well pretend, and perhaps with still better right, that had the German bee been introduced into Italy, it might perhaps be more fertile and more active than the Italian bee, already enfeebled by the mildness of the climate. Also, do we not see plants and animals, natives of northern countries, succeed better in southern regions than those which, on the contrary, were transplanted from the mild climate of the south to the colder regions of the north? Why should not the same thing take place with bees? If our German bee is really capable of improvement, it would be better, perhaps, to use for this purpose, as M. Weygandt recommends, the bee from the most northerly countries or even those from the Carniolan Alps; and these climates being more severe and colder than that of Germany, they could bear our winter more easily than the Italian or Cyprian bee, which is accustomed to mild winters and very hot summers.

‘With respect to the much-boasted fertility of these foreign races, this circumstance arises most from this fact, that the queen-dealers only provide young queens, one year old. Why do we not renew our queens also every year? Why should we not make use of the lesson the dealers have given us? It is to you, gentlemen, that I leave the answer to this question.

‘As to myself, my opinion is this, that the native bee cannot be more active than it really is. If the number of hives is constantly decreasing, the fault certainly does not lie with our native bee, but rather with the bee-keeper, who, always following the old routine, does not know how to keep up with the times. However, we can find the same inconvenience in many hives of Carniola or of Italy, because all the bee-keepers there do not call themselves Ambrozie or Sartori.

‘The ignorant bee-keeper, said our honourable President, Mr. Bastian, in his writings, is the bee’s greatest enemy, but the real faults are very often put to the account of the German bees, and when, after bad management, they cannot get through the winter, they say that they are old and worn out, and that they must get some new blood from Carniola, Italy, and who knows where! In this we do a great injustice to our bee, which is so courageous. Our native bee is neither degenerated nor unprolific, as is sometimes said. Our native bee is as gentle in character as those of other races, provided that you know how to treat it properly, and at the proper time. Our native bee merits still today, as in times gone by, to be considered as the symbol of activity.

‘From that you must not infer that by interchanging German bees with other races you cannot attain good results; but a beginner must not imagine that without importing foreign bees

and without cross-breeding a rational bee-culture is impossible. The best proof is that the bee-keepers of Carniola and of Italy do not go in for cross-breeding. On the contrary, they abstain from it, and keep their races as pure as possible. Good reasons dictate this method to them. The more simple the art of bee-keeping, the more popular will it become, and so much the sooner will the wish of M. le Pasteur Baelz be realised, viz., to find a pot of honey in every household.’

Notices to Correspondents and Inquirers.

H. E. WALLER, (Highbury).—*Condition of Bees after Long Frost.*—Assuming your description of the contents of the ten frames to be quite accurate, the hive should have had in it (on October 4th) between 30 and 40 pounds of food. This, with nine full seams of bees and brood on six combs, makes up an exceptionally good stock for that time of the year. One hundred and seven dead bees on the floor-board on January 5th, after the long frost, is not at all an alarming quantity, and you may be quite easy as to the bees being all right.

EAST DULWICH.—*Moving Bees 100 yards.*—Move the bees at once before the frost is gone. As you have but two stocks it may be done after nightfall, and if such a hive is carried carefully by two persons the bees need not be disturbed at all. You need not even trouble to close the entrance, as no bees will be likely to take wing.

AMATEUR (Bath).—The bees sent have evidently died in the ordinary course, and the paper received contained only particles of old pollen cast out of the cells by the bees. The subscription for our monthly, the *Record*, is 2s. 6d. per annum, post free.

W. F. SHEPPARD (Woodford).—*Views and Descriptions of Large Apiaries.*—We have received several photographs of apiaries kindly sent from time to time by readers, and have under consideration the advisability of reproducing them in our pages. A serious difficulty, however, exists in regard to your suggestion as to ‘description’ beyond the photo-engraving. In that, to do impartial justice, we should require a special correspondent to visit each place; but we will see what can be done to overcome this.

JOHN SMITH (Cumnor, Oxon).—*Bees Flying in Winter.*—There must be something radically wrong when the bees of one particular stock fly out in numbers in such weather while all the other colonies are quiet. Of course it is possible that the bees—being driven lots joined in autumn—may be less quiet under the influence of a little sunshine than stocks in normal condition; but we should advise an examination the first warm day if the unseasonable flying continues.

THE
British Bee Journal,
BEE-KEEPERS' RECORD AND ADVISER.

No. 448. Vol. XIX. N.S. 56.]

JANUARY 22, 1891.

[Published Weekly.]

Editorial, Notices, &c.

OUR PROMINENT BEE-KEEPERS.

No. 30.—MR. JOHN LOVE.

We have much pleasure in giving this week the portrait and a biographical sketch of the veteran bee-keeper, Mr. John Love. Born in the village of Kilbarchan, Renfrewshire, on 10th April, 1806, bred a hand-loom weaver, as were his father and grandfather, three Johns in line, he may be said to have been a born bee-keeper, as he remembers a saying of his father's, that in the old garden the hum of the bee had been heard without a break for sixty years. Of middle height, fair complexion, with high colour, the fringe of pretty, fair, silky hair below his wide-awake behind, this 'yellow-haired laddie' of eighty-five summers is frequently taken by the stranger as wearing on to seventy. Still remarkably nimble and fleet of foot, of a very amiable disposition, his laugh is as happy and jubilant now as I believe it to have been when, a boy of nine, he remembers listening to accounts read from the papers of the glorious victory of Waterloo. For many years an exemplary Presbyterian elder, growing deafness (his only infirmity) prevents him now from performing all the duties of the office. So healthy has he been that only once during his



MR. JOHN LOVE.

long life, for a fever, has he required medical advice. He married, 12th August, 1833, Mary Climie, daughter of a weaver's agent in his own village, and has been blessed by a numerous offspring.

A few years after his marriage the subject of our sketch moved to Mount Pleasant, beautifully situated on rising ground above the village, and occupied jointly with his brother-in-law, the

upper flat as their dwelling-house — workshops below, a good garden behind. The passer-by could not but be attracted by the bee-house, a neat model of a two-storied dwelling-house, complete to the sweep on the chimney. The numerous odd hives of the two dwellings were cosily placed in sheltered nooks under the many grafted fruit-trees. The floral display of roses, herbaceous plants, &c. was very fine: but in their season the bed of pinks was the great attraction. Mr. Love for many years was the acknowledged Scottish champion 'pink' grower. Upstairs his stuffed specimens of natural history reflected great credit on our friend's

taste and neathandedness in another direction.

It has been recorded in these pages long ago, when the Italian bee was newly imported, how a petition was couched in respectable verse from the Kilbarchan fraternity for leave to inspect the new bee: the writer of it was Mr. Robert Climie, Mr. Love's brother-in-law. Alas! that deputation has all passed away save Mr. Love. Curious how the poetic vein descends, coming out in

the children and grandchildren of Mr. Love. Robert Climie's end, some twenty years ago, was very affecting. He was invited over to a neighbouring village to examine the bees of a married daughter of Mr. Love. A non-smoker himself, he administered a whiff of the pipe, said to his niece he felt sick, and would never touch that vile pipe again, retiring to an inner room, where she in a little while found him kneeling by the sofa in prayer, in which posture his gentle spirit passed away. The funeral was largely attended, service in the open air, a beautiful spring day, the woods of Glentyan across the strath, and the village nestling in the hollow, bees out in force—very touching to bee-keepers present to see his little favourites hover over the pall and odd ones resting on it, as if taking a long farewell of the old master ere his remains were borne away.

Time brings its changes, the kindly old Laird dies, the estate is sold, and Mr. Love after an occupancy of thirty-eight years has to move his looms into the smoky atmosphere of the town of Paisley, where he and an unmarried daughter bravely struggle on, plying their shuttles side by side. In the interim, first the partner of his joys and sorrows, then his youngest and fairest flower, droop and die. Gladly he accepts an offer to take charge of a cottage and pony, grow and dispose of a large fruit-garden crop in the island of Bute. Rarely do we find a man at seventy-six so cheerily abandon his life-work, and begin to earn his bread by his hobby.

In the autumn of that year, 1881, the writer sailed to Bute and made the acquaintance of that steep ascent, the serpentine road, resting to gaze on the beauty of the grand prospect: Rothesay Bay at our feet, Joward Castle on the opposite shore, the glassy smoothness of the far reaches of the Kyles of Bute in the rugged distance.

The hill-top is at last gained; there, bare-headed as usual, busy among his strawberries, stands our hero. The joy at meeting! 'Why, John, you look like an old eagle perched on this hill-top!' The bees and honey prospects are discussed, and the tremendous crop on his gifted young Caledonian plunn-trees presented by John; a branch promised and hamper followed. By return of post the hit-off thanks:—

'Through wind and rain your basket came
In safety—it is here.

'Twas careful hands that packed it
With its richly-laden store.

I never can repay you.

But I thank you o'er and o'er,
For there are deeds of friendship
Words may not all impart.

Their sterling worth, as deep they sink
Into our inmost heart.

Then, once again I thank you
From here, my mountain home,
And, one and all, I wish you joy
In the year that is to come.'

I gave him an introduction to my good friend Miss Macdonell, of Glengarry, and he assisted her

with her bees, and that lady, in the kindest manner possible, presented him with a couple of swarms, and he was once more into stock, whose descendants he still carefully preserves. The above lady takes an enthusiastic interest in the bee and the silkworm. A handsome mahogany rotating observatory ornaments her drawing-room, and the suppers from her gigantic Stewarsons overtopped everything at the Rothesay Exhibition. She also takes a warm interest in the cause of religion and education, in maintaining the purity of worship in the National Church; is thoroughly practical, projected and supports an Initiatory School where poor boys are taught the ground-work of religion, besides the ability to sew on buttons or patches on their jackets. At the School Board she has sat for nearly six years, the only lady, and heroically defends her position with as much determination as did her illustrious uncle the gates of Hougoumont at Waterloo.

Three verses are extracted from a letter of Mr. Love's on another occasion:—

'I will whisper my tale to the Yule-log
As I muse in its ruddy glow,
As here again comes Christmas,
With its holly and mistletoe.

* * * *

'Yes! that is the tale I whisper,
As I muse in the firelight glow,
As I sit, in the hush of the evening,
And think on long ago;

'On the happy home of my childhood,
On the friends I held so dear:
One by one they have left us,
They are no longer here.'

After a five years' residence in Bute he comes back to Kilbarchan, and the bees and pinks are safely flitted to his present garden. After the labours of the week are over, it is a much-anticipated pleasure on the Saturday half-holiday, skimming over the four miles that part our dwellings. The newest ideas in bee-keeping are discussed, the last bed of pinks planted by himself seen to, and the latest-come herbaceous plant criticised; and if in autumn the fruit-crop is peculiarly interesting—those 'Bouquet trees,' the waxy purity of the white 'celestial' apple, flanked on either side, same tree, by branches of the scarlet or striped varieties successively. He often ejaculates, 'It bates a! How comes such heavy crops?' 'Your good grafting and the fertilising powers of our little friends, the bees.' 'Nae doot, nae doot!'

One fine Saturday afternoon autumn was a twelvemonth, we were favoured by a visit from 'Our Editor,' pointing out to him how 'history repeats itself,' our old Japanese lion, worshipped for 3000 years, had been peopled that season by a colony of humble-bees as Samson's was, the subject of our sketch arrived, and the pleasure of that introduction he will never forget.—A RENFREWSHIRE BEE-KEEPER.

USEFUL HINTS.

WEATHER.—Still King Frost holds every thing in a grip of iron, the few ‘threatenings’ of a change having resulted in the partial disappearance of the snow for a time, only to be followed by another ‘fall’ and more frost. We can hear of bees having had a ‘flight’ here and there, and as a result of this a good many parcels of dead bees have been received from correspondents, who are generally in a state of considerable uneasiness at what appears to be an abnormally heavy mortality among their stocks. They overlook the fact that we recorded a temperature of 27° below freezing on the afternoon of November 28th last, and that—in the south and south-east of England, at least—there has scarcely been a break in the frost now for sixty days! during the whole of which time bees in many parts of the kingdom have never seen the outside of their hives. How long it will last none can tell, but it is not an encouraging sign of a ‘break up’ to learn that at Norfolk the thermometer on the 18th inst. registered 27° degrees below freezing-point; on the grass, at the same time and place, it was only a shade above zero. So long a spell indoors as this, and not a single dead bee carried out in the meantime, is sure to result in an accumulation of dead in many cases which, under ordinary conditions, might mean serious mischief. As it is, however, there is no special cause for alarm. The chief consideration is to get the accumulations on floor-boards—consisting of dead bees, or the *débris* from uncapping of food, or both—cleared away, so that no choking up of entrances may occur; in properly constructed hives the orthodox bent wire will accomplish this. When all is cleared from entrances, floor-boards, &c., and in very suspicious cases a glance got at the bee-cluster, to see that it still exists *as* a cluster, the bees may again be allowed to go to rest till outside warmth arouses them to activity once more. So keen has been the frost that we hear of entrances being blocked with ice formed from condensed moisture ‘from the inside.’ There is something wrong about the ‘inside’ when this result is brought about, and it will be well to guard against such a contingency by tilting hives a little forward, so that any wet may pass freely away until an examination can be made.

FOOD AND RISKS OF STARVATION.—As we have already said, it is quite impossible to forecast when a change in the weather may be expected; we see the Thames covered each morning with masses of floating ice, and read of a gentleman driving tandem across the water in a London park the other day, so that present appearances point to a continuance of hard winter weather for some time yet, and there is real cause for uneasiness when bees are relying, as some are, almost solely on candy-food for their daily supply, while the said candy is as hard as a stone. Not an hour should be lost in guarding against disaster from causes like these. If the chance occurs of an hour’s airing flight, advantage must be taken to remove any stone-hard food, and replace it with properly-made soft candy, which bees consume almost as readily as they could chocolate cream. In other cases relief from impending hunger risks may be given by a comb containing sealed food being moved from the outside nearer to the centre. In doing so care must be taken not to divide the cluster of bees when inserting the frame of food; place it so that the outer seam of bees are directly in contact with the food, and if the surface of the latter is either bruised by scratching, or the capping cut away altogether, they will soon remove the food to the centre of the cluster to be ready for use.

That the extreme severity of the present winter will try the vitality of bees as well as the efficacy of the measures taken for their safety cannot be doubted, and it will be an anxious time for most readers until evidence has been forthcoming that stocks are all right. The necessity, therefore, for a careful watch being kept on the first flight-day for any stocks which appear perfectly still while others are busy is so apparent as to need no urging. A day’s delay may mean death to the colony, while a few minutes’ labour judiciously spent on it may preserve it sound and strong. Nothing in bee-management is more annoying than to find a strong stock dead through sheer carelessness, and yet such cases too often happen to permit of the risk being unnoticed.

DYSENTERY AND RAW SUGAR FOR SYRUP-MAKING.—If anything were wanted to convince bee-keepers of the folly of using unsuitable sugar for syrup-making it, would surely be found in the sad condition in which some stocks are just now. It is

not for us to say how it comes that, in spite of our continual warnings, some readers have used sugar for syrup which is utterly unfit for the purpose. They are induced by grocers to try it, and do so on their assurance of its being genuine cane sugar—which no doubt it is, but several samples received are so full of molasses as to be almost black. The natural consequence of bees existing on syrup made from this would be bad enough in an ordinary season, when frequent opportunity offered for a cleansing flight; but long confinement on such food will inevitably cause bowel-distension, fouling of hives and combs, and too often death! We are thoroughly convinced that dysentery among bees is a preventable disease, and that nothing more is needed to avoid it than careful attention when making syrup for bee-food—using only pure granulated cane sugar, from which the molasses has been refined away, to boil it for a minute, and also avoid ‘drowning the miller’ by over-watering. This, and the exercise of care and a little common sense in preparing for winter, has enabled us to keep bees for twenty-five years without ever having had a single case of dysentery among them yet. Where the disease is present in pronounced form through improper food, a change into a sweet, dry hive, and to fresh combs if possible, and good freshly-made syrup, given warm, or a cake of *soft candy*, are the only remedies.

THE ‘ROYAL’ SHOW AT DONCASTER.

The Royal Agricultural Society of England holds its annual exhibition at Doncaster on Monday, the 22nd of June next, and four following days. We invite the attention of readers to the prize list for the bee and honey department, which appears in our advertisement columns this week. The list has again been revised by the Committee of the British B.K.A., and a large increase in the value of the prizes made in some classes. We therefore hope to see a good entry, and, more than that, a good display of bee-goods as well as honey.

TO CORRESPONDENTS.

We take this opportunity of thanking the numerous friends who have been good enough to forward the season's compliments and good wishes for the new year, and to very cordially reciprocate the same. If half the success wished for the weekly and monthly *Bee Journals* is realised in the current year we shall be very thankful, but whether this be so or not we shall hope to deserve all the good fortune wished us.—Eds.

LIQUID FRUIT SUGAR.

We have received from the importers of liquid fruit sugar a further communication referring to the article on the subject printed on page 597 of our issue for December; but as nothing new is advanced in the letter, we see no reason for publishing anything further with regard to it.

LEICESTERSHIRE BEE-KEEPERS' ASSOCIATION.

A Committee Meeting was held in the Mayor's Parlour, Old Town Hall, Leicester, on Friday, the 9th, to consider the doings of the past year and arrange the annual report. After carefully going over the details of the work done, it was gratifying to learn the year had been more favourable for the Association than for several seasons past, and that the financial affairs were in a better condition than had been expected.

Mr. W. P. Meadows read a pleasant report in a local paper respecting their former respected Secretary, Mr. E. Ball, in which that gentleman was, on his retirement from the mastership of Waltham School, presented with testimonials from the inhabitants and from the past and present pupils of the schools. All present wished Mr. and Mrs. Ball health and strength to enjoy many years of comfort in their new home. They much regretted his absence there that day, and that their funds did not allow of the Society presenting him with a substantial testimonial.

They also hoped the sound practical advice given and signed ‘E. B.’ from North Leicestershire in the *B. B. J.* would continue, if from another district.

KENT BEE-KEEPERS' ASSOCIATION.

The annual meeting of the members of this Association was held on the 13th inst. in the Board-room of the Royal Society for the Prevention of Cruelty to Animals, which was kindly lent for the purpose. The attendance was small. The Rev. F. T. Scott occupied the chair. The report and balance-sheet, duly audited, were read, the latter showing a balance in hand of $\text{£} 2s. 6d.$ The income of the year showed a falling off of $10\text{£} 4s. 1d.$; nevertheless, much useful work had been performed, and the prospect of progress in the early future was promising. During the year the Association had been instrumental in bringing about the apiarian exhibition at the Bath and West of England Society's Show at Rochester, which resulted in a thoroughly successful manner. Lectures had been given in several districts of the county, and fresh interest was stirred up. The apiarian competition between members of the cottager class in the district of Hawkhurst was repeated, and the result was recorded that in a year generally looked upon as unfavourable for bee-keeping the first prize was taken by an agricultural labourer with an average of fifty-six pounds of honey, he being the owner of (spring count) six hives of bees. Foul brood

was still working destruction in many apiaries, but its ravages would seem to be concentrated in fewer localities than in previous years. The President chosen for the ensuing year was Lord Northbourne, and the Committee and officers were re-elected.

NOTES BY A VILLAGE BEE-KEEPER.

Mr. Matthew Freeman, of Slinfold, a well-known and worthy cottager bee-keeper, sends us a few notes of his bee-work in the past which are worthy of being recorded, as an incentive to others in his station of life to go and do likewise.

Mr. Freeman's first statement tells how he established a swarm in a skep in the year 1874, and at the close of 1883 (ten years later) the same skep had yielded a profit value of £1. 10s., or over 30s. per year. Another return details how twenty-five bee-keepers, all residing within two miles of Slinfold Parish Church, took a total of 2188 pounds of honey, besides increasing stocks to the extent of ninety-four swarms, and securing thirty-one pounds of beeswax in the year 1885. Bearing in mind the fact that all the persons whose names appear in the list are simply amateur bee-keepers, owning (except Matthew himself) only a few hives each, a result like that given speaks volumes in favour of bee-keeping.

Correspondence.

The Editors do not hold themselves responsible for the opinions expressed by correspondents. No notice will be taken of anonymous communications, and correspondents are requested to write on one side of the paper only, and give their real names and addresses, not necessarily for publication, but as a guarantee of good faith. Illustrations should be drawn on separate pieces of paper.

Communications relating to the literary department, reports of Associations, Shows, Meetings, Echoes, Queries, Books for Review, &c., must be addressed only to 'The Editors of the "British Bee Journal," 17 King William Street, Strand, London, W.C.' All business communications relating to Advertisements, &c., must be addressed to Mr. J. HUCKLE, Kings Langley, Herts (see 1st page of Advertisements).

* * * In order to facilitate reference, Correspondents, when speaking of any letter or query previously inserted, will oblige by mentioning the number of the letter, as well as the page on which it appears.

FOUL BROOD.

THE CANADIAN TREATMENT: IS IT NEW?

[512.] In the *B. B. J.* of November 20th, your correspondent, 'X-Tractor,' (448, p. 558) criticises our official methods of dealing with the foul-brood plague as given in the *Journal* of November 13th. He ridicules our *modus operandi*, and advises us to 'take a lesson from the custom as practised by the Editors of the *B. B. J.*' This is indeed rich. From reading in the *B. B. J.* of the extraordinary remedies proposed for the cure of the disease, and the still more singular methods of applying them, it had occurred to me that many of the ideas and theories put forth were very absurd; and now it seems this is our position, too, in the eyes of the other gentleman over there.

Well, as we seem to be about even on the score of complimentary opinion, we will now

look at the facts of the case, which are, after all, of much more importance. We have been curing foul brood in all stages without failure during the whole of the past summer, commencing in May and working up to November. We have done this without drugs of any kind. The drugs are only used as disinfectants, not as remedies.

In my last letter I gave our inspector's plan of treatment: but as it did not appear it was probably lost, and I shall therefore repeat it here—that is, the summer treatment, as that for 'fall' was given in the article on the inspector's work, which appeared in the *Journal* of November 13th:—

In the honey season, when the bees are gathering honey freely, remove the combs and shake the bees into their own hives in the evening, give them comb-foundation starters, and let them build comb for four days. In the evening of the fourth day remove the comb and give them foundation to work out, and then the cure will be complete. Fill an empty two-story hive with the combs of foul brood that have been removed from two or more diseased colonies, close them up for two days, after that open the entrance, and when most of the sound brood is hatched remove those combs and give the bees starters of foundation in single hives and let them build combs for four days. Then in the evening of the fourth day take out those new combs and give them foundation to work out.

Those who believe that the germs of foul brood are carried about by the queen, by the manipulator, by the wind, and in various other ways, thus spreading the contagion and communicating the disease, will, of course, be slow in believing in the efficacy of the above simple method of treatment.

By assuming, however, that the *honey* is practically the only medium of communication for the spores or germs of the disease, this treatment becomes perfectly intelligible and rational. On the other theory it is, of course, not so, and as that is the one generally held, the reason becomes at once apparent why the bee-keepers of the United States, as well as English bee-keepers, are so tardy in accepting, and indifferent to, our curative process. It seems to me the practical question for them is—ought they to allow a theory which really has never been proved to stand in their way and override facts to their own detriment?

The fact that our method will cure and invariably cure (so far in our experience) when properly carried out ought to be sufficient for any reasonable man who is not lost in his own conceit. Be it remembered, too, our verification by results of this treatment of foul brood is not circumscribed by a season's work, or limited to a year, or even ten years. In 1875—fifteen years ago—our provincial Foul-brood Inspector, Mr. William McEvoy, of Woodburn, Ontario, found foul brood in his yard, and, after burning the first cases, he experimented, and discovered, so he claims, the method of cure given above,

which he found successful, and has ever since found invariably successful. He has treated the disease for his neighbours off and on ever since, and always with success. In May of the present year, as already stated, he was appointed Foul-brood Inspector under our recent Act, and has had ample opportunity since to still further verify his treatment on a large scale, having treated hundreds of cases in all stages. It may be asked—Why is this treatment, if so effective, not generally known and practised? I answer the question by asking another—Why is it that you British bee-keepers will not accept it now, but only ridicule it? And why is it that our neighbours, the United States' bee-keepers, will not accept it? These questions can be answered in two or three words—viz., prejudice, preconceived opinion, the unwillingness we find in human nature to accept a new truth or fact, especially if it comes from an humble or unorthodox source. Mr. McEvoy is a modest, retiring, but honest and intelligent man in humble life, and hence the small measure of attention his discovery secures. I have determined, however, to bring this cure for foul brood before the bee-keepers of your continent as well as this, and my duty will then be done whether they reject it or accept it. I do not thus commit myself without good grounds. I have not simply taken Mr. McEvoy's word, good as it is. I have sought collateral and corroborative facts and testimony, and have obtained them.

For years before Mr. McEvoy was appointed official inspector he had been curing foul brood for his neighbours far and near, and like a good Samaritan, generally without money and without price. Of the testimony I have in my possession I beg here to quote one instance:—

‘Hamilton, Ont., Nov. 1890.

‘This is to certify that I had foul brood in my apiary in the year 1881. Mr. Wm. McEvoy offered to cure it without destroying the bees, which he did very thoroughly. I continued to keep bees up to the year 1887, and saw no trace of foul brood after the cure effected in 1881.

‘(Signed) JAMES RUSSELL, M.D., *Medical Supt.,
Asylum for the Insane, Hamilton.*’

The reader will observe that this cure was made nine years ago, and Mr. McEvoy had been treating the disease with invariable success the preceding four or five years, thus giving us an experience of fifteen years.

Under these circumstances I do think it about time that bee-keepers, both here and in the old country, dropped their prejudices and their fruitless theorising over this plan and that plan, this drug remedy and that, and gave this simple method of treatment at least a fair trial. I trust they will do so next season and rid themselves of the pest of foul brood.

This method of cure is, however, sometimes bungled and mismanaged, and then condemned. In applying it, one central, vital fact must always be borne in mind and guarded against. That fact is that the infected honey must all be removed, whether in the combs, in the sacs

of the bees, or adhering to the hive or appurtenances, for one drop of it entering into the larval food will start the disease afresh. This mode of treatment seems to have proved that *practically* the honey is the only medium of communication of the germs. Remember, I do not say it is an abstract theoretical fact, but that in our modes of treatment and manipulations we must assume that the honey is the medium of the mischief.—ALLEN PRINGLE, *Selby, Ont., December 31st, 1890.*

[Our correspondent is altogether too severe on our friend ‘X-Tractor,’ whose sensible remarks have called forth the above letter. ‘X-Tractor’ is quite able to defend himself, and when he penned his criticism on the ‘official methods’ he had no doubt in mind all that had been done in Europe in the same way years ago, and discarded as ineffectual. We have no need to take a lesson from our Canadian friends on the treatment of foul brood, for they are now only where we were ten or fifteen years ago, and, although it may be ‘indeed rich,’ it would be well for them to take a lesson from us, for we have more fully realised the dangerous character of the disease, and have taken precautions against it spreading. Were we to send out inspectors, carrying the disease from one apiary to another, we should indeed be spreading the disease rapidly. According to our present knowledge of foul brood, ‘X-Tractor’s’ remarks were most suitable. According to Mr. Pringle, we are altogether behind the times, and will not try the Canadian method because of our prejudice, preconceived opinions, and the unwillingness we find in human nature to accept a new truth or fact, especially if it comes from an humble or unorthodox source.]

Our friend will excuse us for stating that he is mistaken in every one of these statements, for no one is more ready to accept a truth when it is proved than an Englishman, or to give credit even to the humblest who is able to demonstrate it. It, however, happens that we English know something about foul brood, and the remedy proposed on the other side, and those who have been bee-keepers long enough, know also that it has been thoroughly tried here and has as thoroughly proved a failure. We are told that Mr. McEvoy discovered this method of treatment some fifteen years ago. Will our correspondent be astonished to hear that the starvation plan advocated in the ‘Official Bulletin,’ and the one alluded to above has been known and practised for more than 100 years—that Della Rossa describes it in 1790, and Schirach some quarter of a century earlier? In those days, and until quite recently, it was supposed that honey was the medium through which the disease was communicated, and means were taken to induce bees to consume all the honey they carried before they were allowed to raise any brood. Over and over again has this been tried; combs have been removed, and bees even starved to make them consume their honey, and when brood-raising commenced the disease has again broken out. One hundred and twenty-five years ago Schirach wrote:—‘The most simple remedy is to remove from the hive the infected combs and to make the bees fast for ten days, after which fresh comb can be given them.’ In the first volume of the *British Bee Journal*, for 1873 (p. 67), a very similar treatment is recom-

mended of placing bees in empty hives for a few days until the honey in their honey sacs is converted or consumed. On p. 66 of the same volume it is stated that the worst feature of the disease is 'that the honey in the hive is also charged with the germs of infection, and that any robber-bee which gets even one load of it carries home to its hive the poison.' In the first five or six volumes of the *Journal* there are plenty of such references and records of experiments, so that with us, at any rate, the theory is not new, whatever it may be over in Canada.

German bee-keepers have also advocated the same thing, and there are plenty of articles on the subject in the *Bienenzeitung* even as far back as 1865. Does our correspondent know that Berlepsch, Dzierzon, and all the leading bee-masters of Europe, have tried it and failed?—and certainly it cannot be said that in their hands the treatment would be either 'bungled' or 'mismanaged.' And this is the remedy which we are seriously told we 'will not try from prejudice,' to again quote our correspondent.

Besides, it is absurd to say that 'prejudice or preconceived opinion' would prevent a bee-keeper from accepting so simple a remedy for a disease which is in itself entirely subversive of all that is good in the pursuit.

We should like to see the bee-keeper who would withhold his blessing from the benefactor at whose hands he received a cure for foul brood, without inquiring as to the source from whence it came, or its orthodoxy either!

Foul brood in Canada must be very different to what it is in Europe if the treatment advocated is efficacious; perhaps it is what is called *dry foul brood* by German bee-keepers, which is not contagious, and is not the malignant form we have in Europe. At any rate, the foul brood we usually have is contagious and infectious enough. Although not denying that honey is a possible source of infection—that it is the usual means we cannot admit, as we have abundant proof to the contrary. We know of many instances where the introduction of a queen has resulted in foul brood, and we also know that it can be carried from one apiary to another. Canadian foul brood is not the European form if it acts differently. It is because all the starvation methods have so signally failed that European bee-keepers are resorting to more rational treatment, and more in accordance with the present-day knowledge of disease. When bees are gathering honey freely almost any method succeeds, and at such times the cure is supposed to be due to the extra quantity of formic acid used by the bees, this of itself being a disinfectant. We only wish that such a simple method as that proposed were effectual; if it had been, foul brood would long ago have disappeared. Try it by all means, we say to our readers, but do not be disappointed if a cure does not result.—EDS.]

IS MEAD-MAKING ILLEGAL?

[513.] The answer to the above question depends entirely upon the alcoholic strength of the beverage produced. If the amount of alcohol be less than three per cent. of proof spirit the beverage can be made and sold without payment of duty. If the percentage is greater than three, duty must be paid and could be legally enforced. The same question has

frequently been raised in the case of ginger beer, and it has been decided that even in cases in which vendors of ginger beer were ignorant of the alcoholic nature of the article the magistrate has no alternative but to convict.

As the percentage of alcohol in mead would almost certainly be much greater than the above limit, it appears to me that mead cannot be made, and certainly cannot be sold, without a licence. Under the Inland Revenue Act of 1880 mead is specially mentioned, and the licence to be taken out by a retailer of the same is fixed at 1*l.* 5*s.* The Customs and Inland Revenue Act, 1885 (48 and 49 Vict., cap. 51 sect. 5) states as to *private* brewers' licences, 'On and after the first day of October, 1885, the duty of excise, payable under the Inland Revenue Act, 1880, on a licence to be taken out by a brewer of beer (*not* being a brewer of beer for sale) shall be four shillings.' I believe this clause holds good not only for beer, but for all other alcoholic beverages, excepting that in the case of beer the dutiable limit is two per cent. of proof spirit instead of three per cent. as in other cases.

If you, Messrs. Eds., in your exuberance of generosity, will *gladly* pay any fines which the magistrates will have to inflict without any option whatever, then you must indeed be in the possession of a most cheerful temperament.—OTTO HEHNER, *Analyst to the B. B. K. Association, President of the Society of Public Analysts.*

[We did not lose sight of the fact that the strict letter of the law prohibits the manufacture of alcoholic beverages of any kind without a licence; we had only in view the absurdity of an excise officer putting the law in motion against a bee-keeper for making a little mead at home for his own use, as well as the fact that practically we suppose it would be impossible to find a single person in the whole kingdom who manufactures mead for sale. In assuming that we 'will gladly pay any fines which the magistrates may inflict' our esteemed correspondent credits us with an 'exuberance of generosity' to which we can lay no claim. Nevertheless, we will cheerfully fulfil the undertaking made in our foot-note to No. 500 (p. 33), in this one case, if for no other reason than that it will enable us to inform bee-keepers what to expect if they continue to sin in that way.—EDS.]

BEE-KEEPING IN SPAIN.

[514.] Your name is familiar to me as that of an authority on the subject of bee-keeping through the columns of the *Revista Apicola* of Mahon, and through the means of a treatise in French, written by you on the subject; I therefore, at the risk of being troublesome, venture to address these lines to you.

For many years past I have devoted all my spare time and some capital to bee-culture. I have looked out eagerly for works and publications of all kinds relating to the subject, and succeeded, with some difficulty, in obtaining and reading hastily through a treatise by Varembe (French), which, however, gave me little more than the traditional practice of

Spanish bee-keepers applied to cylindrical hives of various materials. In this country, and especially in the inland districts, we are in a very backward state, but in spite of many formidable obstacles I have continued to struggle onwards, refusing to believe that our knowledge of bees could long remain in such narrow limits. Last spring I happened to come across a work from your pen, in French, as mentioned above, and a hive arranged according to your instructions. This put fresh heart into me, and I have now obtained a number of D. F. F. Andreu's *Revista*, but not yet a copy of your work.

Since then I have become a subscriber to M. Andreu's paper, and later on I obtained a copy of his manual. I am thus in a position to undertake the task of converting my 200 old-fashioned hives to the frame system, and have obtained some of the necessary appliances from the manufacturers through M. Andreu. The adoption of the new system, however, would not be satisfactory unless it involved considerable advantages, especially in the matter of economy of appliances. In his volume M. Andreu set such expenses at a low figure, but then he is referring to such articles of his manufacture as might be desirable for those living close to him; but in my case the expenses would be much heavier, as I should have to pay shipping, railway, and carrier's dues on the large quantities of things I should require, without taking into consideration the fact that I could only receive the articles ordered after an interval of two months. In order to be able to surmount these and other obstacles, I propose to endeavour to construct some of my appliances myself, and to read up as much as I can with regard to the advances which have been made by the great bee-keepers.

One of the most important materials I require is comb foundation, and as I collect my own wax, I could effect a considerable saving if I had a machine for manufacturing it.

I shall be much obliged if you will kindly assist me in obtaining a copy of your treatise, and to become a subscriber to your *Journal*, provided a French version is obtainable, for I do not know a word of English. Will you kindly let me know where I can obtain an apparatus for the manufacture of comb foundation? I have no idea of the cost of this, but will remit amount to you to send what I want. Will you have the goodness to reply in Spanish or French.—MANUEL ROMERSY ORTIZ, *Huescar, Province of Granada*.

NOTES BY THE WAY.

[515.] *The Weather*.—Yes, the principal topic of the day is still 'the weather.' Was ever such weather known since the glacial period as we have experienced during the last eight weeks? The *Standard* was jubilant the other day that the frost had really broken up, and a right, good, soaking thaw had set in *all over the land*; but one ought to be careful in prophesying about the weather unless one really knows.

We, in West Berks, have reason to be thankful for the water provided by the thaw. The snow wasted considerably during Monday night and Tuesday, with the thermometer steady at 38°, wind north to north-west; but Tuesday night the thermometer fell again to 33° by ten p.m., and Wednesday morning found the roads coated with ice again, and it continues very severe up to time of writing. During last night the thermometer registered as low as it has been at all throughout the long-continued frost.

Bee-flights.—I have heard privately of bees in full flight. One friend in Scotland (Sutherlandshire) speaks of his bees on the wing in great numbers on New Year's Day, which he remarks was a very mild day. Another, from Warwickshire, writes: 'I trust your bees have had a good flight, as I am pleased to say mine have. It was impossible to remove the snow out of the apiary, but I well bedded up with nice dry straw, and lost very few through chill.' Here's a good suggestion—if you cannot clear the snow, spread some straw, hay, or ferns over the snow, so that when your bees are on the wing they may find a resting-place from which they may take wing again. Well, it is good news to hear that some apiaries have been able to get a cleansing flight; but I am sorry to say we, in this neighbourhood, have not reached the temperature requisite to tempt the bees out. On Monday afternoon I was busy clearing alighting-boards and around the front of hives, hoping on Tuesday to see a general exodus—but very few bees were on the wing; not seven per cent. of the hives in the apiary showed signs of life.

In two cases I have had mice in straw hives, not by boldly going in at the entrance, but by nibbling the hive at the back under cover of the wraps, and getting in that way. The mousetrap was baited, and the entrance of it placed very invitingly near the hole in hive, and in the morning I had a prisoner, who could not resist the allurements of toasted cheese.

Contemporaneous bee literature does not seem to be on the decline in America. The *American Bee Journal* has just completed its twenty-sixth volume, and starts the new year with a new shape, similar in size to our own *Bee Journal*. Hitherto it has had sixteen pages; for the future it will contain thirty-two pages, or 1664 for the year. *Gleanings in Bee-culture* boasts its 10,000 subscribers. The *Bee-keepers' Review* dons a new cover with the new year, and the W. T. Falconer Manufacturing Company issued a new magazine, the *American Bee-keeper*, on the 1st of January, 1891. To these may be added *Bee-keepers' Guide*, the *Apiculturist*, *Bee-keepers' Advance*, and last, though not least, the *Canadian Bee Journal*. This surely is a good array of bee periodicals; but when we come to consider that 300,000 Americans are engaged in the pursuit of bee-keeping, there is abundant room for all the periodicals mentioned, as also others who have 'bee departments,' such as agricultural and horticultural publications.

The single and double-walled hives seem likely to have a good test this winter. Possibly bees may exist as well in one as in the other, and if so the single-wall hive must commend itself to the apiarist on the point of economy; but from another point this cheeseparing in the matter of hives may prove false economy, as probably more food will be consumed by the bees to keep up the animal heat in the single-walled hive than in the hive with double walls; but I am inclined, not only by my own experience, but by the experience of others, to think that the crux of the question comes in during the spring months—say, middle of April till the middle of June. This is the period when our stocks are built up to boiling point, and it is in the development of the brood nest, to the extreme limits of the brood compartment, that the advantages of double walls become apparent, especially if the weather should be cold during that period, or even part of the time. The hive with single walls, containing ten frames, even on the most generous estimate would not contain more than eight frames of brood, while the hive with double walls, under the same management, would probably contain ten frames of brood, the queen being induced to visit the outside combs in the brood chamber by the equable temperament of the hive. These two important items—viz., bees' consumption of stores during winter and an extended brood nest in spring—may be means to an end in the apiary during the honey harvest; in fact, it may make all the difference, when results are totted up, if the balance is on the right or the wrong side.

The Berks Association has lost one of its old members by the death of Mr. W. Champion, Oxford Road, Reading. The deceased was the son of the late Mr. Champion, and formerly owner of Calcot Mill, and was known as a shrewd farmer and judge of cattle. He held the office of Steward of the Corporation Sewage Farm from its formation some sixteen years ago till 1888, when he resigned through failing health. He was an enthusiastic bee-keeper, and has staged some fine exhibits of honey at several shows in connexion with the Berks Association.—W. WOODLEY, *World's End, Newbury.*

SPRING MANAGEMENT.

[516.] Having tried the plan of removing all combs that are uncovered by bees and closing up with division boards at end of February, and having also tested wintering on all the frames in the hives (ten and twelve in each), and leaving the bees undisturbed on this number all through the spring and summer, I am unable to say which seems the better plan of the two. Of course, when left on full frames every attention was given to warm quilting, feeding, &c. Doubtless weak colonies, deficient in bees, are considerably helped by confining them to just the number the bees can cover; but I am doubtful if a strong stock of bees, with young queen, warm quilts, and proper feeding, will derive any assistance by 'crowding up.' Might I suggest

a little discussion under this head as being just now in season? Will Mr. F. Boyes favour us with his views on the subject, as I see by referring to back numbers of *B. B. J.* he has had drones flying on the 10th of April, fully six weeks before us? This may seem a trifle to some, but to me it means bees in supers and sections ready for taking off in May gathered chiefly from whitethorn, gooseberries, raspberries, &c., whilst those who are a little behind time never get any of this early honey. I consider that where there is no heather we ought, by hook or crook, to have our bees in the supers by the time the orchards are in bloom; we cannot afford to miss the beautiful early honey: if we do, there is but one other chance left, *i.e.*, the clover; and if it happens to be cold and wet the latter part of June, this chance is gone, and it is twelve months before we can try again.

The longer I keep bees the more surely do I realise that there is always something to learn or to unlearn; and so I would ask, Has any one tried newly 'slacked' lime for disinfecting hives by giving a good coat inside? Would the bees object?

In conclusion, let me take this opportunity of wishing first our editors, 'Mr. Useful Hints,' every contributor to the *B. J.* pages, and every reader a happy and prosperous new year.—J. W. BLANKLEY, *Denton.*

[Many years ago, when disinfecting hives, we gave a coat of hot newly slacked lime to the *insides* of all the outer cases, roofs, &c., of our hives; but the hives themselves got two good coats of paint inside, and both lime and paint were effectual.—Eds.]

WIDTH OF TOP BAR IN FRAMES FOR EXTRACTING.

[517.] Will you kindly give me your opinion as to whether, in working for extracted honey by means of shallow supers, it would be best to use a frame with top bar and sides of the dimensions as to width used in the brood body or whether it would be better to use a wider top bar, say one and a half inches? I have worked my hives hitherto for sectional comb honey, but am thinking of trying a few hives for extracting during the coming season, and wish to start on the best lines.—S. W. R., *Ascot.*

[Practically to use top bars of two widths means multiplying items in bee-work, and there is no need for it. In preference, when we want to obtain thick combs by working nine frames in a surplus chamber made to hold ten, slips of wood—similar to those used between the end combs and hive slides—are inserted between each pair of frames.—Eds.]

APPLIANCE DEALERS.

[518.] In reply to 'Mr. G. J.' 495, page 10 anent common courtesy, might I again refer to first extract from 'Mr. U. H.' in my letter, 484, page 605? 'It is not fair to blame manufacturers who are *overdone* for a few weeks,' &c., and if overdone, what time have they for usual civilities to customers? This was not written

by 'Mr. U. H.' for the purpose of justifying dealers, as 'Mr. G. J.' would make it appear I considered to be the case, but for the purpose of warning bee-keepers, if all sent in their orders to them at the same time, what would be likely to take place, and curt courtesy must accompany delay in the execution of orders; for if the dealer has time for the one, why not also for the other? I know of a manufacturer having 400 orders on hand at one time last season. Would he not be serving bee-keepers more by getting through with his work than wasting his time making explanations? But except in the matter of discount (and in warning of this 'Mr. U. H.' also refers, 'We hear of dealers refusing altogether to wholesale any'), how is it that 'Mr. G. J.' has been taken advantage of by the, to me, unknown dealer? I have sent on my *Journal* containing his letter (471, page 582) to a friend, and must write from memory. 'Mr. G. J.' sends money to a dealer for sections, &c., according to catalogue. Mr. Dealer writes: 'Sold out of those sections, but have others better and more expensive. Shall I send them instead?' 'Mr. G. J.' says 'send them on.' Mr. Dealer then forwards the number he had paid for according to the increased rate—not the number ordered at lower rate. Has 'Mr. G. J.' not the value of his money? How, then, can he say he has been taken advantage of by Mr. Dealer?

The burning down of one of the largest factories and stores in America, with some other reasons for the scarcity of sections, in the hands of a Higher Power than that of dealers or manufacturers, was the probable cause of 'Mr. G. J.'s' troubles. I am sorry for them, and hope next time matters will work smoother.—W. B., *Patrickswell, Co. Limerick.*

[The ventilation of grievances *pro* and *con* between bee-keepers and dealers has been productive no doubt of much good, but we trust correspondents will agree that the matter may now be allowed to end.—Eds.]

CHEAP HIVES AND APPLIANCE DEALERS.

[519.] 'G. J.' writes me that the 'W. B. C.' body-box is very cheap, and so constructed as to require no great skill in putting it together, and he confesses that in many cases of cottagers not very expert in handling tools it would be better to purchase the 'W. B. C.' as I suggested, and make the cover and outer walls themselves.

The cost of the body-box, with frames, &c., complete, is 3s., and postage 1s. 1½d., and I am anxious to point out that by buying in quantities and sending by rail the cost of carriage could in most cases be reduced to a few pennies; and no doubt county associations, by contracting to have a large number made in the winter, could buy them, carriage free, at the rate of 3s. or 3s. 1d. each, at which price they could be sold to members.

Permit me to add that a box turned upside

down makes a capital floor-board and stand combined, and that pieces of newspaper crumpled up and lightly pressed down make a capital packing, which can be easily removed and replaced without making a litter. The size of the pieces should be about four to a page.—T. F. L., *Brondebury.*

HONEY COMPANIES.

[520.] I have received several queries as to the result of my proceedings *re* the British and Irish Honey Company. I think if you will insert the following letter, sent to me by my solicitors, it may interest creditors of the above-mentioned company, although it is not very edifying reading:—

'The liquidator informs us that the only asset was the business, and that the business has been sold by the bondholders (by which, probably, he means the debenture-holders) for about 200l., that this amount will not be sufficient even to pay the bondholders or debenture-holders, and that, so far as the ordinary creditors are concerned, there will not be a farthing for any one.'

It would be interesting to know if any honey sold to the company has ever been settled for. I believe that the origin of the slang expression 'going to pot' dates from the good old times when bankrupts who could not give a good account of their doings were boiled in oil. I begin to sigh for those good old times. I have not thanked you for your prompt establishment of the 'deposit system,' but do so now with all gratitude. In future I am determined to dispose of any honey produced either by demanding cash before dispatch, deposit system, or, failing to obtain these terms, to give it away. Probably, if my friends read this, they will not encourage the deposit system as they ought.—C. S. READ, *Binsted House, Arundel.*

HOW I USE THE RAITT HONEY PRESS.

[521.] A few seasons ago I purchased a 'Raitt honey press,' which I required to use with thick autumn-gathered honey. On arrival of press I was at a loss how to use it—I mean to make it firm—until I proceeded as follows: I had a 30s. Raynor extractor from which I took cages and loose parts away. I then got a stout board, eleven inches in width by about three feet six inches long, in which I cut a square hole for the rim belonging to press to fit in; two holes were next bored nineteen inches apart for the screws on extractor side to fit in. The board was then screwed down, the rim and press placed in position. I could then screw away without fear of an upset. By placing a piece of straining cloth over extractor before screwing board on you can have the honey straining as it falls from the press. My opinion of press is, it works—to use Mr. Howard's own words—'Slow but sure.'—JOHN WHARTON, *Hawes, North Yorks.*

Queries and Replies.

[300.] *Spring Management.*—May I ask for a reply to the following?—1. Is it a 'positive help' to the bee to use 'American cloth in spring?' 2. Will it help a fairly strong colony to take away all combs uncovered by bees? 3. What is the very earliest time one may with safety begin to stimulate for brood-rearing in the spring, supposing the bees are in double-walled hives, and that every precaution is taken in protecting the bees from cold? 4. I thought of pasting a newspaper over top when giving my first crate of sections. Has any one tried it?—J. W. B., *Denton*.

REPLY.—1. Personally we use American cloth next the top bars, winter and summer, and so you may take it that we deem it of use. 2. It helps a weak colony to do as you say, but a strong one does need troubling about in this way. 3. The orthodox time of 'six weeks prior to the time the honey-flow begins' is about correct. 4. Pasting a newspaper over sections is a nuisance. Try warm quilting and a board well pressed down over all, and at the junction of the crate and the hive insert long strips of newspaper pressed sharp at one edge, so as to exclude air from the outside.

[301.] *Examining Bees.*—How soon may I open up my hives to ascertain their condition?—J. GUNN.

REPLY.—When the weather is warm enough for the bees to take a flight.

Echoes from the Hives.

Denton, Lincolnshire, January 14th—Weather here same as it was a month ago: frost, snow, cold winds; in fact, a real hard winter all along. Bees have not had a flight for over two months. On the 9th I gave a cake of candy each to two stocks about which I was doubtful, and found them lively as crickets after their long imprisonment. This argues well for bees put away in good condition.—J. W. BLANKLEY.

Builth, Wells, Breconshire, January, 1891.—It may interest you to know that in the past poor season I had a surplus of fifty pounds per hive, and left ample stores for winter; and the fact that I took first prize for sections, and first for extracted in a keen competition at one show; first for section and second for extracted at another; and first for extracted and 'h.c.' for sections in open class at a third, or in all four firsts, one second, and one 'h.c.' for six entries, shows the quality was pretty good. I only wish I had two or three times as much of it, for I should have no difficulty in selling it all.—T. L.

Reviews.

Dr. Tinker's new work on 'Bee-keeping for Profit.'—Since our review of this book on p. 24 of *B. J.* for Jan. 8th, we have received several letters making inquiry as to price, where it can be had, &c. In reply, we beg to say the price in America is 25 cents, and it can only be had by direct application to Dr. Tinker, New Philadelphia, Ohio. As, however, the extra cost and trouble of procuring single copies of the work in this way may prevent many from reading it, we have decided—should a few more applications for it be received—to obtain a small stock of the book for the accommodation of bee-keepers here, and will report their arrival should the idea be carried out.

We have received Nos. 1 and 2 of the *Apistische Bibliothek*, by Tony Kellen, published at Zurich. No 1, *Glück des Landleute durch Bienenzucht* (fortune of the country people by bee-keeping), treats of the advantages to be derived by people in the country keeping bees, and the benefits bees confer on mankind in various ways. No 2, *Die Bienenzucht in der Welt-Ausstellung zu Paris, 1889*, is a description with illustrations, of the progress of bee-keeping, as evidenced by the exhibition of honey, hives, and appliances by different countries at the Exhibition in Paris last year.

We have besides a number of other works, which hardly need mention, unless it is one by E. Weygand on his method of treating hives in winter by keeping them in heated chambers. This system has been tried, and although some have written in its favour, the majority of bee-keepers pronounce against it.

REVIEW OF GERMAN BEE JOURNALS.

By J. DENNLER (ENGHEIM).

Der Bukowinder Bienenfreund. Editor, Moritz Müller, of Czernowitz.—No. 7 gives a biography of M. Hamet of Paris, as well as a portrait of a young man carrying a whole swarm attached to his hand. This young man (Fritz Feller) had held by the wings a queen that had come out with a swarm, and placed himself in the centre of the flying bees, which soon settled round their mother, without stinging either the hands or face of this master.

Der Elsass-Lothringische Bienenzüchter. 18th year. Editors, Dennler and Zwilling.—The ministry of Alsace-Lorraine has instructed the directors of districts to proceed to an inquiry as to the noxious influence of bees. If necessary, the Governments would propose legislation for their repression. This inquiry was promoted by a statement of a delegate of Alsace-Lorraine during last session. According to this gentlemen, bees voluntarily

attack fruit and grapes, and cause serious damage. Every bee-keeper knows that, on the contrary, the damage caused is so insignificant that it is hardly worth mention. Bees never attack fruit or grapes not already damaged by birds or wasps.

Notices to Correspondents and Inquirers.

Letters or queries asking for addresses of manufacturers or correspondents, or where appliances can be purchased, or replies giving such information, can only be inserted as advertisements. The space devoted to letters, queries, and replies, is meant for the general good of bee-keepers, and not for advertisements. We wish our Correspondents to bear in mind that, as it is necessary for us to go to press in advance of the date of issue, queries cannot always be replied to in the issue immediately following the receipt of their communication.

All queries forwarded will be attended to, and those only of personal interest will be answered in this column.

We beg to acknowledge, with thanks, receipt of Report of the Proceedings of the Twenty-first Annual Convention of the North American Bee-keepers' Association from the publishers, Messrs. Thos. J. Newman & Son, Chicago, Ill.

W. GOODALL (Rastrick, Yorks.).—*Cotton Knobs for Fuel*.—We fear the 'cotton knobs' you suggest as fuel for smokers, unless confined by the wire gauge tube, would be apt to burn too freely, and soon become a mass of fire. However, we will be glad to have your report when tried as you suggest. Thanks for good wishes.

W. A. WALKER (Ripley).—*Bees Dying*.—There is nothing very alarming in raking out fifty dead bees per week after so severe a time as they have had for many weeks past; but the dead bees received are covered with either honey or syrup, and this *does* want seeing to the first chance. The sample of candy sent is quite useless to the bees as food in winter: it is as hard as stone. Only *soft* candy should be used. Full instructions for making it are given in *B. J.* for Oct. 23rd, 1890, p. 514.

BALLINDALLOCK.—There is no trace of Ligurian blood in bees sent, though it is quite possible there may have been ten years ago; practically they are now natives.

HENRY SMITH (Winchester).—We shall be very pleased to have a 'Weather Report' from you.

J. B. (Durham).—Sugar as sample sent will be good for either syrup or candy.

* * Several letters, &c., are unavoidably held over till next week.

NOTICE.—We request our correspondents in future to address all communications relating to the literary department, &c., to 'The Editors of the "BRITISH BEE JOURNAL," 17 King William Street, Strand, London, W.C.'

THE DEPOSIT SYSTEM.

British Bee Journal and Bee-keepers' Record.

OFFICE: KINGS LANGLEY, HERTS; AND
17 KING WILLIAM STREET, STRAND, LONDON, W.C.

The following are the Rules under which we are prepared to receive Sums of Money on Deposit from persons buying and selling goods.

In order to save trouble it is requested that the Rules be carefully read over by persons using the Deposit System of trading.

DEPOSITING.

1. Method.—When strangers are dealing together, the purchase-money of the articles is deposited at our office. We acknowledge receipt of the deposit to both parties, and hold the money until we are satisfied that the purchase is concluded. If a sale be effected, we remit to the seller the amount deposited, less a charge of 6d. and the expenses of Post Office Orders and postage, &c. Cash will be forwarded by cheque, Post Office Order, or by Postal Order as preferred. If a sale or exchange be not completed, we return the amount deposited, after making the same deduction. By this means buyers and sellers are secured from fraud.

2. Deposits.—Postal Orders (drawn on General Post Office) and Cheques must be made payable to John Huckle, and crossed 'Bucks and Oxon Bank.' The numbers of the Postal Orders should be kept by the sender. We cannot be responsible for any losses that may occur in transit.

3. Honey on Approval.—All honey will be sold by sample, which must be sent direct to buyer.

4. Bee-appliances.—In ordering, the time allowed for completing the order to be stated to us when sending cash. If maker accepts, we hold cash till transaction is satisfactorily completed, when the amount will be remitted subject to conditions as in Clause 1.

5. Bees and Queens.—These will be dealt with entirely by the parties concerned, so far as price, &c., goes, and when the purchase is satisfactorily completed cash will be remitted as per Clause 1.

6. Goods in Transit.—These are at the seller's risk, i.e., any damage to or loss of an article on its journey is borne by the vendor; but a rejected article must be properly packed and returned by the same means as was used in sending it.

7. Carriage.—The carriage of all goods, *except* such as are sent by post, is payable by the buyer, unless otherwise agreed. If any article sent on approval be returned, each party to the transaction must pay carriage one way.

JUDGING HONEY. By the Rev. J. L. SEAGER. Price 3d.

FEEDING BEES. By GEORGE WALKER, M.R.C.S., L.R.C.P. Price 3d.

HOW TO COMMENCE BEE-KEEPING (Leaflet). Price 4s. 6d. per 1000, 6d. per 100, post free.

WINTERING BEES. By THOMAS W. COWAN. The most complete work on the subject of Wintering published. Third Edition. Price 3d.

QUEEN INTRODUCTION. The Ligurian Queen Bee and her Introduction to Alien Stocks. By the Rev. GEORGE RAYNOR. Second Edition, enlarged and fully illustrated with engravings of the various Cages in use. Contains full descriptions of the different methods practised in this and other countries by Chloroform, Caging, Direct Introduction, &c. Price 3d., post free 3½d.

JOHN HUCKLE, Kings Langley, Herts.

THE
British Bee Journal,
BEE-KEEPERS' RECORD AND ADVISER.

No. 449. Vol. XIX. N. S. 57.]

JANUARY 29, 1891.

[Published Weekly.]

Editorial, Notices, &c.

BEE-PAPERS FOR WINTER READING.

No. 3.—SPRING MANAGEMENT.

'STIMULATING' OR 'BUILDING UP.'—The very essence of the 'art of bee-keeping' consists in being able to bring the colony up to full working strength so early in the summer as to be ready for the honey-flow when it comes. In saying this much, we do not lose sight of the fact that 'seasons' in different localities vary as widely as the times of ripening in different kinds of fruits and vegetables; and it is just as necessary for the bee-keeper to make himself acquainted with the honey-producing flora of his district as for the gardener to 'time' the sowing of his seeds.

The circumstances under which the writer finds himself to-day furnish a very apt personal illustration of this fact. For nearly a quarter of a century we had kept our bees in one locality—indeed, in the same garden—and could tell to a few days when the bees would begin storing, because of our intimate knowledge of what was growing within the whole radius of the bees' foraging-ground. Consequently no attempt was made to start early, and so prepare and force on our army of workers for labouring on a source of supply which did not exist. Such a course would have been like hurrying to get up steam for starting the printing machine before the type was set. Full populations by mid-June was what we worked for in past days.

All this, however, is now changed, and we find ourselves and our bees located in a district entirely different in character from that we have left. Here plums, damsons, currants, and such-like are grown in fruit-gardens the extent of which was a revelation to us; while whole fields of raspberries and strawberries surround us on every side, so that we are 'in' for quite a new condition of things, and it would be the height of folly to go on in the old way. We hope to be removing surplus in the coming early summer-time before the bees in Cheshire have started working on the clover, just as surely as we expect that the honey harvest here will be over and ended while more northerly apiaries will be gathering fast.

This puts the matter in a plain light, we hope, as proving the necessity for the bee-keeper 'knowing his ground;' and when he has gained

this knowledge by experience and observation, he will realise the difficulty we have in replying to the oft-repeated, but very vague question, 'When must I begin to stimulate?' A stereotyped, and withal a very sound, reply is usually given, viz., 'Six weeks before the honey-flow;'; but we would like to be able to add, 'Don't stimulate at all,' for happy is the man whose stocks do not need it; and not seldom does it happen that the inexperienced and over-anxious bee-keeper actually retards the progress of a thriving colony by his endeavours to help it on. Another point may be noted here for the information of those who wish to prevent swarming, and that is, stimulation in spring has a tendency to create in the bees a desire to swarm, and adds to the difficulties of preventing it.

'Right here'—to borrow an Americanism—we would say, if a stock of bees is seen to be working vigorously, with an ever-increasing population—and it needs no great amount of bee-knowledge to judge of this without the necessity for opening the hive—leave that colony severely alone. If food is safe, and you know that the combs are in good condition, don't tinker with it, don't bother it, and *don't stimulate* it. The fact is, the condition of things inside such a hive are as naturally stimulating as things can be, and to interfere is to do harm.

On the other hand, it is of very great importance sometimes, especially where the bees are required to be strong quite early in the year, to do something by way of creating a mild form of excitement among the bees. This is done by gentle continuous feeding, forestalling the natural income as it were, and thus raising the temperature to a degree which stimulates the queen to increased egg-laying, and results in a considerable enlargement of the brood nest. The point we would ask readers to bear in mind is, to see that nothing is done in early spring to lower the temperature of the hive when disturbing the quilts for the purpose of feeding. Warm wrappings must be added to, not lessened, at this time; and if a colony is only of medium strength, it will also assist it to contract the hive by removing a few combs, to be returned later on, when the bees are seen to need room. A considerable number of stocks in most apiaries will so surely be found requiring attention after the winter is over that we must not allow readers to suppose that 'stimulating' or 'building up' of colonies is the exception rather than the rule. We wish it was so; but in the

face of the facts our desire is to put forth a restraining hand, to assure them that there is no need to begin eagerly stimulating all and sundry, whether they need it or not. It will not be difficult to grasp our idea of good management when we say it is the stocks which *don't* 'get on' that require most attention in endeavouring to make them 'move' by supplying something they lack. Those that are safe and thriving will need no interference. A prevalent but rather mistaken impression prevails among inexperienced bee-men that 'a colony of bees may be built up to full working strength in six weeks' by the simple process of stimulative feeding. The numbers who have written us after trying this experiment, and failing, testify to the unreliability of the notion in its strict literal sense. In fact, some colonies cannot be built up to full working strength at all, and to suppose that weak stocks—without any reference to the inherent cause of their weakness—can be so built up is quite an error. Only hives with bees full of vitality and waiting but for the natural stimulus arising from partaking of freshly gathered pollen, or that just exposed in the combs by the consumption of its thin covering of honey, can be so aided by stimulating as to produce the desired effect. The slow continuous feeding apparently gives them the impression that summer is come—and no doubt breeding increases largely under its influence.

SPRING DWINDLING.—There can be no doubt that badly prepared and unwholesome food and cold damp hives are at the bottom of the mysterious and unaccountable 'dwindling' which troubles some bee-keepers in spring. The bees have all the heart knocked out of them by living on food which, though it might do no harm in warm 'flying' weather, so lowers their vitality in the long and close confinement of the winter that they can make no headway at all. A few eggs are laid, and are allowed by the poor debilitated bees to dry up and wither away, instead of hatching them out. Bees are continually dying off, or being lost through lack of strength to return to the hive against the force of a cold spring breeze. The few young ones which do hatch are too few to replace those dropping off, and so the population diminishes, dwindling away till the outside warmth of the summer weather assists the bees in hatching the brood, and perhaps after the season is well over the stock becomes just strong enough to carry on for another year. Meanwhile it is neither of 'use nor ornament.' The question is, 'What is the remedy?' And our reply, 'See to the food.' Even the hives are secondary in importance to this. The quality of the honey gathered in districts where 'spring dwindling' is periodical and chronic may have a deal to do with it, and in this case we advise wintering entirely on good cane-sugar syrup, and an avoidance of nitrogenous food altogether for winter, if possible. The less pollen bees consume in winter, the less occasion for their taking cleansing flights; and this is most important, as all will admit. Syrup made of raw

sugar is also very bad for the bees. Some of the samples forwarded to us—after the mischief had been done—would be little better than treacle for syrup-making. No wonder it produced dysentery and general weakness, which is the great cause of spring dwindling. A pint of bright, strong, healthy bees will often work up into a good stock, while a peck of weakly ones will fail and droop through sheer inability to obey the demand nature makes on their energies in hatching and rearing brood in spring.

SPRING OVERHAULING.—While desiring to restrain the anxious fingers 'itching' to begin manipulating as soon as the spring warmth brings the bees forth and their ever-tuneful hum is heard, we must emphatically urge the absolute necessity for a thorough overhaul of every stock in the apiary regarding which the least uncertainty is felt. To say that *every* colony must be examined carefully is contrary to the views we have already expressed. Good ones need no more than a glance beneath the quilts to make it certain they *are* good, and to note them as such. All the rest must be gone through, and careful notes of their condition taken for future reference.

It is most important that this be done for many reasons, but, among others, it enables us to consider and perfect our future arrangements with regard to each colony quietly from these notes indoors, without the need for constantly disturbing the bees, in realising what is required for meeting the necessities of individual cases. The time for making this examination will, of course, be regulated by the weather; when this is favourable, and the bees are able not only to 'turn out,' but to go off foraging for pollen, a start is made. Beginning at one end of the apiary (say of twelve hives), examine No. 1; next go to No. 6; then return to No. 2, and so on. Thus, as each stock is examined, the bees have time to settle down quietly before the hive immediately adjoining is opened; and there is less 'mixing up' of the flying bees during the excitement generally caused by the first 'overhaul' of the year.

With a full report of the internal condition of every stock in the apiary in his possession, the bee-keeper is saved a world of worry and trouble. He can just do the right thing required, while leaving what would be in too many cases the wrong thing undone. Colonies found queenless are dealt with by uniting, combs and food seen to, and that inestimable boon to a starving stock, a cake of soft, warm candy, administered where wanted. Once the bees are started on *properly made* soft candy, given below the quilts in spring, and the supply regularly kept up, they seem—according to our experience—to be stimulated and kept going better than in any other way.

ADDING TO WARM WRAPPINGS.—This is a point much neglected by careless bee-keepers, yet it is of considerable importance in early spring. At that time warmth means increase of breeding, and when, in giving a cake of candy,

the quilts are disturbed and disarranged, then carelessly replaced, the 'lump' formed by the candy makes them fit badly, the warmth of the brood nest escapes on every side, and unmistakable damage is done. Stocks cannot be 'built up' in this way. It is done by 'nursing'—*i.e.*, making the bees warmer and more snug than before by contracting the breeding space, doing away with winter space below frames, and stopping up all ventilation—just as the bees will themselves do as soon as propolis is to be had.

Our own plan is to remove the 'eke' (Fig. 5, p. 27) from below the body-box or brood chamber, and the latter is dropped down on the floor-board in its normal position. The 'eke' is next turned over or reversed, and slipped on the top of the body-box; the side slips—now turned downward—keep it firm in position, and the quilts, with the cake of candy beneath, can then be packed close down at the sides quite warmly, the sides of the 'eke' enabling us to do this more effectually than is possible when the coverings are simply laid on the flat surface of the top bars.

MAKING SOFT BEE-CANDY.—Before giving directions for making this, it may be well here to say a word regarding the prevailing uncertainty as to what is meant by 'soft bee-candy.' It should be quite firm and stiff, so as to bear its own weight without gradually falling down between the top bars, and yet of such a consistency that it becomes 'buttery'—to coin a word—when its surface is rubbed with the finger; just as a piece of butter will if treated in the same way.

Candy may be made 'short' in the grain, so as to break easily; but dry and 'crumbly,' without being 'stone hard.' This kind, however, is quite unsuited for bee-food in spring. Not knowing the secret of how the best Scotch bee-candy is made, we cannot print the exact *modus*, but fancy it is kneaded or worked well with the hands while 'cooling off,' and that this process of working gives it the soft, creamy character—like stiff chocolate cream—which is its point of superiority.

A good soft candy can be produced by closely adhering to the following instructions for making, written by the late William Raitt:—

1. Use preferably a brass jelly or preserve pan, otherwise an enamelled-iron or plain iron one. 2. Put in ten pounds of white granulated sugar at 2*l.* or 2½*l.* per pound, two pints imperial of cold water, and half a teaspoonful of cream of tartar. 3. Set on or hang over a brisk fire, and stir gently now and then till the sugar is all melted. This should require about fifteen minutes. 4. Almost immediately afterwards the whole will reach the boiling point, at first throwing up a deal of froth. The fire may be moderated or the pan withdrawn a little at this stage, when the foamy boil will settle down to a clear crackling one. This boiling should only occupy about ten minutes. 5. Now try a drop let fall on a cold surface, withdrawing the pan from the fire in the meantime. If the drop at

once begins to set so that in a few seconds it will draw out as a thread when touched with the finger, the mass is cooked enough. If not, boil a few seconds longer and try again. 6. Remove the pan from the fire, and set it in a trough of cold water. It may be left there for a few minutes while the moulds (flat or soup plates will do) are being set ready, each with a thin sheet of paper rather larger than the mould laid in. Returning to the pan, commence and continue to stir briskly until the mass begins first to get dim in colour from incipient granulation and then to thicken to the consistency of thin porridge. Then pour into the moulds, warming any remainder slightly to get it to leave the pan. This cooling and stirring process should take about fifteen minutes more. 7. Thus in about thirty-two minutes we finish the whole process, with the result that we have twelve pounds of candy from ten pounds of sugar. The cakes should set within an hour so as to be safely turned out of the moulds. When quite cold they should still be soft enough to be easily scratched into with the finger-nail, and to melt in the mouth with a soft grain. 8. Invert them over the cluster of bees with the paper left on, and cover up warmly. This may be done while they are still somewhat warm.

To the directions under No. 6 we would add the hint to 'work' the candy with the hands while cooling, in order to give it the 'buttery' consistency already mentioned.

SPREADING BROOD.—No operation we know of connected with modern bee-keeping has been productive of more mischief, through mismanagement, than indiscriminate spreading of brood in spring. If anything were wanted to confirm this view it would surely be found in the numerous samples of 'chilled brood' received during the early summer months of last year, the majority of which were the unmistakable outcome of this particular operation in the hands of inexperienced bee-keepers. Indeed, so disheartening is it when the mischievous effects of injudicious management in this line are brought under one's eyes day after day, that we have over and over again wished that brood-spreading had never been heard of, that it was eliminated from all our guide-books, or—let us add—that bee-keepers would only practice it when they had gained experience to guide them as to when it is *safe*.

Yes! this last reservation should be added; for in proper hands and at proper times it is so beneficial to do a little judicious manipulation of the brood combs, that we cannot wonder at writers possessing the necessary experience including it in the 'good things' they have to tell off. A sheet of foundation dropped in the centre of the brood nest in a strong colony during warm weather in April or May will often be partly drawn out, and contain some thousands of eggs, in about twenty-four hours after its insertion. And there is so much fascination in raising up that particular frame and finding it so, that one can hardly marvel at so many being tempted to spread brood, and

spread it till a sudden 'cold snap' comes, and finds the tender larvæ left outside the contracted cluster to chill and die!

To record the *gist* of these remarks in practical form, let us say to the inexperienced amateur: If you *will* try this operation, never part the cluster constituting the brood nest by adding more than one frame of comb or one sheet of foundation at a time, and then only when there is a spare seam of bees, on each side, beyond the combs which contain brood or eggs, so that the cluster may contract thus much without risk of leaving the brood uncovered. (A good deal is left unsaid as to directions for spreading brood, and it is omitted advisedly, because, speaking in the light of experience, and for reasons stated, we do not desire to revive a practice which, thank goodness! is falling into disuse.) It might be added that the risk is minimised when the weather is settled and warm; but the mischief is that it is only in early summer, when building-up is in progress and weather is uncertain, that brood-spreading is desired. In warm weather supers are on, and the brood nest is then safe from interference.

BRITISH BEE-KEEPERS' ASSOCIATION.

Committee meeting held at 105 Jermyn Street on Tuesday, 20th inst. Present: T. W. Cowan (in the chair), Rev. R. Errington, J. Garratt, W. H. Harris, Dr. Raynor (*ex officio*), and the Secretary. Communications were received from the Rev. Dr. Bartrum, Captain Campbell, and H. Jonas, regretting their inability to be present. The minutes of the last meeting were read and conveyed. Resolved, that the Chairman do convey the sympathy of the Committee with the family of the late Mr. Alfred Neighbour in the sad loss they have sustained, and express their appreciation of the valuable services which he has rendered to the cause of bee-keeping during the many years he was a member of the Association.

The statement of accounts for the year 1890 was considered, and, after some discussion, adopted and ordered to be printed. The Secretary was requested to communicate with the Dairy Farmers' Association, with the view of securing an exhibition of honey at the next Dairy Show.

We desire to remind the members that Saturday next is the last day for sending in notices of motion for discussion at the annual general meeting, and also for nominating members to serve on the Committee for the ensuing year.

NOTTS BEE-KEEPERS' ASSOCIATION.

The annual meeting of the above very active Association takes place at the People's Hall, Nottingham, on Saturday, the 7th of February. The President of the Association, Viscount St. Vincent (himself a successful bee-keeper), presides on the occasion, and will be supported by the Mayor of Nottingham. At the conclusion

of the business portion of the proceedings, which commence at 3.30, the members and their friends partake of a substantial 'meat tea.' A 'social evening' follows, when the annual prize drawing takes place. Then follows a lecture on 'Bee-keeping' by Mr. John H. Howard.

Altogether the proceedings are so arranged as to make up a very enjoyable evening, and reflect much credit on the gentlemen concerned in making the arrangements.

DEVELOPMENT IN THE HONEY-BEE.

By R. A. H. GRIMSHAW.

(Continued from p. 7.)

Continued sunlight in many cases results in the removal of the blue from the green, leaving yellow; the yellow fades into almost white, or else by absorbing red becomes orange; the orange loses its yellow and gives place to red; varying chemical changes in the sap alter its light-refracting power until we get all the intermediate colours between red, yellow, and blue—orange, green, purple, russets, browns, citrons, olives, greys, in their many hues and intensities from the white to the black (in violas alone). Well, if bees carry pollen and cross-fertilise the plant it is left on, the pollen cell gives up its contents to the cells of the seed, in which they are absorbed, and give to the seed certain peculiarities possessed by the plant from which the pollen was obtained, contributing such chemical power to the future plant as enables it to derive from the earth, air, light, &c., substances which change the tints of the flower, the aroma of the nectar, the flavour, size, and colour of the fruit, or the subtle active principle of the plant itself, which may prove to the animal kingdom either a wholesome food, a restorative medicine, or a deadly poison.

For instance:—A bee visiting red flowers for either nectar or pollen carries on its body-hairs a few adhering grains from flowers visited on a previous journey; these flowers may be of a deeper shade than the red (say, purple—by admixture of substances which enable the plant-cells to reflect more blue), or of a lighter shade, say, orange—by reason of cell-contents absorbing more red and reflecting more yellow); it then becomes very plain to see that the pollen grains, containing vivifying nitrogenous matter secreted by the male parent plant, left on the stigmatic surface of the plant destined to bear the future intercrossed seed, will so chemically alter the nature and composition of the cell-contents with which their cell-contents coalesce that the future reflecting and refracting power of the cells of the flower petal will be considerably modified—the flowers will partake of and resemble the colours of the male parent. We see, then, that the alteration of the colours in cross-fertilised plants, the passage from green flowers to white—green to red, yellow, or blue—is entirely the work of the male pollen brought from plants which have perfected in their cells a greater power than their neighbours of reflecting the composing colours of

a white ray of light, this power in its turn being traceable to the greater or less ability of the plant-cell (from the cell of the petal to that of the spongole of the root) for secreting such chemical substances from the soil as give it this power. The same rule applies with regard to the fragrance of the flower, the aroma of the essential oil found in the hairs on the leaves, in the sap of the leaves, in the strong medicinal alkaloids lodged in many barks, in the poisonous pith of many plants (the manioc, for example, which yields us, after steeping, tapioca). These active principles show themselves also in the nectar produced by the flowers, which is gathered by the honey-bee, and converted by it into honey. But we must not forget that if this nectar contained much more of the plant-essence than it does, the honey would lose its wholesomeness for us—would be too medicinal and become absolutely poisonous. That a quantity of pure honey in bulk, from only one species of flower, is positively injurious to many peculiarities of constitution cannot be denied; but this objection is removed or obviated in this country by the fact that a great variety of plants bloom at the same time, the honey from which negatives each other's injurious properties; thus do we get, almost always, in our honey, a compound sweet extract of flowers, the medicinal beneficial effects of which our individual systems partake of, whilst, in most cases, the injurious and poisonous nature is annulled by the fact that one poisonous essence is generally antidotal to another. In this country the danger we run of having large quantities of honey from one source only is mostly confined to sainfoin, clover, and heather. Each of these honeys will be found to disagree with some idiosyncrasies of constitution, though fortunately the percentage is so small as to be of little account, the essential principle of each plant not being poisonous to man except in concentration; and even this question—the poison of heather or clover in a concentrated extract—is only a surmise of my own drawn from analogy, believing as I do that every plant could be found to yield a substance fatal to human life if partaken of as a very strong extract. Although the medicinal properties of honey do not come within the province of these articles I cannot refrain from saying that its use in the relief of human suffering, and for the cure and prevention of disease, is as yet but little understood. I doubt not there is a great future for honey in this direction when scientific medical men will recognise that a natural compound of medicinal essences is present in honey, which may be of as much service in its proper place as an artificial compound syrup of hypophosphites is in its place in the pharmacopœia.

The value of insects—bees amongst the rest—as cross-fertilisers has become somewhat over-estimated. There is always this tendency where a great discovery has been made; indeed, so much is this the case that a common opinion prevails amongst those only slightly acquainted

with botany that plants using insects as pollen-carriers find them absolutely necessary, and cannot ripen seed without strange pollen being brought to them. There can be no greater fallacy than this. The exhaustive experiments of Darwin provide us with a list of sixty-three plants 'which, when insects are excluded, are either quite sterile, or produce less than half the number of seeds produced by unprotected plants.' Only twenty-four of these are quite sterile, the remaining thirty-nine were capable of self-fertilisation. In the next list given, of 'plants which when protected from insects are either quite fertile, or yield more than half the number of seeds produced by unprotected plants,' there are sixty, and of these no less than forty do quite as well without insects as with them. Of the 123 plants experimented on there were, therefore, but twenty-four that entirely depended upon insect visitation for the setting of their seed. Amongst those which seem entirely independent in the matter there are many surprises: Candytuft, mignonette, buttercup, poppy, fumitory, Adonis, linseed, balsam, the far-famed *Limnanthes Douglasii*, chickweed, beet, tares or vetches, common pea, sweet pea, lupin, rest-harrow, kidney bean, haresfoot clover, yellow clover (this, strange to say, when protected from insects yielded nearly twice as much seed as when unprotected), eye-bright, mimulus, calceolaria, mullein, and parsley. On the other hand, we know of numerous plants, visited by bees at least, which yield more and finer fruit (for the seed is the true fruit) when so visited than when deprived of their services; nevertheless it behoves us not to unduly magnify the extent of the benefits thus conferred. If we take our particularly favourite white, Dutch, or alsike clover, Darwin gives us some startlingly consoling statistics. Ten unprotected heads gave about ten times as many seeds as ten protected heads, and in a further experiment twenty unprotected heads gave 2290 seeds to one solitary aborted seed from twenty protected heads of this clover. The red clover surprises us still more, for 100 heads of bloom (protected) did not give a single seed against 2720 yielded by the same number of unprotected heads. The carnation clover gave five and six times as many seeds unprotected as against protected plants. When we come to consider the great value of bees to man in cross-fertilising the plants used by him in feeding himself and his cattle, the fruits in his garden, and the produce of his fields, we have, I think, reached the true platform—the acme of its place in the scale of animated nature, as a not insignificant member of that vast mutually interdependent family of living things, which go in chorus to form on the earth perhaps but a single chord in the grand harmonious whole of the universe. I may, however, be too sanguine in holding the opinion that in the future no inconsiderable amount of credit will be given to the honey-bee as a collector of medicinal food, probably of more real service to humanity than is its work of cross-fertilisation.

(To be continued.)

Correspondence.

The Editors do not hold themselves responsible for the opinions expressed by correspondents. No notice will be taken of anonymous communications, and correspondents are requested to write on one side of the paper only, and give their real names and addresses, not necessarily for publication, but as a guarantee of good faith. Illustrations should be drawn on separate pieces of paper.

Communications relating to the literary department, reports of Associations, Shows, Meetings, Echoes, Queries, Books for Review, &c., must be addressed only to 'The Editors of the "British Bee Journal," 17 King William Street, Strand, London, W.C.' All business communications relating to Advertisements, &c., must be addressed to Mr. J. HOSKLE, Kings Langley, Herts (see 1st page of Advertisements.)

* * * In order to facilitate reference, Correspondents, when speaking of any letter or query previously inserted, will oblige by mentioning the number of the letter, as well as the page on which it appears.

FOUL BROOD AND ITS REMEDIES.

[522.] Referring to page 41 of your last issue, allow me to congratulate you and to thank you for taking down what I call Yankee impudence.

Naphthol β.—I have been anxiously looking for further information, opinions, experiences, or suggestions regarding this antiseptic. Having seen nothing in your valuable paper since your translation of Dr. Lortet's article in the issue of January 8th, I venture, subject to your correction, to make a few remarks and suggestions, in hopes that others may follow suit, in order that the most practical means may be devised for trying this method for curing foul brood, so scientifically interesting, as well as, we hope, so simple and so useful.

Naphthol crystal or naphthol β ($C_{10}H_8$) is a white, crystalline, solid substance obtained by distillation from coal-tar. It is sold at about 1s. per ounce. According to Dr. Lortet, when this naphthol is mixed with the food of bees, it kills the foul-brood bacteria which infect the digestive canal of the bees and larvæ; and he says that it is impossible for these bacteria to exist in substances impregnated with a solution of this naphthol crystal.

The strength of solution he recommends is $\frac{1}{3}$ of a gramme of naphthol to 1000 grammes of liquid food. This is about one drachm ($\frac{1}{2}$ ounce) to twenty-four pounds weight of thin syrup, as used for spring feeding, or about one drachm to every stone of sugar.

May I suggest the following mode of application, and submit it to the criticism of your readers?—Obtain one ounce of the naphthol crystal, put it in a 'doctor's bottle' marked on the side into tablespoonfuls; pour in eight tablespoonfuls of water, and add a few drops of spirits (brandy, whisky, &c.); keep well corked. When about to make syrup for your infected bees, add to the water you are about to use the contents of this bottle in the proportion of one tablespoonful of the bottle to every fourteen pounds of sugar. If you are making thick syrup do not add quite so much of the solution; if you are making candy, do not use much more than half of the proportion given.

As soon as foul brood is discovered in an apiary, I think I should recommend the following plan: In the case of hives not much infected, extract all honey, even from brood frames, and feed on the naphtholised syrup in closed hives for three days.

In case of hives badly infected,—

1. Remove all combs from the bees and feed with the antiseptic syrup in closed hive for three days.

2. After this give frames of foundation or clean combs. Allow bees to cluster on these frames, then place them in new hive and allow to remain on the old stand. Continue to feed for a few days longer on the prepared syrup, until sufficient stores are gathered.

3. Remove and burn all dead bees remaining in old hive, melt down wax, and thoroughly disinfect hive with benzol solution or carbolic acid.

4. As to the infected combs you have removed, extract all honey from them. In removing from the hive, allow a sufficient number of bees to remain on combs to tend the brood. Place in new hive, and feed on the naphthol syrup; keep hive closed for a few days, then raise hive, change or clean the floor-board, burning all dead bees, &c. In twenty-one days all the brood will be hatched, and another queen raised, and perhaps laying. I think I should then transfer the bees to new frames of foundation and a clean hive, or to the original hive now disinfected, and I should melt the wax in old combs, burn frames, and disinfect hives. The stocks may then be reunited, if desired.

It would be interesting to note the result of such treatment.

The danger to be apprehended will be, I think, not at all from bees able to fly after having been kept in the hive for a time with none but antiseptic food, but from dead bees, brood, infected combs, contaminated honey, &c., which being permitted to remain in hive may cause a renewal of the disease. We are told that contaminated honey can cause foul brood by communicating the bacilli to the digestive canal of the bees: and we are told that the surface of the wax also holds the bacilli, and we know, of course, that the dead bees and dead brood are full of them. The living bee, by absorption of naphthol, is cured, for the naphthol kills the bacillus; but what about the bacilli in the dead bees, &c.? If the bacilli will only live a certain limited time in dead matter, then by keeping our living bees healthy for that time, the disease will be stamped out; but we are not told how long the bacillus will retain vitality in such dead matter, nor do we know if it can propagate itself therein, or if, on the contrary, the living organization of the bee is necessary for its reproduction. Until this is known to us, we cannot be too careful in destroying everything that can harbour the deadly microbe.

Surely, should practical experience bear out the results of the remark of Dr. Lortet, no bee-keeper will hesitate as to the manifest truth of

the micro-organism theory. Apologising for troubling you,—W. J. SMITH, *Mortonley, near Sheffield, January 24th, 1891.*

NOTES BY THE WAY.

[523.] The thaw has come at last, and to-day the apiary is cheerful with the warm sun and the humming bees—poor things, they must require a cleansing flight very badly, as the interiors of the hives demonstrate! But then it is eight weeks since they had a fly before. Taking a peep on the 21st inst., I took the opportunity of looking through my home apiary to see how the stores were lasting, and found two colonies defunct: one a fair colony in a makeshift hive of half-inch board, and no winter passages or device to afford passages over the frames (as it was intended to change this colony into a new hive which required painting when my apiary was packed for winter): this colony was neglected till it was too late to shift them, and the consequence is I have lost them—either by extreme cold or for want of more protection, or for want of passages, so that the food in outside frames could have been reached easily and stored where wanted in the centre combs. The other colony was a good one, and I am very vexed about it, as I allowed them to starve to death. I packed them carefully in a combination hive, and, when doing so, marked the register 'wants a large cake of candy,' and on closing the hive I must have omitted placing the usual indicator, 'a half-brick,' on the top to call attention to it, with the result that it was forgotten, and the colony perished. On the 22nd I visited my Stanmore apiary and cleared entrances, taking a peep by removing chaff-cushions and turning back a corner of the quilts. This, if carefully done, does not disturb the colony, and is proof positive of the condition inside, as a glance of even half a minute is better than half an hour's guessing.

Soft candy cake I consider the best form of winter food for bees: in fact, I find my bees take it in preference to honey—at least, they consume it before they do the sealed honey in the combs around the cluster—perhaps they mix it to their liking, and use more cake than they do honey.

This is the last January issue of the *B.J.*, and I hope its readers will not forget to place their orders for hives and appliances, so that the maker or dealer may have time to attend to them, and get them made and delivered before the busy time comes on. To the bee-keepers who live in the 'Royal counties,' who want *first-class* work combined with moderate prices, I would commend a well-known dealer living among themselves as one to place their orders with.

The amount of stores required by a colony during the winter is variously stated by different writers—or shall I say bee-men? Some place it at ten to twelve, others fifteen to twenty, yet others twenty to thirty pounds. These last are

probably those who work on the let-alone system. The old adage that proclaims 'There is a medium in all things,' applies with considerable force here, and I think that fifteen to twenty pounds is ample for winter stores. The race of bees may have something to do in the matter, as those foreign early and late breeders will use up more food than our native race, which, as a rule, do not begin extending their brood nest till late in March.

Berkshire Association.—What has become of our county Association—erstwhile the most prosperous and progressive of all county Associations, yet now dormant? Let us hope not quite dead, but only hibernating, to awake to greater energy and usefulness in the good time coming. It is usual to hold the annual meeting late in January, but up to the present no notice has been issued as to the date or place of the meeting.—W. WOODLEY, *World's End, Newbury.*

IS MEAD-MAKING ILLEGAL?

[524.] Referring to No. 509, page 33, of your issue of the 15th inst., should the zealous officer referred to make good his case, I am afraid it will be rather against the interest of bee-keeping, as a number of bee-keepers make use of their refuse by washing and making a very palatable beverage therefrom. I do not see how the officer is going to get at 'H. Langdon' for making mead for his own use. Of course, as the heading indicates, 'selling' is not now in the question.

Mead and metheglin come under the category of 'sweets' or made wines, and a licence is necessary for the sale thereof, but I am unaware of any licence being necessary for their manufacture.

Beer is defined *inter alia* 'any liquor made or sold as a description of, or substitute for beer, which contains more than two per cent. of proof spirits' (48 and 49 Vict., cap. 51 sect. 4). I would say, however, from the limited quantity made at any one time, the mode of manufacture and of use would not bring it under the above Act, and render the maker thereof liable to the brewing licence under the Beer Act, 43 and 44 Vict.

I think with you, however, that should a fair case be brought forward, there would be a difficulty in getting the Commissioners to sanction a prosecution, and a still greater difficulty in getting a magistrate to convict. I should be interested to know (if 'H. Langdon' will inform us) under what Act the officer is going to proceed against him, and I am sure a large number of bee-keepers must be interested in this question. I myself am fond of mead and metheglin, and do not wish to have to pay for the making of these drinks for my own use, and do not see why I should do so, when I can make any description of wine at home duty free. I am afraid you will think my zeal leans more to the bees than the revenue; however this is not so, although I am—A BEE-FEVERISH EXCISE OFFICER.

ENGLISH BEES *VERSUS* HYBRIDS.

[525.] Kindly allow me a word on the subject of native bees and their supposed superior qualities over foreigners and hybrids. To-day I found two pure English stocks dead, with plenty of stores in each case, while my remaining forty-two colonies are alive and apparently doing well. I may say one of the English stocks was not fed in autumn, and the other with only two pounds of syrup, as I found they had enough honey to winter on. I took these two stocks of bees in frame hives of a neighbour last summer, so I feel somewhat contented about my own make of hive and also the breed of bees, inasmuch as if forty-two stocks safely live through such a frost as we have had this winter, without an exception, there can be no room for discontent with one or the other. My bees, with the exception of a few driven stocks, are hybrids, with about an equal part of Cyprian, Carniolan, and English blood, which cross I have found to be far superior to the old English black bee, for the three elementary qualities of honey-gathering, prolificness, and wintering. Very much has been said against the Carniolan breed lately, and if all seasons were like 1890 I should quite agree with it, for a cold, wet summer is altogether against the progress of the foreign races; but in such a summer as 1885 or 1887 no one can deny the superiority of the working qualities of Cyprian and Carniolan hybrids over pure English bees.

I had Cyprian hybrids at the end of 1887, with all their combs full of honey, while English stocks had combs scarcely half full. Of course 'every dog has his day,' but because the foreign races have been lauded above measure it does not follow that they should be discarded from our apiaries.

If in-and-in breeding has been the chief ruin of the British bee, surely the introduction of foreign blood is the nearest way out of the wood, and scarcely any one can fail to notice the deterioration of the ordinary English bees through in-breeding, as they are usually kept by cottagers. The same stocks, with the same queens, that gave me forty to fifty pounds of surplus honey in '89 did not store enough in '90 to winter on. Shall we blame the bees for it? No; I am quite sure my bees were as willing to work in '90 as in '89. I had the good or bad fortune to see six swarms come out successively one morning, and all settle in one lump; and as I had another small 'cast' the same day I hived the seven swarms of bees in one hive on ten frames and 105 one-pound sections. They joined peaceably and started work well, but that was all; the wet weather kept them at home so constantly that by the time the bees could work their numbers were much reduced. Had the season been a good one the 105 sections would have been complete in a fortnight, for the hive was literally crammed with bees; but as it was, I scarcely had a finished section from them.

Such an autumn for winter preparation as the last I have never seen before, and a winter such

as we are passing through I have never before witnessed. Only about half the young queens of last year were successfully mated, so by the time the second lot of queens, raised to replace the unfertile ones, began breeding, these stocks had dwindled very much; but by careful attention and feeding they became strong again, as the weather was splendid from the third week of August till the end of October.

Following some exceedingly trying years for the patience of bee-keepers, let us hope that the present extraordinary winter will turn the tide, and that a few old-fashioned summers will follow so old-fashioned a winter. I only took 550 lbs. of honey last summer, while less bees gave me 1069 lbs. in 1889.

In conclusion, let me advise others not to throw up any race of bees after trying them for one season, nor because they may be fond of stinging, for I have found that good stocks will always be ready for invasion of their domiciles.—ERNEST E. DAVIES, *Great Bookham, Leatherhead.*

AGED QUEENS.

[526.] Late last autumn, as I was examining a hive belonging to a member of the Lincolnshire B. K. A. in this district, to see how it stood as regards stores, and to put it into order for winter, I observed the following, to me, unusual circumstance, which has considerably puzzled me to account for; and as the experience may point a moral to keep respectably behaved young queens only, I will relate it, feeling sure that you will, with your long experience, be able to enlighten me.

The hive was a 'combination' one of Abbott's make, the bees slightly hybrid, fairly strong, and with twelve frames in the hive. They had gathered about fifteen pounds of honey, stored chiefly in the neighbourhood of the brood nest. I commenced the examination by removing the dummy and the last four frames, and on looking through the other frames I kept an eye open for her majesty—for as all brood-raising had then ceased hereabouts on account of the cold summer, I did not expect to get any evidence of her in that line. In the centre of the brood nest, however, I saw some eggs in scattered patches all over the frame, two, three, four, and even five in one cell, and I began to think a 'fertile worker' was to blame; but on turning the comb round, I immediately saw the queen. She was a good-sized one, aged at least two years, as the hive had not swarmed this year (1890), and the owner was not sure about 1889 either. Do you think the eggs were deposited by the queen, as it had been very fine for a few days before I examined the hive, which was towards the end of September? I did not have a further opportunity of seeing if the eggs came to anything, neither did I see any signs of the bees having swarmed, in the shape of old queen-cells. No drones were anywhere about at that time, or I should have thought

they had deposed the original queen, and that the new one had remained unfertilised.

Now, having given you all the data and symptoms of the case at my command, I hope you will be able to solve it. Thanking you in anticipation,—F. J. CRIBB, *Morton, Gainsborough.*

[Aged queens are very erratic in their ovipositing, and act much in the same way as fertile workers. We should judge this queen to be an old one.—Eds.]

ROYAL SHOW—PRIZE SCHEDULE.

[527.] I am pleased to note that no price is fixed for hives, &c., in the prize list just issued. Although it will not affect me personally, yet I think the Committee have taken a step in the right direction, as I know the schedules of the past led to dishonesty, and landed some manufacturers in the Bankruptcy Court. Every trader is entitled to a *fair profit*.—L. WREN, *Lowestoft.*

HIVE ENTRANCES IN WINTER.

[528.] For many years I have been opposed to leaving the entrances to our hives open, 'full width,' during the winter months, and no doubt many a thoughtful bee-keeper, who has had the welfare of his bees at heart, will have partly closed them in such a winter has this has been.

All my entrances are through two-and-a-half-inch tunnels in the bee-house, and these are greatly reduced in width at the outside, thus practically carrying out the Editor's idea as expressed on page 27, where it is stated, 'We regard it as one of the best points in a hive with outer case, that a full-width entrance and its accompanying advantages is practically secured, while the doorway to the outside, of only half an inch in width, keeps out piercing cold winds and driving snow, &c.' My bee-house (heated) forms the outer case of my half-inch beehives.

Very often the snow is our best friend, when entrances are closed up completely by it, because a frosty night generally follows a downfall; but we must not forget that the snow by degrees disappears, and frosty nights continue. The snow, up to a certain date, has kept our entrances closed, and all warm inside; but this month there is no snow left here, so I have kept my entrances closed with imaginary snow, by placing a little white crystallised sugar instead outside of the entrances, and with good effect.

I see a writer in a German bee journal, *Die Biene*, has taken the inside temperature on the floor-boards of three hives on November 30th of last year, while the thermometer outside registered 11° of frost (or 21° Fahr.) The result was as follows:—

- No. 1 (weak colony) . . . 26°, or 6° of frost.
- No. 2 (medium strength) 28°, or 4° of frost.
- No. 3 (strong stock) . . . 31°, or 1° of frost.

Then on December 9th the same experiment

was tried after the entrance had been protected by a moss cushion with an air-hole to the outside. He registered inside:—

- No. 1, 32°, or freezing point;
- No. 2, 39°, or 7° above freezing point;
- No. 3, 41°, or 9° above freezing point;

whilst the outside temperature was 17° of cold, or 15° Fahr. It is stated that an average temperature of 12° warmer results in favour of the protected entrances and surely tells its own tale. How differently the bees feel the winter's cold with protected entrances.

What distances entrances may be from the hives! The *Bienenzeitung* has the following, referring to Weygandt's heated bee-houses:—A bee-keeper living next door to a baker, placed a hive against the warm oven of the latter, and the tunnel through which the bees had to travel to reach the hive measured three yards long, with several turns in it! Nevertheless this stock swarmed last summer, the young queen took her mating trip, was fertilised, returned through this long tunnel, and the bees have done remarkably well.—J. G. K., *Grove House, Southborough, Tunbridge Wells.*

BEE-KEEPING NEAR TOWNS.

[529.] 'Roman Wall' (No. 508, p. 33) asks in what part of Newcastle I keep my bees. Had he, instead of 'wandering by the moor edge,' turned along to the left at the commencement of the moor from the town side, he would have come to a terrace of houses with long gardens in front. Beyond these is the Leazes; beyond this again the Leazes Park, while at the back of the houses stretches the moor, the whole comprising an open space of about 1200 acres of grass-land, park, and gardens. On the moor and Leazes there is a fair growth of white clover at the proper time, while the gardens and park are well filled with flowers during the season.

But when 'Roman Wall' asks for an account of my success—there! I confess he 'has me.' This is only my third season of bee-keeping. The first winter I sent you an account of how I lost my whole stock through inexperience. Last spring I was staying in the country, and made friends with a bee-keeper there, from whom I purchased a good stock. These, I believe, would have done fairly well last year had not the season been such an extremely untoward one. However, I fed them well up for the winter, and hope for better things this year; but as I keep bees for the pleasure of seeing them and not for profit, a larger or smaller quantity of honey is not of much consequence to me. There are, I think, other five or six bee-keepers within a radius of half a mile or so. The greatest difficulty we have to deal with is in preventing small boys from catching the bees and putting them into bottles with a few heads of clover, under the mistaken impression that they will 'lay honey.' One boy told the gardener that he had caught 200 of my bees in one week last summer.

I enclose you my address should 'Roman Wall' care to ask for it, and will be heartily glad to see him at any time if he is passing this way. I know Haltwhistle, well where he dates from, having spent many a pleasant day in fishing the moorland streams to the north of it, and the next time I am there I will certainly give him a call.—*AMATEUR, Newcastle-on-Tyne.*

'CHEAP HIVES.'

[530.] Under the above head, which I respectfully borrow from Mr. 'T. F. L.', I wish to describe how myself and others about here make some of our own appliances; but first, with your permission, I wish to thank 'T. F. L.' for the 'pudding' (W.B.C. body-box and bar-frames with metal ends) he has sent to me by Mr. J. H. Howard. Puddings never come amiss at Christmas-time, and I assure 'T. F. L.' I have great pleasure in accepting it. It is, I must say, indeed very cheap at 3s. cost price, and for many not accustomed to using tools, it would be cheaper in the end than any imperfectly 'home-made' article. Still, as there may be some amateurs who, like myself, would rather save 3s. than spend them, for their benefit I shall describe how I make my appliances.

Let it be understood, however, that I do not lay claim to much, if any, originality of thought or design, except it be in making practical use of the instructions often given on this very subject, and also utilising boxes and other material (which otherwise, in most cases, are allowed to go to loss) in making our bee-requisites, thus minimising expenses—the point in question. In making the body-box, I select two boards $19 \times 8\frac{3}{4} \times 1$, and two others $17 \times 8\frac{3}{4} \times 1\frac{1}{4}$, which I plane smooth, edges and ends included, especially making the latter of the shorter boards perfectly rectangular. I now apply a coat of rather thick white lead paint to these ends, and proceed to bore three holes in each end of the longer boards, and nail them to the shorter ones with 3-inch wire nails, making all quite flush outside. To make sure of having it rectangular, I hold the square to the corners inside whilst nailing. I have now four sides 17×17 inches inside measurement. Next I lay the square $1\frac{1}{4}$ inch from the end inside, and with a strong sharp penknife or chisel cut a mark down the whole depth of the board. I then shift the square almost half an inch nearer the end, and make another cut in the same manner. I do the same on the other end, and also on those of the opposite side. Having taken a little of the wood out between these cuts with a $\frac{5}{8}$ -inch chisel, I further deepen the groove to about a $\frac{1}{4}$ -inch with the help of a tenon saw. Two boards $17\frac{1}{2} \times 8\frac{1}{2} \times \frac{1}{2}$ in. are next planed, and, first having painted their ends, they are pressed down into the grooves, which also should be painted, to the bottom. The top edges of these boards should be chamfered, sloping up towards the inside of the body-box at an angle of about 45°. On this chamfered edge a strip of zinc should

be nailed, which forms a very good *metal* runner for the frames.

A neat-fitting piece of wood must be nailed in between these two walls at bottom and top, making simply a 'dead air-space.' To prevent any possible shifting of the inside board in the groove a small wire nail might be driven through their ends from the inside into the outside walls. Two close-fitting dummies, one on each side of the frames, can be used in winter, thus making the body-box equal to being double-walled on all sides. To make the bar-frames I get a piece of clean board 3 ft. \times 9 in. \times $\frac{1}{2}$ in., the edge of which I plane; then with a moving gauge I mark a strip up the entire length, $1\frac{1}{2}$ in. wide, which I cut off with a fine tenon saw. I again plane this edge level and take another strip off in the same way, and so on till I have five strips cut. I now proceed to cut each of these in two, and having marked off exactly 17 ins., I cut them perfectly square in a mitre cutting block, which is provided with a saw-run for cutting squares. These strips are then marked down the centre and a slit cut in each (to hold the foundation) almost their whole length with a rather fine rip-saw. Next I make a mark round the four sides at $1\frac{1}{2}$ in. from each end. I then set the moving gauge at $\frac{1}{4}$ in. with a tooth $\frac{3}{4}$ in. and draw it up and down between the marks, and with a fine tenon saw I cut through at each end to the scratch, when the centre pieces can easily be detached with a chisel, watching which way the grain runs. The ends are next cut, $7\frac{3}{4}$ in. \times 1 in. \times $\frac{3}{4}$ in., in long strips of about 3 ft. first. To make sure of having these all the same length I put a stop on one side of the mitre block at $7\frac{3}{4}$ in. from the square saw-run. The bottom strips of $\frac{1}{2}$ in. thick I cut in a similar manner. In nailing the frame together I have a board perfectly rectangular and of the exact size of the inside of the frames, fastened with ends at right angles to the bench. I now bore two holes at each end through the top bar from the under side, so that there may be no protrusion of the wood to prevent it lying quite flat on the top of the end pieces. I now place the top bar on the upper edge of the block, and drawing the end pieces up to the ends of the same, I drive two $1\frac{1}{2}$ in. fine wire nails through into each end.

It is very important to have the whole kept in a perfectly rectangular position when nailing. I have learned thus much by experience, that if the frame is nailed out of shape it cannot easily be set right afterwards. The bottom piece is then tacked on, and the whole is ready for use except to put in the foundation, which is readily done by springing the centre slit with a chisel, and gently pressing the foundation in from end to end till it is sufficiently caught. I will not describe how I make the floor-board and cover, as every one has his own idea how these should be made, and mine might only evoke criticism. As regards smokers, I have made excellent ones at a total cost of sixpence. I simply use an empty Newsom's coffee canister for the barrel. The nozzle is also made out of any waste piece

of tin. In cutting out this I use a paper pattern to guide me, which is more easily cut to the right shape so that when folded it will assume the desired tapering shape. As every one is familiar with the appearance of the Bingham Smoker, for instance, I shall not further describe it. I rivet the nozzle and rim which goes down on the barrel with one-sixteenth of inch copper wire. All the laps, before being riveted, should be coated with paint. The canister is double-lapped, so there is no possibility of it coming asunder with the heat. I use a short coil of wire for the bellows spring, and a piece of perforated tin in the barrel to prevent the burning material getting into the pipe. In riveting I may just say I pierce the holes with an awl the same size as the wire, and I use the horn of a pick as anvil, which answers admirably. As regards the mounting of the bellows I consider this more easily done than described, and any one can suggest a method for himself. Respecting veils, I use one I made out of hexagon netting with a mesh about one-sixteenth of an inch. This is a material generally used for protecting fruit-trees from frost, &c., and is well known to all belonging to my craft—*gardening*. I make mine as is generally described, except that I have a light willow hoop sewed in to keep it from my neck. The end of the veil I tuck not under the collar of my coat but inside, and then button my coat over it.—G. J., *Ashfield Lodge, Cootehill, Ireland.*

Queries and Replies.

[302.] *Restless Bees—Is it Dysentery?*—I have at present five stocks of bees (natives) in frame hives. For a fortnight past three out of the five have been unusually restless, and for the last few days still more so, coming out and for the most part dropping on the ground in a helpless state, never to rise again, the ground in front of the hives being strewn with dead bees. On Saturday, the 17th inst., I saw some come out, rise in the air, and fly right away, as late as 4.30 p.m., yet it was freezing hard all day long. I may say they are disturbed by neither mice nor tits, and the hives have been well watched to try and find out the cause of their being so restless. I have not disturbed them in any way, except to remove the dead bees, &c., and I have carefully shaded the hives in front, and covered the top of the hives with sacks, so that the warmth of the sun should not tempt the bees out to their destruction. They have plenty of food, though not fed up until almost the end of October. (I could not do the feeding before.) The hives have good roofs and are double-walled, with chaff packing. I noticed the other day that the bees had been discharging dark-coloured, offensive-smelling matter inside and outside their hives, which I think, from the description in *Guide-book*, must be dysentery. Would the late feeding and long confinement cause that complaint and thus account for the

commotion? I have sent you a few of the bees to examine: the live ones seem bright and clean.—BRICKMAKER, *Horsham.*

REPLY.—If the 'specking' outside the hive and on the combs is excessive, no doubt the bees are suffering from a mild attack of dysentery. We say 'mild attack' because the bees sent show no signs of bowel-distension. They are quite in the normal condition of bees which have died a natural death. Was the syrup made from unsuitable 'sugar'?—because, if so, that might account for the restlessness and commotion, while the extreme cold would render it very doubtful whether bees flying abroad under such conditions would ever get back home. Examine the hives the first favourable opportunity and see if anything in their interior condition will help to clear matters up. If necessary, write again and report their condition later on.

[303.] *Raw-sugar Syrup and Dysentery.*—Through some mismanagement (? giving syrup made of raw sugar) two or three of my hives were attacked with dysentery, and the bees are all dead; but before they died they tore off all the cappings of the combs, and have left the hives and frames in a great mess. Must I burn the frames, or can I extract, {disinfect, and use them again, or would the frames come in again if baked after removing comb and dirt?}

REPLY.—Our impression is that the bees of some of your other hives have 'torn off all the cappings of the combs.' Dysenteric bees are not in a condition to act in that way, and it is probable that after the diseased colony perished some other stock has been engaged in appropriating their stores. If the combs are melted down for wax, the frames may be used again without risk after scraping.

Echoes from the Hives.

Honey Cott, Weston, Leamington, January 24th, 1891.—I am very pleased to say that my bees had a grand fly on Tuesday, the 13th inst., although the thermometer only reached 43°, but the sun shone nice and warm, and it was very calm. As the ground was covered with snow I took the precaution of shaking a lot of loose dry straw over it all among the hives, thereby preventing many bees from losing their lives by being chilled. I took the opportunity to look over any stocks that I thought might possibly be getting short, and gave them a good-sized cake of soft candy under the quilts. One lot was rather too quick for me, and a bee saluted me just under the eye. When I went down to the house, Percy says, 'My father seems as though he liked it!' Certainly, I may say, I did not dislike it, and it soon passed off. For several days the sun shone warmly on the hives, and I thought of what friend Abbott used to recommend years ago, of having a sheet of glass let into the front of the hive, so that it could warm up the bees to enable them to move to their food

I think the bees must have had some intuitive knowledge of what was coming further on, for at night it began to freeze again, and continued through the remainder of the week, but only a few degrees of frost, till Sunday morning early, when we had 24° of frost. However, the sun shone warmly during the day, but the cold at night was more intense than ever, culminating on Monday morning in 26° of frost, the lowest temperature we have had here all the season. What a winter! such as we have not had for years. I have found three stocks that have lost more bees than I like, and I find they had eaten up all their food on the combs where they were, and the others were cram-jammed so tight they could not get by them to the food. Certainly, if I had thought we should have had it so long and so sharp I would have put a large cake of candy on every stock I have. I had three stocks of bees given me in the autumn by a gentleman at Leamington, and as he had prepared them for winter, with enamel cloth on top of frames and quilts, I thought I would let them go; but as the frost wore on, I did not like the look of the entrances, so I turned up the corners of the enamel cloth to let out the moisture. There was a lot of water in the recess where the frames lodged on, but as there were no metal ends I suppose the moisture condensed and dropped into this recess. Well, friend Abbott will say, 'I told you so.' After I turned up the corners I covered them up again with some porous material, so as to let off some of the exhalations of the bees. All right, 'X-Tractor,' woe betide you if we don't have a good honey season! If all is well I shall remember what you said, but I have an idea myself that we shall have a good season. I perfectly well remember 1861 as being an exceedingly good honey year; 1871 I have forgotten about; but 1881, that was grand! I think that beat all I ever had, especially for quality.—JOHN WALTON.

Notices to Correspondents and Inquirers.

Letters or queries asking for addresses of manufacturers or correspondents, or where appliances can be purchased, or replies giving such information, can only be inserted as advertisements. The space devoted to letters, queries, and replies, is meant for the general good of bee-keepers, and not for advertisements. We wish our Correspondents to bear in mind that, as it is necessary for us to go to press in advance of the date of issue, queries cannot always be replied to in the issue immediately following the receipt of their communication.

All queries forwarded will be attended to, and those only of personal interest will be answered in this column.

DR. TINKER'S BOOK ON 'BEE-KEEPING FOR PROFIT.'—Several applications having reached us for this book, we are procuring some copies of the work, and will report when received. The book costs in America 25 cents, to which will have to be added cost of carriage and duty. Price will be fixed when these details are to hand.

J. G. KIRSTEN (Tunbridge Wells).—We thank you for translation of the article 'Bad

Luck' from the *Bienenzeitung*. It is very humorous and quite harmless, but it scarcely harmonises with British notions of propriety, and is therefore unsuited to our columns.

G. F.—*Stocks formed from driven Bees perishing in Winter.*—Having started bee-keeping so lately as June last, you were too inexperienced to attempt establishing stocks from driven lots of bees in autumn. Why you have failed is not easy to say without knowing all about what you did and how it was done. However, six lots of bees in experienced hands should have made two good stocks by joining three in each and treating them properly; but if, as we suspect, the operation was deferred till late in autumn; no ready-built combs given the bees to winter on; no time for them to seal them over; and maybe insufficient warm wrappings allowed, the disaster is easily accounted for. There is no reason to suspect foul brood. Either of the hives you name are good ones; as to their being 'the best,' that is, of course, a matter of opinion.

WM. GREENER.—*Mouldy Combs and Moth Larvæ in Hives.*—We should judge that the syrup injudiciously left on all winter has leaked from the feeder, as it will do, and running down among the combs has caused the mouldiness—or a damp, cold hive, through faulty top-packing, will result in mouldy combs. The larvæ in the *debris* sent is that of a small wax-moth which, through want of strength in the colony, has been allowed to effect a lodgment between the hive and floor-board. All this should have been cleared away in the autumn. It would appear as if the skep was the warmer domicile in your case, hence its freedom from mouldiness. As the colonies increase in population the bees will clean up the mouldy combs, if not too far gone.

A. WELLBRIDGE (Parracombe).—We shall be glad to have your 'experience' when convenient.

W. F. T. (Morchard Bishop).—Members of Associations affiliated with the B.B.K.A. can obtain the use of a set of lantern slides at a nominal cost on application to the Secretary, Mr. J. Huckle, Kings Langley, Herts, and paying carriage.

ERRATUM.—In our last number, p. 42, fourth line from bottom of second column, for ten—read two.

* * Several letters, &c., are unavoidably held over till next week.

NOTICE.—We request our correspondents in future to address all communications relating to the literary department, &c., to 'The Editors of the "BRITISH BEE JOURNAL," 17 King William Street, Strand, London, W.C.'

THE
British Bee Journal,
BEE-KEEPERS' RECORD AND ADVISER.

No. 450. Vol. XIX. N. S. 58.]

FEBRUARY 5, 1891.

[Published Weekly.]

Editorial, Notices, &c.

OUR PROMINENT BEE-KEEPERS.

No. 31.—PASTOR PAUL SCHÖNFELD.

Certainly amongst the most prominent bee-keepers in Germany we find the name of Paul Schönfeld, who has not only contributed much towards practical bee-keeping, but has done great service to the science by working out and explaining many mysteries connected with the anatomy and physiology of the bee. To him, also, bee-keepers are indebted for a knowledge of the nature of foul brood, and to its being caused by 'bacteria.' That brood food was produced in the chyle stomach of the bee has also been clearly demonstrated by him, and most interesting are his articles in the German papers about his experiments on this subject.

Paul Schönfeld was born in Sulau, a small town of Lower Silesia, on the 30th of November, 1821. From 1840 to 1843 he went to college at Breslau, where he studied theology with the object of entering the ministry of the German Protestant Church. In 1847 he was appointed to the living of Teutschel, near Liegnitz, where he has resided and continued his pastoral duties until quite recently. He was much loved

and highly honoured by all his parishioners, and also by all who have had the privilege of knowing him. Outside his ministerial duties, Schönfeld devoted all his spare time to the study of bees, not only in practical bee-keeping, but also in microscopical work.

It was quite by chance that Schönfeld became a bee-keeper, and it happened by his taking over from his predecessor in office a colony

of bees in an enormous log hive, which had been mismanaged, and had not even given off a swarm. The next year, in Schönfeld's possession, it gave off three swarms, but these died of starvation the following winter. This determined Schönfeld to look after the bees himself, and he at once read up what literature he could find on the subject, and made himself thoroughly acquainted with both the theory and practice of bee-keeping. With persevering study he soon became master of the subject, and as a result his apiary flourished. As his colonies increased, so also



PAUL SCHÖNFELD.

his devotion to the bees increased. After working at the anatomy and physiology of the bee for five years, he communicated the results of his observations to the *Bienenzeitung*, and had been a regular contributor to its columns for upwards of thirty years when, owing to some disagreement, he transferred his articles to the *Illustrierte Bienenzeitung*, edited by Cravenhorst. One of

his most important works was in connexion with his researches on the five senses of bees, which made a considerable stir at the time. Baron von Berlepsch, seeing their value, induced Schönfeld



Fig. 1.

Fig. 2.

to write article 105 of his celebrated book. Berlepsch always considered this contribution as a most valuable addition to his book. Through the instrumentality of Schönfeld, Dr. Wolff searched for and discovered the organ of smell of the bee, which resulted in his writing his now classical work on the subject.

Many investigations were made on the temperature which bees require for their well-being, and many articles were written on this subject which have led to a proper understanding of the theory of wintering.

One of the most important subjects with which Schönfeld's name is connected is that

of foul brood. With regard to his studies on this subject he had to fight hard battles against Fischer and Von Molitor-Mühlfeld, which ended in Schönfeld's favour, and it is to him that we owe our present knowledge of the real cause of this most terrible disease of bees. As Schönfeld's experiments have been so misrepresented, and statements have been attributed to him that he never made, we make no apology for giving an extract from the *Bienenzeitung* for 1874. Following the investigation of Dr. Preuss, who discovered minute bodies of an oval shape in foul-brood matter, which he termed 'micrococci,' and which he considered to be the cause of foul brood, Schönfeld proved these supposed micrococci (Fig. 1) to be neither more nor less than the spores of a 'bacillus' (Fig. 2), and he maintained that it was these bacilli, and not micrococci, that were the cause of the disease. On page 201 of the *Bienenzeitung* for 1874 Pastor Schönfeld, giving a de-

scription of his observation on foul brood, says:—

'On the 24th of July, the smell from an examination of the hives showed that foul brood was raging in all three of them. I therefore took out one comb from each, and drove to Breslau, where they were most carefully examined in the Physiological Institution by Dr. Cohn and Dr. Eidam. This examination showed that in every dead larva, and in each foul-broody cell, whether the contents were yet white and fluid, or brown, tenacious, and ropy, there were to be found long, oval bodies, which Dr. Preuss called 'micrococci.' Close to and amongst, them Dr. Cohn was the first to find, with the most powerful of the five microscopes which were used, a countless number of slender, pale rods, joined together, and which he at once identified as bacteria of the genus 'bacillus.'

The length of a single rod was about six micrometres, but many of them were two and three jointed, so that these foul-brood bacteria, as I will call them, microscopically resemble the anthrax bacteria, which produce the dreaded splenic fever in cattle, and also those which produce *pustula maligna* in man, though, of course, both these are different, physiologically and in the manner in which they act as ferments.'

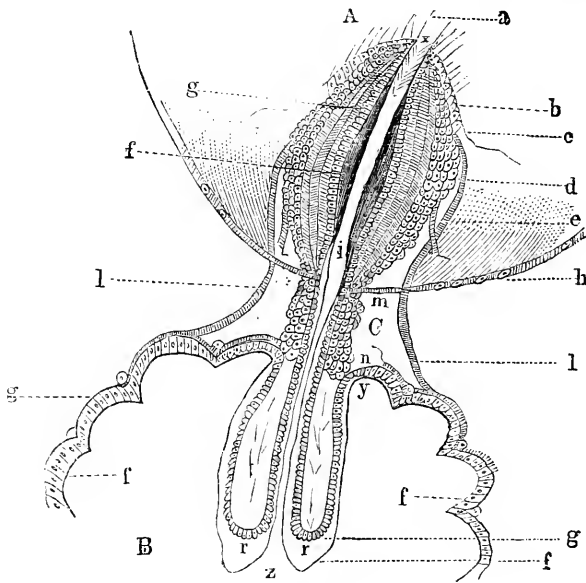

Fig. 3.—Stomach-mouth.

Schönfeld had many opponents, and ten years later, viz., in 1884, Mr. Cheshire accused Schönfeld of stating that 'micrococci' were the cause of the disease, and claimed to have discovered that it was really due to a 'bacillus' which the Germans called 'alveolaris,' and Cheshire named 'alvei,' without any regard to the fact that this 'bacillus' had been discovered ten years previously, and had been described in *Bienenzeitung* in 1874. The knowledge of the cause of foul brood led to the suggestion of remedies, such as phenol by Boutleroff, and salicylic acid by Hilbert.

Schönfeld then turned his attention to the food of larvæ, and the study of the stomach-mouth of the bee; and he was able to demonstrate that chyle food was not a product of the glands, but of the real stomach of the bee; and Dr. de Planta's later chemical researches have shown him to be correct in his statement. The anatomical researches of Schönfeld respecting the mouth of the stomach of the bee, the true character of which he was the first

to discover, have solved the hitherto unexplained problem as to how bees take food, and how it is possible for them, as members of a swarm, from the honey taken with them on leaving the parent hive, either to construct cells very rapidly when the weather is favourable, or to exist for days without other visible supply of food when the weather is the reverse of favourable. Our illustration (Fig. 3) shows a section of this stomach-mouth. Schönfeld has also taken up the question of drone food, and has shown that they are also dependent on chyle food, and that if it is withheld they die, after three days, in the presence of abundance of honey.

Pastor Schönfeld has now retired to Liegnitz, where he is devoting all his time to scientific investigation and microscopic work in connexion with bees; and we hope he may long live to continue his researches, and give them to the world in the free, generous manner he has hitherto done.

USEFUL HINTS.

WEATHER.—At length we have something fresh to say on this interesting topic, interesting in a tenfold degree to the bee-keeper, of all men, at this time, because of the change it has wrought on the face of the earth, and the consequent release it has given to the little prisoners so long frost-bound. Yes, bees have at last had a flight. Alas! that to so many thousands it should have been a flight out of existence! So long a period of continuous confinement very rarely occurs in this Kingdom, and the heavy death rate among the stocks of some bee-keepers is very excusably causing considerable alarm. We may, however, just give the comforting assurance that it frequently happens that stocks which suffer, through such causes as are not the actual effect of weakness or of disease, pull up marvellously when once breeding is started.

Although a few reports received are gloomy enough, it seems quite plain from the details given that bad food has been the main cause of disaster, *not* the severe cold. And this fact places the mischief so clearly among results which are avoidable or preventable that sufferers among bee-men may take heart of grace, and resolve to do better next time. We say this quite seriously, because when it is seen that experienced bee-keepers can keep their bees alive—and none will dispute this fact after the small percentage of loss in such apiaries as are managed by men of this class—it only needs this same experience to ensure like results all round.

There is one thing, however, against

which it is necessary to guard readers, and that is the necessity for being careful in drawing conclusions based on a single experiment or a solitary experience. For instance, a bee-keeper finds his bees dead between the combs with no food in reach; for the first time he has omitted to cut winter passages, and, of course, 'through that omission he has lost his bees.' But what about the other correspondent, who finds his bees dead with plenty of food in the outside combs, and with full winter passages cut in the orthodox fashion? In both cases it would have been safer to attribute death to the excessive and long-continued frost having overcome stocks with population too sparse to resist its effects. Too few reports have as yet been received to form an accurate notion of how the bulk of stocks have borne the strain of long confinement.

DOUBLE *v.* SINGLE-WALLED HIVES.—We have on another page referred to the fact of our own hives and bees being, through circumstances beyond our control, left to take their chance of wintering safely, without being in any way specially prepared for it. They were thus left until the 31st of January, when an opportunity offered for paying them a visit. Having reduced our apiary to ten stocks on coming south, it was not a big job, but the examination resulted very satisfactorily in every way. First let us say that one colony was dead! This is a rather paradoxical method of arriving at satisfactory results, and yet it is none the less true, for had the same occurred to any one else we would—in effect if not in words—have said, 'Served you right.' The colony in question was a fairly good one when last we saw it, in September, '90; but in the coming darkness and haste to catch our train it was inadvertently left without slides to the outer case—*i.e.*, with an entrance about sixteen inches wide; and as it faced nearly east, some idea of what the bees had to stand may be imagined. In consequence, they perished, with plenty of stores about them, from the piercing cold. The other nine colonies are all in good health, and in one hive young bees were seen. Now, when it is considered that these nine stocks are in thin single-walled hives, with equally thin outer cases, and with no packing between hive and case, we shall conclude that for winter protection nothing more is required.

(*Remainder of 'Hints' will appear next week.*)

Correspondence.

The Editors do not hold themselves responsible for the opinions expressed by correspondents. No notice will be taken of anonymous communications, and correspondents are requested to write on one side of the paper only, and give their real names and addresses, not necessarily for publication, but as a guarantee of good faith. Illustrations should be drawn on separate pieces of paper.

Communications relating to the literary department, reports of Associations, Shows, Meetings, Echoes, Queries, Books for Review, &c., must be addressed only to 'The Editors of the "British Bee Journal," 17 King William Street, Strand, London, W.C.' All business communications relating to Advertisements, &c., must be addressed to Mr. J. HUCKLE, Kings Langley, Herts (see 1st page of Advertisements).

* * * In order to facilitate reference, Correspondents, when speaking of any letter or query previously inserted, will oblige by mentioning the number of the letter, as well as the page on which it appears.

ENGLISH BEES *VERSUS* HYBRIDS.

[531.] Mr. E. E. Davies's letter (525, p. 56), on the above is very good, but I would like to ask him in a friendly way if the results he gives in favour of the hybrids are the best and most conclusive he has to offer, as I certainly fail to gather from what he says any decided superiority belonging to the hybrid bees. Cyprian bees I have had nothing to do with, but have had some experience with Ligurians and Carniolans, and their crosses; not very extended, perhaps, with the latter, but sufficiently so to enable me to judge of their three qualities Mr. D. names, viz., honey-gathering, prolificness, and wintering; and *right here* I would ask, Is not a poor honey season a good one to test the honey-gathering qualities of bees by? In a good season almost any kind of bees will breed sufficiently, and gather sufficient honey if it is to be found within their beat, and have we not had abundant proofs of the excellent qualities of our native bee in storing honey in good seasons? But in the case of a short 'come off,' either with the one or the other, they will in a good season be pretty well sure to get enough to winter on anyway without feeding, and then it is not so much minded or noticed. But to take a season like the last, we actually *feel* their different qualities in that respect. The question then is, will they get enough for their own use, or will we have to pay away our money to feed them? The latter is a point I *feel* most uncomfortably. This last season I had about an equal number each of Ligurians, Carniolans, and their crosses, and the natives, all located in the same apiary under precisely the same conditions, and the honey-storing results read like this, in the autumn: Foreigners and their crosses, entirely destitute to a hive; natives almost all amply provided for winter, and some given a small surplus. I am well aware of the *cause* of this very marked difference in results, and I readily admit that the foreigners are quite as industrious, or, perhaps, more so than the others, and possibly gather more honey than the natives; but the mischief is here—they are such breeders that their large populations consume all they gather. Management at fault! Well, I am not quite a novice, but I confess I cannot manage these bees

to advantage. If you attempt to limit the brood nest, swarming is intolerable, while with an unlimited brood nest you have nothing but an entire hiveful of brood and bees, and even then excessive swarming. There is no mistake about their being the ones for *bee-sellers*; but I would say, *bee-buyers*, beware! I refer chiefly to Carniolans and their amiable crosses.

And next as to their wintering qualities. I must say I find them good winterers (although I have one lot of Carniolans I fear gone dysenteric at the present time), but have never found them better in that respect than the natives. I do not, as a rule have any trouble in that way, except through carelessness.

And then, as to their 'stingitiveness.' I think the Cyprian and Syrian have pretty well got their verdict in that line, while the Carniolans are generally supposed to be fairly amiable, likewise the Ligurians; but the difficulty—nay—the utter impossibility—is to keep them pure in this country. Then, what about their crosses? Does not pretty well every one who has had to do with them credit them with a superabundance of the *registry* business? and perhaps that would not so much matter if I don't mind a few stings. But how about my neighbour's bees? He may not be quite so much in favour of foreign strains of bees nor of stings as I, but his bees will as surely get crossed as mine. I had a proof of this last autumn, in driving some skeps for a neighbour a mile away from my bees, and mine are the nearest foreigners to his, I know; there were many grey and yellow-banded, and pretty much sting-banded ones, too, as I found to my cost.

This very marked feature in the so-called hybrid is, I believe, a very great barrier in inducing the cottager to take up bee-keeping. The chief drawback with them is, they are afraid of the stings attendant upon the pursuit; and it will soon be difficult to find the pure, quiet, native bee in this country. My foreigners and hybrids have all notice to quit—some are gone. As to deterioration from in-and-in breeding, can that possibly occur when our drones fly three or four miles from their hives?

In conclusion I would ask, How do you *know* that you are not introducing foul brood into your apiary with an imported queen? There is at least a risk, of no small importance, either. Heartily wishing friend E. E. D. and all bee-keepers a good year,—HENRY NEVE, Warbleton, Sussex, January 30th, 1891.

VIRGIN QUEENS.

[532.] Some time ago 'A Hallamshire Bee-keeper' sent out a number of virgin queens, if I am correct, to establish as a fact that they could all be safely introduced, and that colonies in which they were would winter well. If you think it would be of sufficient general interest, would you kindly review the matter, and tell us if it was entirely successful, and, if so, what was the plan of raising such queens, and the plan of introducing?

Weather is a queer thing, isn't it? While you are talking about very severe winter weather, we are having, in northern Illinois, as we had last winter, a remarkably mild season. The coldest we have had this winter was 3° below zero. Perhaps you don't think that very torrid. Well, we are accustomed to have it play around zero and below it for days together, sometimes going 35° or more below; and this winter the thermometer has not, I think, been below zero but the one time. Most of its time it has spent among the twenties, ranging from 15° to 40°. I don't mind cold so much, but I envy you your English climate for roses.

I thought you were going to let Mr. Cowan make us another visit before this. I have never ceased to regret that I didn't meet him when he was here before. If you will let him come into the western wilds as far as Marengo, I'll promise not to scalp him. Kindest wishes.—C. C. MILLER, *Marengo, Ill.*

[We are forwarding by first mail a copy of the *Record* for August, '89, in which is reported 'A H. B. K.'s' own account of introducing virgin queens, and also a copy of *Record* for June, '90, in which appears a report on these queens. These will give an opportunity of judging of the success of the plan from the originator's own standpoint. If our good friend, Dr. Miller, will just think of what is involved in a journey to America, and visiting the bee-keepers there, by imagining that he was going to leave his 'western wilds,' and visit this country on the same errand, he will understand why we cannot regard the undertaking as lightly as he does in kindly expressing his intention of subduing his scalping instincts in our case. We may say, however, that if our Co-Ed. does visit America again he will not pass by Marengo, or fail to make a call at the worthy Doctor's home.—EDS.]

NOTES BY THE WAY.

[533.] The weather during the past week has been all that bee-keepers can desire at this early period of the year, the sun shining bright and warm, and the bees disporting in its warmth on several occasions. Some stocks have been hard at work clearing out the *débris* from hives, while many bees have been busy around the drinking-troughs, possibly more for water to reduce the candy and crystallised honey to an edible consistency than as an indication of breeding, though in strong colonies the small patch of a few cells of brood will now begin to grow in size, and we shall get a veritable spreading of the brood nest. Any stocks that are likely to run short of food for the next few weeks should have a supply given while the weather continues mild and open.

Leaky roofs *must* be attended to; it is an imperative duty the bee-keeper owes to his bees to see that their domicile is dry. Damp wraps, cushions, &c., should be removed and dry ones put in their place. Dryness is a *sine quâ non* to the well-being of the colony. Read carefully what our Editor says in last week's *Journal* on spring management.

Mead-brewing.—I was surprised to see that mead-making is considered by some to be illegal. If our exciseman is going to charge—and for illegal brewing surcharge—bee-keepers for mead-brewing, what of the multifarious other decoctions brewed by cottagers from mangolds, carrots, parsnips, gooseberries, currants, and elderberries, not forgetting the home-made wines of a superior quality brewed by thousands of careful farmers' wives?—if, as I say, the exciseman is going to prosecute in all cases of 'brews' for home use, of even intoxicating liquors, he or they will have a busy time of it, and I opine will raise such a nest of bees about their ears as will give a shake to any government that ordered such prosecutions.

I am glad to see that the B. B. K. A. intend holding a honey show in connexion with the Dairy Farmers' Association's next show, and I trust the Dairy Farmers' Association will come out handsomely with special prizes and plenty of space; also that we may have a good honey season, and be able to prove to them that in the interval since we last held a show in connexion with their Association (I think in '81 or '82) our industry has grown and is still making progress. This metropolitan gathering of bee-keepers would be a good opportunity for holding that 'Grand National Honey Competition,' to decide the championship, which our Scotch brethren, with just a wee bit o' clannish pride, have located for the present in the person of Mr. Rae, of Dalbeattie. No doubt the representative of the clan McNally, at present located in the Emerald Isle, will scent the battle from afar, and be ready when the time arrives to enter the lists again with redoubled ardour. This national class could easily be made a source of income to the 'British,' as the small quantity sent from each exhibitor would not, except in the winning exhibits, be worth the carriage and trouble of the return journey; therefore all ordinary exhibits could be sold and the proceeds handed to the Association; and also a small entry of, say, 1s. each would, if it was taken up with spirit, augment the resources of the show account considerably. Here, too, at a great metropolitan show, we should have representative bee-men from all parts of the kingdom, who could act as judges; thus we could have an English, a Scotch, and an Irish judge, one from each part of the kingdom, and also a Welsh, so that all interests would be represented. Now, bee-keepers, what do you say to the idea?

Mr. Read (520), *re* British and Irish Honey Company, is in much the same plight as others who are so unfortunate as to be creditors of the concern. I know a bee-keeper who took action in the county court, with the result that he is the loser of the court fees. The Company treats the matter with contempt, and does not even put in an appearance, and in this case it was an example of 'throwing good money after bad.' The bee-keeper who has honey for sale in the future will only have himself to blame if he parts with his honey without the cash. The

'deposit system' inaugurated recently by the management of the *Bee Journal* places the nefarious dealer in an awkward position if the seller insists on dealing as Mr. Read says he is determined to for the future—'cash or deposit.' Mr. Read wonders if any honey the British and Irish Honey Company bought was ever paid for? Yes, sir; I sold them a parcel at Windsor at the Show in 1889, which was promptly settled for, and that stroke of business, coupled with what I was told they were doing in the trade, induced me to send two large consignments afterwards, for which a cheque was promised in a few days after delivery. After repeated applications I obtained a cheque for 77. odd some months afterwards, and the promise of another cheque for the last and largest consignment in a few days. That cheque has never come to hand, and I fear never will. But bee-keepers have even a crumb of comfort in this failure to meet engagements, for had it not been for the ventilation of the several delinquencies reported, we should have had no 'deposit system' started.

English Bees versus *Hybrids*.—Mr. Davies (525, p. 56) does not tell us the reason why his two stocks of pure natives should be dead, while the rest of his stocks, composed chiefly of hybrids, are alive. I expect there is some cause for the disaster other than difference in the race. In- and-in breeding is only a scientific 'bogie,' as applied to bees kept by cottagers in the past. If it is so difficult to keep any particular race of bees pure—unless isolated on all sides by a long distance—where does 'in-and-in breeding' apply to the English bees as formerly kept by cottagers and farmers in every village, hamlet, and farm? Why, there was not even a remote chance of anything of the kind; the bees of one village or hamlet fraternised and mated with the bees in the next or adjoining village, and so on all sides. Mr. Davies says 'No one can fail to notice the deterioration of the English bees through in-and-in breeding.' My dear sir, it is the *system* of the cottager that is at fault, not the cottager's bees; and if Mr. Davies likes to put my assertion to the test in the coming season (good or bad), let him procure a four-pound swarm of these cottagers' deteriorated bees and place them on the same treatment as a four-pound swarm of his improved hybrids. If he will do this I have no fear that, when he tots up results at the end of the season, the balance will be on the side of the English swarm, supposing, of course, they start equal. I have sent swarms of these despised natives to all parts of the kingdom, and have yet to hear of a complaint of their working qualities, though numerous testimonials have proclaimed their honey-gathering qualities. In conclusion, may I ask how many centuries would be required for a race of bees to deteriorate by so-called in-and-in breeding? We know that bees would pass through, say, thirty generations per century. I am referring to the mother-bees, not the ordinary worker-bees.—W. WOODLEY, *World's End, Newbury.*

FOUL BROOD IN CANADA.

[534.] The letter of Mr. Allen Pringle (512, p. 42) claiming credit to Mr. McEvoy and Canada for the discovery of the 'purgatorial' means of curing foul brood 'is indeed rich,' to say nothing about his assertion that 'practically the honey is the only medium of communication of the germs.'

The plan adopted and recommended by Mr. McEvoy, and now put forward by Mr. Pringle, is practically, if not exactly, the one I published in the *Record* in 1887, with one important omission, viz., the thorough disinfection of the old hive, and without which the disease *invariably* breaks out again. If Mr. McEvoy can make a permanent cure of the disease on the lines he has laid down, he can do more than I ever could; and I think I have cured as many cases of foul brood and experimented as much as most men. I consider that honey is a means of infection, no matter what any one may say to the contrary; and I have an opinion that it is so simply because of its *sticky* nature, which allows spores of the disease to adhere to its surface, to be licked off by the bees. But to say it is 'practically the *only* medium,' is what no one, with any experience of it, would maintain for a moment.

You say regarding the Canadian method, 'They are where we were ten or fifteen years ago.' Have they got even as far as that? Thirty years ago we cured foul brood by the starving or purgatorial process, but we never omitted scalding or baking the hive and all belonging to it, to kill the spores.

There is one more matter touched on by Mr. Pringle, viz., he credits Mr. McEvoy with curing foul brood of fifteen years ago, and bases his claim on a *private* letter written in November, 1890. Now, according to well-known journalistic etiquette, no one is entitled to set up 'priority' claims that cannot be supported by unquestionable evidence, such as something published in a book or journal. If Mr. Pringle or Mr. McEvoy cannot do this, then they must admit that they either have or *could have* got the information from published British works. The only part that is 'new' is purging the bees, and yet giving them their liberty, and this part is claimed as the discovery of the undersigned, and will be so until *prior publication* is shown.—A HALLAMSHIRE BEE-KEEPER.

[The 'plan' mentioned by our correspondent as having been published in the *Record* four years ago referred to what he then called 'Odourless foul brood,' probably some less malignant form of the disease than *Bacillus alvei*. What we maintain is that foul brood proper, as we find it affect bees in the United Kingdom, cannot be cured by the 'starvation' method. Beyond this, we say that for Mr. McEvoy or any one else to claim 'priority' in introducing this latter method, in the face of what we have shown was printed and published over a hundred years ago, and even after what appeared in our own pages eighteen years since, is simply absurd.—EDS.]

IS MEAD-MAKING ILLEGAL?

[535.] If Mr. Hehner is correct in 513, page 43 of the *B.B.J.*, I am afraid there has been a great leakage of revenue for the last thirty years or more. Upon reference to the Act of 1880 mentioned by him, I find it has no reference to mead-making at all, but to 'sweets' (under which category mead and metheglin come).

Retailing.—Seeing that mead is particularly mentioned as sweets, I do not see how the Beer Act can affect the matter in question, as it cannot be called beer or a beer substitute.

As in my previous letter, I am still of opinion that there is no law affecting the manufacture of sweets, mead, or metheglin, or imposing any duty upon such industry. The law only steps in when sale of the same commences, and imposes licences of 5*l.* 5*s.* upon persons selling in quantities of two gallons and upwards (such person not being a wine dealer), and 1*l.* 5*s.* upon persons selling in any smaller quantity (such person not being a wine retailer).

The alcoholic percentages mentioned by Mr. Hehner have reference only to the maximum amount of spirit allowed to be present and sold free of licence duty.

I still think that you will not be mulcted in any very heavy penalty over your *rash* promise made to H. Langdon. I will be much obliged to any reader of the *B.B.J.*, or indeed any other person, who will point out to me the Act of Parliament imposing any excise duty upon the manufacture of sweets, or made wines (mead or metheglin), and as I do not think such an Act exists, I must conclude that mead-making is legal, and may be indulged in to any limit the bees will permit by honey gathered, and that there is no fear at present of any law being able to touch the maker.—A
BEE-FEVERISH EXCISE OFFICER.

A CURIOUS EXPERIENCE IN
'QUEENING.'

[536.] I have had an experience with one of my hives which to me is interesting, and may be interesting to some of your readers. When my hives returned from the heather, I found one—a bar-frame—queenless. I left them as they were till near the end of November, when I saw an advertisement in the *Journal* from a Sussex bee-keeper offering Carniolan queens at four shillings each. I thought I would have four shillingsworth, and sent a postcard for one. The advertiser very kindly sent one by return post, advising how to introduce her. This was, I believe, on the 26th of November, by which time very few bees remained in the hive, and of the number a good few were drones. I caged her for twenty-four hours, and then liberated her. The following day they commenced killing the drones. On the 2nd of December I saw some bees carrying pollen, the latest date I ever remember to have seen such a thing. On New Year's Day—a most beautiful spring-like day

here—numbers of young bees (workers) were flying, and have been many times since. Yesterday (the 27th) I found the queen at the mouth of the hive, *dead*. To-day I got another surprise. I found some young drones thrown out. Now, I would ask, is it not a little remarkable she should have started breeding in a hive so weak in bees at such a late date? and is it not still *more* remarkable she should breed drones?

I enclose the queen and three young drones. I should be glad if you could find out the cause of her death.—R. T., *Midlothian*.

[The dead queen sent is doubtless the Carniolan introduced last autumn, for a *post-mortem* proves her to be fertile and laying. The question therefore arises, Whence the young drones? Are you sure there was not a queen reared late last year, and that, being unfertilised, she is not the drone-layer? Should this hypothesis be correct, the probability is that the two queens have been kept apart in the hive all winter, and now, having met, one has been killed; unfortunately the fertile one.—Eds.]

NAPHTHALISED BEE-CANDY.

[537.] I noticed in the *B.J.* of January 8th (p. 16) an article on 'The Foul-brood Bacteria,' which interested me much. Taking for granted that the chemical, naphthol β , can be consumed by the bees, by means of 'soft candy' as well as syrup, would it not be well for some of our well-known appliance dealers to make some naphthalised candy, and offer it for sale, at a slight advance upon their present prices, so that it may be thoroughly tested? Many amateurs, like myself, have neither the time nor the appliances for such candy-making. The English proportions I take to be: 5½ grains of naphthol β dissolved in 1 quart of water, with 19 grains of alcohol added; or perhaps 5 grains of naphthol in 1¼ pints of water, with 15½ grains of alcohol, would be more correctly the same as the French quantities given. I am glad to say my bees have survived the winter so far, in spite of one hive leaking, which I have just found out and corrected. The bees were flying on the 26th and 27th, clearing out their dead most busily.—W. H. HUGHES,
Llanbedr Rectory, Ruthin.

[We trust that some of our manufacturers of bee-candy will adopt the above suggestion.—Eds.]

INCOMPLETED SECTIONS.

[538.] The question is often raised, what is the best thing to do with them? Most bee-keepers who work for section honey will admit (even in a well-managed apiary, and especially through a bad season) that a number of such sections often come to hand. But for section honey to command a remunerative price, the combs must be evenly built out, well sealed, and of a good colour, and produced in its purest and most cleanly form. Unsealed sections, if allowed to stand long, are objectionable, as the honey often becomes watery and deteriorates in quality, rendering it almost unfit for use, and a poor

price only can be obtained for sections with combs partly and unevenly built out.

Two remedies are generally adopted—the feeding process (or giving back natural stores at the end of the season, in order that the bees may complete such sections,) or the extractor remedy. Speaking individually, I have tried the feeding method on several occasions, both with unsealed combs and extracted honey, by reducing the number of section crates and re-arranging those sections nearest completion: but the results have not been very encouraging. The plan I now adopt during the honey season is to extract all sections not likely to be evenly built out and completed so as to class with the marketable bulk, and at once return the empty combs to hive for bees to refill, and all sections not completed and sealed at the end of season I extract, and carefully store away the empty combs for use in the early spring, which to my mind is an inducement for bees to commence with the sections, and a means of securing the early crop. One thing I find very desirable in the plan is that the best average samples, both section and extracted, are secured in labable form, for which the best market price can be obtained, and involve very little trouble or disappointment to the bee-keeper.—AMATEUR.

BEES PERISHING ON SNOW.

[539.] Although the snow is gone it is not too late to have a recurrence of the same kind of weather; perhaps therefore you may think the following of some use. On the first sunny day during the late snow I lost a considerable quantity of bees, as they alighted on the snow and were unable to rise again. On their next flight, at the suggestion of a neighbour (Mr. Moseley), I spread some straw in front of the hives, and I think I lost scarcely a single bee afterwards. I would have written last week, but waited to see if any one else had tried the same thing.—J. T. AMBROSE, *Bishampton, Per-shore, Worcester.*

APPLIANCE DEALERS.

[540.] With all due respect to your footnote to your correspondent 'W. B.'s' last letter (518, page 45), I am constrained to ask the favour of this once only replying through the medium of the *B. B. J.* to 'W. B.' re what I must characterise as his unreasonable comment on my letter (471, page 582). Your correspondent asks in his last letter (518, page 45), 'Has Mr. "G. J." not the value of his money?' I answer most emphatically, 'No!' According to his (the dealer's) advertised price list in the *B. B. J.* of the very week in which the transaction took place, I should have had five shillings worth more sections, besides 1s. 6d. off in the pound. Defaulting appliance dealers must feel not a little indebted to Mr. 'W. B.' for although his attempt at making them out pure and spotless is a sorry one, yet, no doubt, were his talent for logic and

his sense of prudence equal to his intention, he would at least be deserving of the appellation, 'A friend in court of the defaulting appliance dealers!'

As 'W. B.' has carefully secured himself from blame for any discrepancies in his last under cover of an absent journal, I will say no more, only desire him to read my first letter again when he gets his *Journal* back from his friend, if it would not take too much time in thus doing what *common courtesy* to me seems to require.—G. J., *Ashfield Lodge, Cootehill, Ireland, January 27th, 1891.*

WINTERING REPORT.

[541.] Answering your inquiry re bees passing through the late severe weather, I have had a look among the bee-keepers in this neighbourhood, and find, as a rule, they are experiencing little loss of colonies, although the death rate has been large. I think many are startled at the way hives and the general surroundings have been decorated with the effects of a 'first flight.' Those wintered on natural supplies seem to have stood it best. Procrastination seems very rife amongst bee-keepers, and time is not given for sealing before cold weather comes. I advised many who have tiering hives to take surplus boxes off early, so as to give an opportunity of storing in Standard brood-body, and where this was done early enough it has amply repaid. Feeding must now be resorted to, or a serious loss will occur.—W. P. MEADOWS, *Syston, near Leicester, January 31st, 1891.*

NAPHTHOL FOR FOUL BROOD.

[542.] In my letter of January 24th (No. 522, p. 54) I ought to have said that the bottle of water and spirit containing the naphthol β must be shaken before adding to the syrup. The crystal is insoluble in cold water, but is soluble in alcohol, ether, and slightly in hot water. The addition of the spirit is to render it more perfectly soluble in the hot syrup. If undiluted spirit be poured into the naphthol it causes perfect solution, but the addition of cold water will cause re-precipitation.—W. J. S., *Mortmoley, near Sheffield.*

AN EARLY QUEEN-WASP.

[543.] I enclose a pill-box with a 'Peculiar Bee' I found amongst one of my stocks when examining them to-day. I guess this is the first of its species you have seen this year. I am afraid it will be dead before it gets to you, as I hurt it in getting it out of the hive. The beggar was so lively I had hard work to catch it.—T. E., *Kilcarbery, Enniscorthy.*

[The queen-wasp was quite lively when received, and must have had warm quarters to stand so severe a winter and be moving so early.—Eds.]

SUDDEN DEATH OF AN IRISH BEE-KEEPER

[544.] The death of the Rev. John M'Neece, rector of Tullylish, occurred with extreme suddenness this morning. It appears the deceased gentleman, before coming to breakfast, requested a glass of hot water, as he fancied himself suffering from indigestion. The water was supplied, and in a short time afterwards the breakfast bell rang for his presence. There was no response to the alarm, and Mrs. M'Neece went to his bedroom, when, much to her horror, she found her husband lying lifeless on the floor. Immediately Dr. Swan, of Gilford, and Dr. Robert B. McClelland, J.P., Banbridge, were sent for, and on their arrival pronounced life to be extinct.

I send you the above cutting from our local paper, which explains itself. It will be remembered by many readers of the *B. B. J.* the prominent part Mr. M'Neece took in advocating the merits of the self-hiver last season. He was most enthusiastic with whatever he took in hand, and had a great love for bees. His loss is keenly felt in Laurencetown and district by a large circle of friends.—JOHN D. McNALLY, *Laurencetown, Co. Down, January 26th.*

DEATH OF A SCOTCH BEE-KEEPER.

Twelve months ago the death of a well-known Scotch bee-keeper, Mr. John McDowall, Lochans, Stranraer, was intimated in the columns of the *B. B. J.* Since then his apiary has been under the care of his nephew, John McDowall McConnell, who seemed to have inherited from his late uncle the same high qualities that that gentleman possessed of becoming a successful bee-keeper. It is now our painful duty to record the death of the above-named gentleman, who died recently at Lochans. He had been for some time in failing health. No doubt had he been spared, he would have been a shining light amongst the young and rising generation of Scotch apiarians.

WEATHER REPORT.

BUCKNALL, LINCOLN. BM. 25.

	Week ending			
	Dec. 21st.	Dec. 24th.	Jan. 4th.	Jan. 11th.
Maximum	36°	34°	39°	34°
Minimum	2°	12°	18°	6°
Mean max.	31°	28°	34°	31°
" min.	16°	21°	23°	15°
" temp.	24°	25°	29°	23°
" of 5 years (32°)	(32°)	(32°)	(30°)	(33°)
Wind	NE	N	N	S
Rain (inches) . . .	0.20	0.45	0.10	0.13
Rainy days	1	1	2	3
Remarks	{ frost, snow.	frost, snow.	frost, snow.	frost, snow.

J. BINT.

Queries and Replies.

[304.] *Specific Gravity and Melting Point of Beeswax.*—What specific gravity or what melting point of wax is safe for introduction into brood chamber or supers? (I have an amount of wax.) Can anything be added to raise the melting point? I ask for the information for my own private use only.—W. J. S.

REPLY.—The specific gravity of beeswax varies from 0.965 to 0.972, and the melting point 143°00' to 147°20' Fahr. The following vegetable and other waxes have a higher melting point:—Chinese insect wax, 177°80' to 179°60' Fahr.; Carnuba wax, 181° to 206°60' Fahr.; Palm-wax, 161°60' Fahr.; Mineral wax, 136°40' to 212° Fahr. They are, however, none of them suitable for mixing with beeswax, and can only be treated as adulterants.

[305.] *Wax Extracting.*—Will you kindly tell me what is the matter with the enclosed wax? At first the comb was soaked, then put in a muslin bag and boiled in five gallons of water. As the wax came to the surface it was skimmed off and put in cold water, and in order to clear it this process was repeated. The water was then drained from it. The wax was then melted in a small saucepan, about two pounds at a time, and poured out into basins. There was nine pounds. This is my first attempt.—F. R. HOLMES, *Whitstable, Kent.*

REPLY.—From the appearance of the wax sent it would seem as if the frothy scum formed on the surface of the boiling wax had been skimmed off as it rose to the top, and in consequence only about half an inch of clear wax lies on the surface, while the remaining two or more inches of the cake is a frothy admixture of wax and pollen. There is a large amount of pollen in it, and from the smell it must have been mouldy before melting. Boil the whole in clean water and let it cool gradually. When cold the wax may be lifted off, and the *débris* gathered on the under side removed with a knife.

[306.] *Honey Granulating.*—Some of my honey has granulated, and some is still quite liquid. Will you please tell me why this is?—F. R. HOLMES, *Whitstable, Kent.*

REPLY.—Perhaps the following remarks on the granulation of honey, written by Mr. Grimshaw, and reprinted from page 214 of *Record* for October, 1889, will serve the purpose of reply as well as anything we could say:—'We must first think of nectar being simply a solution of cane sugar in water, the amount of sugar and chemical peculiarities varying, of course, with the kind of plant, with the wetness of the season, and also with the humidity of the air at the time of the nectar-flow (electrical influence is, for the moment, beside the question). The business of the bee is to gather the nectar, remove some of the water by the help of its own system, and by the help of a salivary ferment convert the cane into grape sugar; by

adding formic acid to the honey regurgitated into the cell its further fermentation is arrested, and its keeping quality well assured after still more surplus water is allowed to evaporate before the bee seals it up in the cell.

'The honey is still one-fifth of it water; two-fifths of the rest is dextrose, or crystallisable sugar; with two-fifths levulose, or non-crystallisable. Extracting honey before it is all ripe will, we know, throw out some bearing an undue proportion of water in it, this having a tendency to retard the candying, but we shall throw out nearly all the dextrose, which increases this tendency. If, however, one waits till all is sealed, good ripe stuff, when it is extracted a certain portion of the crystalline sugar remains in the cell, and thus give out a greater share of levulose (non-crystallisable) sugar. Such honey naturally holds out longer in a clear, fluid state. If I had to decide between A and B in the same district, A having readily-candying honey, whilst B's remained fluid, I should say B extracted from nothing but sealed comb, whilst his neighbour was not so particular. If this was not the case, my alternative would be that the bees of A had easier access to water, thus allowing the crystalline sugar to be readier slung out of the cells. I am presuming that A keeps his honey in as warm a place as B; if not, there is really no question at issue.'

[307.] *Buying Bees.*—I beg to thank you for your reply to my query (No. 303). The mischief is even worse than I suspected, for five out of my seven hives (four driven lots and one very strong Carniolan lot) are dead, and the other two badly diseased. The first I noticed was the Carniolans, but I did not dare open the hive during the intense cold. I know they must have been too strong to allow of robbing, yet the cappings were only recently torn, as the honey had not begun to drip from the combs, as it has done since. 1. I have been told by a man who has kept bees for sixty-three years come next swarming-time, and whose father kept bees before him, that the reason my driven lots did not thrive is because I did not feed them. I ought to have shot and partly plucked a sparrow or two, and hung over the feed-hole, so that the bees could get good meat, and become strong enough to live till honey-time. 2. As I shall want to buy some bees for the good summer promised by 'X-Tractor,' and can get some cheap now, how can I best judge of their fitness? I suppose I could not look for the queen this side of April; so what points should be noticed besides strength in numbers and amount of stores?—W. F. T., *Morchard Bishop.*

REPLY.—1. This same 'sparrow' superstition was alluded to last month by a correspondent in the *Record*, with the difference that the bees in that case were treated to roast 'fowl,' instead of having the bird raw and 'partly plucked.' We pay no attention to these 'old tales' about bees. 2. The 'fitness' of a stock can best be judged by an examination to ascertain the amount of brood hatching: at the same time, if

the bees are seen to be numerous and working vigorously, carrying in pollen, &c., it may be safely assumed that all is in good order within.

[308.] *Excessive Death Rate.*—I shall be glad if you can say what has been the cause of six stocks of my bees dying. Saturday was the very first opportunity that I could look through my fourteen stocks, when I found six of them dead, and a tremendous lot of dead bees in three of the others! In nearly all instances the dead bees were in a heap in the centre of the hive just under where the cluster should have been; in some of the frames in several of the hives also the bees were quite in a saturated condition. 2. In other cases the bees were filled with a dark brown fluid. None of the bees in any one instance had gone beyond the three centre frames, although there were passages for them and plenty of honey. Some of the combs were very mouldy, and the pollen gone quite bad. My hives are double-walled, and well packed on every side. The only conclusion I can come to is that through the intense cold the bees were compelled to throw off an excess of moisture, which has caused the mischief. Two stocks in exactly the same sort of hives are as strong and clean as possible. 3. Are the frames filled with comb (and honey part the way down) any good to use again? 4. If so, how can the dead bees and pollen be got out of the cells? I have kept bees now for ten years, but never saw such a sight as now. I shall be glad of any information you can give me (as a constant reader of the *B.B.J.*) concerning the other stocks, of which I have cleared all dead bees and taken all frames out which were in quite a bad state. The top coverings were damp, but no rain could possibly enter, as the roofs of all my hives are in good condition.—H. C. SCLATER, *The Court, Littlehampton, February 2nd.*

REPLY.—1. You give no particulars as to top coverings used, and without an opportunity of actual examination we can only imagine that in some way either the food or the 'packing' is at fault, combined, of course, with the terribly severe winter. In this connexion you might refer to 'Useful Hints' on another page. Had you not cut winter passages most persons would at once have laid the fault on want of these, and it shows how careful we must be in jumping to conclusions. The stocks which have survived will no doubt be all right if food is seen to. 2. This appearance denotes bowel-distention, and is caused through bad food and inability to leave the hive for the purpose of voiding the fæces. 3. The cleanest and best of the combs may be used again. 4. It causes the bees a lot of labour and trouble to remove dead bees and pollen from combs, so where they are very foul we should burn the combs. The honey will do for future use, as there is no disease indicated.

[309.] *Painting Insides of Hives.*—Is there any disadvantage in painting the inside of body-boxes and floor-boards? I have always found it practically impossible to get them perfectly

clean by washing and scrubbing, and I think of trying painting in addition.—H. LIVERMORE.

REPLY.—Excepting where it is desired to disinfect hives after being occupied by foul-broody bees, we should scarcely advise painting the insides. At the same time, we always recommend two good coats of paint *inside and out* when disinfecting hives, and we followed that plan many years ago—when curing foul brood—without experiencing any ill effects from the paint.

Echoes from the Hives.

Bideford, January 25th.—Bees flying to-day, and some of them going in and coming out of one hive in particular with a business-like air, that meant work of some sort going on. I thought they might be carrying water, and afterwards, passing by the pond, in which for many weeks past the goldfish have appeared 'framed and glazed' below a coating of ice, I saw to my regret seven apparently drowned bees floating on the surface. I collected their bodies, took them indoors, put them on a plate, and covered them with a little heap of table salt, inverting a tumbler over them, and set them in the fender in front of the fire, and in a few minutes one bee began to move a leg—ultimately the whole seven 'came to life.' I allowed them to remain enjoying the warmth for a few minutes, and then, still keeping the glass over them, took them to the hives. When the glass was removed I had the satisfaction of seeing them fly, and after a gyration or two select the hive I had noticed, and expected they belonged to, and enter it. We have had no snow—perhaps half an inch on one or two occasions—in this happy region, although the thermometer at night has once or twice registered as low as 17° Fahr. Stormy wind and rain characterised last week, with thermometer at 47° about.—C. T.

Later.—January 27th.—Passing the front of my house this morning I was arrested by the sound of bees at work, and saw them thick upon the blossoms of the yellow jessamine! Neither crocuses nor snowdrops are out yet, and the abnormal activity of these bees is perhaps due to their having undergone a long railway journey during the frost.—C. T.

Warbleton, Sussex, January 26th, 1891.—Yesterday and to-day the bees have been favoured with a partial flight, but not sufficient for a good cleansing. The greater part of them have been confined to their hives for nine weeks, and none have had a thorough flight during that period. Never in my bee-memory have we had such a trying time of it for the pets. Mine were all packed up well, with an abundance of good sealed stores, in good health and strength, but notwithstanding I fear some have fallen a prey to dysentery. In previous winters I have

used a substitute for the 'Hill's device'—a couple of sticks across the frames—considering it an advantage, but decided to try it without any passage-ways at all this winter; but upon slight examination I found several hives with whole seams of bees dead, apparently from being unable to move on to fresh feeding-ground during the late severe weather. The mortality is great in almost all hives, but curiously enough in the thinnest, apparently coldest, single wall I have, with a wide-open entrance facing north-east and always in the shade, there was the smallest amount of dead of the whole lot—not twenty bees. The present seems a very opportune time to again ventilate the subject of *Single versus Double-walled Hives*. After this very trying time the frost seems to be well broken up now. Let us hope for a week or two of open weather now.—HY. NEVE.

The Apiary, Higher Bebington, January 25th.—Grand cleansing flight. Every hive has had a turn-out. Find that two out of thirteen have ceased to exist; one in consequence of two mice having got in and made a nest. They (the mice) paid the penalty for such an act. The other, a weak lot, that did not take the food well last fall, and of which I had great fears.—H. H. LINDON.

Castlecroft, near Wolverhampton, January 27th.—On Sunday, the 25th, bees were flying from all my five hives. I seized the opportunity to give a cake of candy to one hive which I was very anxious about; it was very late in the autumn when I made it up of two weak stocks, and I couldn't get them to take syrup. I was agreeably surprised to find them looking very well. Another hive seems weak, but they lost a lot of bees through flying one morning during snow when the sun was out very bright. Sunday was the first day here that bees could fly since middle of November. The frost has been terribly severe, and I hardly expected the bees would come through so well. With best wishes for a happy and prosperous New Year to you and your delightful *Journal*,—HAROLD E. TWENTYMAN.

Oakfield, Enfield, February 1st.—I have just been looking over my stocks (five), giving additional candy where necessary, and find all have apparently passed through the winter in first-rate condition. The bees were flying in great numbers this afternoon—a most beautiful one. I take this opportunity of saying how greatly I appreciate the *Journal*, which I eagerly look for every Friday, and I am greatly indebted to it for what little I know of the fascinating bee.—HERBERT LIVERMORE.

Uttoveter, January 31st.—*Effects of the Winter on Bees.*—As soon as the severe weather was over I examined the entrances of each of my six hives, and one or two others belonging to friends, and, by means of a bent wire, cleared out an immense quantity of dead bees; and, being rather alarmed at the unusual number of dead bees in one of my hives (a single-walled one made of inch stuff—the only

single-walled one I have), I opened it, and found all were dead, having eaten all the food in the front frames, where the bees had clustered, although there was plenty at the back. The other hives have lost large numbers, but still are in a hopeful condition, and a good cake of candy was necessary for one of them, this being the first time I ever fed with candy, which goes to show me that more food than usual has been consumed this winter. I have partially examined several hives, and in one or two instances found a seam of dead bees between outer combs, where no winter passage had been made, which will teach me in future always to make provision for bees getting easily from one part of the hive to another—a thing I had done regularly for many years until last year, and I appear to have suffered for it the first time I failed to do so.—**UTTOXETER.**

Notices to Correspondents and Inquirers.

COMB-HONEY (Kent).—*Sections in Hanging Frames, &c.*—1. Instead of making a double-walled body-box with frames to hold six one-pound sections in each, you would be far more likely to succeed with a super built on the lines of 'Lee's section case' sold by Neighbour & Sons. This carries out your notion of having the sections in hanging frames, and by purchasing one as a pattern you will have all the measurements, &c., correct. 2. When using full sheets of foundation in grooved sections no space is allowed at bottom for stretching. 3. The one-pound is the best size, but it is a moot point between two and four bee-ways. 4. With strong stocks and good management moths are never troublesome. 5. Bees were in a 'mashed' condition when received and quite unrecognisable. 6. It is possible to clear 'an average of thirty shillings per hive in one year,' but as to the probability of your doing it we have strong doubts.

HENRY SMITH (Winchester).—Sugar sent is genuine Porto Rico.

HONEY-BEE.—The comb sent is foul-broody. Burn all combs and honey and frames, and disinfect the hive well before using again.

BOSTON STUMP will find full details for candy-making on page 51 of last week's issue.

BOTTLE-BREAKER.—You have overlooked the fact that the admission of air from the bottom of a feeder (which when reversed becomes the top) will cause the syrup to run through. This is the difficulty which renders it next to impossible to make a feeder capable of being refilled without removal from the hive. Make a trial of the bottles you have succeeded in boring, and report results.

G. KILBY (Westfield, Hereford).—There is no cause for alarm in what you have observed, unless the 'markings' on the flight-boards are excessive. So long as the bees appear vigorous and fly strongly, all will be well after a few warm days.

BEE-CLIPPINGS.

BEE-KEEPING FOR FARMERS.

At one of our large shows the other day I was told by an exhibitor in the honey department that the supply of honey was not equal to the demand, and, upon my asking whether the short supply might not be attributed to the wet weather experienced during the last honey-gathering season, she said that she was not referring particularly to this season, but that honey always is a scarce article, and one for which a good price is willingly paid. This immediately suggested to me the question, 'Why in this country is bee-keeping so neglected by farmers?' It is not so in America. Almost every farmer in that country keeps at least a few hives: and last year it was estimated that the honey product of the United States and Canada was worth no less than 3,000,000. Bee-keeping is, properly speaking, a branch of agriculture, and the place for the apiary is on the farm. The native haunt of bees is in the field, and not in the town garden. Garden flowers yield but little honey, many none at all, but, on the farm, clover and buckwheat furnish the bees with large quantities of honey. Again, there is no more convenient place than the farm for keeping bees: near large centres of population they are apt to become a nuisance, especially at swarming-time in early summer, and in autumn when honey is scarce. In America, bee-keeping forms the exclusive business of many people; but the majority of bee-keepers have comparatively small apiaries, and make a fair livelihood by keeping from 100 to 200 hives. Every farm should have on it at least a few colonies: they can be kept without adding seriously to the cares of the farmer, while the profits will make a respectable addition to the owner's income. Ten hives, well managed, may be counted on bring in 15*l.* to 20*l.* a-year.—*Farm and Home.*

ANOTHER 'TALL' ONE.

A successful boring for honey has been made in North Tennessee. For many years swarms of bees have been noticed by boatmen on Fox Bluff, on the Cumberland River, near Franklin, Kentucky. The bluff is 170 ft. high, and the river's channel runs directly under it. The bees have been observed about a big fissure near the centre of the bluff, and the opening could not be reached from above or below without great danger of being stung to death. As the bees had never been robbed, it was believed a large amount of honey was stored in the cliff. Recently a well-borer visited the bluff, and was at once impressed with the idea that he could reach the wonderful honey storehouses with his drill. After some coaxing he persuaded a number of farmers to undertake the expense, and a three-inch hole was bored from the top of the bluff. At a depth of eighty-five feet the drill struck the honey. Barrels and tubs by the score were filled and carried off to neighbouring farms, and the syndicate has sent to Louisville for more receptacles.—*Boston Transcript.*

THE
British Bee Journal,
BEE-KEEPERS' RECORD AND ADVISER.

No. 451. Vol. XIX. N. S. 59.]

FEBRUARY 12, 1891.

[Published Weekly

Editorial, Notices, &c.

BEE-PAPERS FOR WINTER READING.

No. 4.—PACKING HONEY.

SENDING HONEY IN BULK BY RAIL.—No one with any experience of handling honey after it has undergone a journey by rail will read the above heading without an instinctive smile or a frown—as the results happen to affect him—at the recollection of the many and various ‘smashes’ revealed on the opening of packages received from inexperienced packers. And if this is so at the present day, when the general adoption of the one-pound section as a receptacle for honey in the comb ought to have reduced the chances of breakage to a minimum, how much greater were risks incurred a few years ago, when the efforts of bee-keepers were directed to having the combs built with no attachments to the bottom board, or adapter, so that the super could be turned over and shown ‘bottom up,’ with combs sealed and rounded off without a single broken or unsealed cell? Nowadays we make every sort of endeavour, when working sections, to have the comb built and attached to the wood on all sides of the section; this end attained, there ought to be no difficulty whatever in packing sections for transit to any part of the kingdom in perfect safety. Indeed, it is proved beyond doubt that there *is* no difficulty, as buyers who regularly receive parcels of honey from experienced producers can attest.

The question then arises, Why should so many breakages occur? Why is it that comb honey sent by rail, when packed by the inexperienced producer, so frequently reaches its destination with combs broken away from the sections and honey running ‘all over the shop?’ Our endeavour in this paper will be to show how the loss, vexation, and annoyance which such results naturally bring about may be avoided.

In the first place, then, it must be borne in mind how fragile and tender a thing is the comb in which honey is stored. The wonder is how so great a weight of liquid sweets in its delicate waxen encasement can, even with all our care, stand the jolting, and shunting, and rough handling inevitable in a railway journey by goods train, and be delivered perfectly safe at its journey’s end?

To illustrate our meaning, let any one take a

section of honey in which the comb is attached to the top and a little way down the sides only; hold this ten or twelve inches from the ground, and suddenly let it drop. There is nothing to check the suddenness of the shock, and of course the comb attachments break away, and it falls in a bruised mass; but if the comb is built well on to the wood all round, and the section falls on a bed of any soft material, no harm will follow. Surely this is plain enough, yet it is just the extent to which we realise the cause of breakdown, or the reverse, which marks the difference between good and bad packing.

No bee-keeper does himself justice who, well knowing what care is required at all times in handling sections of comb honey, to avoid poking his fingers (accidentally, of course), through the capping, or damaging the beautifully clean surface left by the bees, yet omits the exercise of the same thoughtfulness in packing his honey for transit.

Suppose we have half a gross of one-pound sections of comb honey to prepare for a journey by rail: procure a strong, second-hand packing-case, large enough to hold comfortably twelve separate parcels of six sections in each, with room for two or three inches of hay, or other similar material, above, below, and on all sides. If possible, a box of suitable size should be chosen—say about 28 by 17 by 14 in. deep—for holding the twelve parcels in two layers, six in each. Place six sections side by side—preferably with a square of glass on the outside of the one at each end—wrap in brown paper, and tie together, across the top and round the sides, with strong twine, so firmly and securely as to bear lifting about by the cord without the sections slipping out of place. When the twelve parcels are ready, prepare a level bed of hay, two or three inches thick, on the bottom of the box, and on this set six parcels, with just a little hay between each. The spaces at the sides are then stuffed with hay, pressed sufficiently firm to keep the parcels from moving about, even though the package be turned ‘end up.’ After sprinkling a little loose hay on the top of the first layer, a thin board is laid over all, and on this is set the second six parcels, which are packed on each side as before, the whole being covered with sufficient hay to keep all close down and firm when the lid is nailed on. A stout rope is then tied round the package convenient for railway porters to lift by, and after labelling ‘Honey in comb: this side

up, with care, dispatch by goods train. We have only to add that sections in transit should stand the same side up as when on the hives, so that any odd unsealed cells may not drip and cause the honey to run over the face of the comb. The only exception to this rule is when the comb is not well secured to the bottom of section, in which case it should travel bottom upwards. If the above instructions are faithfully carried out there is little risk of breakage.

Extracted honey is, of course, less liable to damage than comb. With it the chief trouble is to prevent leakage, in order to avoid the messy, untidy appearance, so objectionable to the tradesman on whose counter the honey has to stand. Almost any kind of covering we can name, short of careful capsuling, will leak if honey jars are laid on their sides for a few hours, and this makes it necessary to pay special attention to packing, so that boxes are not liable to be turned over in the rail journey. The best preventive we know of against this trouble is to make the package too heavy for one man to lift so easily as to toss it about. When two pair of hands do the lifting, and a bold label is affixed to the top, worded—'This side up,' sufficient care is generally taken to keep it right. Good screw-cap jars with cork wads are now so much in favour with honey-buyers, and withal are such a saving of labour to the packer, that the parchment covers largely used a few years ago are gradually dropping out of use. In packing jars of honey each one should be wrapped in separate paper, and laid on a layer of hay or soft straw, two or three inches thick, each jar having just as much (or as little) of packing around it as prevents the glass from touching. When the bottom of the box is full, the sides and the spaces between the jars are packed so tight as to keep the latter in an upright position. In preparing for second or third layers of jars a little packing should be sprinkled over the first lot, and a thin board laid over all. On this the second layer may stand on the bare boards with packing between each jar as before.

SINGLE SECTIONS AND JARS BY PARCEL POST.—On this little need be said beyond observing the points specially emphasised in the foregoing remarks. With the sections the comb must be well built to the sides all round. This seen to, a box of quarter-inch wood is made, just large enough, when lined with pieces of corrugated paper cut to size, to hold the section. After 'glassing,' and tying on the squares of glass with string for convenience of lifting, the section is dropped in the box, a piece of corrugated paper laid on to keep it from shaking about when the lid is nailed down, and it will travel safely any distance.

Single glass jars, when they can be safely guarded against leakage—such as dry sample jars, with good corks—may be sent safely by post if a piece of corrugated paper, cut a little deeper than the height of the jar, is folded round it, and the jar protected top and bottom

by a circular piece of the paper tied in before the outside wrapping is put on. Ordinary honey jars, however, are so difficult to make leak-proof that it is best to choose one with a good cork wad and a well-fitting screw cap; pack in a wood box with either bran, hay, or corrugated paper, send it by rail, and endeavour by the directions on label to induce the carrier to bear it 'right side up.'

SENDING HONEY TO SHOWS.—If we can do anything by way of inducing exhibitors at honey shows, who may read these papers, to bestow a little consideration on the unfortunate and usually overworked Hon. Secs., and others who have charge of the 'staging,' we shall be aiding in the removal of a source of frequent trouble and annoyance to these latter gentlemen which is altogether inexcusable; and the worst of it is, it frequently happens that those who take most pains in packing their exhibits for transit to the show, give quite as much trouble as those who take least: for the time and labour involved in unpacking and repacking some exhibits is, as we know from personal experience, 'a caution.' We therefore propose to show how bee-keepers, who aspire to show honours, may send their dozen sections or their dozen jars of extracted honey by rail to the show, and have them unpacked, staged, repacked, and returned safely with the minimum amount of trouble to all concerned, and with no great outlay for appliances.

The cut (Fig. 9) represents a crate for holding

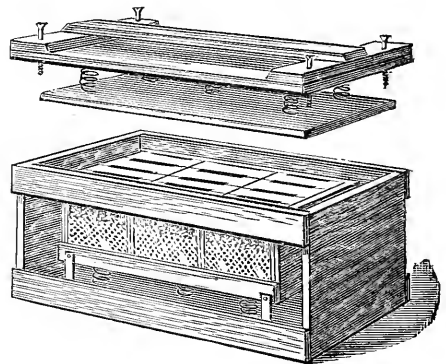

Fig. 9.

a dozen one-pound sections, and as no great amount of skill is involved in its construction, it may be said that any amateur joiner can make it for himself. It is a box within a box, the inner one resting on six spiral springs fastened to the bottom of the outer box, while the inner one is pulled down a little by a strip of leather at each corner, as shown. This form of crate, without the lid, was first introduced by a well-known firm in 1886, and it answers the purpose admirably. The lid we had made for our own use, and its construction will be at once seen in the cut. The lower or inner lid is of thin board cut small enough to fit easily inside, close on to the

tops of sections. The upper one is of the same light wood, with cross-pieces at each end of three-quarters of an inch stuff, and a strip of the same forms a handle to lift by. Five springs are fixed between these two lids and fastened to both, so there is no risk of one being lost. A stout screw driven in at each corner forces this double lid close down on to the sections and keeps them firmly in place. As all sections sent to shows must be glazed, no other glass protection is used. The inner box is made $12\frac{3}{4}$ inches long by $8\frac{1}{2}$ inches wide, so there is room for a small roll or wedge of corrugated paper to be slipped down at the outside of each row, which keeps them firm in place, and when withdrawn allows the section to be lifted out readily. Except to caution the maker not to cut the end-pieces of the crate so that the screws are driven in to the top of the grain, and to have all its parts strongly nailed together, no further instructions are needed for making, save a close inspection of the cut.

For extracted honey in glass jars make a strong box divided into twelve partitioned squares, as shown in cut (Fig. 10). The exact

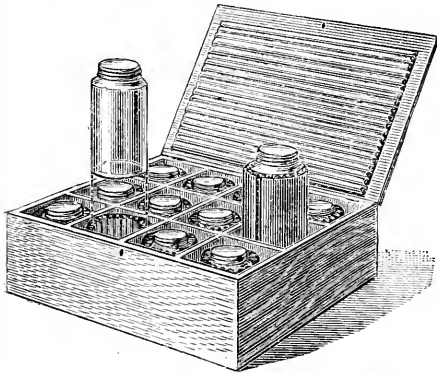

Fig. 10.

size of these squares is determined by the particular make or form of the honey jar used, but they are made sufficiently large to hold the jar comfortably when the latter is encircled by a fold of corrugated paper. The bottom of each portion has also a square of the same paper on which the jar rests. A strong lid hinged, on the inside of which is nailed a square of corrugated paper as shown, completes the box, while the height of the jars is so arranged that the ridged portion of the paper rests close on the screw-caps and keeps all firm. A single screw in centre of lid at the front fastens it down, and when a strong cord or rope, with a nail driven through it at the bottom, to keep it fast to the box and prevent its going astray, is tied round the whole, with a label on the top as before, the package is ready for travelling any distance without breakage.

The saving of trouble and labour to the officials of a show when dealing with honey packed in this form is simply astonishing. The cord is untied, the single screw drawn, and the

jars lifted out without disturbing the packing one bit, or losing any of the parts. There is no littery mess about; the box is put away; when wanted after the show is over it is ready for dropping the jars into, and the honey is safely repacked for the return journey in about five minutes.

Those who have had to do with shows will know what this means, and we therefore venture to express a hope that exhibitors will earn the gratitude of officials, and at the same time conduce to their own satisfaction, by following our advice in the matter of 'packing honey for shows.'

It will be observed that in packing comb honey for travelling to shows, spiral springs are relied on for safeguarding it from damage, and for glass jars corrugated paper is made to act as the 'buffer' against breakage. Both articles are very inexpensive, the springs costing only a few pence at any ironmonger's, while corrugated paper is sold at less than a penny per superficial foot. Unlike a beehive, no great accuracy is required in making, so that amateur joinery is peculiarly suited for making both section crate and box for jars. At the same time any appliance dealer will make them for a very small cost when it is understood that only rough, strong articles are required.

It sometimes happens that persons have to assist in staging and unpacking who are not accustomed to handling honey, and these gentlemen are placed at a double disadvantage when bad packing has to be dealt with. Referring to persons unaccustomed to handling honey, and the many 'slips' they make through inexperience, we may conclude this paper with an illustration from our many experiences. Some fifteen years ago we had as regular customers for honey the establishment in the North known as the headquarters of the Mormon community at the port of embarkation from this country to the Salt Lake. The chief elder or officer in charge was a very nice fellow indeed, highly intelligent, well read, a man of much travel, and, but for his peculiar religion, a gentleman with whom we could have got on very well indeed, especially as he knew something about bees. He was especially fond of good honey, and, moreover, was a first-rate judge of its quality. We took especial pride in supplying him with our best, and he always paid us 1s. 6d. per pound for extracted honey in bulk.

The season in question was a good one, and the honey in Cheshire was extra fine. So our friend sampled out a quarter-hundredweight; it was put into a large stone jar and taken a distance of six or seven miles to his place by a special messenger of our own, who carried it all the way. The honey was, after the long journey, safely handed over to a servant, and by him carried down a dozen stairs, and two minutes after it left his hands our messenger was asked to 'come down and see what could be done, for the servant had dropped the jar!' He went and found the jar broken, the contents all over the kitchen floor, and the culprit a standing lesson in handling honey by an inexperienced carrier!

USEFUL HINTS.

BUILDING UP IN SPRING.—We had under consideration—when our space ran out last week—the effect of a severe winter on stocks of bees in light, single-walled hives, and, seeing that our own colonies—all of them in hives so constructed—have stood the test so well, the question arises how are such hives adapted for building up stocks rapidly in spring? Up to now they have had for top-coverings, first, a sheet of American cloth, with its glazed side next the top-bars; next, a single thickness of grey felt undercarpeting; on this the top-board (a covering of half-inch board in three pieces); and over all the ordinary summer quilts, consisting of several thicknesses of felt, &c. It has been our custom hitherto to do no more at the hives in early spring than take away space from below combs and add a little to top coverings; but we had no particular object in forcing on the bees very early in the year, as the honey only began to turn in in quantity about mid-June. Now, however, we are in a new district, and must prepare for a new ‘gathering-time,’ so the majority of the hives will be well packed all round with some warm material, to raise the internal heat as much as possible. At the same time, by way of experiment, a few hives will be left just as before, and we hope by this course of procedure to do something towards solving the problem of the relative efficiency or the reverse of thin hives as against double-walled ones.

The weather has become so warm and sunny during the last few days that everyone so disposed has had full opportunity for ascertaining how the bees have fared. Some appear to have come through wonderfully well; and others, with apparently no very great difference of treatment so far as can be gathered from the details given, have fared badly; but the general mortality has not been at all high when the extreme winter is taken into account, and if no further disasters occur, through starvation or other preventable causes, the all-round result may be set down as a very satisfactory one.

All stocks should be raised from floor-boards the first chance which occurs, and the dead bees and rubbish cleared away. Water may also be given, either by spent tea-leaves kept moist or by troughs on which the bees may alight and take the water without getting into it.

BEE RAMBLES IN SAVOY.

The winter of 1889 will be remembered as one of the most trying, not only in England, but all over the world, owing to an epidemic of influenza which spread far and wide, laying low the strongest and carrying off those who were not strong enough to battle with the disease. All classes, poor and rich, were smitten alike, and among one's friends there was hardly a family where at least one of the members had not been a victim. Fortunate are those who escaped, for the disease left every one weak, and it was a long time, frequently months, before the patients were themselves again. Unfortunately we were amongst those attacked, and although we partially recovered, we were not able to get rid of the complaint entirely, and thoroughly broken down in health we left England to try and regain strength in our favourite country, Switzerland. Here we arrived in May, and while breathing in fresh mountain air and new life a letter was received from our friend, M. Ed. Bertrand, proposing that we should accompany him and M. G. de Layens, who was staying at that time with him, on a trip to Savoy. We could hardly realise this as a fact, for we had long wished to visit the bee-keepers in Savoy, and had never been able to do so. We had seen the splendid honey coming from amongst the Savoy mountains, and had heard of their rich crops of esparcette (sainfoin), from which most of their honey is gathered, and had longed to see the pasturage. Here was an opportunity not to be lost, more especially as two such bee-keepers as M. Bertrand and M. G. de Layens were to accompany us. We three had already made a pleasant trip together in 1883, and the remembrance of that trip certainly gave us the prospect of similar enjoyment on this occasion.

The invitation was at once accepted, for there was nothing to hesitate about. We were resting and regaining strength, and could do this with change of scene as well as by staying at home—which was always a temptation to be at some sort of work, which was strictly prohibited. Just about this time the weather was very bad, and it was decided to start as soon as there was a promise of settled weather, our object being to see the bees at work during the graphs of the flowers. When this work is to be height of the honey-flow. M. de Layens was also resting from his labours, a rest richly deserved, for he was engaged upon a voluminous work on botany in connexion with M. Gaston Bonnier. It is on the flora of France, and is to contain something like 3000 to 4000 illustrations which M. de Layens is preparing from photo-finished it is difficult to say, but that it will be a valuable addition to the literature on the subject there can be no doubt, after his previous productions in this branch of science. Most of our readers know both M. Bertrand and M. de Layens by repute; but if there is one who does not we would just introduce them by saying M.

Bertrand is certainly one of the leading and most indefatigable bee-keepers in Switzerland. He is the editor of the *Revue Internationale*, without exception the best bee journal in the French language, and has written *Conduite du Rucher*, a thoroughly practical work, which has reached the sixth edition, besides many pamphlets. He is the life and soul of the Société Romande d'Apiculture, and to him is mainly due the advance made in bee-keeping in the French-speaking cantons of Switzerland and the adjacent departments of France. A partisan of large hives, he has demonstrated that it is only by the use of such that a large harvest is possible. M. de Layens, besides being a botanist of mark, is without question the foremost bee-keeper in France belonging to the modern school. His object has always been to popularise bee-keeping, and to enable the working classes to obtain a good return with the minimum of labour. His methods are simple in the extreme, but his hives are enormous—too large, many of our old-school bee-keepers would say, but sometimes really too small, as we have ourselves seen. What will our bee-keepers say to a hive with twenty frames double the size of our standard?—yet we have not only seen these filled, but also some with twenty-six frames, and even then supers had to be added to give more room. M. de Layens has also written *Eleveage des Abeilles*, a practical book with especial reference to management of bees in these hives. He has also been a regular contributor to the *Revue Internationale*, and we have frequently translated his excellent articles for the benefit of our readers. Such are the two men with whom we were about to make a bee-trip to Savoy.

The weather having at last become fine, and the barometer rising steadily, on the 30th of May we left Lausanne for Nyon, where the night was spent at the residence of M. Bertrand. The evening was passed in making arrangements for the journey: our pleasure being greatly increased by the promise of Madame Bertrand to accompany us, at any rate during part of the excursion. The barometer was right, for on the next morning the sun rose in a clear sky, and there was but a slight ripple on the beautiful blue Lake of Geneva. On the opposite side Mont Blanc stood out in all its grandeur, and there was every indication that we would be favoured by the weather. At ten o'clock our party left Nyon by steamer for Nernier, on the Savoy side of the lake, and here we were met at the pier by M. Genoud, of Messerie, a village about two miles from Nernier. A *char* was in readiness to take our bags, while we walked and admired the vast expanse of lake on our right, and in all directions fields of esparcette in full bloom. Nyon was prettily situated on the opposite side of the lake, but not nearly so favoured as regards pasturage as the plains on this side.

Arriving at Messerie, after a few minutes' rest we were invited by Madame Genoud to lunch, and here we had our first experience of what the famed Savoy hospitality was. Much

was the astonishment of our host when we declined wine, and it was with difficulty that our friends explained that we never took any, but preferred water instead. Of course, the talk was of bees, and we tasted a specimen of honey, which was delicious. We then went to the apiary at the back of the house. M. Genoud has about sixty hives, but he had, unfortunately, made a mistake in starting with the wrong hive. Some one, when he was a novice, had recommended him to start with German hives of the Berlepsch pattern, and he had a number of these made, but found out his mistake when he began to read the *Revue* and talk to progressive bee-keepers. He was, however, doing his best to remedy the mistake by transferring the bees to larger hives. All the hives are under cover, and amongst them he has several Layens, Dadant, and Cowan hives. He also showed us some Cowan hives he was making for an exhibition in the autumn. He told us his winter losses in the Berlepsch hives were fifteen per cent., whereas the other hives have wintered well.

M. de Layens persuaded us to bring a photographic apparatus with us, to take views of apiaries, which would at some future time be a pleasant reminiscence of this trip. This we consented to do, and the first view was taken of M. Genoud's apiary; but owing to the limited space we could not get back far enough to take any more than a small part of the apiary.

Another look at the bees, which were very strong and hard at work, and then we went to pay a visit to the Rev. M. Magnin, the curé of the place, whom we found in his cassock amongst the bees. This gentleman has sixteen hives with the Burki frame. Carniolan and common bees were principally kept. M. Magnin was an enthusiast, still quite young and very full of energy. He made his own hives, and took us to his workshop, which was fitted up with a bench and all the necessary carpenters' tools. Here he showed us a peculiar feeding appliance of his invention. It was sunk in the floor-board, and supplied by a wine-bottle inverted behind the hive. It was very simple, and we were told it worked well. The bees here were also kept in a bee-house on shelves, of which there were three rows. Rather an awkward arrangement for any one not endowed with the same muscular power as our friend, the curé. Hospitality was again proffered, and coffee was selected, over which there was a pleasant chat. The curé thought bees settled when they heard a noise, and told an amusing anecdote bearing upon this. He said on one occasion he saw, near the parsonage, a swarm of bees that had come from some distant apiary. They were evidently intent on pursuing their course when the thought struck him that he would try what effect music had upon them. He at once sat down to his harmonium, beside the open window, and after playing a little he had the satisfaction of seeing the swarm settle in front of the par-

sonage. He also said many of the country-people attribute bees swarming more frequently on a Sunday to the ringing of the bells. Honey was also tasted here, and after taking leave we started in an open carriage for a drive to Anne-masse, where we wished to call and see Dr. Henon before proceeding further.

(To be continued.)

Correspondence.

The Editors do not hold themselves responsible for the opinions expressed by correspondents. No notice will be taken of anonymous communications, and correspondents are requested to write on one side of the paper only, and give their real names and addresses, not necessarily for publication, but as a guarantee of good faith. Illustrations should be drawn on separate pieces of paper.

Communications relating to the literary department, reports of Associations, Shows, Meetings, Echoes, Queries, Books for Review, &c., must be addressed only to 'The Editors of the "British Bee Journal," 17 King William Street, Strand, London, W.C.' All business communications relating to Advertisements, &c., must be addressed to Mr. J. HUCKLE, Kings Langley, Herts (see 1st page of Advertisements.)

* * * In order to facilitate reference, Correspondents, when speaking of any letter or query previously inserted, will oblige by mentioning the number of the letter, as well as the page on which it appears.

IMPORTING FOREIGN BEES.

[545.] I adopt the above heading with the hope of gathering from readers of the *B.J.* some expression of opinion as to the benefits likely to accrue to British bee-keepers from the importation of foreign bees into this country. We have a native bee most suitable to the peculiar changes of our climate, and withal one of the best of workers under the sun with proper management—a race capable of showing a bold front, and making themselves *felt*, too, if not properly handled.

Of foreign bees we have, first, the Italian—a bee, we are told, possessing every good quality possible, and the one best fitted for crossing with our native strain. Next comes the Carniolan, introduced to us as possessing all the above good qualities, and a few others besides. An attempt has also been made to bring into our midst some of the African races of bees. We hear great things of the good qualities of Italians and Carniolans and other races, and of their various crosses; but what about the attending evils or bad qualities possessed by these bees which have been introduced in our midst, and will in the near future be sown broadcast amongst us?

I would like to ask, Are the bee-keepers of Carniola introducing other races to improve their native bee? No; they try to keep the race as pure as possible. The same with the Italians; while we read that in Australia they are about to introduce a bee best suited to the country, and to keep that race as pure as they can.

Able writers tell us that the honey-bee is a native of some part of Asia, and that by a kind of natural emigration it has spread itself all over Europe, and climate, habit, forage, and other conditions have wrought the various changes

characteristic of the various European bees of to-day. The Carniolan, for instance, sends out swarm after swarm in unlimited numbers, some of which swarms contain about half-a-dozen queens and a handful of bees. These swarms (?) may be good for certain purposes, but not for English apiaries.

We cannot get a fixed strain of hybrids by crossing two different races of bees, for in a few years the special characteristics of the one race will disappear. If we breed for colour or any other quality by crossing and selection, that strain may be fixed only by constant care, and without such it is but labour lost.

Granting that fresh blood among our native bees is a necessity, why develop the tendency for over-swarming still further by adding the swarming propensity of Carniolans? Some authorities tell us that the Italians are very prolific, make few queen-cells, and consequently swarm moderately, are early and late workers, and good honey-gatherers. Then why is it that we hear so little of them now?

Where are the Italian and black hybrids of a few years ago? Do they still retain the quality of the first cross, or has the character of the one race disappeared? And if this is so with Italian hybrids, so it will be with Carniolan hybrids a few years hence. In view of these facts, I hope that British bee-keepers will see the folly of sending their money abroad to buy foreign queens and obtain a cross, which they are not able to keep. The more simple the art of bee-keeping the more popular will it become.

As we have just passed through one of the coldest winters experienced for some time, it will be interesting to know how these foreign or crossed races have passed through the late spell of cold weather, taking into consideration food, hives, their position, and packing. For myself, I believe that the native bee cannot be improved by crossing with any of the foreign races we now have amongst us. Let British bee-keepers endeavour to maintain the good quality of the native bee by purchasing queens from good black stocks, and by buying virgin queens to be mated with our own drones. By doing this I believe the race may be improved, foul brood stamped out, and our efforts rewarded with good returns at honey harvest. At all events this will be my system for the future. My stocks will be of the best old English race, and all queens sent out or bought by me shall be of the same strain. I hope to give you an account of our district in a future issue.—G. W. EDLINGTON, *Brigg, Lines.*

NOTES BY THE WAY.

[546.] The weather has continued very mild during the week, bees on the wing every day, busy at the watering-places. Fancy giving bees water the first week in February! Truly this has been a phenomenal winter so far. Candle-mas Day has come and gone, and the sun shone brightly before twelve o'clock; this, according

to the old belief, is a sign that winter is not half over yet. Though we know that the continuance of such mild weather is unseasonable at this early period of the year, yet one hopes that we may not have such another cold spell as we had from November to well into January. The fields have begun to put on a mantle of green; the birds have commenced singing; the partridges are calling to their mates in the gloaming, leading one to suppose that they have paired before the usual time—Valentine's Day. The old couplet says,—

'Of all the monthes in the yeare,
Curse a faire Februear.'

This spell of warm weather has given our bees the chance of clearing out their dead, and in some cases the numbers of dead bees have been very considerable, caused, no doubt, by the long confinement, and in some cases probably the outside seam of bees perished if unable to reach the cluster without going around the ends of the frames. The cappings of comb brought out testify to the fact that the bees have been adjusting their larder, and possibly would come out better in April and May if we could get a month or six weeks' cold, seasonable weather.

Scarcity of Early Bee Flowers.—The severe winter has played sad havoc with our hardy herbaceous plants, and we shall have to depend on the tuberous-rooted plants for early natural pollen, such as crocus, snowdrops, &c. I have not noticed many catkins, but there is a wealth of swelling buds on the palm, or withies, as they are called in some parts. On the other hand, there will be very few wallflowers left to blossom, as the bulk is killed, so that in large apiaries, with a long distance to the woods, the bees will have to depend principally on artificial pollen. Those in the suburbs of towns will, of course, have abundant natural pollen from the number of early spring flowers that will soon be bursting into bloom.

'G. J.' (540) must admit there are two sides to every question. It the appliance dealer advertised an article at a certain price, of which article he has (yes, must have) a limited quantity, and he receives orders for more than he has in stock—*i.e.*, the demand exceeds the supply—what can he do in the matter? Why, it is a case of first come, first served. Even if his orders came by the same post, the letters opened should obtain priority. To the orders opened last he would have to say how sorry he was to disappoint, but all the articles were sold when the order was received, and that it was impossible to replace same at previous rates, but that he had sent the nearest in stock to the goods ordered, though of an enhanced price. This is the only way out of the difficulty, and I see nothing unfair or calling for the epithet 'defaulting.' I am not either a maker or dealer in bee-keeping appliances, neither am I interested in the trade in any way, so that I feel free to speak on the subject.

Queen-wasps are numerous this year I think. I have found and killed several among the winter wraps and cushions in my apiary—those in a state of hibernation have their wings laid down straight, rather below their legs, while in those that are dead the wings are along their backs, as in a state of rest.

The writer in *Farm and Home* should read up the American bee-papers carefully before he ventures into print with the assertion that a fair livelihood can be or is made by keeping 100 to 200 hives in America. No doubt, if every season were good, and a good market could be secured, such a thing would be possible, but during the past three years bee-keeping in the States has been under a cloud on account of the successive poor seasons.

The English Honey Season.—I was talking to an old bee-keeper the other day, an intelligent mechanic, who told me he had kept bees fifty years, and that he did not remember but seven or eight really good honey years in all that time, and he had kept bees in various kinds of hives. 'Of course,' he added, 'there have been some fair honey seasons, but we do not get a really good one only about once in seven years as a rule.'—W. WOODLEY, *World's End, Newbury*.

NATIONAL HONEY COMPETITION.

[547.] Yes, friend Woodley, if a national competition could be arranged—and I see no reason why it should not—on the lines suggested by you (533, p. 65.), if I am in the land of the living most assuredly will I again enter the lists with renewed energy, and with as much enthusiasm as I ever entered any contest, and endeavour to win the lost laurels of the past year. Being accused (and perhaps rightly, too) of issuing a challenge when all the best nectar had passed into oblivion, I will not lay myself open to the same charge for the coming season. I trust this early notice will stimulate the many who intend to compete for champion honours in such a laudable competition, to reserve samples of their very best produce for the occasion; this done, and the judges drawn from the different nationalities as suggested by Mr. Woodley, the contest should be a good one, and the decisions settle once and for ever the claims to championship. As the matter now seems to rest with the Committee of the B.B.K.A., I trust they will soon take action and put the matter into shape. If the classes are made small enough—say one 1-lb. jar of clover or flower honey, one 1-lb. jar of heather or dark honey, one 1-lb. section of comb honey—these could all be sent in by parcel post, and undoubtedly the entries would be large and representative. For my own part, though defeated in the recent contest, I am still willing to submit another sample of Irish nectar alongside either English, or Scotch, or Welsh: all I desire is a fair field and no favour.—JOHN D. McNALLY.

'UNCLEANNESS IS DISEASE.'

[548.] Foul brood is loathsome. Tell me, please, its cause and prevention. I don't want to know what is the *possible* cause and possible means of prevention, but the *certain*. We have had absolutely no experiences of this disease in our apiary, and should be delighted if all bee-keepers could say the same. Is it a scourge for mismanagement, or did it come in the 'new blood' of foreigners? It is here and there and everywhere. Whence came it? How shall we stem its advance, and stamp it out?

Acres of paper have been covered in the discussion of this foul disease; and yet, I suppose, Messrs. Editors, you are constantly receiving bits of suspected comb, and constantly replying, 'Bad case of foul brood,' 'A case of chilled brood,' and so on; evincing that bee-keepers in general are still in a fog. We have a very strong impression that a large number of cases of foul brood—some directly and some indirectly—are the inevitable consequence of bad management. Just as with mankind cleanliness is half the battle in striving after the security of health, so, in bee-keeping, sanitary hives must ever be the *summum bonum*. I mean by sanitary hives, clean within and without, waterproof, with plenty of paint and putty, warm, clean covering quilts, ventilation, &c. It will not do for the bees and their keeper to be separated by a hundred miles, as in some cases. They must live and move about in the same garden, not now and again, but daily, in spring, summer, and autumn, else much will be left undone that ought to be done; and we all know the advantage of being within hearing distance of the issuing swarm.

I have been horrified at the sight of the internal filthiness of some hives, and have wondered how bees could exist in such 'East End' dens of accumulated rubbish. Can it be wondered at, when hives stand year after year, uncleaned within, paintless without, a stiffened, coarse, dirty old square of carpet, or sacking, as the only quilt, that there is disappointment and disease? Verily, no. I visited an apiary several times last summer, of about forty hives, standing where, under proper management, a good harvest might have been secured—yes, even in such a season as last. But such was by no means the case. They did not average a return of 2s. per hive, all worked for sections. The bee-keeper was a man of the most fatal indifference as to his hives, bees, &c.; and replied to all questions in such a way as to excite no end of laughter. To this gentleman there were no such things as important details in the management of his bees; clumsy, awkward, and careless in manipulation, the workers lost no time in being about his ears, and he, in return, showed no mercy or regard for their lives. He opens a hive without having used a smoker, catches hold of the old quilt and doubles it back, when up come the enraged bees, and down goes the quilt on top of them. Hundreds of worker-bees lay in heaps in all the hives; and what

frames! some close together, others two inches apart, no metal or other ends, some stuck to sides of hives, and as rough on top with propolis as a newly ploughed field.

'You must scrape and adjust these frames,' I said.

'I never bother to scrape the tops of frames I shall leave 'em jest as they are.'

'Are you not afraid of the rain getting through these hive roofs?'

'Oh! that often gets thro'; then the sun comes and dry 'em agin.'

'Are you troubled much with moths?'

'Moths don't bother me so long as I get plenty of honey.'

'What do you mean by plenty?'

'Well, they yielded me 15s. a hive my best year.'

'Do you ever transfer your bees into clean, well-painted hives?'

'No! I never interferes with 'em; I used to ollus keep pullen 'em about, an' I didn't see they were any better for that. Now I let 'em hev a good deal of their own way. I know nobody was ever more careless with their bees than I am.'

Did you ever hear of such a bee-keeper? I found, when next I gave him a call, that one of his stocks had been wholly destroyed by moths. Did he destroy the moths? Oh dear, no! he simply carried combs and sections and dropped them into a large box in the bee-house, wherein he had several stocks. What a sight was there! Moths of unusual size and fatness all over the place, half buried in the wood, and hundreds infesting the combs. I tried to take a few sections, as there were hundreds in the hives, some without crate or dividers, standing on top of frames, others in crates but no quilt on, and bees working up in the roof. One roof had about twelve pounds of nice comb quite in the top. There was not a single perfect section to be found, and simply all caused by the most culpable mismanagement. Some were half-full and capped, others more than full, and a number joined together. It is to be hoped that such bee-keepers are few and far apart. If filth is a disease, surely such apiaries become a nuisance and a danger to neighbours, and it makes one thankful to be at a safe distance from such a spot. Here was a case where, at first, from anxiety, perhaps, there was over-manipulation. Now the hives, bees, and appliances are grossly neglected. Indifference is a poor substitute for enthusiasm, and when the bee-keeper fails to take an absorbing interest in his pursuit confusion sets in, and 'the moth doth corrupt and thieves break through and steal.'

Most of our bees are in Cowan hives, and are transferred each spring into clean brood chambers and freshly-painted outer cases; and floor-boards, and roofs, quilts attended to, and tops of frames scraped. We manage this by having two or three hives ready for a start, and transfer, clean, and paint right through the spring.

Are bees not less liable to foul brood when treated in this way than those which receive no

attention whatever? We did not make a drop of syrup here last autumn, so I feel rather anxious to ascertain the condition of our thirty stocks after the long spell of snow and frost. They all looked well and lively. We now yearn for sunshine and flowers, both for the bees and ourselves.—FREDRICH, *Methwold, Norfolk*.

[It will be a happy day for bee-keepers—and bee-keeping editors of all men—when a reliable reply can be given to the query with which our correspondent prefaces his letter. For the present, however, we can only say that foul brood is caused by the presence of bacterial germs in the body of the larvæ or brood, of the bee, just as small-pox and other kindred diseases result from the presence of similar germs in the human frame; and when the most eminent scientists of the age are engaged in investigating the mysteries of these terrible germ diseases without being able to name a *certain* means of prevention, our correspondent may well pardon us for admitting our entire inability to supply the information asked for. At the same time if he can, by a continuance of the excellent precautions hitherto followed, remain in blissful ignorance of foul brood in his apiary, he may indeed say 'it is folly to be wise,' and he may rest assured that when a certain cure is found the *B. B. J.* will not be long in apprising its readers of the fact.—Eds.]

CURING FOUL BROOD.

[549.] The following brief account of my endeavours to cure foul brood may be of interest to some readers of the *Journal*. The disease showed itself in April last: one weak stock and two strong ones were badly affected; four others slightly.

1.—Weak; burned bees, combs, frames, quilts, and hive.

2.—Strong; used one-third of a pound formic acid (B brand) without producing any *visible* sign of improvement. Burned six combs, two-thirds of each being filled with rotten grubs; killed queen; gave clean hive and combs; left in a couple of shallow combs of brood. Two ripe queen-cells given in succession were destroyed; no eggs were laid for twelve days. Then introduced fertile queen and treated with naphthaline crystals—about a dessert-spoonful every week. Bees did not attempt to remove it from frame-rests, where it was placed. The number of bees seemed to keep up, and some surplus was stored, but the disease did not quite disappear. In August tried a new solution sent me by Mr. Harrison. Sprayed combs, uncapped cells with sunken lids, and poured in solution. Fed with syrup containing the solution. A few weeks later the characteristic smell was absent from the rotten matter, of which not many cells remained. This solution is, at any rate, a deodorant. The stock appeared to be cured before closing down for winter, but further trials are necessary with this solution.

3 and 4.—Used one-third of a pound of formic acid to each without visible improvement. Afterwards used naphthaline.

5, 6 and 7.—Very slight cases—used naphthaline *only*, and less than with the above stocks.

All signs of disease gone in a few weeks. All the stocks yielded surplus, and are *apparently* cured. I do not consider re-queening (though adopted in one case) as actually necessary; but I think that in all but very slight cases of disease the combs and frames should be destroyed, or the chances of cure (if a cure there prove to be) will be small.

Other precautions to prevent the disease being spread were:—

1. Disinfecting the hands with Calvert's medical carbolic soap. 2. Naked arms and hands when manipulating a diseased stock. 3. Separate veils when needed. 4. If smoker used, it was disinfected with the above soap or carbolic acid. 5. If hives were worth preserving they were well scalded, scrubbed with carbolic soap, rinsed with carbolic acid solution, and well painted within and without with two coats, before being used again, and were used only for stocks which had been diseased—not for those which were undoubtedly healthy. All stocks are at present alive, and have plenty of stores. Hoping that foul brood has, like the dirt, made a 'remarkable disappearance' from my apiary, —THOS. BADCOCK, *Southfleet, Kent, February 6th*.

SECURING WELL-FILLED SECTIONS.

[550.] I have seen in great part your varied correspondence relating to filling sections, but yet wish to see a thoroughly practical hint or two relative to filling them as far as possible to corners with comb, for after that it greatly depends on the good or bad season. Would they fill best with section-ends some way apart, or would they be better hung in frames one or two deep? As far as my experience goes, if kept too warm, it is conducive to edge or corner holes. Should you consider it worth while to bring this subject before your readers, it would be in good time to arrange for coming season, be useful to myself, and maybe to my fellow-bee-keepers—at least, in this locality.

My bees are all in prime condition, having passed the winter so far well, with very little loss. They are mostly in double-walled hives with winter passages, and dry.—ANTELL, *near Dorchester*.

[We hope to treat of the above in the series of winter papers now appearing.—Eds.]

QUEEN-REARING.

[551.] I should be glad to know, with a view to the coming season, with how many stocks it is advisable to go in for queen-rearing—honey being the chief object in view, and I myself being a novice. Also, is it ever worth while to make one's own foundation? I, for one, should be glad of a copy of Dr. Tinker's book. May I suggest that in reviews of books the price should always be stated, and if published abroad how it can be obtained?—E. M., *Fressingfield, Harleston*.

WEATHER REPORTS.

BUCKNALL, LINCOLN. BM. 25.

January, 1891.

Maximum 51° on 28th. Minimum -5° on 18th.
 Mean max. 37·8° Rain 1·58 inches.
 „ min. 22·4° In 24 hrs. 0·37 on 31st.
 „ temp. 30·1° Rain on 16 days.
 „ of 5 yrs. .. 34·5° Average, 5 yrs. 1·26 in

Remarks.—The weather has been bright and clear generally, the mean daily range being 15·4°. The rainfall, though above the average of five years, has fallen chiefly in showers and at night, leaving the days bright. The mean minimum is exceptionally low, the ground being covered with snow till the 21st. Ice, ten to fifteen inches in thickness. There have been two very cold periods: from 5th to 11th, minimum being 6° on the 10th; and from 16th to 19th, when a minimum of -5° was touched at 8 a.m. on the 19th. The bees have been flying every day since 25th.—J. BINT, *February 2nd.*

WESTBOURNE, SUSSEX.

January, 1891.

Maximum .. 50° on 31st. Rain:—2·54 in.
 Minimum .. 17° on 18th. Heaviest fall, ·59 in.
 Min. on grass 14° on 18th. on 29th.
 Frosty nights..... 22 Rain on 14 days.
 Average, 5 yrs., 2·66 in.

Sunshine.—117·40 hrs. Brightest day, 5th,
 7 hrs. Sunless days, 8.

Remarks.—A phenomenally bright month. Bees were out first on the 21st, and from the 25th to the end of the month were flying every day.—T. B. BIRKETT.

Queries and Replies.

[310.] *Removing Bees.*—My two hives I find have to be removed at least two and a half miles from where they now are, and so will require a cart. Will you kindly direct me how to manage this? 1. Must the hives be taken off their stands? *If so*, how wrapped up? 2. *If not*, how should they be fastened together? 3. Is the evening the best time to remove them? 4. Are all wraps to be removed when they get to their new quarters *at once*? 5. What quarter would you advise the entrances to face when in their new location?—G. B., *Craven Terrace, W.*

REPLY.—We can reply to your queries *en bloc*. Pray give up the idea of a cart for conveying the hives. A couple of men will carry them both on a handbarrow (or on a couple of poles made to serve as such) for less cost, with less disturbance, and they will travel almost without any special preparation whatever beyond closing the entrances with perforated zinc to keep the bees in. Carefully and quietly done at night, the bees will hardly be aware of the removal; whereas the shaking and jolting of a cart is likely to cause much disturbance. Remove the zinc from entrances as soon as the

hives are fixed up on their new stands. S.E. is the best direction for entrances to face.

[311.] *Syrup from Raw Sugar.*—I fed my bees up last autumn on syrup which was guaranteed to be a pure cane sugar, but I fancy it contained treacle, as all my bees are badly affected with dysentery, and several stocks dead, while others are very weak. I enclose a sample of sugar, and will thank you for your opinion of it. I have taken all combs containing food away from my remaining stocks, and given them three or four clean combs, and poured about half a pound warm thick syrup in one comb, and put a cake of candy on top, and covered up warmly. I would like to know if I can use the food in the combs which I have removed from the living stocks, or shall I have to throw it away? If the fault is in the sugar, I presume it would be best to put it away.—TOM, *Northwich.*

REPLY.—The sample sent is no doubt pure cane, but it is a raw sugar, and such does not make good bee-food. *Granulated* sugar should always be used. The syrup in combs may be used for spring food if boiled again after extracting. In fact, bees in flying weather can take food with impunity which would be ruinous to their health when they cannot get abroad for a flight for weeks together.

[312.] 1. When is the best time to transfer bees from straw skeps to bar-frame hives, now or in autumn? 2. When severe frost gave in a little and weather soft, I opened hive and found a few bees alive, since dead. Frames contain sealed honey, also dark unsealed syrup—I suppose that with which I fed late in autumn. Some cells have a substance which looks like wax; a few are sealed, and, when opened, have fully developed dead bees in. They are slightly mouldy. Do you think this is foul brood? 3. Would it be safe to uncap honey and put frames into other hives for food? 4. Can anything be done to remove mould from comb, or will the bees do this and clean out cells? 5. Bees were fed on *best quality* of saccharine, or inverted cane sugar, such as used by brewers. Is this good feeding? 6. With respect to 'mead-making,' how does it compare with cider-making? Farmers make hundreds of hogsheds of cider for sale, and pay no tax and require no licence; yet in strength cider is equal to beer, and very intoxicating, and cannot be retailed to be drunk on premises, except in licensed houses.—IDLE HOUR.

REPLY.—1. The operation of transferring bees and old combs from skeps to frame hives is fast falling into disuse, and wisely so, for in these days of cheap comb foundation there is no need for utilising old combs in that way. Let the skep swarm, and hive it in the usual way. When the second swarm or cast has come off, return it to the skep, and leave the bees in the latter till the twenty-first day from the issue of the first swarm, when they may be driven and established as a swarm, the old combs in skep being melted down for wax. 2. We cannot venture an opinion as to foul brood with-

out seeing a sample of the comb and brood. 3. If it is honey you wish to uncap, and there is no disease, yes; but taken in connexion with query No. 5, it is very questionable. 4. If not very foul, the bees will clear out the mould. 5. This substance is entirely unfit for bee-food. If bees are to be safely carried through severe winters, nothing but pure cane granulated sugar must be used for syrup-making. 6. The law defines all drinks containing more than a certain percentage of alcohol as chargeable with excise duty, and we see no reason why cider should be exempted if it come within the statute.

[313.] *Dysenteric Bees.*—Kindly tell me what it is best to do with a moderately strong stock rather badly suffering from dysentery at the present time? They have sealed stores at hand, but at present the weather is not warm enough for them to get out. An answer in next issue of *Journal* would be esteemed a favour.—PUNNET STREET.

REPLY.—Take advantage of the first warm day to transfer bees and combs into a warm, dry hive, and let all top coverings be well dried, too, before replacing. Good, warm syrup will also assist in removing the trouble.

[314.] *A Beginner's Queries.*—I have three hives, each containing six frames, and would like to have them made up to ten by the time the honey season commences here—early in June. 1. Should I place the four frames to the side of the other six, or set one or two of them in the centre? 2. Should I commence stimulative feeding in March? Each hive had 20 lbs. of stores last autumn. 3. Suppose a swarm came off, would it be best to return it again or hive in a separate hive, so as to have the best advantage of the honey crop? The heather is very plentiful about a mile distant. 4. Would you recommend me to get Lee's sections? 5. How many crates would be sufficient for each hive? A reply will greatly oblige—A BEGINNER, *Carnforth*.

REPLY.—1. Set the frames to the outside of those already in. Beginners should not attempt 'brood-spreading.' 2. April is soon enough to start stimulating if food is all right. 3. All depends on the date the swarm came off. If at the early part of the honey season locate it on the old stand, and give it the supers from the parent hive to finish a week after hiving. If season is nearly over return it, otherwise neither stock nor swarm will complete the unfinished sections. 4. Yes. 5. It entirely depends on the season.

[315.] *Bees refusing Candy.*—Can you tell me why it is my bees have not taken the candy left on the hives last autumn? Is it because the candy is hard?—FRAMPTON.

REPLY.—Most probably the candy is so hard that the bees can do nothing with it. We have had samples of bee-candy sent here recently which would be about as useful for bee-food as a stone. Only *soft* candy is suitable at this season.

Echoes from the Hives.

Westbourne Rectory, Sussex, February 4th.—My bees passed the winter with entrances full width, porous quilt, no winter passages, but space given over the combs, and with about six thicknesses of carpet or felt, but no chaff or cork cushions, and they are all alive and well.—L. B. BRKETT.

Needlingworth, St. Ives, Hunts, February 5th.—On looking over my twenty-one stocks of bees, I find they are all alive. Sixteen are in single-walled inch-thick hives, and five in skeps. Three of the wood hives have lost a great many bees. Indeed, there has been greater mortality all round in the wood hives than in the skeps, although the former have five or six inches of chaff packing on them. Respecting cheap appliances, I make all my hive frames and section racks. Last year I made ten hives complete, including two coats of paint, for half-a-crown each, not counting labour. Last year was a bad one, but not so bad as 1888. That year it cost me thirty shillings to feed up for the winter. Last year I had honey of that value to sell, so that they kept out of debt. The year 1889 was a good one, so was 1887. I am happy to say we have no foul brood here. I have never seen it, and don't want to. I had only one swarm from twenty stocks last year. Instead of putting a hive on the top of the brood chamber, I put it underneath. They filled it with comb, but no honey.—ST. IVIAN.

Valley Apiary, Hundon, Suffolk, February 7th, 1891.—On Wednesday last, being a nice day and bees on the wing in thousands, I took the opportunity to examine my thirty-four stocks, and am pleased to state I have only lost two, one from mice and one owing to a leaky roof. I find they are breeding profusely, some of them having patches of sealed brood as large as one's hand, so they appear none the worse for their long confinement. I never knew them so long without a flight before. My hives are double-walled, three-quarters of an inch stuff, with no packing between walls, three thicknesses of good porous covering above frames, and a crown board with a couple of bricks above that, and a three-inch entrance. I always winter on seven or eight Standard frames, and when packed in October they average twenty-five to thirty pounds sealed stores. I think a winter like this will test the hives and bees too. Mine are all pure natives, and they are the bees for me! A cunning skeppist told me the other day that he had lost seven out of eight, and I am afraid I shall hear of several more losses, and yet they will not feed.—C. WHITING.

Bridgnorth, Shropshire, February 3rd, 1891.—The exceptionally severe winter has decimated a good many stocks hereabouts; but I was agreeably surprised to-day on examining a colony to find a fine brood nest in three or four of the middle class. The queen—a Carniolan—

was laying freely, and there were goodly patches of sealed brood in a perfectly healthy condition. Is not this very early brood, considering the intensely cold weather of the past few months, with 31° of frost on one occasion? [Yes.—Eds.] I may add that this particular stock was wintered on natural stores, has plenty of pollen, in a hive double-walled and air-space on two sides only, entrance open full width, and a south aspect. Early crocuses and the willow catkin are just coming into bloom, and will furnish the first forage for our favourites in this district.—J. EDMUND RODEN.

Hawkhurst, Kent, February 7th.—I have just taken a peep at my bees, and find all are alive so far. I have five stocks; one a condemned lot in a makeshift hive, and even these appear to be all right. I have not heard yet of any losses about here, but I expect to where the bees are not properly looked after. I trust we shall have a good season. I shall look out and get my bottles set the right end upwards when it comes.—F. R.

Midland County, February 5th.—My eight hives are all in good health and spirits, ready to make use of every hour of sunshine. There has never been a winter passage cut for them, and the hives are one large bar-frame (double walls), one single-wall (thin), one Neighbour's cottage (straw), one flat-topped skep, two boxes without frames, two boxes late but well-fed swarmers of July 13th. Plenty of variety here, and in each case doing well.—MIDLAND COUNTY.

Notices to Correspondents and Inquirers.

Letters or queries asking for addresses of manufacturers or correspondents, or where appliances can be purchased, or replies giving such information, can only be inserted as advertisements. The space devoted to letters, queries, and replies, is meant for the general good of bee-keepers, and not for advertisements. We wish our correspondents to bear in mind that, as it is necessary for us to go to press in advance of the date of issue, queries cannot always be replied to in the issue immediately following the receipt of their communication.

All queries forwarded will be attended to, and those only of personal interest will be answered in this column.

TURLOUGH B. O'BRYEN (Carron, Ennis).—

Quality of Honey.—To keep bees in quantity in a district the honey from which is not saleable by reason of its flavour is certainly not to be recommended; but are you sure the fault is in the locality and not in the season? A good deal of honey-dew was gathered last year in some parts, and it went far to spoil what good honey was already in surplus chambers. Might not this have spoiled yours? At any rate, if the main crop is gathered, as state, in 'late July and early August,' you cannot charge the mischief on the sycamore, for that bloom is over before June is out. When the sample promised comes to hand we will give you our opinion on it. Meantime we should say your best plan would be to work for comb honey in the early season while the quality is good, and the later or inferior crop could be extracted and sold at a cheap rate for manufacturing purposes.

RICHARD DUTTON (Witham).—Any raw sugar will not do as a substitute for Porto Rico. Good Demerara is the next best, but, according to Mr. Simmins, genuine Porto Rico is the only really suitable sugar for dry feeding.

S. GEORGE FIELD.—Of the two samples sent No. 1 is a good make of soft candy. No. 2 is as hard as a stone, and not fit for spring food—indeed, the sugar of which it is made has not even been thoroughly melted. No doubt bees store a portion of the soft candy, as they will any other food they can take down into the hive. If there is no pollen in the comb you may give pea-flour outside as a substitute. Referring to the cutting on 'spreading brood,' it appeared ten years ago, and the writer had no idea of the amount of evil which would result from the practice in the hands of inexperienced bee-keepers. Be guided by what appeared in our article on the subject on p. 51 of *B.J.* for Jan. 29th.

ALPHA.—Comb sent is slightly affected with foul brood—not the malignant type—Candy is all right. We don't know what is meant by 'spring beans.' Bees do work on field beans, or horse beans as they are called.

R. AULD.—We think there is no cause for alarm, it is only a bad case of chilled brood.

R. FRENCH (Leamington).—Your parcel has not reached us.

WAX FURNITURE FINISH.

A wax finish for furniture woods is made by mixing about three ounces of washed tallow and three and a quarter pounds of wax with one pint of turpentine, constantly stirring while boiling and until cold. The paste is rubbed in, the superfluous wax removed with a wooden scraper, and then gone over with soft woollen cloths until it shines. Some workmen prefer to let the wax dissolve in the turpentine cold, as they fancy the heat diminishes the polishing effect. If a coat of French polish is afterwards applied it deepens the gloss.—*English Mechanic.*

WAX POLISH.

An excellent wax polish for wood is made by boiling a quarter of a pound of white wax with an ounce of pearlsh in a quart of water. It should be continually stirred while boiling and until thoroughly cool. It is applied to the surface of the wood with an ordinary paint-brush, and rubbed briskly until dry with a velvet or plush rubber. A very high polish is the result.—*Builder and Woodworker.*

* * Several letters, &c., are unavoidably held over till next week.

NOTICE.—We request our correspondents in future to address all communications relating to the literary department, &c., to 'The Editors of the "BRITISH BEE JOURNAL," 17 King William Street, Strand, London, W.C.'

THE British Bee Journal,

BEE-KEEPERS' RECORD AND ADVISER.

No. 452. Vol. XIX. N.S. 60.]

FEBRUARY 19, 1891.

[Published Weekly

Editorial, Notices, &c.

THE LATE

REV. J. LAWSON SISSON.

With much sorrow we have to announce the decease of the Rev. J. Lawson Sisson, who passed away on the 11th of February, after a long and painful illness.

Mr. Sisson, as one of the pioneers of modern bee-keeping, had been indefatigable in advancing the industry in every way he possibly could, and his loss will be much felt by bee-keepers generally, and more particularly by those who knew him. He was born in Leeds on the 10th of January, 1816, and was therefore just seventy-five years of age. His father, Dr. Sisson, was master at the Wakefield Grammar School, and was a scholar of some distinction as well as a writer. He wrote an Anglo-Saxon grammar, an historical sketch of Wakefield, a work on Inland Navigation, and also on Divinity questions. His house was the rendezvous of authors and publishers, whom Mr. Sisson used to meet. As he was a delicate lad he was kept much at home, and having obtained a scholarship at Wakefield School of fifty guineas a-year for four years, he commenced his school-life there. From school he went to Jesus College, Cambridge, and after taking his degree he was ordained to the curacy of Monmouth by Dr. Musgrave, bishop of

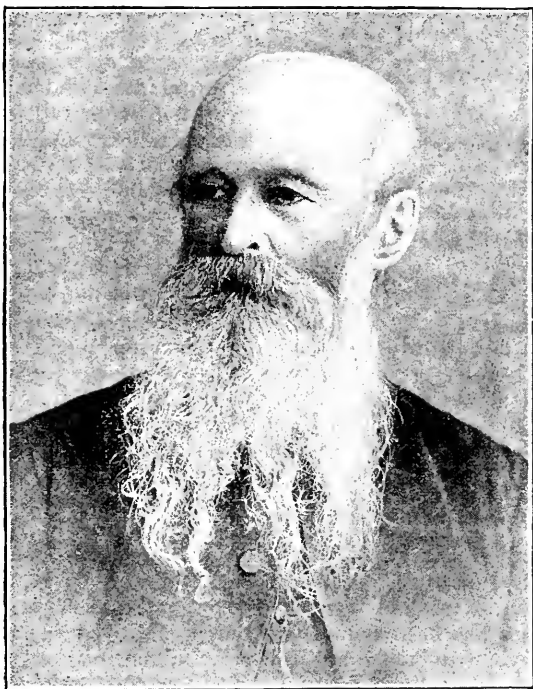

REV. J. LAWSON SISSON.

Hereford, in December, 1840. He took priest's orders in 1841. The climate being very relaxing he left Monmouth, and entered on the curacy of Hunstanton, in Norfolk. A few months after he was presented to the living of Swaffield by Lord Granville Somerset, who was Chancellor of the Duchy of Lancaster at that time. This living he held for seven years, and was then presented by Lord Carlisle to Edingthorpe, which living he held to his death. He and his predecessor had held this living for just over one hundred years.

Mr. Sisson first began to take an interest in bees in 1850, and being a good carpenter he made a number of hives—Nutt's, for instance, and those illustrated in a tract by Mr. Cotton of Oxford—the 'Conservative Bee-keeper.' Having put a curate into the living, he took his family to Switzerland for a time, and while there he was offered the English chaplaincy at Lausanne, to which he was licensed by the Bishop of London in January, 1857. After ten years' residence abroad

he returned home to take up his work at Edingthorpe, and started bee-keeping.

His connexion with the British Bee-keepers Association dates from its commencement, and he was frequently called upon to judge at its exhibitions. He was also among the first subscribers to the *British Bee Journal*, and continued his interest in it to the last. His contributions were generally instructive as well as amusing. His handsome countenance and long, white, flowing beard gave him the appearance

of a patriarch, and his powerful voice and fluency of speech caused him to be attentively listened by all whom he addressed. Fearless with bees he was always a welcome manipulator in the bee-tent, where his replies to questions often caused a good deal of amusement. He took a great interest in the promotion of the Norfolk County Association, and he wrote some hundreds of letters on bee-keeping for cottagers in the local papers. His letters made a stir among those who did not think of keeping bees, and through them many were induced to make a start. He was judge at many of the shows of the B. B. K. A. as well as County shows, and being a thoroughly practical man his awards generally gave satisfaction. Every new improvement that was worth anything was tried by him, and without reserve he was always willing to give information and advice. Besides bee-keeping, photography was a hobby of his, and was commenced by him some forty years ago. So proficient had he become in this science that Messrs. Marion published a small work of his on the paper negative process, illustrated with stereoscopic views taken from his negatives. The loss of his son a few years ago was a sore trial to Mr. Sisson, and for some time he had little heart to attend to his bees; but his ardent love for them revived, and although he was seventy-five, to the last he gave his bees the attention they required. His failing health during the latter years of his life had prevented him from taking a prominent part at shows, but those who remember him a few years ago will not easily forget how he attracted audiences to the bee-tent by his fearlessness with bees and his quaint, humorous remarks.

We are sure all bee-keepers will feel that they have lost a good friend, and one who has done much for bee-keeping, and will join us in sympathy with his relatives at his decease.

USEFUL HINTS.

WEATHER.—If Southern bee-keepers have a complaint just now against the weather, it is because of the summer-like warmth which for several days has been tempting the bees out, and mayhap inducing brood-raising on a more extended cell-surface than is quite safe. Notwithstanding the reports of a temperature certainly high for February in some parts, the frequently recurring night frosts warn us that bees would be all the better for a week or two of cool weather yet before normal spring activity is begun. Not that we should complain, for the sunny days with which we have been favoured have been of the utmost value to bees and their keepers alike, and it is not too much to say that both have profited by them.

CAUSES OF MORTALITY AMONG BEES.—It is

perfectly bewildering—while going through the correspondence received during the last few days referring to this subject—to attempt a diagnosis of the various cases presented to us for our opinion, and the simple confidence with which correspondents write to say—‘My bees have died, with plenty of food in the hive! I send you a few dead bees to examine. Please say what has caused their death?’—is very flattering to us as betokening the idea that the Eds. of the *B. J.* are veritable ‘wells of wisdom’ in bee-affairs. Unfortunately, however, we are entirely unable to give any answer at all in the majority of cases, other than that ‘we don’t know.’ Moreover, the very few details vouchsafed in most instances make it impossible to even venture a guess why the bees have died.

This much may be said: Bee-keepers who have had experience in managing fairly large apiaries can keep their bees alive in any winter experienced in the United Kingdom with a very small percentage of loss; and this being so, it only remains for less experienced readers of the *B. J.* to follow one or other of the methods adopted by such men. Having done so, they may rely on us when we tell them that in some way their management is at fault if they fail, and that when further experience has been gained they will be enabled to winter their bees safely.

At the same time, we can arrive at some general conclusion on the effects of the past winter, so far as it has affected bee-life, and it points to the certainty that bees have fared worse in cases where upward ventilation has been allowed than where close, non-porous coverings have been adopted. Odd instances will appear where contrary results have followed, but those who would dispute the point must kindly bear in mind that we are in an exceptionally favourable position for judging, and that our sources of information are such as are possessed by none other in the Kingdom. It seems as if the escape of heat—insensible though it would appear, and productive of no harm in an ordinary winter—has told its tale in reducing the vitality in some stocks. This, and the mistake made by so many of feeding on raw sugar, give the most tangible evidence which can be gathered from the correspondence before us.

After all, the winter has been anything but a disastrous one, for the great majority of reports sent in are most favourable.

BRITISH BEE-KEEPERS' ASSOCIATION.

ANNUAL MEETING.

We draw the attention of bee-keepers and those interested in the pursuit to the annual meeting of the above Association, which takes place at the offices of the Royal Society for the Prevention of Cruelty to Animals, 105 Jermyn Street, on Tuesday, the 24th inst., at 3.30 p.m.—the President of the Association, the Baroness Burdett-Coutts, in the chair. A *conversazione* will afterwards be held in the same rooms at six o'clock, when a paper will be read by Mr. R. A. H. Grimshaw on 'Bees and Odours.'

TO OUR SCOTTISH READERS.

SCOTTISH BEE-KEEPERS' ASSOCIATION.

We are glad to hear that there is a prospect of the formation of a Bee-keepers' Association for Scotland. For a great many years the Caledonian Apiarian Society has done good work. It was, in fact, one of the first societies to be started, and its foundation dates as far back as 1875, when it was brought into existence under the title of the Caledonian Apiarian and Entomological Society, and in connexion with the Glasgow and West of Scotland Horticultural Society. Shows were held in connexion with the Highland Agricultural Society, which was found to be more advantageous for the spread of bee-keeping than those previously held under the auspices of the Glasgow and West of Scotland Horticultural Society.

Much energy was displayed by the Society when Mr. R. J. Bennett assumed the secretaryship and while he was able to take an active part in the work, and much credit is due to him for the manner in which he managed the Society. However, increasing pressure of work has not allowed him to devote so much time to bee-keeping as formerly, and as he got no assistance from his Committee, and had frequently to supplement the funds by contributions from his own friends, the annual shows have ceased to be held, and when we were in Scotland Mr. Bennett was anxious to find some energetic gentleman, with time at his disposal, who would be able to work up the Association.

Practically, therefore, the Association has ceased to exist, and we think it would be of immense advantage if an entirely new association were formed, and work commenced *de novo*. In a country so highly favoured as Scotland for bee-keeping, and with such an array of bee-masters, there should be no difficulty in founding a society upon a sound and permanent basis, and we would ask our numerous Scottish readers who are willing to co-operate in forming such a society to put themselves in correspondence with Thomas D. Gibson Carmichael, Esq., of Chiefswood, Melrose, who is in communication with Mr. Bennett on this subject.

BEE RAMBLES IN SAVOY.

(Continued from page 78.)

A pleasant drive of two and a half hours brought us to the residence of Dr. Hemon, who met us at the threshold with his wife and little daughter, giving us a hearty welcome. We had seen Dr. Hemon some years ago and were glad to visit him again, for he was an ardent bee-keeper, and a noted botanist as well. In his beautifully kept garden we found forty hives of the Layens pattern, all in good order. Dr. Hemon does not interfere with these hives except to satisfy himself that they have plenty of food. They are left to develop themselves, and have all the frames (making up the twenty) given to them in the spring at one operation. They are then not interfered with until the honey has to be extracted in the autumn, and the bees prepared for winter. Wonderfully well this let-alone system seems to succeed: Dr. Hemon is rewarded by a fair harvest of honey, while he has time at his disposal for his other occupations. Just now he was experimenting on grafting vines on American stocks in order to resist the phylloxera, which had devastated the vineyards of France as well as the adjacent countries. Refreshments were partaken of here, and Dr. and Madame Hemon accompanied us to the station to see us off to La Roche, *en route* for Bonneville, whither we were bound that night, promising to spend the next day with our friends, when our bee-chat was to be continued. The line from La Roche to Bonneville was to be opened the next day, so they were going to take advantage of this to see more of us.

Our hosts accompanied us to the station at Annemasse, which we left by the 8.30 p.m. train, our destination being La Roche, where we arrived soon after nine o'clock. We passed through some lovely scenery, and regretted that in the dim twilight we could not enjoy it more. We remembered a rocky valley near Reignier seen some years previously, where amongst masses of rocks grew the lovely little *cyclamen* in profusion, but we were not able to see anything of them, and had to be content with past reminiscences, when we had visited this valley in the company of M. Bertrand and Dr. Hemon. At La Roche we took the omnibus which was to carry us as far as Bonneville, in the valley of Chamounix. After a considerable delay a start was made, and the reckless driving soon convinced us that the driver had been indulging rather freely. A halt was made at several *cafés* of such duration that at last we remonstrated, and asked if we were ever likely to reach our destination, for at every halting-place more wine was imbibed, and we began to fear lest we should never get to Bonneville at all. In reply, the driver said, '*Ma foi!* what would you have?' After twenty years' work on the road, there were many friends to take leave of, and one must take a parting glass, as this was the last run of the coach on this road!—as the railway was to be opened on the next day. However,

there was one consolation, and that was that the horses were sober and knew the road, and after a rather perilous journey in dense darkness we arrived at Bonneville, where M. Morel-Fredel met us, wondering what had caused such an unusual delay in our arrival. We walked to M. Fredel's residence, and there met with a hearty welcome from Madame Fredel and her son, which quite made up for any inconvenience we might have experienced in our journey. Late as it was we were glad of some supper, and then retired to rest, but not before we had had a good talk about bees. The night was lovely, and from our open windows could be heard the loud contented hum of the bees which were in the garden below. M. de Layens said they were *forging*, and it certainly sounded like the perpetual din of ironworks in the distance. Next morning we had an opportunity of seeing the bees and inspecting the premises. M. Morel-Fredel has between fifty and sixty hives of the Layens pattern, and obtains very large yields of honey.

Bonneville is picturesquely situated in the fertile valley of the Arve, flanked on the right by the rugged limestone works of the Bregon, and on the left by the slopes of the Môle, the summit of which rises 6127 feet. The valley is not very broad, but extremely rich in cultivation, so that there is very good pasturage for the bees.

The honey-flow is generally continuous throughout the summer. In the meadow-lands *esparcette* is cultivated, and when this is over the bees find their way to the higher ground of the Mont Bregon range, and also to that of the Môle. There is a continuous succession of bloom, and as the flowers low down become exhausted the bees ascend. Sainfoin was to be seen in all directions, and we tasted some honey having a most decided flavour of *astrantia*. M. Morel-Fredel, who knew the neighbourhood well, said that the nearest place where *astrantia* grew was eight kilometres, so that the bees must have gone all that distance to collect it. The hives were arranged in the garden with their backs to the paths and faced in all directions, so that they could easily be examined without standing in front of the stream of bees which come pouring in and out, most intent in their work.

On some of these hives, although occupying twenty frames, M. Morel-Fredel had worked supers. For several years he has obtained an average of 50 kilos. of honey per hive (110 lbs.), and one hive gave him 104 kilos.; and on another, occupying twenty-one frames, he was obliged to put a super to give the bees room to store their surplus. M. Morel-Fredel showed us his store-room, where his extractor was kept and honey and frames stored, and also told us a curious fact about the honey-flow. A hot day and a cold, dry night generally produced a large yield of honey the next day, but if it happened that there was a hot day followed by a cold dew at night, the next day produced honey-dew in profusion, so that the moisture in the atmosphere

appears to have something to do with it. Then with a *bise*, which is a sort of dry north-east wind, the honey-flow ceased altogether. We also remarked rotten wood placed on some of the hives, and this, we were told, was to amuse wasps and hornets, which were attracted by it and did not interfere with the hives. In fact we saw several wasps, while we were watching, come and nibble away at this wood, and carry small pieces away quite contentedly. Both wasps and hornets use rotten wood in the construction of their nests, and it would not be a bad plan for us to follow the example of M. Fredel, and give our wasps something to do instead of worrying our bees by endeavouring to get into the hives.

Dr. and Madame Henon arrived, and a most enjoyable day was spent comparing ideas and talking about bees and flowers. We shall never forget the hospitality of Monsieur and Madame Fredel, and how they made us feel at home at once.

(To be continued.)

MEADOWS' NEW REGISTERED FRAME.

Mr. W. P. Meadows (Syston) forwards a sample of this newest form of frame in the market. The sketch given by the manufacturer in our advertisement columns conveys so clearly the idea of the invention, that detailed description is unnecessary beyond saying that the new features in the frame fully answer the purpose intended. The foundation is fixed very rapidly, and when fixed it is quite firm. Many bee-keepers will no doubt adopt it because of its removing the (to many) objectionable lodging-place for the wax-moth larvæ afforded by the saw-cut in upper side of top bars. We shall give a personal trial of the frame this spring, and will report results. The 'paper-clip' is a very simple arrangement for keeping the lower edge of foundation in line with bottom bar.

DERBYSHIRE BEE-KEEPERS' ASSOCIATION.

The tenth annual meeting of the Derbyshire Bee-keepers' Association was held on Friday, January 30th, in the Town Hall, Derby, under the presidency of Mr. J. L. P. Barbar, J.P., C.C., there being a very good attendance. Mr. Atkins, Secretary, read the balance-sheet of the Society, which showed a balance in hand of about 40/.

The annual report was next read, which stated that the annual show was held by permission of the Derbyshire Agricultural Society in their grounds on September 10th, 1890. A large tent was erected, and in it was located a display of bees, honey, and appliances for bee-keeping on modern principles. The show was not so large as that of 1889, but, considering the very un-

favourable season, it was about equal in merit to any show to be met with in any part of England. The staging and the whole arrangements were carried out by Mr. W. T. Atkins, the Secretary, and reflected much credit upon him. Mr. C. N. White, of Somersham, was the judge, and during the day he also conducted an examination of candidates for the third-class expert certificates; all three candidates were successful. The same candidates contended for second-class certificates, and again all passed with credit.

From the Experts' spring reports we gather that the loss of bees belonging to members in the winter of 1889-90 was very small compared with the previous winter.

The year's honey results to members have been much below the average, and some considerable feeding had to be done to get the bees into condition for wintering.

In moving the adoption of the report the Chairman impressed upon the bee-keepers present the necessity for competing with the large trade done in foreign honey by inducing persons to join the Society and produce honey at home.

The report and balance-sheet was adopted unanimously, and after the usual votes of thanks to the various officials, who had rendered excellent service to the cause of bee-keeping by their personal efforts, the proceedings terminated by the election of officers for the current year, Mr. W. T. Atkins being again elected Hon. Sec.

NORTHAMPTONSHIRE BEE-KEEPERS' ASSOCIATION.

The annual meeting of the Northamptonshire Bee-keepers' Association was held on Saturday, the 14th of February in all Saints' Schoolroom, Northampton. The Rev. J. Phillips presided. There were also present Messrs. A. L. Y. Morley, H. Collins, W. Manning, G. E. Atkins (Hon. Treasurer), R. Hefford (Hon. Secretary), &c.

The report for the past year was read by the Hon. Secretary and adopted as follows:—'In presenting the Eighth Annual Report and statement of accounts for the year 1890, your Committee have the pleasure to state that after paying all liabilities due at the close of the year, a balance of 5*l.* 8*s.* 11*d.*, besides other assets, remain in favour of the Association. The annual show was held at Delapre in connexion with the Northamptonshire Horticultural Society Show on August 4th and 5th, when in consequence of the very poor honey season, the quantity exhibited was not so large as the previous year; Mr. J. R. Truss again undertaking the lecturing and manipulating in the bee-tent with bees lent by Mr. H. Williams. The Association also offered a few prizes, and sent the bee-tent to Fawsley Show on August 1st, Mr. C. Cox kindly undertaking the manipulating, &c., which was of considerable interest to members and others in that district, three new subscribers having since joined the Association. The Association owes its best thanks to the

Rev. R. A. White, Mr. J. Shaw, and Mr. J. R. Truss for kindly officiating as judges. The Association is also indebted to the following gentlemen for their kindness in offering prizes:—Messrs. Johnson and Wright, H. Williams, H. Collins, C. Cox, W. Bazeley, O. C. Hollis, and R. Hefford.'

The balance-sheet was then produced by Mr. Atkins, and after his explanations thereon it was considered very satisfactory.

The election of officers for the ensuing year was then proceeded with, Mr. A. L. Y. Morley being elected President, Mr. Hefford and Mr. Atkins were re-appointed Hon. Secretary and Hon. Treasurer, and the following gentlemen were elected on the Committee:—Rev. J. Phillips, Weston Favell; Messrs. H. Collins, Berry Wood; J. R. Truss, Ufford Heath; C. Cox, Brampton; W. Manning, Northampton; J. Cox, Bady.

Votes of thanks were passed to the retiring President, Lady Knightley, to the Managers for the use of the schools, and to the Chairman for presiding.

Correspondence.

The Editors do not hold themselves responsible for the opinions expressed by correspondents. No notice will be taken of anonymous communications, and correspondents are requested to write on one side of the paper only, and give their real names and addresses, not necessarily for publication, but as a guarantee of good faith. Illustrations should be drawn on separate pieces of paper.

Communications relating to the literary department, reports of Associations, Shows, Meetings, Echoes, Queries, Books for Review, &c., must be addressed only to 'The Editors of the "British Bee Journal," 17 King William Street, Strand, London, W.C.' All business communications relating to Advertisements, &c., must be addressed to Mr. J. HUCKLE, Kings Langley, Herts (see 1st page of Advertisements).

** * In order to facilitate reference, Correspondents, when speaking of any letter or query previously inserted, will oblige by mentioning the number of the letter, as well as the page on which it appears.*

IN THE HUT.

'If thou be a severe, sour-complexioned man, then I here disallow thee to be a competent judge.'
IZAAK WALTON.

[552.] Mr. Allen Pringle does not seem to like my italicising his article entitled 'The Inspector's Work.' I repeat my remark that 'He (the inspector) examines eighty-one apiaries, and finds foul brood in 350 stocks, and then, to use his own words, rushes on to other places. Yes, I think a great deal of it will be *his work*, performed, of course, in all innocence, and meaning well.' This, mind you, is in a district where foul brood is rampant, and where Mr. Pringle's inspector has been for *fifteen years dealing successfully* with the pest. Surely, they ought over there, with a fifteen-year-old 'sure cure,' to clear themselves of it, before roasting for us this 'chestnut;' before making one's maternal grandparent acquainted with the proper method of extracting the contents from the ovarian productions of female members of the poultry yard!

On the 1st instant I examined hives, seeing that bees were having a good flight in a temperature of 55°, and was surprised to find they had wintered so well. They have opened out strong and vigorous. A good deal of this is perhaps attributable to my having wintered them on nothing but heather honey, which contains only a small proportion of water, and is very slow in candying in the comb. I recently used a splendid shallow-frame slab of two years old for the table, and it was no more candied than marmalade. My neighbours (Huttites) are also delighted with their 'opening out.'

I have just returned from my first spring ride on my three-wheeler, having intended to see how the bees of the blacksmith's wife were looking; but alas! the roads were too rough and hard, and the rider too soft—the paste (pace) was too stiff, and the paper (X-Tractor) too thin! So I gave in after ten miles, and came home with 'a head so little there is no room for wit,' but room enough for a headache; and Moore tells us—

'You write with ease to show your breeding,
But easy writing's curst hard reading.'

Mead-making is legal enough, I think, but the rub comes when one sells it. Your readers will remember how the 'Devil of an Exciseman' stopped the sale of mead by the old lady, so well written of a couple of years ago by Mr. Godfrey. Brew it, and drink it instead of strong tea (the doctor's truest friend). We must all thank our brethren in the Inland Revenue Department for their good advice on this debatable point.

This bit of advice is only for those benighted (?) individuals who, like 'X-Tractor,' believe in frames parallel with the entrance:—At the first opportunity (50° in shade) take out two frames nearest entrance (probably now quite empty), and substitute the two back frames (probably quite full). Likely enough we shall have another cold snap (please don't take this as a prophecy), and the reduced area, with still plenty of food, will tend to keep all warm and snug.

Of all the bee-keepers I know, Mr. 'Useful Hints' is most to be commiserated. With the bees he loves so well so far from him, well may he wish—

'Mine be a cot beside the hill;
A beehive's hum shall soothe mine ear;
A willow brook that turns a mill
With many a fall shall linger near.'

I should like to be behind him and 'tak' notes' when he goes to see them, and fulfil the office of—X-TRACTOR.

EXPERTS' VISITS.

[553.] As the time is now approaching when Country Associations will be sending out their experts on their spring visits, I should like to suggest that every expert should be supplied

with a memorandum-book, the leaves of which should have a form something after the following printed on them:—

Name of Association.

Expert's visit made by	Date	1891.
Name and address ^o of person visited,		
Number of hives,	frames,	skeps,
Time occupied in visit—from		to
Condition of bees,		Instructions left,

This form to be filled up in duplicate, one copy to be left with the member or person visited, and one copy left in the book.

The back of the forms left might be used as a means of advertising the Association when a visit was made to a non-member, by printing the rules and advantages of the Association. By having a book of this kind the headquarters of the Association would be well posted in the work done by their experts, know exactly how their time was employed, and the persons visited would have the written instructions for reference.

At the Committee meetings of the Association the book would be open for examination by any member, and places where foul brood was prevalent, and whether the expert had gone direct from a foul-broody apiary to another, seen at a glance. A certain number of these books might be issued by the Committee to the local hon. secretaries, or others who were competent experts *and thoroughly acquainted with foul brood*, and who were willing to devote some of their time to expert work free of charge to their Association. There would by this means be a permanent record of the members visited and the expert work done during the season.—T. D.S.

[A very excellent suggestion, and one we should like to see carried out by every B. K. Association, not only for the ready means of keeping Committees posted up as to the work of their experts and the condition of members' bees, but for the extra precaution against foul brood it will ensure on the part of experts themselves.—Eds.]

APPLIANCE DEALERS.

[554.] It is very indulgent of you, sirs, to again allow space for discussion of this subject. I am accused by Mr. 'G. J.' (540, p. 68) of being 'a friend in court of defaulting appliance dealers,' and of 'an attempt to make them out pure and spotless;' but, sirs, on opening my *Journal* (12th inst.) received this morning, I find there (546, p. 79) a complete refutation of the epithet 'defaulting' by Mr. Woodley as applied to the unknown dealer against whom Mr. 'G. J.' makes this grave charge, and which is the case in hand—not that of all defaulting appliance dealers, which Mr. 'G. J.' would make it to appear. I can add nothing to the simple, quiet defence of this dealer's character by Mr. Woodley as in accordance with the evidence submitted; it makes everything so clear that I should say it is unanswerable. I might have an equal 'intention' with Mr. Woodley, whatever Mr. 'G. J.' means by that, but would be unable

to defend him anything like so well. But, sirs, there is another aspect of the case: the word 'defaulting' being swept away by Mr. Woodley, I presume I am to be considered as a friend in court of this unknown appliance dealer, and that Mr. 'G. J.' wishes I should be considered as such. Let us then investigate the evidence as contained in his letter (471, p. 582) a little more closely. I have done exactly as I have been 'desired,' have written to my friend for the *Journal* containing it, received it back on Thursday last, and now, with your permission, will quote a few extracts, not my own mild version of the affair, but Mr. 'G. J.'s' own exact words, and see what inference we can draw from them.

Mr. 'G. J.' writes to a dealer for sections, &c., enclosing payment for them according to the dealer's advertisement, and continues: 'We got word that the particular priced section was sold out, but he could supply a dearer and better quality if we advised. There being no time to wait we were reluctantly obliged to wire him, to "send goods specified to amount sent."' Now, sirs, what did or could this telegram mean but to send the better goods at the higher price? and does not this telegraphic contract rule Mr. 'G. J.' altogether out of that of the advertisement? What, therefore, does he mean by 'We wrote again, threatening litigation except the balance was refunded;' and, as in his last letter, 'Emphatically no; he had not the value of his money according to the dealer's advertised price list.' This all just means Mr. 'G. J.' is endeavouring to force the dealer in question to give him his best at the price of his inferior goods, and, when threats of litigation fail, branding him in the *B.B.J.* with the epithet of fraudulent.

I leave it to the readers of the *Journal* whether this is not so, and whether such a course is reasonable, right, or just. I might use stronger expressions, but forbear, and pass over Mr. 'G. J.'s' remaining personalities with the remark that they show a weak case, and that the complainant resorts to them only from lack of argument and knowing he is in the wrong.—W. B., *Patrickswell, Co. Limerick.*

[We must respectfully decline to insert further letters on the above subject—for the present at least.—Eds.]

MOUNTING OBJECTS FOR THE MICROSCOPE.

[555.] Could you, or any of your correspondents, give some plain instructions on mounting insect subjects for the microscope? I have a powerful microscope and should like to study the anatomy of the bee. I have never mounted any objects properly, and have no appliances for injecting the blood vessels, &c. Can this be dispensed with? Also, is it necessary to make sections of the part it is desired to study, or can the organ, if not too large, be mounted as it is?

What preservative fluid should be used? The subjects I should like to try my hand on would be the wings, legs, tongue, sting, and any of the internal economy possible. I am afraid that the above inquiry is rather a large order: but there may be others whom it would interest, and any hints would be gratefully received by—*MOTICHE À MIEL.*

P.S.—Can you recommend any low-priced book on the subject?

[The subject referred to by our correspondent will be dealt with ere long in the series of 'Bee-Papers for Winter' now appearing in this paper. It will not be possible in the space of a single paper to do more than glance at a few of the many branches of the science interesting to microscopists; but 'mounting objects for the microscope' will have special attention from one of the Editors, a practical microscopist, who has himself mounted some hundreds of objects for his own use, and who will give the information asked for from personal and practical experience. A suitable book for the purpose is Davies' on *The Preparation and Mounting of Objects for the Microscope.* W. H. Allen & Co., Waterloo Place, Pall Mall, London. Price 2s. 6d.—Eds.]

NAPHTHOL β .

[556.] I find naphthol β is very difficult to keep soluble. It dissolves very easily in alcohol, but the moment it is added to cold water it precipitates again, and if this is so in cold water would it not do the same when the syrup is cold? I should be glad if some bee-keeper who is a chemist would give some information on this subject, and the best way syrup and candy could be medicated with it.—T. D. SCHOFIELD, *Oakfield, Alderley Edge.*

[Naphthol β is soluble in alcohol, and if this solution is poured into hot water it remains in solution even on cooling, unless there is an excess of naphthol. It should be put into syrup when this is hot, or before it is taken off the fire. The simplest way to prepare syrup would be to weigh out three grains of naphthol for every pound of sugar used, and dissolve it in as much alcohol as will form a solution, then add this to the syrup while it is being boiled. For medicating candy, when the syrup is boiled to the proper consistency, pour in the solution and stir till set.—Eds.]

SINGLE OR DOUBLE-WALLED HIVES.

[557.] The break-up of the frost is evidenced by the well-filled and diversified pages of the *Journal* as well as by flights of the bees. The regular staff were, of course, compelled to give us 'copy' whatever the state of the weather, and notwithstanding a probable desire on their part to hibernate with the rest of us. I hope that all feel duly grateful to them for 'keeping the pot a bilin'' while we were lazily doing nothing; or, perchance, sedulously bumping

ourselves against the ice—almost as lively an occupation as that of bumping bees.

Considerable interest is naturally aroused as to the comparative virtues of the single and double-walled hives. The writer of 'Useful Hints' comes to the conclusion, after recent experience, that the single-walled hive with outward casing is all-sufficient. Such a hive is practically a double-walled hive, and to describe it as single-walled is liable, I think, to lead beginners astray. 'So high an authority having pronounced in favour of the single-walled hive,' the beginners will say, and forgetful of the outer casing, 'what need have we of more?' and come to grief in consequence. Mr. 'U. H.'s' double-walled hive, though these walls be thin, gives, in my estimation, greater protection than would a hive whose single walls were $1\frac{1}{2}$ in. thick.

How has Mr. Wood fared this winter? Likely enough his bees have as much grit as their keeper, and have persisted, in spite of the cold, in doing well in their half-inch walls. A temperature of 35° below zero, such as Dr. Miller (532) speaks of, would be the test for the rival systems. I had the pleasure of knowing what 34° below zero felt like when I passed a few months in the State of Illinois, seven years ago. My great regret now is that I was not then acquainted with the names of American apiculturists, else I should have considered it incumbent upon me to honour the Doctor with a call as a relief from the dreary work of tie-counting, which I was engaged upon in the previous autumn. Professor Cook, of Lansing, in whose neighbourhood I passed the greater part of a year, would doubtless have been similarly distinguished. Right here allow me to correct the writer in *Farm and Home*, whom you quote in your last number. 'Almost every farmer in that country' (America) 'keeps at least a few hives.' So far as my observation went (not very keen for bees then, it is true, and that was seven years ago) very few farmers kept bees. Almost all the bees I saw were kept in their spacious villages—no, not villages, but cities—I doubt whether any well-regulated American would be so wanting in civic pride as to refer to his cluster of cottages, hotel, saloon, post-office, and store, as a village! 'No, sirree!'

I have unwittingly wandered from my subject, and return to it to say that a single-walled hive that I have had, up to the present winter, persistently given bad results. The hive was always damp, and the bees dwindled in numbers. This winter it has done well. The change is due to a return to the crown-board of the early frame hive. This board, half-inch thick, I placed so as to allow bee-space between it and the frames, and was, with the exception of a single thickness of slightly overlapping calico, the only top covering the bees had besides the cover itself. The hive is now strong in bees, and is dry. There has, however, been considerable consumption of stores. My experience during this and past winters points to the

following as the ideal conditions for successful wintering:—A watertight 'parallel' hive having double side-walls with air-space only between; six or seven fairly filled broad-shouldered or metal-ended frames of natural stores (cheaper than sugar in the end), and two or three empty frames next the entrance; the entrance not less than four inches wide, and a strong stock of bees packed beneath a substantial porous quilt of calico and sacking. Such is my ideal, and it will be my endeavour in future to come up to it. I am short of it this winter, for I have two stocks defunct mainly through the absence of one of the above conditions, viz., that of having the bees strong. These two stocks were queenless for several weeks in the autumn, and went into winter quarters weaker than they should have gone.—EAST GLAMORGAN, *February 9th*, 1891.

DIRECT HIVING OF SWARMS.

[558.] On page 170 of last year's *Illustrierte Bienenzeitung* was a description in an article by the respected editor, M. Gravenhorst, of a new swarm-box, into which the swarm is placed, and no second transfer is needed. As represented it does not seem a practical one for English frame hives, but it may be adapted to suit our requirements by the exercise of a little ordinary ingenuity. Let me borrow the W. B. Carr hive to explain further, and refer to the figures on p. 17 of your monthly, the *Record* for '90, for each separate part. I want three of these parts, No. 5 (the body-box), No. 7 (the stand), and No. 8 (the eke), although the latter is not necessary.

The very simple idea is, if the swarm settles low, place the stand over it, near it, or as best you can, with the body-box containing six of the ten frames, with or without the eke between them. No floor-board is wanted. Darken the inside as much as possible by placing two pieces of black calico crosswise over all down to the ground, leaving an entrance or two for bees to join the swarm, which will, in all probability, at once ascend into the frames, and if tempted by some comb foundation, will take possession of the body-box at once, to be treated like any other swarm when hived. The frames, put a good way apart, allow the bees to crowd into them better, and the frames can be filled up to the full number afterwards when all have settled down and been placed.—J. G. K., *Grove House, Southborough, Tunbridge Wells*.

ENGLISH BEES VERSUS HYBRIDS.

[559.] No, Mr. Woodley, it would not take centuries for a race of bees to deteriorate. Without going into unlimited time, does your correspondent think that young queens bred from parents that are themselves so nearly related as cousins would be as strong, active, and healthy as those bred from bees where there is no consanguinity? Can we point to any animal with

which we are familiar, and say in-breeding is not detrimental to its health? I admit that bees have a very wise natural instinct which impels them to mate with fresh blood; and I am not aware that it has ever been noted as a physiological fact of a queen-bee mating with her brother; but I fully believe queens are very much in the habit of mating with their own near relations where there are only two or three hives kept in a large radius. Where a bee-keeper has a continual supply of fresh blood every autumn in-breeding undoubtedly will be very small, but where no fresh queens are brought to a small apiary mating of blood relations is sure to take place; and if others are blind to the inevitable evils thus arising, I, for one, am not.

Referring to the proposal of Mr. Woodley on p. 66, I have five pure English stocks of bees in my apiary, just about equally strong with the other forty-seven, and at the end of the coming season I intend comparing results as intimated. I have successfully wintered fifty-two stocks of bees; by mistake my last communication gave the number as forty-two.

I can assign other reasons than those given for the two English stocks dying. Mr. Henry Neve (No. 531, p. 64) cites it as an advantage gained by English bees over hybrids that they did not breed as many young bees last autumn as the foreigners. If 'No. 531' ever gets a heavy honey yield he *must* have plenty of workers, and this is just what my hybrid stocks have throughout summer; they will keep up their numbers, and as a consequence, in a poor season like '90, they have all bees and little or no honey. But what in a good season? Why, instead of storing nearly all their honey in the brood combs, and crowding out the queen and then lying idle the remainder of the season, they have a good-sized brood nest to keep up the continual supply of workers needed to gather surplus for any length of time. They are exceedingly energetic whenever there is honey to be gathered, and if they have not room in advance of their requirements they resort to swarming. Let Mr. N. or any one else procure a good, strong, well-bred stock of pure English bees, and he will find them resemble hybrids in all noticeable qualities, including 'stingitiveness.'

With regard to the risk of introducing foul brood with imported queens, my reply is: I have never experienced foul brood either through imported queens or by any other means. Mr. N. also refers to excessive swarming with a limited brood nest, and over-breeding in an unlimited brood chamber. But how could my hybrids have given such good results in 1889? No, sirs, 1890 was not the best year to compare natives with hybrids, nor the fairest. We must take, say, six to ten seasons together to compare results fairly. Carniolan bees, though easily subdued with smoke, are very excitable, and must not be disturbed needlessly.

Birds are a great nuisance in this neighbourhood; however, I am trying to defend my bees

against their attacks. I have caught twenty-three tomtits since Christmas in steel traps baited with suet.—ERNEST E. DAVIS, *Great Bookham, Leatherhead.*

BRITISH AND IRISH HONEY COMPANY.

[560.] It has for some time been my intention to give some account of the transactions of the British and Irish Honey Company, which have resulted in considerable loss to many correspondents, as well as myself.

I have been waiting for the co-operation of the Chairman, but after reading letter 533 I wait no longer. In this letter Mr. Woodley gives information which comes as a surprise to me, as I distinctly recollect the Chairman saying that Mr. Woodley's, among other accounts, must be paid. No one sympathises more than I do with those whose losses have been so heavy. 'A fellow-feeling makes us wondrous kind.' I have this week received a cheque for 1*l.* 7*s.* 2*d.*, my share for debenture of 25*l.* To this loss must be added the value of one share and the expense of attending meetings. Twice no meeting could be held for want of a quorum.

I was induced to take shares in the Company in October, 1889, through the representations made to me by the then manager, and after receiving a prospectus, on which was printed in red type, 'A well-established Home Industry, earning ten per cent. per annum, with prospects of considerable increase.' How such a statement could be made by the light of subsequent events I fail to understand.

To me at the time everything appeared satisfactory, and, desiring a fair interest for a small investment, I took the step I *very shortly* afterwards had reason to regret. Being asked to become a Director, I thought an opportunity presented itself for enabling me to do something towards assisting bee-keepers to find a good market for their honey at remunerative prices, and therefore I agreed to accept the position.

When I went up to a special meeting of the shareholders, called for the purpose of electing me to the position of Director, I found matters in a sorry state, the Company being in the hands of a Receiver. Of course I naturally declined to accept the position of Director under such circumstances.

The Manager declared that the Company had been brought to ruin by the Directors, and that if only they were removed the Company could not fail to prosper. He also introduced a gentleman who, if the Directors were removed, was prepared in a short time to put 500*l.* into the concern, so convinced was he of its ultimate success. This gentleman took *one* share and became a Director. Accepting the assurances given for the future success of the Company, and seeing that the only way for any creditor to be paid was to carry on the Company in a more economical and more business-like manner, I was prevailed upon to become a Director on the

new Board. This was in March, 1890, although I had been advertised as a Director the previous autumn. This I found was sent to the *B. B. J.* by certain of the officials on their own responsibility, and for this action I hold an apology from them.

When I went on the Board it was on the distinct understanding that I should not attend all the meetings, and I was content to leave matters wholly in the hands of the Chairman.

At the first meeting I proposed that cheques should be signed only by the Chairman, but it was not acceptable to the Board. I subsequently learned that business from that time was carried on almost wholly by the Manager and the Director who lived near the depôt, and had risked *one* share in the affair. At a meeting called by the Chairman, who was not satisfied with the management, it was found that matters were as bad, if not worse, than they had been a few months before, and he remonstrated strongly on the reckless business transactions which had been carried on, with the result that the one-share Director resigned. The Chairman then sent me an urgent request to attend a meeting, which I did; but the Messrs. Timberlake, who held 500*l.* debentures, for which, by the way, they paid nothing, opposed—then and at the following meetings, which I did not attend—the drastic remedies which were then necessary to save the Company. As their voting power was overwhelming, the Company again went into the hands of the Receiver, with results so disastrous to many.—C. N. WHITE, *Somersham, Hunts, February 7th, 1891.*

NOTES BY THE WAY.

[561.] The weather still continues fine and dry. Barometer steady, at or about *set fair*. Thermometer during Sunday, 15th inst., 52° in the shade. Bees busy foraging for any forward blossom they could find open, principally snow-drops, jessamine, and daisies at present; but the crocus is pushing up through the ground, and in a few weeks' time, if this beautiful weather still lasts, we shall have the borders aglow with its cups of gold, and our busy bees revelling in its abundant supply of pollen.

Food Supplies.—This constant everyday flight and attendant growth of the brood nest will tax the resources of the storehouse, and where the cakes of candy have disappeared quickly a further supply should be given as required.

In a recent note I gave the number of bee-keepers in America as 300,000. Friend Root, in *Gleanings*, says that 300,000 was the estimated number some three years ago, but that the number has probably increased to 500,000 at the present time. These large numbers give us an idea of the extent of the 'bee industry' in that great continent. On wintering bees in cellars, Mr. J. A. Pearce, of Michigan, U.S.A., writes in the *American Bee Journal* that he weighed his hives of bees when put in the cellar, and that on weighing them again a month afterwards was surprised to find them turn the

scale at the *same weight* as they did a month before. How was that, I wonder? He says the temperature of the cellar was 42° to 44°.

I would like to endorse 'E. M.'s' suggestion (551, p. 81) *re* price of books reviewed, where convenient. 'E. M.' propounds several questions which probably would be replied to if he had been more explicit. I cannot answer his first question without knowing the extent of his apiary. To his query *re* foundation, I say, Buy your foundation of a good maker; it will be cheaper in the long run even if you have nothing to do in the meantime.

Leaky hive-roofs, damp and mildewed wraps, cushions, and quilts are not conducive to either the well-doing of the bees or the credit of the bee-keeper, and such a state of things should never be allowed in the apiary. For a remedy take a piece of grey or unbleached calico, cut it large enough to cover the roof of the hive, and nail on under the eaves of the roof with tinned tacks; but before you tack on the calico give the roof a coat of thick paint, and then spread on your piece of calico, well work it in the boards of roof with your hands, stretch and nail on around the eaves, and then give another coat of paint on the top of the calico-covered roof. 'Brooks's soap' and warm water will clean the hands after the job is done. This will render any old hive-roof waterproof, provided the boards of same lie flat, and are nailed down so that the sun does not warp them to tear the calico; also be careful to drive nail-heads well into the wood and putty same, or rust will soon eat through your calico.

What about super-clearers, bees' escapes, and other kindred subjects? I trust our friends and brethren of the craft speak out. 'What think ye of these things?'

I am pleased to notice in both *Gleanings* and the *American Bee Journal* review notices of our editor's latest work, *The Honey Bee*, in very flattering terms. The *A. B. J.* says the illustrations are 'marvellously fine; the subject-matter is as interesting as a *novel*, and withal highly instructive.'

What has become of our Kentish friend, 'Platelayer?' We have not heard from him lately. If this meets his eye, I hope it will 'rouse him up.'—W. WOODLEY, *World's End, Newbury.*

WEATHER REPORT.

PLYMOUTH.—*January, 1891.*

Maximum. . 51° on 23rd. Rain on 15 days.
Minimum. . 19° 8' on 18th. Rainfall, 2.97 inches.
Frosty nights 16. Heaviest fall, 0.62 on 29th.

Remarks.—The weather was very cold and bright until the 20th, when a thaw set in, and the remainder of the month was mild, wet, and foggy. No snow has fallen. The bees (Carniolan hybrids—five bar hives) were out for a fly on 1st, 14th, 16th, 25th, 27th and 30th. On the 25th they were out in full force, and had a thorough cleansing flight.—J. F. R. AYLEN.

WINTERING REPORTS.

SOUTH DEVON.

When last autumn I packed into winter quarters my sixteen lots of bees, I was pleased to find all well but one, which had evidently lost its queen. We have had severe weather, as elsewhere, although not so long in duration. The latter part of December and through January my bees had frequent flights; some are now carrying in pollen from furze, &c. I pack with porous coverings and $\frac{1}{2}$ -inch entrances. My hives (home-made) are loose body-boxes with outside $\frac{3}{8}$ -inch cases, no packing sides or ends, and I have always had success with such. I am feeding with dry sugar—Porto Rico—over brood nest, in boxes with $\frac{1}{2}$ -inch holes drilled in bottom, the bottom of box $\frac{3}{8}$ -inch from quilt, through which I cut a hole or two for the bees to come up through; with such boxes I avoid removing quilts so early in the year, also the making of candy, and I have found such arrangement answer, and push on the bees for an early honey-flow from the orchards, &c., round here. Also no waste, as the sugar forms itself into a firm mass, and can fill the boxes from the top as they stand on the bars. I will be glad if some will try my plan and report results.

I have made a few hives this winter from ideas of my own, but as they have not been experimented with yet, I say no more, as perhaps you might think my ideas rather wrong; I do myself sometimes—*afterwards*.

I hope your *Journal* is enjoying increased circulation; it deserves to do so. With best wishes for the year, and looking forward for a good year for all,—DRONEY, Paignton.

WILTS.

In your note to No. 543 (page 68) you say that the queen-wasp must have had warm quarters. I caught a queen-wasp last autumn to dissect. Putting her in a match-box, I forgot all about her until last week. I heard a scratching noise and opened the box, and she was quite lively and in good condition; in fact, she seemed plumper than when put in first. Now, this box had been in a room without a fire all the winter, and had to bear many degrees of frost, as water was constantly frozen there. I forward the queen for you to see; also please note how she places her wings, quite underneath her body, no doubt for protection. The loss of bees around here is not so great as one would expect after so severe a winter. I think the principal cause was not having sufficient food in the individual frames the bees clustered on; most of mine had only about three inches of sealed food on each, so left in more frames than usual. Many of the stocks which have perished had winter passages and plenty of honey the other side of frames, but no doubt it was too cold to get at it, as there was no break in the frost for so long; so it shows the necessity of having the honey contracted to as few frames as possible, as no doubt their wintering on cold slabs of honey is better than letting them starve.

Double v. Single-Walled Hives.—Most of my hives are single, and I find them quite as good for wintering as double. For an experiment I tried a few years ago a hive made from a starch-box, three-eighths of an inch thick. It stood the winters well, and gave me as good an average as any double-walled hive I had.

English Bees v. Hybrids.—I quite endorse Mr. Woodley's opinion as regards English bees, but cannot say anything for or against foreigners, never having kept any, being quite satisfied with our browns. I have opened hundreds of stocks and driven as many, but never found a case of foul brood in this district, nor do I think there are any foreign bees in a radius of seven miles.—A. J. NOYES, Pewsey, February 9th.

Queries and Replies.

[316.] *Suspected Foul Brood.*—Will you kindly advise me in next issue of *B. B. J.* what I had better do under the following circumstances?—1. I wish to renew all or part of the combs in two of my hives, as I believe it is time, seeing that they have been occupied by bees, one since 1887 and the other since 1888. I should like to perform this operation before breeding commences. Another object I have in view is to take away some of the drone cells, as I had a lot of these idlers last year. 2. I lost two stocks last autumn with something like foul brood and robbers. I sent a sample of the comb from each hive to the *Dublin Weekly Freeman*—which paper has a bee-article every week—but did not get a reply such as to convince me that it was foul brood. I am anxious, if possible, to save my other stocks (eight in number) by taking needful precautions and using medicated syrup during the coming spring, for which I have ordered a supply of foundation and a bottle of formic acid. Please say how shall I proceed and how soon shall I commence, as I am very anxious to check the disease, if disease it is? All the remaining stocks appear to be strong in bees, and have got through the winter all right so far.—SUBSCRIBER, Co. Kilkenny, Ireland.

REPLY.—1. You cannot renew combs 'before breeding commences,' because bees will not build out the foundation until they begin breeding. When the weather is settled and warm, and the bees are becoming sufficiently numerous to fill up seven or eight frames well, begin to renew the combs by removing one of the outside ones; insert a sheet of foundation in the centre of brood nest at intervals of three or four days, if you are safe against frosty nights. 2. Will it not be the wiser course to send us a sample of the suspected comb, and let us judge whether there is any necessity for taking precautionary measures before any trouble or expense is incurred?

[317.] *Photographs of Apiaries.*—I would

like to ask you, Messrs. Editors, if it would not be possible to give us a little more illustration in the *Journal*? When there are so many amateur photographers about, many interesting photographs of apiaries, hives, &c. I am sure would be sent you for reproduction, which would be of great interest and often instructive to your readers.—T. D. S., *Alderley Edge*.

REPLY.—The subject named has already been referred to on p. 36 of *B. J.* for January 15th last, and as there stated is under consideration.

[318.] *Transferring Bees*.—1. I have some stocks in straw skeps which I wish to remove into frame hives: which is the best time so that the bees may make the best return this season? 2. When uniting two or more stocks of driven bees, how am I to know the best queen to let remain with the stocks?—IRIS.

REPLY.—1. The bees will make the best return by being stimulated to swarm early, the swarm being fed for a few days after hiving in frame hives, then giving surplus room. Transferring bees and combs from skeps to frame hives is a practice wisely being allowed to fall into disuse. 2. It is not possible to choose the best queen merely by sight. Some information should be sought as to the history and antecedents of each, and preserve the most promising queen of the two.

Echoes from the Hives.

Old Eastbourne, Sussex, January 10th, 1891.

Upon examining my bees in the last week in January, I was glad to find all three hives with plenty of bees and food. My employer has five stocks, which are also in very good condition considering the severe weather we have had. I was very anxious about a late swarm hived last year on six frames, and with a driven lot added in the autumn. I found that stock more lively than the rest, but not so well off for food, so I made a cake of soft candy which will last them till the middle of March, and think all will do well until then.—R. SHATFIELD.

Leazes Lodge, Durham, February 10th, 1891.

—I read with much interest the 'Echoes' from various parts of the country, which are both interesting and profitable. Therein are recorded failures to warn us, successes to stimulate and cheer us, others which only make us smile—yet in reading these we feel to fraternise with the writers, for we have passed through some of the same difficulties. I purpose now to cheer up my fellow-bee-keepers with the gladdening news that four of my stocks were carrying full-sized pellets of pollen on Sunday, the 8th inst., the thermometer standing at 43°, but with bright sun. I consider this is very cheering after having had 30° of frost. The mention of frost calls to mind the many favourable reports of the double-walled hives, but, having used both, I fail to see the advantage of one over the other for wintering stocks. I think the chief points to

keep in view to be successful are:—1. Keep the inside of the hive perfectly free from damp, whether from condensed moisture or from any imperfection of the hive. 2. Ample stores, sufficient for the winter, sealed early in autumn. 3. Woollen cloths above the bars, with plenty of dry hay, which will absorb any moisture that may happen to be there from any cause; a watchful eye, that this may be removed whenever it feels damp, and fresh supply given. I think there is much misconception respecting bees dying from frost. The winter of 1888 and spring of 1890 were the most fatal to stocks for a number of years, yet it was not a severe winter. I often think if we would look back we could find a predisposing cause for many deaths which we attribute to cold.—J. R.

Notices to Correspondents and Inquirers.

Letters or queries asking for addresses of manufacturers of correspondents, or where appliances can be purchased, or replies giving such information, can only be inserted as advertisements. The space devoted to letters, queries, and replies, is meant for the general good of bee-keepers, and not for advertisements. We wish our Correspondents to bear in mind that, as it is necessary for us to go to press in advance of the date of issue, queries cannot always be replied to in the issue immediately following the receipt of their communication. All queries forwarded will be attended to, and those only of personal interest will be answered in this column.

JOHN SMITH (Cumnor, Oxford).—*Bees Dying in Winter*.—The past winter has been too severe for a stock established from a driven lot in autumn. You don't say if they had combs to build, but in any case two or more lots should be joined together to make up a decent colony from driven bees. They may still pull up if kept warm and fed regularly. We don't advise you to rob other hives of their brood to help the weak one; rather let it take its chance than weaken others in order to save it. The two numbers of *B. J.* will be forwarded to you on receipt of 2½d. in stamps.

BEE-STING (Saltburn-by-Sea).—*Tea-meal for Candy*.—Two large table-spoonfuls are sufficient for five or six pounds of candy, though three will not be harmful.

G. M. EDMONDS (Stoke Doyle Rectory).—*Bee Flowers*.—Under the circumstances we should sow only *borage* and *mignonette*. For another year, *wallflower*, *white rock*, and *crocus* might be introduced.

O.—*Feeding with Granulated Honey*.—If made into a stiff paste by the addition of 'icing sugar' while the granulated honey is slightly warm, it may be mixed with pea-flour and fed to the bees.

BRITAIN WHITEFIELD (Fishponds).—1. Rapid feeders, as the name implies, are entirely unsuited for spring use in slow feeding. You can make a cheap slow feeder, like that depicted on p. 26. 2. Give soft candy till weather becomes warmer and bees are carrying in pollen, when thin, warm syrup might be substituted. 3. Bees may be transferred to a clean, dry hive on any warm day.

THE
British Bee Journal,
BEE-KEEPERS' RECORD AND ADVISER.

No. 453. Vol. XIX. N.S. 61.]

FEBRUARY 26, 1891.

[Published Weekly.]

Editorial, Notices, &c.

BEE-PAPERS FOR WINTER READING.

No. 5.—HONEY PRODUCING.

The question must frequently suggest itself to those having much to do with bees, 'How would matters stand if we could rely on a good honey season every year?' Without being prepared with a very deeply thought-out reply, it will be safe to say the subject would assume an altogether new aspect, just as it would if bees were possessed of no stings. In a word, if bee-keepers could be perfectly sure of continuous fine weather for two or three special months in every year, honey would be obtained in such quantities that it would pay to sell it at two-pence per pound. What that means, who can tell?—but any way, the question is robbed of so much of its speculative character by stern facts which none can alter that we may be quite sure honey producing will always remain a comparatively minor industry in this country, no matter to what perfection the art of managing bees is brought; and we are inclined to think that the uncertainty always hanging over us is really a blessing in disguise, for the pleasures of bee-keeping are certainly enhanced by the element of risk, or chance, so dear to all men. Besides, there is a sentimental interest about

'The beehive's busy hum'

suggestive of sunshine, and flowers, and sweet, perfume-laden air, which entirely disappears if we contemplate honey handled in big barrels by rather uncleanly and 'sticky' labourers.

We therefore approach our task of dealing with honey production conscious of the difficulties surrounding it, and with very vivid recollections of the bitter disappointments beemen undergo, for are we not bee-men ourselves? and haven't we planned, and worked, and schemed, and toiled, 'all along of those blessed bees,' and had to wind up the year's labours with the comforting bit of philosophy ending with, 'Ah, well! let's hope for better luck next time?'

By these remarks we by no means wish to infer that bee-keeping means a series of attempts to attain something we nearly always fail to secure; but the really *good* honey seasons when they *do* come produce such enormous results

that their effects on the minds of those who have had the good fortune to participate in them remain for years afterwards, and cause us to regard twenty or thirty pounds of surplus per hive as a disappointing result, which of course it is in comparison.

Then, again, the enormous amount of surplus per hive which improved methods have made possible has naturally brought prices down, and rendered it necessary to consider what system of working will yield the best all-round return. In this direction the tendency of late years has been unmistakably in favour of working for extracted rather than for comb honey, and the amount produced by the former method is increasing yearly, first, because of its being found the more 'saleable form' of the two, and, second, because it possesses the enormous advantage of being removed from the list of 'perishable goods,' which will always remain as one of the disadvantages attaching to honey in comb. We therefore give first place in importance to extracted honey as that which most bee-keepers elect to work for.

WORKING FOR EXTRACTED HONEY.—It may be taken for granted that the weight of surplus a colony of bees will gather when worked for extracted honey almost doubles that which could be secured by the same stock labouring for honey intended to be sold in the comb. This fact is so generally admitted that we need occupy no time in proving it beyond saying that so clearly was it demonstrated to our mind years ago that, in the face of some opposition—now happily passed away—we have so persistently advocated the adoption of a shallow frame for storing surplus in, that its general adoption may now be admitted as an accomplished fact, while the $14 \times 5\frac{1}{2}$ frame is now regarded as a dual standard for surplus along with the well-known $14 \times 8\frac{1}{2}$ Standard frame for brood chambers. While mentioning Standard frames—single or dual—we may here say a word on the vexed question of Single v. Double-walled Hives which is now receiving some attention from advocates *pro* and *con*. First, then, we personally refuse altogether to give countenance to or tolerate in any way attempts to ignore the British Standard frame, or alter its recognised measurement of $14 \times 8\frac{1}{2}$, with a top bar of seventeen inches. The benefits which have accrued to bee-keeping, to bee-keepers, and to hive-makers since its adoption by the B.B.K.A., are so clearly demonstrated to those best able to judge, that arguments on the point seem so much time

wasted. Indeed, the extreme jealousy with which many of our best men regarded any attempt to alter the measurements of the 'Standard' formed the main obstacle to our efforts in endeavouring to dissociate the brood frame from that intended exclusively for surplus honey-storing. Having, however, made clear the point that a dual frame would be an all-round advantage; moreover, having retained the exact measurements of the Standard *minus* three inches of its depth, the shallow frame is now accepted as advantageous for its special purpose by some of the most determined opponents of any interference with the dimensions of the former.

When stocks are being pushed forward in spring and syrup is being given, it is very essential to avoid having cells intended for brood filled up with more food than is actually required; in fact, when surplus chambers are set on, the frames in the brood nest below should be as nearly occupied wholly with brood as is possible, so that the lower chamber is exclusively devoted to its legitimate purpose of brood-raising, while the bees are perforce compelled to utilise the combs given them overhead for storing honey as gathered. To attain this end some attention is needed by way of scratching the surface of sealed food on the upper portion and sides of the frames, to induce egg-laying over as much of the comb surface as we can, and at the same time to get rid of any surplus sealed food, which renders comb so occupied useless for brood-raising. The time for stimulating is, as we have already said, best gauged by the date when natural pollen can be had outside, and this will serve as a safe guide for any locality, north or south.

Some advantageous stimulating may be done by *safe* hands at this time in weeding out faulty combs by removing such—one at a time and at intervals of a few days between each removal—and inserting a full sheet of foundation right in the centre of the brood nest. Eggs will be laid more rapidly this way than if ready-built combs are given, and so long as the operation is only performed when stocks are strong—covering, say, seven or more frames—no harm from brood-chilling will result. When honey begins to come in perceptible quantities, and bees indicate the 'comb-building impulse'—*i.e.*, when whitened edges appear on the combs, as seen between top bars—surplus chambers may be given, and in doing this it is worth noting what quality of honey is coming in. If from sycamores, or some other such inferior source, the bees may do a little comb-building while gathering it. Under such circumstances we therefore give frames with half-sheets of foundation; but if the finer qualities of nectar are within reach, full sheets of foundation or ready built combs should invariably be given. A good stock of these combs, from which brood and pollen has been rigidly excluded, is so much valuable plant, to be carefully preserved year after year, and kept ready for immediate use as required. Extra heavy combs may be secured

if preferred by using nine frames in the chamber made to hold ten, slips of wood half an inch in width, cut from broken sections, being inserted between the shoulders of the metal ends of each frame.

Queen-excluders are also indispensable in working for extracted honey. Even those who dispense with them below section racks are agreed on this point, so we need say nothing by way of enforcing it. Whether the excluder be a plain sheet of perforated zinc of the usual long-hole pattern laid flat on the top bars, or a honey-board in which the metal is framed, with bee-space below, be used, we care not, so long as the queen is confined to the hive body or nursery below. After setting on the surplus boxes, carefully exclude the air from outside by slipping short lengths of newspaper, folded to form a knife-edge at one side, between the junction of hive and upper chamber to keep all as warm as possible. As soon as required, additional boxes may be given—whether under or over the one already on we won't stop to argue, except to say we have always set them 'over No. 1,' mainly to save trouble, and we think that is some gain: besides, honey for extracting is best ripened on the hive, and the whiteness or otherwise of the capping is of no account in these cases.

EXTRACTING.—It can hardly be termed plagiarism to quote oneself, and having written in the *Record* on the subject of extracting a year or two ago, we may be pardoned for quoting portions of our article here. It was written in response to a correspondent who wrote as follows:—

'I am a comparative novice in bee-keeping, with plenty of enthusiasm, but with only three-years' experience of bees, and I have had so much trouble, coupled with unsatisfactory results in my efforts to get my bees to build sections, that I am resolved in future to change my plan and confine my bee-labours to what is called "working for extracted honey." I have this year used a few of the shallow frames, which I know you, Mr. Editor, to be a warm advocate of, and am much pleased with the results; but my extracting—chiefly, I believe, because of bad uncapping—is not a success. I therefore ask you if you could not, for the benefit of readers of the *Record*, including myself, give a short article on the method by which to obtain such beautiful extracted honey as that which won the prize in the County Competition at South Kensington in 1886? I heard at that exhibition that a good portion of the honey in question came from your own apiary, and though we do not all dwell in so favoured a county as Cheshire, we want to make the best of the honey available to us, and to learn how far the skill of the bee-keeper himself assists in bringing about the desired result.'

In reply, we observed that—first, and certainly foremost—the skill of the bee-keeper has no influence whatever on the quality of the honey gathered by his bees, except so far as the 'handling' of the product goes. The bees of

Giles, the labourer, kept, mayhap, in a half-rotten old straw skep, gather precisely the same nectar and visit the same flowers as do the squire's, there being neither aristocrats nor democrats among the community of *apis mellifica*. All that the 'art of bee-keeping' does is to help the bees to 'sort the stuff.' However, we willingly tell all we know on the subject; merely premising that any one intending to keep a dozen or more hives of bees, will find it true economy to provide himself with a fairly good set of implements wherewith to do the work.

Nothing so much aids us in this part of our bee-work as *good tools*. Ours consist of an extractor, holding four combs; a 'strainer and ripener,' the upper or movable portion of which is of sufficient capacity to hold five or six gallons of water, and will, of course, contain a great quantity of cappings, from which the honey is day and night gradually dripping through the sieve into the receptacle below. It seems incredible how the honey drains through; but it does in time, and so none is lost. Then we have a lamp 'knife-heater,' a couple of keen-edged old carving-knives, with blades about ten inches long, the points of which are curved inwards for about one and a half inches; a wooden 'tray,' with a raised edging half-inch high all round it, and near the left corner a couple of small pieces of wood nailed on so as to form an angle or rest, so—L—to keep the frame from slipping. Finally, we have a brown holland 'blouse,' which slips over and protects the clothes. A bowl of clean, cold water, for dipping the hands in, and a towel complete our 'kit.'

Thus equipped, and with the boxes of honey piled one above the other, we prepare to start. First, with a pencil, we consecutively number the combs in each box, so that they may be replaced in the same order as built by the bees—experience will show the wisdom of doing this.

Our correspondent has alluded to 'bad uncapping,' and we may say that *that* has a deal to do with the difficulty of extracting cleanly and rapidly. The annexed sketch shows the manner of holding the comb while uncapping. With a sharp knife just withdrawn from *hot water*, and a shallow comb held as in the sketch, the whole sheet of wax capping may, with a little practice, be removed at one cut, without bruising or breaking the cell walls in the least. This is an important point, because if the cells are damaged, the honey will not freely leave the comb as the cage of the extractor revolves.

The operator, grasping the 'lug' of the top bar firmly in his left hand, places the lower end in the 'rest,' a knife is lifted from the hot water, and, after touching the blade with the towel to remove the drip, he leans the frame forward so that the sheet of capping, as it is severed, hangs clear of the surface of the cells, as seen in the sketch. When cutting, do not give the knife too much of a 'sawing' motion, and endeavour to keep the blade just beneath the surface of the capping; when the top of the comb is reached,

the capping will adhere to the knife long enough to allow you to drop it smartly into the strainer close by your right hand, ready to receive it. Stroke both sides of the knife-blade on the edge of the strainer to remove the adhering honey, and replace it in the hot water. We never use the same knife for uncapping more than one side of the same comb. It takes far less time to do the job than to describe how it is done; but to do it well requires both care and practice. There must be no 'dragging' while the knife is passing upwards, or the cell walls will be all bruised in its passage, and, as before stated, the honey will not flow freely. As each comb is uncapped it is placed in the extractor, and when the four are inserted we at once start, using no care whatever as to speed, and giving no heed to the usual precaution against fracturing the combs by the too rapid revolution of the cage. Neither do we ever think of troubling to partly extract one side of heavy combs



Fig. 11.—Uncapping Combs.

and then reverse them, only to turn them again before completing the extracting, as is so often advised. These precautions *may* be necessary when working with Standard frames; with shallow frames no such care is needed. Our extractor has no cog-gearing; but we get up top speed at once, turning the handle as rapidly as possible, and then, after allowing the cage to go by itself until it slows down, the handle is again seized and turned as fast as it can be made to revolve. About two minutes suffice to extract one side of the combs, when they are reversed, and the operation is repeated till all the frames have been gone through. When the space below the cage is full of honey the extractor is raised up on a box high enough to allow an earthenware 'bread-mug' being placed below the valve tap. These mugs each hold about one hundred pounds of honey, and, when a piece of book muslin—not too fine—just wrung out of clean, cold water, is stretched over the mug, the tap can be so regulated as to run just as fast as the honey will strain

through; it, therefore, needs no watching. As the mugs are filled a clean cloth is tied over each; they are then labelled and set aside in a warm place ready for bottling off after extracting is completed. When this is done the cage is removed from the extractor, the cylinder being washed out to remove all wax chippings, and it becomes a vat for bottling purposes.

GRADING HONEY.—This is another important point, and one which no careful bee-man can afford to overlook. When setting on surplus boxes the date on which it is placed should be written on a card and tacked on it, so that a pretty safe guess may be made as to the quality of the honey each box dated alike contains, and quite a remarkable difference will be found in the value of the contents. By this simple plan the honey grades itself, and all that is needed is to select all the boxes of a given date when extracting, and keeping each lot separate for bottling off.

(We must reserve the subject of working for comb honey for another paper).

HONEY IMPORTS.

The total value of honey imported into the United Kingdom during the month of January, 1891, was 2557*l.*—W. PITTAR, *Statistical Officer, H.M. Customs.*

BEE RAMBLES IN SAVOY.

(Continued from page 88.)

M. Fredel is the registrar of the district, and rather than give up his country life and his bees he has declined a more lucrative appointment, since he was comfortably located and surrounded by his bees and a numerous family of live-stock, which lived on the best of terms with each other: several fine dogs, no end of cats, birds, and other animals, all on the most friendly footing, and all testified to the loveable nature of the host and hostess. Even a martin found a corner of the bedroom we occupied a sufficiently safe place to take its rest in during the night. With all these there was the greatest order, and when all met at the social meal the most brotherly feeling prevailed. Here a good deal of talk centred upon the use of honey in making wine, M. Fredel having been successful in his endeavours to make hydromel. We also tasted some excellent vinegar, produced in the most simple manner possible, which compared favourably with the best wine vinegar. Every one knows the difficulty nowadays of getting good vinegar, and commercial vinegar usually contains acids that attack the teeth and injure the stomach. As this would be a new way of advantageously utilising honey we will give the method pursued by M. Morel-Fredel. Procure a cask, which must be sweet and thoroughly clean. Then get from a vinegar factory, if you cannot get it any-

where else, some of the gelatinous scum which usually contains a ferment called *mycoderma aceti*. Wash this in cold water, and then rinse it in vinegar. Then dissolve honey in water that has been boiled, the proportions being one kilo. of honey to eight to ten litres of water, according to the strength required. When cool pour into the cask and put in the ferment. Care must be taken not to exceed the proportions of honey, as the vinegar would be too sweet, and if a smaller quantity were used it would be too weak. Place the cask in a moderate temperature—60 to 80 degrees Fahrenheit—and the acetic fermentation is developed rapidly. The bung-hole should not be closed tightly—a cloth laid over it or a piece of slate does very well—and the cask should not be more than three parts filled. Air is necessary for proper fermentation. In a very short time the vinegar is ready; in summer one month suffices. Now the work is practically at an end, for you have only to draw off some of the vinegar and replace it by an equal quantity of honey and water. It is not even necessary to use good honey for this, as the cappings, pieces of broken comb, &c., can have water added to them and this sweetened water can be used.

Of course, the strength will vary, but this is of little importance when it is for home consumption. If wanted for sale the proper proportions should be adhered to. It is better to begin making the vinegar in the summer on account of the temperature, and once the fermentation has started you can go on as long as you like. This is a simple recipe, and we hope some of our bee-keepers will make a trial of it. Our time at this hospitable residence was drawing to a close, and it was with much regret that we were obliged to leave Bonneville the next day, carrying away with us a most pleasant recollection of our visit. We have since heard that the honey harvest has quite come up to the expectations of M. Morel-Fredel.

About mid-day we started in a carriage to the Lake of Annecy, and, on the recommendation of our host, we decided to go by the Valley de Thônes. The valley is very unfrequented by strangers, but full of beautiful scenery—waterfalls, gorges, precipices, and views of mountains all along the route. Our route was high above the River Fier, and when we got towards the village of Thônes the valley was very broad, and in all directions, as far as the eye could reach, extended fields of esparcette in full bloom, relieved by an occasional stretch of blue—the wild sage. Pasturage everywhere, but where were the bees? None to be seen, except a few skeps here and there. At Thônes we had lunch and rested our horses, and then made another start. We soon got to the Customs boundary, situated rather far from the frontier; but this is explained by the fact that there is a certain belt of territory adjacent to Switzerland that is exempt from import duties.

As we proceeded on our journey we came in sight of the St. Bernard, and presently the charming little lake of Annecy, nestling low down in

the valley. Before long Menthon was reached, and here we saw the château, situated on the slopes of a recess. Here St. Bernard, the Apostle of the Alps, was born, and this fact, apart from its local beauty, could not but interest us.

Here the road turned to the left, and in front of us we saw Talloires, situated on the banks of the lake, with the Château Duingt prettily situated on a promontory extending far into the lake on the opposite shore. Talloires is the birthplace of Berthollet, the celebrated chemist. Our resting-place was the Abbaye, formerly a monastery, but now turned into an hotel. We were comfortable, but the place felt dismally lonely. It shows unmistakably its former use, for in the courtyard there were ruins of ancient carved work, and nooks and corners displaying old ecclesiastical architecture in the last stages of decay. After ascending a rambling old stone staircase, we reached an enormous hall, round which were the bedrooms, formerly the cells. There must have been forty or fifty doors, and as many round the gallery above. Altogether the place had a weird, ghostly appearance, and just such a place as one would fancy would be tenanted by such phantoms; however, they did not disturb our slumbers, nor did the old confessional-box, now turned into a wardrobe in our room, interfere with our rest. Next day we explored the neighbourhood, photographed the Château Duingt, and were not sorry to embark after lunch on the steamer on our way to Annecy.

(To be continued.)

DEVELOPMENT IN THE HONEY-BEE.

By R. A. H. GRIMSHAW.

(Continued from p. 53.)

If we desire to visit the honey-bee struggling under adverse conditions to maintain its place amongst us we must make a trip to the high moorlands of our islands, where the sheep-farmer on some hillside can just manage to get his bees through from autumn to spring with a yield of a swarm in July, and a straw super in October of honey such as is rarely tasted by people living in the valleys and towns. Here in winter a drifting snowstorm (hurled against the north-west wall, under which crouch the one or two skeps) has banked up the exposed side until all seems one level sheet—a winding-sheet to some things, a warm winter wrapping to others—of pure crystals just tinged with the pink glow of a reflected sky. On the sheltered side the snow-flakes have tipped lightly with the strong wind into the shelter of the wall, until skeps and stands, snuggled up with sheets of turf stripped from the closely cropped moor, and topped with thin slabs of stone borrowed from the high wall, are deep in a light layer of thoroughly dry snow, in which, as we know, animals of various kinds can hibernate successfully. Warm underneath this pervious blanket, which shelters life from death-dealing, piercing blasts of icy air, cutting like lancets into the very vitals of animals

exposed to their fury, rests snugly the German honey-bee, having forced itself forward and northward, and become adapted to most adverse climatic conditions. It has taken the rotting straw skep in hand, and covered the whole inner surface with propolis, so called, with the most resinous compound secreted and exuded by the plants of the district, has used its own wax to make up any deficit in the supply of gum, and to give a cheap bulkiness to the substance, thus making at least a weatherproof covering, which is eked out by the sods and slabs of the shepherd into a passable home, in which the honey-bee may safely pass the crucial trial-time, and prove by surviving its fitness to survive. It is surely idle to speak of the honey-bee as indigenous in a country such as this, where the written history, scratched deeply into the very rocks, tells of the slow passage over them of glaciers and icebergs weighing millions of tons, and bespeaking a surrounding temperature in which neither the bee can live nor the flowers on whose nectar it subsists. The whole surface of the land tells of an ancient submergence and a subsequent upheaval, on which only the scantiest vegetation can as yet live; so that such animals, birds, and insects as are there found to live and reproduce successfully their species must have invaded the land from other more or less suitable climes, and become little by little adapted to their new home; that is, such animals only as were able to withstand the changed conditions succeeded in living on from one season into another, the rest dying out as unfit. Thus, with the mountain-loving bee, ever searching upward and northward for the sheets of blossoming alpine plants, whose scented exhalations slowly sink down the hill-slopes in response to the mist-laden air-currents of the higher altitude, which in their turn descend laden with moisture on the sheltered mountain-side, watering the almost barren rock-earth, and thus affording conditions more suitable for the growth and spread of vegetable life than the naked storm-swept slopes exposed to the fury of the prevailing wind: thus does the bee find the mountain-side gradually lending itself by its own shape alone to the formation of a more and more fitting home for itself and the flowers on which it feeds.

It is almost an axiom amongst gardeners that if strong, hardy, and robust plants are desired, they should be sought to the northward of the garden into which they are to be imported. They have acquired an amount of vigour which makes their cultivation in the south much easier. They are able to brave more adverse climatic conditions than their kind obtained from warmer districts. Should not, then, the same rule apply to bees obtained from Scotland or the northern counties and imported into the south, where the strain is sometimes found to have become effete and worn out, liable to be attacked by enemies ever on the alert for the extermination of stocks unfitted to carry on the species? We find the moor-man's bees living on—just, and only just,

able to maintain their place under specially unsuitable surroundings. Winter ends in the south, rapid consumption of stores and breeding follow, with its wearing-out labour, whilst yet the northern bee continues its hibernation; but presently the hot slanting rays of the spring sun strike the snow-sheets, and, as if by magic, hill-sides are starred with blossoms, the mountain rills ripple down our heather-clad stretches, and roll on in increasing volume over sheets of spongy sphognum, through peaty sweeps on which the bilberry and crowberry have managed to secure a foothold, down rocky torrent gaps, where countless saxifrages and mosses are waiting for aid from above, past banks of minute flowering plants, to its end, the sea—if one may call any part of an ever-rolling cycle an end. The cackle of the disturbed moor-game, the delightfully welcome boom of the ubiquitous humble-bee, tell of a new year, and as we approach the homestead, the welcome sound in all nature to the bee-keeper greets his ear. The steady hum-tone about his hives gives him assurance that once again he is blest in his solitude with a society and companionship (next to wife and family) most welcome of all—more welcome in his lonely lot than even the faithful dog, the shepherd's trusty help.

As we descend with the mountain stream from the higher altitudes, where life of any kind is in a never-ending, hand-to-hand, life and death struggle with hard conditions of life, we reach the confines of moorland, and in such a spot, with either an eastern or southern slope, we find to my mind the very *beau ideal* of location for a bee-garden; for although our all necessary clover, both red and white, manages to live and flower in the Highlands in varying altitudes up to 2700 feet, yet its real use to the bee-keeper only appears when we descend to the lower pastures, and here he may avoid the inconveniences of having to move his hives to the heather, for from May to October the clover plant will be in bloom on the hillside fields, serving at least as food, after the June and July honey harvest is past, till the ling begins to blossom with the advent of August. Then come the downward air-currents from the heather-clad hills, fraught with the flavour-essence of the vast sheets of bloom; in quick response upward to the gathering-ground speeds the active nectar-sucker, with his empty honey-sac, light on its outward journey. Down again with its load on an easy homeward trip, enabling the bee-keeper to snatch a second harvest with only the trouble of taking the honey from the hives. Here disease amongst his bees is at a minimum; the pure air and change of diet offered by the higher feeding-ground give his bees a tone of robust health, well enabling them to resist the attacks of their all too numerous enemies, microscopic and otherwise. This vigour often takes the form of an inclination to sting anything that approaches the hive, an excess of the defensive instinct which we most erroneously term vice.

(To be continued.)

LECTURES ON BEE-KEEPING.

During the winter, the Rev. I. A. Kempe, M.A., Vicar of St. Veyan, Cornwall, has given a series of lectures in the St. Michael-Caerhays Reading-room on the subject of 'Bees and Bee-keeping.' The lectures have been illustrated by some remarkably good magic-lantern slides, many of them being taken from instantaneous photographs. Mr. Kempe also showed some good diagrams, and further illustrated his remarks by exhibiting a bar-framed hive with all its fittings, &c., also honey extractors, section cases, and all the appliances needed in the management of bees. The lecturer not only gave minute directions for the proper keeping of bees, with full instructions what to do and what to avoid doing at the different seasons of the year, but he also kindly explained to those present how to prepare the honey and wax for exhibition or market. A large and appreciative audience has attended at each of the lectures, and from signs already apparent, it is evident that bee-keeping in this little remote parish has had a great impetus given to it in consequence of Mr. Kempe's lectures. At the close of the last lecture, which was given on February 10th, the Rector of the parish (Rev. H. M. Crossing, M.A.) proposed a hearty vote of thanks to the lecturer, on behalf of the members of the Institute and the parishioners generally, for the great treat afforded to them by the course of lectures. This was seconded by Mr. E. Martin, Hon. Secretary to the Institute, and carried unanimously. As a result of the lectures, a considerable sum has been added to the funds of the Institute, for which the Treasurer and Committee are very grateful.

NOTTS BEE-KEEPERS' ASSOCIATION.

The annual meeting of the above Association was held at Nottingham on February 1st—the President, Lord St. Vincent, presiding. A large company, including the Mayor of Nottingham, assembled, among those present being many influential bee-keepers of the county, including several ladies.

According to the annual report, read by the Hon. Secretary, Mr. A. G. Pugh, the Notts B.K.A. continues to make progress, showing a net increase of forty-six members since 1889, the number last year being 167. The principal show of the year was that held in connexion with the Notts Agricultural Society at Wollaton Park. Minor shows have also been held in conjunction with the local horticultural societies at Beeston, Southwell, Sutton-in-Ashfield, Arnold, and Moorgreen, at all of which considerable interest was aroused.

The executive of the Association are making strenuous efforts to render bee-keeping popular, and are arranging to assist members with advice and help through the agency of certified experts, &c.

In responding to a vote of thanks, the Mayor expressed the pleasure it gave him to hear so

favourable a report of their position, and trusted Lord St. Vincent would honour them by presiding over their meetings for many years to come. For himself, he gladly accepted their invitation to become one of the Vice-Presidents, and hoped to be present at their next meeting.

After the meeting in the afternoon about 110 persons sat down to a substantial tea. Subsequently another meeting was held, Lord St. Vincent presiding. The following gentlemen were re-elected to act on the Committee:—Messrs. F. H. K. Fisher, M. Linley, S. W. Marriott, W. F. Newman, H. Price, A. Warner, and S. White; Messrs. A. Simpson, Rawson, sen., Baguley, Watts, J. E. Phillips, and Thompson were elected in the place of the retiring members; Mr. P. Scattergood was appointed Auditor; Mr. A. G. Pugh, Hon. Treasurer and Secretary; Mr. J. E. White, Assistant Secretary.

The Vice-Presidents, with the addition of the Mayor, were re-elected.

In the course of the evening Mr. John Howard, of Holme, Peterborough, gave an interesting lecture on bee-keeping, which was heartily appreciated.

Correspondence.

The Editors do not hold themselves responsible for the opinions expressed by correspondents. No notice will be taken of anonymous communications, and correspondents are requested to write on one side of the paper only, and give their real names and addresses, not necessarily for publication, but as a guarantee of good faith. Illustrations should be drawn on separate pieces of paper.

Communications relating to the literary department, reports of Associations, Shows, Meetings, Echoes, Queries, Books for Review, &c., must be addressed only to 'The Editors of the "British Bee Journal," 17 King William Street, Strand, London, W.C.' All business communications relating to Advertisements, &c., must be addressed to Mr. J. HECKLE, Kings Langley, Herts (see 1st page of Advertisements.)

* In order to facilitate reference, Correspondents, when speaking of any letter or query previously inserted, will oblige by mentioning the number of the letter, as well as the page on which it appears.

THIN SINGLE-WALLED HIVES.

[562.] I notice in last week's *B. J.* that 'East Glamorgan' (No. 557, p. 91) asks, 'How has Mr. Wood fared this winter?' I conclude he alludes to myself, so have pleasure in answering him. Out of twenty-five hives I have lost three very weak ones, and one particularly strong stock. The latter was lost through the entrance getting blocked with dead bees, which smothered the lot. I can't detect any other cause, and as I was from home, skating, every day during the storm, I neglected the precaution of clearing the entrances. The three weak stocks came back from the moors in very poor condition, with only about two seams of bees in each, but as I wanted increase I ran the risk of its being a mild winter and kept them. I did not find a tumblerful of dead bees in each. My other stocks are doing well, and in the early part of the week, when giving extra combs of honey to five of them, I found large patches of brood in all.

I quite agree with 'E. G.' (p. 92) when he

says that a hive with an outer case is not a single-walled hive in any sense whatever. I have noticed this before when reading the *Journal*, but did not trouble to argue the point.

What is the difference between an outer case which is slipped on and one that is nailed on? My hives are simply half-inch wood; the bees are confined to seven combs by two dummies which are of quarter-inch wood, which are open to the roof, which again is open to the outer air through the ends of the broad-shouldered frames. We had never more than four degrees below zero, but that was sufficient to test the hives.

A neighbour of mine has twelve stocks, five of them in single-walled hives, and he tells me he can't tell the difference between them and the double walls as regards strength. It is pretty clear to me that in a hard winter a very weak lot of bees will not pull through in a single-walled hive, but at the same time I do not think they would be much, if any, better off in double walls.—ARTHUR J. H. WOOD, *Bellwood, Ripon, February 20th.*

[We are as little inclined to 'argue the point' as is our correspondent, seeing that we have endeavoured to make quite clear our views as to single and double-walled hives, and if there is any vagueness in what we have said on the point, we will be glad to remove it. But is not our correspondent himself a little wanting in clearness when he—by inference—refers to 'four degrees below zero' (thirty-six degrees of frost!) as not a severe test, but 'sufficient'? We also confess to some difficulty in quite following the few words above in which he describes the hive he prefers and uses himself. If bees will stand thirty-six degrees of frost in such thin hives with no other protection than is described, and will 'build up' in spring as rapidly in them as in others, our correspondent will confer a real benefit on the craft by kindly exhibiting one of his hives at the coming Royal Show, which fortunately is held this year in his own county. He will then afford an opportunity for those who differ somewhat from himself an opportunity of inspecting the hive, and arriving at some conclusion as to its merits or otherwise.—EDS.]

BEE-KEEPERS' ASSOCIATION FOR SCOTLAND.

[563.] Since your remarks were published in the current number of the *B. B. J.*, I have had letters from bee-keepers in various parts of Scotland urging the formation of a new association. Mr. Bennett, who is most anxious to do all he can to help a new association, suggests that a meeting of members of the Caledonian Apian Society, and others interested in bee-keeping in Scotland, should be held in Glasgow about the end of March. I am arranging for this meeting, and due notice of the date will be given by advertisement in your columns. Meanwhile, it may interest some of your readers to know that I have arranged with the Highland Society that if a new Scottish Bee-keepers' Association is formed at any time between now and the date of the Highland Society's Show this summer at

Stirling, arrangements will be made that the Apiarian Exhibition shall be in the hands of the new Association.—THOS. D. GIBSON CARMICHAEL, *Chiefswood, Melrose, Feb. 21st, 1891.*

NOTES BY THE WAY.

[564.] *English v. Foreign Bees.*—In closing my note on the above subject (see *B. J.*, February 5th), I put the question, How many centuries would be required for a race of bees to deteriorate by such so-called in-and-in breeding? You see, sir, the sense of my query was dependent on the whole paragraph. I know that if we breed from consanguineous stock the progeny will deteriorate, but my argument is that in the insect world such a thing is practically out of the question. Who, I ask, can control the mating of bees any more than of wasps? and, although the wasp is hunted out and killed the whole year through, they manage to exist, and some seasons in such numbers as to be a nuisance to some trades. Do we find that the wasp requires any foreign blood introduced to keep up the vitality of the insect? In my humble opinion the wasp is as vigorous as it was a thousand years ago, and in like manner I believe the native race of bees in England to-day is as well adapted to fill its place in the economy of nature as they were when England formed part of the continent of Europe, and the brown or black (so-called) bees were one family in one great Vaterland. The following clipping from the *American Apiculturist* will give a good example of the strength of native character over foreign or imported races. Dr. C. C. Miller, one of the best authorities on bees and bee-keeping in America, writes thus on degenerate Italian bees: 'I have for years kept Italians, bringing in a fresh-imported queen every year or two. After keeping that up for a number of years I reasoned that, as there were very few other bees in the neighbourhood, the *Italian blood must predominate so much that if left to themselves my bees would soon weed out those one-banded fellows. Although I have had no blacks for years, I soon found that I had two or three colonies that were Simon-pure blacks, at least so far as colour was concerned. Now the question is, did my yellow bees turn black, or were the few surrounding blacks so powerful in character as to overcome them?*' (The italics are mine.)

This is conclusive evidence, from an authentic source, that unless one keeps up the constant introduction of foreign blood by fresh importations the characteristics of any foreign race is soon lost, or so covered by the predominating power of the native race as to be worthless, and is another illustration of the somewhat hackneyed term, 'The survival of the fittest.'

The radius must be large to secure in-and-in breeding in any one apiary. See the distance bees fly to all points of the compass: as an example, notice the long distance M. Morel-Fredel's bees went for the *astrantia honey*—eight kilomètres, nearly five English miles (*vide par. 3, p. 88 of B.B.J.*, 'Bee Rambles in Savoy'). This is enough

to show the absurdity of many of the circumscribed ideas relative to bees and their flights. Besides, the almost impossibility of keeping any race of bees pure shows conclusively the wide range of amorous drones, and the fact that there is, if not actual welcome, at least no repugnance shown to drones in hives other than their own homes may be a wise provision in nature to prevent that in-and-in breeding which seems such a scarecrow to the present generation of bee-keepers.

I beg to thank Mr. C. N. White for his outspoken letter, and to tender my sympathies in his loss over the late British and Irish Honey Company. I, too, wishing to help in the honey industry was inclined to invest in a few shares in the affair, but the earnest and prudent advice of my good wife fortunately restrained me from investing my hard-earned money in what proved to be—the glowing prospectus notwithstanding—a bubble company.

Mrs. L. Harrison has scored a point in the *Prairie Farmer*, re the Wiley Lie about manufactured comb honey. Mrs. Harrison says: 'Now is the time for the manufacturers of such to fire up their factories, and run them night and day, for there is very little comb honey to be had at any price, and what little there is on the market is retailing at 25 cents per section. The scarcity of comb honey at a time when it commands such a high price is evidence of the truth of the statement that comb honey *never has been and never will be manufactured.*'—W. WOODLEY, *World's End, Newbury.*

SPRING REPORT.

[565.] I am pleased to be able to report all stocks—thirteen—safely through the winter so far. From a cursory examination, they seem to have consumed very little of their stores and suffered scarcely at all from the severe weather, for small patches of brood can already be seen in the centre frames. On Sunday, the 15th, a beautiful day, and again to-day, I saw several carrying in pollen, probably from my early snowdrops and crocus, winter aconites, and possibly hazel catkins. My strongest stock is one that worked itself up from a mere handful of bees last spring. I notice they still have some Cyprian blood in their veins. The queen is the great-granddaughter of a Cyprian queen I had from Mr. Simmins. I do not mean to hint that this is the reason of their strength, for I believe—and I say it after trying most of the other species, or varieties, whichever they may be—that our native bee cannot be beaten for this climate. The strongest stock I have ever seen were pure natives, and were located in an eighteen-inch Pettigrew skep, with an immense bell-glass, fast being filled, on the top. It was one amongst many hives in the garden of an enthusiastic old gentleman at Knutsford, in Cheshire, eight years ago, and I shall never forget seeing them at work.—H. J. SANDS, *Harborne, near Birmingham.*

QUEEN-REARING.

[566.] I am much obliged to Mr. Woodley for his information (361, page 94). At present I have only nine stocks, but mean to increase to a good number—say, fifty—with time and experience. What I am anxious to know is, with how many stocks ought I to start queen-rearing, the increase being made partly by natural early swarms, partly by artificial swarming, and partly by gift and purchase? I should be very glad to know this. In clearing supers, I now always take off my supers (sectional only) by means of Webster's super-clearer, and a simplification of it of my own.—E. M., *Harleston*.

[If you propose to go in for so large an increase it would be well to read a short treatise on queen-rearing.—Eds.]

A FEW HINTS ON FIXING UP BEES IN WINTER, ETC.

[567.] I am rather surprised at 'Friend Woodley' saying on p. 55 it was *too late* to shift a colony of bees from that makeshift hive, and hence their death. Is he not aware that bees can be handled in a warm room at night with a *good paraffin lamp*? I say good because it requires one with a reflector so arranged as to throw a good light direct on the hive to be manipulated. Those who have not tried it will be surprised at the ease with which bees can be handled this way, even when it is freezing out of doors. I have found that they can be handled in this way with almost no stings, and scarcely any loss of life: they seem to have no inclination either to sting or fly. During the last nine years I have packed some scores of colonies in this way for shipment to all parts of the globe, and it generally had to be done in very late autumn or in winter, in order that the bees might arrive at their destination in their spring or early summer. I say nothing here about the method employed in packing, except that I had only two complaints during the whole time; one when some one on board did a little manipulating on his own account, and after prizing open the packing case helped himself to the good things placed there for the bees to feed on during the journey. The other was by the official on board who takes charge of the live stock, &c., placing the bees in the *ice-house* instead of 'a moderately cool place,' as instructed. I don't wonder they went wrong!

To give another instance of handling bees during frost and snow. In December of 1879 I took several stocks of bees on the G.E.R. Company's line to a place in Essex, and finding one lot (a late swarm with natural combs) broken down at the end of the journey, I could not let things remain so, so with permission of my mother-in-law I got the use of a kitchen close to for a short time, and by the use of tapes and laths I soon put them all right. That stock went through the winter safely, and gave off two swarms, besides a fair amount of honey. These cases go to prove that, with a warm, dark

room and a good lamp, there is no reason why an experienced bee-keeper should not be able to do anything required to be done in this way.

Just another hint. I would advise those who find stocks in a state of starvation not to trust entirely to candy-feeding at this time of the year, but give each starving lot a bottle of hot thick syrup, made with six and a half pounds of sugar to a quart of water, with two wine-glassfuls of vinegar. Select a mild day and put on feeder, and cover warmly to maintain the heat of the syrup; give about a quart of food this way, then a cake of soft candy will make the stock safe enough. All other things are right. I argue thus because when bees are allowed to run down so low they have no heart to leave the cluster to go for the candy.

A good many seem puzzled to know what to do with unfinished sections, but I always consider there is money in them if they are used the right way. Some advise putting them through the extractor; I say, 'Don't!' it only messes the wood of the section with honey and discolours them, making them not fit to use the next season.

Most bee-keepers have in the early autumn a few stocks that are very short of food; let them give the unfinished sections to those stocks wanting food; it saves buying sugar and the need for writing to the Eds. to know what to do with the unripe honey. The bees will take it down sharp, if given in the latter part of August or early September. Place them in double-layer crates, on their sides, one above the other, and they will soon be emptied clean and dry. If stowed away safe from dust, mice, and wax-moth, with a lump of camphor in each crate, they will be quite safe till again wanted. Now, here comes my 'wrinkle.' We read both in *American* and *British Bee Journals* that many are against using combed sections on account of bees not working them out so well as they do new foundation. But if, either now or some time soon, while the wax is *still brittle*, we take each section and with a piece of tin or glass scrape off the surface of the comb to within about three-eighths of an inch of the midrib—that is, leaving about three-eighths of the cell walls standing—it will be a surprise to many to see the results as regards appearance and the way the bees fill and seal them up. I, myself, would not mind if I had enough of them for the coming season instead of using new foundation. At the early part of the season the bees take to them quicker, they fill them quite as well, and seal them splendidly. The idea is to do away with the hard top-surface of the cells, often discoloured and sometimes covered with propolis. When treated as described, the cell walls are pure white, thin as natural comb, and three-eighths or half an inch deep, which we all know is a great inducement for the bees to fill when honey starts coming in fast. This is not theory, but practice. I have done the same for two seasons with good results.—WALTER MARSHALL (*late Manager of Geo. Neighbour & Sons' apiary and bee-farm*).

Queries and Replies.

[319.] *Bee Appliances.*—I commenced bee-keeping last year, buying a straw skep in May, and from it I had a swarm in the same month, from which latter I got some forty pounds of honey, exclusive of their winter supply. I bought a quantity of bees in skeps from farmers about here from which I took the honey, putting the bees into bar-frame hives, three to five lots together according to size, so as to cover at least eight frames as full as they could hold. I extracted the honey, filled the frames with the empty combs, and fed up each lot with about twenty pounds of good syrup, and packed them for the winter. Over the woollen quilt I put four or five newspapers folded so as to cover every crevice, and left them to their fate. Having nothing but artificial food, and I being so inexperienced, I scarcely expected all would survive, especially as I was much too late in driving the bees. However, I am very pleased to say the bright weather of late has encouraged them out, and the whole eleven hives appear very strong indeed. I wish to know:—1. What spare appliances I should lay in to commence this season with in working for extracted honey only? 2. May I expect a swarm from each hive, and after that should I return each succeeding swarm to its hive? A difficulty I anticipate about this is the securing of queens. Although I drove some thirty to forty skeps last year, I only caught sight of one or two queens, though looking for them with care. 3. Should I not return the queens; may the swarms be still returned to the hive again? 4. With a number of skeps, if a swarm comes off unseen, how shall I tell from which hive it came? 5. Is there any limit to the size of hives? If one could adopt a monster hive, such as I see are usual on the Continent, the labour of watching and handling might be reduced, perhaps. How near can we with profit approach the bees in what I may call a state of nature, as when they got into the roof of a house, where they have ample room, and may increase *ad lib.* for years? After I read about the flour dodge in your *Journal* I tried it with several lots of driven bees, and never observed any ill effect. It saved me much trouble in uniting.—STILL AN APPRENTICE.

REPLY.—1. For extra hives all depends on your views as to increase, and the same with surplus chambers. Get a dozen of the latter to be going on with, and arrange for more at short notice if required. 2. Yes. 3. Not until you have had more experience. 4. By noticing the deserted aspect of the entrance, and turning up the skeps if necessary. 5. Opinions vary on this point. *We* say stick to a hive of ten standard frames.

[320.] *Cutting down Combs.*—I have frame hives with bars $18 \times 9\frac{1}{2}$, and have seven hives with bars Association size, $14 \times 8\frac{1}{2}$. 1. Will you advise me as to the best time to take bars out and cut them down to $14 \times 8\frac{1}{2}$? In July

last I drove two stocks of bees and put them in a bar-frame hive with foundation, and fed them up fully, but when I opened the hive a day or so ago I found the bees dead, with plenty of food, and the combs a little stained and mildewed. 2. Do you think the honey good enough to divide among the other bees?—E. B., *Witchester.*

REPLY.—1. The operation you propose to undertake is by no means an easy one unless you have had some experience, and a lot of damage may be done to hatching brood by unskilful hands. Don't attempt to cut down the old frames to standard size. Use new standard frames, and transfer the brood, &c., into them by cutting the combs to fit the frames closely on all sides, and tying them firmly in with tapes until the bees have made all secure. Transfer indoors in a warm room, and be careful not to damage the face of capped brood. Defer the operation till weather is warm and settled. 2. Yes.

Echoes from the Hives.

Honey Cott, Weston, Leamington, February 21st, 1891.—After overhauling my bees, am glad to say I have not lost all the bees in any one stock, though in one case it was a near shave. I dusted the few remaining bees with flour, and united them to a driven lot of bees, to which they united very peaceably. A curious thing in this case was that the bees should be all dead at the end of the frame, or from a third to half-way along it, having consumed all their food, while along the remainder of the frame there was plenty of food sealed, thus showing that through the extreme cold they could not even follow up to their food. Three or four more stocks have lost more bees than I like, but on the whole I am well satisfied with the result. The frost continued so long and so severe, I could not help thinking of my poor bees. What fine sunny weather we have had for a few days, and how the bees have enjoyed themselves outside! In 'Notices to Correspondents' our Editor says he does not know what is meant by 'spring beans.' Round here autumn-sown beans are called winter beans, whereas those planted in February and March are called spring beans. I have given all stocks a good large cake of soft candy—in some instances they have had two or three. If I found it getting nearly all eaten up I have torn a hole in the paper at the top and set another cake upon it. In one or two instances I found the bees had built a bit of comb up from the feed-hole. I felt rather tempted to give pea-flour during the past few sunny days, but have not done so, as we are having it very cold again.—JOHN WALTON.

Llanfairfechan, North Wales, February 22nd.—The weather during the past week has been most beautiful. To-day is summer-like, with calm air and cloudless sky, and the shaded thermometer is standing at sixty-three degrees.

The bees, taking advantage of such an exceptional day, are busy on the crocuses, yellow jessamine, and white alyssum. Pollen is being carried in vigorously, and the water is visited in a business-like way. I have three stocks which have come through the winter very satisfactorily—one consisting of condemned bees, the others my stocks of last year, which then yielded ninety-five pounds of honey. Seventy-six pounds in the comb sold for *3l. 8s. 0d.*—C. M. E.

St. Bees, Cumberland, February 20th.—I have examined my five stocks of bees—all in single-walled hives—and I must say they have turned out well and strong. A good many hives have gone down in the neighbourhood for want of a few pounds of sugar. Can a bee-keeper persist in keeping tenantless hives containing comb standing in his garden after being told to remove them?—[Yes.—ED.]—ISAAC MOSSOP.

Notices to Correspondents and Inquirers.

Letters or queries asking for addresses of manufacturers or correspondents, or where appliances can be purchased, or replies giving such information, can only be inserted as advertisements. The space devoted to letters, queries, and replies, is meant for the general good of bee-keepers, and not for advertisements. We wish our Correspondents to bear in mind that, as it is necessary for us to go to press in advance of the date of issue, queries cannot always be replied to in the issue immediately following the receipt of their communication.

All queries forwarded will be attended to, and those only of personal interest will be answered in this column.

A HALLAMSHIRE BEE-KEEPER.—The writer of No. 500, p. 93, being a director and shareholder in the Company referred to, and having had his name printed as such, was perfectly justified in making his position clear before the public, but we fail to see what right outsiders claim to have their curiosity gratified by calling on him to explain more fully the why and wherefore of all his actions connected with the Company. We quite believe in Mr. White's *bonâ fides*, and sympathise with him in the loss he has sustained through his misplaced confidence in the Company.

R. W. L. (Cornwall).—No trace of foul brood in the two bits of comb sent. The stock has doubtless become queenless after swarming, and so bees have dwindled away after being robbed of their honey.

AUGUSTUS (Renfrewshire).—The materials sent are admirable for quilting purposes, &c. Our only objection is they are *too good*—*i.e.*, too costly.

T. JAMES.—The honey sent is a bad sample of unripe and fermented honey. It is not fit food for bees.

THOS. WILLIS (Sunderland).—The 'sample of dead bees' on comb sent have died through cold and hunger. There is no trace of foul brood. Possibly they are a seam of bees which by some chance have become separated from the main body and been unable to reach the food. (You don't say if *all* the bees in the hive are dead.)

N. (Stirling).—Comb sent contains nothing but good honey. The brown capping is the natural result of the bees covering—or capping—the cells with wax from the old material of which the comb consists.

B. J. (Woodchurch).—The honey sent is very fair in quality. The dark colour is owing to the source from whence it was obtained. Honey always sets hard when granulated. The grain is not 'large.'

C. STANLEY.—1. Either of the sugars named are suitable for bee-food. 2. There is really nothing to choose between the two makes of sections named. 3. The W. B. C. hive is storified (not doubled) by adding shallow chambers with frames for extracting.

A COTTAGER.—The candy must be faulty in make, and is so granulated as to be unfit for feeding purposes. Bee-candy should be quite soft.

CONTRACTOR.—Candidates for third-class Experts' Certificates should notify the Secretary of the nearest County Association of their intention to present themselves for examination, and the necessary papers containing the information our correspondent requires will be forwarded by the Secretary of the B. B. K. A. Mr. J. Huckle, Kings Langley, Herts.

ALEXR. STRATHDEN (Ballindalloch).—Allow the bees to gather what natural pollen they can gather outside, but do not give all the pea-flour they will take so early as this. The colour of the pollen pellets depends entirely on the source from whence it is got.

HUGH F. KRISKE (Donaghadee, Co. Down).—The weak colony is suffering mainly from paucity of numbers and consequent want of warmth, hence their listlessness, &c. Matter marked 'A' is old pollen. Bees were smashed beyond recognition when received.

T. G. FORSYTH (The Hohae, Esholt).—*Unseeded Honey in Combs.*—If you find the queen cramped for egg-space a month or six weeks hence, a comb or two may be put through the extractor, but we fancy it will not be needed.

G. B. (Craven Terrace).—1. Hard candy, twelve months old, is almost useless to bees as candy. It may be used in syrup-making. 2. The coverings should remain on until supering-time.

ERRATA.—In our last number, p. 88, line 26 from top of first column, for 'works' read 'rocks,' and for 'Bregon' read 'Berzon.' Also, we are requested by Mr. C. N. White to correct an error made by him in No. 590 (p. 93). In the last paragraph the word 'debentures' should read 'ordinary shares.'

* * Several letters, &c., are unavoidably held over till next week.

NOTICE.—We request our correspondents in future to address all communications relating to the literary department, &c., to 'The Editors of the "BRITISH BEE JOURNAL," 17 King William Street, Strand, London, W.C.'

FOR SALE,

AS A GOING CONCERN,

One of the Largest and Oldest Established

Bee-Appliance Businesses

IN THE KINGDOM.

THE STEAM FACTORY is fitted up in the most perfect style with IMPROVED and LABOUR-SAVING MACHINERY.

The Premises are large and convenient, a good RESIDENCE is close by, and a long Lease of the whole can be had at a very moderate Rent.

A Large BEE-FARM or APIARY is connected with the Business, and the locality is a good one for Honey.

About £3000 will be required for the Purchase of the Stock and Plant. The value of the Goodwill may be arranged entirely on the results of a year's trading by the Purchaser.

APPLY TO 'MANUFACTURER,'

Care of *British Bee Journal* Office, 17 King William Street, Strand, London.

NAPHTHOL BETA.

AS we find that some of our Subscribers are not able to procure the right sort of NAPHTHOL BETA, we shall be pleased to supply any who are not able to obtain it through the usual sources, at 1s. a packet, post free. The packet contains an ounce, and is sufficient to medicate 145 lbs. of sugar. Printed instructions accompany each packet. *British Bee Journal* Office, 17 King William Street, Strand, London.

BEE-KEEPING FOR PROFIT.

By DR. TINKER.

WE have received a supply of these Books, and can forward them free by post on receipt of 1s. 2d. *British Bee Journal* Office, 17 King William Street, Strand, London.

To Lecturers, Schoolmasters, &c.

THE Committee of the British Bee-keepers' Association have resolved to reduce the price of the remaining stocks of their Coloured Diagrams to half rates.

PRICES WITH KEY.—Members of the Association, 2s. 6d. per Set. Non-Members, 4s. Postage 3d.

Pamphlet on the Management of Bees in Straw Skeps in Welsh and English, 6d. per dozen.

NEW EDITION of 'MODERN BEE-KEEPING' now Ready, price 6d.; postage 1d.

Address J. HUCKLE, KINGS LANGLEY, HERTS.

THE DEPOSIT SYSTEM.**British Bee Journal and Bee-keepers' Record.**

OFFICE: KINGS LANGLEY, HERTS; AND
17 KING WILLIAM STREET, STRAND, LONDON, W.C.

The following are the Rules under which we are prepared to receive Sums of Money on Deposit from persons buying and selling goods.

In order to save trouble it is requested that the Rules be carefully read over by persons using the Deposit System of trading.

DEPOSITING.

1. Method.—When strangers are dealing together, the purchase-money of the articles is deposited at our office. We acknowledge receipt of the deposit to both parties, and hold the money until we are satisfied that the purchase is concluded. If a sale be effected, we remit to the seller the amount deposited, less a charge of 6d. and the expenses of Post Office Orders and postage, &c. Cash will be forwarded by cheque, Post Office Order, or by Postal Order as preferred. If a sale or exchange be not completed, we return the amount deposited, after making the same deduction. By this means buyers and sellers are secured from fraud.

2. Deposits.—Postal Orders (drawn on General Post Office) and Cheques must be made payable to John Huckle, and crossed 'Bucks and Oxon Bank.' The numbers of the Postal Orders should be kept by the sender. We cannot be responsible for any losses that may occur in transit.

3. Honey on Approval.—All honey will be sold by sample, which must be sent direct to buyer.

4. Bee-appliances.—In ordering, the time allowed for completing the order to be stated to us when sending cash. If maker accepts, we hold cash till transaction is satisfactorily completed, when the amount will be remitted subject to conditions as in Clause 1.

5. Bees and Queens.—These will be dealt with entirely by the parties concerned, so far as price, &c., goes, and when the purchase is satisfactorily completed cash will be remitted as per Clause 1.

6. Goods in Transit.—These are at the seller's risk, i.e., any damage to or loss of an article on its journey is borne by the vendor; but a rejected article must be properly packed and returned by the same means as was used in sending it.

7. Carriage.—The carriage of all goods, *except such as are sent by post*, is payable by the buyer, unless otherwise agreed. If any article sent on approval be returned, each party to the transaction must pay carriage one way.

PUBLICATIONS OF THE**British Bee-keepers' Association.**

FOUL BROOD AND ITS CURE. By Frank R. Cheshire. Price 2½d., post free.

THE ADULTERATION OF HONEY. By Otto Hehner, Analyst to the British Bee-keepers' Association. Price 2½d., post free.

DIAGRAMS ILLUSTRATING BEE-CULTURE and the Relation of Bees to Flowers. Drawn by FRANK R. CHESHIRE, F.R.M.S. Approved and recommended by the Science and Art Department. 4s. per set.

THE MANAGEMENT OF STRAW SKEPS. Designed to teach the Cottager how to obtain the best results at the least possible cost. Price 1d. Ditto in Welsh, 1d.

J. HUCKLE, Kings Langley, Herts.

THE
British Bee Journal,
BEE-KEEPERS' RECORD AND ADVISER.

No. 454. Vol. XIX. N.S. 62.]

MARCH 5, 1891.

[Published Weekly.]

Editorial, Notices, &c.

USEFUL HINTS.

WEATHER.—Warm days, alternated with fog and frost at nights, to be again succeeded by warmth, this time accompanied by a foretaste of 'the ides of March,' in the shape of a biting bit of east wind—is our weather report for the last two weeks. Bees have been abroad a good deal on the several warm days, and pollen seems to be fairly plentiful in many places. There are few bee-keepers who cannot now count up the number of stocks on which their work for the coming season must depend, seeing that all the doubling or uniting likely to be needed may now be fairly calculated and queenlessness will have been generally discovered, so that queenless lots of bees will not be counted on save for helping weak stocks.

The curious personal experiences of the weather which fall to the lot of the dweller outside the metropolis are indeed a 'caution.' We leave home—only thirteen miles away from Charing Cross—amidst bright sunshine, the fresh air of the country, quite June-like in its warmth, birds singing and bees humming the while. The train whisks us off, and forty-five minutes or so later we find ourselves groping along in more than semi-darkness—dropped down, as it were, from sunny morning into foggy night in a few minutes. How it makes the bee-man long to be where the bees are at such times!

SPRING WORK.—We must impress upon our readers the fact that, except in very early districts, there is no hurry yet for beginning work in earnest. It may be well to assist stocks with artificial pollen where the natural article is scarce, but it is usually found that Nature provides in her own way for the bees' requirements; and when stocks are forward by reason of the

location, the willows, hazels, and all the early pollen-producing blossoms are forward too, yielding abundance of nitrogenous food for the developing brood. After seeing that risks of starvation are guarded against, active spring work may be still left over for a fortnight or three weeks. Then will be the time to begin the race in earnest, and give opportunity for each and all of us to indulge in our own special 'fancies,' or 'fads,' or whatever they may be termed, in building up by 'coddling,' or by 'letting alone;' by practising dodges to keep the brood nest extra warm; or by showing our contempt for 'dodges' of any kind, by letting the bees severely alone, to build up all the more rapidly for being untouched. But, so long as we only keep from quarrelling among ourselves as to who knows most, or whose plan is best, we may each 'go on his own way,' and the writer of 'Useful Hints' cordially wishes good luck and a big honey harvest to one and all, whether they follow his lead or criticise adversely the methods he advises.

If readers of the *Bee Journal* will but bear in mind the difference, or draw the line of demarcation between the official column, *i.e.*, the department where editorial *responsibility* comes in, and the very interesting and useful one headed by the intimation that no one is responsible for the opinions expressed therein save the writers themselves, we shall be pleased to give every bee-keeping reader a fair field for the expression of individual opinion, merely reserving to ourselves the right to steer the craft straight by means of an editorial footnote.

We lay claim to no knowledge of bees beyond that possessed by many readers, but the very fact that we are glad to be the recipients of the confidence of bee-keepers by thousands ought, and we sincerely hope *does*, add some little to the weight of our views, by the very wideness of the experience gained in this way.

(*Reminder of 'Hints' will appear next week.*)

BRITISH BEE-KEEPERS' ASSOCIATION.

The annual general meeting was held on Tuesday, February 24th, at 3.30 p.m., in the boardroom of the Royal Society for the Prevention of Cruelty to Animals. Owing to illness, the President (Baroness Burdett-Coutts) was unfortunately prevented from attending. Mr. Cowan, the Chairman of the Committee, was also absent owing to indisposition. The chair was taken by the Rev. F. T. Scott, who was supported by Captain Campbell, the Rev. Dr. Bartrum, Mr. Garratt, Mr. Lyon, Mr. McClure, Mr. Grimshaw, the Rev. E. Burkitt, Mr. Hooker, Mr. Andrews, Mr. Meggy, the Rev. Mr. Carter, and Mr. W. R. Fox.

The minutes of the last annual general meeting were read by the Secretary, upon which Mr. Hooker called attention to Rule 3—of the Conditions of Affiliation of County Associations—stating that he considered the wording of the same somewhat ambiguous. A discussion ensued, in which Mr. McClure, Mr. Garratt, the Chairman, Mr. Grimshaw, and Mr. Hooker joined, when it was agreed that further consideration of the matter should be postponed until some practical difficulty arose in the application of the rule, Mr. Hooker being satisfied with the expression of opinion that had taken place. The minutes were then signed by the Chairman.

The Chairman moved, 'That the report and balance-sheet issued for the year 1890 be received and adopted, with a vote of thanks to Mr. Kirchner, the auditor.' He thought Mr. Kirchner well deserved that compliment.

Mr. McClure seconded the motion, which was carried unanimously.

Mr. Lyon proposed a vote of thanks to the retiring officers and Committee, who had worked sedulously during the past year for the best interests of the Association. The important results that had been achieved as regarded the reduced railway rates for the carriage of honey spoke well for the energy displayed by the Committee.

Mr. W. R. Fox seconded the resolution, which was carried unanimously.

The Rev. Dr. Bartrum moved a vote of thanks to the Council of the Royal Society for the Prevention of Cruelty to Animals for the gratuitous use of their boardroom for committee and other meetings. He felt the Committee were deeply indebted to the R.S.P.C.A., to which they could make but small return for the advantages enjoyed by the Association. Through the kindness of that body, they had the benefit of a central place of meeting, an admirable room, and the greatest courtesy from the officials; and that, with the valuable help and advice of the Lady Burdett-Coutts (whose absence he much regretted) was a great boon to the Institution. He trusted the cause which prevented the President from being among them was only a temporary one.

Mr. Garratt seconded the motion, which was passed with unanimity.

Mr. McClure moved the re-election of the

President, Vice-Presidents, Treasurer, Auditor, Analyst, Librarian, and Secretary for the year 1891, in accordance with Rule 9. No words of his were necessary to recommend the resolution, as he felt sure every member of the Association would acknowledge that the Baroness was a good friend to the cause, and that all the officers, from the highest to the lowest, were assiduous in their attention to the interests of the Association. He could speak from personal experience of the Secretary's devotion to his duties.

Captain Campbell seconded the motion, which was carried unanimously.

With regard to item No. 6 on the agenda, the Secretary stated that the nominations for the Committee during 1891 had been the same as for the previous year, but that some of such members were unable to serve. Captain Bush was in a bad state of health, and therefore could not undertake to act on the Committee. The Rev. J. L. Seager had written to say that increased work compelled him to decline appointment on the Committee. Mr. Hasluck had stated that he could not serve again, as he could not give the time to committee work. The Hon. Mr. Bligh had been absent abroad for some time owing to ill-health, his exact address being unknown; therefore his nomination form had not been signed. Thus, there were four vacancies on the Committee. The Chairman, who, unfortunately, could not be present owing to illness, had written a letter to the Committee suggesting that Mr. Bligh would probably act as usual, the delay in returning the nomination form being due, no doubt, solely to circumstances connected with that gentleman's absence in Egypt; also that the remaining vacancies might be filled up by the Committee, as prescribed in Rule 8, the annual meeting giving the Committee authority to such effect.

Mr. Garratt submitted that under the peculiar circumstances in which Mr. Bligh was placed, whereby he was prevented from complying with the rules of the Association, the meeting should waive the non-fulfilment of the particular condition referring to nomination-papers, and taking into account the valuable services rendered to the Association by Mr. Bligh, consider him as duly elected a member of the Committee.

As these remarks seemed to represent the general opinion of members present, Mr. Garratt moved a resolution in accordance therewith, which was seconded by the Rev. Dr. Bartrum (who spoke in high terms of Mr. Bligh's modest, but none the less practical and thorough, devotion to apiculture and the interests of the Association), and carried unanimously.

A lengthy discussion followed regarding the appointment of committeemen to the three remaining vacancies. The Rev. Dr. Bartrum, Mr. Garratt, Mr. Hooker, Mr. Grimshaw, Mr. McClure, and the Chairman, thought it unnecessary that the vacancies should be filled up; while Mr. Meggy, the Rev. Mr. Carter, Mr. Andrews, and Mr. Lyon counselled a strict adherence to Rule 7, which stipulated that the

Committee should consist of fifteen members. After Mr. Grimshaw had pointed out that the rule in question would be fully complied with, owing to the fact that Rule 3—of the Conditions and Privileges of Affiliation of County Associations—provided under certain conditions that county representatives should be *ex-officio* members of the General Committee, by which means the latter body would always consist of at least fifteen members, it was unanimously agreed that the matter should be allowed to drop.

The Chairman read a letter just received from the Baroness Burdett-Coutts, in which the President expressed great regret at her enforced absence from the meeting.

On the motion of Mr. McClure, seconded by the Rev. Dr. Bartrum, a vote of thanks was passed to the Chairman, who briefly acknowledged the same, and spoke of the splendid condition of his stocks of bees, notwithstanding the severity of the past winter.

This concluded the ordinary business of the annual meeting.

CONVERSAZIONE.

At 5.30 the proceedings commenced, when Mr. Jonas was voted to the chair, and among the company present were the Rev. Mr. Scott, Mr. Garratt, Captain Campbell, Mr. Grimshaw, Mr. Blow, Mr. Andrews, Mr. Hooker, Mr. Meggy, Mr. Lyon, the Rev. Mr. Bancks, Mr. Leadbitter, Mr. Harrison, Mr. Carbonell, Mr. New, Mr. Grimwade, Mr. Welham, and others.

The Chairman, after a few introductory remarks, called on Mr. Grimshaw to read a paper he had prepared, entitled 'Bees and Odours.'

Mr. Grimshaw, after expressing pleasure at seeing some excellent diagrams prepared and brought to the meeting by Mr. Andrews, which, as it happened, would assist him in illustrating some of the points referred to in his paper, said he hoped the meeting would not regard his remarks as dogmatic expressions of opinion, but rather as notes upon which a useful, and he hoped, instructive discussion might be founded.

Mr. Grimshaw then proceeded with the reading of his paper, the full text of which will appear next week.

MIDDLESEX BEE-KEEPERS' ASSOCIATION.

The annual general meeting was held in the Boardroom of the R. S. P. C. A., 105 Jermyn Street, on Tuesday, the 17th of February,—Mr. W. H. Harris in the chair.

Much regret was felt when the acting General Secretary announced that the President of the Association, the Baroness Burdett-Coutts, was prevented from presiding owing to indisposition, but had written expressing disappointment at her enforced absence.

Letters of regret for non-attendance were also read from Mr. T. W. Cowan, Dr. Rayner, and Mr. Hasluck.

The report was presented by the acting

General Secretary, Major Fair, for the Hon. and Rev. H. Bligh, who was absent in Italy for the benefit of his health.

The Treasurer, Mr. Jonas, presented the balance-sheet, which showed a balance in hand of 11*l.* 2*s.* 2*d.*, which was considered satisfactory.

From reports sent in from the various districts into which the county is divided, it appears that the honey harvest for 1890 was below the average quantity, but that the quality was exceptionally good. The Expert, Mr. Baldwin, made two tours of the county; one in the spring and the other in autumn. His report is satisfactory as to the progress of apiculture in Middlesex, especially as to the diminution of 'foul brood' in several districts.

The Baroness Burdett-Coutts was re-elected President. Mr. T. W. Cowan was elected a Vice-President, and also re-elected on the Committee. The Hon. and Rev. H. Bligh was re-elected Honorary Secretary. Mr. T. E. Way was elected Auditor in the room of Mr. A. Kenworthy, who had sent in his resignation on proceeding abroad. Dr. Rayner was re-elected county representative and *ex-officio* member of British Bee-keepers' Association Committee. Major Fair was also elected a county representative, *vice* Mr. English, resigned. Mr. Baldwin was re-elected Expert. The Provincial and District Secretaries and Committee-men were also re-elected.

The proceedings terminated with the reading of the names of winners in the annual drawing of prizes.

BEE RAMBLES IN SAVOY.

(Continued from page 101.)

We arrived in Annecy about four o'clock, and at once proceeded to the Hotel d'Angleterre, where we met M. Mermey, who had come over from Aix-les-Bains, and was to be our guide to the bee-keepers of the neighbourhood. In Annecy we had to see M. Froissard, chef de Prefecture, and thinking we should be most likely to find him at the Prefecture, we repaired thither, only to find that he was out. It was then decided to try and find him at his residence, a very short distance on the outskirts of the town. This gave us an opportunity to see something of the town. Annecy is a picturesque, old-fashioned town, the capital of the department of Haute Savoie, and has several manufactories. Here is also a bronze statue of the famous chemist, Berthollet, who has been already alluded to when speaking of Talloires, his birthplace. Our drive soon came to an end, and we inquired at the residence of M. Froissard, but found him not there. The weather was very hot, and Madame Froissard begged us to wait a little while, as she was sure M. Froissard would come immediately he knew we had arrived. We found some seats under the trees close to the hives, and had an opportunity of observing the bees at work.

It was not long before M. Froissard made his appearance and welcomed us. Before anything was talked of, however, wine was handed round and also some hydromel, which M. Froissard wanted us to taste. M. Froissard has his own ideas about hydromel, and as M. de Layens is also a great authority with regard to it, a most lively discussion ensued. M. de Layens prefers slow, natural fermentation, while M. Froissard has been trying rapid, artificial fermentation with equal success. He employs a number of salts, which, added to the honey and water, are favourable to fermentation. In carrying out his experiments he had recourse to the services of M. Gastine, a learned specialist who has made fermentations of wine his study. This gentleman says that so little hydromel is made on account of the difficulty of getting it properly fermented. Sweetened liquids, he says, ferment on the addition of proper ferments, such as yeast and others, but always provided that the vegetable organisms of which these ferments are composed find in the liquids the proper nutrient substances for their nourishment. These substances are various, some organic and others mineral, such as phosphate of potash, magnesia, lime, and also the sulphates of these substances. These substances are indispensable, and if any of them are absent, the development of the yeast-plants is either retarded or entirely stopped, therefore the fermentation is not completed, or even does not take place. Natural musts, such as that from the juice of grapes, as well as the artificial ones of beer, besides fermentable sugars contain these organic and inorganic substances. With honey, on the contrary, it is very different; here these substances are entirely absent. Honey is composed of different kinds of sugars, which form seventy-five to eighty per cent. of its weight, the remainder being water. This, therefore, he finds is the worst medium for the development of the ferments that could be found, and for this reason he thinks the success of hydromel has been so feeble. Now, to get over this difficulty he has made experiments, and has found the best nutritive substance to be composed of the following salts:—

Phosphate of ammonia.....	7.30
Neutral tartrate of ammonia	25.50
Bitartrate of potash	43.60
Calcined magnesia	1.50
Sulphate of lime	3.60
Tartaric acid	18.50

This mixture is used in the proportion of five to seven grammes to one litre. The proportion of honey is 200 to 300 grammes to one litre of water. Now, should any of our bee-keepers like to try and make some of this beverage, we will give the instructions as given by M. Gastine and M. Froissard.

First dissolve 250 to 300 grammes of honey in every litre of water. If the sweetened water derived from washing wax cappings or pieces of broken comb is used, it will be necessary to have recourse to a hydrometer. Baumé's is recom-

mended, or Gay-Lussac's hydrometer. When these instruments are used the liquids should be at a temperature from 15° to 16° Centigrade; the liquid should also be filtered. On Baumé's scale it ought to read from 12.50° to 15.00°.

The mixture of salts must be in fine powder, and they must be thoroughly incorporated. From five to seven grammes per litre are added to the sweetened liquid, which must then be sterilised to kill the noxious germs, which would produce undesirable ferments. The boiling should not be continued long, otherwise the aroma of the honey is driven off. The copper in which the liquid is boiled should be marked, showing the height to which this rises, and should any evaporation take place the volume must be made up with water. While hot this mixture is poured into casks, which are two-thirds filled, and in these the fermentation has to take place. The casks must be perfectly clean, and the liquid is poured in hot, so as to destroy any germs that may be present. The bung-hole is then covered with a piece of cloth doubled several times, and a piece of stone is placed on the top, to prevent the cloth being displaced. As soon as the contents have cooled down to the temperature of the air the ferment can be introduced. This is best prepared from a bunch of ripe grapes, care being taken not to wet them or rub the bloom off, as this contains the ferment. The grapes are best gathered just when they are wanted, and are to be crushed in a sterilised glass until all the juice is extracted. The glass can be sterilised by being rinsed with boiling water. The juice is then filtered through a sterilised cloth, and is now ready to use as a ferment. This is poured into the cask, and must be used when freshly made. The cloth is then replaced on the bung-hole, and is used for the purpose of preventing dust and other impurities getting in, while at the same time it admits air, which is indispensable for proper fermentation. If the temperature is favourable, alcoholic fermentation sets in rapidly, from thirty-six to forty-eight hours after the addition of the ferment. Bubbles will soon rise to the surface and break, and after a few days the fermentation will become more sluggish, and the liquid will commence to clear. Then draw off a portion of the liquid, and pour it back again into the cask, which will restart the fermentation. This may be repeated after six or eight days. When all fermentation has ceased and the liquid is quite clear, it can be racked off into a clean cask, and put in a cool place. It must only be corked when the fermentation has definitely ended, which can be ascertained by tasting. Made in this way hydromel has a very delicate flavour, and resembles Madeira wine.

We have gone rather fully into this process, as we thought some of our readers might wish to try and utilise some of their honey in this way, but later we will give the recipe of M. de Layens, whose honey wine is all that can be desired by the most fastidious *connoisseur*. We were assured that M. Froissard's wine was good.

We next gave a short glance at the bees. There were eighteen hives of the Layens pattern, most of them cosily situated under the shade of trees, each hive having a straw cover on it. M. Froissard found that the hives in the shade did much better than the others, and were always ready first in the spring. He does not keep his honey harvests separate, but mixes all the honey together, and finds that the late lime honey improves the general flavour. We noticed esparcette in all directions, as well as sage, and we were sorry to find this mixed with lime honey, which, in our opinion, is decidedly inferior both in quality and appearance. M. Froissard no doubt caters to the taste of his customers, who prefer a darker and stronger-flavoured honey to the refined flavour of esparcette honey.

(To be continued.)

Correspondence.

The Editors do not hold themselves responsible for the opinions expressed by correspondents. No notice will be taken of anonymous communications, and correspondents are requested to write on one side of the paper only, and give their real names and addresses, not necessarily for publication, but as a guarantee of good faith. Illustrations should be drawn on separate pieces of paper.

Communications relating to the literary department, reports of Associations, Shows, Meetings, Echoes, Queries, Books for Review, &c., must be addressed only to 'The Editors of the "British Bee Journal," 17 King William Street, Strand, London, W.C.' All business communications relating to Advertisements, &c., must be addressed to Mr. J. HUCKLE, Kings Langley, Herts (see 1st page of Advertisements).

. In order to facilitate reference, Correspondents, when speaking of any letter or query previously inserted, will oblige by mentioning the number of the letter, as well as the page on which it appears.

THE PROPOSED SCOTTISH BEE-KEEPERS' ASSOCIATION.

[568.] I am very glad to see that there is again some prospect of reorganizing or starting afresh a Scottish Bee-keepers' Association. For many years the Caledonian Apiarian Society, under the guidance of its able and energetic Secretary, Mr. Bennett, was looked upon as the national show of Scotland, and its annual exhibitions, held in connexion with the Highland Society, were everywhere successful. But as Mr. Bennett was for some years desirous to hand over the Secretaryship to some one qualified to attend to these duties, and as no one could be found willing to undertake the task, the show has consequently ceased to be held for the last two years.

Now that it is proposed to start a new Association, it will only be for the good of Scotch bee-keeping in future if a Society be formed on a sound and permanent basis. With the many veterans, whose kindly advice in bygone days has proved useful to many of us, and the infusion of fresh blood within the last year or

two through those who have started to keep bees, there should be little doubt but a strong and numerous Association will be formed. It is to be hoped that as many as possible will avail themselves of the opportunity to attend the first meeting, when announced.

Coming in daily contact with the different classes of bee-keepers, and knowing somewhat of their views, I might here state that it has been long wished for among the leading Scotch hands to have an Association in Scotland conducted on similar lines to the B.B.K.A. in England, this Association to represent all classes of bee-keepers and the honey-raising industry. With the support of the upper classes, many of whom are now interested in bee-keeping, and with a good working Committee and an efficient Secretary, this might easily be accomplished.

As there are a good many bee-keepers in Scotland who take the *Record* and might not see the *British Bee Journal*, it would be advisable when calling a meeting to give due notice in both papers.—W. McNALLY, *Glentworth*.

LINCOLNSHIRE NOTES.

[569.] Since the break-up of the frost here, which was the hardest and longest experienced since 1881, the bees have had a few glorious days at the commencement of this month, and all had an opportunity of a good airing; so I have had a tour round to see my brother bee-keepers in this neighbourhood, and bearing in mind the discussion on single and double walls, porous *versus* non-porous quilts, wide and narrow entrances, &c., I determined to make a few 'notes by the way' for reference on my return. The total number of hives I am acquainted with, and which were put up for the winter, is 112. Of these four only are skeps. Eighty-eight of these were visited, and the remainder in two apiaries sent in reports. Of this number thirty are dead, *viz.*, one skep, and twenty-nine frame hives. Of these defunct lots I examined twenty-four, taking careful notes as to their condition, in order to try and form a correct opinion afterwards as to the reason of their demise; and under the head of neglected or too late feeding, I find twenty lots; the other ten were doubtless lost by the long continuance of the frost. Five of these belonged to an old and very intelligent bee-keeper. They had plenty of sealed stores, plenty of warm quilts, and chaff cushions besides; single-walled hives, with outer cases, as recommended by Mr. 'U. H.,' narrow entrances, and good sound roofs; but were frozen where they had clustered as soon as they had finished the stores in their immediate vicinity. Of these ill-fed twenty, nine composed one apiary. The man in charge last autumn said 'they didn't want feeding.' They don't now, for they are all dead, poor things! The other eleven were scattered over different apiaries in twos and threes. Most of them had a little *unsealed*

stores, and some were only weak stocks. Of the living, some were very strong, seven and eight seams of bees, and one of them had had an entrance full width of the hive, nearly an inch high. As a rule the mortality in these was very great. One stock, which I never expected to pull through—it was so weak, not more than half a pint of bees—seemed just as it had been left in the autumn. From my observations, I have formed the opinion that the most important item in wintering bees, in a severe winter like the past, is to put them away *strong*, and if they have enough food, and are dry, with a fair amount of top covering, entrances and quilts are very secondary considerations. On the other hand, if they are not strong, and they require considerable assistance to help them, then the coverings or packings will act like Paddy's overcoat—both ways. They will keep in the natural heat and keep out the cold. The weaker stocks are, the more care and packing are required, and while newspapers are so cheap there should be no excuse for insufficient top covering, paper being almost the best non-conductor of heat there is, and it has the advantage also of lying flat and close. I wintered eleven stocks last year with scarcely anything else. All devices *under* the quilt to afford winter passages are open to the objection of preventing the quilt lying close round the edges, others allowing a considerable escape of heat, and I much prefer a quilt in two pieces, with a piece of wood half an inch thick hollowed out, running the entire distance across centre of the hive, with a quilt under each edge. Slots can be cut in the top of this for candy feeding, if required. I, too, have been wondering how Mr. Wood has got on, and hope he will report. Personally, I have suffered no loss, but am fortunate in having my bees at home, so can look after them, and am sure it must have been an anxious time for those whose bees were at a distance, like our worthy Editor's.—F. J. CRIBB, *District Hon. Secretary Lincoln B. K. A., Gainsborough.*

[Our correspondent's conclusion that to winter bees well they should be 'strong when put away' is so obvious that none will dispute its soundness. Moreover, it is quite certain that weak lots of bees are difficult to winter, no matter what hive is used, the case of the successful wintering of the 'half-pint of bees,' notwithstanding. As a matter of fact, strong lots of bees—if not famished for want of food—are easily wintered. All bee-men know this, and endeavour to have their stocks strong accordingly.—Eds.]

FLOUR FOR UNITING.

[570.] Last autumn I had a curious experience with a friend's bees which I went over to drive. The hives are box hives, 11 × 11 × 9 inches inside, and the frame tops were covered with queen-excluder zinc, bought of a well-

known maker. Before going to the hives, I was shown some supers, and asked the reason the combs and honey in them were so dark in colour. I could not account for it except by supposing the bees had used the wax of the old combs in building and sealing the comb in the supers. But on going to the hives, I found that the whole six queens had been through the zinc, and that drones had been raised in the combs, so either the zinc or queens must have been curiously wrong. Late last autumn I tried flour as a pacifier with perfect success. I had two hives for uniting side by side, and, as a test, I thought I would join them at midday, when the bees were in full flight. I smoked the first lot, and caged the queen. I then smoked the second hive, which was to receive the bees, and spaced the frames wide apart, after dusting with flour. I then returned to the first hive, took the queen away, dusted the bees, inserted the frames alternately between the others, and removed the first hive. The bees did not all join at once; some kept on the wing for some time, but they did not fight.—ALPHA.

BRITISH AND IRISH HONEY COMPANY.

[571.] I trust you will grant me space for a word of reply to No. 560 (p. 93, *B. J.*, February 19th), seeing that the writer, Mr. C. N. White, directly refers to me as manager of the Company, and also by name as a debenture-holder.

I regret as sincerely as Mr. White himself does the loss sustained by shareholders and others through the collapse of the late Company, but I fail to see why the blame should be put upon my shoulders. As manager I was but a servant of the Company, and could do no more than honestly endeavour to carry out the instructions I received; and, since Mr. Woodley's promised cheque has been referred to, I would say on this point it was an easy thing for the chairman to order payment, but a most difficult matter to carry out his instructions when no funds were available. Again, with regard to Mr. White's name appearing on the prospectus before he was formally elected, I would remind him that I hold his written consent to become a director, if elected, at the very time his name was published, and his non-election merely arose from our inability to form a quorum. I admit that his name did get into print before he had been formally elected, but I afterwards apologised to him for the inadvertency.

Since Mr. White has, in your last issue, corrected his mis-statement about us holding 500l. debenture bonds instead of ordinary shares I need say no more on that point; but I do think that, while my brother and myself are engaged in an honest endeavour to keep the business of the late Company together, and carry it on (as I believe we can) to the advantage of bee-keepers as well as ourselves, it is most unfair for Mr. White to cast undeserved odium on

my action in connexion with the B. and I. H. Co.—ALFRED TIMBERLAKE, *Primrose Hill, Kings Langley, Herts.*

DAMP AND MILDEWED WRAPS.

[572.] Referring to 561 (p. 94), it is doubtless abundantly possible with paint, putty, and careful attention—the latter in quantity—to keep a wood roof water-tight the year round; nevertheless our esteemed friend 'W. W.'s' hint as to calico covering is by no means superfluous; but how is it that, in this connexion, we never hear (at least not since July, 1889) of an article that cannot possibly leak, viz., galvanised light iron roofing? Last summer I fitted up a hive with roof shaped *à la* Cowan, boarded over bee-tight, two strips of wood added to rise to corrugation of roofing sheet, and the latter fixed with fine nails. There are no damp quilts; the coverings, on the contrary, are in perfect condition, which is more than can be said of my three wood-roofed hives—one of them a triple step centre ridge by well-known maker—although I thought they had been fairly well cared for. The leakage in these latter appears to be due to capillary attraction, rather than to direct downward water-flow.—J. F., *Devon.*

NOTES BY THE WAY.

[573.] We have reached the end of the driest February on record in this district; at least, so says our provincial chronicler. The 28th ult. was a very warm day, more like a warm day in May than in February. The apiary was very lively, natural pollen was gathered from somewhere, probably from catkins, of which I notice there is a great abundance, also from snowdrops and crocus, and we put out the boxes of shavings, on which we sprinkled some pea and wheat flour mixed, and very soon the bees were reveling among the shavings, as dusty as millers. Those bee-keepers who lose their bees now from want of sufficient stores to carry them through will only have themselves to blame for the loss, as the past month has given many opportunities of supplying any deficiencies on that head; and those whose bees have suffered from dysenteric maladies, induced by the long confinement during the continued frosts of December and January, must feel thankful for the continued open weather that has given their bees the needful cleansing flights so conducive to healthy colonies.

The losses through the winter have been heavy in some apiaries, while others have got off comparatively light in that respect. The principal factor in the losses seems to be long confinement, causing dysentery or diarrhoea. Some few losses have occurred from want of winter passages through or over the frames, the bees dying of starvation with plenty of stores in the adjoining combs, which they were unable to reach for want of passages to the food. These losses rarely happen in straw hives, where the bees build of their own sweet will; but in

modern hives, and full sheets of foundation in the frames, the poor bees are obliged to build as their owner designs, and as soon as they get on with the brood combs a crate of sections is put on the top of the frames, giving passage-ways to all parts of the hive. This freedom of access to all combs of the hive while the crate of sections is on the hive lulls the bees into a false security as regards the necessity of making winter passages, by which they can have access to the combs containing winter stores when needed. Therefore I hold that it is incumbent on the apiarist to provide means of access for the bees when packing for winter. This brings us to

Winter Passages.—The past volumes of bee-literature contain many plans for winter passages, with several appliances for cutting same in combs. I myself used to cut holes through the combs every, or nearly every season, for the holes were nearly always built up the following year. One simple dodge gave the best result, and that was a piece of tin turned round into ferrule shape, and inserted in the hole in the comb. These metal passage-ways rarely get filled by the bees; but during the last few years I have used a modification of the American plan called the Hill device, which consists of three or four pieces of wood held together with a piece of hoop iron nailed across; this is laid on the tops of the frames, and gives access to the combs. My method is to have a lot of short strips of wood, and lay three or four across the frames, then the quilt over them, and the bees soon fix them. These, when taken off in the spring, can be stored in a small space in a box, and do not take up much room.

Mr. Stokes' letter to *Record*, p. 36, is a good word for the double-walled hives. That has been my contention—that double walls are best when breeding on an extensive scale is going on in the spring, and we get, as we have for several years past, spells of cold weather during May.

Excluders for Extracted Honey.—May I ask for opinions on this from our advanced bee-keepers? Their opinions will be valuable, and of great help to young hands in the craft. Last September Mr. McIntyre, in *Gleanings*, speaks of the comfort he had just experienced in the use of 450 excluders during the honey season. He says his reason for buying them was because he had so many drone combs in his super compartment, and he wished to keep the queens from going up into the supers and filling the hives with drones, but after one season he says if *all his comb was worker-size* he would not do without them again, as it is so much easier to take combs out of the super, because the bees do not build so many brace combs.

The month of March is the time for sowing bee-flower seeds. Don't forget the wallflowers for next year, or the mignonette, borage, *Limnanthes Douglasii*, and a host of others for the coming season.

I cannot refer to bee-topics of the week, as my copy of *B. B. J.* has not come to hand yet.

The Berks Association is not defunct. The

'Windsor Branch' have elected to work on their own lines, leaving the Reading or Central district to do the same. The central takes over the liabilities, also the assets, which, I believe, leaves a deficit of about 10*l.* to be met by the Central Association. This is not a very large sum, but when the wealthiest part of the Association is formed into a district branch the emoluments accruing from that wealthy district are lost, the other parts of the county must of necessity suffer, and even a deficit of a few pounds is an incubus that presses heavily on the executive in their work. I may be able, in a future number, to give fuller details of our future work in the county. Our chief difficulty is in supplying bee-papers and expert's visit to every member, when so many only subscribe enough to pay for the paper only.—W. WOODLEY, *World's End, Newbury.*

BROOD NESTS AND QUEEN-EXCLUDERS.

[574.] I have two ideas to which I would draw the attention of bee-keepers. Both are founded on articles in *Gravenhorst's Bee Journal*, and illustrated last year on page 303 and page 214. The first is a representation of an instrument for uncapping the honey in frames, before these go into the extractor. It is almost like a violin bow, with a fine saw in lieu of the hair is set partly sideways in the handle and the top end of the iron frame of the bow. When drawn across a frame of sealed honey, the saw (or knife) cuts it, and the back part of the fiddlestick rests upon the frame, guiding the cut, either shallow or deep, as desired.

The second article refers to 'Queen-excluder Zinc.' I have always preferred dispensing with the queen-excluder rather than cool the temperature of the brood nest by replacing the warm quilt with a perforated metal covering extending over the whole of the frames; it must cause a certain coolness, if not a draught, from the entrance upwards right through all the tender, just-hatched bees and brood. It does seem to me a most unnatural covering, and does not sound reasonable; besides, I think nobody would argue that all the honey-laden bees returning ever pass through the crowded state of the brood nest to deposit their burden in sections and supers above it. The centre sections are always first finished, and it is clear that the warmth escaping through the excluder robs the brood nest, and assists the formation of the middle sections, these being then the warmest.

Would it not be better to keep on that portion of the quilt immediately above the brood, keeping it by that means considerably warmer? Mr. Gravenhorst says (and I agree with him) that bees heavily laden with honey, returning into the hive with the intention of storing the surplus in the chamber above, do not run over all the frames or scramble through the crowd of the brood nest to get into the upper story; they either cross the floor-board at once and run up

the back wall of the hive, or else mount at once by running up the front wall; he therefore recommends that to put only two inches of queen-excluder zinc in a frame, it should be placed so as to cover the outside frames only. Now my own idea is to keep the quilt on the brood and place a narrow strip of queen-excluder on each side of it, thus adding to the probability of side sections being filled and finished off sooner and better, especially if section racks had the centre portion of the bottom covered by a thin square brood, with a two-inch strip of excluder all round it. This board would assist in keeping the brood below the quilt snug and warm, free of all draught, and free from bees which should have no business in the nursery.—J. G. K., *Grove House, Southborough, Tunbridge Wells.*

[We suggest that our correspondent make a trial of a section rack built on the lines he lays down, and will be glad to report results, but we fear they will not be found satisfactory.—Eds.]

CURIOUS WINTERING RESULTS.

[575.] Mr. 'Useful Hints,' on p. 86, declares his inability to tell the cause of death in stocks of bees through knowing so little of the circumstances connected with each case, but I think it would trouble him a good deal even if furnished with full particulars in some cases. Take my own apiary. I examined them a week ago, and found nearly all the stocks had, with double walls 3 inches thick, whole seams of dead bees. To cite a few instances:—No. 39, combination hive, wintered on 7 frames; bees strong when packed in autumn, with plenty of stores; entrances faced south; several quilts over all. This stock is now quite useless. The adjoining colony:—Bees strong in autumn, on 9 frames, abundance of stores and quilts. This has now 6 seams of bees. Another lot, No. 41:—Bees were strong last fall, and had young queen, together with lots of natural food (own gathering), and seven quilts for covering; entrance faced north. There is now about a teacupful of bees in it. No. 32 is a cast, or second swarm, of 1890, intended to be united to another, but overlooked till too late; bees few in autumn, wintered on 8 frames, covered by 2 quilts only, stores rather short (own gathering); entrance facing north. Bees are now on 4 frames, and there is brood in two of them. Finally, there is No. 19, which had a rapid feeder of the Canadian type left inadvertently on all winter, and this, when discovered, still contained thin syrup. The bees seemed to suffer slightly from dysentery, but there were no seams of dead bees, and it now has 4 seams of bees with brood on 2 combs. All the hives named are of the 'combination' pattern with double walls, 3 inches thick.

A stock in the hive which has always wintered best hitherto is now dead, though there is plenty of honey in it. Stocks seem to have wintered best in hives with a dummy in rear of frames

left raised, so as to allow a bottom draught right below the combs and through the hives.—‘ALPHA.’

[We consider the experience of our correspondent, as detailed above, goes far to verify the observations of Mr. ‘U. H.’ on page 86. The only conclusion which we can arrive at is that ‘Alpha’ has not yet quite become a successful hand at wintering bees safely, but he will no doubt profit by the experience gained and improve. He does not say whether porous or non-porous coverings were used, though admitting the advantages of ventilation below. In spite, however, of the full details given, and the widely varying results which followed, we fancy that had Mr. ‘U. H.’ been able ‘in spirit form unseen’ to watch over and see through all the work done, it would enable him to form a shrewd guess as to the ‘why and wherefore’ of some of the failures.—Eds.]

SAWDUST FOR POLLEN.

[576.] On February 10th I overhauled and gave candy to those hives that needed it, and I am pleased to report that my fourteen stocks have come through the winter with the loss of one. The cause of that one’s decease is not far to seek, as by some oversight I packed them up with neither winter passages nor sticks over frames under the quilts, so they perished with a full frame on each side of the cluster. I contracted all entrances to half-inch when that frost began, and as all the hives are double-walled, and were packed with chaff over quilts and behind dummies, I think the inmates had every chance given them. I must say that it appears to me to be putting an unnecessary strain on the bees to give them the work of raising the temperature of the air at from 10° to 30° below freezing, coming in at a ten-inch entrance, when they do first-rats with a half-inch one, as more air *must* come in at a big door than at a little one. I found young bees in two and brood in all the other hives on February 10th.

My bees have found an inexhaustible supply of pollen. At a sawmill temporarily at work close to here, I noticed them carrying in lots of pellets, chiefly white, and to-day, being round that way, I found hundreds of them fairly revelling on a huge pile of sawdust, just as they do on a plate of pea-flour. It is to be hoped that the larvæ have good digestive powers if they are going to be fed on sawdust for a change!—NORTHANTS.

WINTERING ON NATURAL STORES.

[577.] Three days warm at midday have enabled me to overhaul and clean my hives. Though the cold has been very great—on two nights only four degrees above zero—all my ten stocks, whether in double or single hives, are very strong. The honey last season being of inferior quality, I did not extract as much as I might have done, but left to each stock over thirty pounds on frames. Of this about one

half is unconsumed. All my hives were protected above the quilt with bags of cork-dust, and over the roofs I nailed a square of asphalted felt.

I have in store a large quantity of frames with three to five pounds of honey in each, not good enough for extraction; I propose with these in April and May to replenish the brood chambers, so that when the honey-flow commences the bees may forthwith work in the sections.—J. PELLY, *Yarford, Suffolk, February 24th, 1891.*

ENTRANCES BLOCKED IN WINTER.

[578.] We hear a good deal just now of great mortality among bees that have died with plenty of food for their sustenance. May I venture to suggest that failing to clear the entrances may have been the cause of a great deal of that mortality. During this long winter the bees have been confined to their hives so many weeks that there has been a great accumulation of dead upon the floors. When the milder weather came a rush was made for a flight; but, alas! the dead blocked the way, temperature and excitement increased, even so did the heap of dead, while the living were all helpless prisoners. My own experience justifies me in writing this. I noticed the bees from one of my ten hives were not flying while bees from the other nine were upon the wing, so I turned up a corner of the quilt, and found the bees alive, and making something of a stir. With a hook (made from the rib of an umbrella) I at once cleared the entrance, and I feel certain, from the quantity I raked out, that if I had not done so the survivors would not have survived long. Can we not devise a better entrance than so shallow a one on the level with the hive floor? To-day, I am glad to say, my bees from ten hives are revelling in pea-flour and fine chips in a revolving protected vessel, made of an old meat-tin, as described in your ever welcome *Journal* about a year since by—TINKER.

[The safest device we know of for removing the risks of disaster referred to is giving space below the frames in winter. The three-inch ‘eke’ we use quite overcomes the trouble.—Eds.]

NOTES ON WINTERING.

[579.] I have read with great interest the ‘Echo’ by J.R., page 96, in your issue of February 19th, and am happy to say that I can testify to the accuracy of some of his statements. Myself and partner have been very successful in wintering our hives, and on examining them on February 14th found them in very healthy condition; of course we took particular care that our hives were free from damp, and covered them well up with woollen cloths and cork-dust for the winter, and each hive had ample food to winter on. I found on the date mentioned above that our hives were in a very healthy state, having each a considerable quantity of sealed brood, and

the queens were laying vigorously. A very curious incident occurred during the examination, the queen from one of the hives finding its way into my trousers pocket. I did not notice this until I had reason to put my hand into my pocket for my knife to uncap some food, when I found a bee there. I paid very little attention to this until I had finished, and when I put my hand into my pocket again and drew forth the queen, which was not harmed in the least. I quickly restored her to her lost tribe, and in a short time what had at one time almost proved a disastrous thing to one of our hives ended without damage. I have examined a few hives in this district, and only in one instance have I found any great mortality, the person owning the said bees being a blind bee-keeper. He had been trying to winter on twelve frames with about five frames of bees, and these very poorly covered. I found three seams of bees dead, including the queen. Evidently they had been unable to reach the food. I united the remainder to one of his other hives for him, and gave him the best advice I could on the matter, and promised to assist him at any time he might call upon me to do so. I felt sorry for my friend, as he is a very enthusiastic bee-keeper, although blind. It gives me much pleasure to hear him talk in his own peculiar way about his bees, and to see him manipulate the same in the summer-time, and I have had many a good laugh when he has called upon me to go with him to look at his bees, and passed some remark as to how well they were doing or not, just as the case might be.—P. JOWETT, *Bingley*.

Queries and Replies.

[321.] *Returning Second Swarms.*—I had considerable difficulty last season with second swarms, or casts, and shall be much obliged if you can give me a little advice as regards the following:—I notice in *B. J.* for February 12th, 1891, 'Queries and Replies' (312), a statement with reference to the transference of bees and old combs from skeps to frame hives, 'When the second swarm or cast has come off, return it to the skep, and leave the bees in the latter,' &c. Kindly explain whether it is necessary to kill the queen of the cast before returning it, as it is impossible to cut out the queen-cells in the skep, or whether a battle royal ensues, ending in the survival of the fittest.—B. BEE, *Perthshire*.

REPLY.—If surplus queens are not required there is no special need to trouble about killing them—they will settle that matter themselves. We may say, however, it is not so difficult to remove queen-cells from skeps as our correspondent imagines. After the second swarm has issued the skep may be at once turned up; giving a little smoke will drive the few bees from the lower edges of combs, and most of the cells can be reached usually with the blade of a carving-knife and cut away.

[322.] *Painting Hives.*—During the recent mild weather I examined my bees (four stocks), three of which I found in good strength; in the other one the bees were all dead, apparently for want of food. 1. Would it be advisable to remove the combs from that hive, and, after painting it, transfer one of the other stocks into it, and continue the painting, &c., throughout? 2. What coloured paint is best to use? 3. Whether to be painted inside and out? 4. Whether to put some of the old combs, which are empty, in with the others, and if so when?—INQUIRER, *Mumbles*.

REPLY.—1. While the course you propose to adopt may be followed, there is no reason why it should, since there is no difficulty in painting hives while the bees are in possession, providing the front parts be done in the evening, after the bees have given up work for the day. 2. Light stone is the colour we prefer, but it is just a matter of taste. 3. Not inside, if the hives are healthy. 4. Yes, if needed; giving the extra combs when room is required.

[323.] *Bee Flowers.*—1. Are wallflowers of any utility as a bee-plant—say, if planted close to hives and filled with artificial pollen (peameal)? 2. What common plants or flowers might be planted for bees at present time, or a little later? Of course, I am aware a few flowers are of little use, but which are best?—ROBERT DE B. SAUNDERSON, *New Ross*.

REPLY.—1. Wallflowers, if planted in sufficient quantity, are excellent for bees in early spring, but they need not be planted close to the hives, nor are they suitable for artificial pollen-feeding, the crocus being more adapted for the latter purpose. 2. Borage, mignonette, wallflower, limnanthes, white rock, and sunflower, are as good as any half-dozen varieties we can name.

[324.] *Queens and Excluder Zinc.*—1. Would it be injurious to the bees to feed with syrup medicated with formic acid, though foul brood did not really exist there? 2. I have two hives, ten frames in each, the queens of which went up to sections last season: does it follow that they will do so again this season, or would it be wise to procure and use excluder zinc? I did not experience this trouble before.—SUBSCRIBER, *Co. Kilkenny*.

REPLY.—1. Not in the least, but do not give too much acid. 2. It does not follow, but we should be inclined to guard against risk by using excluders in these cases.

[325.] *Sugars for Bee Food.*—Which of the sugars sent is the best suited for syrup or candy-making? I find you recommend lump sugar in the *British Bee-keepers' Guide*, and granulated cane sugar in the *Journal*, and the grocers about here say that Demerara sugar is the cane sugar, and they do not know of any other. I fed my bees up with syrup made from lump sugar last autumn, and they seemed to have dysentery the first flight or two.—ANXIOUS.

REPLY.—The sugars sent are all granulated or refined, and if pure cane any of them will do

for bee-food; the reason we do not advise lump sugar of late is because so much of it is now made from beetroot, and all beet sugars are bad for bees. For your grocer to say that 'Demerara' is the only cane sugar is absurd: surely you must have misunderstood him in some way, as there are several raw sugars other than Demerara, *i.e.*, 'Porto Rico,' 'Barbadoes,' &c.

Notices to Correspondents and Inquirers.

Letters or queries asking for addresses of manufacturers of correspondents, or where appliances can be purchased, or replies giving such information, can only be inserted as advertisements. The space devoted to letters, queries, and replies, is meant for the general good of bee-keepers, and not for advertisements. We wish our Correspondents to bear in mind that, as it is necessary for us to go to press in advance of the date of issue, queries cannot always be replied to in the issue immediately following the receipt of their communication.

All queries forwarded will be attended to, and those only of personal interest will be answered in this column.

Dr. Tinker's Book on Bee-keeping for Profit.—The demand for the above has been greater than we anticipated, and the first lot received is already exhausted. We have, however, written for a further supply, which may be expected in a few days.

S. S. (Halstead).—Bees deserting Hive.—It is impossible to account for the desertion unless you have accidentally damaged the queen when giving food. If you did this she may have crept out of the hive to die, and thus caused the bees to leave. *Driving Bees.*—'Why do you wish to drive the bees from a skep in April?' On the face of it we should not think it wise to do so.

JOHN SMITH.—Bees Dying.—Only an experienced person on the spot, who knew the whole history of both stocks, could give a reliable opinion as to why two lots of driven bees treated precisely alike should be found, after the winter, one strong and well, the other dead.

D. W. M. (Ripon).—Deserted Hive.—The brood in comb sent has been 'chilled;' no trace of foul brood. We judge that the bees, finding themselves entirely foodless, have deserted the hive as a hunger swarm, leaving the small patch of brood to perish. The hive has evidently been tenanted by a late swarm, or one which had not gathered much natural food after hiving.

E. D. (Rhydygwin, S. Wales).—Comb sent contains honey or syrup only, sealed and unsealed. Brush away the *débris* on the floor-board, and all will be quite right. Probably the amount of unsealed food has caused slight symptoms of dysentery, but there is no cause for alarm.

M. H. (Bentworth).—Bees Robbing.—I. Pray don't attempt to transfer the bees while the 'robbing' trouble lasts. It would make 'confusion worse confounded' to do it. You say

'the bees were moved to a new place in the cold weather.' What distance were they moved? 2. There is nothing for it but contracting the entrances to a one or two bee-space, and continuing the use of carbolic acid. Use soft candy for feeding instead of syrup, if compelled to feed at all. An inspection should be made of the hives, if weak, to ascertain their actual condition. As you give no details we cannot form any idea of how they stand in that respect.

TRADE CATALOGUE RECEIVED.

T. B. Blow, Welwyn, Herts (56 pp.)—Mr. Blow is first in the field this year with his new catalogue for 1891, and a very complete and comprehensive one it is. Quite a number of new and excellently got-up illustrations have been specially prepared for it, including several full-page ones, wherein is adopted the idea of showing each part of the hive separate. This assists the reader very much in comprehending each hive and its working parts. No doubt there will be a large demand for this catalogue.

CLIPPINGS.

THE LATEST IN ELECTRICITY!

The *Graphic* says:—'Runaway horses can be stopped now by electric power, thanks to the latest American invention. Should the animal bolt, the driver touches a button, and the runaway receives an electric shock, which brings him to a standstill at once.'

[The above suggests nothing to bee-keepers beyond the fact that they are 'getting on' in the States; but what about the following press-cutting, which has just been forwarded to us:—

Poor Bees!—'Perhaps one of the most interesting uses to which electricity has been applied is its employment in the hiving of bees when they swarm. A practical German conceived the idea of using electricity in order to stupefy the bees without injuring them, and certainly very much assisting the safe handling of a hive. It is stated that the insects can be rendered inactive and completely senseless for thirty minutes by introducing the ends of two conducting wires into the honey-comb and applying a mild electric current.'

It would seem as if nothing is too absurd for the imaginative penny-a-liner; but his details, as given above, prove his practical knowledge of hiving swarms to be very limited.—*Eds.*]

* * * Several letters, &c., are unavoidably held over till next week.

NOTICE.—We request our correspondents in future to address all communications relating to the literary department, &c., to 'The Editors of the "BRITISH BEE JOURNAL," 17 King William Street, Strand, London, W.C.'

FOR SALE,

AS A GOING CONCERN,

One of the Largest and Oldest Established

Bee-Appliance Businesses

IN THE KINGDOM.

THE STEAM FACTORY is fitted up in the most perfect style with IMPROVED and LABOUR-SAVING MACHINERY.

The Premises are large and convenient, a good RESIDENCE is close by, and a long Lease of the whole can be had at a very moderate Rent.

A Large BEE-FARM or APIARY is connected with the Business, and the locality is a good one for Honey.

About £3000 will be required for the Purchase of the Stock and Plant. The value of the Goodwill may be arranged entirely on the results of a year's trading by the Purchaser.

APPLY TO 'MANUFACTURER,'

Care of *British Bee Journal* Office, 17 King William Street, Strand, London.

NAPHTHOL BETA.

AS we find that some of our Subscribers are not able to procure the right sort of NAPHTHOL BETA, we shall be pleased to supply any who are not able to obtain it through the usual sources, at 1s. a packet, post free. The packet contains an ounce, and is sufficient to medicate 145 lbs. of sugar. Printed instructions accompany each packet. *British Bee Journal* Office, 17 King William Street, Strand, London.

BEE-KEEPING FOR PROFIT.

By DR. TINKER.

WE have received a supply of these Books, and can forward them free by post on receipt of 1s. 2d. *British Bee Journal* Office, 17 King William Street, Strand, London.

To Lecturers, Schoolmasters, &c.

THE Committee of the British Bee-keepers' Association have resolved to reduce the price of the remaining stocks of their Coloured Diagrams to half rates.

TESTIMONIALS.

'I wish I had known of these Diagrams before; they will help me considerably.'

'The Diagrams will greatly assist me, for they are capital.'

PRICES WITH KEY.—Members of the Association, 2s. 6d. per Set. Non-Members, 4s. Postage 3d.

Pamphlet on the Management of Bees in Straw Skeps in Welsh and English, 6d. per dozen.

Address J. HUCKLE, KINGS LANGLEY, HERTS.

THE DEPOSIT SYSTEM.**British Bee Journal and Bee-keepers' Record.**

OFFICE: KINGS LANGLEY, HERTS; AND
17 KING WILLIAM STREET, STRAND, LONDON, W.C.

The following are the Rules under which we are prepared to receive Sums of Money on Deposit from persons buying and selling goods.

In order to save trouble it is requested that the Rules be carefully read over by persons using the Deposit System of trading.

DEPOSITING.

1. Method.—When strangers are dealing together, the purchase-money of the articles is deposited at our office. We acknowledge receipt of the deposit to both parties, and hold the money until we are satisfied that the purchase is concluded. If a sale be effected, we remit to the seller the amount deposited, less a charge of 6d. and the expenses of Post Office Orders and postage, &c. Cash will be forwarded by cheque, Post Office Order, or by Postal Order as preferred. If a sale or exchange be not completed, we return the amount deposited, after making the same deduction. By this means buyers and sellers are secured from fraud.

2. Deposits.—Postal Orders (drawn on General Post Office) and Cheques must be made payable to John Huckle, and crossed 'Bucks and Oxon Bank.' The numbers of the Postal Orders should be kept by the sender. We cannot be responsible for any losses that may occur in transit.

3. Honey on Approval.—All honey will be sold by sample, which must be sent direct to buyer.

4. Bee-appliances.—In ordering, the time allowed for completing the order to be stated to us when sending cash. If maker accepts, we hold cash till transaction is satisfactorily completed, when the amount will be remitted subject to conditions as in Clause 1.

5. Bees and Queens.—These will be dealt with entirely by the parties concerned, so far as price, &c., goes, and when the purchase is satisfactorily completed cash will be remitted as per Clause 1.

6. Goods in Transit.—These are at the seller's risk, i.e., any damage to or loss of an article on its journey is borne by the vendor; but a rejected article must be properly packed and returned by the same means as was used in sending it.

7. Carriage.—The carriage of all goods, except such as are sent by post, is payable by the buyer, unless otherwise agreed. If any article sent on approval be returned, each party to the transaction must pay carriage one way.

JUST PUBLISHED.

BEE-KEEPING FOR ULSTER

By REV. H. W. LETT, M.A.

Awarded First Prize in Competition promoted by the Ulster B. K. A. for 'An Essay on Modern Bee-keeping, clearly intelligible to those unacquainted with the pursuit.' Price 3d.

Address THE SECRETARY, U.B.K.A.,
41 Waring Street, Belfast.

APIFUGE.

The Original and ONLY PERFECT
Preventive against STINGING.

Quality Improved & Price Reduced.

In 1/- & 2/- Bottles; British postage 2d. extra.
All orders must be accompanied by remittance.

Special Terms to the Trade.

DARCY GRIMSHAW, Horsforth, Leeds.

Invaluable to Travellers Abroad as an In ecific-ge.

THE British Bee Journal,

BEE-KEEPERS' RECORD AND ADVISER.

No. 455. Vol. XIX. N.S. 63.]

MARCH 12, 1891.

[Published Weekly.]

Editorial, Notices, &c.

OUR PROMINENT BEE-KEEPERS.

No. 32.—MISS MACDONELL, OF GLENGARRY.

(Extracts from the autobiography of the last of the 'Chieftain's daughters' bearing the name.)

'I was born at Glengarry on Loch Oich, the highest part of the Caledonian Canal, on September

27th, 1814, and quite close to the site of the old castle,

which was blown up by Cumberland in 1746—a few yards from the garden in which the bees were kept. I am the fourth daughter of Colonel Ranaldson Macdonell, of Glengarry and Clan Ranald. My mother was a daughter of Sir William Forbes of Pitsligo, Bart., and before her marriage, at twenty-two, lived in Edinburgh. There were seven daughters of us and seven sons; six of the latter died under three years of age. We were a bright and cheerful family, full of mental and bodily vigour among the mountains and glens of our Highland home. My

mother was a very clever person in many ways, and was quite bewildered at her new mode of life, having to send a horse and cart to Inverness (forty-two miles) for some coarse needles the housekeeper wanted; but many other useful articles came back in the cart.

'My father's birthday, September 15th, was always celebrated with Highland games. They generally took place in a field about two

miles from the house. We children walked with our governess, the elder members drove—which sometimes seemed a very perilous undertaking, as they had to cross a wooden bridge over the river Garry, which used to shake violently. The horses particularly disliked the sound it made: my mother was quite afraid, but my father was always determined that horses and servants should do their proper work, and her only relief was to patter her feet on the floor of the carriage, as he said screaming both frightened

the horses and made the servants useless. It was a great day for us children: tents were always pitched for shelter. The feats were splendid, and very different from what they are nowadays. I do not remember the weight of the stones or the hammers thrown, nor the weight or the length of the caber-tree; but the leaping was admirable over a pony's back, probably thirteen or fourteen hands high. Our piper used to tell us that he had performed the feat of leaping in and out of six herring-barrels placed close together in succession. After the games there was always dancing to the pipes in the evening, and the foresters and deer-stalkers did dance well. No one

could appear at those games and dance, but in the Highland dress, kilts and plaids, looking beautiful. When any entertainment took place on a Saturday my mother was most careful to put the clocks forward twenty minutes, so that the house should be cleared before twelve o'clock. "A deoch-an-dorius"—a parting glass of whisky—was given to each man in passing out.

'About 1824 the Caledonian Canal was opened,



MISS MACDONELL, OF GLENGARRY.



and after this our first boat-load of coals arrived at Glengarry; formerly nothing was burned but peat. My father had a large and handsome barge built, and that same year I remember seeing the first two hives of bees arrive. My father was very anxious for everything that would ameliorate the condition of his people; he had an intense liking for all national things, which I inherited.

‘We three schoolroom girls were as wild as young goats on the arrival of a new governess from Edinburgh. Before she got to the front door a large deer-hound seized her muff and took it from her; her eldest pupil appeared at once and presented her with it, after scolding the dog in Gaelic.

Without shops, the advent of a packman was hailed with delight, and justified our vanishing from the presence of the governess. The only other excusable occasion was a dog-fight: at the first sound we were off and in the thick of the battle, to rescue a visitor's dog from the fangs of the deer-hounds; we had many of them, my father being very fond of deer-stalking. It was he who presented Sir Walter Scott with “Maida,” his favourite stag-hound, named after the battle in which my uncle, Lieut.-Col. Sir James Macdonell fought. It was this same uncle who held the gates of Hougoumont at Waterloo.

This dog was Sir Walter's chief favourite, was often painted along with him, and died at Abbotsford in 1824 and was buried underneath the “leaping-on-stone,” with this couplet inscribed:—

“Beneath the sculptured form which late you wore,
Sleep soundly, Maida, at your master's door.”

‘We were in the habit of going to Perth for the winter. One season, in the end of November, my mother, fearing more snow, ordered twenty men with shovels to start early to clear the road, but more fell after we left. Papa sent a message from the first carriage we were all to get out and walk. One of the maids fell into a wreath, and papa made a joke of her requiring two handsome fellows to pull her out. The frost was very keen, and our wet clothes froze: the fringe at the foot of my brother's Glengarry

tartan trousers was hanging in icicles, and my second youngest sister was ready to cry with the intensity of the cold, but was told it would be worse for her then, as the tears would freeze on her cheeks.

‘My father started for Edinburgh with my two eldest sisters, a great storm arose, and the steamer was wrecked. On leaping on a rock he struck his head, and he died of brain fever that night (January 17th, 1828), and was buried on February 1st with all Highland honours. To the admirers of Scott it was well known my father was the prototype of “Fergus McIvor” in *Waverley*. His character was such as Sir

Walter delighted to pourtray; and in the *Provost*, by Gault, there is an account of my father at the coronation of George IV.

‘After our father's death we came to reside at Merchiston Castle, near Edinburgh. We soon came to consider the confinement quite dreadful, and began to wonder how long it would take us to run some three hundred miles back to Glengarry again, so we measured how often round the battlements made a mile. We started with as many bits of wood in our hands, leaving a piece each time we came to our starting-point. On these battlements we might sing our Gaelic songs as much and as loud as we

liked. One day our governess was told by a friend that he had been quite startled when walking on the road by singing in the air, which no doubt emanated from the battlements.

‘Perhaps my first bee-memory was at Glengarry, when I saw a swarm proceed from our green-painted bee-house, and watched them taking up their quarters in the roof of the mansion-house, whence they were with some difficulty dislodged by the gardener. I remember seeing a large crock of Glengarry honey when we lived at Merchiston Castle in '28 or '29. We came to live in Bute in '41, and in '46 we bought a couple of hives near Mount Stuart, and used Cotton's book as our guide. Our efforts in bee-culture at that time were not successful, after a long and varied experience, purchasing all sorts of hives and quite overloaded with bee-gear.



THE LATE MISS CAROLINE H. R. MACDONELL.

‘In 1878 we made the acquaintance of the gentleman who writes in your columns as “A Renfrewshire Bee-keeper,” and he kindly invited my sister and me to pay him a visit, which we did, and he showed us his apiary, and explained everything to our entire satisfaction. We saw his Scotch-made embossed wax machine, which he told us was stereotyped from the original German sheets long years before the American rollers were invented, or the words “Comb Foundation” coined. His apiary consisted chiefly of storified colonies, cultivated with success in Scotland centuries before the word “Tiering” was invented in America. All the combs in his hives were movable, in frames or bars, and in the shallow supers as well. His very beautiful watering device we admired much, as well as his original rotating Observatory hive, which had great attractions for us.

‘My sister was the first to set up a Stewarton colony, and I followed. They proved a great success, and we had the pleasure of exhibiting our beautiful supers at Rothesay Show.

‘The “Renfrewshire Bee-keeper” kindly gave us in 1880 the use of his trained boy, and he quite charmed us; so much so, we begged the loan of Peter again, and for that Saturday invited a few friends to a garden party at Loch-na-Gaoidh to witness his doings. The little fellow gave a few puffs of smoke from his brown-paper roll, doffed a cover, drew the slides, and explained it was necessary to give the bees time to supply themselves with food, then raised the frames, and handed them about, showing the queen and all the internal economy of the hive—and such an expert was he that he restored everything to its original condition without a sting to any one. Eleven years have sped past, and though Peter Kerr is now a full-fledged engineer, he comes to assist me still.

‘My Renfrewshire friend kindly ordered for me a similar Observatory to his own. It was set up in the drawing-room at Loch-na-Gaoidh, since removed to my present house in Rothesay. Nothing affords me greater pleasure on a holiday than having the teachers and children of my initiatory school up for a bee-lesson—our School Board teachers and children, too. They are all shown how loyal the bees are to their queen, forming a body-guard around her, court etiquette practised, retiring backwards before her. Each bee is prepared, if need be, to go forth and lay down its life in defence of “queen and country.” There are no *strikes* in the beehive. They are too clannish for that. Short shift for the *agitator* there. They could not brook to see the honey drift past their own into other waxen kingdoms.’

USEFUL HINTS.

(Continued from p. 109.)

We were led to make the few observations with which our incompleting ‘Hints’ terminated last week because of one or two communications appearing in our pages expressing some divergence of opinion between correspondents and ourselves on bee-keeping matters; and we here repeat the hope that no misunderstanding may arise as to the free and full discussion of everything connected with bees in the columns of the *B.J.* so long as the ordinary rules of courtesy are observed, and all unseemly personalities avoided. Moreover, it is always gratifying when correspondents evince their interest in the contents of the paper, either by commenting on ‘Editorials,’ or by criticising theories in the no less interesting ‘Correspondence’ column.

As was observed last week, our only desire is to impress upon readers and upon correspondents alike, the necessity for distinctly marking the difference between the two departments named, because official responsibility—even in our little bee-world—is somewhat akin to official responsibility in larger and more important spheres. Small editors, in this respect, do not differ very much from great statesmen; and few will fail to note the difference between utterances—parliamentary and otherwise—when the responsibility of ‘office’ comes in.

But beyond this there is an enormous advantage on our side in the possession of a rather capacious set of pigeon-holes, the contents of which give us not only ‘both sides,’ but many sides, of most questions discussed. For instance, what advantage is there in John Smith, when writing to the Eds. of the *B.J.*, insisting that bees will not winter well unless certain conditions are faithfully observed—and citing his own case to prove it—if we can produce letters from William Brown and Thomas Jones respectively which just as conclusively prove that bees *have* done well while the ‘conditions’ have been completely ignored?

The most casual reader will realise the point we lay stress on, viz., that the opportunities of ‘putting this and that together’ falling to our lot as Editors, give us advantages in arriving at sound conclusions beyond the reach

Janice E. M. Macdonell

of any single individual, which must be obvious to all. We here insert a letter lately received to show with what difficulty we get any 'furrader' in our attempts to account for the variations in wintering results if we are to be guided by single cases. The letter is as follows:—

'*Warbleton, Sussex, March 2nd.*—The last week here has been unusually mild and summer-like, the thermometer in the shade ranging from 46° at nights to 56° during the day, and the sun shining brilliantly. Natural pollen has been carried into the hives freely—from furze chiefly—an indication that breeding is going on. My losses this winter consist of one good stock, with an abundance of good sealed stores on the *same combs that the bees died on*, and another lot or two terribly weakened by deaths. I recently looked over nine stocks of bees, offered me for sale, which astonished me. These consisted of six skeps and three frame hives, which latter had apparently six frames inserted in each when the bees were put into them and the remaining space left quite open, in which the bees had built combs all sorts of ways. Racks of sections had been put on some three years ago and been left on undisturbed ever since, and, by the way they are fastened in by the bees, are almost immovable; newspaper served the purpose of quilts over some portion of the combs, some had nothing whatever to cover them but the hive roof. But the skeps beat all: a more neglected lot I never saw; hardly a hive had the least covering over the straw, and were completely soaked with rain every one of them: some were supered with straw caps, in which the bees had taken up their winter quarters, while others had a large hole in top of hive quite open to the heavens; some have two or three entrances, and some are quite rotten. But what astonished me was the state of the bees: they were as healthy and bright as possible, and in no one hive did I find so many as a half-dozen dead bees (and this mind was just after the frost broke), and in most I could see the cappings of sealed brood, while mine at home were *cared for* so well that I had just before raked a lot of dead out of most hives. I attribute the capital condition of the lot of bees to their being left entirely to their own natural courses. They had never been fed, so that their stores were good honey alone, gathered, of course, at a time when it could be nicely sealed over, and although some bees were in frame hives, they were there under perfectly natural conditions, quite enough so in my way of thinking to see the way the combs were fastened in, and the amount of propolis used; anyway, I took a hint from them that too much of man's interference was not altogether beneficial for the bees.—HY. NEVE.'

The conclusion arrived at by Mr. Neve is a sound one, and tends to show how much an observer is assisted in judging of results when a personal inspection is possible. Moreover, the above case is only another

confirmation of our oft-repeated contention, that natural stores and a minimum of interference with brood chambers are important aids to safe wintering, and that the art of the bee-keeper is best shown by bestowing judicious care on his bees in early spring; using the 'forcing' process in such a way that stocks are hurried forward, and not the opposite, by his 'coddling.' When we are asked to account for all the contradictory results disclosed by the many and varying reports received, we can but sum them up in a general way by again repeating the assurance that bees can be and are safely wintered by experienced men, and that the knowledge of how to succeed in attaining this desirable end is within the reach of all who care to acquire it.

As to the means by which success is attained, why should we complain if some choose to travel by a different road to *ours*, so long as the coveted goal is reached? And so, while anxious to give readers the benefit of all the bee-knowledge we have gained, both by personal experience and by the not less important advantage of Editorial information never printed, we shall always welcome wholesome discussion in our pages.

BEES AND ODOURS.

PAPER READ BY MR. R. A. H. GRIMSHAW AT
CONVERSAZIONE OF THE BRITISH B.K.A.,
FEB. 24, 1891.

I must ask your indulgence if in this paper I deal more with the question of odours than with the distinct connexion we know exists between them and the honey-bee; that point needs no elucidation, it stands as a plain matter of fact. The visits of insects are required by some plants—they secrete perfumed nectar, which has the effect of attracting the insects, with the results we all know of. There is, however, an aptness to confuse the words odour, perfume, scent, and smell, and from this I will not attempt to exempt myself. Shakespeare tells us 'The rose by any other name would *smell* as sweet.' Moore says:—

'You may break, you may shatter the vase, if you will,
But the *scent* of the roses will hang round it still.'

And so on, through the innumerable works of preceding and subsequent writers, the words are used somewhat indiscriminately.

The scent of the violet stinks in the nostrils of the foxhunter, because it draws the hounds off the scent—mark the word—the *scent* of the fox. Now, if there is one smell above another that is an abomination, it is that of a

fox; yet the odour from the bruised leaves of the St. John's Wort (*Hypericum*) is identical with it, and is the most delicious perfume to some insects. Many plants are the colour of putrefying animal matter, emitting the same smell, the colour and the smell serving to attract such insects as are necessary for the cross-fertilisation of the plants, while they repel undesirable visitors. In other species the very exquisiteness of the perfume is protective against an enemy. In a rough survey of animate nature—or rather of the animal kingdom—we observe the power of odour as an important factor, insects, birds, and beasts being drawn towards others of their kind, or from or to suitable or distasteful plants, by being able to distinguish the attractive or repelling odour provided.

We should, strictly speaking, never take upon ourselves the responsibility of branding any odour as agreeable (attracting) or disgusting (repelling) excepting as it refers to our own sense of smell, for all, even the vilest to us, are intensely agreeable to some other animal, and the converse is also quite true. Take oil of cumin or aniseed as an example: the aroma of these is so much beloved by horses and some other animals that they are used as taming media. Some insects delight in putrefactive odours, but to others they are an abomination: every plant or animal bearing a distinctive odour is valued and sought after by some living thing, which uses this means for its discovery.

All odours are attractive in most directions, absolutely repellant ones are few in comparison. Plants, as a rule, are provided with protective appliances, mechanical arrangements against robbery—such as hairs, spines, thorns, folding doors kept tight by springs, barriers of sticky wings where leaves join stems, &c.; but I am sure the scents given off by smell-distilling cell-contents are not nearly of so protective a nature as is commonly supposed. It cannot well be so when we remember that every odour given off by plants and flowers is an elaborate secretion of its cells, generally—nearly always—identical with the essence of the whole plant—its active principle, in fact. It may be all very well to say the plant will *repel* certain visitors by the odour of this essence; in some cases I admit it does so, yet I contend this is chiefly accomplished by the other means I have named, and that the portion of essential principle which is diffused in the air is mainly attractive in its office. The plant giving off odour loses some of its substance, which floats in the air—with the wind, of course; the bulk of this matter is (for want of a better word) wasted, exactly as is the case with the clouds of pollen-grains which never fulfil their office, but are absorbed and used again in the great laboratory of the soil we live on. (A similar fate seems to overtake the countless drone-bees, which appear to us as having lived in vain.) Such substance, then, of the plant as is thus received by a desired organism produces what may be termed a pollination of odour, the scented cell-contents absorbed by the receiving organism, having successfully

played their part; but in nearly every case, I wish you to notice, this reception is in animals given by the breathing apparatus, by inhalation. The atom-like cells of odour, with their own peculiar and characteristic chemical properties, strike responsive chords on certain cells as they pass along the air-ducts, and these sensations, being carried to the brain (or what does duty for it), record the character of the plant or animal from which the messengers come.

Our own organ of smell does a score times more work than it gets credit for, and the taste-organ gets credit for an amount of labour considerably in excess of what it performs; this is due to our own physical inability to accurately discriminate in our own minds between what we taste and what we smell—there is a sort of deception practised by these two senses upon the brain. These senses are not alone in this failure of identification. Eyesight and touch may be deceived with ease. Truly speaking, the greater number of the things we believe we are actually tasting we are but smelling; for instance, the different flavours of honey. Our own comparatively coarse discriminating organ of smell can be easily rendered useless by cold; the taste-organ nearly always sympathises with it, and we thus so often find a cold in the head deprive us of the temporary use of these senses. To be accurate, we can only taste acids, alkalis, sweets, and bitters, these things recording themselves on taste-cells situated at the back part of the tongue, whereas the flavours of things rise, or are rapidly carried up, to the true smelling-cells situated in the nostrils. Now, what about the honey-bee and its taste (!) organs? Are they not, must they not be, in some portion of the mouth as in most other animals, so that what passes down the oesophagus may be checked, and passed along as approved and suitable, or rejected? Is it not more reasonable to confine the true use of the taste-organ of the bee to the discrimination between acids, alkalis, sweets, and bitters, and to locate these tasting-cells in the mouth, as with us, than to mistake tasting for smelling, and lodge the organ in the antennæ? When we observe a bee approach any substance with its head, do we not find the antennæ passed over it and touching it before the tongue comes into play, smelling and touching before tasting? It becomes an interesting subject for thought how the smell of nectar, or anything else, is carried to the knowledge-centre of the honey-bee. For it seems to me that an act of inhalation is necessary in nearly all animals before the smell-organ can be brought into use, before they can taste (!) anything beyond sweet or bitter, alkaline or sour; this is in order that minute flavour-atoms may be borne along the current and strike the scent-cells *en route*. No air-current, no inhalation is necessary to enable the bee to smell by its antennæ; there can be no actual inspiration, bringing the flavoured particles into contact with the extremely sensitive smell-organ, seeing that the inhalation of air is believed to be only by means of the spiracles found on the abdomen and thorax. Every other

animal (excepting insecta) I can think of, that is attracted or repelled by odour, demands the mechanism for the inhalation of air-currents. With the bee, which we all know is violently attracted or repelled by agreeable or disagreeable odour, I believe the scent-atoms strike immediately on those telephone-receiver-like depressions on the antennæ, which communicate the impression to the thought-centre precisely as do the scent-cells in our own nostrils. Whenever we notice bees under the influence of odour the antennæ are somewhat raised forward, so that the scent-atoms borne about by the air may strike the drum-like disc and vibrate them on the nerve-tip, which we believe is the true organ of smell. Whenever we notice bees approach an odorous substance the antennæ are first placed over it, for the reason just stated.

Returning for a moment to the agreeable or disgusting qualities of odour, let me impress upon you the fact that attraction or revulsion are almost always only questions of the intensity of the smell given off. Try most odours—musk, hawthorn, orange, heather, clover, the smell of apples, pears, and many fruits, the scents of lilies, violets, and most flowers—in intensity, and even on our notoriously coarse olfactory nerves there is an exceedingly objectionable effect produced. On the other hand, let us attenuate—by spirit, water, or air—nearly every objectionable smell, and the sensation becomes agreeable, so that the bee finds delicious what may annoy us, and is sometimes intensely annoyed at what we may deem agreeable odours. This is the case with many human beings who have more or less sensitive smell-organs. We find precisely the same thing with the essential active principles of plants; diluted they are potent medicines, whilst in intensity they are deadly poisons.

Again, we find insects which, in their larval state, feed on plants, are flavoured throughout their whole body with the active principle of the plant, besides partaking of its colour (falsely called mimicry). Both in colour and taste they resemble the food they eat, and not this alone, but they have in many cases an apparatus for casting forth flower-perfumes for the same purposes as the nectar is used by flowers—aids to cross-fertilisation or protection against undesirable mating. Some larval secretions of beetles smell of guano; some larval secretions of moths smell of pineapple, fennel, pears.

BETTER.—A *Pterostichus* smells of smelling salts; a *Dytiscus* of sulphuretted hydrogen; a *Trichius* of musk; an *Osmoderma* of Russian leather; an *Aromia* of musk; a *Cantharis* of mustard; a *Lina tremulæ* of naphtha; certain long-horns of tea-roses.

MORHS.—Musk, vanilla, jessamine, amber, vinegar, turpentine, rafia.

PLANT BUGS.—Fruit essence, thyme, peach, dead nettle, black currants, sliced cucumber, hyacinth.

GAUZE WINGS (amongst which are bees).—Musk, cachous, ether, formic acid, garlic, &c.

So that we see the delightful aromas we have

hitherto thought peculiar to plants and their flowers also emanate in many instances from members of the animal kingdom.

The whole subject of odours, so far as insects and plants are concerned, is woven the one into the other in a most beautiful web of intricate interdependence; yet, when we remember that these odours, essences of plants, when analysed seem to us (mere compounds of carbon and water) as simple as the mariner's compass, we find they are just as mysteriously wonderful. It appears as easy for the mind to grasp the idea of their simplicity as it is to think of the glistening diamond or of a plain bit of coal as a piece of carbon. The whiteness of the clear crystal, the opaque blackness of coal, however, are in truth so complex that the chemist is able to extract from the one the most lovely colours, from the other the most enchanting perfumes and delightfully tasting essences.

Correspondence.

The Editors do not hold themselves responsible for the opinions expressed by correspondents. No notice will be taken of anonymous communications, and correspondents are requested to write on one side of the paper only, and give their real names and addresses, not necessarily for publication, but as a guarantee of good faith. Illustrations should be drawn on separate pieces of paper.

** * * In order to facilitate reference, Correspondents, when speaking of any letter or query previously inserted, will oblige by mentioning the number of the letter, as well as the page on which it appears.*

THIN SINGLE-WALLED HIVES.

[580.] I am sorry if my letter in the *B. J.* for February 26th (562, p. 103) was not quite clear. I was writing rather against time, having only twenty minutes to spare before post-time. I certainly did not consider four degrees below zero as otherwise than a severe test for hives, but I believe it was stated in the *Journal* during the storm that the frost in the south was more intense than in the north, and in addition to this six degrees below zero has been mentioned

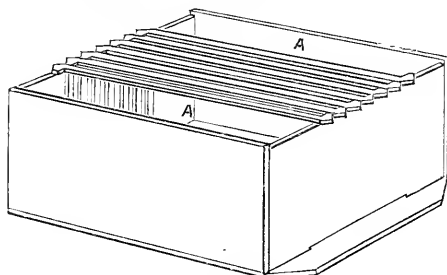

Fig. 1.

in one of the Yorkshire papers as having been registered within a few miles of this place.

When I first wrote on single-walled hives it was my intention to 'confer a real benefit on the craft,' but as I did not consider the adoption of these hives was encouraged by our *Journal*, I have latterly dropped the subject, as, of course, it does not matter the least to me if

people pay 3s. or 30s. for their hives. As our courteous Editors mentioned a few weeks since in a footnote to one of my letters, they have to give advice which is most suitable for the generality of bee-keepers. I enclose a sketch (Fig. 1) of my hive with seven frames in; it is almost too simple to send to any show. It is obvious that when there is a dummy on each side of the frames there will be spaces, A A, open to the roof, and as the ends of frames hang over edge of hive, of course there is a free current of outer air to the interior of roof. I hope I have made it plain to all. I also enclose a sketch (Fig. 2) of a rim I use when there are nine frames in, suitable for travelling to the moors, as it not only keeps the dummies and frames jammed up together, but fills up the spaces A A (Fig. 1), (when there are nine frames in and two dummies), and also keeps the crate in position. If a second

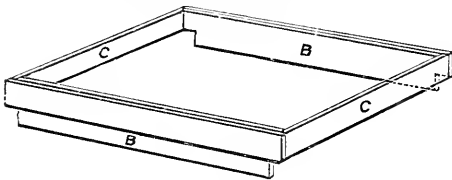

Fig. 2.

crate is required an extra rim is slipped over it, and all is secure without any extra fastening, as the rims are not as deep as the section crates. By putting slips also on the floor-boards, as in Fig. 3, hives are packed most quickly for the

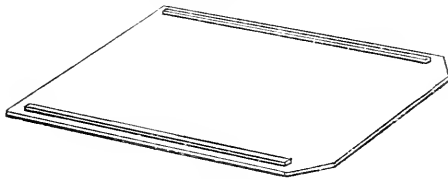

Fig. 3.

moors, as all that is necessary is to put perforated zinc over entrance and top of crate, and a cord round the lot.—ARTHUR J. H. WOOD, *Bellwood, Ripon, February 27th.*

[We thank our correspondent for promptly giving readers of the *B. J.* an opportunity of judging of the hive he uses. A reference to the sketch (Fig. 1) makes it clear that it is the one well known as 'Abbott's Makeshift Hive.' It is simplicity itself, and, as its name implies, was only intended by the original maker as one for temporary use or for use in a bee-house. We have used it years ago for holding swarms till a hive could be got ready, but always supposed it an insufficient protection for bees both in winter and summer—*i.e.*, from cold and from heat. The two dummies used certainly makes the hive double-walled on two sides, and if our correspondent will tell us if he uses a deep roof it may help us to understand stocks doing well in it in his hands with late northern honey harvests to work for. With all respect for Mr. Wood's views, we think that hives of that type will continue to be regarded by the vast majority of bee-keepers as, at best, only 'makeshifts.'—EDS.]

IN THE HUT.

'But now I am cabin'd, cribb'd, confined; bound in
To saucy doubts and fears.'

[581.] After two months of hard frost come two weeks of dense fog over all the land like a plague of hats—a darkness which might be felt. With the fog came the fear of dysentery amongst the bees and doubts as to disturbing them, so 'when in doubt, refrain' is the motto. Seeing the entrances kept clear by the bees themselves is in itself a fair assurance that all is well; but bee-keepers will do well if, once a week, a temperature of 50° gives them a chance of looking in the hives, not to neglect the opportunity, and, above all things, keep all snug and warm. I have already, with this object, removed overhead winter passages, believing that we are safe from such snaps of frost as will kill the bees before they can get round to their stores; if a keen frost come, however, the empty frames have been removed for snugness, and I know food to be now next to the cluster.

The subject of winter passages reminds me of the very interesting discussion on general subjects at the recent *conversazione*: the exchange of ideas and the experiences of such practical and yet scientific bee-keepers as Messrs. T. B. Blow, J. Hooker, Garratt, Jonas, and others well known in your columns, are of the utmost service to such present as deemed themselves novices in the art, and it would be well if our worthy Chairman were to drop a postcard to some prominent bee-keeper, shortly before a quarterly meeting, asking him to open a discussion in some useful direction. Mr. Meggy did yeoman service by suggesting that our summer *conversazione* should take the form of an outdoor reunion in the grounds of some well-disposed M. B. B. K. A. The *éclat* of such a proceeding, he said, would reach far beyond our somewhat narrow lines, and be calculated to considerably advance the cause.

Death—

'The shadow cloak'd from head to foot,
Who keeps the keys of all the creeds'—

has stalked again along our ranks, and removed another prominent bee-keeper. To all who knew him, the late Rev. J. Lawson Sisson was a man 'of infinite jest, of most excellent fancy,' and I will call to mind my first meeting with him, in the train from Norwich to London, on his way to the great show of honey at the Colinderies. The rearrangement of some sections of honey gave 'X-Tractor' an opportunity of introducing a subject which considerably relieved the tedium of an unusually monotonous ride. A joke he made in your columns about 'hitting the right nail on the head,' I shall ever remember.

'Who shall decide, when doctors disagree,
And soundest casuists doubt, like you and me?'

This ancient discussion on the use of thin-walled hives. Mr. Wood of Ripon is a bee-keeper whose opinion, in my opinion, is well

worth having, though there may be those who care not for either of our opinions. He happens in this instance to have pronounced in favour of safety behind thin walls, and it only remains for your readers to try the question, as I did some years ago somewhat exhaustively, and came to the conclusion that it stands to reason, and is supported by fact, that the more you render bees less susceptible to variations of climate in winter, by giving them a house floored, walled, and roofed with the best non-conductors of heat, the greater is the probability of their survival. We must remember that there is no such thing as cold—it is only absence of heat, and when the surrounding air is colder than the clusters of bees in the hive, the heat will leave the latter, in obedience to a law of adjustment, in a perfect ratio with the conducting or non-conducting properties of the intervening jacket—the sides and roof (quilts) surrounding the bees. If thin walls be safe, and good to be adopted, I should say thin quilting and roofing naturally follow. I can only repeat my experience that the best-protected bees come out best in spring. Any shelter from stormy wind and frost—even that of the despised bee-house—is of vast benefit.

I will run the risk of trouble resulting from tale-bearing, for the good of your readers, by telling them a bee whispered in my ear the other day that there is a dearth of wax this year; so 'vote early and often,' unless you desire to pay more money in that particular part of the year when you must have foundation and cannot get it. The foundation-maker will be busy at that time and so will the—X-TRACTOR.

NOTES BY THE WAY.

[582.] The weather has changed in our district, and we are getting a gentle rain which is very acceptable after a month's continued dry weather; may it be the harbinger of more, so that we may get a good supply in the wells, several of which have been dry for some time, while those that have held out have been very low. The rains will also improve the pasture lands and grass crops, making better and earlier forage for the busy bees.

The early spring flowers are making the garden beautiful, gladdening the hearts of both owners, beholders, and bees—who have visited every opening bud, culling the first sips of nectar from the Christmas roses and now from the crocus; and now that the bees have had a taste of natural pollen, I think we may supply the artificial when the weather is fine. Of course, each individual bee-keeper will be the best judge as to the requirements of his own apiary, and also as to the supply of natural pollen in his or her immediate neighbourhood. Where there is plenty of natural pollen it is folly to supply artificial, because the bees may possibly store more than they consume, and the cells that ought to contain young bees may be filled with useless pollen. There is very great difference in

districts, even within short distances of each other, as regards the supply of bee-food. Those who live in marshy districts will soon have their bees revelling in the willow blossoms, or palm, as it is called in some parts. This is a great help to early breeding, as the blossoms in suitable weather produce large quantities of honey, which stimulates the bees to extend the brood nest considerably.

'Alpha's' letter (570) brings out a point that requires the consideration of bee-keepers, or rather the serious consideration of manufacturers connected with bee-craft. From time to time we hear and read of the failure of so-called excluder zinc to fill the conditions it is intended to do. In some cases it may be the queens are under the usual size; but here, in this case, the whole six queens in the apiary had been through the zinc, so that evidently the zinc was at fault. Can 'Alpha' give exact dimensions of openings in the zinc? Was it laid flat on top of frames, or in a honey-board, giving space above and below the excluder zinc?

I don't think many bee-keepers would care to see galvanised iron roofs to their hives; but, appearances aside, galvanised iron would not be a suitable covering, as iron absorbs and transmits so much heat that, unless special means of ventilation were adopted, the contents of the hives would be liable to melt down and run out at the entrance-hole, as I had one myself some years back. If 'J. F.'s' hives get damp, possibly he has not enough roof ventilation, or else the boards forming the roof are approaching decay. I have one or two such. The dampness of the atmosphere seems to be attracted, and condenses on the inside. When I can get them thoroughly dry again in the summer I intend to give them a coat of paint inside the roofs, and if that does not cure, to remove the roof boards and put new ones. I use chaff cushions, and so only get the top part of the cushions stained with mildew; the under side, next quilts, is quite dry and clean as new.

A few years back Messrs. Abbott used to illustrate a beehive with a zinc cover over the wood. I remember it was quite flat on the top, and I think was called the Fuggle pattern.

If 'E. M.' (566) wishes for increase he should keep his bees on eight or nine frames, feed slowly during May, and if the season is a fair one he may confidently look forward to increase his nine stocks to twenty-seven by natural swarming, or by artificial methods he may increase to thirty-six; then next year he may look forward to having a crop of produce, and reach his intended number, fifty. I don't see that 'E. M.' if he allows natural swarming, will require to start any stock queen-rearing, as he will have abundance of queens. The old queens that lead off the first swarms may, if required, be superseded when the second swarms come off; though, if they are prolific, why do so, as generally three or four, and sometimes more, queens leave the hives with second swarms or casts?

'E. M.,' speaking of super-clearers, brings up a subject that has engaged the attention of some

few of the old hands in the honey-producing line—quite apart from appliance-making—and we have, after considerable discussion and thought, decided on a very simple but, I believe, effective form of escape, so that super honey in sections may be secured by the novice in bee-keeping and removed from the hives as a pleasant pastime compared to what it has been in the past, when everything living has had to fly to corners to escape the onslaught of angry bees. I have received the pattern escape from Mr. Flood, Donnington Road, Reading, who was commissioned to make them, and it is beautifully made to drawings sent him. I am so well pleased and so convinced of its success that I have placed an order for more. To the timid ones we say, wait, and we who try them will report after the honey harvest. To those who would like to try them the coming season I say, *place your orders early*, so that the maker may get them made before the busy time comes in a few weeks.—W. WOODLEY, *World's End, Newbury.*

EXPERTS AND THEIR WORK.

[583.] Referring to 553, p. 90, *re Experts' visits*, I send you particulars of the system in use by the Derbyshire Bee-keepers' Association to show the way of advising members of Expert's visit, and of keeping a record of work done. The particulars of the visit are entered on the card by the member visited, and the cards sent in at the end of *each week* by the Expert, thus keeping the Secretary posted up in the work done weekly. In addition to the above, I have kept a record of every visit made, in a book for my own private use, as follows:—

Date.	Name and Address.	No. of Hives.		No. lost.		No. Examined.		Remarks.
		Skeps	Frames	Skeps	Frames	Skeps	Frames	

In this book is a cash column to the right, in which I enter all money received, in addition to the entry in the counterfoil receipt-book carried for that purpose. I also enclose a slip of sample foolscap sheets, with printed headings as shown, on which, at the end of the season, we have to enter details of every visit, and send it to the Secretary, together with a formal report of the work done, this final report usually occupying about four or five sheets of foolscap, filled up both sides. I do not think the suggestion of 'T. D. S.' is any improvement on this system, which has been in use quite four or five years to my knowledge. As to keeping committees posted in the work being done, according to my experience it is far more difficult to get them to take an interest in the work than it is to find the material for them to study.

It has often occurred to me that Experts as a class are seldom heard of in the pages of your valuable *Journal*, except when some one has to growl at them—perhaps because they have very little time for writing if they attend to their many duties; but now that I am an ex-Expert, I hope to send an 'echo' occasionally. The ex-

periences of experts should be at least as interesting as those of novices, and men who toil among bees and bee hives from early morn till dewy eve, through sunshine and storm, should have something to say which would be both useful and interesting to readers.

Might it not be possible to get up a conference of bee-keepers at the coming Royal Show, as it is now some years since one was held, and Doncaster is within easy reach of all parts. What do bee-keepers think?—W. COXON, *late Expert to Derbyshire B. K. A., Ambaston.*

AN EXPERIENCE.

[584.] I began bee-keeping—at least I was presented with a swarm of bees—in July, 1887, at which time, I may say, I knew as much about these interesting creatures, and their likes and dislikes, as I knew about the inhabitants of the moon and their daily life, except in so far as I was aware that the former made honey and stung furiously any one who came near them. It is a most extraordinary thing, but somehow I had at this time a firm conviction that if bees were provided with a strong skep and super they would gather honey in abundance, quite irrespective of wind and rain. I therefore set my skep upon a small wooden stage, placed a super on the top, and covered up with canvas bags, paying little attention to crevices or level, and departed, in the belief that my labours would soon be amply rewarded. I watched operations for a few weeks with lively—I fear too lively—interest. Not a day passed without my lifting up the super to ascertain how matters were progressing. The bees, I thought, were exceedingly perverse and stubborn, for they strenuously refused to work in the upper story, although they soon filled the skep with beautiful white comb. Seeing that they did not come up to my estimation of what bees should be, my enthusiasm or bee-fever began to subside, and my visits to the apiary became less and less frequent, until they ceased altogether.

It was not until October that I examined the hive again, and to my disgust found the super still quite empty and deserted. The skep, however, was very heavy, and quite full of bees, and I made a straw thatch, and covered it up for winter. I remember the canvas bags were quite soaked, but I did not then realise how injurious this was. Thus ended my first season of bee-keeping.

The summer of 1888 saw my bees still alive, and, to my mind, working vigorously enough. I thought that they might, perhaps, have insufficient foraging-ground within convenient distance, so I procured the seed of several varieties of flowers, which I was informed were great favourites among bees, and sowed every available spot in the garden. Unfortunately, the weather did not prove favourable, and I noticed that this had a great effect upon the bees. I observed that they were very sensitive to the least atmospheric change, and began to put more trust in them as weather prophets than in the

barometer. During July they looked very like swarming, and in the evenings I remarked the hive entrance quite choked with bees. I had put on a super, and it, too, was full of bees. They failed to swarm, however, and when I looked at the super at the end of the season I was utterly chagrined to find only half a square foot of comb—with no honey!

This experience was quite enough to extinguish my zeal for apiculture, and I was on the point of giving up the whole business, when I was told by a friend that bees had been a failure everywhere that season, and that I had reason to be thankful my bees were alive at all. I resolved, therefore, to give them another chance, and secured them against winter.

During that winter I chanced to come upon that invaluable little book, *Modern Bee-keeping*, which quite revolutionised my ideas on the subject. I read the book over and over again, my interest increasing more and more. It soon became matter of wonder to me how on earth my bees had contrived to hold on so long with damp coverings and numerous other ills.

In 1889 I provided myself with a few necessary bee-appliances, and under more experienced and careful management my skep swarmed twice, besides giving a fair amount of honey. I put the swarms into bar-frame hives, and at the end of autumn drove the old stock into a bar-frame also, feeding it up with syrup.

In the beginning of last year I began taking the *B.B.J.*, and have since then followed the advice of 'Useful Hints' with most satisfactory results. With my three stocks I had four swarms and upwards of sixty pounds of heather honey (there was no clover harvest here last season). One swarm weighed seven pounds, and another seven pounds nine ounces. I gave no syrup in autumn, and found the other day on examination that they had sealed comb galore.

This finishes my story, but I cannot conclude without thanking 'Useful Hints' very cordially for much valued assistance.—BIZ E. BEE, *Vale of Athole, Perthshire, N.B.*

Queries and Replies.

[326.] *Heavy Winter Loss.*—Whilst taking a run round my bee-keeping friends the other day I met with rather a distressing case. A friend, who is an old, experienced bee-keeper, has lost six stocks, and five others are so weakened he is afraid they will not pull round. The hives are all well made. The bees were strong when put up for winter, covering nine frames, with plenty of food; there is enough left in each hive to winter a stock on. They were also warmly packed up. There are many bee-keepers round here, but none can tell what has caused the disaster, so we have decided to send you sample of the bees, combs, and sugar; also a sample of honey from another friend in the craft whose bees are close to the noted 'Wrekin,' which has a quantity of heather and trees upon it. By answering the following as

fully as possible you will be greatly helping a large number of subscribers to both your weekly and monthly papers, which I must say we feel we could not do without. 1. What has caused death of bees? 2. Do you consider food in combs fit for spring use? 3. What had better be done with combs? They are all new from full sheets of foundation last summer. Could they be used if extracted, washed in warm water, and put to dry in the sun? 4. Are the samples of sugar, A and B, fit for bee-food? 5. Would you advise uniting the weak stocks, and when? 6. What is the quality of honey, and the reason it is dark?—IN A FOG.

REPLY.—1. There is nothing in the bees sent specially indicating the cause of death. 2 and 3. Before answering these questions it should be decided whether the food has been a main factor in causing the death of the bees, and here we may say that it is quite impossible to form a reliable opinion from the few details given above. We know nothing whatever of the history of the defunct colonies, or the date they were fed up or how, or the method followed by the owner in preparing them for winter; neither have we any opportunity of inspecting the condition of bees when examined—in fact we are wanting in almost all that should guide us in arriving at a sound conclusion as to the cause of death, save and except the reply we have to give to query No. 4, which refers to the sugar. We think that both samples sent are beetroot sugars, and as such not fit for bee-food. It will do little harm to feed on it in early summer, but for winter it is quite unsuitable. 5. Yes; unite as soon as convenient. 6. Only medium. The dark colour is quite common in honeys gathered late last year.

[327.] *Bee Association for North Wales.*—Is there a Bee-keepers' Association in any of the counties of North Wales? If so, which? If not, why not? 2. What do you think of a book published by L. Upcott Gill, called *Bees and Bee-keeping*? Is it a reliable book in practical and scientific matters? 3. Is it too early to begin stimulative feeding?—PENMON, *Llanfairfechan.*

REPLY.—The only Bee Associations in Wales are the Glamorganshire (Hon. Secretary, Mr. D. P. Davies, 17 Commercial Street, Aberdare) and the Cardiganshire (Hon. Secretary, Mrs. Phillips, Priory Street, Cardigan). Referring to the last portion of query, we can only echo 'why not?' 2. Yes. 3. In your part, yes. The end of March is quite early enough.

Echoes from the Hives.

Sandford, St. Martin, March 2nd, 1891.—My twenty-six colonies of bees have come through the winter very well. I felt rather anxious about one stock, but an examination showed sealed brood on two combs and plenty of sealed stores, so my mind was set at rest. On the 26th ult. I saw that most welcome sight of the whole bee-year

—bees carrying in pollen, showing that our great Creator has not forgotten to send us the early spring flowers to gladden and beautify the earth, and to provide our bees with pollen, and that our bees have not forgotten, in these long, idle months, how to gather it. I use non-porous covering for winter, with winter passages or sticks on top of frames, with plenty of chaff coverings, and I have never lost a colony of bees from starvation or from cold. Last season I took 558 lbs. of honey from seventeen colonies, spring count, increased to twenty-six stocks, and sold two swarms. My honey sold at a very fair price without trouble, and I got the money punctually from a firm who, I am glad to say, use the columns of the *B. J.* for advertisement. Bee-keepers owe you a debt of gratitude for establishing the deposit system, showing us in an unmistakable manner that we have in the Editors friends who are always ready to help us, and we must now learn to help each other.—ED. HANCOX.

Cropton, Pickering, Yorks, March 3rd.—February 23rd being a very warm day, I overhauled my twenty-two stocks of bees, and found them all very strong and with plenty of honey to last them for two months yet. My hives are a mixed lot—including single-wall, double-wall, and square straw hives, and some are in the old straw skep: but all alive and well.—FIFTY YEARS A BEE-KEEPER.

Kent, February 28th.—I examined my six frame hives between the 16th and 27th February, and found bees all alive, with stores, sealed brood, and some young bees already hatched out. All except two are in double-walled hives, and these two are very weak, while the others are in capital order. I prefer double walls, with plenty of warm covering at the top and entrances closed to within an inch or so. I don't believe in having a six-inch entrance in winter.—F. R.

Rempstone, March 4th.—Bees around here breeding fast. Not many dead in this neighbourhood: all mine came through the winter quite safely.—A. F.

* * Several other 'Echoes' are in type, and will appear next week.

WEATHER REPORTS.

BUCKNALL, LINCOLNSHIRE. B.M. 25.

February, 1891.

Maximum 59° on 28th. Rain:—0.9 inches.
 Minimum 16° on 22nd. In 24 hrs. .06 on 8th.
 Mean max. 46.3° Rain on 3 days.
 „ min. 28.6° Average, 5 yrs. .89 in.
 „ temp. 37.5° Frost on 19 days.
 „ of 5 yrs. . . . 36.1° Mean range, 17.7°

Remarks.—A dry, mild month, with much fog, but generally bright during the day.—J. BINT, March 3rd.

WESTBOURNE, SUSSEX.

February, 1891.

Maximum .. 54° on 28th. Rain:—21 in.
 Minimum .. 23° on 24th. Heaviest fall, .16 in.
 Min. on grass 19° on 11th. on 1st.
 Frosty nights..... 22 Rain on 5 days.

Average, 5 years, 1.43 in.
 Sunshine:—125.80 hrs. Brightest day, 27th,
 9.35. Sunless days, 5.

Remarks.—The driest month and brightest February recorded in nine years. The barometer never fell below 30, and the maximum 30.87 is the highest ever recorded by me. Rainfall just one-seventh of average.—T. B. BIRKETT.

Notices to Correspondents and Inquirers.

Letters or queries asking for addresses of manufacturers or correspondents, or where appliances can be purchased, or replies giving such information, can only be inserted as advertisements. The space devoted to letters, queries, and replies, is meant for the general good of bee-keepers, and not for advertisements. We wish our Correspondents to bear in mind that, as it is necessary for us to go to press in advance of the date of issue, queries cannot always be replied to in the issue immediately following the receipt of their communication.

All queries forwarded will be attended to, and those only of personal interest will be answered in this column.

To Cambridgeshire Bee-keepers.—A lady residing at Bottisham, near Cambridge, would be glad to have the address of some experienced bee-keeper willing to advise her in bee-matters. Address to the Editors.

Dr. Timber's Book on Bee-keeping for Profit.—We must ask the numerous applicants for this work to accept this acknowledgment of receipt of cash. When the books arrive from America they will be at once forwarded.

W. TAYLOR (Wrawby, near Brigg).—By subscribing direct to this office the *B. J.* should reach you on Thursdays, but not later than Friday morning in any case. Occasionally an odd number misses in post, but we very rarely have complaints of non-delivery from subscribers.

F. R. KENT.—*Honey-comb Designs.*—In the *B. J.* for May 12th, 1887, are given full particulars of how to make honey-comb designs, together with a sketch explanatory of the process. If you cannot refer to it we will send the number for two penny stamps.

H. HOWELL (Ingatstone).—*Moving Bees.*—If the bees are moved at once, and the appearance of the hives altered somewhat to attract the notice of the bees to the change, very few will be lost. Don't attempt the plan you propose of keeping the bees indoors and feeding for a time. That will never do.

NOVICE (Kidderminster).—The bee sent is a queen.

* * Several letters, &c., are unavoidably held over till next week.

APIFUGE.

The Original and ONLY PERFECT
Preventive against STINGING.

Quality Improved & Price Reduced.

In 1/- & 2/- Bottles; British postage 2d. extra.
All orders must be accompanied by remittance.

Special Terms to the Trade.

DARCY GRIMSHAW, Horsforth, Leeds.

Invaluable to Travellers Abroad as an Insectifuge.

THE HONEY BEE :

Its Natural History, Anatomy, and Physiology.

By T. W. COWAN, F.G.S., &c., &c.,

Editor of the British Bee Journal.

Cloth gilt, price 2s. 6d.; postage 2½d.

London: HOULSTON & SONS, Paternoster Square;

ALL BOOKSELLERS; AND

British Bee Journal Office, Kings Langley, Herts;
and 17 King William St., Strand, London, W.C.

NAPHTHOL BETA.

AS we find that some of our Subscribers are not able to procure the right sort of NAPHTHOL BETA, we shall be pleased to supply any who are not able to obtain it through the usual sources, at 1s. a packet, post free. The packet contains an ounce, and is sufficient to medicate 145 lbs. of sugar. Printed instructions accompany each packet. *British Bee Journal Office, 17 King William Street, Strand, London.*

MODERN BEE-KEEPING. New Edition.

Post free, 7d. The most useful Guide for Cottagers and others commencing to keep bees. Nearly 50,000 already sold.

J. HUCKLE, Kings Langley, Herts.

THE DEPOSIT SYSTEM.

British Bee Journal and Bee-keepers' Record.

OFFICE: KINGS LANGLEY, HERTS; AND
17 KING WILLIAM STREET, STRAND, LONDON, W.C.

The following are the Rules under which we are prepared to receive Sums of Money on Deposit from persons buying and selling goods.

In order to save trouble it is requested that the Rules be carefully read over by persons using the Deposit System of trading.

DEPOSITING.

1. Method.—When strangers are dealing together, the purchase-money of the articles is deposited at our office. We acknowledge receipt of the deposit to both parties, and hold the money until we are satisfied that the purchase is concluded. If a sale be effected, we remit to the seller the amount deposited, less a charge of 6d. and the expenses of Post Office Orders and postage, &c. Cash will be forwarded by cheque, Post Office Order, or by Postal Order as preferred. If a sale or exchange be not completed, we return the amount deposited, after making the same deduction. By this means buyers and sellers are secured from fraud.

2. Deposits.—Postal Orders (drawn on General Post Office) and Cheques must be made payable to John Huckle, and crossed 'Bucks and Oxon Bank.' The numbers of the Postal Orders should be kept by the sender. We cannot be responsible for any losses that may occur in transit.

3. Honey on Approval.—All honey will be sold by sample, which must be sent direct to buyer.

4. Bee-appliances.—In ordering, the time allowed for completing the order to be stated to us when sending cash. If maker accepts, we hold cash till transaction is satisfactorily completed, when the amount will be remitted subject to conditions as in Clause 1.

5. Bees and Queens.—These will be dealt with entirely by the parties concerned, so far as price, &c., goes, and when the purchase is satisfactorily completed cash will be remitted as per Clause 1.

6. Goods in Transit.—These are at the seller's risk, i.e., any damage to or loss of an article on its journey is borne by the vendor; but a rejected article must be properly packed and returned by the same means as was used in sending it.

7. Carriage.—The carriage of all goods, *except such as are sent by post*, is payable by the buyer, unless otherwise agreed. If any article sent on approval be returned, each party to the transaction must pay carriage one way.

New Catalogue. New Catalogue. New Catalogue.

CATALOGUE.

MANY NEW AND ORIGINAL ILLUSTRATIONS. **W. P. MEADOWS,** POST FREE ON APPLICATION. **SYSTON,** Near LEICESTER.

THE
British Bee Journal,
BEE-KEEPERS' RECORD AND ADVISER.

No. 456. Vol. XIX. N. S. 64.]

MARCH 19, 1891.

[Published Weekly.]

Editorial, Notices, &c.

COUNTY COUNCILS AND TECHNICAL EDUCATION.

We wish to call the attention of our readers to the discussion at the last *conversazione* of the B. B. K. A. (see page 136) of a question brought forward that we hope may lead to some practical good. Our attention has been further called to it by the following letter on the subject from the chairman of the meeting (Mr. H. Jonas), who writes:—

'At the *conversazione* on Wednesday night it was stated that a formal application had been made by the Hon. Sec. of the Essex B. K. A. (Mr. F. H. Meggy) to the Essex County Council for a share of the grant made to them for educational purposes, on the ground that it would be usefully devoted to the employment of an expert, lecturer, and use of a bee-tent, and after some discussion it was recommended that the B. B. K. A. should at once call the attention of the several county secretaries to the fact that these grants were about to be made for educational purposes, and that, if they were to formulate a well-considered scheme for showing the County Council that the money would be wisely expended and judiciously controlled, there was every prospect of their obtaining some portion of the grant. As chairman, I promised to bring the matter before you, in order that it might be noticed in the *Bee Journal*.'

Bee-keeping has of late made rapid advances, and we may say with pride that it has become a national industry. As a branch of agriculture it compares favourably with any other; but although much has been done, very much still remains to be done to bring it before the masses. The B. B. K. A. and its affiliated county associations have done much to spread a knowledge of practical bee-keeping, but the funds available from these sources are quite inadequate, and could never be sufficient for all the requirements so long as voluntary contributions only had to be relied upon. To make bee-keeping hold its own as a national industry, and to enable us to supply all the honey we require for our consumption in this country, instead of having to import a large amount annually, we must have systematic technical education on the subject. On the Continent technical education is considered most important, and is far in advance of what it is here. The B. B. K. A. had already

taken a step in the right direction when they obtained the sanction of the Educational Department to bee-keeping being taken as one of those specific subjects by which grants may be earned. Since then many schoolmasters have taken up bee-keeping, and given their pupils instruction in the science; but a more systematic method is required, by means of which the knowledge may be brought to the very doors of those requiring it.

Technical education is considered absolutely necessary in our towns and centres of industry to enable the children of the working classes to obtain a knowledge of the trades by which they have to earn their living. Then why should we not have similar schools in the country, where the rural labourer could be practically and experimentally taught bee-keeping, in addition to other matters connected with agricultural industry? There might be some difficulty in establishing fixed schools, but with the machinery at the disposal of the Association instruction could be carried into the various rural districts. Very much could be done in arousing an interest in the subject by sending experts to lecture in various towns and villages, and then following this up by sending the bee-tent to agricultural and flower shows, wherever held. Nothing is wanting but the necessary funds.

In order to secure grants from the funds in the hands of local authorities, it would be necessary to approach them cautiously, and to show that a real benefit may result from their making such grant. We think it is a matter that the B. B. K. A. could very well take up, and might, as suggested in the above letter, call the attention of the county secretaries to it. We would not wish them to stop at this point, however, but would like to have it thoroughly discussed by the representatives of the different associations who meet the Committee of the B. B. K. A. as *ex-officio* members of that body at one of its meetings, when a good practical scheme could be drafted, and then submitted to the different local authorities having funds at their disposal by the associations interested. Bee-keeping is now taken up by all classes, and we are sure there are many county councillors who are bee-keepers, and who, if they saw a practical scheme brought forward, would give it their support. It will be seen in the report of the Essex B. K. A. on page 138 that Mr. Meggy, who alluded to this subject, which brought forth

the discussion at the *conversazione*, has already made an application for a grant on behalf of his Association; and we sincerely trust that he may be successful, if not in getting the whole of the amount asked for, at any rate a part of it, which would be very usefully spent in promoting a knowledge of bee-keeping amongst our rural population.

BEE-PAPERS FOR WINTER READING.

No. 6.—MOUNTING MICROSCOPIC OBJECTS.

From time to time we have inquiries about mounting objects, as many of our readers are in possession of a microscope, and would like to prepare specimens for future observation, and also to show their friends. There is nothing more instructive than spending an evening over the microscope, for the more an object is examined the more beautiful is it found to be. Many details, that at the first glance are not noticed, begin to be seen and appreciated only after repeated examination under varying conditions of light, and in the different media in which the objects are preserved. The careful preparation of objects, and the selection of the best media for their preservation, can only be acquired by great perseverance and practice, and the tyro must be prepared to fail many times before he is able to produce anything worth keeping. But with failure comes experience, if we will only take the trouble to notice the causes of our failure, and have sufficient perseverance to try and overcome the difficulties. 'A thing of beauty is a joy for ever' may be said of a properly prepared microscopic object, but how very few of these are to be found in the average microscopist's cabinet. The idea very often seems to be to get as many slides mounted as possible, quite irrespective of their appearance. Frequently have we looked at slides mounted in the most slovenly way and in a medium perfectly unsuited for them, and such slides being of no use either from an educational point of view or as specimens. If a thing is to be done at all it should be done well, and this applies to this branch of science as well as to any other. Preparing and mounting microscopic objects requires great delicacy of manipulation, perseverance, and patience, many preparations requiring weeks, or even months, before they can be definitely completed and put away in the cabinet for future use.

It is hardly necessary to describe the ordinary microscope, as most of our readers who take an interest in natural history subjects will already be acquainted with its structure; but those who intend to go in for dissection, and work at the internal organs of the bee, will be wise to procure some sort of dissecting microscope, which we shall describe when we begin to treat of dissection. A great deal of work can be done with simple lenses, and for the beginner these will suffice. One of the most useful is a

pocket magnifier, with three lenses, which can be purchased of opticians for about 3s. 6d. The lenses fold into a case, in which there is a hole, and this can be made to slide up and down on a rod fixed into a heavy block of wood. The magnifier should be the pocket companion of every bee-keeper, and by using one, two, or three lenses, a great many observations can be made. Another very useful lens is a watchmaker's eye-glass, which can be fixed to a piece of spring fastened to a stand, and placed in such a way that the eye can be brought towards it without having to use the hands, and by bringing the head down the eye-glass can be lowered towards the object. Everything the microscopist requires can be got of the opticians, but much time and money can be saved if the microscopist exercises a little ingenuity, and prepares what he may require for himself. A self-adjusting stand for the treble pocket magnifier can be got for 2s., and this can be used for the watchmaker's eye-glass by simply fitting a cork, through which a hole has been bored, over the rod. Horizontally into the cork drive a piece of steel wire or spring, which can be fastened to the eye-glass. The cork can be pushed up and down the rod, and a certain amount of rough adjustment obtained.

Besides lenses, the mounter requires certain instruments, many of which he can make himself. He should provide himself with a dozen dissecting needles. These can be ordinary needles of different thicknesses, the eye end being pushed into cedar sticks, such as are sold for the camel's-hair brushes. When fixed they may be heated in the gas-flame, or in that of a spirit lamp, and afterwards rehardened by heating and plunging while hot into oil. Some should be filed triangular, and some must have the points turned at right angles, in the form of a hook. They must be well polished, as it is impossible to work properly if they are at all rough, especially when delicate work is being performed.

Camel's-hair pencils are indispensable, and there should be different sizes kept ready. Two pairs of fine dissecting scissors, one straight and the other curved, should be obtained. We prefer for fine work those with a spring, that open by themselves. A few dissecting knives will be wanted, and several pairs of forceps, straight and curved. Glass tubes, drawn out to a point, and one to act as a syringe, having an india-rubber ball at the end, such as those used for filling fountain pens, is most useful. A bull's-eye condenser will be already provided with the microscope, and this must be used to concentrate the light on to the object upon which we are operating.

Objects are generally mounted on glass slides, which measure three inches in length by one in breadth, and vary very much in thickness and price. They are sold with rough edges or ground edges, and as these last look better when finished, and have so many other advantages, we prefer using them, and recommend our readers to do

so too. However, as some may prefer slides covered with ornamental paper, we will describe them too when we touch upon finishing slides. Ordinary flatted crown slips are the cheapest, and will do for beginners to practise upon, but for fine work the best selected plate-glass slips only should be used, more especially for objects requiring delicate attention to illumination.

The object has to be covered with thin glass, circles if ground-edge slips are used, but square will do if they are to be covered with paper.

Some objects are so thick that the thin cover requires some support at the edges, or others require to be mounted in some fluid, and for these purposes cells have to be used. These are made of varnish or are solid.

For the purpose of making cells a turntable must be used, one of the most useful for general purposes being 'Aylward's self-centering turntable,' which can be bought for about 12s. 6d. This instrument is indispensable, as there are few objects that can be finished without it.

Besides these things there should be a supply of watch-glasses, small porcelain evaporating dishes, and a few small pots with covers, those used for pomatum being just the thing. A few one-ounce wide-mouthed bottles, with corks, are also very useful.

When we come to chemicals, reagents, and media, it is difficult to know where to begin and where to stop, but we will mention a few that will be required.

Softening Agents.—One of the best for this purpose is acetic acid, diluted with four times its weight of water, or, as microscopists call it, a twenty-five per cent. solution. It renders some tissues quite transparent. Glycerine is of the greatest service for microscopical purposes, and not only prevents the drying of the tissues, but makes them tougher, and also more transparent. It is used in different strengths, from ten per cent. to concentrated.

While speaking of glycerine and acetic acid we should like to mention that a mixture of these is a good preservative for bees, or, in fact, insects generally, strong acetic or glacial acetic acid and pure glycerine being used in equal quantities, to which an equal quantity of water may be added. Potash, ammonia, and soda are all softening agents, potash being the strongest and ammonia the weakest. Liquor potassæ is what is usually used for softening and dissolving animal substances.

One of the best agents we know of for softening and decolourising chitine is what is sold by the name of Labarraque's solution. This is used in the proportion of one of this solution to three or four of distilled water. We would here remark that if good, clean slides are required, only distilled water should be used, as ordinary water always contains impurities which disfigure the preparation.

Dehydrating and Hardening Agents.—For dehydrating, concentrated sulphuric acid is used in a proper desiccator, but as fluids, especially such dangerous ones as sulphuric acid, are not

so handy as solids, there is nothing better for general purposes than fused chloride of calcium.

When we wish to dehydrate a preparation without losing its moist appearance, it must be brought in contact with a water-absorber. Absolute alcohol and ether are excellent for this purpose, and when the one cannot be used the other can take its place. Various hardening agents are used, such as tannin dissolved in ether or alcohol, and this is especially useful for gelatinous tissues. Alcohol itself is a powerful hardening agent, but tissues subjected to its action contract very much, so that it must be used with caution.

Bleaching Agents.—For our purpose nothing is better than Labarraque's solution, already mentioned. Turpentine is also useful, and is indispensable in mounting with balsam.

Solvents.—Amongst these we have potash, soda and ammonia, sulphuric and acetic acids, ether, alcohol, benzole, glycerine, and oil of cloves, each having its proper use.

Now that we have given a general description of apparatus and reagents required, we will proceed to practical work, and, commencing with the simplest form of mounting, we will then go on to the more difficult branches of the science, such as dissecting and section-cutting.

Before commencing, however, we wish to impress upon our readers the necessity for absolute cleanliness. Be sure that your instruments and glasses are thoroughly clean, and when work is done for the day, wipe every instrument before you put it away. It is also important that there should be but little dust in the room used for mounting, and all objects during preparation should be covered over. Bell-glasses, such as bee-keepers used to use formerly as supers, are very convenient for putting over objects, and even wine-glasses, broken at the stems, can be brought into use for this purpose.

Mounting of objects is generally divided into three sections, viz. (1) mounting dry, (2) mounting in gum resin, and (3) mounting in aqueous media.

(To be continued.)

BRITISH BEE-KEEPERS' ASSOCIATION.

DISCUSSION ON MR. GRIMSHAW'S PAPER, &c.

The Chairman complimented Mr. Grimshaw on the extremely interesting paper he had just read, and hoped that it would afford good food for thought, reflection, and discussion.

The Rev. Mr. Scott's experience to a certain extent corroborated Mr. Grimshaw's concerning the transference of scent from plants to insects. When garlic was mentioned it brought to his mind a circumstance that occurred many years ago. A gentleman in his neighbourhood was greatly disturbed, owing to the bad smell issuing from his hives, and attributed the odour to the

presence of disease. Upon examination, however, he (the speaker) soon discovered that the smell emanated from garlic, which the bees had obtained from neighbouring woods.

Mr. Andrews thanked Mr. Grimshaw for his able contribution to bee literature, which, however, was rather too profound for an ordinary bee-keeper thoroughly to grasp. The subject was one that probably few had given much attention to, and any further inquiry they might make therein would most likely be due to Mr. Grimshaw's initiative.

Mr. Garratt endorsed the compliments paid to Mr. Grimshaw, and would be very glad if that gentleman would oblige further by pointing out the direction their thoughts should take, so that some practical result might issue therefrom.

Mr. Meggy asked whether the scent as well as the hearing hollows were shown on Mr. Cheshire's diagram. The story that little boys in Germany were in the habit of eating cock-chafers because they tasted like nuts seemed to be a corroboration of Mr. Grimshaw's remarks to the effect that insects partook of the odour of plants they fed on. He could not quite agree with the reader of the paper on the question of imitation. The fact of an insect taking the odour and colour of what it ate did not explain what had been spoken of as imitation, because many examples could be found of imitation of form as well as of colour. Whether the origin of imitation of form were due to eating or other cause, the result would be the same, and would not affect the question of evolution.

Mr. Grimshaw, in reply, said his remarks respecting the emission of odours by insects were intended not to refer especially to bees, as Mr. Scott appeared to think, but to the family of gauzy wings, to which tribe bees belonged. With regard to Mr. Garratt's observations, he would say that the study of bees and odours had led him to the conclusion that the odour peculiar to the hive was emitted by the queen, and that the bee could receive impressions on its smell organs of that odour which enabled it to recognise the hive to which it belonged. Throughout the animal kingdom it was generally admitted that the female gave off a powerful odour, agreeable or the reverse, often disagreeable to those of another species. It was perceptible, even to the coarse olfactory organs of human beings, that the queen-bee emitted a much stronger smell than either drones or workers. He quite agreed that the enjoyment of or objection to a particular smell was often the result of association, and that was true in so far as the odour recalled pleasant or unpleasant reminiscences. At one time he abominated the smell of carbolic acid; now it was pleasurable to him, possibly because it suggested a pursuit in which he took the greatest interest. Answering Mr. Meggy, he could only say that Mr. Cheshire had described some organs situated along the antennæ, the object of which could not be ascertained for certain, but which were believed to be auditory organs, because they were admirably adapted for hearing. As regarded mimicry, he thought

the Almighty in His wisdom had permitted animals and plants to adapt themselves to their surroundings—certain animals, by feeding on certain plants, to take the essence thereof into their systems, and assume the colour and appearance of those plants, in consequence of which enemies were deceived.

Mr. Hooker said he had often noticed different odours issuing from hives, according to the source from which the honey was obtained. Limes gave a very sweet smell, while sweet chestnuts did anything but that. He thought the scent came from the pollen; at any rate it was much more prevalent in the neighbourhood of the hive than in the honey taken therefrom.

Mr. Grimshaw said that was not an odorous particle.

The Rev. Mr. Bancks supposed that each individual queen omitted a distinctive odour, because she was not recognised until after she had been fertilised. In the case of many insects it was the male sex which possessed that peculiar quality. Probably the power was employed as a means of attracting other members of the same species. In the case of parasitic bees, one could only conclude that the odour emitted was pleasurable to their victims.

Mr. Grimshaw said the odours probably were given as aids to general fertilisation or protection against undesirable mating.

Mr. Blow, upon being invited to speak by the Chairman, said the subject was too deep for him to express any opinions offhand. It was one which required much thought. There was very little doubt that queens possessed a distinctive smell, which accounted for the difficulty experienced, until of late years, in introducing them.

Mr. Andrews pointed out that the smelling organs on the antennæ of the drone, as shown in the diagrams, were far more numerous than on the worker or the queen, the reason of which was obvious. That fact indirectly supported Mr. Grimshaw's contention regarding the smell emitted by the queen, but he hardly thought the scent would be strong enough to impregnate the whole hive.

Mr. Blow remarked, that when bees swarmed they would often go back to the place where the queen had settled, and even in places where the bees could not see her they knew of her presence.

Mr. Garratt supposed it was not suggested that the odour which emanated from the queen could be discerned by human beings. It was far too delicate for that; but there was plenty of evidence that bees recognised their queen, because if a queen were removed and handled the bees very soon discovered the fact on the hands of the manipulator.

After a few words from Mr. Grimshaw, the Chairman, in closing the debate, expressed his belief that bees had a most powerful sense of smell, although he thought there must be some materials and liquids of which they had no appreciation through those organs (carbolic acid for instance), or their delicate olfactory nerves would be highly offended. He had noticed that

bees seemed to tell by instinct immediately a manipulator lost nerve, at which time the latter was sure to be attacked. With regard to moths, he was reminded of an occasion when visiting an entomologist (Mr. Doubleday) in the quiet little town of Epping. That gentleman then related to him a curious circumstance which had happened the previous year. A moth he (Mr. Doubleday) was anxious to secure had settled on a pill-box in his shop. After two attempts he succeeded in catching and securing it. He then opened the pill-box, which had come from France, and contained a chrysalis, when a female moth of the same species (unknown in England) flew out. How far the male moth had flown, or how far it had been attracted by the odour of the female, it was impossible to conjecture. As to sight helping taste or smell, a familiar example thereof was the fact that it was often impossible to tell with the eyes shut whether a cigar was alight or not.

On the motion of Mr. Garratt, seconded by Mr. Andrews, and carried amid applause, a vote of thanks was awarded to Mr. Grimshaw for his able paper, which had promoted an interesting discussion.

Mr. Andrews suggested that the present condition of hives, after the unusually severe winter passed through, might be a topic worth consideration, if the members present would state how their own apiaries had fared. As to his own hives, they were very much stronger than he expected to find them—more so than they had been for four or five years.

Mr. Blow had been agreeably surprised to receive reports from different parts of the country confirmatory of Mr. Andrews' experiences. His own bees had passed through the winter worse than those of his correspondents, but his losses could not be taken as a guide, owing to a variety of causes. He thought the average would be just about that stated by Mr. Andrews—two or three per cent. of colonies.

Mr. Burkitt had lost one out of six stocks, which was exceptional. The loss of bees had been great, owing to the severe weather. In many cases stocks seemed to have become divided in the hives, a little patch being separated from a larger one. Supplies had been consumed just round the brood nest, but as there were no winter passages some of the bees could not get to their food and were frozen. As a rule, winter passages were not required in England.

A conversation ensued as to the desirability of providing winter passages, Mr. Meggy, Mr. Hooker and Mr. Blow agreeing that it was a good way of maintaining necessary heat, the cluster moving on as the food was consumed.

Mr. Leadbitter said that Mr. Cheshire was of opinion that if the hive had double walls the bees would cluster at the ends of the frames and would not require winter passages. If hives with double walls were used, and the ends of the frames pointed towards a warm quarter, with the addition of impervious quilts, no winter passages were needed.

Mr. Garratt did not provide winter passages in his hives, yet there seemed to be life in all of them; and where he had lifted the quilts there appeared to be a sufficiency of bees. The winter just passed had been an excellent one to test the value of single or double-walled hives. He had an equal quantity of each, and neither seemed to possess an advantage over the other. He thought there was nothing to fear from the cold if the bees were protected from damp and actual want.

The discussion was continued by Mr. Meggy, Mr. Blow (who accounted for the large number of dead bees found in hives lately by the fact that for nearly two or three months the bees had been unable to leave their hives, in consequence of which they had a large accumulation of dead—whilst usually during the winter they were able to carry out their dead about once a month); Mr. Hooker (who thought bee-keepers were, as a rule, too anxious to secure the last ounce of honey out of their hives, instead of leaving there sufficient food, so as to obviate the necessity of feeding); Mr. Garratt; Mr. Lyon (who had only lost one hive, the cause of which was that the bees had made their nest in the centre, and had worked along one side, but were unable to work across the empty nest and get to their stores on that side); the Rev. Mr. Banks (who explained that, out of twenty-six stocks packed up by him in the autumn, twenty-five of which were provided with winter passages and one not, the former were now alive, while the latter had perished); and the Chairman (whose bees had survived the winter satisfactorily).

Mr. Hooker pointed out that the bees were given too much work to do too late in the year. They might be saved a lot of trouble if good combs filled with syrup were supplied to them. A ready method of filling the combs was to take a box which would hold three or four and put the combs therein, and slowly pour syrup through a tube into the bottom of the box. If done slowly, the food would rise by degrees, and as it rose the air would be ejected from the cells, which would fill with syrup.

Messrs. Garratt, Meggy, Blow, and Lyon commended the simplicity and utility of Mr. Hooker's plan.

Mr. Meggy said he would like to call the attention of those who had the management of county associations to the fact that county authorities had large sums of money at their disposal for the furtherance of technical education. In his own county (Essex) about 17,000*l.* was held for that purpose, which, if not used, would probably be devoted to the reduction of rates. He, as secretary of the Provincial Association, had made application for a grant for experts, for lectures in winter, and for tent-work, &c., and had asked for 350*l.* Possibly he would not obtain so much as that, but an annual grant of even much less would be valuable to the cause. At any rate the subject was an important one for the consideration of county auxiliaries. Undoubtedly bee-keeping came under the head

of technical education. The report of his Association would be issued in a fortnight, wherein would be found stated the grounds of his application. He would be happy to supply copies upon request to county branches.

Mr. Garratt and Mr. Blow wished Mr. Meggy every success, and thanked him for mentioning the matter. Every Association ought at once to take prompt action, and bring influence to bear in the right quarters. Probably many members of County Councils were also members of Bee-keepers' Associations.

The Chairman thanked Mr. Meggy for his very useful suggestion. He apprehended, however, that no sum would be granted unless the application were supported by a very clear statement of how the money was to be spent, and that if given the fund would be placed under the control of some educational body in the county. One claim in favour of bee-keeping was that it helped to keep the rural population in the country.

At the suggestion of the Chairman it was unanimously recommended, 'That the B. B. K. A. be asked to take immediate steps to draw the attention of county Associations to the grants for technical education, and to suggest that early application should be made by such bodies to County Councils to participate in those grants'

Mr. Blow moved, and Mr. Garratt seconded, a vote of thanks to the Chairman, which was briefly acknowledged, and the proceedings were brought to a close.

ESSEX BEE-KEEPERS' ASSOCIATION.

The annual meeting of this flourishing Association was held at the Vestry Hall, Chelmsford, Friday evening, January 23rd.—Mr. Ed. Durrant presiding.

The confidence which the 317 members who compose the Association have in its management was evidenced by the attendance of six besides the Chairman, the Hon. Sec. (Mr. F. H. Meggy), and the Expert (Mr. W. Debnam). Their confidence is good; their presence would have been better. The report opened with a series of postulates in the nature of a 'Bee-keeper's Creed,' which the B. B. K. A. might do worse than adapt to the purposes of a leaflet, and issue in that form for dissemination among the public. It also recapitulated the work done during the year, and showed that Mr. Meggy had applied to the County Council of Essex for a grant of 335*l.* for the E. B. K. A. from the 17,000*l.* now at the disposal of the Essex authority for furthering technical education. The meeting approved the action. The matter is of such importance as a suggestion to other counties that we hope to make some future use of the text of Mr. Meggy's application, which he has kindly forwarded to us.

The financial statement showed that the number of members was increasing, and that although, owing to special expenses on the occasion of the Prince of Wales's visit to the Annual Show at Chelmsford in the summer, the year's

income had not quite covered the expenditure, which amounted to 140*l.*, there was still a balance of about 20*l.* to the credit of the Association, besides property valued at 10*l.* Both report and balance-sheet were adopted, and the officers appointed, Lady Brooke being elected President. The Essex Association pays its expert 50*l.* a-year to visit 275 bee-keeping members every spring and autumn; supplies the *Bee-keepers' Record* gratuitously to fifty-five cottage members; and last year gave away 35*l.* in prizes. It was resolved to hold both summer and autumn county shows during 1891, and to continue the offer of a prize and certificate at every horticultural or cottage garden show in the county, where the managers would accept the same.

Several suggestions, made by hon. district secretaries and others, were discussed by those present, and it was resolved to offer a prize for 'the best-kept register and honey census for the year 1891.'

The Hon. Secretary reported that lectures were wanted at several places in the county, and Mr. Durrant having offered to undertake the duties of lecturer, arrangements were made accordingly.

The usual votes of thanks to officers and chairman closed the proceedings.

ULSTER BEE-KEEPERS' ASSOCIATION.

The annual general meeting of this Association was held at 41 Waring Street, Belfast, on Friday, the 27th of February, at four o'clock. The attendance, which was large and representative, included the Rev. H. W. Lett, Messrs. W. J. Johnston, J.P., S. Cunningham, James Frew, Jno. Kennedy, Edward Smith, Alex. W. Child, Paul McHenry, William Rainey, and S. Refausse, all well known in the district as ardent bee-keepers. The Rev. Mr. Lett, Vice-President, was called to the chair.

The report of the Committee, which was presented to the members, congratulated them on the continued success of the Association, the roll of membership and the balance to credit of the Hon. Treasurer being more satisfactory than ever, in spite of the honey crop of 1890 having been most discouraging and damping to the spirits of the faint-hearted. The essay on Bee-keeping, to which was awarded the first prize offered by the Association, had been printed and circulated among the members. The depot for the sale of honey, which had been established in Royal Avenue, Belfast, had successfully disposed of all consignments at remunerative prices, and much more could have been sold for members had they been fortunate enough to have had it to send forward. The report concluded with an expression of regret at the loss sustained by the Association through the death of Sir Richard Wallace, Bart., a former President of the Association.

The Chairman, commenting on the report, remarked that though the Association had done a great deal in extending the improved system of keeping bees in frame hives, and harvesting the

honey in one-pound sections by means of the extractor, there were still in Ulster large tracts of most suitable country that were yet practically beeless. He mentioned one district near Ballymena, well situated and adapted for producing honey, where at present there was not a single stock of bees, and yet forty years ago, in the old skep days, it was literally full of bees, scarcely a farmstead being without six or a dozen or more hives. The extinction of the bees he attributed to foul brood, or some similar disease. He was glad to know that the members had been exerting themselves to extend the pursuit in various districts throughout the great northern province by assisting and advising beginners, and in endeavouring to persuade the ignorant to double or treble their crops of honey by using the improved hives and methods advocated by the Association.

The members present discussed various matters bearing on the work of the Association in the coming season, and it was resolved to leave the arrangements for subsidising honey classes at the different provincial shows, and having the industry represented at the Chrysanthemum Show of 1891 in Belfast, to the Committee. The meeting closed with a vote of thanks to the Chairman.

Correspondence.

The Editors do not hold themselves responsible for the opinions expressed by correspondents. No notice will be taken of anonymous communications, and correspondents are requested to write on one side of the paper only, and give their real names and addresses, not necessarily for publication, but as a guarantee of good faith. Illustrations should be drawn on separate pieces of paper.

Communications relating to the literary department, reports of Associations, Shows, Meetings, Echoes, Queries, Books for Review, &c., must be addressed only to 'The Editors of the "British Bee Journal," 17 King William Street, Strand, London, W.C.' All business communications relating to Advertisements, &c., must be addressed to Mr. J. HUCKLE, Kings Langley, Herts (see 1st page of Advertisements).

** * In order to facilitate reference, Correspondents, when speaking of any letter or query previously inserted, will oblige by mentioning the number of the letter, as well as the page on which it appears.*

IS BEE-KEEPING A SUCCESS?

[585.] I have been a reader of the *B.J.* for five years, and also the *Record* for the last two years, and all I know of bees has been obtained from your columns, and—though not unsociable, I hope—I have never had a practical bee-keeper to see my stocks, or any outside assistance whatever. I began with a swarm in June, 1886, and have now, after the severe winter, five stocks in good condition in good hives of ten standard frames in each, with outside cases, entirely of my own make. They have flat sloping roofs, stands with four legs, perforated zinc floors full size of hive, with slides two and a half inches under, pulling out at the back, on the principle of a bird-cage slide. The hives and stands are made of sound wood, but the outer cases and roofs are all from *egg-boxes*, the roofs

covered with calice, and all well painted—the whole taking to pieces. I have thought several times of rushing into print with a description of hives for the benefit of beginners; but your columns are so crowded with hobbies that I should probably be voted a nuisance, and, as I know a little of local journalism, I can feel for you, Messrs. Editors, in dealing with so many different views of the same subject. Still, if you think my description of a cheap and useful hive is of any use, pray command, and I will do my best to give you a clear description.

The proof of the pudding is in the eating, and I suppose the good qualities of hives are proved in the results obtained from them, so I will give you the harvest for last year, first observing that mine is not one of the best quarters for honey-gathering, and I consider I am only now finding out what a really strong hive means. My best stock, working in five racks of twenty-one sections each, completed seventy-one—besides twenty-eight unfinished ones for own use and for feeding in spring—bringing me in 49s. Another lot gave twenty-one completed (realising 18s.), and seven for own use. Two other stocks working in shallow frames (these I tried for the first time and shall work for extracted honey with them for the future) gave me thirty-seven pounds and fifteen pounds respectively, and brought in 20s. 10d. and 15s., leaving twelve pounds for own use and that of friends. The total sum realised for honey was 5l. 2s. 10d., my balance-sheet working out with 15s. on the right side on my four years' working, while I also have the good five stocks of bees, extractor, and other appliances, worth to me 8l. or 10l., so I will leave your readers to be umpires as to the success or otherwise of bee-keeping hobby. Wishing you and your *Journal* every success.—W. A. N. H., *East Dorset*.

BEE-HOUSES.

[586.] Having kept bees for very many years in home-made hives, I am a strong advocate for bee-houses, and have latterly always used them; but the ordinary bee-houses are, in my opinion, defective in the entrances. I have seen bees, when caught in a sudden thunder-shower, with wind in summer, come home in crowds, but owing to the small entrances have been delayed in entering, and have been blown away and dashed to the ground. At shows, as far as I remember, I have never known a prize offered for a bee-house. I wish to add also that, in the home-made beehives which I have used, I always found the floor-boards in spring in a very dirty, damp, and, in my opinion, unhealthy condition.

I have endeavoured for some years to make a bee-house to answer the convenience of amateur bee-keepers in any manipulations which may be required; also to make such entrances as the bees can fly into, and be at once out of danger from wind and rain, and to keep the bees inside the hives as healthy as possible.

The plans (Fig. 1 and Fig. 2) of my bee-house arrangements, which you have made, are very correct, and I will now endeavour to explain them, beginning with Fig. 1.

ground to about one foot above the top of the entrances. The bees make no mistake; they fly right in, as shown by the arrows on the plan (Fig. 2), alighting at times at the entrances, but

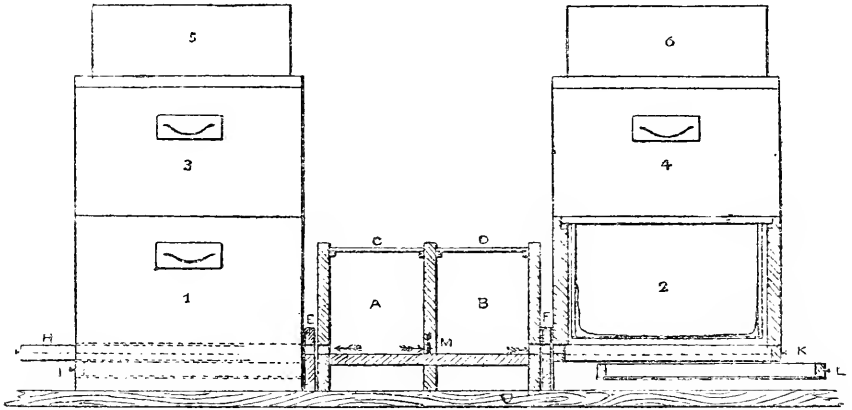

Fig. 1.

There are two entrance chambers, A and B, seven inches square, and extending back into the bee-house eighteen or twenty inches, and opening

more frequently flying one foot in, and often settling at the far end, M. The outside opening is slightly enlarged, and the part marked N is

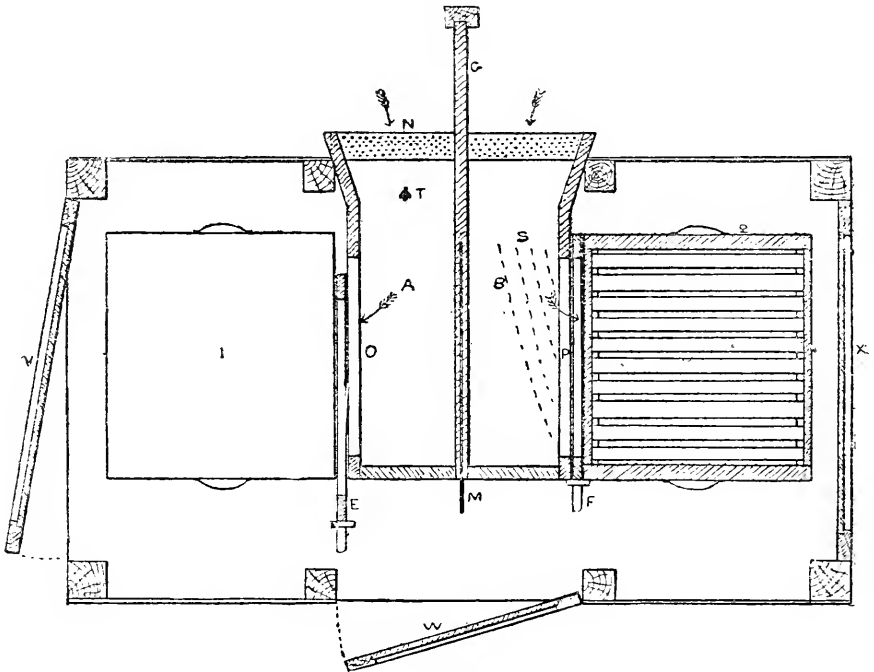

Fig. 2.

from the front of the bee-house fifteen inches going into the wrong entrance, there is an outside division, which projects in front of the bee-house twenty inches, and reaches from the

perforated zinc, and there is a small porch, just to keep the wet off. The floor of the chambers A and B is wood. From N to about T, it slopes upward a very little, but the rest is flat. When bees come home heavy laden with honey, the tail

end of the body trails along the floor, and the wood gets slippery. If the wood slopes, the bees have often to use their wings to help them up. If the wood is left rough it gets dirty, and the bees have some difficulty in pulling out dead bees.

On the top of each chamber I have a sheet of plate glass: it enables me to watch the bees going out and in. It must be loose, to lift off. I find ordinary glass too light. It blows off when the door, W, is opened, if the wind blows into the chamber. Plate glass does not break so easily.

The bees go into their hives as shown by the arrows from the side of the entrance chambers, A and B (see Figs. 1 and 2). There are passages ten or eleven inches long cut along the edge of the floor of the chambers three-eighths inch deep. Each hive has three zinc slides one inch deep—not shown in the drawings—running in front of these passages, each slide having an entrance of different width, but all a half-inch in height, cut in the zinc. Thus No. 1 slide has an entrance one inch wide; No. 2 one of four inches, and No. 3 ten inches. One only is used at once to regulate the size of the entrances to the hives, and all, if turned upside down, shut up the passage altogether. They are kept in position by a small slip of wood nailed along at O and P (Fig. 2), and are pulled out like M through a slit at the back.

The hives are placed about three-quarters of an inch from the outer sides of the chambers A and B, and, in order to prevent bees being crushed, a slip of wood, E and F, shaped thus,

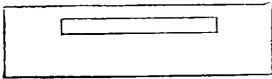

is put in between. When the hive, after being moved, is placed in position, this wood is slipped in, and the doorway, W, must be wide enough for this to pull out. The slide E is shown partly pulled out, and the slide F is in position. There are doors, V X, at each end of the bee-house (Fig. 2); they must be wide enough and high enough for the hives and supers, &c., to be put in, and it is at these doors that the operator stands when inspecting his hives.

I will now endeavour to explain the floor arrangements of my hives. The handle ends of the hives rest on pieces of wood three inches square, and reaching from front to back of the hive, sixteen or seventeen inches. Between these, two drawers, like bird-cage drawers, slip in from front to back. They run in grooves one above the other. The upper drawer has a perforated zinc bottom, the holes of which are as big as they can be so as not to allow a bee to get through. The lower drawer has a solid zinc bottom, and is filled with dry peat-moss, which has been put into the oven, not only to dry it, but to destroy all insect life or eggs. Below hive No. 2 the upper drawer is shown in position, the dotted line representing the perforated

zinc floor. The upper part of the frame of both the drawers nearest to A and B chambers is removed, and the bees get into the hive, first through the side of chambers E or F, then through slides, then through the drawer front as shown in Fig. 1.

The floor of the entrance chambers is level with these hive entrances. Below hive No. 2 the lower drawer is partly open; this in the summer-time enables the floor to be thoroughly ventilated. The drawers are made to run easy, and the hive itself rests only on the wooden blocks which are screwed to the shelf. These project a little into the inside of the hive.

I have now used these drawers for three or four years, and there has been no difficulty with them; at times perhaps they are a little tight, and require extra force to pull out. A great deal of dirt and *débris* falls through the zinc. The glass covers to entrance chambers aid me very much, and what I and other bee-holders see is of great interest. The bees when fanning take the position shown in B chamber (Fig. 2) by the dotted lines, and the drones when they come out in search of a wife make a run to the point T, then stop, comb down their antennæ, perhaps remove pollen from their eyes, and fly off. The workers are not so particular. I should say five out of six drones clean themselves as above mentioned. If it is wished to join the bees in No. 1 to No. 2, the operator stands at door, W, the covers of 1 and 2 are lifted, and both are sprinkled with syrup and the bees are allowed to fill themselves, the covers being again put on for a few minutes; the metal slides previously described from E to O is turned upside down, thus shutting up hive No. 1, the incoming bees crowd in A, the slide M is pulled out, opening a passage to B chamber, the honey combs in B are lifted out, and the brood combs with the queen from No. 1 are put into No. 2, and it is filled up with honey and pollen combs. In one minute the bees in A chamber discover that their queen is in No. 2 hive, and, their own hive entrance being shut up, their heads are turned to the chamber B, they go through the passage, M slide being removed. I never saw them fight, but they hesitate a little before going in; however, before night all is quiet. The No. 1 hive incoming bees fly into A chamber for some days, but the slide M being out, they find their way across to No. 2 hive. Robber-bees or wasps fly backwards and forwards inside the chamber, and the bees on the floor are ready for them if they alight. If robbers are about there is a restlessness about the bees; they challenge their own sisters much more on these occasions.

Last year, in the month of May, and honey coming in, I saw signs such as I have described. I drew out the bottom drawer. I saw something was wrong; I found honey among the peat, and outside robbers smelt it. I pulled out the perforated zinc drawer and found a quantity of comb refuse and some honey. I lifted the comb immediately above this. There was an old comb partially filled with hard, mouldy pollen. The bees were pulling this out as useless lumber.

The surrounding cells were sealed honey, and their sides were broken down, and the honey had gone down to the bottom, into and through the perforated zinc. I removed this comb; there was no brood in it. I sponged the zinc, put fresh peat in the lower drawer, and in a couple of hours the fighting ceased.

I fear, Mr. Editor, I have troubled you with a long letter, but I am much interested in these things myself, and if this interests any one else I shall be pleased.—A BEE-KEEPER PAST AND PRESENT.

NOTES BY THE WAY.

[387.] 'The ides—the ides of March remember!' Yes, we shall remember the weather during March, 1891, as distinctly as we remember the weather of January, 1881. When I wrote last week we were getting a nice, steady rain, so much needed; then followed a day of rather boisterous wind, and during the afternoon of Monday, the 9th, the wind rose to a hurricane, with a heavy fall of snow, that drifted in some places to the depth of fifteen feet. Our apiary presented a very wintery aspect on Tuesday; the hives, many of them, were buried, and in some the snow had penetrated into the covers by way of the air-holes. This gave some trouble to remove the cushions and wraps and shake the dry snow off, but by giving attention to the job at once I prevented the snow from melting and thereby saturating the wraps with snow-water.

Thanks, Mr. Wood, for drawing and description of your single-walled hive (580). May I ask what kind of a roof do you use to cover the said hive, and also, do you use porous or non-porous covers to the frames? Also, what provision (if any) for the bees to reach the outside combs during the winter?

'A word to the wise.' Don't forget, brethren, to place your orders for hives, foundation, and sections early, so that you may have all in readiness for the early honey harvest. Remember that *all* requisites for bee-keeping will *keep* with little or no deterioration till another year, if not all wanted this year, and under such circumstances 'stock is as good as money,' and in the height of the busy season much more valuable.

Fixing Foundation in Sections.—My method of fixing is very simple. We use one of Abbott's little reel (real) fixers, and a small mug of clean water to dip it in to prevent the wax sticking to the fixer. My better—no, I will give her her due—my best half in bee-keeping does all the folding of sections and all the foundation-fixing, and generally the scraping of sections and all the glazing of them for market. Did I hear some one say, 'Why, if you produce section honey your wife does the biggest part of the work?' My share consists of the work in the apiary, the putting in and taking off of supers, extracting, attending to the colonies, the queens, swarms, casts, hive repairs, painting, the water supply, packing and despatch of produce, and the correspondence—so you see, friends, we each do our part, and, being pretty equally yoked, we pull

well together. This little glimpse of our work in the apiary leads me on to another thought. Do we use too much foundation, or, in other words, does it pay to use full sheets of foundation in sections and frames under all circumstances? By its use in the brood nest we prevent any very large production of drones. This may be, and no doubt is, a desirable consummation, but even this gain is not without its drawbacks, as colonies that are curtailed in the production of drones are driven often to elongating the worker-cells, and rearing drones in cells somewhat larger than worker size. Now, it is reasonable that drones cribbed and confined during the important period of their growth must be of smaller size than drones reared in full-sized drone-cells, and, as a consequence, will perpetuate a race of bees deteriorated as regards size. This, I consider, is a very serious matter. How often we hear and get inquiries how to improve our strain of bees by introducing queens, without inquiring as to the paternal stock with which those queens mated; yet how very rarely do we hear a word of inquiry how to improve our *king*-bees, though I am inclined to believe this is the root of the matter.

How different these things are managed in all other stock selections! The breeders of horses, sheep, pigs, rabbits, &c., all pay more attention to the paternal than the maternal side in nature, except those who wish to keep the strain of blood pure, when, of course, both sides are of the same breed, though even then it is the best of its kind on both sides. This is running somewhat from my proposition, Does it pay to use full sheets of foundation? To the honey-producer undoubtedly it does in the brood nest, though possibly some of his extra profits produced by rearing nearly all worker-bees will be swallowed up in buying new stock to keep up his apiary to the required standard; whereas if nature had been allowed to have its sway the production of drones in greater numbers would of itself hold its own against any deterioration. No doubt if our hackneyed idea that bees consume twenty pounds of honey to make one pound of wax was put to a searching test it would have to be greatly modified; our American brethren in the craft would reduce it by about two-thirds, placing it as low as seven pounds of honey to make one pound of wax. Even at this price it pays to use it pretty freely at the present price of foundation.

By the way the question of fixed distances for brood combs crops up at the American Bee Conventions, we would be led to think there is a good field over there for advertising *metal ends*. A good few use the Hoffman frame, with the wood distance-keepers on both sides of the top bar (Messrs. Abbott introduced a similar frame from America some three or four years back, only our Standard size). Some bee-keepers in America are beginning to use the wire nails for distance-keepers, such as we discarded ten years ago or more.

Keep a sharp look-out for the bullfinches. I visited my Stanmore apiary the other day,

and I found the new fruit-trees stripped of every bud; the snow was covered with the leavings of the birds. A few strips of red rag tied in the trees so the wind can blow them about is a capital scare for the finches (proved).—W. WOODLEY, *World's End, Newbury.*

BRITISH AND IRISH HONEY COMPANY.

Having been requested to give the same prominence to Mr. C. N. White's correction of the error made by him in his letter (560, p. 93) as in the letter itself, we therefore beg to say, on behalf of Mr. White, that the word 'debuture' should read 'ordinary shares.'

Echoes from the Hives.

Fairspeir, Ascott-sub-Wychwood, Oxford, March 2nd, 1891.—I took advantage of January 31st being mild to examine my twenty-six stocks of bees, and I found them all alive, except one, which, however, still contained at least ten-pounds of stores. As these were round the outside, and as there was nothing left in the centre, I concluded that the bees were unable, on account of the intense cold, to move round the frames to the stores, and so were starved to death within reach of plenty. This will be a lesson to me in future to place two slips of wood on the frames under the quilts, to enable the bees to get over the frames to their stores—a sort of 'Hill's device,' in fact, and which will save cutting winter passages through the combs. On the whole, I found them much stronger than I expected, and with brood in each stock. I may mention my hives are all single-walled, that is, fronts and backs of one-inch thick wood and sides half-inch thick. Entrances, one inch wide in winter, and about five thicknesses of carpet over frames.—APIARIST.

Nyon, Switzerland, March 7th.—The winter here, as with you, has been exceptional in its intensity and continuity of cold. There is still much ice in my avenue. They say the frost penetrated the ground (?) one metre ten centimetres in depth. Everywhere the watercourses have frozen. Bees have wintered well. M. Spühler (Zurich) writes to say that in his pavillion the bees were confined to their hives for ninety-three days on the south side, and 107 days on the north side. All the colonies have stood it well, and there is no dysentery. Neither is there any here, after sixty-nine days of confinement.—E. BERTRAND.

Romney, Ontario, February, 1891.—We have had a few cold days, but generally the winter has been rather mild, and there are strong indications of spring. It is my intention to run two apiaries this summer. I am in a good locality, and if great care is not taken the spring and fall honey may mix with clover and linden, but I think this may be avoided.—R. J. HOLTERMANN.

Queries and Replies.

[328.] *Clipping Queen's Wings—Single-walled Hives, &c.*—Does it not recompense the bee-keeper for many annoyances (such as railway delays and breakages) to see his bees pouring out of hive entrances as if they meant 'fitting?' All my hives had a little cloud of bees before the entrances on February 25th. I was curious to see if any of my queens were as precocious as those of some of your correspondents are, so I examined five stocks, found queens in all, but no eggs or brood. They had plenty of stores, and what surprised me much—quantities of *uncapped* honey. Now, I was careful when packing last autumn to extract all such from the combs. 1. Can you explain how it came, or do the bees uncapped beyond their immediate wants? [Yes.—Eps.] 2. Do you approve of clipping queens' wings? I have tried it for the last two years, and found they worked as well, and did not swarm. I quite agree with '557' (p. 91) that it is a misnomer to call a body-box—though single—within a case a 'single-walled hive,' for it is double-walled on *all* sides. I have many such. A large tea-chest, bottom removed, makes the case. They admit of secure winter packing, and when well cooled and floored resemble a *Cowan hive*.—Glen Colmbhill, Carron, Ennis, March 2nd.

REPLY.—1. Yes, frequently. 2. Not in careless hands. Clipped queens fall to the ground on attempting to issue with a swarm, and they cannot return to the hive of themselves, and this causes mischief in various ways occasionally. 3. The words referred to by '557' and yourself appear in 'Useful Hints,' p. 76 of *B. J.* for February 12, and the hive in question is there designated a 'single-walled hive.' The 'Hints' on that page, however, are only the concluding portion of what appeared on p. 63 of the previous week. Read along with the context, there is neither 'misnomer' nor 'vagueness' in the term as applied.

[329.] 1. What flowers or seeds are best to plant for bees? 2. Which is the best way to ensure pea-flour being taken, and how may it best be given? 3. When may extra frames be inserted, and stimulative feeding commenced, when hives are on seven frames? 4. Ought brood to be in all stocks now?—ROBERT DE B. SAUNDERSON.

REPLY.—1. Borage, mignonette, wallflower, white rock, &c., &c. 2. By half-filling an old straw skep (with the odour of honey about it) with shavings and sprinkling the pea-flour on them. 3. When weather is settled and warm. 4. Yes.

[330.] 1. Are either or both the enclosed sugars fit for dry-sugar feeding? No. 1, I am told, is Barbadoes, and No. 2 Porto Rico.—2. In transferring bees from skep to frame hive I fitted one or two small pieces of comb in the frames the wrong way up, with the upward inclination of the cells pointing sideways instead of top and bottom: will brood hatch out in it all

right? 3. If combed sections were placed in a hive the wrong way up, would it be possible for the bees to fill them with honey?—E. H., *Egham*.

REPLY.—Neither of the sugars is Porto Rico, and we should not advise their use. 2. Yes; but care should be used to keep the comb right side up. 3. They should not be put 'wrong way up,' as it gives the bees needless trouble, though they can store honey in reversed sections.

[331.] *Securing Frames for Travelling*.—How can I secure the frames of a bar-frame hive from oscillating against one another when taking them to the moors (about nine miles away)? I may say that the floor-boards are in most of my hives fixed to the sides.—BEGINNER, *Darlington, Yorks*.

REPLY.—If a strip of wood is screwed down firmly across the ends of the frames, front and back, and the frames have distance guides, they should travel safely to the moors. The frames may be made quite rigid by a distance rack along the bottom, but with fixed floors this is not practicable.

Notices to Correspondents and Inquirers.

Letters or queries asking for addresses of manufacturers of correspondents, or where appliances can be purchased, or replies giving such information, can only be inserted as advertisements. The space devoted to letters, queries, and replies, is meant for the general good of bee-keepers, and not for advertisements. We wish our Correspondents to bear in mind that, as it is necessary for us to go to press in advance of the date of issue, queries cannot always be replied to in the issue immediately following the receipt of their communication.

All queries forwarded will be attended to, and those only of personal interest will be answered in this column.

J. THOMAS (*Lancing*).—*Bee Parasites*.—Bees forwarded were quite unrecognisable as to race, all markings on the abdomen being entirely gone. The parasites on them are known as the *Braula caeca* or blind louse. A description of this insect appeared in a former number of the *B. J.*, which we quote:—'It is not indigenous to this country, nor will it increase here, the atmosphere being, luckily for the British bee-keeper, too damp for it to thrive in. It is usually introduced here on the bodies of imported bees. Fumigating with

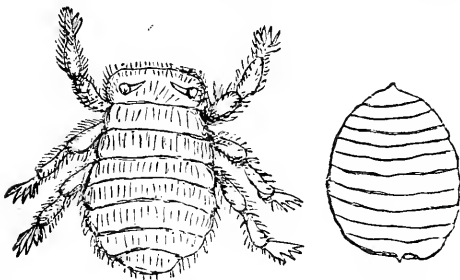

tobacco smoke will cause them to drop on to the floor-board, when they may be brushed off and destroyed. The floor-board should be afterwards washed with diluted carbolic acid, and if the operation is repeated a few times

the pest may be got rid of. We give an illustration, much magnified, of the parasite as it appears in perfect form and in its undeveloped condition.'

MOIETA (*Plumstead*).—For natural swarming in May begin stimulating at the end of March, feeding slowly and continuously. Add second swarm to first in frame hive same day on which it issues, using care in uniting, and give sections at once.

* * * We are again compelled to hold over several queries, &c., till next week.

THE DEPOSIT SYSTEM.

British Bee Journal and Bee-keepers' Record.

OFFICE: KINGS LANGLEY, HERTS; AND
17 KING WILLIAM STREET, STRAND, LONDON, W.C.

The following are the Rules under which we are prepared to receive Sums of Money on Deposit from persons buying and selling goods.

In order to save trouble it is requested that the Rules be carefully read over by persons using the Deposit System of trading.

DEPOSITING.

1. *Method*.—When strangers are dealing together, the purchase-money of the articles is deposited at our office. We acknowledge receipt of the deposit to both parties, and hold the money until we are satisfied that the purchase is concluded. If a sale be effected, we remit to the seller the amount deposited, less a charge of 6d. and the expenses of Post Office Orders and postage, &c. Cash will be forwarded by cheque, Post Office Order, or by Postal Order as preferred. If a sale or exchange be not completed, we return the amount deposited, after making the same deduction. By this means buyers and sellers are secured from fraud.

2. *Deposits*.—Postal Orders (drawn on General Post Office) and Cheques must be made payable to John Huckle, and crossed 'Bucks and Oxon Bank.' The numbers of the Postal Orders should be kept by the sender. We cannot be responsible for any losses that may occur in transit.

3. *Honey on Approval*.—All honey will be sold by sample, which must be sent direct to buyer.

4. *Bee-appliances*.—In ordering, the time allowed for completing the order to be stated to us when sending cash. If maker accepts, we hold cash till transaction is satisfactorily completed, when the amount will be remitted subject to conditions as in Clause 1.

5. *Bees and Queens*.—These will be dealt with entirely by the parties concerned, so far as price, &c., goes, and when the purchase is satisfactorily completed cash will be remitted as per Clause 1.

6. *Goods in Transit*.—These are at the seller's risk, i.e., any damage to or loss of an article on its journey is borne by the vendor; but a rejected article must be properly packed and returned by the same means as was used in sending it.

7. *Carriage*.—The carriage of all goods, except such as are sent by post, is payable by the buyer, unless otherwise agreed. If any article sent on approval be returned, each party to the transaction must pay carriage one way.

Tenth Edition. Nineteenth Thousand.

BEE-KEEPERS' GUIDE BOOK. Containing Management of Bees in Modern Moveable Comb Hives, and the Use of the Extractor. By THOS. WM. COWAN, F.G.S., F.R.M.S., &c. With numerous illustrations. Fcap. 8vo., price 1s. 6d.; or in cloth gilt, 2s. 6d. Postage 2d. To be had of HOULSTON & SONS, Paternoster Square, all Hive Dealers, Secretaries to Bee-keepers' Associations, and of J. HUCKLE, *British Bee Journal Office, Kings Langley, Herts.*

THE
British Bee Journal,
BEE-KEEPERS' RECORD AND ADVISER.

No. 457. Vol. XIX. N.S. 65.]

MARCH 26, 1891.

[Published Weekly.]

Editorial, Notices, &c.

USEFUL HINTS.

WEATHER.—‘All that one could wish’ will, we take it, be the bee-keeper’s opinion of the weather as we write, for all vegetation is making good progress, and it seems fairly certain that ‘the time of the singing of birds has come.’ The temperature is not abnormally high—for we can still see snow lying in sheltered hollows to a considerable depth, whither it was drifted in the storm of a good many days ago—but bees are ‘tackling to’ merrily, pollen is plentiful, and nearly every day more or less work is done. In fact, everything points ‘forward,’ and we say shame on the bee-keeper who allows neglect to come in and deprive his bees of a fair chance of maintaining progress once begun. There is no more discouraging sight to a bee-man—and we speak of what we have seen more than once—than to see a strong-stock of bees in early spring dead, with brood on four or five combs, and everything pointing to prosperity except food! Let no one who reads these lines fail to take note that a week’s neglect may mean death to a colony just now, and until the time when natural food can be had, unless the food supply is safe. Nothing is easier than to give a cake of soft candy, and no food is more suitable for feeding as well as stimulating at this time. If in cases of known scarcity let it be a good supply, say 3 lbs., and so make all safe for a week or two.

Luckily for stocks which have lost heavily in bees this winter, the warm weather of February did not last long enough to induce breeding to any considerable extent, otherwise the cold during the greater portion of March has been quite severe enough to cause shrinkage of already attenuated clusters, sufficient to make certain that, in some cases at least, chilled brood would

have been inevitable. So far, however, as we can learn, no harm has been done, and the welcome return of cool weather has no doubt saved the lives of an enormous number of bees which would inevitably have perished had warmth accompanied the late boisterous weather of the early part of March. Any day, however, may see a wonderful change, and the season be on us before we can look around.

We have again been endeavouring to analyse the reports before us, with the view of arriving at some fairly sound conclusion on the wintering problem. Nearly all the probabilities point to the food as being the main source of trouble, and that syrup made from beet sugar is really dangerous on which to winter bees. An extract printed nearly two years ago sums up the facts we have so far gathered in a few words as follows:—

‘In an apiary of over twenty stocks, all in frame hives, only two survive! and these were known to be the only ones out of the whole lot in which, at the time the bees were put up for the winter, there were natural stores of honey; the others were fed entirely on syrup, made from beet sugar we think, and every one of them perished!’ This extract, read in conjunction with late reports in our pages, would lead one to suppose that sufficient evidence had been adduced to decide the case; but a letter received too late for insertion in this number completely upsets, so far as the evidence of one writer can upset, all our calculations as to cause and effect, and we are again compelled to fall back on what we regard as our strongest argument, viz, that while it passes the wit of man to say why bees will perish in some hands while in others they can be kept alive in all weathers, we can point to results in the hands of some of our successful and experienced men, and say to readers, Gain experience of the right kind and success will follow.

All controversy as to the various plans

followed, either as regards double-walled or single-walled hives, warm-packing or cool-packing, must give way to the inexorable logic of facts, and these are what must decide the matter.

HONEY IMPORTS.

The total value of honey imported into the United Kingdom during the month of February, 1891, was 3845l.—W. PITTAR, *Statistical Officer*, H.M. Customs.

BRITISH BEE-KEEPERS' ASSOCIATION.

Committee meeting, held at 105 Jermyn Street, on Tuesday, March 17th. Present: T. W. Cowan (in the chair), R. T. Andrews, W. Lees McClure, J. Garratt, W. O. B. Glennie (Treasurer), and the Secretary. The minutes of the last Committee meeting were read and confirmed. Communications were received from the Rev. Dr. Bartrum, Captain Campbell, the Rev. F. T. Scott, and H. Jonas (who had previously attended a meeting of the Exhibition's sub-Committee), regretting their inability to be present. The statements of accounts to March 16th were considered and adopted.

On the recommendation of the Exhibitions sub-Committee, it was resolved to submit a draft schedule of prizes for honey to the British Dairy Farmers' Association, to be offered for competition at the Annual Dairy Show. The Secretary was instructed to prepare such schedule, and confer with the Secretary of the British Dairy Farmers' Association in respect thereto on an early date. The Secretary reported that he had not been able to obtain a reply from the Bath Local Committee in respect to the proposal for holding an exhibition of honey, &c., at the Bath and West of England Show. It was resolved that further efforts should be made to arrange such an exhibition. It was resolved to hold the monthly meetings of the Committee on the third Wednesday in each month during the ensuing year.

BATH AND WEST OF ENGLAND AGRICULTURAL SOCIETY.

We notice in the proceedings of the meeting of the B.B.K.A. held last week that, so far, no definite steps have been taken by the local authorities towards holding a bee and honey show in connexion with the annual show of the above Society, to be held at Bath this summer. Seeing that the Council of the Society are prepared to offer the same facilities as were rendered at Rochester last year, and to make a like grant towards the expenses, it is a matter for regret that action has not been already taken by the bee associations of Gloucester. Time is pressing, and as so excellent an opportunity for bringing bee-keeping prominently before the many thousands who will no doubt visit this important show should not be lost, we trust to hear that something has been done in the matter.

BEE-PAPERS FOR WINTER READING.

No. 6.—MOUNTING MICROSCOPIC OBJECTS.

(Continued from page 135.)

Dry Mounting.—There are many objects that would be spoilt if mounted in any medium, as, for instance, the hind leg of a bee with pollen in the basket. The leg itself would be better if mounted in balsam, but if we wish to show the pollen *in situ* this would be entirely spoilt by the necessary preparation of the leg.

For this class of object it is necessary to have cells prepared to support the glass covers, as they are too thick to be mounted in the ordinary way.

Many cells can be made sufficiently deep with varnish, and a supply of these should be kept in stock, as they require to be well seasoned, and the varnish must be perfectly hard before they are used.

The turntable already alluded to is used. This consists of a circular brass plate, about three inches in diameter, upon the surface of which there are springs or clips for holding the glass slip. Some of these clips are made so that they centre the slides accurately in one direction, there being a series of circles on the plate, which enable the operator to make the proper adjustment by inspecting them. The brass plate is supported on a pivot, and is made to revolve by turning a milled rim placed beneath.

We first place the glass slide on the turntable and secure it in position. Then, while revolving the table with the left hand, with the right we hold a diamond vertically in contact with the glass in the position we intend the cell to occupy. We make three rings, the object of which is to roughen the slip and to make the varnish adhere more readily. When this is done take a small camel's-hair pencil, full of varnish, and, making the table spin rapidly, bring it in contact with the glass in such a manner that it stands up like a wall. A little dexterity will be required, and at first it will be difficult just to judge the proper quantity of varnish to take up or the proper amount of pressure to apply; but with a little practice perfection will be arrived at. When one layer is put on, the slide should be put on one side to dry, and when perfectly hard another layer may be put on, and the process repeated until the cell has acquired the proper depth. The slide must then be dried or baked at a gentle heat over a long period. We prefer making a large number of cells at one time, and putting them by in some warm place for months, as we find such naturally dried cells are much more reliable than those dried artificially. The varnish of which the cell is made varies according to the nature of the medium used, and for objects mounted dry either asphaltum or gold size may be used. Marine glue is sometimes used, and is by far the best, but is troublesome to manipu-

late, and is now principally used for building up glass cells when large objects have to be preserved. Gold size requires no baking, and is one of the most useful media used by the microscopist.

If deeper cells are required than it is possible to make by the process we have just described, they should be constructed of glass, ebonite, or pure tin. These can be procured of the optician of any size and depth required. The glass slips are roughened as already described, the cell rings are also to be roughened on each side and cemented down to the glass with gold size, or other suitable varnish. Paper, cardboard, and wax cells should be carefully avoided, as they are sure to leak sooner or later, and in the case of dry mounting will admit air and moisture, and in course of time ruin the objects. New cells frequently turn out unsatisfactory, therefore a considerable number of various-sized cells should be made at one operation and put by for future use.

Our cells being ready, and having a stock of thin glass covers ready, we can proceed to mount our object, but before we do so we must point out that both glass slips and covers must be perfectly clean. The thorough cleansing of the glass is most important, as a slight film of grease is sure to prevent perfect adhesion of the varnish. For this purpose we use methylated spirit to which a few drops of ammonia are added: methylated spirit, 2 ozs.; liquid ammonia (sp. gr. .880), 10 drops; water, $\frac{1}{2}$ oz., and sufficient rouge to make a thin cream. Another way for glasses and covers that have not been used is to place them in strong sulphuric acid for an hour or two, then transfer them to methylated spirit for an hour or two. We then take them out and rub them with a clean old silk handkerchief very carefully. The slips can be rough-dried on any clean rag, and then rubbed with chamois leather.

Cleaning the Specimens.—All objects, whether intended to be mounted dry or in various media, must be cleaned, that is, they must have all dirt and foreign matter removed. This is not difficult if set about in the right way. We will place the leg of the bee which has been carefully removed from the body under the microscope, and we shall probably find a number of particles of dust upon it. Holding the leg down with a handled needle in the left hand, with the right hand we remove the particles of dirt with a camel's-hair pencil, forceps, or anything that we find most suitable for this purpose. In using an ordinary microscope, the beginner will find that he will have some difficulty in doing this at first, because he will see everything inverted and reversed, and he will have to get accustomed to this; but familiarity in this will come, as in everything else, by practice. Of course, if a regular dissecting microscope is used, this difficulty will not present itself; but even with an ordinary microscope it can be avoided by using what is called an 'erecting glass,' which again reverses the image. After the object has been thoroughly cleaned, we can select one of the

prepared slips with a cell of suitable depth, and arrange the leg in the centre, fixing it to the glass by means of a tiny drop of gum. The object has then to be dried, and upon this being properly done depends the future state of the preparation. Every object contains moisture, and unless this is thoroughly removed it condenses on the glass, and causes the object to be covered with mildew.

Drying the Specimens.—For dry-mounted objects this is done by means of a desiccator. The one we use is a bell glass with ground rim, which stands on a ground glass, the ground rim being greased to ensure better adhesion to the glass. Under the bell glass is a vessel containing concentrated sulphuric acid, which is one of the most powerful absorbers of water we have. A shelf is fixed over the acid, upon which the slides are laid. Those who do not care to use so dangerous a material as concentrated sulphuric acid could use fused chloride of calcium instead, but it is not quite so rapid. A desiccator is made expressly for use with this, and may be obtained of almost any dealer in chemical apparatus. The slide with the preparation upon it is placed in the desiccator and left to itself for twenty-four to forty-eight hours, according to its thickness. We also place the cover glass we intend to use in the desiccator, so as to make sure of its being perfectly free from moisture.

When the object is sufficiently dry, we can proceed to finish it. It is removed from the desiccator, and now with a fine camel's-hair pencil we coat the edges of the cover glass with a layer of thick varnish; wait until this has nearly set, and mount it carefully and firmly upon the cell walls of the slip. A slight pressure with the handle of the pencil will cause the cover to adhere all round, when the slide may be set aside for hardening. When sufficiently hard it can be placed on the turntable, and a slight coat of varnish applied to the edge of the circle. We now put away the slide for at least a week, after which it is examined under the microscope, and if found satisfactory it may be again placed on the turntable and have a ring of white-pink varnish put upon it, so as to cover the edges of the circle, and make everything completely air-tight. If inclined, when this is dry, rings of coloured or flush varnish may be put over this, to suit the fancy of the operator. The slide is now ready for the label bearing a description of the object. This completes it, and it is then ready for putting away in the cabinet for future reference. We have only taken the leg as an example of dry mounting; but other parts, such as the wings, head, antennæ, and portions of the external skeleton, may be mounted in the same way, taking care to use suitable cells for them, so as to show them without pressure.

We will next consider the preparation of objects for mounting in various media, such as the gum-resins and fluids.

(To be continued.)

BEE RAMBLES IN SAVOY.

(Continued from page 113.)

M. Froissard invited us to dine with him in the evening and continue our conversation, so here we left him, and went to see M. Nicot, a retired Custom House officer and a most enthusiastic bee-keeper. We found him in his bee-house in shirt-sleeves, busy at work putting sheets of foundation into frames, surrounded by a few friends who had come to talk about bees. We met with a hearty reception, and when he knew who the three standing before him were he professed himself happy. We found M. Nicot very intelligent and very fond of experimenting. He was trying different sorts of hives, of which he had fifteen. In the bee-house, which was quite a large room, there were cupboards, the doors of which swung down, and the hives could be pulled out, running on rollers, the door forming a table on which the hives rested during manipulation. Here was a 'Cowan' hive that M. Nicot told us with pride had given him the largest quantity of honey of any last year. It had then three stories, but had four this year. The honey-flow had only commenced a few days before; the hive was full of bees, and already honey was being stored in the third and fourth stories. There was also a very large straw hive, furnished with frames, but too unwieldy for any but a very powerful man to manipulate. English sections were ready in racks for placing on the hives, some of which were already tenanted and work well advanced, one of Abbott's hives having three racks on already.

We then took a turn in the garden, where we saw a large trunk of a tree hollowed out and fitted with Dadant frames, also a Layens hive with twenty-six frames and a super on besides. M. Nicot generally works these hives with from twenty to twenty-six frames, and often finds these insufficient during a rapid flow of honey. The Dadant hives he works with thirteen frames and two sets of supers. Here his principal harvest is from sainfoin. We were then taken indoors to taste his wine and eau-de-vie, which he had made from honey. 'Excellent' was the verdict pronounced on this species of brandy or liqueur. It is distilled from hydromel in a proper 'still,' but is very easy to make, and is found to be a profitable way of using honey that is unsaleable. After a hearty shake of the hand we left, and found it was time to return to M. Froissard's to dine. Madame Bertrand left us at Annecy and returned home, as she had had enough of bees and bee-talk, and was desirous to get back to more congenial occupations, much to our regret, as her presence greatly added to our enjoyment.

On our return to M. Froissard's we were invited into the dining-room, where we found Madame Froissard had prepared a banquet for us, to which we sat down, and were soon in deep conversation over bees and honey wines. The hostess was determined that we should not lack anything, and had provided everything with a

prodigal liberality which made us realise what Savoy hospitality meant. M. Froissard is about fifty-three years of age, but looks very much older, no doubt owing to his arduous indoor life at the prefecture, and he finds bee-keeping a pleasant relaxation. He is the author of a book called *Causeries sur la Culture des Abeilles*, the second edition of which has just made its appearance. He calls himself 'Apiculteur-vulgarisateur,' and his aim has been to popularise bee-keeping. For this he has been decorated, and is able to style himself 'Chevalier du Mérite Agricole.' This entitles him to wear a ribbon, but not a blue one. During dinner he showed us a manuscript book of apicultural statistics, which must have cost him an immense amount of time and trouble. It was beautifully written, and there were elaborate tables. This book he wished the Department of Agriculture to publish, and he was promised 2000 francs for it, but somehow the negotiations fell through, and the book still remains unpublished. It is a pity that all this valuable information should be thrown away, and we hope he may make some arrangement to have it brought out. As usual, most of the conversation was about wines and eau-de-vie. Our friends kindly did the tasting for us, but Madame Froissard was quite concerned about our refusing to be tempted by the wine. It was a little difficult to have to refuse wine everywhere, for it was the beverage of the country. Wine is the industry of the country, and as the vines have failed, owing to the ravages of phylloxera, bee-keepers are naturally turning their attention to making a substitute from honey. The thoughts of the inhabitants seem centred entirely in the production of wine, hence this subject was the usual topic of conversation. This fact was specially noticeable at meals, over which an unusually long time is taken, dinner often occupying two or more hours. Thus at these meals the conversation often turned on bees and their relation to the national trade, bee-keepers being most anxious to introduce honey and make it to some extent replace wine. Soon after ten the repast was over, and we left our hospitable friends and returned to our hotel and to bed.

Next morning we took leave of Annecy and took the train to the next station, Pringy, with the object of visiting Dr. and Madame Delavelaye. After a walk of about a mile, with fields of sainfoin on either side of us, and orchards of apple and pear trees here and there, we arrived at the residence, and soon introduced ourselves to Madame Delavelaye, who was the bee-keeper. She took us to her apiary, and sent for the Doctor, who soon joined us. We found Madame most enthusiastic, and she had fifteen Layens hives in splendid working order. She had been very successful, and did all the work herself—not very easy work for a lady, considering the size of the frames. We were shown a hive which last year had twenty frames and two supers. The garden is on the side of a hill, and the hives are placed in different positions

amongst the flowers and vegetables. We were pleased to find a lot of good old-fashioned herbaceous plants in bloom, and the ground was so neatly kept that the gardeners here were evidently not afraid of working amongst the bees. There were some skeps under cover, which we were told were kept for the purpose of providing queens for hives requiring them. In the house a spacious room is provided for extracting and storing combs. After a short but pleasant visit, Dr. Delavelaye drove us over to Metz, to see Monsieur Durrant, who is the mayor of this place. The carriage in which we travelled was one peculiar to the country. The seats were arranged somewhat like those in an Irish jaunting car, only not quite so high, and there are four wheels. Most convenient are these seats for botanising, as it is easy to step off the board on to the road while the carriage is going, and just us easy to step up again. M. Durrant gave us a welcome, and we were at once conducted to the apiary. There were some twenty-five hives arranged at right angles to each other, one row being under trees, and quite in the shade. They were mostly of the Layens type, and M. Durrant assured us those under the trees did better than the others. He thought the bees in the shade did not fly out so soon in the spring, and therefore did not perish like the others, and none of them gave any swarms. Last year M. Durrant was obliged to put a Layens on the top of another such hive, and the upper one was completely filled with honey. The district is a marvellous one for honey, and they never have a bad year, as there is a succession of harvests, and if one fails others succeed. The fruit-trees we saw gave the first honey, and then came sainfoin and sage, limes, &c. Several hives were examined, and a photograph of M. Durrant inspecting a frame was taken. The view from the terrace was very fine, and the red fields in all directions made us feel that such a country could with difficulty be overstocked, and that how very small the proportion of hives kept was to the pasturage available. Several hundred hives in such a district would not be too many. We were then invited to lunch, after which M. Durrant drove us to the station, whence we took the train to Rumilly. Stopping at Ancey, our luggage had to be passed through the Customs, although it was only a few miles out of Ancey that we had journeyed.

Near Lovergny we passed the Gorges du Fier, which we were strongly advised to visit, but we found our time limited, and preferred to pass on to Rumilly, where our friend, M. Mermey, met us at the residence of M. Collet, having come from Aix-les-Bains on his bicycle. We found M. Collet ill in bed, but when he heard that we had called, he insisted on getting up to receive us. As Madame Collet did not think he would be any the worse for it, we consented to stay. After a short interval, M. Collet joined us, and we found him a very intelligent gentleman. He is what is called an *agent-voyer*, or road-surveyor for the district,

and gets about a great deal. He has some forest property on the hills, and is going to establish an apiary there, so that the bees may take advantage of the mountain pasturage, as well as the sainfoin in the lower parts of the valley. He had eight Dadant hives, all in good condition. These were placed along the side of the garden path and stood one in front of the other. This district was also a good one, and honey most abundant. A little refreshment, and then M. Collet drove us to see the apiary that M. Mermey had just outside the town, this gentleman accompanying us on his wheel-horse. We had particularly wished to see this apiary, as M. Mermey had cured a hive of foul brood some time before, and we wanted to examine this hive for ourselves. The apiary, which consists of twelve hives, is prettily situated on the sloping fields of the valley, with a picturesque range of mountains opposite. It is in the middle of a field of sainfoin, and this was to be seen on all sides, and as far as the eye could reach. By the side of the apiary was a gravel-pit, in which was quite a forest of willow and other trees, and M. Mermey intended to put some hives amongst these trees. It was here that his bees got their early pollen and a little honey. One or two hives were examined, and we left the one that had had foul brood until last. This was carefully examined, every comb being taken out, and both sides scrutinised by five pairs of keen eyes, eager to detect if there had been any failure in the cure. We came unanimously to the conclusion that the cure had succeeded perfectly. This hive had been obtained from a confraternity, the brothers declining to take the necessary steps for curing the disease, so M. Mermey thought he would try his hand.

He gave them naphthaline, which he placed on the floor-board. On the next day a handful of dead bees and diseased brood was thrown out of the hive. He then gave them eucalyptus in the syrup for a short time, with the result that when we visited the hive it was perfectly healthy. The cure was made under the most favourable conditions, and as the bees were rapidly filling their hives with honey, it was most likely to be a permanent cure. While talking of the effect of naphthaline, M. Collet told us that if the hands are damp and naphthaline is rubbed on them it effectually prevents the bees stinging. M. Mermey finds this such a good neighbourhood for bees that he intends extending his apiary. A photograph of the apiary with sainfoin in full bloom was here taken, and then M. Collet drove us back into the town to our hotel, as we intended to stay the night here and go up over the mountains the next day, to see some peasant proprietors in Massingy.

Next morning an early start was made in a carriage, our destination being Massingy. A couple of hours' steady drive uphill—with an occasional walk to stretch our legs and relieve the horse—through beautiful scenery, brought us to the village.

(To be continued.)

LEICESTERSHIRE B. K. ASSOCIATION.

The annual general meeting of the members of this Association was held in the Old Town Hall, Leicester, on Saturday, March 7th, when the officers for the ensuing year were elected, and questions of government discussed and resolved upon. The Rev. M. A. Thompson (Thistleton) was voted to the chair. There was a fair attendance. The report and statement of accounts, having been printed and circulated among the members, was taken as read. The total receipts for the year amounted to 42*l.* 14*s.* 1½*d.*, including a grant of 10*l.* from the Leicester Agricultural Society, and three guineas from the Horticultural Society. After meeting all liabilities, there was a balance in hand of 5*l.* 2*s.* 9½*d.*

Mr. W. P. Meadows then addressed the meeting on the subject of bee-keeping. He spoke very strongly concerning certain statements which he said had appeared in a local contemporary as to the existence of 'foul brood' in the county, characterising the allegations as being 'abominable falsehoods' and 'a scandal on the profession.' A discussion followed.

In proposing the re-election of Mr. H. M. Riley, of Tower House, Leicester, as Secretary, and that he be also Treasurer, Mr. Meadows said the Society had never stood so well as it did now, and its position was the best testimony to the hard and efficient work which their Secretary had done. Mr. Riley was unanimously re-elected.

The meeting next proceeded to the election of officers for the year, a strong and influential Committee being appointed. Mr. Meadows was thanked for his address, and a similar compliment having been extended to the chairman for presiding, the proceedings terminated.

Correspondence.

The Editors do not hold themselves responsible for the opinions expressed by correspondents. No notice will be taken of anonymous communications, and correspondents are requested to write on one side of the paper only, and give their real names and addresses, not necessarily for publication, but as a guarantee of good faith. Illustrations should be drawn on separate pieces of paper.

Communications relating to the literary department, reports of Associations, Shows, Meetings, Echoes, Queries, Books for Review, &c., must be addressed only to 'The Editors of the "British Bee Journal," 17 King William Street, Strand, London, W.C.' All business communications relating to Advertisements, &c., must be addressed to Mr. J. HUCKLE, Kings Langley, Herts (see 1st page of Advertisements.)

** * * In order to facilitate reference, Correspondents, when speaking of any letter or query previously inserted, will oblige by mentioning the number of the letter, as well as the page on which it appears.*

BEE-KEEPING AND TECHNICAL EDUCATION.

[588.] All interested in bee-keeping must wish Mr. Meggy every success in his application to the Essex County Council, and I trust he will report as early as possible what success he meets with.

Each county stands by itself with respect to the uses the fund at its command is put to, but

so far as Lancashire is concerned, I fancy the money will be distributed as *grants in aid* to assist local efforts. None will be given to pay initial expenses. As the Lancashire and Cheshire Bee-keepers' Association do not confine themselves to one county, they will be unable to obtain a grant.

It must be borne in mind that the present and future Chancellors of the Exchequer are not bound to provide these funds in the future, consequently whatever move is made towards giving technical education in bee-keeping should be done in such a way that the work could be continued even though the county grants were withdrawn.

To my mind, nothing that can usually be done on a show-ground in a bee-tent could come under the category of technical education. The question then arises, what can? And I would submit that if an apiary was established in the most favourable situation for the bees in every county, any one might go to study the practical working of an apiary on similar conditions to what pupils now go to study cheese-making at the Bath and West of England Society's School at Wells, in Somersetshire, or the Kilmarnock Dairy School, where both butter and cheese-making are taught.

These aparies, I take it, would have to be established, and certified practical bee-masters placed over them by County Associations, or from moneys raised by public subscription; then grants in aid would come in from the counties to pay the experts, or the fees of those pupils who could not afford to pay all the charges consequent on their attending at the apiary.

By these means I believe an old industry might be revived, and many a family made happier and better off; but writing from a manufacturing district, I cannot shut my eyes to the fact that there are many districts in which bees cannot be kept with success, as pure air and more than one kind of good pasturage in the year are necessary adjuncts to profitable bee-keeping.—WM. LEES McCLEURE, *The Lathams, Prescot, March 21st, 1891.*

BEE AND HONEY SHOWS.

[589.] As the advertisements for the 'Royal' Show are to the fore and other shows will soon follow suit, I should like to call attention to what I and others consider a very great mistake in the management of the bee-tent and honey shows. It is this. They are never ready for *hours* after the specified time. I went purposely on the half-crown days to the Yorkshire Show at Hull, the Lincolnshire at Louth (the same year), and again to the Lincolnshire at Boston last summer, only to be disappointed at each of them. If there is not time to judge and arrange all by ten or eleven o'clock, as the case may be, why cannot the honey, hives, and appliances be there and judged on the first day? It appears to me the best part of the busiest day is taken up arranging and judging (for many things both at Hull and Boston were not even

unpacked at the time they were put down in catalogue as being ready for show), consequently it is only the people on the third and 'rush' day who really see all to advantage. This is unsatisfactory and wrong. I heard many complaints from people who, like myself, had gone purposely for the bees, or rather the honey and appliances, and they were the things most difficult to see. If the subject were thoroughly discussed in your columns, I think whoever manages these matters would see their error and try to obviate so much disappointment.—*BEZ-KAX.*

[Our correspondent will find official regulations very strictly adhered to at shows of the Royal Agricultural Society. Referring to the one show of the three specially mentioned of which we have cognisance, viz., that at Boston, the official programme is before us and the honey, &c., exhibition is there announced to open at 12.30, on Thursday, July 24th. We can personally state that that arrangement was adhered to, from the fact of being present in an official capacity at the time.—*EDS.*]

NOTES BY THE WAY.

[590.] The weather since I wrote last week has continued cold and dull, large quantities of snow still lie in all directions, and some of the village roads continue blocked for vehicular traffic, the tradesmen having to make detours by the way of the fields. Only once during the past week have the bees been able to fly, and on that occasion only for about two hours, viz., on Monday, the 16th. It seems hardly-credible that we are at the end of March, that when the next number of *B.B.J.* appears it will be April. This ought to remind us to set our apiaries in order for the honey harvest, which will be here before we are ready for it if we are lulled into forgetfulness by the continuation of wintery weather so late into the spring.

Feed the bees, also provide artificial pollen for them for a few days until the palm is in bloom, or some other natural source is open from which the bees can gather a supply. Soft candy is the best food to give for the present, as the cake of candy can be covered with the wraps and cushions, thus keeping all snug and warm. This conservation of the heat of the colony will be a means tending to produce a rousing colony of bees ready for the first flow of honey in sunny June. Sections that have been kept in a dry room require laying on a damp brick floor a few hours before folding; or, if turned on edge a lot together, then with an oil-can, or anything that will pour a very fine stream of water out of its spout, a little hot water is poured into the grooves. This will toughen the wood, so that the sections can be folded with very few breakages.

Clipping Queens' Wings.—I notice a correspondent last week inquiring on this subject. I have never practised this, but have read of many American bee-keepers who have done so; but I believe the practice is dying out in

America—very few of their progressive bee-men are doing it now. It can only be adopted with any degree of success by those who have their hives resting on the ground or on very low plinths, as the clipped queen is unable to fly, and the idea is, with the hives placed on the ground, that if the bee-keeper is not at hand, the queen can crawl back into the hive. I think the principal reason why queens were clipped was to prevent swarms taking flight to the woods, and so proving a serious loss to the bee-keeper, rather than as a means to prevent swarming altogether.

I hope those bee-keepers who used the various swarm-catchers or self-hivers last season will give us the result of the trial, so that others may, by seeing the success or failure of the different patterns, know which is the best pattern or make that will accomplish the desired result. Please, friends, do not think we older hands in the craft wish to 'sit on' young beginners, or that we have no patience to listen to suggestions, or fads, if you like to call them by that name. Remember we have not reached the *ne plus ultra* in bee-keeping yet; therefore, I say, give us the benefit of your ideas, give us the chance of telling you (if we can) if your new-to-you ideas have been tried before, thereby saving yourselves the trouble and loss of time requisite to try them; or, on the other hand, the interchange of ideas through our *Journal* may start other minds thinking and planning out on the same line of thought. This may lead on to perfection, even though the ideas at first may not appear to contain any potential force.—*W. WOODLEY, World's End, Newbury.*

PROPOSED CONFERENCE OF BEE-KEEPERS AT THE 'ROYAL' SHOW.

[591.] Referring to the suggestion made in the last paragraph of 583 (p. 129), I would say the same idea had occurred to me, and if such a meeting could be arranged it would undoubtedly be a success. Many northern bee-keepers, unable to attend meetings held in London on account of the distance, would embrace the opportunity of meeting at the 'Royal' at Doncaster. Personally, it would be a pleasure to see and hear such bee-keepers as our Editors, Messrs. Blow, Grimshaw, Howard, Woodley, and others who might be named, and many would, no doubt, be as highly delighted to attend as myself.

Anent 'X-Tractor's' 'bee-whisper' *re* the dearth of beeswax, one of our leading foundation manufacturers writes: 'I fear foundation will go to a bigger price ere the season is out, as real beeswax is very scarce, and money won't buy it soon;' so I shall take 'X-Tractor's' advice. During the past season I had many sections spoilt through unwelcome queen-visits; had H.M. been compelled to remain in her own domains, whole crates might have been finished early in the season. As it was, when the brood

had hatched out, the honey had hatched out also, and I had the enjoyable (?) task of taking off empty sections. 'Excluding honey-boards' will be the rule between surplus and brood chambers during the coming season with—A. WOODHEAD, *Goole, Yorks.*

CURIOUS WINTERING RESULTS.

[592.] Referring to your footnote to No. 575 (p. 115), I used both porous and non-porous coverings. The cast which stood the winter had a porous quilt, so had the other hive (No. 41), in which nearly all the bees have died, while the best stock I have at the present time has a non-porous covering.

I have kept bees over twenty years and have generally wintered them successfully, sometimes not losing one out of nearly fifty stocks, but they were natives, whilst this year they are Carniolans. I don't think either bees, stores, or quilts had anything to do with it. I consider the severity of the weather was the chief cause; such a trying time was unknown before, nearly ten weeks without sun, odd days of thaw followed by frost again at night, and foggy days with the glass at zero.—ALPHA.

[If the severe weather was the cause of the heavy mortality, and management had no influence on the result, how are we to account for the bees of so many of our readers coming through the same season so well? This is the point for our correspondent to consider.—EDS.]

THIN SINGLE-WALLED HIVES.

[593.] In answer to Mr. Woodley, will you allow me to state that all the covers I used this last winter were Simmins' pattern, of three-quarter-inch wood, but I have often used other shapes of half-inch only? I use porous quilts, three thicknesses of house-flannel and one of ticking—generally only one, but I have used two the last two winters, simply because I had them by me. I make no provision for bees reaching outside combs. My experience proves, at all events to my own satisfaction, that if bees are as strong as they ought to be in the autumn they will keep a seven-frame space warm and dry in the winter.

I have never advocated more than seven frames to winter on, and if any one has tried experiments with hives of different substances, giving perhaps ten frames to all, I have no doubt the double-walls might come out the best in the spring.—ARTHUR J. H. WOOD, *Bellwood, Ripon, March 21st.*

COLOURED PLATES OF BEES.

[594] What about the coloured plates mentioned in the *Journal* some months ago? Are we likely to get any? I think the way to make sure whether it would be worth your trouble in getting them up would be for every one intending to take copies to let you know the number they

wanted. To begin with, I will take half-a-dozen copies for some friends here and myself.—J. M., *Glasgow.*

[The amount of interest taken in the subject referred to has not been sufficient to justify us in incurring the expense, which, to do the thing really well, would not be inconsiderable.—EDS.]

WILLESDEN CARD FOR HIVE ROOFS.

[595.] I am surprised at never seeing 'Willessden card' recommended in *B. B. J.* for covering roofs. Galvanised iron and zinc I found warped with the heat, and open the nails, and so let in wet. I began to use the Willessden card quite six years ago, and after testing its value reported it to *B. B. J.*, and have always recommended it to any who consulted me. I use the 'four-ply' quality. It is the cheapest and lightest thing out, and most easily applied. After one season I paint two or three coats, and then it will last three or four more at least. Before using soak it in water, or sponge it well both sides, to soften it. Cut it one inch larger *all round* than the roof, *turn the edges under the eaves* (this is *most important*), and nail with $\frac{3}{4}$ -inch tin-tacks, two inches apart.

As I am writing, may I also call attention (as I did two or three years ago) to the use of *vaseline* in frame hives, rubbed round the bottoms of section crates, ends of dummies, shoulders of frames, &c.? All propolisation is avoided, and so crates, &c., can be removed without the least jar or disturbance. It was Mr. Abbott, jun., who put me up to this dodge.—W. E. BURKITT, *Hon. Sec. and Expert, Wilts B. K. A., March 7th, 1891.*

A YEAR'S EXPERIENCE OF BEES.

[596.] Perhaps it may interest some readers who are not already bee-keepers to have a brief account of my first year's experience with bees. I commenced last spring by undertaking the care of three stocks for an aged widowed relative. The bees were in wooden hives about twelve inches square. Fortunately, a friend lent me a copy of your *Journal*, which I have taken regularly ever since, and I determined to go into my new line of business by making a fair start with hives of modern size and style and the latest appliances. I also got some publications, including Cowan's *Guide-book*, and thus fortified, I began work in earnest.

I found two of the three stocks weak, and though I fed them through the spring, one of the two weak lots died, and the other did not swarm. The third, however, swarmed twice, both swarms being hived on foundation in new standard frame hives, and fed as directed. After twenty-one days my friend drove the bees from the parent hive, thus forming a third new colony, and after watching the operation I drove the unswarmed old stock myself, making up my number to five.

They were then sent to the heather, and how

they worked! They soon added 130 lbs. to what they had. The first swarm filled ten standard frames and seven sections. I only took one frame of honey from each stock, leaving seven combs of honey to every colony when arranging them for winter. The hives are double-walled, frames parallel to entrance, and coverings were made non-porous by using American cloth, glazed side down, and four thicknesses of warm felt covering over this.

On February 5th last, I examined and found all perfectly dry, no moisture, bees very strong. I moved full frames of honey close to the cluster. The top swarm, though strongest in autumn, had lost most bees, the others losing about equal. All seem very healthy, and each stock has fully fifteen pounds of stores still left. So I am not troubling about feeding, and hope with care they will do well.

I eagerly scan the *Journal* each week, and am surprised how patient you are with us amateurs and all our bee-troubles. I use a veil and armlets, as advised by you, and rarely get stung, even on my hands.—Wm. BARKER, *Hutton Rudby*.

METAL ENDS.

[597.] Might I suggest that the 'W. B. C.' metal ends should be procurable in zinc as well as tin? I know there would be a demand for them. Personally, I would never use tin for any purpose about an apiary.—ARTHUR J. H. WOOD, *Bellwood, Ripon*.

HARDINESS OF BEES.

[598.] As the question of Single v. Double-walled Hives is now being considered in your valuable paper, perhaps the following instance of bees surviving the late severe weather under very unfavourable circumstances may not be uninteresting.

When in a cottage-garden near Epping last week, the writer noticed a dirty wooden box fixed on a rude stand, and having for a roof an old battered tea-tray kept in its place by some heavy stones; and on inquiring whether it was a beehive, the owner replied in the affirmative, and I subsequently learned that two summers ago a swarm of bees settled on one of his fruit-trees, where they remained a couple of days, when he procured an old box of half-inch wood about 15 x 12 x 8, and cutting off the portion of the branch he carried the swarm and dropped the latter into the box. Since that time the bees have been left entirely to themselves, the owner being quite ignorant of their ways and requirements, and he has not even attempted to obtain any honey. Being late in the afternoon and somewhat cool, I did not see any of the bees, but was told they have often been out of late.

On asking whether the bees were being fed I caused a little astonishment, as the owner was entirely ignorant that such a thing could be done; so the bees doubtless laid up ample stores last season, which are not yet exhausted.

Since stocks are sometimes lost in winter even in well-conducted apiaries, is not the above a remarkable instance of bees being left severely alone, without any protection from the weather, and still being able to survive such a winter as we have just passed through?

Having offered to buy the stock referred to above, provided it is found to be strong, I will be glad to know—not having had much experience at present in bee-keeping—the best way of judging as to its strength and also as to proving the existence of a queen, as well as the most suitable time to remove them, and whether they should be taken away as they now stand or first driven into a skep. I may mention that the box above alluded to was quite empty when used, and is, therefore, really equivalent to a skep. Any advice as to the removal of the bees will be much appreciated.—E. H. A., *Wormley, Herts*.

[If you can take advantage of a fine warm day during the next few weeks it will not be at all difficult to estimate the relative value of the stock by observing the way in which the bees work, and what amount of pollen-gathering is being done. Besides, you could, after giving a puff or two of smoke in at the entrance, turn the box up and see how many combs are covered by bees. Supposing it is decided to purchase the stock as it stands, we should strongly advise you not to drive the bees at all, but push them forward to swarm early, make a new colony of the swarm, and when the second swarm comes off return it to the box, leaving it there till twenty-one days after the issue of the first swarm, when the bees and combs may be transferred to a frame hive and the box broken up.—Eps.]

WINTERING BEES.

[599.] I have lost during the winter eight hives out of thirty; four were good stocks and four were nuclei, or single lots of driven bees. I wintered my bees in about five different ways, to endeavour to discover the best plan of wintering. Only one hive died from want of food, and this hive was a nucleus. All the other hives had plenty of food, either above them or to the right or left of them. But it appears to me that when the temperature of the hive is below a certain point the bees are incapable of moving even a few inches; for two of the lots of bees which died had each a five-framed super full of honey right above them, yet the bees were incapable of ascending to the combs above. I am inclined to think that Hill's device, and all similar devices, are quite useless unless hives are kept very warm, and then they are unnecessary. In my opinion, the two chief necessities for successfully wintering average hives are three inches of honey on each side of each comb, and plenty of non-conducting material over and around the hives. Some of my hives have a quarter-inch space all over the combs, but this did not prevent seams of bees from dying as soon as they had finished the food near them.

All my hives are double-walled, with one and a half inch air-space between the hive, and half-inch casing. I gave up single-walled hives, because they take too long to work, and I am sure double-walled hives are the best. Late feeding did not kill my bees, as I only used six pounds of food last autumn, and that was given to one hive.—R. T. S., *Rockford*.

NATIVE BEES *VERSUS* FOREIGNERS.

[600.] I should like to give my experience of the above, and here it is:—Last spring I purchased three stocks on five bars each; one of blacks, one of Ligurian hybrids, and one Cyprian hybrids. I worked them in longitudinal hives up to thirteen frames each, then put on sections. The result was as follows:—Blacks gave me forty-four pounds of surplus, and the bees had plenty for winter; the Ligurians wanted twenty pounds of sugar, but gave a fine swarm; Cyprians no honey, no swarm, but hundreds of stings! so I killed queen and requeened with black.—A BEE-FEVERISH COACHMAN, *Bath*.

'A VAGABOND SWARM.'

[601.] On Friday, February 27th, about 1.30 p.m., a neighbour came to me with the report that he had a swarm of bees in his garden. I went with him, and found a very small swarm (less than a pint of bees). They were settling on the hedge. I examined them and found the queen. As I had a queenless lot at home I caught her, and at once put her in a cage and gave her to them. To-day (Saturday) I have let her out, and the bees at once fed her, so I conclude she is all right. I took the swarm for a 'vagabond' one, but do you think it probable that it was an unfertile queen flying out and followed by some workers? Of course, time will show, but she was quite a normal size and shape. I should be glad of your opinion on the above point. I should not have troubled you with this, but even a vagabond swarm in February is unprecedented in my experience.

I have wintered sixteen lots and have not lost one, and all have queens laying but the one above mentioned. Fifteen are in double-walled hives (Cowan pattern), and one in a single-walled hive, but with dummies on both sides. They were wintered on honey and syrup in about equal proportions, porous coverings, and no winter passages. I have kept bees six years, and have never lost a hive or cut a winter passage. Plenty of food and keep them warm and dry is my plan.

In spite of the severe weather I have never had my bees look so promising, many having two or three frames of brood already.—J. T. AMBROSE, *Chilton, Bucks.*

[Swarms, in the proper acceptance of the term, never issue in February, so we may safely say it was a 'hunger swarm.'—Eds.]

AN EARLY QUEEN-WASP.

[602.] Referring to No. 543 (p. 68), on January 23rd I was stripping the reed from a stack of beans in the straw-yard, and on the north side of the stack, I found a queen-wasp in the reed and alive. It began to move rather fast and as I thought it was going to take wing I killed it. How it could have lived in such a place and such a winter I cannot think, as the reed was less than two inches thick.—T. P., *Streethayne, Devon*.

PREPARING BEE-FOOD.

[603.] Seeing in *B. B. J.* that so many hives are dying in an unaccountable way, with plenty of food in store, might it not be well to ascertain in what sort of vessel the food was cooked, and what was cooked in it previous to the bees' food?—JAMES SADDLER, *Forfar*.

Queries and Replies.

[332.] *Wax Extracting.*—There seem to be helpful and useful hints given about most bee-work, with the one exception of wax and wax-melting. For a small apiary a wax-smelter is expensive and not necessary; so in my own interests and those of other small bee-keepers, I should like to ask for some information, which must be simple, efficacious, and practicable. I think, from your many and kind readers, some one will help me with this little difficulty; and to any such I should be grateful. I want to know the best way to clean the wax thoroughly after being well washed; then how to melt it; and lastly, the best sort of things or shapes to let it cool in. If you leave a pound or so, when melted, is it best to sell it, or to get some appliance dealer to make it into sheet comb for you?—BEE KAY.

REPLY.—So many homely ways of extracting wax from comb will suggest themselves to those with only a pound of wax to deal with that it seems scarcely worth treating at length on the various plan to be followed, and so from the many methods which from time to time appeared in our pages we reprint the following as a sample:—In the first place get a tin biscuit-box which is water-tight, and a piece of wire gauze of such size that when the tin box is placed thereon there shall be a margin all round of three inches. Now make four cuts in the gauze parallel to the sides, $3\frac{1}{2}$ inches from each of the sides, and $3\frac{1}{2}$ inches long. Turn up the gauze all round, thus making a tray $3\frac{1}{2}$ inches deep, and 1 inch smaller each way than the box. Hang this tray in the box, pour an inch or so of hot water into the bottom, place the combs to be melted in the tray, put on the cover of the box, and set the whole apparatus in the oven or on the stove. The heated steam rising through the comb will melt the wax out of it, which will

fall into the water, from which, when cold, a solid cake of wax may be lifted.' The oftener it is remelted in clear water the cleaner the wax will be. For moulds anything suitable may be used—patty-tins, saucers, &c., according to taste. Bee-keepers with a pound of wax to deal with will act wisely by selling it and buying foundation with the proceeds.

[333.] *Abnormal Drones.*—I enclose herewith two drones brought out of one of my hives yesterday. The bees were driven from two straw skeeps last autumn, and hived on full sheets of foundation. As it is so very early in the season I should like to have your explanation of what appears such an unusual circumstance. I would add that I opened the hive about three weeks since and found patches of brood in two or three frames, and have seen young 'workers' on the alighting-board this season, thus showing that there is a laying fertilised queen in the hive. Do you think the drones are from her eggs, or is there any fear of there being a fertile worker also in the hive? There has been about a foot of snow on the ground lately, but throughout the whole of February the weather was quite spring-like. My four stocks of bees all had brood the early part of the month, and the consumption of stores for winter was much less than I anticipated. Wishing every success to the *B.J.*, and thanking you for many useful hints gained from it,—A. M., *Newton Abbot, Devon.*

REPLY.—The drones sent have the appearance of being hatched from elongated worker-cells, while the distorted and imperfect wings indicate a sparse population in the brood nest. Examine the combs and see (a) if the brood is scattered in irregular patches; (b) if the drones are hatching from worker-cells; (c) if any worker-brood is hatching; and (d) if the bees are at all numerous. You will soon clear up any uncertainty regarding the queen by so doing.

[334.] *Shallow Frames for Extracting.*—I have had made eight shallow boxes for extracted honey, $14\frac{1}{2} \times 14\frac{1}{2} \times 6$ in. inside measure, thinking they would hold ten of Lee's patent shallow frames, but I find when the foundation is fixed the box is a quarter of an inch too small to hold ten frames. Should I make small pieces of wood to slip between each frame, and so make nine frames fill up the space, or shave a bit off the insides of the boxes to make them hold ten frames?—ANXIOUS, *Woodford, near Thrapston.*

REPLY.—Use the slips of wood between the metal ends on each frame, so that nine may fill up the box.

[335.] *Size of Standard Frames.*—1. Is it a fact that some years ago the top bar of the standard frame was $\frac{3}{8}$ in. thick, the ends $\frac{1}{4}$ in., and the bottom $\frac{1}{2}$ in.? Do those proportions exist still? If not, what are they now? 2. What breadth and thickness of top bar are the 'W.B.C.' and Howard's metal ends respectively made for? 3. Are the different parts of shallow frames for extracting made the same breadth

and thickness as Association frames? 4. Do shallow frames require wiring? 5. The best-made frames are liable to twist out of square, thereby bringing one part of the lower end nearer to the hive side than the other; in view of which would you recommend the hive to be a $\frac{1}{4}$ in. more than the regulation $14\frac{1}{2}$ in.? If so it would materially assist the manipulator to withdraw or return a comb without crushing or hurting the worker-bees or queen.—NORTH WEXFORD.

REPLY.—1. The size of 'standard' frames has never been altered. Your measurements are correct so far as they go, the width of top bar being $\frac{3}{8}$ in.; length, 17 in.; and the outside measure of rectangle $14 \times 8\frac{1}{2}$. 2. 'W.B.C.' ends are made for both $\frac{3}{8}$ in. and $\frac{1}{2}$ in. top bars. 'Howard's' for $\frac{3}{8}$ in. only. 3. Yes. 4. No. 5. The extra width you propose to allow will not assist the manipulator one bit, for the bees would simply lengthen out the cells of the outer combs to regulation distance from the hive side, viz., $\frac{1}{4}$ in.

[336.] *Foul Brood and Comb Foundation.*—Can you oblige an old subscriber by saying:—1. Are the germs of foul brood destroyed by melting down the combs in a Girster's wax extractor? 2. Is wax so extracted fit for comb foundation? 3. Have you known foul brood to emanate from foundation bought in the usual way? 4. Have you put some combs out of a foul-broody hive away all the winter with a lot of clean ones that I extracted honey from in the autumn. What is the best thing to do with the whole of them? I have looked through *Journals* for years back, but cannot come across the answers required.—P. W. C.

REPLY.—1. To make assurance doubly sure fumigate the combs with sulphur fumes before melting down. 2. Yes, if the foregoing precaution is followed. 3. No; but for all that we should not care to use foundation made from foul-broody wax. 4. Fumigate with sulphur or spray with salicylic acid solution.

MEADOWS' NEW REGISTERED FRAME.

Mr. W. P. Meadows (Syston) forwards a sample of this newest form of frame in the market. The sketch given by the manufacturer in our advertisement columns conveys so clearly the idea of the invention, that detailed description is unnecessary beyond saying that the new features in the frame fully answer the purpose intended. The foundation is fixed very rapidly, and when fixed it is quite firm. Many bee-keepers will no doubt adopt it because of its removing the (to many) objectionable lodging-place for the wax-moth larvæ afforded by the saw-cut in upper side of top bars. We shall give a personal trial of the frame this spring, and will report results. The 'paper-clip' is a very simple arrangement for keeping the lower edge of foundation in line with bottom bar.

Echoes from the Hives.

Brigg, North Lincolnshire, March 10th.—After passing through a very severe winter, I have wintered twenty-one stocks with the loss of one, which succumbed through insufficient food. Some of my hives have porous quilts, others non-porous. In double and single-walled hives, some have six or seven seams of bees, with brood in centre frame. Those in single-walled hives seem as strong as any at present, but I shall transfer them into double-walled ones before breeding is fully commenced. I consider bees do better in them during the changeable weather in the early season, although I believe a strong stock will winter equally as well in single-walled hive with dry wraps and plenty of food. Among bee-keepers about here who have attended to their stocks losses have been small, but the long winter has told on neglected colonies. As the county show is held here this year I hope bee-keepers and members of the Association will do their best for the bee-department, and that our Association may be well represented.—GEORGE W. EDLINGTON, *District Hon. Sec. L.B.K.A.*

Notices to Correspondents and Inquirers.

R. WILLIAMS (Cinderford).—The very small pieces of comb sent contain nothing but food and pollen and a couple of adult bees. There is no trace of foul brood. To judge fairly, however, a piece of comb should be forwarded with dead brood in it. Is it not probable the bees have been suffocated, since entrance was blocked for twenty-four hours?

ROBT. DE B. SAUNDERSON.—Comb sent is foul-broody.

J. R. TRUSS.—The honey is a good sample, but has no trace of pine-apple flavour.

W. B. WRIGHT.—The sample, in our opinion, is best sugar, and unsuitable for bee-food.

'SUBSCRIBER' (Cork).—Comb sent contains only dried brood; chilled in the first instance probably, but, though no actual foul brood is present, it would be dangerous to use them. We should melt them down for wax.

THOMAS VENN (Coventry).—*Confining Bees from Snow.*—It is a dangerous practice to confine bees to their hives while snow is on the ground. Apart from this, your wintering arrangements are very good, and we are glad your bees have come through so well.

CONSTANT READER (Kingussie, N.B.)—The candy is not to our mind. Samples sent us made from naphthol obtained from this office are as nearly as possible flavourless, while in yours it is marked, and will probably be objectionable to the bees. The candy is also too hard.

THE DEPOSIT SYSTEM.

British Bee Journal and Bee-keepers' Record.

OFFICE: KINGS LANGLEY, HERTS; AND
17 KING WILLIAM STREET, STRAND, LONDON, W.C.

The following are the Rules under which we are prepared to receive Sums of Money on Deposit from persons buying and selling goods.

In order to save trouble it is requested that the Rules be carefully read over by persons using the Deposit System of trading.

DEPOSITING.

1. Method.—When strangers are dealing together, the purchase-money of the articles is deposited at our office. We acknowledge receipt of the deposit to both parties, and hold the money until we are satisfied that the purchase is concluded. If a sale be effected, we remit to the seller the amount deposited, less a charge of 6d. and the expenses of Post Office Orders and postage, &c. Cash will be forwarded by cheque, Post Office Order, or by Postal Order as preferred. If a sale or exchange be not completed, we return the amount deposited, after making the same deduction. By this means buyers and sellers are secured from fraud.

2. Deposits.—Postal Orders (drawn on General Post Office) and Cheques must be made payable to John Huckle, and crossed 'Bucks and Oxon Bank.' The numbers of the Postal Orders should be kept by the sender. We cannot be responsible for any losses that may occur in transit.

3. Honey on Approval.—All honey will be sold by sample, which must be sent direct to buyer.

4. Bee-appliances.—In ordering, the time allowed for completing the order to be stated to us when sending cash. If maker accepts, we hold cash till transaction is satisfactorily completed, when the amount will be remitted subject to conditions as in Clause 1.

5. Bees and Queens.—These will be dealt with entirely by the parties concerned, so far as price, &c., goes, and when the purchase is satisfactorily completed cash will be remitted as per Clause 1.

6. Goods in Transit.—These are at the seller's risk, i.e., any damage to or loss of an article on its journey is borne by the vendor; but a rejected article must be properly packed and returned by the same means as was used in sending it.

7. Carriage.—The carriage of all goods, *except such as are sent by post*, is payable by the buyer, unless otherwise agreed. If any article sent on approval be returned, each party to the transaction must pay carriage one way.

Tenth Edition. Nineteenth Thousand.

BEE-KEEPERS' GUIDE BOOK. Containing Management of Bees in Modern Moveable Comb Hives, and the Use of the Extractor. By THOS. WM. COWAN, F.G.S., F.R.M.S., &c. With numerous Illustrations. Fcap. 8vo., price 1s. 6d.; or in cloth gilt, 2s. 6d. Postage 2d. To be had of HOULSTON & SONS, Paternoster Square, all Hive Dealers, Secretaries to Bee-keepers' Associations, and of J. HUCKLE, *British Bee Journal Office*, Kings Langley, Herts.

BEE-KEEPING, its Excellence and Advantages. Price 3d. *British Bee Journal Office*, Kings Langley, Herts, and 17 King William Street, Strand, London, W.C.

JUDGING HONEY. By the Rev. J. L. SEAGER. Price 3d.

DIAGRAMS ILLUSTRATING BEE-CULTURE and the Relation of Bees to Flowers. Drawn by FRANK R. CHESHIRE, F.R.M.S. Approved and recommended by the Science and Art Department. 4s. per set.

JOHN HUCKLE, Kings Langley, Herts.

* * Several letters, &c., are unavoidably held over till next week.

THE
British Bee Journal,
BEE-KEEPERS' RECORD AND ADVISER.

No. 458. Vol. XIX. N. S. 66.]

APRIL 2, 1891.

[Published Weekly.]

Editorial, Notices, &c.

OUR PROMINENT BEE-KEEPERS.

No. 33.—RICHARD ATKINSON GRIMSHAW.

Amongst those who have been conspicuous during the later years in promoting bee-keeping

and working for its benefit is the subject of our sketch, and we are sure that our readers will be pleased to become better acquainted with Mr. R. A. Grimshaw, or as he usually signs himself, R. A. H. Grimshaw. We would, however, remark that the H in the signature is merely a *lettre de plume* adopted by our friend to prevent confusion with one (by a strange coincidence) Richard Atkinson Grimshaw, of exactly the same name in an adjoining village, but who is no relation. Mr. Grimshaw, whose portrait we present to our readers, was born at Norwich on the 3rd June, 1845, of Yorkshire parents.

At the early age of thirteen he commenced work with Messrs. John Pepper & Co., carting agents to the Great Northern Railway, and remained with them for thirteen years, during the last six of which he held the position of cashier to this firm at Liverpool. He was afterwards occupied for some years as traveller for an ironworks, until in 1877 he became associated with his brother and cousin in the manufacture of nails in Leeds, his firm of Josiah Grimshaw being second to none in the kingdom, and capable of turning

out upwards of a hundred tons of nails a-week. We have ourselves used the oval nails made by this firm, and can say from experience that there are none more suitable for hive-making. Mr. Grimshaw's schooling having terminated at so early an age and being fond of acquiring knowledge, all his spare time was devoted to reading. During the past thirteen years he has been constantly travelling for his firm between

London and Aberdeen in the prosecution of business, and he computes that he has ridden not less than a hundred thousand miles in railway carriages during that time.

Mr. Grimshaw was married in March, 1868, and has had a family of twelve children, of whom eleven are still alive. He comes of a musical family, and having a good baritone voice, he was for ten years a chorister, during five of which he assisted in Leeds Parish Church choir, finishing by being choir-master of St. Catherine's, Wakefield. He sung at three festivals as a paid singer in the choir of the famous Leeds Festival Chorus. A love of music and painting being hereditary, considerable

time was given to these hobbies, and numerous water-colours from his hand lend interest to his home.

Both of these hobbies, however, had to give way to a study of botany, which had peculiar charms for a keen lover of nature like Mr. Grimshaw. This study was chiefly prosecuted by theoretical reading in the long railway journeys, and practically supported by close observation in the botanic gardens of Kew, Edinburgh, and



RICHARD ATKINSON GRIMSHAW.

Glasgow, not omitting 'Glasnevin,' Dublin. So assiduous was he at this study, that for three years one Sunday in every month was spent in Kew Gardens, from the time it was opened until it closed, the study of orchids and tropical plants claiming most of the time. The physiology of plants also claimed his attention, and the reasons for the various parts, from simple cell to complex fructification, were carefully studied.

It is not surprising that after such careful study he should be considered fit to write for one of the leading horticultural periodicals of the day, the *Garden*, from which he had a roving commission during the years 1882 to 1885 to visit and describe such parks, noblemen's gardens and glasshouses, with their contents, as fell in his travels. These articles were frequently interspersed with others on matters of vegetable chemistry and arrangements of colour in the flower-garden, these being of such interest as to be frequently copied into the *Field* and *Gardening Illustrated*; and these questions—the colour and perfume of flowers—directed his studies towards organic chemistry and the effects of plant secretion on animal life. Being a close follower of Darwin, the transition to the work of insects amongst plants was easy, the insect enemies of plants being followed by their insect friends. It was by a happy accident that he was led to the study of bees. A son—of a kindred spirit with the father's—was in the habit of obtaining nests of humble-bees and keeping them in boxes through the season, until their number sometimes became troublesome. Mr. Grimshaw was told by a friend, if he did the lad justice he should obtain a hive of bees for him. This was no sooner said than done, and as a matter of course, with such an inquiring spirit and thirst for knowledge, fascination and bee-fever followed. These were followed by contributions to the *B.B.J.*, of which he has been a most loyal supporter ever since. In 1886 he became a member of the B. B. K. A., and has since that time been a regular attendant at the quarterly *conversaciones*. In January, 1886, he read a paper on the 'Identity of the Bee's Sting with the Ovipositor of other Insects.' He has since contributed several papers: in January, 1887, on 'The Vocal Organs of Bees,' and in July of the same year on 'The Visual Organs of Bees.' Besides several others he read one on 'Hereditry in Bees,' which he also read before the Linnæan Society. All these papers were noted for the deep thought bestowed upon them, and the arguments brought forward showed that he had acquired much more than a superficial grasp of the subjects of which he treated. Combining theory with practice, Mr. Grimshaw is certainly one of our most progressive bee-keepers.

In 1887 he invented 'apifuge,' and in the same year was appointed joint hon. secretary of the Yorkshire Bee-keepers' Association. In this work he was most assiduous, frequently giving lectures on bee-keeping in various villages of the county. In 1888 he became the hon. secretary of the Y. B. K. A., the work done since that time being the founding of district

associations, which flourish better than the parent. Secretarial work is not to Mr. Grimshaw's taste, but he prefers study, observation, and writing to the *B. B. J.*—which he calls his agreeable relaxations. The writings of Mr. Grimshaw are well known to our readers. One of his articles, namely, that on 'The Medicinal Properties of Honey,' has been reprinted in the *American B. J.*

In 1887 he joined the staff of the *B. B. J.*, and many articles have appeared from his pen. In 1889 he commenced 'Development in the Honey Bee,' which has appeared month by month up to this day. Last year he was appointed representative for his county at the Central Associations meetings. In scientific following he is distinctly Darwinian, taking, however, the theistic idea of evolution which acknowledges nothing less than the development of the divine plan in the construction of the universe. In all he is a searcher after truth, which, after all, is real science. In manner he is genial and fluent in speech, and he is rarely at a loss for an argument.

We hope that we may long have Mr. Grimshaw amongst us, and feel sure that if he continues his investigations in the manner he has done hitherto, and communicates his ideas as freely in the *B. B. J.*, we shall all be the gainers. Theory without practice, and practice without theory, do not lead to the best results even in bee-keeping; but when we find the two combined, as they are in Mr. Grimshaw, with sound common sense and indefatigable perseverance, we have the necessary qualifications for a true bee-master.

BEE-PAPERS FOR WINTER READING.

No. 6.—MOUNTING MICROSCOPIC OBJECTS.

(Continued from page 147.)

We will now direct our attention to mounting in gum-resins. Of these, those principally used are Canada balsam and gum dammar.

Insects to be mounted in these media require quite as much preparation as those specimens mounted dry, but they have the advantage of being much more permanent, and if properly prepared and carefully mounted they are practically indestructible. This cannot be said of any other method of mounting, for objects preserved in fluids frequently after a few years are valueless.

Objects may be mounted either pressed flat or without pressure. Of course, to get a correct idea and study of an organ or parts of an insect, pressure should not be used, as by it more or less distortion is caused; but there are some objects whose detail it is necessary to study, and in this case pressure is admissible. Until quite recently it was the fashion to mount only the external skeletons of insects, all the internal parts being dissolved out. These are pretty preparations, and in some cases useful, but in addition to these the same objects should be mounted without pressure for comparison.

We shall want, besides the gum-resins mentioned above, rectified turpentine, oil of cloves, alcohol, ether, and benzole.

The Canada balsam we prefer is that dissolved in benzole, and sold under the name of benzole balsam. This is the best for general use, and for mounting without heat. Where heat can be applied pure Canada balsam can be used, and in some cases balsam dissolved in chloroform is best used.

The balsam must be kept in a glass-capped bottle or jar with a glass rod in it, with which the medium can be conveyed to the object and dropped upon it. For pure balsam we use a glass syringe. It is filled by removing the plunger and pouring in the balsam from the bottle in which it came from the optician's, and when nearly full the plunger is put in the syringe. The point of this is slightly warmed over a spirit-flame, and a little pressure on the plunger forces a drop of balsam out. When not in use the point may be covered with a cork, and the syringe placed point upwards. Any air-bubbles escape at the point. There are always air-bubbles when mounting any other way with thick balsam, and we know of no method better than that of the syringe plan to avoid them.

We will now take some simple subject to mount, and cannot do better than begin with the wings.

Every part of an insect contains air, and if we were to place it direct into balsam it would be disfigured by a multitude of tiny bubbles of air which could not make their escape from the tracheæ as soon as these are closed by the viscid medium coming in contact with them. To get rid of the air we have to place the object in oil of turpentine, which not only expels all the air, but also reduces the colour of the chitine. The wings must be carefully detached from the thorax at the roots, and we can mount them either separately or the front and back wing locked together as in the act of flying. After the wing has been in the turpentine a few hours it is placed on a slip of glass and examined under the microscope. If all the air has not been removed return it to the turpentine until the object has been thoroughly permeated with this. When sufficiently clear place the wing on a clean glass slip, and with a needle remove any foreign substance that may be present. We next place it in benzole for a short time to remove excess of turpentine, and it is now ready for mounting. We next place the object in the centre of a glass slip, and with a small piece of blotting-paper take up the excess of benzole; then with the glass rod drop a little benzole balsam on the object, and taking up a well-cleaned cover glass, with the forceps place it carefully upon the object in a perfectly horizontal manner. Then carefully press down the cover with the handle of a camel's-hair pencil, very gently, so as not to displace the object. We then put on a spring mounting slip, which can be purchased at the optician's at 1s. 6d. a dozen, and is indispensable. We now set the slide on one side for a few weeks in some warm

place: the top of a cupboard in the sitting-room does very well. By this time the excess of balsam on the outer edge of the cover glass will be hard enough to remove, and it can be scraped away with a knife, and the glass cleaned by slight friction with a piece of sponge, moistened with methylated spirit. The spring clip can be dispensed with, and the slide allowed to remain to further harden for another week or two. After that it is placed on the turntable, and a coating of varnish applied, so that the ring embraces the edge of the cover and the slide, after which it may be finished with a ring of white-zinc varnish, or coloured rings, at the discretion of the mounter.

The structure of the fore and hind wings is slightly different. The inner edge of the fore wing has the membrane folded under, so as to form a sort of trough into which the hooks on the outer edge of the hind wing hook. It is very easy to put the two together under the microscope after they have been soaked in turpentine, and if only one slide is prepared, they should be shown in this position.

Several parts of the bee can be mounted in this way without any further preparation than soaking in turpentine and benzole. Thick objects will require to be soaked first in liquor potassæ for a certain length of time, depending upon whether we require only the outer skeleton or, in addition to this, the preservation of certain of the internal tissues.

Supposing we only require the outer skeleton, the object is allowed to remain in liquor potassæ until the inside is quite soft. We will, for example, take the leg of a bee. As soon as it is soft enough place it in a saucer of water, and holding down the claw end of the leg with a camel's-hair pencil with the left hand, press on to the first joint with another camel's-hair pencil, and with a rolling motion squeeze out the contents towards the upper end of the leg. As the brush is lifted, a quantity of water will take the place of the ejected contents. Then apply pressure to the next joint and so on, until there remains nothing but the chitine. If the contents do not flow out freely, it is a sign that a little more soaking is required. The object is then thoroughly washed in clean water, and left to soak in several changes of water for five to six hours. It is then placed under the microscope and cleaned.

At this stage there are two methods of proceeding: the one is to dry the object and press it out flat, or to mount it as it is, using different fluids, the one taking the place of the other in succession—for it must be remembered that oil of turpentine and benzole are not mixable in water.

In adopting the first method, we place the object on a clean glass slide, and under the microscope arrange it in such a way as to show to the best advantage the principal parts. (By reference to *The Honey Bee*, pages 33 to 37, some idea will be gained as to the principal parts to show.) When the object is properly arranged, place another glass slip on the top of

it, tie the two together with thread, or place them between a spring mounting slip, and put them on one side until quite dry. When dry, the object is removed, soaked in turpentine and benzole, and mounted as we have described for the wings.

Another way is:—After the object has been thoroughly washed, to place it in methylated spirit for a few hours and then transfer to absolute alcohol until all the moisture has been extracted. The time will vary from a few minutes to several hours, according to the size and texture of the object. It is then taken out, drained on blotting-paper, and put for a few minutes into ether. From this it is transferred into oil of cloves, on which it will at first float, but when it sinks to the bottom it can be removed and placed in rectified turpentine until sufficiently transparent, when it is put in benzole for a few minutes. It is then placed on a glass slip, arranged in position, and can be mounted in balsam as already described.

Not only legs but also the whole insect can be treated and mounted in this way. Of course, when a whole bee has to be mounted it will have to remain in liquor potassæ a very long time before all the inside can be dissolved. Also very great care will be required in squeezing out the contents not to rupture the outer skin. The inside must also be well cleaned. When the bee is sufficiently soft it is placed in water, and we begin by forcing out the contents at the end of the abdomen, and these are driven out at the anal opening. Then go higher until the abdomen is clear. It will be found necessary to replace the object in liquor potassæ for some time longer, as the thorax will be found to be very hard, and as all the contents have to pass through the *petiole*, only a very gentle pressure must be applied. When the thorax is done the head can be tackled, the contents of which may be forced out of the mouth, and lastly, the legs must be cleaned out. The object should be frequently examined under the microscope, and when thoroughly clean can be washed and soaked in changes of water for a day or two, so as to get rid of all the potash. It can then be arranged and dried, or dehydrated in alcohol and oil of cloves, as already described. From such a skeleton a number of slides can be prepared. There are the spiracles which extend on either side of the abdomen. These can be dissected and mounted separately. Then there are the abdominal rings, and the ventral plates showing the wax-pockets. One of these, neatly dissected and mounted in balsam is a very interesting object, and presents the appearance of Fig. 62 in *The Honey Bee*. The bee-keeper who is desirous of mounting parts of bees cannot do better than try to imitate the figures given in this book, most of which have been drawn from microscopic preparations.

Continued soaking in oil of turpentine, especially if this is placed in a glass vessel and exposed to full daylight, will generally make the objects sufficiently transparent, and it must be borne in mind that Canada balsam has a tendency to make the objects still more transparent. But there

are some which are so dark that they require a little bleaching—such, for instance, are the antennæ—and these can be placed for twenty-four hours in Labarraque's solution, diluted with four times its quantity of water. In using this solution it must be remembered that it has a powerful solvent action on chitine, which it rapidly softens; therefore, if allowed to remain too long in the solution, or if this is too strong, the object may disappear altogether. After treatment with this solution the object must be thoroughly washed in several changes of water.

(To be continued.)

ERRATA.—In our last number, p. 147, second column, 19 lines from bottom, for white-pink read white-zinc, and 16 lines from bottom of same column, for flush read black.

BEE RAMBLES IN SAVOY.

(Continued from page 149.)

We stopped to inquire for M. Fabian Picon, and curiously enough we addressed his brother, M. Marie Picon, who asked us to go in and see his bees, and he would afterwards accompany us to his brother's place, which was situated some little way further. We very soon had a number of the natives round us, who very much wondered who we were, and what the curious thing was that we carried about with us and with which we took pictures.

Massingy is a good specimen of a Savoy mountain village. Curious stone and stuccoed houses, with thatched roofs and projecting eaves, beneath which invariably hung the large cage containing the cheeses manufactured here—'Tonnes' they are called, and there are big, little, and middling-sized tonnes, made of skimmed milk. Not very famous cheeses these, but there are some that are excellent, and we were much pleased with many of them, one particularly, called 'Le Mont-Cenis,' which is very much like a mild Roquefort of a greenish colour. At many of these houses there are bees kept in skeps and boxes, which are placed pretty high up on shelves fixed against the walls, the hives being protected from the weather by the projecting eaves of the houses. We also saw many such shelves where formerly bees were kept, but now, alas! no longer are they to be seen in the places specially prepared for them.

Marie Picon had some hives of the Layens pattern, and when we reached them he at once proceeded to open one or two, to allow us to examine them. They were full of bees, and the combs were beautifully straight, and had all been built out on wired foundation. It was quite a treat to see hives so well and intelligently cared for in such an out-of-the-way mountain village. The little vegetable garden in which the hives were situated was adjacent to a field of sainfoin, which sloped away from it. We stepped a little way back into the field, and could not help admiring the picture before us, so much so that we were tempted to photograph

the scene. There was this brave peasant in front of us in his home-spun linen shirt, bare-headed, and a pipe in his mouth, manipulating the large frames of a hive, the bees of which were too intent on work to take any notice of what he was doing. Close by him stood three small children, bare-headed and with bare arms, perfectly unconscious that bees have stings, intently watching the curious strangers. In the background the house, with its eaves projecting a deep shadow nearly down to the open door, against one of the posts of which stood the good wife in wide straw hat, such as is worn in the mountains. Two diminutive boys, not quite so courageous as the little girls, stood in front of her with their eyes as wide open as possible, wondering what it all meant. Such a scene does not frequently present itself, but when it does it

and well managed, the Dadant having been doubled according to instruction given in our *Guide-book*, the French translation of which we found these mountaineers of Savoy one and all to be perfectly familiar with. It was not long before the father made his appearance, and was also introduced to us. He said he was not a bee-keeper himself, and had been very much against his sons having anything to do with bees; but finding that they were so successful he had quite come round, and looked upon the bees as the most remunerative of the farm stock. Seeing the venerable father and his three sons so enthusiastic about bees made us wish to possess a picture of them as a *souvenir*, so the idea occurred to us to photograph the whole group of those surrounding us, and the picture here given is the result.



makes one feel happier for having participated in it, and leaves an impression that is not easily forgotten.

Time, however, did not allow us to linger over this scene, and so we got back to our carriage, and Marie Picon accompanied us to his brother's farm, a little farther out of the village. When we got to the farm, we decided to take a short cut to where Fabian Picon was at work, and send the carriage round. We very soon came upon him, and then commenced the introductions, and as each was introduced separately, an exclamation of surprise, a beaming face, and a hearty shake of the hand, told us that we were welcome. He said he little expected to see us in his mountain home, and felt pleased that we had come, and at once left his work to conduct us to his house and apiary. Here he introduced us to another brother, and then the inspection of the hives commenced. Fabian Picon has twenty-four hives, of which twenty-one were Layens, one Dadant, and one an observatory hive. His hives were all strong

In the background we have the farmhouse with projecting eaves, and just in front of one of the windows hangs the cage containing the tonnes. The old gentleman on the right, holding his hat in his hand, is the father; near to him stands M. Mermey, and sitting in front is M. Layens: the mother is standing between him and M. Bertrand, and holding the hand of one of the grandchildren. The three bee-keeper sons are all dressed alike in their field costume, Fabian sitting on a log of wood to the right, and Marie standing in the centre. The third brother is standing next to M. Bertrand, and holding one of the children by the hand, while his wife is holding the rather shy baby in her arms. After this picture was taken, refreshments were handed round, and these worthy peasants made us feel at home at once. They told us there was great prejudice against bees, and they were laughed at for keeping them according to the new method, and were told they would never pay; but they had proved the contrary.

We went into the workshop where these brothers make their own hives, and where they have made 120, besides those they have sold. Bee-keeping is taking hold of the small proprietors in the district, and as they have found that these brothers have succeeded so well, they are now beginning to think seriously about it. Just around them, thanks to the assiduity of these brothers, there are sixty frame hives, belonging to twelve persons. From the abundant pasturage on all sides it was evident that if every one in the village kept a few hives the district could hardly be overstocked. The brothers have a lathe in their workshop, and make many things they would otherwise have to purchase.

The time came for departure, and after a hearty hand-shaking all round we left these people, carrying away a pleasant reminiscence of our short visit.

We promised to look in on M. Ramuz, the Maire of Massingy on our road, and when we arrived here, and just as we got into the garden, we heard the ringing of a swarm at a farmhouse just opposite. The swarm had issued from a skep on a shelf high up the side of the house, and was settling on a high tree, while an old dame was beating a scythe with a key and making a frightful din to induce the bees to cluster. As quick as lightning M. Bertrand suggested that a looking-glass should be tried, and the light flashed on the bees. This had been mentioned in the *Revue Internationale* as being successful in getting a swarm to settle. Some time, however, elapsed before a glass could be found, and when it was brought out the larger number of the bees had already settled, so the experiment was of no value.

M. Ramuz had the bee-fever very badly, and he had got ten hives of the Layens pattern. So convinced was he that bees were a good investment that when he took his cattle to market he sold them and invested the money in bees; and his old father was quite pleased with his son's success with bees, for he took us to his workshop, where he with pride showed us an extractor that his son had made, and for gearing had utilised that from a hand-drill. This extractor only cost him fifteen francs, or twelve shillings. The extractors used by these people are very simple. The outer cylinder is generally of wood, with a wooden spindle in the centre carrying cross-bars of iron, with four pieces of wood for the corners of the cage. The wire is then wound round the four pieces of wood and tightened by nuts, which turn on screws on the ends of the cross-bars. In this simple manner any amount of tension is obtained, and bulging is prevented. This plan we believe was copied from models obtained from Switzerland, where it is usually adopted.

(To be continued.)

FURNITURE POLISH.

Moisten 120 parts beeswax with oil of turpentine, and add 7.5 parts finely pulverised resin, and enough aniline red to give the desired mahogany colour.

DEVELOPMENT IN THE HONEY-BEE.

By R. A. H. GRIMSHAW.

(Continued from p. 102.)

The inclination to sting certainly accompanies hard work and prolificness, and is a symptom both of sedulous care of the young and of indefatigable nectar-gathering. It is, perhaps, worthy of consideration whether this disposition, often seen amongst bees removed to the moors, is not in some degree to be traced to their changed surroundings. In the valleys the bees are more accustomed to the presence of man and various animals near their home than they are amongst the heather, where for a couple of months few animals are seen other than odd mountain sheep and moor game, even these rarely venturing near the solitary keeper's homestead. On the other hand, I have fancied I discerned, on the removal of hives to the moors, an immediate tendency to become aggressive amongst hitherto mild-tempered bees, which I (wrongly or rightly) attributed to the strong smell of the heather bloom: and again, when bees (quietly wintered in the lower levels) were fed with combs of heather honey, the result has been the same. We should not always brand a disposition to sting as vice: a laudable effort to defend home should be indicative of constitutional vigour, and when properly viewed is a sign that there is something in the hive worth protecting—prolific queen, combs of brood, or stores of honey—always supposing the bee-keeper handles his bees with the calmness and care now considered orthodox. If, unfortunately, he has been guilty of extracting honey from the combs (or has opened his hives) too often, and thus, time after time, has aroused what temper the bees have, he must not be surprised at an ebullition of vice; he has taught his bees that the often bungling meddler is their enemy, they resent the interference and approach of any animal near the hive, and by some occult means (I again suggest the hereditary transmission through brood-food) have the power of giving their acerbity of temper to their successors. Like a horse that has once learnt the trick of bolting, the bee finding its power over the quasi bee-master does not fail to exercise it. I am not of opinion that in such a case bad temper is communicated to the queen, resulting in the laying of eggs which bring forth bad-tempered workers, or that re-queening the hive is a proper cure, but I would rather suggest the transference of the brood combs, with caged queen, to a hive placed upon the stand of another which will bear the loss of an artificial swarm, the latter hive being removed to another part of the garden.

Another hive, containing a few combs, might be placed upon the stand of the vicious bees, and a piece of perforated zinc fastened at night-fall over the entrance: then by sulphur fumes from a smoker the ill-tempered bees should be smothered. One objection to this plan is the brood might hatch out vicious workers, but it seems to me (for there is no method without some

objections) the best way, at the least cost to rid the bee-garden of a vicious stock—for rid it ought to be one way or another, as soon as possible, lest young queens and swarms issuing from such a hive of ill-natured foster-mothers contaminate a whole apiary. We must not lose sight of vice in bees, which results directly from the crossing of varieties—varieties so distinct and pronounced in their peculiarities that one might almost consider them different species when thinking of the results to be obtained by crossing. True hybrids, such as those obtained by inter-breeding the linnet and goldfinch with the canary, are infertile we are told; yet it must not be laid down as a law, for there are many instances in nature of fertile hybrids, and when we are treating of insects the whole subject is such a complexity of seeming breaches of all recognised canons, that if it were possible to cross the honey-bee with the humble-bee or wasp, we could fairly expect a fertile progeny. The prevention of vice amongst honey-bees by crossing varieties is not so complex in theory as it is difficult in practice, because of the physical obstacles to selected mating. The virgin queen, obeying an important instinct, sweeps upward in her first flight until she reaches an altitude much beyond that used by the workers or by the majority of the winged enemies of the bee; on this aerial coursing-ground takes place that admirable selective process by which an overruling power decides which species, varieties, or individuals shall live on in posterity or become extinct. Here the queen of an inferior kind, or an inferior queen of a good kind, flying in a marital race at utmost speed is easier overtaken by a correspondingly inferior drone (perhaps of the same hive), and they go down to posterity with all their imperfections on their heads. On the other hand, a vigorous virgin of a finer race can only be equalled in speed or agility by drones of a robust strain, and then begins the crucial contest amongst these for superiority in wing-power and dexterity. True, it must be confessed, nature often steps in on this mating-ground, and enables an effete and dying race to become recuperated and revived by the cross-mating resulting from the easy capture of poor queens by drones of vigorous varieties. Could we, as bee-keepers, control the mating of our bees as we do that of domesticated animals, we might hope that science would come to our aid in this, as in other cases, and give us a perpetuation of desirable qualities and an elimination of objectionable points. We might argue (and the results of experiment would confirm or destroy theory) that physical 'points'—points of a structural, constitutional nature—would be generally displayed in perfection, workers where the queen was of a perfectly robust, strong strain, whilst the mental (if one may use this term) qualities would in all probability resemble those of the workers in the hive who raised the drone parent. Therefore we ought not to permit any drones to be raised in hives showing bad temper, irritability, vice, or whatever we like to call it.

(To be continued.)

WEST CUMBERLAND B. K. A.

The members of this Association recently met at Cleator Moor, and it was decided to hold the annual exhibition for the current year at that place. Mr. E. McNally gave an address on 'The Work of District Associations,' and at the close received the thanks of the delegates present.

Mr. McNally, who has been the leading spirit in the formation of the Association, is leaving Cumberland to take up his abode in Glasgow, and we learn that he was made the recipient of a testimonial from his co-workers, in appreciation of the public services rendered during his residence in Harrington, coupled with regret at the loss of so active a worker.

A PROCESS FOR DETECTING PARAFFIN IN BEESWAX.

A process for detecting paraffin in beeswax has been found useful in Germany by H. Hager. A few grammes of the sample to be examined, in fine air-dried shavings, are gradually heated in a small porcelain capsule until fumes begin to arise. A pint wide-mouthed bottle is then inverted upon the capsule, and when it is filled with white vapours it is closed and set aside until the fumes have condensed upon its sides. The sublimate thus produced is then dissolved in three cubic centimetres of chloroform, and this solution being evaporated in a test-tube, the residue left is boiled with four cubic centimetres of caustic soda solution. If paraffin is present it will be now found floating on the clear alkaline solution when the latter has cooled. A drop of the chloroform solution may also be placed on a slip of glass and evaporated, after which the spot is examined under the microscope. The author remarks that the fumes from pure beeswax are not so white as those from paraffin, and are only obtained at a higher temperature, which he estimates at from 300° to 320° Centigrade. The sublimate produced in the above experiment gives a coloured solution with chloroform, and a coloured and turbid solution with soda. The residue from the chloroform solution is a dull film; paraffin, on the contrary, gives separate grains in a clear field.—*Magazine of Pharmacy.*

FOREIGN HONEY.

Mr. T. Christy exhibited and described, at a recent meeting of the Linnean Society, specimens of honey from different countries. From Turkey, 'arbutus honey,' which is said to produce drowsiness and sleep; 'eucalyptus honey,' from Mount Barker, Adelaide, is supposed to possess therapeutic qualities; and what is called 'wool honey,' from the Euphrates, which is a sort of honey-dew deposited by aphidæ on the leaves of oaks, from which it is collected.

Correspondence.

The Editors do not hold themselves responsible for the opinions expressed by correspondents. No notice will be taken of anonymous communications, and correspondents are requested to write on one side of the paper only, and give their real names and addresses, not necessarily for publication, but as a guarantee of good faith. Illustrations should be drawn on separate pieces of paper.

Communications relating to the literary department, reports of Associations, Shows, Meetings, Echoes, Queries, Books for Review, &c., must be addressed only to 'The Editors of the "British Bee Journal," 17 King William Street, Strand, London, W.C.' All business communications relating to Advertisements, &c., must be addressed to Mr. J. HUCKLE, Kings Langley, Herts (see 1st page of Advertisements).

* * * In order to facilitate reference, Correspondents, when speaking of any letter or query previously inserted, will oblige by mentioning the number of the letter, as well as the page on which it appears.

BEE-KEEPING IN KENT.

[604.] It is late in the day to talk about 1890, but better late than never, and so, as usual, I send you a short account of our bee-doings for that year. As it fell to my lot to keep the bee-account, I give the facts from my note-book.

Our stock came through the winter of '89-90 well, and we began the spring with fifteen colonies, most of them in good condition for gathering from the fruit-bloom. By the middle of May, hives worked for sections had from forty-two to forty-eight on each, with fourteen standard frames in brood chambers. Other stocks had double, and in two cases triple body-boxes, holding from twenty-eight to forty-two combs for extracting, all crammed with bees, and doing better on the fruit-bloom than we ever remember them at the same date. We work our stocks on the non-swarmer plan, but three hives swarmed in spite of us, and from each of the swarmed stocks three nuclei were formed by dividing the bees and brood left behind by the swarm, a good queen-cell being given to each of the nine lots into which the bees were divided. Each parent hive was then filled up with store comb, or with full sheets of foundation, the swarm returned, and all surplus boxes, &c., replaced as they were before swarming. The hives so treated did as well as any of the non-swarmer, and we had the extra colonies to the good.

After finishing extracting we had taken altogether 285 one-pound sections and 577 pounds of extracted honey--total, 862 pounds, or an average of over 57 pounds per hive. As, however, we used queen-excluders between brood nest and surplus chambers, nearly all the honey was stored in the latter, and in consequence we used two hundredweight of sugar in feeding in addition to one hundredweight of the darkest honey. Most of the honey was a little dark in colour, but it has sold fairly well. It has been our custom to change queens every year, but as many young ones failed in mating we decided to keep the old ones a year longer. By uniting we reduced the number to twelve stocks for the winter.

On opening the hives this spring we found in

two or three cases large patches of unhatched dead brood, chilled, I suppose, by the severe weather in November last. The combs were removed, dead brood uncapped and washed out with a garden syringe, combs dried, disinfected with carbolic acid, and stored away for future use. Where stores were short, combs of sealed food were given. Three hives were rather weak, but all the others are in splendid condition, with brood in all stages.

The following is our bee-account for 1890:—

EXPENDITURE.	£	s.	d.
Various requirements during season	5	0	8
Two hundredweight of sugar	1	15	0
One hundredweight of honey fed back	4	4	0
	£10	19	8

INCOME.	£	s.	d.
577 pounds of honey at 9d.	21	12	9
285 one-pound sections at 9d.	10	13	9
21 pounds of wax at 2s.	2	2	0
	34	8	6
Deduct expenditure	10	19	8
Balance for labour and profit	£23	8	10

Just a word respecting queen-excluders. We find that we do not require them in a good honey year, but in a season like the past they have proved invaluable. If we had not used them the queens would most likely have ascended into the sections and store combs.

In conclusion, we are trying a new method of working the bees this year, and if successful will report the same. One stock was tried on the plan last year with great success, but we think it should have another year's trial before recommending the principle for general use.—A. E. W. for C. H. W., Aylesford, Kent.

THIN SINGLE-WALLED HIVES.

[605.] In answer to your footnote to my letter (No. 580, p. 126), I may say that in a previous letter to the *Journal* some years since I explained that the hive I use is simply Abbott's 'Makeshift' hive.

I do not think it is any advantage having two dummies, thus making the hive double on two sides. It is only during the last two winters I have used more than one. If I wintered bees on ten frames, as many do, I should certainly prefer double walls: but I have always pointed out the importance, when using single walls, of wintering on seven frames only. This, I believe, is the whole secret of success. I have tried eight frames, and found bees backward in the spring, and have come to the conclusion that if you put up an ordinary strong stock in the autumn on seven frames only they will keep any frost out that we get in England. I have tried them for ten or twelve years alongside of double walls and skeps, and never could detect the slightest difference, but both the former have

been wintered on seven frames. It is all a question of management, as I know of a bee-keeper who has lost all his stocks in double walls. In answer to your question about roofs, I use Simmins' roof at present, but have used all kinds. I have not been using roofs that come down over the sides of hives except in a very few cases, where for exposed hives I put a rim on three inches deep to prevent them being blown off. I have about half a dozen like this, and only put them on last year. With all respect for our editors, I believe single walls are gaining in favour.—ARTHUR J. H. WOOD, *Bellwood, Ripon.*

[We cannot think our correspondent means to seriously contend that the whole secret of success in wintering in single-walled hives lies in confining the bees to seven frames only, and that to try and winter them on eight, or any other number, means failure? No! there must be something in his good management beyond the magic of the number seven. Personally, we have often found it impossible to get our bees crowded into a ten-frame hive when putting them up in autumn; indeed, we have more than once been compelled to leave a ten-frame shallow surplus chamber on to hold the bees till the weather became cold enough to crowd them into the ten-frame brood chamber.—EDS.]

NOTES ON BEE-KEEPING.

[606.] My bees have had a rough time of it since I wrote to the *Journal* in April last year. I do not remember ever having my apiary in better condition than it was last spring. I had not lost a single stock during winter, and every colony was in the most flourishing condition possible. My prospects were bright and encouraging in the extreme. But this highly satisfactory state of things was of short duration; the summer was a most unfavourable one. Stocks at the beginning of July were in a decidedly worse condition than they were at the beginning of May, and never once throughout the summer reached that boiling-over point so essential for the rapid filling of supers; consequently but very little surplus was gathered, and breeding ceased at a very early date. In the autumn I found that some stocks had got more stores than was necessary. This was taken away and given to those that were short, by which means all were supplied with natural stores. The only syrup used was thirty pounds, which I had made before I had ascertained the exact condition the bees were in, and which was distributed amongst about twenty stocks.

The unfavourable summer was followed with the finest autumn that I can remember—in fact, it was real summer weather, and bees were on the wing every day right up to the middle of November, when winter—such as I had never before experienced—set in in right earnest. For ten long weeks my bees were complete prisoners; eight weeks out of the ten hard frost, snow, and dense fog prevailed, and I truly believe that during that time not a bee in my apiary 'moved a peg.' The thermometer went down to zero no

less than six times, and on three times out of the six thirty-three degrees of frost were registered. There was skating on the river Ouse—which had not been frozen over since 1881—six weeks with but slight interruption; during the last week of the frost the ice was no less than eighteen inches thick. Several times during this severe weather I passed my apiary between twelve and one o'clock in the night; the scene was magnificent, not a sound to be heard but the creaking snow beneath my feet. My rows of hives were covered with frozen snow, upon which the moon was shining with a brilliancy that made the night practically as light as day and the snow sparkled like so many diamonds. The trees were so heavily laden with rime that they bowed down like weeping willows, and telegraph wires covered in the same manner appeared to be a good inch in diameter. A grander picture I thought it impossible for nature or man to produce, and with my hands up to my ears to ascertain whether the latter were really frozen or only so cold that they were beyond feeling, I thought if bees in single-walled hives can stand this they can stand anything.

At last the thaw came, and I lost neither time nor opportunity in examining my stocks, twenty-six of which were in double-walled hives, and, with one or two exceptions, all were snugly packed with chaff cushions. The other eight—a total of thirty-four—were located in single-walled hives. The death-roll was very much the same in both, and it is no exaggeration when I say that every hive, whether double or single-walled, contained ten times more dead bees than were seen in the whole of my thirty stocks during the whole of the previous winter. In several instances the queen was amongst the dead. In one case the bees had acted very foolishly: instead of proving themselves good unionists, they had followed a separatist policy—that is, they had formed two clusters, which meant, of course, their mutual destruction. In one or two other cases the bees had all died of starvation with sealed stores in the very combs on which they were clustered: the moving up of a few inches would have landed them in the midst of plenty. Dysentery—a complaint with which I had never before been troubled during the fourteen years that I have kept bees on the modern system—was my greatest enemy. Six stocks had got it in a terribly bad form. Those who have never seen a bad case of dysentery, and are anxious to know what it is like, can paint the picture for themselves in a few minutes. Remove the quilt from a hive that is full of combs, take a sixpenny tin of chocolate-coloured paint, remove the lid and pour out the contents in such a manner that it splashes all over the frames, combs, hive sides and floor-board, and you have as good a representation of a bad case of dysentery as can well be described.

A few weeks ago, Mr. Editor, you stated that dysentery is the effect of one of two causes, viz., unsuitable food, improper ventilation. As stated above, the whole of my stocks were packed up on natural stores, and as regards the hives they

are hives in which bees have wintered successfully for the last eight years. I am quite satisfied that in my case dysentery was caused through the ten weeks' confinement, and the extremely cold and foggy weather that prevailed during that time. But why some should have suffered while others that were treated the same escaped is only one out of many mysteries with which I have been confronted since the breaking up of the hard weather, and of which I may have more to say in future notes. What with my losses from starvation—or, more correctly, cold, for I only found one lot that had actually run out of stores—dysentery, and the uniting of weak and queenless stocks, my autumn count of thirty-four colonies is now reduced to about two-thirds that number. This is by far the most serious loss I have ever had. Even two years ago, when my bees were wintered almost entirely on syrup, and when so many hundreds of stocks died throughout the country, my actual loss was limited to one or two—I forget which—out of thirty, but the winter then was nothing to be compared with what we have recently passed through.—A. SHARP, *Huntingdon*.

[The above is the communication referred to in 'Useful Hints' last week, p. 145.—Eps.]

FOUL BROOD AGAIN.

[607.] Touching the editorial comments on my letter in *Journal* of January 22nd (512, p. 41), I may be permitted to make some remarks.

In the first place, it is evident that my position on this question has been somewhat misapprehended. Personally, I have never either seen or treated a case of foul brood. During a quarter of a century or more of bee-culture I have always had the good fortune to escape the plague.

But my position as President of the Ontario Bee-keepers' Association, the past year and the present, brought me in contact with the foul-brood inspector and his work, and forced upon my particular attention an unpleasant subject with which I had never been personally troubled before.

When I saw the remarkable success of the inspector's simple method of cure, and procured from independent sources ample proof of the efficacy of his treatment, I deemed it my duty to make the facts as widely known as possible, and to even urge them upon the attention of bee-keepers everywhere. This I have diligently and persistently done, with the single object of benefiting those concerned. And while I have been criticised by both the Americans and English, it is worthy of note that the facts I have presented have never been disputed, and I still maintain that we are safer in following facts than theories or hypotheses, no matter how plausible. The plain fact is, we cure foul brood by a simple process. If that process clashes with certain theories, so much the worse for the theories. Whether the disease is the 'dry' kind or the wet kind it yields to the treatment, and

that is the main point with us. According to the undoubted testimony of the Inspector (Mr. McEvoy), Mr. D. A. Jones, and many others, as to the malignancy and offensiveness of the disease as found here, I can only say, if you have any worse forms of it over there, we may well extend our sympathy as well as advice.

So far as the scientific view of the origin, nature, and treatment of foul brood is concerned, I have never denied any of the scientific facts, nor do I feel disposed to. No man has greater respect for demonstrated science. Indeed, she is my guide in life in everything so far as I have made her acquaintance. I have not even dogmatically denied the theories which stand, or appear to stand, in the way of the facts before me—theories emanating from very respectable scientific authorities on the foul-brood question. I refuse even to make a generalisation from the facts before me—strong and numerous as they are—except for *practical* purposes, not to predicate a principle or theory. While the induction of a principle from such an array of instances might be logically justifiable, it might not be scientifically safe. My position is therefore, I think, a reasonable one.

So long as our method of treatment continues so thoroughly efficacious, we shall continue to practice it. Should it fail, that will be time enough to cast about for a different and better one. Mr. D. A. Jones has had a long and extensive experience with foul brood, and I fancy the English authors and journalists would have a big undertaking on hand to attempt to convince him that the 'starvation plan' of curing foul brood has been 'proved a failure.' I did not say or mean that the theory or principle of Mr. McEvoy's plan of treatment was new. I believed, and still believe, that his *modus operandi* was new and original with him, as I have seen no reason yet to change that opinion.

The *Journal* says, 'It is absurd to suppose that "prejudice or preconceived opinion" would prevent a bee-keeper from accepting so simple a remedy for a disease which is in itself subversive of all that is good in the pursuit.' This is not quite what I meant. I meant that the authorities and journals—not the common bee-keeper—would not heed the remedy placed before them, it being so opposed both to their theories and practices. I note with satisfaction that the *B.B.J.* concludes its criticism by advising its readers to 'try it by all means,' but presents the wet blanket with the other hand. I would say, try it, and go through it with at least enough faith in its efficacy to enable you to do it properly without bungling it.—ALLEN PRINGLE, *Selby, Ontario, February 9th.*

BEE AND HONEY SHOWS.

[608.] I notice that 'Bee-Kay' (589, p. 150), has been informing your readers that on the 28. 6th. day of the Hull Show of the Yorkshire Agricultural Society in 1889, he (or she) was present and was dissatisfied with the want of

preparation evident in the exhibits, the bee-tent, &c. I think 'Bee-Kay' must be alluding to the appearance of things before noon, at which time, as we all know, tent-work would not have commenced. After that time, during the whole afternoon, in fact, until the close of show, the lecturing and manipulation of bees, &c. continued almost without intermission. Even in the short space of time when the voice needed a little rest, a notice was fastened on the tent stating the time fixed for the resumption of the work, but the interest of the spectators was such that continued conversation and explanations had to be proceeded with. In fact the lecturing and manipulation was scarcely fairly stopped from the time the bee and honey show opened till closing-time. As for the exhibits and judging, they were as forward as could be expected. It is really too much for visitors to expect the pot to be *incessantly* on the boil, yet in this case, as I happen to know, it was so. Mr. Seager, W. Dixon, Leeds (the expert), Mr. A. Woodhead (Goole), Mr. Jemieson, (York), Dr. Wray, and Mr. Atkinson (Tockwith) will, I think, be able to say that on that day his duty was done by—
HON. SEC., YORKSHIRE B.K.A.

METAL ENDS.

[609.] Replying to 597 (p. 153), I shall be very happy to supply your correspondent, or any one else, with 'W.B.C.' ends in zinc, or even brass or copper, if he wishes. He seems to reverse the order of things; few people now will use *any* zinc in their apiaries.—W. P. MEADOWS, *Syston, near Leicester.*

Queries and Replies.

[337.] *Changing Hives.*—I bought a couple of strong stocks of bees in frame hives last year, along with the small bee-house in which they stood. The hives are almost touching each other in the house, and so they are very awkward to manipulate. I therefore want to transfer the bees into two new hives; but the combs now in the hives, and some good spare ones I have, would not fit between the rabbet of the new hives like the frames with 'W. B. C.' ends. I can easily manage the spare combs; but how am I to do with the frames occupied by the bees in transferring them to the new hives? Even if the rabbets were planed down, the frame ends would overlap the sides of the hives. Can you tell me—1. A way out of the difficulty other than by using double side walls to the hives, or cutting out the combs and fastening them into new frames by tapes, &c., for the bees to fix? 2. When would be the best time for changing the bees? 3. Ought I to change the two stocks at the same time, or only one, allowing it to settle before doing the second? 4. As the present structure is well raised from the ground on legs, and the new hives are without

the latter, and close to the ground, would the bees readily find the entrances so much lower? 5. Should I at once remove the house after changing or leave it as a landmark for the bees, with the hives just in front of the present entrances, which would, of course, be blocked up? 6. How should I proceed generally in the matter? I may say here that the hives now in the house are not suitable for standing *outside*.—SNOWDROP.

REPLY.—1. If your intention is to use the 15½-inch top bar instead of the orthodox 'standard' of 17 inches, and work the ends in a half-inch rabbet, the best course will be to cut away the projecting broad shoulder and reduce the length of top bar to 15½ inches. 2. Any warm day; but the combs with brood in should be taken into a warm room while being altered, and care must be taken not to damage the sealing of the cells, or the brood will suffer. 3. It is just a question of expediency. 4. Use a loose stand for the hives, with legs 10 inches long, and bring the hive entrances to as near the present level as convenient, lowering them by a foot at a time till in their permanent position. 5. Move the bee-house away at once. 6. Refer to No. 4.

Echoes from the Hives.

Draycott, Derby, March 24th.—My stocks have all survived the winter, though some were far from strong when put up. In my own apiary native bees are far behind Carniolans, and I have reasons for believing that the latter are longer lived than British bees. When I have experimented further on this point I will give my reasons. Perhaps others who have both races will also test them in this respect. Whenever my bees begin to show a tendency to rob in early spring and autumn, I use the carbolio cloth in preference to smoke, as it tends greatly to check robbing. Mr. Woodley (on page 142) rather disapproves of using full sheets of foundation in brood nests, and thus limiting the production of drones; but, on the other side, may we not do harm by using too little? As a case in point, I once bought a stock of bees, to which only strips of foundation had been given, with the result that two-thirds of the comb in the hive was drone-comb. Moreover, I think we should rid our hives of black old combs oftener than we usually do when foundation is so cheap. Much has been written for and against the use of excluder zinc, but after trying to do without it, and being continually annoyed at results, I have resolved to use it always in future. The weather of late has been a blessing in disguise, serving as a warning against meddlesomeness and stimulating yet. When the warm weather does come, breeding will go ahead at express rate. Queens meanwhile have had an easy time, and the workers, by being confined to the hive, have been spared from death by thousands. I shall certainly not commence stimulative feeding

until weather is more settled, but, once begun, shall not stop until no more is needed. No feeding by driblets for me.—CHARLES WOOTTON, *Second-class Expert.*

Honey Cott, Weston, Leamington, March 27th.—After a mild February, with high temperature, March brought us a terrible blizzard. Not so bad here as that in 1881: but a day or two after we had 14° of frost, which was very sharp for the time of year. Again, this last two or three days, bees have been enjoying themselves, carrying in water, and busy on the pea-flour I placed outside for them. I have only begun giving it this week, and the bees were at it in a few minutes by hundreds. The palm is out slightly, and fruit-trees are showing expanding buds, so that we may expect in a few days, with good weather, bees will have plenty to do, but there is blackthorn winter to come yet, and we have had snow to-day (Good Friday, 2° of frost.)—JOHN WALTON.

Notices to Correspondents and Inquirers.

Letters or queries asking for addresses of manufacturers of correspondents, or where appliances can be purchased, or replies giving such information, can only be inserted as advertisements. The space devoted to letters, queries, and replies, is meant for the general good of bee-keepers, and not for advertisements. We wish our Correspondents to bear in mind that, as it is necessary for us to go to press in advance of the date of issue, queries cannot always be replied to in the issue immediately following the receipt of their communication. All queries forwarded will be attended to, and those only of personal interest will be answered in this column.

A. CONSTANT READER (Redbourne, Herts).—

There is no foul brood in comb sent, but the comb is so old, pollen-choked, and generally unfit for use, that we would almost sacrifice the little honey rather than give them to the bees again. In any case we would only insert them in the hive, after uncapping the food, for a day or two while the bees consumed the honey.

ST. IVIAN (Hants).—1. Pea-flour candy cake is a suitable spring food for bees, but yours has been overcharged with flour. 2. No: usually it is used for feeding purposes by the nurse-bees.

DORSET (Wimborne).—Move the bees at once, and make some temporary change in the outside appearance of the hive.

E. R. B. (Denmark Hill).—It is rather too early to quite decide that the hive is queenless. Remove the candy put on in autumn, and stimulate the bees for about a week by giving warm syrup daily and uncapping a little of the sealed food: then examine for eggs and brood.

** * Several letters, &c., are unavoidably held over till next week.*

NOTICE.—We request our correspondents in future to address all communications relating to the literary department, &c., to 'The Editors of the "BRITISH BEE JOURNAL," 17 King William Street, Strand, London. W.C.'

THE DEPOSIT SYSTEM.

British Bee Journal and Bee-keepers' Record.

OFFICE: KINGS LANGLEY, HERTS; AND
17 KING WILLIAM STREET, STRAND, LONDON, W.C.

The following are the Rules under which we are prepared to receive Sums of Money on Deposit from persons buying and selling goods.

In order to save trouble it is requested that the Rules be carefully read over by persons using the Deposit System of trading.

DEPOSITING.

1. **Method.**—When strangers are dealing together, the purchase-money of the articles is deposited at our office. We acknowledge receipt of the deposit to both parties, and hold the money until we are satisfied that the purchase is concluded. If a sale be effected, we remit to the seller the amount deposited, less a charge of 6d. and the expenses of Post Office Orders and postage, &c. Cash will be forwarded by cheque, Post Office Order, or by Postal Order as preferred. If a sale or exchange be not completed, we return the amount deposited, after making the same deduction. By this means buyers and sellers are secured from fraud.

2. **Deposits.**—Postal Orders (drawn on General Post Office) and Cheques must be made payable to John Huckle, and crossed 'Backs and Oxon Bank.' The numbers of the Postal Orders should be kept by the sender. We cannot be responsible for any losses that may occur in transit.

3. **Honey on Approval.**—All honey will be sold by sample, which must be sent direct to buyer.

4. **Bee-appliances.**—In ordering, the time allowed for completing the order to be stated to us when sending cash. If maker accepts, we hold cash till transaction is satisfactorily completed, when the amount will be remitted subject to conditions as in Clause 1.

5. **Bees and Queens.**—These will be dealt with entirely by the parties concerned, so far as price, &c., goes, and when the purchase is satisfactorily completed cash will be remitted as per Clause 1.

6. **Goods in Transit.**—These are at the seller's risk, i.e., any damage to or loss of an article on its journey is borne by the vendor; but a rejected article must be properly packed and returned by the same means as was used in sending it.

7. **Carriage.**—The carriage of all goods, *except such as are sent by post*, is payable by the buyer, unless otherwise agreed. If any article sent on approval be returned, each party to the transaction must pay carriage one way.

Tenth Edition. Nineteenth Thousand.

BEE-KEEPERS' GUIDE BOOK. Containing Management of Bees in Modern Moveable Comb Hives, and the Use of the Extractor. By THOS. WM. COWAN, F.G.S., F.R.M.S., &c. With numerous Illustrations. Fcap. 8vo., price 1s. 6d.; or in cloth gilt, 2s. 6d. Postage 2d. To be had of HOULSTON & SONS, Paternoster Square, all Hive Dealers, Secretaries to Bee-keepers' Associations, and of J. HUCKLE, *British Bee Journal* Office, Kings Langley, Herts.

BEE-KEEPING, its Excellence and Advantages. Price 3d. *British Bee Journal* Office, Kings Langley, Herts, and 17 King William Street, Strand, London, W.C.

JUDGING HONEY. By the Rev. J. L. SEAGER. Price 3d.

DIAGRAMS ILLUSTRATING BEE-CULTURE and the Relation of Bees to Flowers. Drawn by FRANK R. CHESHIRE, F.R.M.S. Approved and recommended by the Science and Art Department. 4s. per set.

JOHN HUCKLE, Kings Langley, Herts.

THE British Bee Journal,

BEE-KEEPERS' RECORD AND ADVISER.

No. 459. Vol. XIX. N. S. 67.]

APRIL 9, 1891.

[Published Weekly.]

Editorial, Notices, &c.

USEFUL HINTS.

WEATHER.—Still another change, and that for the worse this time. The genial warmth and bright sunshine which bees and men were so thoroughly enjoying when last we wrote in this column was followed by some welcome rain, only to be succeeded by a return of cold north-east wind and more gloomy dullness. The present backward condition of the fruit-bloom everywhere in the south makes it unsafe to hope for any very early honey from that important source of supply, but we have the comforting reflection that the tender blooms, so snugly folded away in the roundness of plump buds ready to burst forth, are safe from sharp frosts and drying east winds. Passing through some acres of fruit-gardens daily, we can see abundance of promise for the bees; but even the black-currant bloom is only just showing its tiny purple pellets half hidden between the opening leaves, while plums, which we thought to have seen white with blossom by this time, are still a thing of beauty which 'is to come.' We do not share the prognostications of a cold summer some talk of one bit—at least, so far as that unhopd-for condition of things is to be associated with a poor honey harvest. All our experience points to the fact that very severe and long winters have been followed by good bee-seasons, and we trust 1891 will be no exception.

The present untoward condition of the weather, however, renders it very necessary for bee-keepers to be watchful, because, notwithstanding the cold, good colonies will be breeding well, and a constantly increasing number of mouths to feed means a corresponding increase in the consumption of stores with almost no income whatever,

except what is provided by the thoughtful hands of the bee-keeper himself. In some seasons bees in early districts are gathering honey by the second week of April; but we are safe in saying that no nectar of 1891 has yet been seen, though three or four days may see a complete change and bees finding out sunny spots where honey may be gathered by the time these lines are in print. For the present, however, the two words—watchfulness and warmth—comprise about all that is needed in the apiary and among the bees.

PREVENTIVE MEASURES AGAINST DISEASE.—Already samples of comb are making their appearance, though, so far, only a single case of foul brood has been received. Perhaps it is too much to hope that the plague has been more than partly scotched, to say nothing of its being killed. We are, perhaps, open to the charge of confusing readers by the multiplicity of the remedies advocated in this *Journal*, but this is a thing very difficult to avoid. Our sole and only object is to find out the best, and give prominence to whatever we believe to be good in the interest of bee-keepers, who, so far from feeling anything like dissatisfaction at the multiplication of remedies for this disease, should be grateful that so much of the time of eminent scientists is given to the elucidation of questions connected with bee-diseases. We write thus because of being reminded that several remedies for foul brood have appeared in our pages, the latest of which (Naphthol Beta) is now finding a good deal of favour, mainly, we suppose, because of its harmlessness compared with formic and other powerful acids. What all bee-keepers need is a simple disinfectant or preventive against contagion, and if constant watchfulness is exercised in using such in all food given, it cannot be doubted that immense good will result.

EXCLUDER ZINC.—A correspondent on p.

(176) calls attention to the fact of six queens in one season having passed through the perforations in the metal of the queen-excluder (?) used. No doubt it was, in this case, the faulty make of zinc which caused the mischief, and it is an unpardonable oversight on the part of our appliance dealers to send out such so-called excluders. There are several patterns of zinc on the market which are more or less faulty in our view; among these is the one in which the perforations run in parallel rows. When it is borne in mind how zinc contracts and expands under variations of temperature, we can understand how the smallest amount of buckling or stretching will cause an upward bend in one side of the long-hole perforation, and allow the queen to pass through. There is no form of zinc so likely to minimise this risk as that shown on p. 176, and if bee-keepers when ordering ask for this make there need be no difficulty in obtaining it. Another point is the use or non-use of a bee-space between the tops of frames and the under side of the zinc. We prefer the metal to lie close on to the top bars with no space between, and with the lengthway of the holes running across the space between the frames. It seems to us far better for the bees to pass through the perforations direct rather than enter a space above the tops of frames and then climb up to the perforations above. We have seen the bees covering the top bars for some time before entering supers, owing, as we thought, to this defect.

HONEY IMPORTS.

The total value of honey imported into the United Kingdom during the month of March, 1891, amounted to 2927*l.*—*From a return furnished by the Statistical Office, H.M. Customs.*

BIOGRAPHIES OF BEE-KEEPERS.

Of the numerous appreciatory letters received respecting our biographies is the following from a Scotch clergyman, referring more especially to the biography of Miss Macdonell:—

‘The photograph is excellent, beautiful, with the index of great strength of character. I must order several copies for transmission abroad. In Prince Edward Island I know how much it will be appreciated; and then I shall keep a copy for myself. In the real excellence of the portrait and the rare interest of the story I am sure even the *Bee Journal* has had nothing of finer interest for many a day. The experiences of my Perthshire contemporary, “Bizz-E-Bee,” in his early bee-keeping, also are especially good.’

BEE-PAPERS FOR WINTER READING.

No. 6.—MOUNTING MICROSCOPIC OBJECTS.

(Continued from page 160.)

Another method of mounting is that without pressure, and this, from a scientific point, yields the most satisfactory results. In the methods of mounting we have described, as only the outer skeleton is required, it is not very material how the insects are killed, or how long they are kept previous to preparation. But in mounting without pressure, in order to show the internal structure and muscular fibres, it is absolutely necessary that the insects be quite fresh and only recently killed. We place ours in an entomologist's killing-bottle, which is prepared with cyanide of potassium. It must be remembered that this is a most deadly poison and should not be smelled, therefore great care should be exercised in its use. The insect is killed by the vapour in a few seconds, and should not be left in the bottle more than half an hour at the most, as cyanide of potassium would, in a short time, materially injure the muscular structure of the insect, and spoil it as a microscopical object. The insect is removed before its legs and wings become rigid. We now take any part of the insect we require, say, for example, the head, and soak it for a couple of days in equal parts of spirits of wine and water, after which we transfer it to absolute alcohol for two or three days longer. It is then transferred to oil of turpentine and placed in the light until it is sufficiently bleached, when it is taken out of the turpentine and soaked in benzole until this has replaced the turpentine. Then select a glass or tin cell just deep enough to hold the object, rinse it out with benzole and place the head in the centre, pouring in benzole balsam until the cell is full. Then put on a glass cover and place in a warm place until the benzole escapes, and the balsam becomes hardened round the edge. No pressure must be used, as this would depress the thin glass, and when the pressure is removed air would find its way under the cover and thus spoil the object. After a few weeks the balsam may be removed from the edges, and the slide finished by having several coats of varnish applied. We prefer giving first a ring of dammar, and finishing off with asphaltic varnish. Particular care must be taken not to use brass rings when mounting in balsam, as it acts upon this metal.

Should we wish to have the tongue extended and the mouth-parts well shown, these should be placed in the position they are to occupy before being put into the spirit. To do this we first spread a thin film of Canada balsam upon a glass slide, and on this place the head in the position we desire. The tongue and mouth-parts are then arranged with a needle, and made to adhere to the balsam. In this position they may remain for two or three hours, after which the glass with the insect can be placed in the spirits of wine. The hardened film of balsam will keep the mouth-organs in position until the

balsam is dissolved by the turpentine, into which the objects are transferred from the absolute alcohol. If desired, the parts can be pinned out on a piece of cork, but we prefer the film of balsam, as being in every way the most expeditious. Objects mounted in this way show the internal structure very well, especially if they are soaked long enough in turpentine to make them transparent.

Another way of mounting with slight pressure, which is sometimes employed, is to place the object in pure liquor potassæ mixed with one-fifth part of strong ammonia. It must, however, not be left too long in this solution, and must be tested from time to time by putting it in water and pressing the thorax, which is the hardest part of the body. When this is soft, as are also the legs, place the insect in water for twenty-four hours, then soak in a mixture of equal parts of glycerine and glacial acetic acid for several hours. The insect can now be left and preserved in this solution until required for mounting. Then immerse it in several changes of water for twenty-four hours, after which it may be laid out and arranged on a slip. We then place a glass cover over it, and tie round with cotton thread, so as to keep the object and cover in position. We next place the slip on end on a piece of blotting-paper to drain, and then put it into dilute spirit for twenty-four hours; or, if we allow more time, we can put it direct into the turpentine, and leave it there until all the moisture has been driven out and the insect is thoroughly saturated by the turpentine. We then drain off the turpentine, and remove any excess under the cover by means of blotting-paper. Lastly, we run in benzole balsam at the edge, and allow it to fill the space by capillary attraction. The slide is then put in a warm place, and can be finished off when sufficiently hard. By this method very good results are attained, but the best are undoubtedly objects mounted in cells without pressure, as previously described.

Instead of mounting in benzole balsam in cells, thick pure balsam may be used, but in this case the cell must be filled above the rim and placed under a bell glass, to exclude it from dust, for four-and-twenty hours. This will allow all the air to escape, when a drop of fresh balsam is applied and a glass cover slightly warmed let down gently upon it. Objects mounted in this way are very clear, but pure balsam is a long time in setting and getting hard, therefore great care must be exercised not to knock off the cover glass, which should have several coats of varnish applied to the edges.

It will be noticed that all the objects are dehydrated, and upon the efficiency of this depends the future state of the slide. Unless all the moisture is got rid of the slide soon gets cloudy. Alcohol removes the water, and oil of cloves takes out the alcohol, with which the oil changes place, one volume of oil of cloves dissolving an equal volume of alcohol. Turpentine replaces the oil of cloves and clears at the same time. Benzole still further clears the object, mixes

with the turpentine, and causes the benzole balsam to flow over and penetrate the object more rapidly. Benzole, however, is extremely inflammable, and great care should be taken not to bring it anywhere near a light. We have mentioned ether, and this follows alcohol, dissolving it, and therefore making a suitable intermediate bath between alcohol and oil of cloves. It can, however, be dispensed with, although we prefer to use it in our preparations, as it is also a solvent of fats.

Many of the internal parts can be mounted in balsam, but these we must allude to when speaking of dissection.

We have now given general directions for mounting dry and in gum-resins; it remains for us to treat of mounting in fluid media.

(To be continued.)

BEE RAMBLES IN SAVOY.

(Continued from page 162.)

After taking leave we started on our way, and a drive downhill of about one hour brought us to the village of Albens, which is on the main road to Aix-les-Bains. Leaving our luggage at the station we returned to the inn, and after lunch went in search of M. Rochet, who was the director of the *écoles communales* there. He was busy with a class, but on our arrival the school was dismissed, and the rest of the day was given to us. The school was a large one and quite modern, and at the back there was a large garden where M. Rochet kept his hives. These we found ranged with their backs to a path running parallel with the house, and very conveniently situated for examining the bees without disturbing them by going in front. He told us that there was one hive he was not quite satisfied about, and would like our opinion. This we left until last, and examined some of the others. M. Rochet had not kept bees very long, and was a learner, but several hives we found in very good order. He had seven Layens and two Dadant hives.

We at length came to the one we left to examine last, and it was decided that one of us only should manipulate the frames, and the others scrutinise them. M. de Layens undertook the manipulation, and took out one frame after another. There were few bees, and very soon M. Bertrand was the first to discover a suspicious-looking cell which turned out to be foul-broody. Others were then found, and after satisfying ourselves that the hive was diseased it was closed, and we went away to wash our hands and get rid of any contamination. M. Rochet was recommended to at once try naphthaline, as his hive was not badly affected, and we went to the village chemist to get some; but as he had not any, M. Mermey undertook to bring some from Aix-les-Bains the next day, and as he had already had experience, he was to superintend the cure. After this, a pleasant time was spent in bee-chat, and after dinner we retired to the inn for the night, being too late for the last train

to Aix. We found also here as in other places where we had been that bees had been kept much more generally in former days, but that owing to disease and other causes they had disappeared. Now another start was being made on modern principles and bees are again becoming a good source of income. The bee-keepers we visited at Massingy told us they had no difficulty in selling all the honey they could get at remunerative prices, and they got 2 francs to 2 francs 50 cents a kilo. for it. Sections they could sell for 1 franc 50 cents. Most of the honey went to Lyons and Paris, and they could easily sell ten times the amount they get. Savoy honey, being principally from sainfoin, was much appreciated, but there are other sorts of honey from various mountain districts having particular flavours that also command a good price.

Mermey is standing to the left, and on the extreme left stands a woman just from the hayfield, while her faithful hound lies at her feet. The wall of this house looks rather dilapidated, but gives easy access to the loft by means of a ladder placed against it. The carriage holds four persons, who sit back to back, and contains a receptacle for the luggage at the back and a seat for the coachman in front.

On arriving at the château we found the Count absent, but his son received us very graciously, and told us his father would be sorry to have missed us, and was sure that he would have been pleased to have shown us the correspondence of his grandfather with Huber. We were shown over part of this ancient château, which dates from the fifteenth century, and there was much of interest in it. It is rather curious that it is



Early next morning M. Mermey, who had gone to Aix-les-Bains on his bicycle, joined us, and we decided, instead of going by train, to make a slight détour, and pass by Grésy, calling on Count Mouxy de Loche at the château there, as we were told he had a number of unpublished letters of François Huber, which we wished to see. We ordered a carriage, and to our delight one of the native vehicles made its appearance, and the master of the inn offered to drive us. We passed through pretty lanes with thatched houses and several disused beehouses. Thinking it would be a pleasant reminiscence to have a picture of this primitive carriage, which is fast disappearing and giving place to more modern vehicles, we decided to photograph it, and for this purpose we stopped in front of one of the old farmhouses. We present our readers with the picture, which is a faithful representation of the scene. M. Bertrand and M. de Layens are sitting in the carriage, and the Jehu on the box-seat, while M.

supposed Grésy derives its name from a Greek colony which settled in these mountains. The Celtic is *Graig-hill*, and Latin *Græci* or *Græsiacum*, which, converted into French, became *Grais*, and finally *Grésy*. The grandfather of Count Mouxy de Loche was a scientist of some renown, and devoted himself to the study of bees. He was also in correspondence with many scientific men of the day, including Huber. He was in the military service, and in 1786 his taste for natural history commenced, when he published his first papers. Six years later he was elected a member of the Royal Agricultural Society at Turin. In 1798 he settled in Turin, and continued his studies in apiculture, entomology, agriculture, and archaeology until 1805, when he returned to Savoy, and was admitted a member of the Natural History Society at Geneva. In this way he came in contact with Huber, and from that time frequently corresponded with him. He was most assiduous in his observations on bees, and published a

number of papers and works, some of which we are fortunate enough to possess in our own library, which our visit to his château renders all the more interesting.

Amongst the memoirs published by him on bees the following may be mentioned:—1. *De la culture des abeilles dans le Département du Mont-Blanc*; 2. *D'une résine employée par l'abeille dans la construction de ses gâteaux*; 3. *Culture de l'abeille*; 4. *Des causes qui déterminent les abeilles à construire leurs gâteaux*; 5. *De l'abeille chez les anciens*; 6. *Traité général de l'abeille*; 7. *Mémoire sur la génération des abeilles mâles*; 8. *Mémoire sur les abeilles et principalement sur la manière de faire les essaims*; 9. *De la culture des abeilles sur les Alpes et les pays voisins*; 10. *Mémoire relatif*

Layens and Dadant patterns. The long hives seen in the front row are the Layens, while those at the back are the Dadants. We found M. Mermey a very intelligent as well as an enthusiastic bee-keeper, and were therefore not surprised to find his apiary in such good order. He is very well situated, and has a good opportunity of disposing of all his honey to advantage, as he lives on the main road from Aix to Rumilly, and there are a large number of visitors from Aix who pass his place every day when out for a drive or walk. M. Mermey told us that the late Mr. Alfred Neighbour came out several times when he was staying at Aix. M. Mermey keeps a first-class restaurant in the house seen in the background of the picture, and we advise any of our readers who visit Aix not



aux cires de France; 11. *Recherches physiologiques sur les abeilles*.

These writings extended over the period from 1806 to 1836, and will show that at the beginning of this century bee-keeping occupied a prominent place in Savoy. We were sorry, however, not to see the letters, and the son said he was sure his father would call on us. His younger brother, a young gentleman of about twenty, had taken to bee-keeping, and his father encouraged him in his pursuit. Leaving the château, we drove towards Aix, and stopped within about a mile of the town at the residence of M. Mermey. Here, curiously enough, we met the Count returning from Aix, and he promised to call upon us at our hotel in the evening. M. Mermey took us at once to see his bees, which he kept in a garden on the opposite side of the road. These were beautifully kept, and we found this quite a model apiary. The illustration will give a very good idea of what it was like.

M. Mermey has twenty-four hives of the

to forget to go out as far as the 'Rendezvous des Chasseurs,' where they will not only get good refreshment, but will be able to see an apiary kept in first-class style, and make the acquaintance of a very pleasant and agreeable bee-keeper.

The pasturage about here, though good, is not nearly so good as in some of the places we had visited, and it was because M. Mermey had such a good demand for honey that he was establishing an apiary at Rumilly, which he could conveniently reach on his bicycle.

After partaking of a meal that was certainly more to our liking than any other we had had in Savoy we took leave, and determined to spend the rest of the day in sight-seeing. After depositing our luggage at the 'Hôtel de Genève' in Aix, we went down to the Lac du Bourget, and made an excursion in a steamer to Haute Combe, a Cistercian monastery at the foot of the Mont du Chat. This was quite one of the lions of the place, and was well worth a visit, having been formerly the burial-place of the Princes of

Savoy. One of the reverend fathers accompanied us, and showed and explained all the curiosities. In the church were the monuments of Amadeus V., VI., VII., Humbert III., Boniface of Savoy, who was Archbishop of Canterbury, and many others. The place now belongs to the Italian Royal Family, and was frequently visited by the late King Victor Emmanuel.

(To be continued.)

Correspondence.

The Editors do not hold themselves responsible for the opinions expressed by correspondents. No notice will be taken of anonymous communications, and correspondents are requested to write on one side of the paper only, and give their real names and addresses, not necessarily for publication, but as a guarantee of good faith. Illustrations should be drawn on separate pieces of paper.

Communications relating to the literary department, reports of Associations, Shows, Meetings, Echoes, Queries, Books for Review, &c., must be addressed only to 'The Editors of the "British Bee Journal," 17 King William Street, Strand, London, W.C.' All business communications relating to Advertisements, &c., must be addressed to Mr. J. HUCKLE, Kings Langley, Herts (see 1st page of Advertisements.)

* * * In order to facilitate reference, Correspondents, when speaking of any letter or query previously inserted, will oblige by mentioning the number of the letter, as well as the page on which it appears.

IN THE HUT.

'The humble-bee the wide wood-world may roam;
One feather's breadth I shall not stir from home.'

RICHARD JEFFERIES.

[610.] Not with lamb-storms rattling about and filling one's windward ear with hail-stones, instead of the dulcet spring tones of bird-song and bee-hum; not with snaps of cold sandwiched between spells of sun-hine, that make one wheeze and whistle with bronchitis like a distant chorus of woodland warblers! Oh, shade of Hoge! where is now thy compound of Murrubium-cum-mel (otherwise horehound honey)? Time was when I wanted an extract of horehound, but could only obtain the herb; the *materia medica* knows it not, yet the ancients made great use of it to remove obstructions from the lungs, in consumption, and in cases of hacking cough. 'X-Tractor' is one of those old-time believers, and thinks that those who went before us certainly knew one or two things—items of wisdom; therefore why should we not credit them with a knowledge of the virtues of the white horehound plant amongst the very few things they did know? So, if you want to cure a cough, ask a herbalist for some of it, boil it down to an extract, and mix with honey. Spirit will also draw its virtues from it.

Some odd days, in this miserable, bleak part of Yorkshire, really do seem fine ones, and then a sneaking visit is paid to the hives, and an entrance effected by the back premises (parallel dummy-board), an empty comb is extracted (yes!), and one substituted for it, over one side of which pea-meal has been 'shaken and well rubbed in.' A bottle is stealthily refilled with syrup (on the slow system), and placed over feed-hole; then, like miscreants who have done

some wrong, a quiet retreat is beaten. Some odd days the sun shines, and the crocuses, wonderful hygrometric foretellers of a few rays of sunlight, open and spread out their fan-like stigmas of saffron for the heat-beams, which will bring on their lines the bee from the hive. Then, again, the bee-keeper skulks out, and glancing about to see that he is unobserved, takes from his pocket a packet bearing a yellow cover. To the old lady, peering behind the window-blind, it seems that he is 'giving them snuff,' and with a mournful sigh of charity and a strange shake of the head, she turns away full of pity for the friends and relatives of the poor fellow who pours snuff into his hives and medicates his flowers with pea-meal. Never mind, my dear neighbour; who has such crocuses and spring flowers, self-sewn—not renewed year by year from 'sales of Dutch bulbs?'

How often a scarcity of bees accompanies a splendid season for honey! This year, to hint at a well-known phrase, 'bees will be BB,' and we must work right up to the elbow for early swarms or strong stocks by all sorts of stimulating treatment consistent with safety, but in our garden only outside frames shall be disturbed.

I hope your readers will not forget 'Hooker's device' as explained at the recent meeting of B.B.K.A. In short, it is a box made to hold one, two, or more frames. Down one corner, open at bottom, is a tube; down tube pour syrup (pour sirop), and as it (the syrup) slowly ascends it fills the cells, gradually expelling the air the while. This is a simple, safe method of feeding in tricky weather, such as we are now having.

I do not know that 'X-Tractor' will be trespassing on an any one's pseudonym when he makes a few remarks upon that useful article—'the smoker'—I mean the man, not the machine: 'Man, the machine.' I mean the smoker who smokes tobacco, and dispenses with the tin utensil. He dispenses the pungent fumes amongst his frames, fragrant with tobacco:—

'Divine in hookahs, glorious in a pipe.'

Really, my bees will not be near so mild with me with anything so well as with tobacco; at times rebellious, they can be 'sent down' with a ring and a bang. 'If tobacco be there, I have never a care.' The soothing fumes of fustian are soon forgotten. The old familiar twang of carbolic is soon, as with us, 'rather liked if anything;' but for really pleasant manipulation commend me to my pipe stuck through a hole in the veil, replenished and used on the bees at pleasure. Then again, if at no other time, the bee-keeper gets a really good smoke at each manipulation—pipe after pipe in quick succession—he knows about it.

The studious and inquiring have a nice problem before them: How is it stocks, for no apparent reason, pop off *en masse*, and join the ranks of their deceased progenitors? I was examining the bees in a bee-garden on Easter Tuesday, and found whole brood nests filled with dead bees on plenty of stores, thick-walled hives well protected and packed with quilts. The presence of

young or old queens does not come forth as a factor in such cases as these; the bees were dead with all surrounding conditions present to enable them to keep alive. One is always expected to assign a reason for anything curious or abnormal about honey-bees, so I thought in this case that as there was excessive 'abominable detention' (to use a Partingtonism), the cold weather, continued for during nearly three months, had prevented the bees leaving the hive to void fæces, and as this act generally requires muscular contraction of the abdomen when on the wing, the poor things died because they were not 'allowed to go out.'

I see wax has gone up in price, and like the almanac writers of the stamp of Zodiac (I don't mean Zadkiel) I will try to fit in the facts *after they have occurred* with my prophecy. As to the coming honey season, the signs in the heavens tell us (?) the weather we have had is just what we might have expected, and that the longer it continues unpropitious, the greater are the chances that when we do get a peep into spring, the spring will be a bound, flowers and fruit will abound also. By the way, do seasons ever take their names from seasonal conditions? Does Easter get its name from easterly winds, for example, just as a receptacle for honey gives its name to—X-TRACTOR?

WINTERING BEES.

[611.] Referring to your footnote to my letter (No. 605, p. 164), I wish to say that I conclude seven frames to be the right number to winter bees on, because I have found they do not build up so well in spring on a larger number, presumably because they are unable to keep up the heat in a larger space in thin hives. For the same reason I should prefer six frames for wintering on, except for the difficulty of getting stocks in autumn into such a small space, and also six frames do not hold quite enough food to winter on without running a risk of scarcity. If a hive is extra strong in the autumn I raise a dummy, to allow the bees to cluster between it and the hive-side. As the cold weather advances they retreat to the combs, when the dummy can be dropped.—ARTHUR J. H. WOOD, *Bellwood, Ripon.*

BALANCE-SHEETS.

[612.] From time to time contributors send for publication in the *B.B.J.* balance-sheets of their bee-keeping, and although an experienced bee-keeper is not misled by such, yet I fear there is danger that those who are thinking of starting the hobby will get the idea that much larger profits are made than is really the case. In last week's *B.B.J.*, for instance, 'C. H. W.' (604, p. 164) publishes most excellent results for so poor a year, in fact he shows over 200 per cent. profit; but, unfortunately, the balance-sheet is incomplete, as no account is taken of how much the stock had cost at the beginning of the season, and how much it was worth at the end. In my

experience of an apiary of 100 stocks it is needful to deduct a large sum (at least twenty per cent. per annum) from the cost of hives, extractors, &c., as they not only wear out but become old-fashioned and practically unsaleable in a few years. I believe 'C. H. W.'s' profit, from a business point of view, is really about half the sum shown. I hope he will not take this note as finding fault, for I think he is to be greatly congratulated on obtaining, even according to *my* figures, so handsome a result. It is well to bear in mind that many hobbies show enormous profits for one year, but that if an average of, say, four years be taken the results are very different. I should be glad if you, Mr. Editor, would criticise in a footnote all the balance-sheets which you publish.—E. J. GIBBINS, *Neath, April 3rd, 1891.*

[We did not regard the communication on p. 164 as a 'balance-sheet,' but simply as a statement of expenditure and income—a 'bee-account for 1890' as it was designated by the writer—and as such no fault could be found with it. No doubt in striking a balance it would have been better to give value of stock at beginning and at end of year; but it would come with a bad grace from us to take upon ourselves to criticise keenly such communications as bee-keeping readers are good enough to favour us with, and would, we fear, rather tend to discourage them from sending in reports at all if they were to be regularly held up to editorial criticism in the way our correspondent suggests.—Eds.]

NOTES BY THE WAY.

[613.] The weather in West Berks continues cold, scarcely a bee moving during the past week, and of those that have braved the elements many have been blown down and chilled; a change to warmer weather will be appreciated by both bee-keepers and bees. I notice that 'bee-escapes,' or super clearers, as we more commonly term in this country, are receiving commendations from the bee-keepers who have used them in America during the past year. The horizontal escape appears to hold the field, and has proved a success in the hands of several prominent bee-keepers; so much so that they assert that it has 'come to stay.'

Referring to what 'Bee-Kay' says ament shows, and their failure to be ready by the opening of the gates, the schedules always state a specific time when all honey, appliances, &c., are to be staged ready for the judges, but only those who exhibit and the secretary and acting committee know of the many difficulties that have to be surmounted before the exhibits are staged. The railway companies, with the large amount of extra work on their hands (I am speaking of large agricultural shows) are thrown into confusion. As an example, to illustrate what I mean, I will take the Royal Counties' Horsham meeting, 1889. There the company had erected temporary offices, and engaged or drafted a staff of hands specially for the goods, &c., going to the show-yard, which was some three miles from the station. If I take my own

case it will suffice. I had consigned several cases of honey to the show some days previously, so that there should be no hitch when I got there, the day before the show, and expected to find all ready to be carted to the show-ground under my own superintendence; but on inquiry I could hear no tidings of my consignment, but was buoyed by the assurance that trains would be coming in all night from London, and I had better look down early in the morning. Asking what time they would be open, as I intended to be one of the first next morning, the manager told me they should be on duty all night. Accordingly I was astir early, and with the aid of a porter uncovered several trucks of goods, all marked 'show,' and at last found my cases. These I managed to get transferred to a van, with the promise that they should form part of the *next* load to the show-ground. This was about 6.30 a.m. I then got breakfast in the town, and started for the show-yard, and then had to wait until nearly eleven o'clock before my honey was delivered at the tent, and it was only by dint of having everything in readiness to stage before I left home that I was enabled to stage some four to five hundredweight of honey in the various classes, with only a few minutes to spare.

This will give 'Bee-Kay' a glimpse of some of the difficulties that have to be overcome by exhibitors who are on the spot to stage their own exhibits. How much more difficult it must be for a committee or secretary to have to arrange exhibits only just to hand in time for staging, when they have to feel their way, so to speak, with the exhibits. I don't think there is anything gives a secretary so much pleasure as to have all in readiness for the judges on their arrival. I have noticed many times how thankful they have been when there has been a little time to spare, so that a few plants could be interspersed among the exhibits, or a few finishing touches given to the exhibits where required.

Metal Ends.—Have these been made two inches wide yet for super compartments? 'If not, why not?'

Hardy annuals, if not already sown, should be got into the ground at once; also wallflower seed sown now will grow strong, bushy plants for another spring. This is one of the best early bee-flowers, and what can be more refreshing to the bee-keeper than inhaling its sweet perfume when working amongst his bees?—two excellent reasons why it should be grown in every apiary; and if you have spare plants, don't throw them to the waste-heap; give them away to your neighbours, and so increase the breadth of your bee-garden while extending a friendship with your neighbours. Only those bee-keepers with a good number of hives near or in a village, and close to a high road, can understand how essential it is to cultivate neighbourly and friendly feelings, so that when swarms intrude on your neighbours' gardens you can secure the same without any fuss. Then, later on, the gift of a little honey to the little folks, and in the winter, if your neighbour

suffers from sore throat, a little honey works wonders; in fact, it is '*Mel sapit omnia.*'—W. WOODLEY, *World's End, Newbury.*

QUEENS PASSING THROUGH EXCLUDER ZINC.

[614.] In answer to Mr. Woodley's inquiry (582, p. 128) for particulars about the queen-excluders used, the hives named are not bar-frame hives, but Scotch box hives, 12×12×9 inside-measure, with fixed bars on the top; the ends rabbeted on the inside to bring the bars level with the sides, and a crown board screwed on, to take off in summer. There are also box supers, 12×12×4, with bars for tiering. The excluder zinc was nailed close on the top bars, with projecting sides bent down around the outside of hive, so it was impossible for the queens to get through except by the perforations in the zinc, of which I send a sample.—ALPHA.

[The sample of zinc is not a good one for use as queen-excluders. It is coarsely made, and the perforations are not regular, some being larger than others—sufficiently so to admit of very diminutive queens pushing through. The most perfect form of

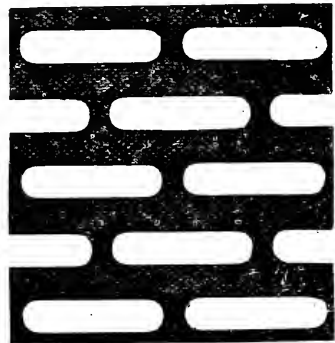

excluder we know of is that of which an impression (taken direct from the zinc itself) is given above. It is one of several patterns made by Dr. Tinker, of Philadelphia, and there should be no difficulty in having it manufactured in this country if dealers in bee-appliances would take the trouble to move in the matter.—EDS.]

BEEES IN CUMBERLAND.

[615.] It is long since I sent a line to your delightful *Journal*, whose coming I look forward to every Thursday. Last summer my bees did very badly; there was little to record but continuous rain. I took about 60 lbs. of honey from fifteen hives. I gave it back to the bees, and bought 2 cwt. of Egyptian cane sugar, and made as much into syrup as they would take down. This was done rather too late in the autumn, as my bee-man had to finish with the harvest before he could help me to take off the supers, which were well worked out with cells, but had little honey in them—very few perfect sections. I never saw more clover in the fields or more wild flowers in the hedges, but being always

wet, they were of little use to the bees. In January last I made a slight examination of the hives, and found one colony dead and several with very little or no food; so took out a frame or two and filled in with sections, in this way giving from 6 lbs. to 9 lbs. of honey to each hive. All have looked very flourishing ever since. On the 21st inst. I began syrup-feeding, having to get my bees ready for the sycamore bloom, and five of my hives being Abbott's old pattern, with large tapering frames, they hold a great quantity of bees, but they give the best results; one of them in a good summer gave me 154 lbs. of honey in sections. I never feel quite content unless my hives average 100 lbs. of honey each. I began bee-keeping in 1881 with four skeps, which each swarmed three times. In the autumn an expert came and put all into three of Abbott's large hives. Since then, taking good and bad years together, I have had nearly 4000 lbs. of honey more than it was possible to either sell, use, or give away. One year I sold 16l. worth, but generally I cannot get it sold at all, and so give it away. If any of your readers find mice troublesome to their bees or to crocus bulbs, or in their houses or out-houses, cork shavings, or thin discs cut from old corks, and fried in bacon fat, till, as cooks say, a nice brown, and placed about where mice or rats come, the creatures will eat it, and it will destroy them: dogs, cats, and poultry are said not to touch it.

I should be glad if the inventor of the funnel-shaped super-clearer would tell me what the consequences would be if the queen was up in the super when the 'clearer' was on and the bees coming out of it. Would it be advisable to give a puff of smoke to the bees before lifting off the super—a sort of notice to quit to Her Majesty? Having a great number of sections filled, or partly filled, with comb, the queen is very likely to go up, and I have an objection to excluder zinc.

My bees are all perfectly healthy; we have never had foul brood in this neighbourhood. I consider the secret of getting plenty of super honey is in having plenty of bees in the hive, plenty of flowers in the neighbourhood, and plenty of warm wraps over and around the supers. I use chaff cushions, thick, new felt druggot, and newspapers. I have my hives washed out with carbolice soap and water every spring, not long before putting the supers on. Most of them double-walled hives, the single-walled hives have sheds to cover them. The bees are wintered on all the frames, and with no winter passages except what they make for themselves.—BEE SWING.

ODD THOUGHTS.

[616.] In *Gleanings* (American) a few weeks back, something was said about beetroot sugar being as good as cane sugar for feeding bees. Professor Cook endorsed it, producing scientific evidence that beetroot sugar is identical with cane sugar, and that it is suitable for feeding

bees. We, on this side, are of a different opinion. I, myself, about 1879 or 1880, lost over twenty stocks by spring dwindling, caused, I and others had no doubt, by feeding up after a bad season with cheap (beet) loaf sugar.

I have procured one of Mr. Flood's beescapaces, and I think it will answer its purpose well; of course, I have not tried it yet.

Now, while I think of it, I hope to make some reversible floor-boards for some of my hives for another winter; something like Dr. Miller uses in America, with a two-inch rim for the hive to stand on for winter, and to be reversed for summer use, only having three-eighth inch strips for the same purpose.

Queen Wasps.—I have found two or three that had crept in amongst some of my appliances this spring—winter, I may say, although spring time of year. Other years I have found them many times between boards, tiles, &c. I do not think they feel the cold at all. I think they really do hibernate—not so the bees; at least, that is my opinion.

What will the season of 1891 prove? There's the rub. I see some have prophesied that we are to have a cold, wet summer. All bee-men will hope this forecast may prove a false one.

What a fuss about native bees *versus* foreigners. All I can say is, if there is any honey about, the foreigners are bound to be amongst it, but if there is very little, like last season, with us, how can either kind get it?

Excluders.—I like them for extracted honey, to keep queens out of the boxes; also it prevents the bottom of frames being joined to the top of the brood frames. Likewise for comb honey, the excluder, with me, saves a lot of trouble by doing away with burr combs.

Winter Passages.—I never cut any in my combs, neither do I place any device on top of frames for passages; but another winter I may place something over, and that will probably be a good large cake of candy, not *too soft*.

Years ago I have kept driven bees, of course, giving them some ready-built combs and a small quantity of syrup, and then placing a large lump of loaf sugar, cut off a sugar loaf, on top of frames, and covering up warm, and the bees wintered exceedingly well. This was before Simmins' dry-sugar feeding came into vogue.—JOHN WALTON, *Honey Cott, Weston, Leamington.*

BEE-HOUSES.

[617.] I am thinking of putting up a bee-house against a wall facing south. One side of the house would be formed by a wall ten feet high, facing east, and forming the fence to a road—in fact, the main street in our village.

1. Will the bees from this house interfere with passers-by in the road?—and if so what distance from the road would it be safe to put the house along the inside of the wall facing south? 2. Would two feet between entrances to hives in house be too close?—if so what would be a safer distance? 3. I would be glad to know if you have a back number of *B. J.* giving

a description of a good bee-house to take ten or more hives in one row?—DORSET BEE-KEEPER.

[1. If there is a wall or close fence nine or ten feet high over which the bees must pass in their flight from the hives, no danger need be feared to passers-by, as the bees will fly quite clear of the road. 2. Two feet is as far apart as we find entrances in most bee-houses, unless the style of house as shown in

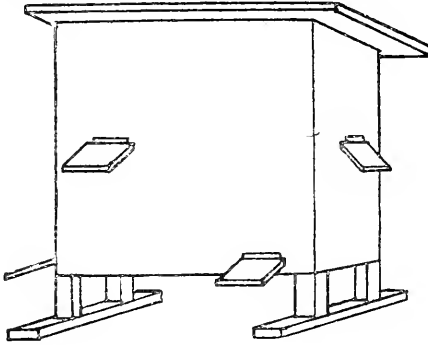

sketch be adopted. In this the entrances face in several directions and are kept wide apart. 3. A good form of bee-house for holding a large number of hives was fully described in *B. J.* for April 10th, 1890; unfortunately, however, that number is now out of print. The annexed cut taken from the

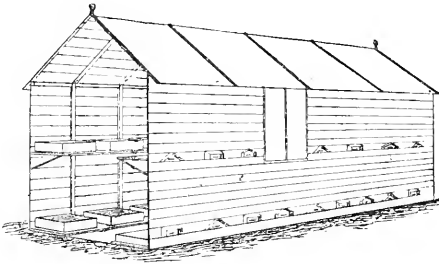

article referred to, will give an idea of the form of the house. Then there is the portable house for holding seven hives, described on p. 367 of *B. J.* for July 31st of last year. We have never seen a lean-to bee-house, such as you suggest. Indeed a structure of that kind would be more properly described as a bee-shed for keeping the hives dry.—Eds.]

WEATHER REPORT.

WESTBOURNE, SUSSEX.

March, 1891.

Maximum, 55° on 1st.	Rain:—2.65 inches.
Minimum, 24° on 22nd.	Heaviest fall, .55 on 9th.
Min. on grass, 17° on 31st.	Rain on 20 days.
Frosty nights, 15.	Average, 5 years, 2.22.
Mean max. 43°	Sunshine:—96.85.
„ min. 33°	Brightest day, 8.30 on 3rd.
„ temp. 33°	Sunless days, 6.

Remarks.—A dull and very cold month. The snowstorm of 9th and 10th produced, when

melted, exactly one inch, equal to about one foot of snow. Since the first, there has not been a single day on which it has been warm enough to open the hives. Many have lost their bees this month.—L. B. BRKETT.

Queries and Replies.

[338.] *Changing Hives and Disinfecting Combs Annually.*—1. I suppose it is well to shift the frames into clean hives annually when cleaning floor-boards, and what time do you consider the best for it, spring or autumn? 2. When surplus combs and frames are scraped and cleaned, what process should they undergo in the way of fumigating, &c., to render them safe for future use (of course I don't allude to foul-broody combs, but healthy ones), and the proper way to do so?—F. JELICO.

REPLY.—1. It is not at all necessary to move bees into clean hives annually if they are kept in generally good condition, though, if convenient, it is a good plan to clean each hive thoroughly while temporarily denuded of bees. May is the best month to do it. 2. The same with store combs: it is safer to guard against harm by fumigation with sulphur-fumes or by syringing with salicylic acid solution before storing them away; but if they are known to be clean, healthy, and free from moth, it becomes a matter of time and convenience whether they are so treated or not.

[339.] 1. *Painting Hives.*—I have nine stocks in frame hives. I want to put these into makeshift hives while I clean and paint. I have not enough makeshifts to do all at once. Please say how soon may I with safety begin, and how long may they remain in makeshift hives while I clean and paint? 2. Bees are feeding well on candy. When may I with safety start on syrup food?—J. T. N.

REPLY.—1. There is no need to remove bees from hives while painting the latter. If the fronts are painted after the bees have done work for the day, the other parts may be done at any time. If, however, it is more convenient to do the painting indoors, we should defer it till weather is more settled, and frosty nights are less frequent. The bees might with safety be left in makeshift hives if warmly packed and protected from wet. 2. Any time now.

[340.] *Beginning Bee-keeping.*—Being desirous of trying my hand at bee-keeping, I bought three hives in December last, having no previous knowledge whatever of the subject. One hive is of wood, fourteen inches square, with two square boxes inside; the other two are skeps. I left them as they were all winter, and in February I found bees were issuing from one of the skeps, but the other two were dead. The bees in the living stock carry in pollen busily on fine days, and as I have made a frame hive I would like to put them into it, if I knew how to set about the job. 1. Can you tell me

how? 2. Will the bees want feeding now, and, if so, with what food?—R. H. F., *Foot's Cray, Kent.*

REPLY.—1. Gain more experience before attempting to transfer bees. Allow them to swarm naturally, and hive the swarm into your new hive (standard size, we hope). 2. If food is short, give a one-pound cake of soft candy, which can be bought from any dealer and sent you by post for a few pence.

[341.] *Bees in a Tree.*—I have just discovered a swarm of bees which must have wintered in the fork of a tree about three hundred yards from my apiary. They are about twenty feet from the ground, and could be easily reached by a ladder. Would it be possible to drive them, and if so, how should I proceed? They seem strong and healthy, and appear in great numbers on sunny days.—(Mrs.) C. N., *Co. Derry.*

REPLY.—The task you propose undertaking is a difficult one for an experienced bee-keeper, and in the absence of any actual knowledge of the 'conditions' to be faced, it is impossible for us to give instructions such as could be carried out by a lady. In fact, we cannot do more than advise calling in the help of some strong man accustomed to handling bees, and let him do the work.

Echoes from the Hives.

Keswick, Cumberland, March 20th.—My eighteen stocks have wintered safely, and after the long frost have only shown very slight symptoms of what may be dysentery, while they flew as vigorously on New Year's Day as if it had been June, after being confined from early in November till the last day of 1890 through frost. New Year's Day, 1891, was the warmest I ever remember in mid-winter and the 'outing' did the bees good. Afterwards they had another spell of confinement for a month, followed by several weeks when they were on the wing almost daily, busy on the crocus, in which I had put artificial pollen. March has brought another change of weather. Strong winds, hills around us covered with snow, but in the vale of Keswick the fields were only once covered with snow during the six weeks' frost. I have done no examining yet further than glancing at the tops of combs to see that all was right. Bees here did not do much last year in the way of surplus honey. A few, whose stocks are close to the heather, got some and did not forget to charge an extravagant price for it. Other bee-keepers, myself included, had the consolation, however, of being saved expense in feeding up, for the bees got enough for themselves and to spare in the brood combs, though the sections were almost empty. I left my stocks on all their combs and with all the food they had gathered, and am hoping that, as we have

only had one good year out of the last three, we shall have a good reward in 1891.—BEE-ROBIN.

TRADE CATALOGUES RECEIVED.

GEO. NEIGHBOUR & SONS, 127 HIGH HOLBORN, LONDON (64 pp.)—Messrs. Neighbour's catalogue is, as usual, very full and complete. It contains over one hundred illustrations, comprising almost everything required by bee-keepers. We are glad to see this firm, in addition to the manufacture of high-class goods for which they have so long maintained their good name, are turning out hives in the cheaper forms adapted to later notions of economy in bee-appliances. That Mr. Jas. Lee still continues at the head of the manufacturing department is a guarantee for the accuracy of the work turned out.

W. P. MEADOWS, SYSTON, NEAR LEICESTER.—Another excellently got-up thirty-two page list, descriptive of bee-goods. Formerly Mr. Meadows made a speciality of tin-work for bee-keepers, and his extractors, feeders, &c., had, and have, a very high reputation. Recently, however, he has erected steam-power wood-working machinery of the most modern construction for hive-making and general bee purposes. Several novelties for the coming year are also depicted among the capital illustrations the list contains.

IN AN OLD GARDEN.

Yellow roses, purple pansies,
Tufts of heavy-headed stalks,
Either side the quaint old gateway—
Blazing torch-like hollyhocks.

Sweet-peas tossing airy banners,
Saintly lilies beuding low,
Daisies powdering all the greensward
With a shower of summer snow.

Boxwood borders, yews fantastic,
Wallflowers that with every sigh
Spill such scent that e'en the brown bees
Reel with rapture, wandering by.

And the pear-trees, long arms stretching
O'er the sunny gable wall,
Scarce can hold their ruddy nurslings,
Ripening where the warm beams fall.

Oh! the ecstasy of living,
How it thrills my heart to-day!
I can almost hear the flower-bells
Tinkle where my footsteps stray.

In a garden God first placed man,
There first woke love's magic thrill;
And methinks a breath of Eden
Clings to earth's old gardens still.

MARIA HEDDERWICK BROWNE.

—*Girls' Own Paper.*

Notices to Correspondents and Inquirers.

Letters or queries asking for addresses of manufacturers or correspondents, or where appliances can be purchased, or replies giving such information, can only be inserted as advertisements. The space devoted to letters, queries, and replies, is meant for the general good of bee-keepers, and not for advertisements. We wish our Correspondents to bear in mind that, as it is necessary for us to go to press in advance of the date of issue, queries cannot always be replied to in the issue immediately following the receipt of their communication.

All queries forwarded will be attended to, and those only of personal interest will be answered in this column.

MOORLAND.—All three samples of sugar sent are good for bee-food.

L. S. (Alton).—Any dealer advertising in our pages will supply you with the long-hole pattern of excluder zinc, which is the right kind for bees.

H. S. (Tarbolton, N.B.).—The articles on 'Queen Rearing,' by Mr. H. Alley, were discontinued in May, 1889, because the author ceased sending on advance proofs at the time named.

JOHN SMITH (Cumnor).—1. If the stock in skep is as heavy as stated there is no need to feed the bees. 2. You can unite the cast with the top swarm by sprinkling both lots with flour.

S. G. FIELD (Crouch End).—*Straw-sided Frame Hives*.—With some undoubted advantages these have many drawbacks, which, in our opinion, outweigh the former. All brood chambers, of whatever type of hive, should be made to take standard frames. Your quotation about 'bees revelling in flower blossoms,' does not appear in our pages.

COAL PORTER (Colchester).—The condition of comb sent, though not foul-broody, shows an unmistakable want of care for the bees. The whole mass is wet and decaying, and as is usual when such corruption sets in maggots (not wax-moth larvæ) generate therein. We are sorry your loss has reached so high as fifty per cent. of the whole, and no doubt the severe winter has contributed largely to the heavy mortality.

JAMES HUTCHINSON (Cheltenham).—Comb being full of badly mildewed pollen is quite unfit for use, and should be destroyed. There is no foul brood in it.

NOVICE (Woking).—1. It is not the rule to expect swarms and honey the same year, and, in so moderate a season as that of last year, to increase from one to three stocks—all of which have wintered safely without feeding—cannot be called failure. You would do well to read some small book on the subject of bee-keeping before investing further. 2. Do not attempt transferring; allow one skep to swarm naturally, and super the others as last year. 3. The frame sent is not a correct 'standard size,' nor is it a very well-made one. 4. For syrup-making and feeding refer to *B. J.* for January 15th and 29th last, pp. 26 and 50.

R. W. (Cinderford).—Comb sent contains chilled brood and pollen only, not foul brood. We attribute your loss to syrup being made too

thin and from beet sugar, together with some fault in packing which caused the combs to be 'wet and unhealthy-looking.' Melt down any combs containing dead brood, and only use such as are clean and wholesome.

WOULD-BE EXPERT (Hutton Ruddy).—Mr. J. Huckle, Kings Langley, Herts, will supply information as to qualifying for examination for experts' certificates.

* * * Reports of Worcester and Irish B. K. Associations will appear next week.

THE DEPOSIT SYSTEM.

British Bee Journal and Bee-keepers' Record.

OFFICE: KINGS LANGLEY, HERTS; AND
17 KING WILLIAM STREET, STRAND, LONDON, W.C.

The following are the Rules under which we are prepared to receive Sums of Money on Deposit from persons buying and selling goods.

In order to save trouble it is requested that the Rules be carefully read over by persons using the Deposit System of trading.

DEPOSITING.

1. Method.—When strangers are dealing together, the purchase-money of the articles is deposited at our office. We acknowledge receipt of the deposit to both parties, and hold the money until we are satisfied that the purchase is concluded. If a sale be effected, we remit to the seller the amount deposited, less a charge of 6d. and the expenses of Post Office Orders and postage, &c. Cash will be forwarded by cheque, Post Office Order, or by Postal Order as preferred. If a sale or exchange be not completed, we return the amount deposited, after making the same deduction. By this means buyers and sellers are secured from fraud.

2. Deposits.—Postal Orders (drawn on General Post Office) and Cheques must be made payable to John Huckle, and crossed 'Bucks and Oxon Bank.' The numbers of the Postal Orders should be kept by the sender. We cannot be responsible for any losses that may occur in transit.

3. Honey on Approval.—All honey will be sold by sample, which must be sent direct to buyer.

4. Bee-appliances.—In ordering, the time allowed for completing the order to be stated to us when sending cash. If maker accepts, we hold cash till transaction is satisfactorily completed, when the amount will be remitted subject to conditions as in Clause 1.

5. Bees and Queens.—These will be dealt with entirely by the parties concerned, so far as price, &c., goes, and when the purchase is satisfactorily completed cash will be remitted as per Clause 1.

6. Goods in Transit.—These are at the seller's risk, i.e., any damage to or loss of an article on its journey is borne by the vendor; but a rejected article must be properly packed and returned by the same means as was used in sending it.

7. Carriage.—The carriage of all goods, except such as are sent by post, is payable by the buyer, unless otherwise agreed. If any article sent on approval be returned, each party to the transaction must pay carriage one way.

Tenth Edition. Nineteenth Thousand.

BEE-KEEPERS' GUIDE BOOK. Containing Management of Bees in Modern Moveable Comb Hives, and the Use of the Extractor. By THOS. WM. COWAN, F.G.S., F.R.M.S., &c. With numerous Illustrations. Fcap. 8vo., price 1s. 6d.; or in cloth gilt, 2s. 6d. Postage 2d. To be had of HOULSTON & SONS, Paternoster Square, all Hive Dealers, Secretaries to Beekeepers' Associations, and of J. HUCKLE, *British Bee Journal* Office, Kings Langley, Herts.

THE
British Bee Journal,
BEE-KEEPERS' RECORD AND ADVISER.

No. 460. Vol. XIX. N.S. 63.]

APRIL 16, 1891.

[Published Weekly.]

Editorial, Notices, &c.

THE FUTURE OF BEE
ASSOCIATIONS.

Among the annual reports of Bee Associations periodically reaching us it is depressing to find an occasional one in which the view is expressed that the work for which such Associations were originally formed has been, in a measure, completed, and the mission of the County Bee-keepers' Association having been fulfilled, that there is no need for its continued existence. Such, in point of fact, was the substance of a resolution proposed at the annual meeting of the Staffordshire Association, held a few days ago. We are pleased, however, to observe that an amendment to the effect 'that the Society be continued' was carried by a majority of two to one. The same views were given as a reason for the decline of active work in another county a year or two ago, and resulted in the Association concerned ceasing to exist.

We entirely refuse to accept this interpretation of the fact that members are falling away from and losing interest in Bee Associations. With far more reason may it be supposed that some variation in the method of working is needed beyond the no longer novel exhibition in the bee-tent and the orthodox bee-tour of the expert. It may be admitted that the art of bee-keeping has been introduced and well taught in every corner of many counties by important exhibitions of bees, honey, and appliances, as well as by the periodical tours of that curious nomadic creation of modern times—the County Expert; but there is surely more scope for the efforts of an active executive Committee than is conveyed in the very limited programme detailed above.

Why should work begin and end with the show of honey and appliances, the

bee-tent, and the expert's tour? What reason is there why the public-spirited efforts of our prospering Associations should not be shared by all others? Bee-keeping is being prominently recognised in quarters where it was entirely ignored a few years ago. The Royal Agricultural Society of England—probably the most important of its kind in the world—in its quarterly *Journal*, just issued, prints a special article on modern bee-keeping, while in the same journal in another paper, on 'Technical Education in Agriculture,' the writer says:—'There might be instituted a series of lessons in what might be termed rural economy, which would certainly attract the attention of farm labourers, and possibly of their wives as well, and if the older people were secured the children would follow. Practical instruction might be given upon the making of butter, the management of bees, and the keeping of poultry, whilst a lecture or two upon the pig would find attentive listeners. Bees, poultry, and pigs would afford safe staples to work upon.'

We quote the above because the attention of Bee Associations is just now being directed towards the grant to County Councils of an annual sum to be devoted to the furtherance of technical education; and it will be well not to lose sight of the recognition bee-keeping is thus receiving at the hands of our important agricultural societies. Applications have already been made on behalf of two Bee Associations for a share of the above-named grant, which may or may not for the present be successful; but in any case the facts we have drawn attention to will tend to strengthen the hands of those who are thus interesting themselves on behalf of bee-keeping, and it is not unreasonable to hope that sooner or later their well-meant efforts will be suitably rewarded.

Instead of taking the gloomy view we deprecate so strongly, our flourishing County

Associations are extending their spheres of usefulness in several directions, depôts are being established for the disposal of members' honey, and special attention is given to its being produced and prepared for sale in attractive form. Extractors and other of the more costly appliances are being lent to cottage members at a nominal charge, and we hope soon to see glass honey jars, &c., supplied to working men bee-keepers, to be paid for when the honey is sold.

To teach a man how to manage bees and obtain surplus honey is good, but instructing him further till the value of his produce is realised in cash is better, while continuing the educational process by loaning or supplying him with appliances of the best kind for helping him on in his work is better still. Yet this is now being done by some well-worked County Associations to-day. *They* do not say their mission is accomplished. Their complaint is that in some cases the better class of members do not infuse a little more public spirit into their bee-keeping, and continue their subscriptions though receiving no direct pecuniary benefit from membership, so as to provide the necessary funds to help cottagers and others less fortunately situated.

Nor can we avoid directing attention to the fact that the most successful Associations are those which distribute most freely the current bee journals of the day among their members. Some retain the old and rather troublesome method of issuing a limited number of journals, and these are passed on from member to member after perusal; but this plan does not work very satisfactorily, and such Associations as offer to members the option of including in their subscription a copy of the *Record* at a reduced rate freely acknowledge that the receipt of the bee-paper every month contributes almost more than anything else to maintain the interest of the recipients in the Association and its work; and it is a significant fact that the particular Association which has, probably, laid more stress on this point than any other, regularly issues nearly 300 copies of the *Record* per month among its members.

It has just been suggested by a well-known bee-keeper that we should endeavour to issue the *Record* in similar form to the parochial magazines distributed by various religious bodies, in which the main portion of the literary matter is printed in large numbers and issued with local matter added

on; and our correspondent expresses a hope that we could see our way to print the necessary few pages of Association news and matters of local interest at a small additional cost to Associations. It must, however, be pointed out that this idea is impracticable. Local printers could produce a hundred or two sheets of extra local matter for insertion in the paper at as low a cost as it could be done in London, while the trouble of attending to it here would be more than we could undertake.

We are willing to issue the *Record* to Associations at the usual wholesale rate, and print the whole (cover and all if required) on *white paper*, so that a coloured cover could be added, which cover would be available for four pages of local matter, advertisements, or whatever was most required, while the advertisements would probably cover the cost.

We urge the importance of bringing these matters forward, not from the selfish standpoint of increasing our circulation, but because we believe that much good has been done, and can be done, in the way we indicate.

BEE-PAPERS FOR WINTER READING.

No. 6.—MOUNTING MICROSCOPIC OBJECTS.

(Continued from page 171.)

Mounting in Aqueous Media.—In this way of mounting it is better not to allow the objects to become dry at all, and they should invariably be soaked for some time in the medium before they are mounted to enable it to thoroughly penetrate the tissues.

Various media are employed, but for our purpose there are two which are the most useful. These are glycerine and glycerine jelly. Most of the objects can be mounted in glycerine, and that will be found the most satisfactory. For this method of mounting we prefer the insects freshly killed and soaked in diluted glycerine for a few days. They are then transferred to a stronger solution of glycerine, until they can be finally put into pure glycerine. We generally begin with a thirty per cent. solution, then go on to sixty per cent., then eighty per cent., or even undiluted, according to the size of the object. The reason for this is that the glycerine may gradually penetrate all the tissues, and take the place of the fluids, which it does not do so readily if used too strong at first.

Objects that have been preserved in glycerine and acetic acid should have all the acid washed out, and this is best done by allowing the preparation to soak in water and then put it into glycerine. All objects in glycerine should be mounted in cells of suitable depth, and much more care is needed to exclude air bubbles than

when mounting in balsam. In fact, sometimes it is impossible to do so without the use of an air-pump; but the risk of air bubbles is very much diminished by long soakage in glycerine if commenced with a diluted solution and gradually increased to the pure.

We place the preparation that has had all the superfluous matter removed in the centre of a suitable cell, and drop pure glycerine upon it by means of a glass rod. We then put a little varnish or gold size round the edge of a thin cover glass, and drop this down upon the walls of the cell. We have found a convenient method of holding this glass was to put a little beeswax on the end of the stick of a camel's-hair pencil, and pressing this on the glass causes it to adhere. When in position the stick is easily removed by giving it a twist, which separates it from the glass without displacing the latter. Very little pressure must be used, but sufficient to make the glass adhere to the cell-wall and force out the superfluous glycerine. This is soaked up with a little blotting-paper and the remainder removed with a camel's-hair brush and water. When this is done, and the slide is free from the greasiness caused by the glycerine, a very thin ring of gold size can be put on, using the turntable. In this first application we must be careful to use very little gold size, otherwise it is liable to run in and spoil the slide. The object can then be put on one side for a few days and another ring applied, and when this is quite hard it can be finished off with asphalt varnish.

During preparation the object should be examined under the microscope, and before the first ring is put on, if any air bubbles are found, either put the object back into glycerine and begin again, or place it under the air-pump until the air bubbles are removed.

Mounting in glycerine jelly is more troublesome, and requires much practice to attain good results. In using this cells are not required, except for very thick objects. The jelly, which is usually sold in small bottles, is warmed in a water bath, and must only just be melted, any extra heat being detrimental. The object should be soaked for some time in some of this jelly dissolved in water, and then placed on the glass slip. Remove the excess of liquid, and pour some of the melted jelly on the object. For this purpose we use a glass tube, drawn out to a point. The tube is warmed and plunged into the warm jelly, which rises in it. The upper end of the tube is then closed with the finger, which, on being removed, allows the jelly to flow out. Allow a liberal quantity to flow over the object, and gently lower the cover glass upon it, pressing it down into position. It sets almost immediately, and the excess of jelly can be scraped away and washed with water. The edges should be covered with rings of varnish. Rapidity of operation is requisite for mounting in this way, as the jelly soon becomes set. The setting can be retarded by warming the slide and cover glass.

Another way where objects are thick is to cut out a piece of the jelly and put it upon the

object. Then gently warm the slide, when the jelly will diffuse itself through the object. Some objects are improved by being boiled upon the slide, and this method gets rid of air bubbles, but is not suitable for every preparation, as some would be entirely spoiled by boiling. If the object is to be boiled, a clip must be used to hold the glass in its place. A special clip is made for this purpose, and is called Smith's mounting clip. It has a set screw, so that pressure can be regulated. The slide is then held over the flame of a spirit lamp, and it will be noticed that it begins to bubble from the centre outwards. The slide must be carefully watched, and a distinct crack will be heard. This is a critical moment, and the slide must at once be removed and placed upon a cold surface. The jelly soon sets, and air bubbles will be absent. If the proper moment is missed the slide will be spoiled by over-boiling, or the bubbles will not be expelled if insufficiently boiled. These slides may have white zinc varnish rings put on first instead of gold size if preferred; but we like in any case to finish them off with asphalt varnish.

There only remains now to finish our slides by cleaning them and putting on rings of coloured varnish according to the mounter's fancy. Then stick on a gummed label describing the object, and stating the medium in which it is mounted.

Objects mounted in glycerine and fluid media require a fresh ring of asphalt varnish run round them from time to time, as they are liable to leak. Some prefer to cover their slides with coloured papers instead of using ground-glass slips. Those who do so can use ordinary rough-edged slips and square cover glasses, as these are a trifle cheaper than the others. Coloured paper gummed on one side is cut into pieces $\frac{3}{4} \times 1\frac{1}{2}$ inches. A circular hole is then punched in the centre, a little smaller than the square cover, and the paper is then stuck on to the under side of the slide, so that the hole may come exactly in the centre. The corners are then cut off and the edges folded over the glass slip very tightly. After all the four edges are brought over, an ornamental cover, which can be purchased of the opticians, must have a circular hole, a little smaller than that on the under side, punched in the centre, and can then be stuck on. These covers are generally gummed on the under side and gilt on the top. A label then completes it.

There are, of course, many other media which may be used, but the principle of mounting is the same as described, and it is only by practice and experiment that the mounter can arrive at an idea of the best medium for a certain preparation. As we have already stated, some objects should be mounted various ways for comparison, and some show details in one medium that would be entirely lost if mounted in another.

We will now proceed to dissect our bees, and can at the same time mention the best medium for preserving each part.

(To be continued.)

WORCESTERSHIRE BEE-KEEPERS' ASSOCIATION.

The eighth annual general meeting was held at the Guildhall, Worcester, on April 1st last—Mr. C. H. Haynes, of Hanley Castle, in the chair. The attendance was not large.

Before the ordinary business was proceeded with, the following resolution was proposed by the Chairman and carried:—‘That this meeting desires to place on record its deep sense of the loss the Association has sustained by the death of the President, Earl Beauchamp.’

Mr. A. H. Martin, the hon. sec., then read the report for the past year, which stated that owing to the poor honey season last year the Committee had not deemed it expedient to hold a show of honey, &c. The report also expressed regret that from the same cause the number of members had decreased. Notwithstanding this fact, however, the Association is in a sound condition financially, the balance-sheet showing a balance of 2*l.* 16*s.* 9*d.* in the hands of the Treasurer.

The Rev. E. Davenport, in moving the adoption of the report, thought that notwithstanding the falling-off of members, and the dark outlook which the Association had at present, they had a great deal to congratulate themselves upon. The funds had been sufficient to meet the expenses, and through good management they had a balance on the right side. He thought there was every prospect of their having an abundant honey season this year, and that, no doubt, would give a stimulus to the Society.

The Earl of Coventry, the new Lord-Lieutenant of the county, was unanimously elected President.

In consequence of increasing professional duties Mr. Martin was compelled to resign his post of Hon. Sec., and the Rev. E. Davenport was elected in his place.

The Chairman proposed a vote of thanks to Mr. Martin, and in a few appreciative remarks expressed the indebtedness of the Association to that gentleman for the services he had rendered to the cause of bee-keeping.

It was afterwards suggested that steps should be taken to present Mr. Martin with some mark of their appreciation of the service he had rendered.

Mr. Martin, who has been connected with the active work of the Association since its formation in 1873, replied in a few appropriate words; and after the election of Messrs. Haynes and Davenport as representatives to the Quarterly Conference, and of Mr. Martin to represent the Association on the Committee of the B.B.K.A., the proceedings were brought to a close.

The annual ballot for hives resulted in Messrs. J. Partridge, of Alvechurch, and S. Tombs, of Droitwich, being declared the winners.

IRISH BEE-KEEPERS' ASSOCIATION.

The annual general meeting was held on the 2nd inst., Mr. J. K. Millner in the chair. The

report, which was adopted, states that the year 1890 was discouraging to bee-keepers, the wet and chilly summer having proved most unfavourable to the production of honey, especially where none could be obtained from heather. There had been, however, no diminution in the work accomplished by the Association, but, on the contrary, in that most important department of its work—promoting the knowledge of bee-keeping—distinct progress had been made.

Mr. C. N. White, a well-known and experienced apiarist, kindly made a tour on behalf of the Association in counties Dublin and Louth, inspecting hives and giving advice as to their management. Lectures on bee-keeping were also given in four different localities. A large amount of honey was sold at the *dépôt*, the sections of 1890, when up to a fair standard, having usually fetched from 9*d.* to 10*d.* The bee-disease known as ‘foul brood’ having become alarmingly prevalent, a special committee had been formed to inquire into the subject, but had not yet completed its investigations.

Miss F. W. Currey made some suggestions with regard to this latter question derived from her own experience, and moved a resolution, which was passed unanimously, ‘That the attention of the Association be specially given to the subject of foul brood.’

The following officers and Committee were elected for the year 1891–92:—*President*: Lord Ardilaun. *Vice-Presidents*: The Earl of Rosse, Miss Rutherford, Rev. Canon Procter, Hon. Richard Bellew, Mr. W. J. Bramley. *Hon. Treasurer*: Mr. J. Edmundson. *Hon. Secretary*: Mr. Henry Chenevix. *Hon. Auditors*: Messrs. J. K. Millner and M. H. Reed. *Committee*: Mr. M. H. Read, Dr. Traill, Miss F. W. Currey, Rev. P. Kavanagh, Rev. Canon Sadleir, Rev. R. Seymour, Messrs. R. T. Croasdaile, J. K. Millner, J. M. Gillies, W. Morony, T. B. O’Brien, Oswald Hardy, Dr. Knight, T. G. Barlow, and G. W. Hargraft.

The President, Vice-Presidents, Treasurer, and Secretary, are also members of Committee *ex-officio*.

LEICESTER B.K.A.

It may not be generally known in the Loughborough and Ashby district that Mr. A. Harding, Park Road, Loughborough, has kindly undertaken the duties of Secretary to the Leicestershire Bee-keepers' Association for that division of the county, and at the general meeting, held in the Mayor's Parlour, Leicester, on March 7th, Mr. Page, of Loughborough, was unanimously elected as Expert for this same division. His appointment, I have no doubt, will give great satisfaction to all the members and bee-keepers with whom he will be brought into contact, and will fill a want which has been felt for some time past, for it goes without saying that a man residing in the district it is his duty to visit has a great advantage over a stranger.—HENRY M. RILEY, *Hon. Sec. Leicestershire B.K.A., Tower House, Leicester.*

SCOTTISH BEE-KEEPERS' ASSOCIATION.

A meeting was held in Glasgow on April 8th of persons interested in bee-keeping in Scotland. There was a good attendance. Mr. R. J. Bennett, who was in the chair, explained that the Caledonian Apian Society has for the last two years practically ceased to exist, and the meeting had been called to consider how best to remedy what is felt to be a loss to bee-keepers in Scotland. The first thing they must determine was whether they should attempt to resuscitate the old Society, or whether it would not be better to start a new Society with a new name.

After some discussion it was seen to be the general desire to form a new Society, and those present agreed to enroll themselves as such and endeavour to get others to join.

Mr. Gibson-Carmichael said that from the number of letters he had received on the subject he was sure that a good many members from various parts of Scotland would join, and it was agreed to try and get active bee-keepers to work up every district. It was agreed that the new Association should try and fill the same part in Scotland as the British Bee-keepers' Association did in England, and that local bee-keepers' societies should be encouraged to affiliate themselves to it.

Mr. Bennett proposed that Mr. Gibson-Carmichael (Chiefswood, Melrose) should be asked to be secretary and treasurer until the new Society was well started.

Mr. McNally suggested that Mr. Bennett might himself be treasurer, but Mr. Bennett explained that he had not enough spare time. Mr. Carmichael was therefore appointed secretary and treasurer.

It was determined to appoint a small Committee to assist the Hon. Secretary in drawing up rules, &c. Messrs. McNally (Glenluce), Ross (Stranraer), and Johnstone (Sterling) agreed to serve, and it was determined to ask Messrs. Cameron (Blair Athol), Fraser (Strathpeffer), Sutherland (Golspie), and Wilson (Dumfries) also to join the Committee. The name of the new Association was left to the Hon. Secretary to settle, who said that he should suggest that it be called the 'Scottish Bee-keepers' Association.'

It was also remitted to the Hon. Secretary to make arrangements for holding an apian exhibition in connexion with the Highland Society's Show at Stirling in the summer. There was some conversation as to whether a second show might not be held in the autumn for honey, so as to give heather honey a chance. The Secretary promised to consider what could be done in that direction.

The annual subscription was fixed at half-a-crown.

It was determined to hold the next meeting of the Association at Stirling during the show, when it is hoped many new members may be present.

Correspondence.

The Editors do not hold themselves responsible for the opinions expressed by correspondents. No notice will be taken of anonymous communications, and correspondents are requested to write on one side of the paper only, and give their real names and addresses, not necessarily for publication, but as a guarantee of good faith. Illustrations should be drawn on separate pieces of paper.

Communications relating to the literary department, reports of Associations, Shows, Meetings, Echoes, Queries, Books for Review, &c., must be addressed only to 'The Editors of the "British Bee Journal," 17 King William Street, Strand, London, W.C.' All business communications relating to Advertisements, &c., must be addressed to Mr. J. HUCKLE, Kings Langley, Herts (see 1st page of Advertisements).

** * * In order to facilitate reference, Correspondents, when speaking of any letter or query previously inserted, will oblige by mentioning the number of the letter, as well as the page on which it appears.*

NOTES BY THE WAY.

[618.] We are now in the fourth month of the year. The weather continues of the phenomenal kind. January was cold to a degree; February was the driest on record; March will be remembered for its blizzard and heavy falls of snow, and now April is ushered in with heavy rainfalls.

Bee-keepers in this country have been hoping and prophesying (as also, bee-keepers in America) that we were to have a good honey year, though, according to the weather forecast for the summer by Belgian and English meteorologists, we are to have a wet and cool summer. This they deduce from records during the past sixty years, which show that a cold winter has never been followed by a very hot summer: on the contrary, those summers have been comparatively cool, and from a comparison of former observations, therefore, it is predicted that, after the recent cold winter, the temperature of June and July (our two honey months) will be below the average. It is not very comforting, after the poor season last year, to be told not to expect too much from 1891, as we know that the secretion of nectar in the flowers depends on certain conditions of the atmosphere, and that our honey-flows in the years that lie behind was always associated with a high temperature; last season the flowers bloomed profusely, though the busy bees searched in vain for the tiny globules of nectar, owing to the low temperature.

Manipulating-houses for the apiary are very convenient during the busy season, and those who intend building one should begin to get out their plans. I would suggest that they should be built on one side of the apiary, with the window on the side giving a view, if possible, of the whole of the hives. When I laid out my own apiary some few years back, I placed my manipulating-house at one end. This is convenient for one end of the apiary, but very inconvenient for the other end farthest away, and necessitated building another makeshift last year, which I hope to make permanent this season. The house should be bee-proof. This is a great point when you get into actual work, as

the bees soon find they cannot gain an entrance, and give up the attempt, and if honey is left for a time in the house, it is safe. This often happens with a man who has several things to attend to; some one or something calls him away just as he is busy taking off honey, and it is a great comfort to him to be able to shut the door of his manipulating-house, and feel the contents are safe until he can attend to it again. Then the window should have a bee-escape at the top, to allow any bees that are carried in with the honey, and also bees that follow the bee-keeper, to escape.

I hear of a few losses during March, principally from dysentery, resulting from the long confinement of the bees to the hives by continued cold spells, and I expect to hear of cases of spring dwindling induced by the same cause.—W. WOODLEY, *World's End, Newbury.*

FOUL BROOD AND NAPHTHOL BETA.

[619.] Owing to some remarks in your *Journal* I determined to give naphthaline a chance in my hives, where it would have every opportunity of displaying its merits, if any. I began inserting it about January 20th, when I first noticed a few bees carrying in pollen. Owing to the cold and wet I could not continue the formic acid treatment very late last summer, so united my stocks to six fairly strong colonies, most of which were much improved as to disease, though none were free of it. Of these, two hives perished in the winter, and both were reeking with foul brood, which apparently broke out with virulence when the formic acid was discontinued. Another gave out from queenlessness. The three others, which have been treated with the naphthaline, are apparently well. On lifting the covers the other day I was instantly aware of the strong smell of healthy brood—an odour to which, unhappily, I have long been a stranger. I did not like to examine the combs as a cold east wind was blowing, though it was hot enough in the sun; but I could not detect the smallest taint of foul-brood odour. I renewed, with something like hope, the supply of naphthaline. I give a teaspoonful or two, powdered, about every ten days, and either blow it in at the door with the smoker, or drop it in with the spoon under the quilt at the back of the hive. I can answer for one thing: it does not in the slightest degree harm the bees, and they do not seem to object to the smell, though it is strong enough for me to detect it sometimes five or six yards off. Since I began using it we have had snow and severe cold, but the bees kept close to their disinfected homes. I have to leave home for three weeks in a day or two, so must defer a real examination till my return; but this I can say, I looked at some hives belonging to a neighbour to-day, who has suffered a little less severely, if anything, from foul brood than I have, and the horrible old smell was quite strong—very different to the unmistakable odour of fresh,

healthy grubs in my hives. Considering the severity of the winter, my bees are strong in stores, and I shall now feed a little, but only for the sake of giving some Naphthol Beta a trial.—F. W. CURREY, *The Mall House, Lismore, Ireland.*

BEE-T SUGAR FOR BEE-FOOD.

[620.] In company with many others in this world I have been afflicted with *La Grippe*, and along with it loss of hearing. While removed from active work my greatest pleasure was reading, and the *British Bee Journal*, along with other bee-periodicals, was brought to my bedside. As what is 'far-fetched and dear bought' is usually most pleasing to the ladies, I took off the wrapper of what our little girl is pleased to call the 'Britisher.' What good times we are now living in, and what a blessing the mail facilities are! This *Journal*, starting from London, carries the kind wishes and valuable thoughts of bee-keepers all over the world.

After removing the wrapper my eyes caught sight of the picture of Miss Macdonell, of Glengarry. What a beautiful pen picture she gives of her home-life in the Highlands, and of their games, pastimes, birthdays, &c.! I am very fond of the busy bees, and take a lively interest in others who delight in their culture. There is something charming in the way Miss Macdonell tells of her interest in bee-culture, and the way the boy Peter tamed the bees, pointed out the queen, &c. It is a delightful conversational paper, and I wish that we could have more of them. Ladies, we have the reputation of being great talkers; why not imitate the brevity of the lady who has spoken?

Beet Sugar.—At the late North American Bee-keepers' Association, Eugene Secor, of Iowa, introduced the subject of beet-sugar, and quoted the authority of Frank Cheshire, of England, who declares that it is detrimental to bees for food. There was quite a spirited discussion for a while, many claiming that granulated sugar was granulated sugar whether manufactured from beet or cane. I wrote something about beet-sugar afterwards, and the editor, in a footnote, remarked that he was sorry this subject had been brought forward, and requested Professor Cook's opinion, who answered that the sugars were the same. I see in the issue of the *B.J.* for March 12th, 1891 (p. 130), it is stated that beetroot sugars are not fit for bee-food. I wish some of your correspondents would relate their experience in feeding with beetroot sugars, as it is now manufactured in large quantities in the State of Nebraska.

Feeding Bees.—It appears to me that you feed your bees much more in the British Isles than we do in the United States. One spring a neighbouring woman, in a boasting way, said that she intended to have her bees stronger than mine at the commencement of white clover bloom. With that end in view she made a slab of candy and hung it alongside

of the bee-cluster. It was run into a frame, and weighed about five pounds. The bees ate it all up, and she owned that her bees were not as strong as mine, that depended upon their own stores and what they gathered from the fields.

To-day (March 25th) a heavy snowstorm is prevailing. March has been colder than the previous winter months; only one or two pleasant days. Bees in the cellar and upon their summer stands appear to be doing well.—Mrs. L. HARRISON, *Peoria, Ill.*

[We are sorry not to be able to agree with Professor Cook in the conclusions he comes to with respect to the sugars derived from sugar cane and from beet being alike. Chemically they are so, and if we obtain them from a chemist's laboratory no doubt we should get them exactly alike. But commercial sugar from beet contains substances which distinguish it from pure cane-sugar, and just as commercial glucose differs from grape sugar, although chemically alike, so also beet-sugar differs from cane-sugar. Amongst the impurities are potash salts, in which the sugar-beet is very rich, and which can be removed from the sugar only with the greatest difficulty, and these cause fermentation. Beet sugar has a lower sweetening power, and a peculiar unpleasant odour, which distinguishes it from cane. It is very prone to ferment, which cane-sugar is not, and it is a well-known fact that preserves made with beet sugar soon become mouldy, whereas those made with cane-sugar keep very much longer. Chemists find that cane sugar gives a clearer and sweeter syrup than that made from beetroot, the clearness being due to its greater purity. Experience has also long since enabled bee-keepers in this country to decide against using beet-sugar for feeding bees, and many of the winter losses have been attributed to it. If beet-sugar were a chemically pure sugar, it might be admissible, but in commerce it is not so, and we do not consider it fit for bee-food.—Eds.]

GARDENERS AND BEE-KEEPING.

[621.] Readers of the *Bee Journal* will be glad to see the portrait of Mr. Grimshaw. His works are most interesting. Being myself a gardener and a bee-keeper, I read them with much interest. I wonder why more gardeners don't keep bees? If they only knew the value of bees in a garden, I am sure that more of my craft would take to keeping them. I have been a bee-keeper for many years, and was sorry to have to part with them when I came to London. Formerly I had eleven stocks all in hives of my own make, and was very successful with them. I have taken from a single hive 123 one-pound sections in a season. Bees are very profitable when well managed, and very interesting too. I was like a fish out of water when I got to London without my bees, so determined to try a hive in spite of the smoke. I purchased a stock in the spring of 1890, but the season being a bad one they did not do much; still, they gave a full crate of twenty-one sections, and partly filled the second, besides ample stores for winter, proving

that bees can be kept in town as well as country. The only drawback is a place to put them, but where there is a will there is a way, and so mine stand in a small garden at the back of the house, and I have had to fix them on the top of a wall, where they have wintered well, and are now quite strong, spite of the severe winter. I have been a reader of your *Journal* for six years, and look for it every week with much interest.—JOHN DUNSTER, *Upper Tooting, S.W.*

'MEL SAPIT OMNIA.'

[622.] 'Once upon a time' I slung ink, attended meetings, *conversaciones*, gave lectures, received and paid visits, took the dear old 'Sage' and 'X-Tractor' and all the rest of them for a ride behind 'St. John,' and *kept bees*. The bees still flourish, 'St. John' is still musical, 'The Sage' is beyond the small worries of this poor world, 'X-Tractor' I have not seen for what seems an age, but the bee-papers still come to the tune of seven different ones—home, colonial, and foreign. I have seen the kindly efforts of my friends in the *B. B. J.* from time to time to draw me out, but all of no avail. But I will tell you what did it at last. We have a new postman! The former one delivered the bee-papers with the conventional bang! bang!! on the knocker, but one day I was startled by a double lump! lump!! on the panel of the door. It was our new postman operating with his fist. He gave me a book-packet; it bore the Leeds post-mark. I opened it with wonderment; it was a copy of the *B. B. J.* with a (for the *B. B. J.*) very good portrait of Mr. Grimshaw. How young he looks after all his profound study of 'Development.' I congratulate him, as I also do bee-keepers generally on retaining such a zealous and enthusiastic worker amongst them. As I always get two copies of the *B. B. J.* weekly, of course it did not come as a surprise, nevertheless I was pleased to find myself remembered, although I had almost forgotten I once was—AMATEUR EXPERT.

SINGLE-WALLED HIVES.

[623.] I have eagerly watched the correspondence in the *Journal* and *Record* for and against single-walled hives, which Mr. Arthur J. H. Wood brought to the front some time ago, and which hives it appears he so successfully uses; but I must protest against his letter (No. 605, page 164), wherein he states that the whole secret of success is in wintering on 'seven frames,' which leads one to the conclusion that your correspondent is not too sanguine of the wintering qualities of single-walled hives. Single-walls have had a fair trial with me, and I will give you my experience of them. I began with two of these hives in the latter part of 1888. In the following year I saw no difference in the returns of honey between single and double-walled hives. I then went further, and

tried twenty stocks in single-walls in 1890. They did very well—better than the double-walled ones in the production of honey. I have not had a swarm from a single-walled hive.

I have now thirty-five stocks in them—twenty-four in double-walls—at my home apiary, and all have wintered equally well on ten and twelve frames. I contract none, and have not as yet lost a stock in a single-walled hive. I use strips of wood laid across the frames to form winter passages, and use only porous covering, and I find that bees winter as safely and well in a single-walled hive with ten or twelve frames as they will do in a double-walled of the same capacity: plenty of top covering, a narrow entrance, and plenty of food—I care not whether natural or artificial, if it be of good quality—and bees in single-walled hives will stand the most severe weather with impunity. I hope Mr. Wood will try more than seven frames next winter.

I have wintered seven nucleus hives on three frames, all in single-walled hives, but as I have not opened them yet I cannot say anything about them, only they are all alive as yet. They will be allowed to work up to full stocks to test to my own satisfaction whether there is any need of such a thing as a double-walled hive in the north of Scotland. We have had a very severe winter, yet I have never seen the bees in better condition than they are this year. I noticed young bees on the wing on Sunday, March 1st. Bees in the Orkney Islands have wintered very well, but as I have not been to my apiary there this year I speak from report only, but I am surprised that bee-keepers there do not take the trouble to send short reports to both the *Journal* and *Record*.

I will send you my return from single-walled hives at the end of the season, as I believe in a few years double-walled hives will be a thing of the past.—A. G. M'GLASHAN, *Kirriemuir, N.B., April 6th.*

SPRING FLOWERS, WAX EXTRACTING, ETC.

[624.] It may be my fancy, but I believe, if there is any nasty weather about, it comes here first and leaves us last of all; at any rate, we are generally a fortnight later than places fifteen to twenty miles away. Yesterday the sun did descend to shine for a short time—a most unusual occurrence, it being Saturday afternoon—and bees were bringing in a little pollen from crocuses, which have scarcely been open before, this season, owing to want of sun. I examined a few hives, and was quite prepared to find very little brood and food getting scarce, so I got the feeders out and placed them ready for syrup to-night.

Every one should grow the lovely Siberian squill for their bees; it will be in full bloom in a few days. The beautiful marsh marigold will not be out yet, but when it is the bees will revel in its golden cups. The willow (palm?)

is now in its prime. If only the poor bees could reach it, what pellets of pollen they would get! This flower seems to act as a narcotic on moths, for they will fall off quite helpless if the bough be tapped; but I have failed to see bees affected by it. The poplar buds are now full of propolis—sticky fingers later on; a whiff of its peculiar smell is very pleasant to me when passing by the trees. How marvellous is the economy in nature!

I took advantage of my mother's absence the other day, and got the back kitchen boiler in full swing. A large sack of old combs, cappings, &c. (the accumulation of twelve months), and a fourteen-pound weight to keep it down, was inserted therein, and it was soon wobbling (a most expressive word!) away splendidly; but the bag was too large or the boiler too small, so I had to get the clothes-prop and fix one end in the bag and the other against the roof. It was a novelty being stoker, but I kept up full steam, and was rewarded with six pounds of wax, which, after being twice remelted, is a good colour. I find this much the best and quickest plan, and have practised it for years. Tin extractors certainly waste a good deal of wax.

My friend, John Walton, is quite right about queen-wasps. I have found them, apparently dead, where they must have been frozen to the very marrow, and yet they revived in a warm room. I should like to remind 'Beeswing' (No. 615, p. 177) that I am fond of honey, and our servant has a sweet tooth. The Editors know my name and address; the former is not really —LORDSWOOD, M.W.B.K.A., *Birmingham.*

SUPER-CLEARERS.

[625.] Your correspondent, 'Beeswing,' (on page 117) asks the inventor of the funnel, really cone-shaped super-clearer, what would happen if the queen chanced to be in the super after the clearer has been put on? As I have no objection to excluder zinc, and take good care always to use the most perfect kind, as illustrated and recommended by you this week, I have no personal experience of the peculiar state of things suggested. Speaking, therefore, hypothetically, and bearing in mind the well-worn saying that 'bees do nothing invariably,' several possibilities suggest themselves to me. First of all, the queen being in the super, I should expect the clearing to be considerably delayed beyond the ten or twenty minutes usually occupied in the process, which, of course, would at once put me very much on the alert, as the delay would be indicative of something most unusual in the bee-world. It is also possible that the bees would rush out in the usual helter-skelter fashion; in that case, the queen being with them, I should expect a natural swarm artificially made (pardon the bull) settling somewhere, to be duly caught and returned to the hive, or the queen might have the goodness to fly at once back into the hive without further trouble; or it is possible that

the bees would leave slowly one by one, and her majesty remain behind with a dozen or so in attendance; in that case, on taking the super away I should find her, secure her by duly returning her to her proper place, *i.e.*, the brood chamber. Respecting the objection to excluder zinc, 'on principle,' I cannot help remarking here that I have never found anything a success in bee-keeping that was done 'on principle.' Bees themselves are most unprincipled things: 'cussed-like,' as our American cousins would say, they pay little respect to our principles at any rate. It seems to me like tempting Providence, when we run the risk of getting our supers spoiled all 'on principle.' However, as I am well aware that many bee-keepers have to suffer not 'on principle,' but because the materials supplied to them are defective, I intend making some experiments as soon as the weather gets warmer (no signs of that good time yet though in this part of the world!), and I hope to let 'Beeswing' and your readers generally know, before it is time to take supers off and employ clearers, how my bees behaved during the clearing process when the queen was with them.—P. HARBORDT, *Liverpool*.

[Our own experience, under conditions similar to these described, is that a very large proportion of the bees will remain with the queen, if the later chances to be in the surplus chamber, and that nothing short of driving will cause them to leave it.—Eds.]

WINTERING BEES IN THE NORTH OF SCOTLAND.

[626.] A correspondent ('D. G.,' Derbyshire) has written asking me to state my method of wintering bees in your columns. For his information I beg to refer him to the *Record* for December, 1889.

I may also state that I do not wish to pose as an authority on this question. My method has proved itself most successful in this locality, but differences of locality, &c., naturally demand differences of treatment, or, at least, modifications of any particular system. Young bee-keepers generally deduce *infallible* results from their 'experiences.' Nine years' experience has convinced me that there is no *infallible* system.—W. STOKES, *Balnastraid, Carr Bridge, Inverness-shire*.

WEATHER REPORT.

BUCKNALL, LINCOLNSHIRE. B.M. 25.

March, 1891.

Maximum, 63° on 1st.	Rain:—1.25 inches.
Minimum, 17° on 21st.	
and 31st.	Heaviest fall, .15 on 8th.
Mean max. 47.7°	Rain on 19 days.
" min. 30.9°	Average, 5 yrs. 1.78 in.
" temp. 39.3°	Frosty nights, 20.
" of 5 yrs. ... 38.7°	Range of temp., 16.8°

Remarks.—A dull, cold, and boisterous month.—J. BINT.

Queries and Replies.

[342.] *Moving Bees*.—I purpose moving ten hives of bees to a clover district five miles away, and hardly know how to arrange for the best. I thought of dividing each hive at the end of May, or, say, on Whit-Monday—or would it be better to let them swarm and shake the swarms into hives, with ready-built combs, at the new ground? I want as much surplus honey as possible, and also to guard against their swarming, as the new apiary is so far away from my house. 1. Will they get strong enough to divide by that time, seeing they now cover three to four combs? All have young queens, and I am stimulating regularly. 2. I am also feeding outside by giving very thin syrup in flower-saucers with tea-leaves in. They take a lot of syrup in this way on warm days. Do you think there is any risk of harm in doing so? I am told it induces robbing.—A LOVER OF BEES.

REPLY.—1. We advise pushing on the bees to swarm early. When the clover begins to yield, drive a swarm from each of the stocks sufficiently populous and live them on a limited number of combs (say six) at the new apiary, giving surplus room a week or so later. 2. Open-air feeding requires to be done under close supervision, and with no other bees about save your own, otherwise mischief may follow.

[343.] *Bees and Red Clover*.—Do ordinary black bees fertilise red and white clover? As I have heard that humble bees were imported into Australia to fertilise the clover there, I would ask—1. Is it right to infer that humble-bees are better adapted for fertilising clover than ordinary bees? 2. Were they imported to Australia to fertilise some particular kind of clover?—H. CORCH, *Launceston, Cornwall*.

REPLY.—1. Humble-bees fertilise red clover; ordinary hive bees do not. The latter sometimes work on second-crop red clover, and can gather nectar from it because of the reduced length of the nectary in the second-crop bloom. 2. The humble-bee has been introduced into Australia and New Zealand specially to fertilise red clover, which before their advent never seeded in those colonies.

[344.] *Honey and Asthma*.—Has honey been known to benefit or to cure asthma, and, if so, kindly explain how it is to be taken?—Jo. Ro. Lo.

REPLY.—We have heard of honey being used with good results by mixing two tablespoonfuls of honey with the juice of one lemon, and taking a teaspoonful when the asthma was troublesome.

[345.] *Horses and Bees*.—I am removing my hives, and shall have to place them in an orchard at one end of a paddock. Will the bees annoy any horses which may be grazing?—J. T. F.

REPLY.—Some little care may be required in keeping the bees orderly when taking honey, but if there is plenty of space no harm will follow.

REPORT OF RECENT RESEARCHES AND IMPROVEMENTS IN ANALYTICAL PROCESS.

DETECTION OF ROSIN IN BEESWAX. H. Röttger (*Chem. Zeit.*, No. 4, 91).—*Donath's process*: If a sample containing 5–10 per cent. of rosin is heated up to 110° C., a strong smell of turpentine will be noticed. But pure wax collected in the neighbourhood of pine woods also emits this odour. If large quantities of rosin are present, any dealer will at once notice this from the very appearance, but small percentages are best detected as follows: if rosin is boiled for some time with strong nitric acid, it is gradually dissolved with evolution of nitric vapours. Water being added, a yellowish flocculent precipitate is obtained, which is not altered by fixed alkalis, but dissolved in ammonia with a blood-red colour. A nut-sized piece of the wax is therefore boiled in a test-tube with strong nitric acid for fifteen minutes. A little cold is carefully added to solidify the layer of wax, so as to enable to pour off the acid fluid. On cooling, or, better still, on addition of more water, a precipitate is obtained which gives the characteristic reaction with ammonia. *E. Schmidt's process*: 5 grammes of the sample are boiled in a flask with twenty-five grammes of common nitric acid of 1.33 sp. gravity for one minute. An equal volume of cold water is then added, and then ammonia in slight excess. If now the fluid is poured off from the wax into a cylindrical glass, the colour will be yellowish if the wax were pure; but if adulterated with rosin, even with only one per cent., the colour will be reddish brown. It is as well to test a pure sample side by side. *Hager's process*: The sample is boiled with fifteen times its weight of dilute alcohol (two alcohol and one water). After cooling, the liquid is poured, or, if necessary, filtered off, and then diluted with an equal bulk of water. If rosin is present, the liquid turns milky. Stearic acid does not interfere with this test. The German Pharmaceutical Committee recommends to boil the suspected wax with ten parts of water and three parts of carbonate of soda for fifteen minutes. If rosin is present, a persistent emulsion is obtained. Sedra proposes the following process: three grammes of the sample are dissolved in a test glass in 30 cc. of chloroform, and then shaken with 200 cc. of lime-water. Pure wax will cause an emulsion, but, if rosin is present, a turbid yellowish brown liquid separates out. The author, after trying these processes, utterly condemns the last process, as he failed to discover an admixture of even twenty per cent. of rosin. Hager's process gives satisfactory results, but the author finds that this chemist makes a mistake in supposing the weak alcohol not to affect the wax or any stearic acid which may be present. Traces of these bodies are dissolved, but are distinguished from rosin by quickly collecting on the surface of the diluted fluid. If, however, proof spirit is used, the stearic acid is practically left undis-

solved, and even two per cent. of rosin may be detected. The best plan is, however, to first thoroughly boil the sample with strong alcohol, to evaporate the alcoholic solution, and then to apply Donath's nitric acid and ammonia test.—L. DE K., in *The Analyst*.

REVIEW OF THE BEE JOURNALS OF FRANCE AND BELGIUM.

BY J. DENNLER.

1. *L'Apiculteur*. Thirty-fifth year. No. 2.—Amongst the questions to be submitted for discussion at the next apicultural congress in Paris is that of parthenogenesis. Dubini recommends the use of vaseline in order to prevent propolisation of the rabbits. It suffices to paint this substance with a small brush over the walls and cracks to prevent these being propolised. By putting vaseline on the rabbits and runners the frames are easily removed. The bees have such a dislike to vaseline that they avoid the rabbits when this is on. If the hive contains bees, great care must be taken not to touch them with the brush; they should be driven back with smoke. No. 3.—The object of the formic acid secreted by bees. If honey from our bees has a few drops of litmus added to it, this imparts a red tint to it, a characteristic of the presence of acids. In this case it is formic acid, the presence of which preserves honey a long time. Honey treated with tepid water, which removes the formic acid, loses this faculty of conservation. The secretion of formic acid varies in different species of bees. The stingless bees of South America make bitter honey, the absence of the sting being followed by the want of secretion of the formic acid, which only could preserve the honey. Of the eighteen species of bees found in the north of Brazil, only three have stings.

2. *La Culture Rationnelle des Abeilles*. Bulletin of the Bee Society of the department of Tarn. No. 4.—Distance for apiaries. A Prefectoral order of November 25th, 1890. Whereas, by law, &c., we decree that hives of bees must be placed at least three metres distant from all neighbouring property or public roads, these distances are not applicable to properties enclosed by walls two metres high.

3. *Le Bulletin Apicole*. Organ of the Bee Society of the Meuse basin. Second year. No. 3. Editor, A. Wathelot.—This number contains an excellent article upon clovers. More than a hundred and twenty [280—Ed. *B.B.J.*] species compose this important genus of this family (*Leguminosae*), about fifteen of which grow spontaneously in Belgium. The most important for apiculture is, without doubt, the small white clover, which comprises several varieties equally sought after by bees. A field of white clover near an apiary is, during the summer, like a fountain of honey. The honey is white, easily extracted, and of good quality.

4. *Le Rucher*. Illustrated organ of the Bee Society of the *Région du Nord*. Eighth year. March.—The regional agricultural exhibitions

in 1891 will take place at Pau from 25th April to 3rd May; at Bar-le-Duc, 2nd to 10th May; at Avignon, 9th to 18th May; at Bourg, 16th to 24th May; at Versailles, 23rd to 31st May; at Niort, 30th May to 7th June; at Aurillac, 30th May to 7th June; at St. Brieux, 13th to 27th June; and at Ajaccio, 16th to 24th May. The Society last season protested against mineral wax, and asked to have the import duties raised to 100 francs a hundredweight. The question was referred to the Chamber of Deputies and Commissioners of Excise, and these, after duly considering the request, have fixed the import duty into France of mineral and vegetable wax at 8 francs, and a minimum tariff of 30 francs, as well as a general tax of 40 francs on mineral wax. The Society think these duties are too low.

Notices to Correspondents and Inquirers.

Letters or queries asking for addresses of manufacturers of correspondents, or where appliances can be purchased, or replies giving such information, can only be inserted as advertisements. The space devoted to letters, queries, and replies, is meant for the general good of bee-keepers, and not for advertisements. We wish our Correspondents to bear in mind that, as it is necessary for us to go to press in advance of the date of issue, queries cannot always be replied to in the issue immediately following the receipt of their communication.

All queries forwarded will be attended to, and those only of personal interest will be answered in this column.

A BEE-MAN.—When it is asked if you 'could sell some bee-things by advertising in our pages,' we can only reply that much depends on the 'bee-things,' and the price asked for them. We do not usually print testimonials as to the value of the *B. J.* as an advertising medium, but the following just to hand may serve as a reply to your inquiry:—'As an evidence of the value of your advertisement column my advertisement brought about a score of replies, and some of them good customers.—F. R. G., (Wilbarston, Market Harborough).'

A. M. (Newton Abbot, Devon).—The comb sent makes it quite clear it is not a fertile worker, but an unfertilised queen, which is producing the drones. The brood is perfectly healthy.

BRITON (Truro).—The dead larvæ in comb sent is undoubtedly chilled brood. There are, however, traces of foul brood, not in the advanced stage, but sufficient to make it needful to use remedial measures at once. We advise in this case a trial of naphthol in the food given, and a pinch of the powder on the floor-board.

W. H. DALLAS (Hendon).—*Bee-flowers.*—Among good annuals for sowing now may be named Mignonette, Borage, Limnanthes Douglasii, and Nasturtium. Wallflowers are also excellent if planted out for early flowering in spring, but we must not disguise the fact that if your bees have fairly good field-pasturage they will not be seen much on your home-grown flowers.

J. BAINBRIDGE (Huttou Ruddy).—Comb sent is affected with foul brood. If the diseased stock is not a strong one we advise its destruction, and the thorough disinfection of the hive, rather than risk the safety of your healthy colonies.

UN AMI (Bourne).—*Painting Honey Vessels.*—We should decidedly not paint the inside of honey tubs; rather paint the outside and keep the inside clean by scrubbing well with water.

BEE-KAY.—We endeavour as far as possible to insert replies to all queries reaching us on Monday in our issue of the same week, and urgent queries are replied to by post when a stamped addressed envelope is enclosed, but we cannot guarantee insertion the same week. To 'add an extra page' occasionally as you suggest, is, we need hardly say, impracticable.

E. RUSSELL (Forest Row, Sussex).—Your sample is beet sugar, and as such is not suitable for bee-food.

THE DEPOSIT SYSTEM.

British Bee Journal and Bee-keepers' Record.

OFFICE: KINGS LANGLEY, HERTS; AND
17 KING WILLIAM STREET, STRAND, LONDON, W.C.

The following are the Rules under which we are prepared to receive Sums of Money on Deposit from persons buying and selling goods.

In order to save trouble it is requested that the Rules be carefully read over by persons using the Deposit System of trading.

DEPOSITING.

1. **Method.**—When strangers are dealing together, the purchase-money of the articles is deposited at our office. We acknowledge receipt of the deposit to both parties, and hold the money until we are satisfied that the purchase is concluded. If a sale be effected, we remit to the seller the amount deposited, less a charge of 6d. and the expenses of Post Office Orders and postage, &c. Cash will be forwarded by cheque, Post Office Order, or by Postal Order as preferred. If a sale or exchange be not completed, we return the amount deposited, after making the same deduction. By this means buyers and sellers are secured from fraud.

2. **Deposits.**—Postal Orders (drawn on General Post Office) and Cheques must be made payable to John Huckle, and crossed 'Bucks and Oxon Bank.' The numbers of the Postal Orders should be kept by the sender. We cannot be responsible for any losses that may occur in transit.

3. **Honey on Approval.**—All honey will be sold by sample, which must be sent direct to buyer.

4. **Bee-appliances.**—In ordering, the time allowed for completing the order to be stated to us when sending cash. If maker accepts, we hold cash till transaction is satisfactorily completed, when the amount will be remitted subject to conditions as in Clause 1.

5. **Bees and Queens.**—These will be dealt with entirely by the parties concerned, so far as price, &c., goes, and when the purchase is satisfactorily completed cash will be remitted as per Clause 1.

6. **Goods in Transit.**—These are at the seller's risk, i.e., any damage to or loss of an article on its journey is borne by the vendor; but a rejected article must be properly packed and returned by the same means as was used in sending it.

7. **Carriage.**—The carriage of all goods, except such as are sent by post, is payable by the buyer, unless otherwise agreed. If any article sent on approval be returned, each party to the transaction must pay carriage one way.

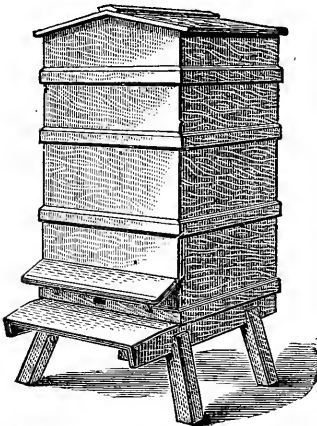

OVERTON'S CHEAP COTTAGE HIVE

For the coming Season. A most complete Hive, and substantially made, with all the necessary arrangements for working Comb or Extracted Honey, separate or combined.

Stock Hive.—Double Walls, back and front, contains 9 Frames with W.B.C. Ends, 1 Dummy, Porch and Entrance Slides. Stands on four legs. Shallow Super with 10 framed lift, so that 2 or 3 racks can be placed under cover; there is also a well-made roof.

PRICE COMPLETE, 14/- PAINTED, 16/6.

Single Rack of Sections, 2/6 Pair, ditto, 4/6 Queen Excluder, 1/6

Naphthalised Candy for Spring Feeding.

This is carefully made, and can be had with or without Pea-Flour. 1-lb. Boxes, 5d. each; 4/6 per Dozen.

64-page Illustrated Catalogue, ready in a few days, sent to any address free.

CHARLES T. OVERTON, Lowfield Apiary, Crawley, Sussex.

LEAKE'S COMB FOUNDATION.

Owing to the continued rise in the price of Beeswax, my Foundation is now offered at the following rates:

BROOD FOUNDATION.

Best Quality: 4 lbs., post free, 7/6; 9 lbs., post free, 16/0; 14 lbs. and upwards, at 1/7 per lb., carriage extra.

Second Quality (Dark, but pure):

4 lbs., post free, 6/9; 9 lbs., post free, 14/0; 14 lbs. and upwards, at 1/3½ per lb., carriage extra.

SUPER FOUNDATION.

Natural Based (very thin and pale): 1 lb., post free, 2/8; 4 lbs., post free, 9/6; 8 lbs., post free, 17/6; 14 lbs. and upwards, 1/11 per lb., carriage extra.

These prices will still be found much lower than is usually charged, nevertheless the quality is excellent and absolute purity guaranteed. Samples sent for three stamps.

LEAKE'S SPECIAL SMOKER—the best extant, post free, 3/-

NOTE.—All Parcels sent out within 24 hours after receipt of cash. If the Deposit System is adopted, please send 8d. extra to cover expenses.

SOLE ADDRESS—**J. LEAKE, Phoenix Park Apiary, DUBLIN.**

BEST FOUNDATION for WIRED FRAMES, 2s. 3d. per lb. (about 9 Sheets).
 Best SUPER, 2s. 7d. per lb. Perfect SMOKER, 2s. 6d. FRAMES, 10d. per doz. SECTIONS, 2s. 6d. 100. METAL ENDS, 5d. doz. METAL DIVIDERS, 10d. doz. CATALOGUE FREE. Innumerable Testimonials received. G. STOTHARD (1st Class Expert), Welwyn, Herts. WELWYN LUBRICATING GREASE for CARTS, 2s. 6d. per 28 lbs. 2489

THE MANAGEMENT OF STRAW SKEPS. Designed to teach the Cottager how to obtain the best results at the least possible cost. Price 1d. Ditto in Welsh, 1d.

FOUL BROOD AND ITS CURE. By Frank R. Cheshire. Price 2½d., post free.

J. HUCKLE, Kings Langley, Herts.

ROYAL AGRICULTURAL SOCIETY of ENGLAND.

DONCASTER MEETING, 1891.

Commencing MONDAY, JUNE 22nd, and closing FRIDAY, JUNE 26th.

Entries Close May 1st.

PRIZE LIST FOR HIVES, HONEY, &c.

May be obtained on application to the Secretary of the British Bee-keepers' Association,

J. HUCKLE, Kings Langley, Herts.

THE
British Bee Journal,
BEE-KEEPERS' RECORD AND ADVISER.

No. 461. Vol. XIX. N.S. 69.]

APRIL 23, 1891.

[Published Weekly.]

Editorial, Notices, &c.

USEFUL HINTS.

WEATHER.—Real spring warmth is now urgently needed, vegetation, though making fairly good progress, being more backward in the southern counties than has been known for some years. The present state of things has, however, a satisfactory side to both fruit-growers and bee-keepers, the former still having a comforting fact before them in the comparative safety of fruit-bloom from damage by sharp spring frosts, and the almost certainty of a heavy crop; while bee-keepers are saved from the disappointing experience of beholding trees covered with bloom, and bees unable to work on it through cold winds and low temperature. The cold winds are with us, but the trees are still blossomless, and bee-keepers must bide their time for a few days longer, when we trust to see spring gathering in full operation. It is one of the main causes of spring dwindling when an abnormally cold April checks breeding, thousands of eggs being laid by the queen only to be eaten or destroyed by the bees because of the low temperature. The remedy is to raise the heat of the brood-nest by slow stimulative feeding. At such a time stimulating is a real benefit to bees, and if supplemented with warm packing it cannot but be of the greatest service in the building-up process now so important. Feed, therefore, regularly, and disturb frames as little as possible till the daily expected spring warmth comes.

EXCLUDER ZINC.—The reference to this in our last 'Hints,' and the further allusion to it on p. 176 of the same issue, has brought forth a considerable amount of correspondence on the subject, and we are pleased to see that manufacturers and dealers are fully alive to the importance of some action being taken in the matter.

The point is, have our English zinc-workers realised the necessity for perfect exactness and accuracy in the size of the perforations, which, while allowing the worker-bee to pass freely through, will rigidly exclude queens? That some of them have not hitherto done so is quite obvious from the fact of more than one sample of zinc forwarded to us as correct being so much too large that we could pass the bodies of queens through them quite readily. Queen-bees, like other creatures, vary in size, therefore queen-excluder, to be what its name implies, must have perforations adapted for small and comparatively slender queens. This was shown by the experience of 'Alpha,' detailed in 570 (p. 114). It has been suggested that we, perhaps, favour the make of one manufacturer beyond that of another, and that 'no reason exists why British-made zinc should be compared with American to the disadvantage of the former.' Both these suggestions are unjust and ungenerous. The several manufacturers of perforated zinc to us stand exactly alike; we know none of them except by name, and no interest is advocated in this *Journal* directly or indirectly save the interest of bee-keepers themselves. Dr. Tinker's make of zinc was referred to as perfect in its way, and we are glad to be informed by a correspondent that a manufacturer here has agreed to make the zinc with precisely the same size of perforation as illustrated on p. 176 of *B. J.* for April 9th, so that the evil complained of is in a fair way of being remedied.

VASELINE.—We are about to give a fair trial to this very useful article as a lubricant to prevent propolisation of the working parts of our hives. We are in a district where propolis is apparently very plentiful, and, as it is always more or less of a troublesome nuisance, it will be well to consider if the antipathy which, according to a Continental bee authority, bees have to vaseline cannot be turned to account. We shall carefully and slightly cover all the

runners, metal ends, sides of dummies, indeed all the working parts of the hive, and watch results. The plan is not new even in this country, but it is not known how far it has been carried out, nor to what extent it has succeeded, so after personal trial we will report.

BRITISH BEE-KEEPERS' ASSOCIATION.

Meeting of the Committee held at 105 Jermyn Street on Wednesday, the 15th inst. Present: T. W. Cowan (in the chair), J. Garratt, W. H. Harris, W. Lees McClure, W. O'B. Glennie (Treasurer), J. M. Hooker and W. Broughton Carr, *ex-officio*, and the Secretary. Letters were read from the Rev. Dr. Bartrum (who had previously attended a Sub-Committee meeting), Captain Campbell, Hon. and Rev. H. Bligh, and the Rev. F. T. Scott, regretting their inability to be present.

The minutes of the last Committee meeting were read and confirmed. The Secretary reported that members of the Bath local Committee had promised a donation of ten pounds, exclusive of the assistance already promised by the Bath and West of England Agricultural Society, towards the holding of an exhibition of honey and appliances at the Bath and West of England Show: resolved, that the same be accepted with thanks, and that the Exhibitions Sub-Committee do proceed forthwith to arrange the prize list and make other necessary arrangements. The Secretary was requested to write to the Secretary of the Bristol Association soliciting their support towards the exhibition.

A letter was read from the Buckingham Association asking for the advice of the Central Committee in framing an application to their County Council for assistance, from the funds set apart for promoting technical education, for the more efficient teaching of bee-keeping. The subject was considered at considerable length. Ultimately it was resolved, 'That a conference of the Committee with representatives of Affiliated Associations be held to consider the subject of making applications to County Councils for grants to promote instruction in bee-keeping.' It was further resolved to hold such conference on Wednesday, May 6th, in lieu of the quarterly meeting already announced for May 20th.

EXPERT EXAMINATIONS.

In accordance with the above announcement, candidates who may have already gained a third-class certificate and are desirous of competing for a second or first-class certificate will note that such examination will be held at 17 King William Street, Strand, close to Charing Cross Railway Station, on Wednesday, May 6th, commencing at ten o'clock in the forenoon. Candidates must give notice (accompanied by a fee of five shillings) to J. Huckle, Secretary to the British Bee-keepers' Association, Kings Langley, Herts, on or before April 30th.

BEE AND HONEY SHOWS.

It is gratifying to find that the activity of the British Bee-keepers' Association, seconded by the public-spirited efforts of a few gentlemen in the county, have succeeded in completing the preliminary arrangements for holding a Bee and Honey Exhibition at Bath in connexion with the Annual Show of the Bath and West of England Agricultural Society, to be held there on June 3rd to 8th. This will be the first bee-show of the year, and as Bath, like Doncaster, is the centre of a large and thriving district, we trust that our leading appliance dealers will make a good first appearance, and support honey exhibitors in making a creditable display at the Bath show.

A few days later—on June 22nd—will follow the Royal Show at Doncaster, where we expect a very fine display. The energy of the Yorkshire folks is already making itself felt in the extensive preparations. According to a report before us, 'the talk is about the show, and nothing but the show,' and it will not be the fault of our northern friends if it is not a notable one even for the 'Royal.' If May turns out a good month for honey there is time for a fair ingathering during the seven or eight ensuing weeks before the date of the show, and intending exhibitors, while being reminded that entries close on May 1st, are notified that entry fees will be returned if six clear days' notice be given of their inability to send exhibits. So there is no risk in entering beforehand.

Some progress has also been made in the negotiations for holding a honey exhibition at the Great London Dairy Show in the autumn, which is expected to be a large and successful affair, and maybe the 'National Honey Competition' will come off at the same show. So that there is promise of an interesting season if we are so fortunate as to experience a good one.

PURE CANE-SUGARS FOR BEE-FOOD.

We are constantly receiving samples of sugar from correspondents making inquiry as to their suitability or otherwise for bee-food. About eighty per cent. of the samples sent are beet-sugars, though declared in many cases to be cane-sugar. Indeed, it seems as if the assurance of grocers is quite unreliable, and when it is borne in mind that beet-sugars are bought at considerably less cost than those from pure cane, while quite equalling the latter in appearance, the reason is not far to seek. With the view, therefore, of assisting bee-keepers to obtain what they want, and to minimise as far as possible the ill effects of feeding bees with beet-sugar, we have made arrangements with a reliable London firm for the supply of guaranteed pure cane-sugar to bee-keepers in large or small quantities, on the conditions which appear in our advertisement columns on another page.

BEE-PAPERS FOR WINTER READING.

No. 6.—MOUNTING MICROSCOPIC OBJECTS.

(Continued from page 183.)

Dissection of Insects.—We have already mentioned, on page 134, the various appliances required for dissection, and also stated that a great deal of work can be done with ordinary lenses, or with a watchmaker's lens. But however useful these may be, there are many things that can only be done under tolerably high powers, such as are not attainable with simple lenses. The ordinary microscope could be used, but the stage is too small and not well adapted for the purpose, moreover, it is not steady enough, as the hands have to rest on the stage during the process of dissection. There are several microscopes made especially for dissecting. Lawson's is a very handy and compact instrument, and is supplied with a duplex lens giving three powers of four, six, and ten diameters. The whole folds up into a small space, and it has a large stage on which a dissecting trough can easily stand. The one which we prefer and which we generally use is Stevenson's binocular microscope. In this the stage, which is very large, stands perfectly horizontally, while the tubes of the microscope are placed at an angle so that the operator can easily work while he sits at the table. The tubes have a rack and pinion adjustment, which enables them to be raised five inches, and any of the objectives can be used to as high a power as three-eighths of an inch, although it is very seldom that such a high power is required. The most useful objectives are one inch, one and half inches, three and four inches. No erecting glass is required, as by means of prisms the object is already reversed in this microscope.

The subject for dissection is generally operated upon in fluid, either water, spirit, or glycerine, or a mixture of these. We consider that glycerine is by far the best medium to use for dissecting, as it frequently toughens structures in such a way that they can be much more roughly handled than if dissected in water or spirit. Glycerine is also much more dense than water, and is more suitable for this reason for carrying on minute dissections. A trough will be necessary to hold the liquid, and this should be about half an inch deep, and made of glass. There are different sorts of troughs made, but we have lately been able to get some circular ones about three inches in diameter that are a great improvement on those we have hitherto used. Of course, one can be made by cementing pieces of glass together, but as those described are so cheap it is not worth the trouble of making them.

The object has to be kept in position, and sometimes pinned down whilst it is being dissected. Sometimes cork, with a piece of lead underneath, may be used; but for rapid work the bottom of the trough could be filled for about one-eighth of an inch with a mixture of naphthaline and stearine, which is translucent. The

object can be easily pinned out on this. Another way we frequently adopt, especially when the subject is under dissection for a long time, is to fix it to the trough with a mixture of wax and Canada balsam, which are melted together. If the whole insect is to be fixed, and pins required for spreading it out, we use the loaded cork. Drop some of this melted wax and balsam on to the cork, and stick the insect on to it in the position required. Fixed in this way we can dissect the object away to the very last without dragging it off the cork, which frequently occurs if only pins are used for holding it down. If the internal organs are wanted, for convenience we remove the wings, legs, and antennae, and have then only the main trunk to deal with. The position in which this is fastened down will depend upon what we require, and what particular organs we wish to dissect. The operator should at first remove the outer integument very carefully, and well study the internal anatomy whilst the organs are *in situ*. With the assistance of *The Honey Bee*, a good knowledge of the disposition of the parts may be obtained, and only after that will it be advisable to separate and isolate the organs. At first it will appear very complicated, but with practice what seemed difficulties vanish. If we use the wax and naphthaline mixture, the object must be partly embedded in it, and this can be done by melting the wax with a hot wire just where we wish to place the insect, and while it is still liquid, lay the bee partly in it in the position it is to occupy when the wax becomes hard.

Now, having fixed the object, we insert the point of the scissors between any of the abdominal segments at the junction of the dorsal and ventral plates, and carefully slit up the integument. Repeat the process on the opposite side of the body, and then raise it by holding it with the forceps, and clear away its attachments with a needle. If carefully done the subjacent visceral organs will not be disturbed, and can be examined *in situ*. We then pour into the trough a mixture of glycerine and water and allow it to stand for twenty-four hours under a bell-glass. We then proceed to isolate the different parts by clearing away all the tracheal attachments with two needles, one blunt and the other sharp. Here we would point out the absolute necessity of having your instruments perfectly clean, free from rust or burrs left after sharpening. We use a strop frequently, and in this way keep them highly polished. We must not forget that in dissecting out the nerves of insects, these will be found very fragile, and will scarcely bear the strain put upon them in clearing them from the surrounding tissue, and any roughness on the instrument will often cause a rupture, perhaps after much time has been spent over the object. Sometimes we can harden these tissues by adding alcohol to the solution we are using for dissecting, and always do so with nerves. The addition of alcohol often enables us to isolate many organs that would collapse without its aid,

Alimentary Canal.—To obtain this complete, besides opening the abdomen as we have described, the thorax must be opened in the same manner, as well as the head. The gullet is easily found, and is a tube passing through the neck and ending at the mouth. Cut this away from its attachments, and follow it up to the honey sac, which will be seen as an enlargement. All the tracheæ and muscles can be taken out bit by bit, and then we get to the chyle stomach. The malpighian tubes will be found winding about in a confused mass at the junction of the chyle stomach with the small intestine; but a little patience and care will unravel them, and they can be made to float out in the glycerine. The large intestine is easily found, and it can be separated from the integument at the last abdominal ring. The whole will be now floating in the glycerine. We then place a glass slip into the trough, resting one end on the edge, and by means of a camel's-hair pencil float the object on the glass, and remove this with the object adhering to it. The canal must now be cleaned, and the intestines must have the fecal matter removed. This is best done by placing the organ in water in which some bay-salt has been dissolved. When clean, transfer to clean water, put it on the slide, take this out of the water and place it under the microscope, and arrange the parts as naturally as possible. The excess of water can be removed by blotting-paper, and the object mounted by either of the methods described.

(To be continued.)

BEE RAMBLES IN SAVOY.

(Continued from page 174.)

We then made the return journey to Aix, and walked about there to see the curiosities. This is a fashionable watering-place, picturesquely situated, and, like all such towns in the season, full of visitors, by far the largest number of whom were English. In fact, you could hear English spoken on all sides, and see the English in all directions. There is a large bathing establishment, which contains baths, drinking and inhaling saloons. In front of it is a Roman triumphal arch, said to have been erected by T. Pompeius Campanus in the third or fourth century. There are other Roman antiquities, but they are in private grounds, and we did not feel inclined to prolong our visit here for the sake of them, as bees were much more to our liking just at that time. Aix had no particular charm for us, although we did meet with some English friends who were there for the baths, but we were really staying to see the letters of Huber. Soon after our return to the hotel the Count Mouxy de Loche and his two sons came to return our visit, and the Count brought the famous letters with him. These we eagerly perused, and he kindly confided them to our care for further study. We hope to be able to give translations of them—or, at any rate, portions of them—for the benefit of our

readers. This visit came to an end, and we spent the evening at a concert given in the casino. Aix-les-Bains not having any particular attractions for us, we left the next morning, intending to go on to Moutiers-en-Tarentaise, a town of a couple of thousand inhabitants, and formerly the chief place in the province of Tarentaise.

A start was made in good time in the morning, and a pretty railway journey along the valley brought us past Chambéry, the capital of the department of Savoy. The scenery in the valley above Chambéry is very fine, and the curves and gradients of the railroad are formidable. We pass on the left the castle of Bâtie, and further on another castle, one of a line of forts extending through the country. On our right is Mont Grenier, 5700 feet high, with the side facing Chambéry a perpendicular escarpment produced by an immense mass of the mountain having broken off, which overwhelmed the country at its base and buried sixteen villages. The traces of this catastrophe are still visible in a series of little hillocks now covered with vineyards. We soon reach Montmélian, where the road branches off that used formerly to go over the Mont Cenis, but which has now given place to the railway. There is also a castle here which was long the bulwark of Savoy against France. A good white wine of some note is also made here, but the vineyards, as in all other parts of the department, are being destroyed by the phylloxera. The railroad for some miles commands a fine view of Mont Blanc, which was seen from no other point of our route since we left Bonneville. The railroad follows the left bank of the river Isère on an embankments of several miles, having crossed the river on a fine bridge just beyond Montmélian.

The next place reached is St. Pierre d'Albigny, and here we have some time to wait, our train going on through the Mont Cenis tunnel to Italy, while our destination was Albertville. We had not time to visit the little town, but remained at the station chatting. M. de Layens told us of several of his experiences while he kept bees in the Alps in the Department of Isère. He said that when the natives wished to change the place of a hive the bee-keeper put a white cloth in its place, and also to stop swarms from flying away they fire at them, and this generally causes them to settle. We have already mentioned that M. de Layens has been very successful in making hydromel, and that his plan was simpler than that of M. Froissard, which we have already described. During the coming season some of our bee-keepers may like to try their hand at making hydromel, so we will give the *modus operandi*. M. de Layens prefers making hydromel strong, as it then keeps better and can be diluted with water to any strength required for table use.

Dissolve 250 to 300 grammes of honey to every litre of warm water, and pour into a cask, which must be thoroughly clean. Do not fill the cask, but leave room for fermentation, which generally commences in a few days. On the

bunghole simply place a tile. Reserve some of the sweetened water in bottles to fill up the cask, as the liquid inside it wastes away during fermentation. The larger the quantity made at one time, the more regular becomes the fermentation. M. de Layens prefers June for making hydromel, as then the temperature is right and the fermentation is completed during the summer months, whereas if made in the autumn the cold weather retards fermentation and has a prejudicial effect upon the hydromel. The honey is easily kept from one season to another for this purpose. The liquid ferments very well at 60° to 73° Fahr. During fermentation he adds about 50 grammes of tartaric acid for every 100 litres of liquid, to encourage the fermentation and to give the hydromel a slight acidity, similar to that of wine. During fermentation he also adds a few drops of an essence of juniper berries. This should only be slightly perceptible to the taste, and in course of time it will unite with the flavour of the honey and will not be distinguished, but will impart an exquisite aroma to the hydromel. Of course any other flavour can be given, but hydromel with juniper flavour is the nearest approach to Madeira wine, and has been taken for such by connoisseurs. If it is required to start the fermentation rapidly a small quantity of yeast may be used. There are frequently secondary fermentations, to prevent which and have only proper vinous fermentation, M. de Layens adds one gramme of subnitrate of bismuth to every ten litres of liquid, which not only destroys all these secondary fermentations, but produces a better and stronger hydromel. The fermentation is allowed to proceed until it is completed, and to know when this is done M. de Layens places a cork into the bunghole having a hole in it; into this a bent tube is inserted, the other end of which plunges into a vessel of water. As the gas is generated it passes in bubbles through the water, and when the production of these bubbles ceases it is a sign that fermentation is complete. After fermentation the cask can be placed in the cellar and a wet cloth put over the bunghole, and on this a cone of wet sand. In the event of any gas being given off, this acts as a safety valve should imperceptible fermentation still take place. The wine is now left till the following spring, taking care to fill the cask from time to time with the liquid reserved for this purpose. In the month of March the hydromel can be racked into a fresh cask or put into bottles. The cask must be quite filled, and for this reason it is better to have it slightly smaller than the one used before. It must be well corked and left to become mature. It can be examined now and then, and every time filled up. The longer it is kept the better it becomes, and if a little caramel is put in the cask to give it a colour resembling Madeira, it would be difficult to distinguish it from this wine.

Our train was now ready, and we made a start for Albertville, following the course of the Isère. The mountains on each side slope

upwards gradually and regularly, and enabled us to judge of the probable variety of pasturage there would be for bees; and yet we knew no bee-keeper we had to visit just about here, so suppose all this honey is going to waste.

(To be continued.)

EXAMINATION OF HONEY BY DIALYSIS.

[The following paper is translated from the 'Alsace-Lorraine Bee Journal,' and was read at the Congress of German Bee-keepers held in Strassburg in June, 1890, by Dr. Oscar Haenle, Director of the Chemical Laboratory of the Alsace-Lorraine Bee-keepers' Association.]

Up to five years ago a thick mist hung over the chemistry of honey. It was stated in textbooks, and legal chemists said, that all pure honey turns a ray of polarised light to the left, and that any honey turning it to the right was adulterated, and should be condemned. But it fortunately happened that in my scientific excursions I found natural honey that turns the ray of light to the right. Many experiments and counter-experiments were made, and all chemists who have given attention to the subject share the conviction with me that honey can no longer be condemned for the sole cause of its polarisation deviating to the right. But this discovery of polarisation to the right was received coldly, for every chemist had to face the difficulty there would be in recognising pure honey submitted to his examination, because the usual adulterant, *glucose*, polarises to the right *always*. As you are aware, I have divided honeys into two classes—*flower honeys*, all of which polarise to the left, and *conifer honeys*,* which polarise to the right. Formerly it appeared easy to distinguish natural honey from artificial or adulterated honey, but now since the discovery of this dextro-rotation it has become very much more difficult. I have also taken the trouble, after a long series of about 150 experiments, to determine the amount of these deviations to the right. I have even published a handbook for the approximate estimation of *glucose* used in adulteration. But the operations there described have a theoretic character, and all theory must be put on one side if it cannot be used practically, with certainty and decisively.

For this reason I searched after other methods, based on new theories, and arrived at results

* These honeys are little known in England, but are frequently obtained in forest districts. The pine-trees exude a saccharine substance, which is collected by bees and converted into a honey having a peculiar flavour, not at all disagreeable, and having certain medicinal properties. When we visited M. Kuntz at Hohwald, in Alsace, we had an opportunity of tasting this honey, and found it very good. The larch fir produces a very fine quality of honey. This is quite distinct from honey-dew produced by aphides, which is generally dark in colour and disagreeable to the taste.—ED. B.B.J.

that were quite certain by means of *dialysis* before polarisation.

Dialysis is the analysis by diffusion, the separation of various substances by osmose; that is to say, the mutual interchange of two liquids miscible with each other, but separated from one another by means of a parchment membrane. The apparatus having this membrane, and by which the diffusion is carried out, is called a dialyser. Honey consists of grape sugar and fruit sugar. The portion of honey capable of crystallising is grape sugar, and that which does not crystallise, but in consequence remains fluid, is fruit sugar. By reason of its different uses in commerce, grape sugar produced in factories is derived from starch, which is boiled for a considerable time with dilute sulphuric acid, the acid being neutralised with chalk; it is then filtered through animal charcoal and evaporated to the consistence of thick syrup. It is this that in commerce goes by the name of *glucose*, and is used to impart to so-called Swiss honey its wonderful colour and beautiful appearance. This manufactured grape sugar is, however, not identically the same as natural grape sugar; it is not quite pure, and this can be easily demonstrated, for the manufactured contains substances which are not found in natural grape sugar, and they are found in the syrup in consequence of imperfect conversion of the starch into sugar, and it is to these, therefore, that the chemist must direct his attention. Polarisation, fermentation, reaction of dextrine, have all failed to give absolutely sure results.

Now, after five years of tedious investigations, I have arrived at results which enable me to tell you with full conviction that it is possible with certainty to distinguish every genuine honey from that adulterated, by means of dialysis before polarisation. I will describe the experiments which enable me to make this statement, so important to apiculture—and all the more important because the greatest practical successes of apiculture are unable of themselves to drive out the artificial honeys which, passing for genuine German honeys, flood the country.

Dialytic Experiments with Flower Honey.—1. Pure Alsatian honey in solution of 1 of honey to 2 of water, polarised -28° . After 16 hours of dialysis, the polarisation of the residue on the dialyser redissolved was $= 0^{\circ}$.*

2. 30 grammes of pure Alsatian honey were dissolved in 150 grammes of water, decolorised and dialysed. After 18 hours no turning of the ray was observed, and the polarisation $= 0^{\circ}$. The liquid on the dialyser was evaporated to 30 grammes, but still no turning of the ray. Evaporated to dryness and dried for two hours over H_2SO_4 (sulphuric acid) in a desiccator, there remained a pale yellow residue, which, redissolved in water was without optical action.

3. 50 grammes of pure Alsatian honey were dissolved in 250 grammes of water and de-

colorised. Polarisation $= -11^{\circ}$. After 16 hours of dialysis the solution no longer turns the ray. The evaporated residue remaining on the dialyser was without effect upon polarised light after dialysis.

4. 50 grammes of Alsatian honey, the polarisation (1 of honey to 2 of water) being as much as -26° , were dissolved in 250 grammes of water, decolorised and dialysed. After $5\frac{1}{2}$ hours of dialysis there was no rotation of the ray. The honey was subjected to dialysis for another hour, removed from the dialyser and evaporated. Polarisation was again $= 0^{\circ}$.

5. 30 grammes of pure honey were dissolved in 150 grammes of water, decolorised and polarised. Polarisation $= -10^{\circ}$. It was then dialysed.

After 2 hours the polarisation was	=	-5°
" ; " " "	=	-4°
" 4 " " "	=	-2°
" 5 " " "	=	-0°

In order to make quite sure, the dialysis was carried on for three hours longer; the residue evaporated to 20 cubic centimetres; polarisation was again $= 0^{\circ}$.

6. 50 grammes of Alsatian forest and meadow honey were dissolved in 250 grammes of water, decolorised with animal charcoal and polarised. Polarisation $= -5^{\circ}$. After 16 hours of dialysis the rotation was 0° . Evaporated to 20 cubic centimetres, the solution remains without rotatory influence. After fermentation with yeast the polarisation was again $= 0^{\circ}$.

Dialytic Experiments with Pine Honey.—7. Pure pine honey from M. Kuntz, in Hohwald (1 honey, 2 water) turned the ray $+33^{\circ}$. A 10 per cent. solution of this honey turned it $+9^{\circ}$. The solution decolorised with animal charcoal was dialysed for 16 hours and then polarised. Polarisation was $= 0^{\circ}$.

8. Another pine honey in a 10 per cent. solution turned $= +4^{\circ}$. After 16 hours of dialysis there was no rotation noticeable.

9. 50 grammes of pine honey of the year 1884 were dissolved in 250 grammes of water and decolorised, rotating 18° to the right. After 16 hours of dialysis there was no rotation to be seen. The residue evaporated to 30 cubic centimetres was also optically inactive.

Dialytic Experiments with Glucose.—10. A 10 per cent. solution of glucose, which rotates 100° to the right, decolorised and dialysed for 16 hours still rotated $+5^{\circ}$. The residue remaining on the dialyser was evaporated and the dextro-rotation increased in proportion to the concentration. The dry residue from 10 grammes of syrup still amounted to 1 gramme 682 milligrammes.

Dialytic Experiments with Intentionally Adulterated Honeys.—11. 40 grammes of pure honey (solution of 1 of honey to 2 of water $= -35^{\circ}$) were mixed with 10 grammes of glucose. A 10 per cent. solution of this mixture after dialysis had a dextro-rotation of $+4^{\circ}$.

12. 30 grammes of pure honey thoroughly mixed with 20 grammes of glucose dissolved in 250 grammes of water and decolorised with

* The sign $=$ is used to denote the twisting of the polarised ray of light to the left, and $+$ when it turns to the right.—Ed, B, B, J,

animal charcoal. Polarisation was as much as + 65°. After 14 hours of dialysis the rotation remained constant at + 14°. After evaporation of the residue on the dialyser to 50 grammes the polarisation was + 60°. Evaporated to dryness and dried over sulphuric acid in a desiccator there remained a highly-coloured yellow residue. This residue dissolved in water and treated with yeast still rotated + 48°.

13. 50 grammes of adulterated honey were dissolved in 250 grammes of water. Polarisation = + 95°. The liquid on the dialyser was examined first every two hours, then every hour, in order to observe the polarisation.

After 2 hours	polarisation	was	+ 45°
" 4 "	" "	" "	+ 33°
" 6 "	" "	" "	+ 18°
" 8 "	" "	" "	+ 15°
" 9 "	" "	" "	+ 12°
" 10 "	" "	" "	+ 11°
" 11 "	" "	" "	+ 10°
" 12 "	" "	" "	+ 10°

After 11 hours the dextro-rotation remained constant.

14. 50 grammes of a 10 per cent. adulterated honey were dissolved in 250 cubic centimetres of water, decolorised and polarised. Polarisation = + 12°. After twelve hours the rotation remains stationary at + 6°.

15. 50 grammes of honey were treated as above. Polarisation amounted to + 75°. After 13 hours' dialysis the rotation remained stationary at + 8°.

16. An adulterated honey treated exactly in the same way as the foregoing, after a dialysis of 12 hours showed a constant rotation of + 9°.

Dialytic Experiments with Spurious Swiss Honey.—17. The polarisation of such a honey procured in Bale amounted to + 240°. Fifty grammes of this 'tafelhonig,' as it is called, dissolved in 250 cubic centimetres of water, showed, after a dialysis of twenty-four hours, a constant rotation of + 20°.

Dialysis of a Hungarian honey, which received several prizes, as well as the silver medal at Trieste, showed it to be an adulterated product. This honey was white, and polarised 75° to the right. From its colour it was recognised as flower honey, but the strong dextro-rotation showed an adulteration of 30 per cent. After 16 hours of dialysis, the rotation to the right remained constant at + 4°, which rose to + 20° after concentration.

It is therefore established after these experiments—1. That honey which after dialysis polarises to the right is adulterated with glucose. 2. That honey which after dialysis does not polarise to the right is not adulterated with glucose.

In consequence of these results, allow me to express a wish. For some time our Society has had the desire to ask our Government to place apiculture in Alsace-Lorraine under its powerful protection, and that it would exercise in its favour the power it has conferred upon it by law, to prohibit the importation and sale of artificial honeys, or adulterations under the

name of 'honey,' this word only being applicable to and implying the natural product. Just as the law distinguishes butter from artificial butter, wine from artificial wine, so also a similar law should distinguish honey from artificial honey, inasmuch as the names 'Table honey,' 'Alpine plant honey,' do not sufficiently mark the difference.

It was hardly possible to ask this of the Government at a time when we were not in possession, as we are at the present moment, of scientific resources which enable us to determine with certainty the difference between honey and artificial honey. Now we can give a guarantee of the proper solution of the problem to the Government, and may it give its powerful support to the bee-keeping in Alsace-Lorraine as well as to the whole of Germany.

LEICESTER B.K. ASSOCIATION.

A Committee meeting was held in the Mayor's Parlour, Leicester, on Friday, April 10th. A general discussion took place re applying for a grant from the County Council for assisting technical education in bee-culture, and it was decided the same should be applied for. The prize schedule for the coming Agricultural Show was discussed, Messrs. Meadows and Redshaw again promising to send collections 'not for competition.' On the motion of W. P. Meadows, it was unanimously resolved to offer prizes:—

(1.) To the exhibitor subscribing 5s. or upwards to the Society who shall, in the quickest and smartest manner, manipulate a frame hive by taking out and turning frames, finding and exhibiting the queen, on the first day of show. First prize, 15s.; second, 10s.

(2.) To the exhibitor subscribing 2s. 6d. or upwards to the Association, who shall on the second day of show perform the same operation. First, 10s.; second, 7s. 6d.

Veils and smokers allowed, but not gloves. Ten minutes allowed to each candidate.

LABARRAQUE'S SOLUTION.

Those of our readers who are unable to get Labarraque's solution in this country could ask for chlorinated soda, or could make it themselves in the following way:—Mix one ounce of dry chloride of lime in half a pint of water, and one and a half ounce of washing soda crystals in another half-pint of water. Pour the two into a bottle, which must be well corked, shake up, and allow to settle. Pour off the clear liquid for use, which should be kept in a stoppered bottle.

DR. TINKER'S BOOK ON 'BEE-KEEPING FOR PROFIT.'—A further supply of these books has been received, and can be had post free for 1s. 2d. Correspondents who have asked to be informed of their arrival will please accept this intimation that the books can now be had, as we cannot undertake to advise them by post.

Correspondence.

The Editors do not hold themselves responsible for the opinions expressed by correspondents. No notice will be taken of anonymous communications, and correspondents are requested to write on one side of the paper only, and give their real names and addresses, not necessarily for publication, but as a guarantee of good faith. Illustrations should be drawn on separate pieces of paper.

Communications relating to the literary department, reports of Associations, Shows, Meetings, Echoes, Queries, Books for Review, &c., must be addressed only to 'The Editors of the "British Bee Journal," 17 King William Street, Strand, London, W.C.' All business communications relating to Advertisements, &c., must be addressed to Mr. J. HUCKLE, Kings Langley, Herts (see 1st page of Advertisements.)

* In order to facilitate reference, Correspondents, when speaking of any letter or query previously inserted, will oblige by mentioning the number of the letter, as well as the page on which it appears.

BALANCE-SHEETS.

[627.] Does not your correspondent, Mr. E. J. Gibbins, in criticising balance-sheets on p. 175, cut it a little too fine? I must say I thought 'C. H. W.'s' bee-account (p. 164) a splendid stimulator for beginners and intending beginners in bee-keeping. A few such bee-accounts would soon increase the number of our bee-keepers and *Journal* readers, and I hope our Editors will insert all such satisfactory accounts as reach them, and not clip the wings of writers, or they will not fly. I observe that your correspondent, 'E. J. G.' used the *B. J.* for advertising his black queens for sale last spring, and I hope he will again (for he has a fine strain of the real old black bee); but as a large queen-raiser surely he ought to see that the more bee-keepers we have, the more bees, queens, hives, &c., will be wanted, and 'C. H. W.'s' balance-sheet is the sort of thing to increase them.—H. J., *Cadwinton, South Wales.*

NOTES BY THE WAY.

[628.] The weather has been fine and warm during the past week, and the bees have taken advantage of the change to collect considerable quantities of pollen and probably a little honey, the white arabis receiving a large share of attention, while the straw skeps and shavings containing artificial pollen has not been neglected.

I notice our American brethren in the craft are exercised in their minds on the probable effect the removal of the duties on sugar, on the 1st of this month, may have on the bee-keeping industry. It appears the duty has amounted to 2½ cents per pound, and that for the future the Government will pay a bounty of 2 cents per pound on all sugar manufactured in that country. This must reduce the price considerably, and will, no doubt, as the bee-keepers aver, materially affect the price of the lower grades of honey, such as is used in confections and kindred manufactures. We in this country have had to compete with cheap sugar for several years past, and it has not affected the price of the produce of the apiary; honey continues to command as good prices as it has for several

years past, and wax seems steadily on the rise. I do not know if we are to trace the rise in wax to continued poor honey seasons or to the diminishing number of bee-keepers on the old system; possibly both causes have worked to the same end, viz., a smaller output of wax, with the usual result in an advance of price.

When we fully believed in the doctrine of the bee-tent, and the constant repetition of the same by different 'masters in the art' in various places 'that bees consumed twenty pounds of honey to make one pound of wax,' therefore, wax cost the bee-keeper ten shillings per pound, if we only computed his honey to be worth sixpence per pound, this oft-repeated assertion had become an accepted truism amongst bee-keepers, and the natural result has been an ever-increasing quantity of foundation used. The above has been disproved by experiments made by Mr. Simmins in England, M. de Layens in France, and Mr. Hasty and others in America, with the following results:—Mr. Simmins, 6½ pounds of honey; M. de Layens, 7 pounds; Mr. Viallon (America), about 7 pounds, and Mr. Hasty, 3 to 4 pounds of honey consumed to make one pound of wax. The time of the year and the state of the weather when experiments were made, also the different methods of carrying them out, may account for the varying quantities given by the several experimentors; but the thanks of bee-keepers are due to the gentlemen named for having put the matter to a practical test, and having shown us that there is not such a large saving in the use of foundation as we were wont to believe. After our editor's footnote (to 614) and 'hint' on excluder zinc, I will only add that Dr. Tinker, of New Philadelphia, U.S.A., has sent me a sample of his new-pattern excluder zinc, and it is a beautifully finished article.

I continue to hear of losses in the apiaries around, and in all cases by spring dwindling. I wonder how those stocks have come through the late trying winter that are headed by the 'Hallamshire queens?' I opine, very much on a level with the rest of 'bee-kind.' Still, it would be interesting to know if each and all were proof against spring dwindling or dysentery, and if so, why?

I notice in *Gleanings* that spring dwindling is prevalent in America this spring. The antidote, according to Mr. Root, is sunshine, and plenty of it.

There is a great dearth of spring flowers for the bees in this district; all, or nearly all, the wall-flowers are dead. The hardier white arabis is now in bloom, but the wych-elms and other early-blooming trees, are backward this year; in fact, the hardy daffodil, that usually blooms early in March, is only just coming into bloom, so that I think we may truthfully say spring is a month later than usual. This means a late bee-swarming and also a late honey harvest. A week or two of warm, genial spring weather would soon alter the face of nature, and we should soon have a wealth of blossom in the fields and woods to cheer the disheartened bee-keeper and find employment for the busy bees,

who, for want of something better, are prone to be prowling about their neighbours' larders and storerooms, and often start robbing, which results in the weakest going to the wall.—W. WOODLEY, *World's End, Newbury.*

EXCLUDER ZINC.

[629.] Since our conversation of a few days ago about the various makes of queen-excluder zinc, I have called on Mr. Harvey, of Lewisham, metal perforator, and he showed me a perforating machine in progress for making excluder zinc of the exact pattern illustrated in *B. J.* of April 9th (p. 176, and recommended by you in the *Journal* of that date as the best pattern you knew of. It appears the 'perforator' will take nearly three weeks to complete, when he could turn the queen-excluder out to meet any demand.

Mr. Harvey is most anxious to have the excluder of the proper gauge, and has already, he tells me, made four perforators at the cost of some 30% a-piece, and would be very glad of any other suggestions to make it as perfect as possible, and as it is intended to advertise the new patterns (wholesale only), dealers will have no difficulty in obtaining it.—JOHN M. HOOKER, *Beaufort Gardens, Lewisham, S.E.*

BEE-HOUSES.

[630.] I shall be pleased to lend 'Dorset Bee-keeper' (page 177) my article on 'Bee-houses,' which appeared in the *Bee Journal* for April 10th, 1890, the illustration of which you re-published on page 178. If he will write to me I will give him all the assistance in my power, as I am more convinced than ever that bee-houses are cheaper and better than single hives if they really are houses, and not cupboards.—EDWARD J. GIBBINS, *Neath, Glamorgan.*

Queries and Replies.

[346.] *Overdosing with Salicylic Acid.*—I commenced bee-keeping last year with one hive, from which I had a swarm and a cast which I united. A friend afterwards gave me a swarm. Then in the fall I drove nine lots of bees, which I united to those I already had, making up four good, strong stocks for wintering. I fed them up, and they wintered well until the memorable blizzard, when I was from home, and on my return I found two stocks dead. The other two are busy carrying in pollen. In making my syrup for the winter I find I used a quarter of an ounce of salicylic acid to ten pounds of sugar, sufficient to leave a slightly bitter taste on the tongue, though the bees took it readily enough, and stored it and have fed on it. I have a dozen or

more frames half full of this syrup, and the rest sealed honey. The bees do not take the syrup now, and I do not want to destroy the combs. 1. Should I extract the syrup and give them back to the bees, or what is best to do with them? I also have a number of partly filled sections, and the honey is now fermented. 2. Can I use these sections? 3. Is the enclosed plant any good for honey or pollen?

REPLY.—You have terribly overdosed the syrup. Why not conform to the orthodox recipe in making? 1. Extract the syrup and use it up in boiling up sugar. About one part to four or five. 2. The ferment honey may also be extracted and boiled along with sugar syrup. Sections may be used again after extracting. 3. Flower was crushed out of all recognition.

[347.] *Are Bees a Nuisance?*—I would like to know if bees have ever been proved in law a nuisance. Three of my neighbours, with whom for certain reasons I do not associate, are trying to get me removed from my house, and the above is one of their pleas. No complaint has ever been made to me, and, so far as I know, no one has been stung. My place is one of a row of cottages, with gardens at back, divided only by a stake driven in the ground and a line drawn therefrom. I intended to fence my piece this summer by way of greater security to the neighbours. I enclose a sectional sketch of the gardens to guide you. The cottages are on the south of the gardens, and a private footpath bounds the north side. The three neighbours are all on the east side of me, the furthest being about thirty yards from the apiary. The hives all face the south.—W. R. L.

REPLY.—To compel removal the bees must be proved to be a source of danger and a nuisance. But it must be admitted that so many as nine stocks kept in such close proximity to unfriendly neighbours will require great care at certain times to avoid mischief, and trouble as well. The fact of no one having so far been stung, however, goes a long way towards proving that neither danger nor nuisance exists in your case.

[348.] *Bee-keeping for Profit.*—I shall be much obliged if you will kindly inform me whether you publish any books or pamphlets which would be useful to any one who is anxious to keep bees for profit, or whether you could give me any advice on the subject? It is for a poor man who is very delicate and only able to work irregularly and earn small wages, and to whom it is most important to be able to eke out his wages in every possible way. I thought if we could provide him with bees he might be able to make it profitable, for I understand they are not much expense to keep. Would the honey and wax sell well? The man has a very small garden, but quite enough for the purpose, and there is plenty of heather and gorse in the neighbourhood. I should much like to know if it would be possible to make a profit out of it, and also

what are the best kind of hives, the probable cost of hives and bees, and where to procure them. He knows a good deal about gardening, and, I think, could soon learn how to manage bees, as when a child he was used to them, so that he probably has some idea about it. Any hints would be very acceptable. His garden is chiefly planted with potatoes, but, of course, he could plant any simple flowers suitable for bees.—F. K., *Bournemouth*.

REPLY.—We scarcely like to take the responsibility of giving advice in a case like the above beyond saying that the sixpenny handbook, *Modern Bee-keeping*, would supply all the elementary teaching required. One 'who is very delicate, and only able to work irregularly,' would also labour under many disadvantages even in bee-keeping. If a strong, healthy stock of bees in a skep were got, he might the first year obtain some surplus honey in sections, as described in the above-named book; then if he found himself able to follow it up, he might extend his operations as desired. Much would, however, depend on the honey-production of the district, for no reliance could be placed on what flowers were sown specially for the bees. For cost of hives, &c., apply for a catalogue of some dealer.

Echoes from the Hives.

Hurstmonceux, Sussex, April 12th.—I wintered eight stocks, and after using 86 lbs. of loaf sugar six of them have come out fairly strong, whilst my neighbour has lost five out of six. We are in a good district, with abundance of pollen-bearing palm on all sides, which I deem a godsend to our bees. While watching the busy little workers to-day coming home by hundreds pollen-laden, my attention was drawn to an enormous queen-hornet enjoying herself in the sun on one of the wraps of a straw skep. I quickly fixed Her Majesty with my pocket-knife before she had time to take wing. I next turned my gaze to a large straw skep which I took charge of last autumn for a friend, and, to my surprise, saw a drone come out, take a fly around, and return to the hive. Presently six more drones came out, and all went through the same process of rubbing their eyes before taking flight. This was at midday, while the worker-bees were coming home to this hive at the rate of eighty per minute. I visited the same hive two hours later, and saw drones again issue forth. Is this not early for the appearance of drones?—S. NEWNHAM.

[Very early for such a season.—Eds.]

Warbleton, Sussex, April 17th.—Still cold and unpleasant, with wind in the north, is the report for the sunny south; we have had scarcely a good day for the bees since February. Last year before this time my bees had filled their combs with beautiful honey from the willows, but not so this year; they have not

had the chance to visit the willows scarcely. Stocks that looked well in February are now terribly weak—many with no brood at all; altogether this has been the worst winter for my bees that I can remember, and the difference in the way some have stood the winter to others to me is quite unaccountable. W. Stokes (No. 626) is quite right in concluding there is no infallible system of wintering bees. Several years' experience has failed to convince me whether either a porous or non-porous quilt is best, or a double or single-walled hive, a narrow or wide entrance, a reduced or full-sized hive for wintering; one thing I have noticed, the more we allow the bees to have their own way and manage their own homes, the better it is for them—the bees. Another thing I notice is, I have one hive (a twin hive) that invariably comes out strongest in the spring; those stocks have always been my forwardest, and this time it contains my best two; and a curious thing about it is, the strongest stock of the two has wintered without (I believe) a single sealed cell of food. Owing to their putting all their honey in the supers last season, I had to feed them for winter, and for some reason (the which they did not tell me) they wouldn't nor didn't seal the food over at all. Gooseberry blossoms are just beginning to open, and the willows are out nicely, only the frosts and winds have damaged them, and the apple and pear buds are bursting, so we should again hope on.—HY. NEVE.

Henley-on-Thames, April 6th, 1891.—To-day (April 6th) being a splendid day, bees are carrying in abundance of pollen from the palm, which abounds in this locality. I have been looking through my seventeen stocks. They have come through the winter fairly well, though I have lost five lots in all. Two stocks the mice destroyed when the hives were buried in the snow; one perished for want of stores; and one stock died in a double-walled hive with plenty of stores, killed, I suppose, by the severe weather. The other lot I found, on examining in March, two clusters of bees, one dead and one alive, with plenty of stores on ten frames. The dead bees smelt very offensive, and among them were little maggots, alive. Can you explain this?—A. B. C.

[The natural result of putrefaction.—Eds.]

TRADE CATALOGUES RECEIVED.

MR. RAITT'S TRUSTEES, BEECROFT, BLAIRGOWRIE, N.B.—This is a larger and more pretentious catalogue than we are accustomed to from Blairgowrie, and the late Mr. Raitt's nephew is evidently infusing some enterprise into his management of the business. The speciality of the firm is of course comb foundation, regarding which Mr. Monair announces that 'it is manufactured on exactly the same lines as practised by Mr. Raitt,' a statement sufficient in itself to satisfy all who knew him, for none ever even suspected 'W. R.' of being capable of adulterating the wax used in founda-

tion-making. All other useful bee-appliances are included in the neatly got-up list, which is well illustrated, and is further embellished with a capital portrait of the late Mr. Raitt.

E. J. BURTT, STROUD ROAD, GLOUCESTER 26 pp.).—Mr. Burtt combines the business of appliance dealer with that of professional expert in bee-keeping, and can be consulted at stated hours at his apiary—a convenience which will be of much service to bee-keepers in the district.

Notices to Correspondents and Inquirers.

Letters or queries asking for addresses of manufacturers or correspondents, or where appliances can be purchased, or replies giving such information, can only be inserted as advertisements. The space devoted to letters, queries, and replies, is meant for the general good of bee-keepers, and not for advertisements. We wish our Correspondents to bear in mind that, as it is necessary for us to go to press in advance of the date of issue, queries cannot always be replied to in the issue immediately following the receipt of their communication.

All queries forwarded will be attended to, and those only of personal interest will be answered in this column.

THE Rev. W. E. Burkitt, of the Wilts B.K.A., desires us to say that he is not the Mr. Burkitt whose remarks at the *conversazione* of the B.K.A. are reported on p. 137, and so far from believing that winter passages are not required, he makes it an invariable rule to provide such.

J. JOHNSON (by Castle Douglas).—If the 'specking' noticed was excessive, we may surmise that the natural stores were from some cause less wholesome than the syrup, and that its use as food caused dysentery and the subsequent death of the stock.

FRED. H. TAYLOR (Fallowfield).—It is not at all uncommon to see dead bees carried out at this time, and is merely the bees removing their dead comrades from the cells, wherein they have died during the winter; but if dying bees are seen carried forth, and the trouble continues after warm weather sets in, write us again.

R. H. (Hitchin).—*Hive-making*.—There is no publication 'devoted to hive-making.' Your best plan would be to order a pattern hive of the kind named from one of our advertising hive manufacturers and work from it.

A LADY residing at Staverton, near Totnes, would be glad of the address of a Bee Expert in South Devon, who could advise her on bee-matters.—Address *B. J.* Office.

* * * Several letters, &c., are unavoidably held over till next week.

NOTICE.—We request our correspondents in future to address all communications relating to the literary department, &c., to 'The Editors of the "BRITISH BEE JOURNAL," 17 King William Street, Strand, London. W.C.'

British Bee Journal and Bee-keepers' Record.

OFFICE: KINGS LANGLEY, HERTS; AND
17 KING WILLIAM STREET, STRAND, LONDON, W.C.

PURE CANE SUGARS.

For the accommodation of Bee-keepers, guaranteed Pure Cane Sugar will be supplied in large or small quantities through this office at the under-mentioned rates:—

CRYSTALLISED.

- 4. DEMERARA } Neat bags, 14-lbs. 23-lbs. 53-lbs. Cwts.
- 5. BARBADOS } Crystals 2 9 5/4 10/6 20/6
- 6. TRINIDAD }

REFINED CANE.

- 7. WHITE CRYSTALS (Small) 3/0 5/10 11/6 22/6
- 8, 9. (Medium and Large sizes, 1/- per Cwt. extra.)
- 10. LUMP (Cut Loaf) ... Boxes, 3/3 6 3 12 3 23/6
- 11. LUMP DUST ... 3/0 6/0 11/9 22/9

All above guaranteed made from CANE SUGAR only, and free from BEET, CHEMICALS, etc., etc.

CARRIAGE PAID, by Carter Paterson, on Orders over 5,0 (or 23-lbs. Sugar) to London and Suburbs.

COUNTRY ORDERS, not less than 2-cwt. (or value £2), carriage paid at 1/0 per cwt. (or £) extra.

(Scotch and Irish orders, special arrangements.)

Cash to be sent with order, and purchasers will please observe that if samples are required or replies asked to inquiries, a stamped addressed envelope must be sent, as we cannot undertake cost of postage.

**HEADQUARTERS for FOUNDATION,
BLAIRGOWRIE, SCOTLAND.**

THE TRUSTEES OF THE LATE

W. M. RAITT,

Manufacturers of Comb Foundation,

BEG to announce that the Business is being carried on as usual under the management of his Nephew, W. B. MONAIR, who is prepared to receive inquiries and Orders for delivery THIS SPRING of their well-known make of COMB FOUNDATION.

NEW ILLUSTRATED PRICE LIST,

Containing Portrait of the late WILLIAM RAITT, post free on application. Send for Copy at once.

Address—W. B. MONAIR, Beecroft, Blairgowrie.

THE NEW QUEEN-EXCLUDER ZINC.

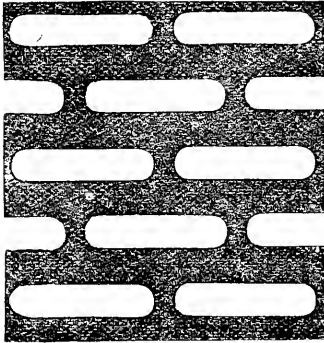

Having had a number of sheets of this Queen-Excluder stamped to the exact size and pattern as recommended in the *Journal* last week, I am prepared to supply Bee-keepers at the following rates:—

1 sheet, 8 ft. by 3 ft.	10s. each.
3 sheets, ,, ,,	9s. ,,
5 ,, ,, ,,	8s. ,,

CHEAP COTTAGE HIVE, 10 Frames, Body Hive, with Roof, Floor-board, and Rack of Sections, only 6s. 6d. Smoker, 2s. 9d. post free; Wire Veil, 2s. post free.

If paid through the Deposit System, please add 8d. extra for sums under £1 to cover expenses.

CHARLES T. OVERTON, Lowfield Apiaries, Crawley, Sussex.

LEAKE'S COMB FOUNDATION.

Owing to the continued rise in the price of Beeswax, my Foundation is now offered at the following rates:

BROOD FOUNDATION.

Best Quality: 4 lbs., post free, 7/6; 9 lbs., post free, 16/0; 14 lbs. and upwards, at 1/7 per lb., carriage extra.

Second Quality (Dark, but pure):

4 lbs., post free, 6/9; 9 lbs., post free, 14/0; 14 lbs. and upwards, at 1/3½ per lb., carriage extra.

SUPER FOUNDATION.

Natural Based (very thin and pale): 1 lb., post free, 2/8; 4 lbs., post free, 9/6; 8 lbs., post free, 17/6; 14 lbs. and upwards, 1/11 per lb., carriage extra.

These prices will still be found much lower than is usually charged, nevertheless the quality is excellent and absolute purity guaranteed. Samples sent for three stamps.

LEAKE'S SPECIAL SMOKER—the best extant, post free, 3/-

NOTE.—All Parcels sent out within 24 hours after receipt of cash. If the Deposit System is adopted, please send 8d. extra to cover expenses.

SOLE ADDRESS—**J. LEAKE**, Phoenix Park Apiary, DUBLIN.

Bath and West of England Agricultural Society.

ANNUAL EXHIBITION to be held at BATH,

JUNE 3rd, 4th, 5th, 6th, and 8th.

PRIZE LISTS for BEES, HIVES, HONEY, &c., ready in a few days.

Apply **J. HUCKLE**, Secretary British Bee-keepers' Association,

KINGS LANGLEY, HERTS.

ROYAL AGRICULTURAL SOCIETY of ENGLAND.

DONCASTER MEETING, 1891.

Commencing **MONDAY, JUNE 22nd**, and closing **FRIDAY, JUNE 26th**.

Entries Close May 1st.

.....

PRIZE LIST FOR HIVES, HONEY, &c.

May be obtained on application to the Secretary of the British Bee-keepers' Association,

J. HUCKLE, Kings Langley, Herts.

THE British Bee Journal,

BEE-KEEPERS' RECORD AND ADVISER.

No. 462. Vol. XIX. N.S. 70.]

APRIL 30, 1891.

[Published Weekly.]

Editorial, Notices, &c.

PURE CANE SUGAR.

Questions on the subject of sugar for feeding bees are constantly being asked by correspondents in the *Journal*, who frequently send on samples for our opinion. The majority of these—at least eighty per cent.—are beetroot sugar, and quite unfit for bee-food. If bee-keepers were content to buy only the very best refined beet sugars there would not be the same objection, although we consider even these inferior to pure cane. Consumers in these days do not understand that the difficulty in getting pure cane sugar lies in the fact that beet sugar is cheaper, and can be sold at a greater profit than pure cane; consequently it has almost driven the latter out of the market.

Sugar may be divided into two main classes of raw and refined, the latter being, of course, chiefly prepared from the former, though white sugar is now sometimes made direct from the cane or beetroot. Both the manufacture and refining are intricate chemical processes, into which there is no occasion for us to enter; the important thing, so far as bee-feeding is concerned, is to get a sugar which is, as far as possible, free from any chemicals or their results, as well as from the dyes which are freely used to make sugar bright yellow or snow-white.

Now it is not generally known that it is most difficult to purify beet sugar in such a manner as to get rid of all the potash salts. It is the presence of these salts that makes beet sugar so liable to fermentation, and causes the complaint that preserves do not keep so well as they used to. Cane sugar is free from these salts, hence its freedom from fermentation. Beet sugar can be recognised by its persistent disagreeable odour,

which it is most difficult to eliminate. Much of the beet sugar is also artificially coloured; for instance, *Demerara* sugar has been imitated. To produce the imitation, all the refiner has to do is to refine beet sugar, re-crystallise it (if necessary) so as to produce the crystalline condition of *Demerara* sugar, and colour it by a preparation of a yellow aniline product, which possesses an aromatic odour, and which gives the characteristic, unpleasant smell of beet sugar.

We only a few days ago purchased a sample of beautiful-looking crystal sugar that we saw in a shop window in London, and upon putting it into some water were able to wash off the yellow colour from the crystals, and expose the deception. Such sugar is unfit for bees as well as human beings, and should be carefully guarded against. It is believed that three-fourths of the sugar sold in London as cane is in reality beet, and we have no doubt the difficulty in getting pure cane in the country is even greater, if we may judge by the specimens sent to us.

Realising the difficulty our correspondents have in getting the genuine article, we have made arrangements with a wholesale firm of importers to supply our readers with 'guaranteed pure cane sugar' in large or small quantities, and we hope that this will remove a difficulty hitherto experienced. We might say a good deal more about the various sugars on the market, but we think enough has been said to put our readers on their guard against using beet sugar either as bee-food or in their households. And in referring to pure cane sugar for household use, we lay stress on the fact that, although the sugar we recommend is slightly higher in price, it is *more economical* in use than the cheaper kinds, as its sweetening power is so much greater. Housewives can test this fact for themselves in a simple manner by weighing out two

ounces of each kind of sugar ; then filling two cups with warm water, tea, or coffee, and after making the contents of each equally sweet, weigh the sugar left, and note the difference. We would also ask our readers to refer to our remarks on this subject on page 187 of this year's *B.B.J.*

'ROYAL' SHOW AT DONCASTER.

We would again remind readers that entries for the above close to-morrow, May 1st, but post-entries are received up to May 12th on payment of double fees. Honey exhibits may be entered and, in the event of unfavourable weather, entrance fees will be returned on six clear days' notice being given of inability to send these exhibits.

BEE-PAPERS FOR WINTER READING.

No. 6.—MOUNTING MICROSCOPIC OBJECTS.

(Concluded from page 196.)

Trachee.—These are very interesting objects, and are not difficult to obtain. We make a small opening in the body by removing some of the outer skin, and pour in strong glacial acetic acid. This decomposes all the viscera, which can be washed out with a syringe. The tracheae, with the air-sacs, are then easily removed by cutting them away from the spiracles to which they are connected. They are then floated upon a slide and laid out to the best advantage, dried, and either shown in this way or mounted in balsam.

Muscles.—These will be found in every part of the body, but in most abundance in the thorax, where they are in bundles. Remove one of these bundles, and with a couple of needles tease them apart in glycerine. When a good specimen is obtained, free from small broken pieces, mount in glycerine or balsam.

Dorsal Vessel.—This can be obtained by embedding the insect back upwards. Remove the upper integument, which will expose the dorsal vessel lying along the diaphragm. It must be carefully separated from the muscles.

Ganglionic Chain.—To get at this it is better to fix the insect by its back, as the ganglia are found quite close to the ventral plates. When these are removed the ganglionic chain is exposed to view. Great care must be taken in removing the outer skeleton of the thorax and also of the petiole, as this is very narrow and the nerves are easily broken. When exposed to view the nerves should be hardened by the addition of alcohol to the glycerine, allowing the object to stand for a few hours. The ganglionic chain can be followed from one end to the other, and the brain should be removed with it. It will be found that the utmost we can do is to get the principal chain, it being impossible to follow up the innumerable branches and isolate them. These must be studied *in situ*, and cannot be mounted entire. Glycerine is the best medium for mounting the ganglia. The brain is worth

special study, and is best got at by removing the head from the body of the insect and fastening it with the back downwards. We then carefully remove the upper part of the cranium, clypeus, and all the outer skeleton to the compound eyes. This will expose the salivary glands and a number of tracheae; but as these are not required for our purpose, they are picked out and thrown away. We now harden the remainder by pouring in alcohol, and commence operations on the brain. This is surrounded by a membrane, which must be stripped off, and then we come to the soft substance of the brain. This, again, hardened with alcohol, will not become uniformly white or opaque, but convolutions appear, which are more easily studied after prolonged immersion. For further particulars we must refer to *The Honey Bee*, where it is fully explained, and illustrations are given which the dissector should endeavour to imitate as nearly as possible.

Sting.—The sting is easily obtained. It can be pulled out, when usually the viscera come out with it, but we consider the best way is to fix the insect and remove the ventral plates. The sting will be found at the lower end of the abdomen, and can easily be taken away. The most difficult part will be to get the poison-gland, which is attached to the poison-sac. This latter is very tough and strong, but the gland winds about amongst the malpighian tubes, and is very difficult to get out entire. When it is isolated the sting and mechanism can be spread out as shown in Fig. 34 of *The Honey Bee*, and the muscles covering the levers should be removed. This is easily done in glycerine. The sting apparatus is one of the easiest preparations to make, and is always instructive. Spread out in this way, we prefer it mounted in glycerine. Many objects are much improved by staining, and this is one of them. If put into blue stain the poison-sac and glands take the colour, while the harder parts of the sting resist it and remain brown. If the sting is to be mounted in balsam, staining must be resorted to, as the balsam renders the poison-sac so transparent that it is not seen unless stained.

Salivary Glands.—To obtain these the insect must be fixed on one of its sides and the integument carefully cut round the compound eyes and removed piece by piece. The thorax should be exposed in the same manner, because two pairs of glands are found in the head, and one pair in the thorax. The compound eye can also be removed, and we shall find surrounding the ganglion gland system No. 1. This can be traced to the hypo-pharyngeal plate. The gland will now float in the glycerine, and we can either separate this, or if we want both sides we must follow it up to its end. It is probable that it will require hardening with alcohol to get it out without rupturing it. System 2 commences by a duct having its opening in the tongue and passes through the mentum. The duct is continued through the neck, but just before it reaches this the glands branch off and fill the space behind the glands of System 1. If

the common duct is followed up we find it passing through the neck, and immediately it enters the thorax it branches off in opposite directions, forming System 3. These systems should be got out together and spread out on a slide on to which they have been floated, and then mounted in glycerine. It will be found very troublesome to get these gland systems out without accident and to make good slides of them. But they can be got sufficiently perfect for study. There is a fourth system, but this is attached to the jaws. It is not so difficult to get at, as very frequently, if the jaw is pulled off, the gland as well as some muscles will come away with it (Fig. 51, *The Honey Bee*). It is not, however, very easy to pull out the jaw, as the connexions are very tough and strong; we can therefore easily get at it by cutting away the hard skeleton which will enable us to remove the gland without much trouble. To get a preparation like the figure alluded to, the muscles must be teased and spread out as shown.

Ovary of Queen.—The abdomen is fixed ventral side upwards, then the ventral plates are removed. The chyle stomach can then be taken out, and will expose the two ovaries, which fill nearly the whole of the space. They consist of tubes which are interlaced by tracheæ. These organs are connected to a common duct, which has its outlet at the last segment. Very little difficulty will be experienced in getting out this organ in the queen, but it will be much more trouble to find it in a worker, as it is so small and quite rudimentary. Care should be taken to remove the spermatheca with the duct. This can be examined separately, and will be found to be covered by a network of tracheæ, which when removed enable us to see the spermatozoa within. These spermatozoa can be obtained by crushing the spermatheca on a glass slide and adding a little water. Then spread a film of this on thin glass covers, and allow to dry under a bell glass. Then put a little stain in a watch glass. We have found a purple stain, prepared by Beck for bacteria, answer well for this. We now warm the thin glass over the flame of a spirit lamp, and float it on the stain film side downwards for about five or six minutes, then rinse in water, or, if the colour is too dense, dip first in spirit and then wash in water. When dry they can be mounted in balsam. If we have several such slides to mount at the same time we just take a glass slip and breathe upon it, and before the moisture has time to evaporate we place three of the covers with the dried preparations on them on the slip, and the moisture from the breath is generally sufficient to cause them to adhere until they are wanted. We then drop on each a little balsam, and place under a bell glass for twenty-four hours. After this we warm a glass slip over a spirit flame, and turning over one of the covers on to the warmed slip the balsam is seen to liquefy, and the glass settles down quietly in its place. The drone organs are the homologues of those of the queen, the testes and *vasa deferentia* bearing a great resemblance to the ovaries and oviducts.

It will, therefore, not be necessary to give special instructions for finding these. Spermatozoa may be obtained from the *vesicula seminalis* of the drone very easily, and can be mounted in the way already explained. The mucous glands, called appendicular, can be easily separated from the spermatheca and spread out on a slide.

We have now shown how to get at the principal organs and dissect them out. But there are several objects that require to be shown in section to give an idea of their structure—such, for instance, as the compound eyes, the antennæ, and the tongue.

Section Cutting.—For this purpose we require an instrument called a Microtome, and it will depend upon the method of cutting the sections what sort of microtome we use. A microtome is a cylinder fastened to a platform having a piston with a screw at the bottom. The object is embedded in the cylinder and brought level with the surface of the platform. We then have a very sharp razor or knife, having its edge and back strictly parallel and ground hollow on both sides. This is dipped in methylated spirits and water, and laid flat on the cutting surface of the microtome. Slide it along in contact with the cutting surface, and cut right through the object with a diagonal cut. Then turn the screw which will push up the object, and take another cut. Every time a section is cut the knife must be dipped into the spirit, and some of the fluid carried on to the surface of the microtome. Each section is carried by the knife into the saucer containing the spirits. Put a basin under the microtome to catch the waste spirits.

Sections may be cut in this instrument either by being embedded in carrots, cocoa-butter, or some other suitable material. The carrot has simply to be split down the middle and the object placed between it, or if too thick a place can be scooped out for it.

Those who do not mind the smell of ether can use a freezing microtome, one of the best and cheapest being the one known as Cathcart's. To cut with this the object must previously be soaked in gum and syrup medium. This is made in the following way:—

1. Picked gum acacia 4 ounces.
- Distilled water 6 ounces.

Stir until dissolved and strain through muslin.

2. Loaf sugar 1 lb. boiled in
- Distilled water 1 pint.

Take of No. 1 five parts and No. 2 three parts, and add five grains of pure carbolic acid to each ounce of this medium. For delicate tissues four parts of No. 2 can be used, to five of No. 1. The two solutions should be kept in separate bottles and mixed when wanted.

After the object has been soaked, it is taken out of the syrup and gum solution and placed between a soft cloth, to remove all gum and syrup from the outside. We now set the ether spray going, and spread a little of the No. 1 solution (gum mucilage) with a brush on to the freezing-plate, place the object upon it, and surround it with gum mucilage. Allow this

to freeze, and elevate the object by turning the screw with the left hand, and with the right hand drive a plane-iron across the object. With this microtome the plane-iron, which must be exceedingly sharp, takes the place of the razor. The plane-iron should be one about $2\frac{3}{4}$ inches broad, and must be held with its edge far below the level of the rest of the iron. If the object is properly frozen it should cut like cheese, if too hard it becomes brittle—therefore, freezing should not be carried too far. Now that we have a general idea of the appliances used for section-cutting, we can direct our attention to some particular organ.

Tongue and Mouth Parts.—We have already mentioned that chitine is very hard, and how hard it is we only find out when we begin cutting sections. If we place the tongue in our microtome without any previous preparation we will find it impossible to get satisfactory sections. We, therefore, have to soften the parts with Labarraque's solution. The tongue and mouth-parts are removed and soaked in a mixture of one of Labarraque's solution to four of water for one or two days. The object can be examined under the microscope, and a little pressure with a needle will determine if the chitine has become soft enough for cutting. After sufficient soaking, the object is well washed in several changes of water, and then put into a thirty-five per cent. solution of alcohol in water, after which it is transferred to absolute alcohol. From this transfer to oil of cloves and then to turpentine in which beeswax is dissolved. This is to prepare the object for embedding in a mixture of wax and paraffin. This mixture must be just soft enough for easy cutting, and the best proportion is three parts wax and one part soft paraffin. The object is taken out of the turpentine and put into a similar turpentine and wax bath heated to a temperature of about 110° . It is then put into an oven and kept at a temperature of between 120° and 135° for forty-eight hours. It is then left for a couple of days at a temperature of 145° , by which time the object becomes thoroughly permeated with the wax. The wax and paraffin are then put in the well of microtome, and the object placed in the position required. The whole is then put into the oven and allowed to cool gradually. This is the only way to exclude air bubbles. Objects prepared in this way cut easily at a temperature of 70° . If transverse sections of the tongue are required, like Figs. 13 and 14 in *The Honey Bee*, the tongue should be embedded with its tip downwards, as the hairs will be just in the right position for cutting, and will cause the knife to cut through easily. If reversed, the knife is liable to slip and split the section.

Sting.—Sections of this can be obtained in exactly the same manner as described above, except that it will require longer soaking in Labarraque's solution. The sections can be mounted in balsam after all the wax has been removed by soaking in turpentine.

Brain.—Remove the brain from the head of perfectly fresh specimen, which will require

some care, because the organ is extremely delicate, and if the investing membrane be impaired the internal parts are likely to be spoilt. The brain is then placed in a solution of osmic acid. This is generally purchased as a one per cent. solution, and is diluted with distilled water to half per cent. It is a hardening agent, and also stains fatty matter. It is very poisonous, very expensive, and soon spoils by exposure to light. It must be kept in a well-stoppered bottle, pasted over with black paper, so that no light gets access to it. The brain must be put into a small bottle such as homœopaths use for globules, and into this pour the osmic acid solution and let it remain in the dark for twenty-four to thirty-six hours. It is then taken out, washed, soaked in turpentine, and embedded in wax and paraffin, when sections can very easily be cut. These can be mounted in balsam.

Head.—This should first be softened with Labarraque's solution (one to four), washed, and then soaked in alcohol and then in turpentine, and embedded in wax. If properly done, very good sections can be obtained, showing the compound eyes, brain, &c., in their proper position. If stained, the appearance is greatly improved. The whole head may be stained before the sections are cut by putting it into carmine stain for a few hours after it is taken out of the alcohol.

Compound Eyes.—Dissect away the posterior wall of the cranium of a fresh insect, and expose it to the fumes of one per cent. osmic acid for about forty minutes, then wash in sixty per cent. spirit, and harden in absolute alcohol. Embed and cut with a razor set so as to give a long sweep at each stroke. In this way the chitine is not so liable to split. The section is removed from the razor, stained, washed, and mounted. There is a great deal of pigment in the eyes, which should be removed if good slides are required. The sections may be temporarily fixed to a glass slip with a solution of albumen and glycerine, then the wax and paraffin are removed by turpentine and this driven off by absolute alcohol. The slide is then inverted over a watch glass containing ninety per cent. alcohol, to which a few drops of nitric acid are added. The fumes given off dissolve the pigment, and the action is stopped by washing with spirit, after which they can be stained and mounted in balsam.

We have now given most of the processes for mounting, dissecting, and section-cutting. Of course in a subject of this sort, which is practically inexhaustible, it is impossible to give a description of every method employed, but we have given quite sufficient for those who are inclined to do so to try their hand. We have in some cases entered more fully into the subject than might be thought necessary; but we have done so because we know of no book that treats specially on mounting insects. The directions for mounting are generally for vegetable preparations, diatoms, or pathological specimens, and as a rule, insects are passed over with a few cursory remarks. Those who wish for further

information should procure Davies on *Mounting Microscopic Objects* (published by Allen & Co., price 2s. 6d.), where they will find descriptions of solutions and various stains. There is no royal road to mounting, and only patience and practice will make perfect.

The mounter must not expect to get many preparations from one insect, and when the internal organs are being dissected out concentrate all your attention on one organ, to get that perfect, and never mind what becomes of the rest. Another hint we will give, and that is to operate on fresh specimens. We cannot begin too soon after the insect is killed, as decomposition sets in very rapidly, and when this takes place it is difficult to get good preparations. With these few remarks we close our papers on this subject, hoping that the instructions we have given may be useful to our readers, and induce them to take a greater interest in the anatomy of the insect that is working so industriously for our benefit.

DEVELOPMENT IN THE HONEY-BEE.

By R. A. H. GRIMSHAW.

(Continued from page 163.)

We should not permit queens to be reared by bees (no matter how wearily good-tempered) which do not exhibit claims to good constitutional vigour, such as size, hardihood, early and late disposition to work, and so on. We could not do better, if we could guarantee purity of mating, than rigorously destroy vicious bees, select our black (brown) German or English queen, and cross-breed with Carniolan drones: that is (and I offer no opinion either way) if any good points at all remain in foreign imports.

In treating of any systematic effort to improve our race of honey-bees, we should not lose sight of the fact that whatever we do, the law of parthenogenesis always appears as an obstacle in the path. We succeed in mating our young queen in our first effort; but at her pleasure during her lifetime she presents us, for several seasons consecutively, with drones of the same family as herself and only half-brothers with her own female progeny; these drones may hold their own in mating contests, in future seasons, with what we will, for distinction's sake only, call 'improved drones,' *i.e.*, drones raised in the second and subsequent seasons from truly cross-bred virgins. The only way, so far as I see, to deal with this difficulty is to obtain young queens from cross-mated black queens, destroying the latter as soon as ever we are able to supplant them. We thus stop the issue of any pure black drones, whilst we are keeping, say, a single stock of Carniolan or Ligurian bees the queen-cells in which we scrupulously destroy (if we are able at all to adequately cope with the determination to swarm when it has once been taken), whilst at the same time we provide such a queen with a reasonable supply of drone comb in the brood nest in order to keep up a

supply of fertilising drones of the kind desired, handy for ourselves and neighbours who have entered *con amore* into the labour of race-improvement amongst honey-bees. Altogether, it seems to me a work so beset with difficulties and obstructions of so many kinds that I very much question whether 'the game would be worth the candle,' and I come to the conclusion that a careful watching amongst our own splendid brown bees for good strains, and perpetuating *them*, is the best and safest plan (for British bee-keepers anyway), being always at the same time on the *qui vice* for *real vice*, and ruthlessly eliminating it when found, as suggested earlier on.

It would appear as if this very law of parthenogenesis were an admirable decree of nature against attempts by either the insects themselves or man at too rapid alterations of variety. I should think that if a census were taken in this country of stocks of bees, and opinions obtained from bee-keepers as to the results, in their own gardens, of cross-fertilisation by importation of foreign varieties, the consensus of opinion would be very much in the direction of 'improvement, *nil*; extermination, considerable.'

Regarding the advisability of occasional importations into our gardens of new blood from a notably good strain of our brown bee (this importation being from a distance), I do not think there can be much doubt of its wisdom. We are working hand-in-hand with the bees themselves in their efforts to secure mating with others than their own close relations—we are but assisting in the mating of non-related individuals of the same variety. It is only when we travel a thousand miles, or more, and assist in making new varieties by introducing insects settled down for hundreds (probably thousands) of years to peculiar climatic and other surrounding conditions far different from ours, that we are treading in very dangerous quicksands as regards the future of our once pure race of honey-bees.

Then, again, whilst on the subject of the results amongst our bees of the admixture of foreign blood, we cannot close our eyes to the singular coincidence, to say the least of it, that before the importation of Italian and other bees the disease known as foul brood is not recorded in this country so far as I can find (and I first got the idea of this fact from Mr. Hooker). The only serious disease that troubled the British skep-man was dysentery, until improved hives and improved bees (!) came into vogue. Foul brood was known, however, on the Continent, for in 1848 Dzierzon lost nearly the whole of his 500 colonies by the pest, and from 1770 to 1780 (according to Della Rocca) an epidemic raged amongst the hives in the island of Syros, nearly annihilating all the bees. *We have it* since we began importing; *we had it not* before that time; and this significant fact, coupled with the knowledge that our Continental brethren were troubled with the disease amongst their bees, goes very far to support the theory that it was imported with imported bees,

which were, of course, crossed with our own, and that these bees transmitted to their progeny, perhaps for all time, a tendency to succumb to the attacks of their microscopic enemies.

I look at the foul-brood question precisely as I look at those human or animal diseases which are the result of, or the accompaniment to, attacks by bacteria or bacilli. Diseases caused by spores or germs of bacilli are very often resisted by animals which have such a peculiar condition of the blood that the pathogenic germs effecting an entrance into the veins, or into the alimentary canal, are dealt with *seriatim*. Myriads of minute white bodies, swarming in the healthy blood, rush to heal up wounds and block up with their dead remains, glued together, every possible aperture likely to afford ingress to the marauding disease germs, which almost would seem to be waiting for such an opening. When these find entrance the vigorous white bodies wrap themselves round the germs, rendering them innocuous, and carry them to where they may be cast forth, along with the self-sacrificing encystment, from the animal attacked. Should, however, the blood of the animal be so poor in these minute white bodies that they are neither numerous enough nor vigorous enough to keep up the defence of the citadel, each attacking soldier being seized by a defender, the gateway is passed, and the disease germs in such a suitable fluid medium multiply at so marvellously rapid a rate, the blood soon teems with them. Fever accompanies their movement, poison—deadly animal alkaloids—is given off or produced by them, and it entirely depends on the stamina and vigour of the subject whether the strain on the vital parts caused by the fever can be borne or not, whether death or victory result. Well, then, to apply this to my subject, animals brought northward from warmer, kinder climates bring with them tender susceptibilities to attacks from the microscopic enemies which swarm in the suitable conditions of their own *habitat*. Becoming interbred with their northern species, they hand on to their progeny the peculiarity or idiosyncrasy which disenables them to resist particular diseases: this is the compensation demanded by Nature for some of the benefits resulting from assisted cross-fertilisation, and it affects many species in the plant world, following the same law. We may now perhaps see the *rationale* of the argument that foul brood is materially assisted by, if not entirely the result of, the importation of bees which may be all right at home, but in our climate succumb to attack, and propagate disease.

(To be continued.)

THE HONEY-BEES OF SOUTH-WEST FRANCE.

Beeswax and honey, the two staple products of the beehive, should be produced on a larger and cheaper scale in the south-west of France than in any other district of Europe. According to a distinguished French naturalist, M. J.

Perez, the Aquitaine district is richer in *melliferous hymenoptera* than the whole of Germany and a large part of Austria, though it comprises twenty times less surface. No less than 489 distinct species of honey-bees flourish in this favoured locality. Of these there are sixty-six species which are exclusively to be met with on the hills or mountains; 196 species are found both on the mountains and in the plains; and 277 species belong exclusively to the plains and valleys. The richness of the *hymenoptera fauna* extends right across Europe from west to east, the greater portion of all the species found in the south-west of France being met with as we proceed east towards the Caucasus and Ural Mountains. It is scarcely diminished even as we penetrate into Asia; three-fourths of the bees of Mongolia are also European species. It is different as we proceed from the north to the south. On starting from Great Britain or Scandinavia, for instance, and proceeding towards the Mediterranean, we notice new species of bees at every stage of the journey. Nevertheless, many of the northern species accompany us right into the southern districts, passing through Spain, Italy, and Sicily, and penetrating actually as far as Barbary. Of the 193 species of honey-bees which inhabit the British Isles, all, except eleven, are to be met with in Aquitaine.—*Magazine of Pharmacy*.

Correspondence.

The Editors do not hold themselves responsible for the opinions expressed by correspondents. No notice will be taken of anonymous communications, and correspondents are requested to write on one side of the paper only, and give their real names and addresses, not necessarily for publication, but as a guarantee of good faith. Illustrations should be drawn on separate pieces of paper.

Communications relating to the literary department, reports of Associations, Shows, Meetings, Echoes, Queries, Books for Review, &c., must be addressed only to 'The Editors of the "British Bee Journal," 17 King William Street, Strand, London, W.C.' All business communications relating to Advertisements, &c., must be addressed to Mr. J. HUCKLE, Kings Langley, Herts (see 1st page of Advertisements).

* * * In order to facilitate reference, Correspondents, when speaking of any letter or query previously inserted, will oblige by mentioning the number of the letter, as well as the page on which it appears.

BEES IN VALENTIA.

[631.] Away in the north-west corner of Ireland lies the pleasant little island of Valentia. In this island I, the writer, have ten hives, seven of them tenanted by strong and healthy stocks of bees. These hives are all of my own making. I am rather proud of them, as men mostly are of their own productions. Carpenters who have seen them have said to me, 'You must have been brought up a carpenter.' But I was not. I began this kind of work very early in life by making rabbit-hutches. Then, years ago, and as I very recently put in a census-paper two very good-sized figures as to my age, I may as well say it was about forty-six years ago I started bee-keeping by making a set of hives

on Nutt's plan—that is, three hives side by side, and an octagon on the top for a bell glass, with doors, windows, &c. With these hives I had very good success, though, of course, they were superseded by the bar-frame hives now in use. But I had better go back to my *Valentia* bees.

I have been away from them now since the first week in this year, but have heard of their welfare from time to time through my good son-in-law, who is taking care of them for me. Indeed it is a letter from him, lately received, which has induced me to put together these gossiping lines. It will show pretty well how my bees have gone through the long and trying winter, while the success in manipulating of one who but a short time ago would not go near a bee may perhaps encourage other beginners in dealing with them. Here is the letter:—

'MY DEAR "C. C. P."—Just a hurried line to tell you of the result of my inspection to-day of the hives. It was a glorious spring day, and as I was not on till 10 p.m. I decided to go through the lot, as my last examination was not a thorough good one. I commenced with No. 1. In this I found the sacks I put in last very damp, and the quilt "filthy," all damp and dirty, slugs, ants, and a multitude of all sorts of vermin; so as there was a good quilt in shed (American cloth), I decided to remove the old and give the new. I soaked the rag in the smoker with acid (carbolic), and smeared a little on the woollen gloves, then went up and removed the old quilt; had a good look in; was surprised to find the hive quite full of bees right to the last frame. There seems to have been no "dummy" put in at the back as usual. I was glad to see they had about $\frac{3}{4}$ lb. of the sugar you put in not eaten, but were feeding on it. Put the quilt (new) on, and replaced the sugar over the square-cut hole, nicely settled all round it, and covered up with dry sacks, and then I went to No. 9; found that in same condition, but no candy, though there were plenty of bees and plenty of insects. Cleared all the latter out that I could find, and removed rotten quilt. Peg made a new one, which I put in, and covered them up strongly with dry sacks. I thought I would take the advice of the *Bee Journal*, and go to No. 5 next, which I did, and found all dry, no candy. Lifted quilt; found all fine and strong; every frame seemed covered with bees. Put back the quilt, covered up, and then went to No. 3; found that dry and nice. Looked under quilt. Such a pile of bees I never saw. All came running up, but, thanks to the carbolic scent, they retreated. I refixed them nicely, same as rest, then went to No. 2. This is the one I said in my last there was candy, but when I lifted the quilt I was astonished to find that what I thought was candy was a lot of comb that you must have put in last fall; they had it fastened down to frames, and were all on top of frames—crowded. I thought, as it was near feeding-time, it would be in the way, so I got a chisel and took it all off, then proceeded to drive the bees down and replace the quilt. They are right through to the last frame in hive, and seemed very full and strong. Fixed them up warm and returned to No. 4. This was a fine strong lot, same as No. 3; every frame crammed right up to the last, but no candy in any but No. 1; plenty of slugs, vermin, &c., which I cleared out in all of them, and fixed it up like the rest. On the whole,

you may congratulate yourself on having no really weak hive; they are all very busy every morning, and on Sunday I was watching No. 1, and saw, to my astonishment, seven bees alight together, all loaded with pollen, followed by batches of three, four, and five at a time. To-day all doing same. Now about the feeding. Peg is going to get sugar from Galvin's to make syrup. Shall I remove candy on No. 1 and melt it into syrup?

'My explorations cost me not a single sting during the whole time; in fact, the bees seemed to know they had their master, and minded me in every particular, and were by no means saucy or insolent—paid due respect to my first good manipulations. Nothing like going at them, and saying, "You have got to obey, and no nonsense."

'In addition to this, I painted the bee-seat, the fence and gate by the road, and retrained the vines on the summer-house, so it was not a bad day's work, with another eight hours of night duty before me. We got two roots of bell-bind from some keeper (presume you told him), for which we thank you much; have planted one to summer-house, one to trellis-arch over gate. Have also hop-roots planted, and are growing nicely. Got pears up and most of small seeds in, also beans, both sorts. It is supper-time now, and I must get ready for duty, so good-night. Love from all here.—ARTHUR, *Valentia*, April 6th, 1891.

'Did you put your age on the census-paper?'

You will see by this that my bees have wintered well and are all strong and healthy.

I know it is said by most advanced bee-keepers that it is better not to encourage breeding through the winter; but as to this I am sure it is best to let them go on as they like, and adapt their manners to the circumstances of the climate. When I see them carrying in pollen I always rejoice, as I know they are well and happy. All through the autumn, and even on Christmas Day, when Londoners were skating, every one of my bees were busily engaged rushing in pollen. The result is that all are strong, and I have no fear of 'spring dwindling.' My fears are as to what will happen at swarming-time. I shall have as much as I can do, by giving them plenty of room and occupation, with frames and sections, to prevent their favouring me with an abundance of swarms.

This part of Ireland is not altogether so very bad for bees. Though it is very wet and windy, yet the climate is quite mild. We have lots of white clover about in the fields. Indeed, I incline to the opinion that it is indigenous. We have plenty of heather on the sides of the mountains, but to this I fear my bees rarely resort, as close at home they have, about the same time, large quantities of fuschia, though this latter yields a quality of honey far inferior to the heather. We have also nearly all the year round a plentiful supply of furze for pollen-gathering.—C. C. P., *Horsham*, April, 1891.

VASELINE FOR USE IN BEEHIVES.

[632.] I have been a diligent student of the *Bee Journal* for some years, and about two years ago one of your correspondents advised the free use of vaseline to prevent bees from glueing

everything up with propolis. I immediately made experiments with it, and a very great comfort it has proved.

Very few things are more annoying to a bee-keeper than inability to manipulate frames without jerking, and sections without breaking them owing to propolis.

I have used it freely, and cannot find *any* objection to it, and the comfort and pleasure in being able to move all the working parts of the hive and freedom from stings is very great. I use metal ends, which I thoroughly rub over with the vaseline, and also the sides of the hives, and everywhere where the frames touch edges of the sections and bottom of section racks, &c. I have learned many valuable hints from the *Journal*, but none, I think, that have been more serviceable than the use of vaseline. Like many more of your readers, I have lost fully half my stocks this winter, in most cases with plenty of natural stores and ample covering and every care. I suppose the severity of the weather is the chief cause. Everything here is extremely backward, and although I have fed my bees for some days, they seem to take but little of the syrup. What we seem to require is a freedom from north-east wind, and some nice, warm showers. I say *seem*, because grumbling about the weather is only an indirect way of grumbling against Him who sends it, and 'we are of yesterday and know nothing,' or at least nothing to speak of.—EDWARD H. LEENEY, *Beecroft, Hove, Brighton*.

NOTES BY THE WAY.

[633.] What shall I say about the weather this week, with frosty nights and mornings, cold easterly and north-easterly winds, some days cheerless and dull, and again some glimpses of sunshine, with the attendant hum in the apiary? Vegetation makes very slow progress, though a few flowers blossom in sheltered nooks and the woods begin to look gay with the wild anemone, from which our ubiquitous worker secures a good supply of pollen; the dandelion also (*Leonis Taraxacum*) is putting forth its blossoms in sunny corners. This plant—weed, our farmers term it—is one of the best early flowers we have in this neighbourhood for honey and pollen.

According to the *British Astronomical Weather Almanack and Chart*, we are to get a wet June, July, and August. What do you say to that, good friends? But bee-keepers are not easily cast down: Hope lives eternal in the bee-keeper's breast; he always hopes to be, if never, blest.

I have read from time to time reasonable and seasonable articles in the *Evening Standard*, but the recent article on 'The Bee and the Wasp,' considering the paper circulates among farmers very largely, is not calculated to inspire them (the farmers) with a very high opinion of the busy bee when their oracle teaches the false idea that the wasp is far superior to the bee. The writer's said article has got out of his

depth; his comparisons are superficial as to the real utility of the bee and wasp. What of our crops of fruit of various kinds? How would he like to be without his strawberries with the cream? What of the raspberry tart, the wine, the vinegar? How would he like to be deprived of the delicious dessert apples, the apple pies and the sauce, not forgetting the cider, and the other multifarious kinds of fruit that are largely, if not entirely, dependent on the visits of the bees, in quest of food, for cross-fertilisation?

Reports of losses still come to hand, and from what I gather the winter losses have been pretty considerable, though the heaviest appear to have come since the last fall of snow in March. I have had two or three cases of spring dwindling in my own apiary; they were fairly strong colonies a month ago, with food sufficient to carry on till time to feed syrup, and the only indication I had of their loss last week was to see others busy clearing them out. They had evidently got so weak in numbers that they were unable to protect their stores, and so became a prey to the stronger. The weak ones always have to go to the wall in bee-kind as well as mankind.

Bees are using larger quantities of food now that breeding has commenced in earnest; don't let them run short, or they will contract rather than spread their brood nest. Registers, placed one in each hive, are a great help. Anything of interest can be noted down; the size, the condition of colony, number of frames, age of queen; also her qualities, times and dates of examinations, quantities and dates of giving food; then later on, the dates of supering and the quantities of honey taken off.

Then in large apiaries outside records are very useful—such as bricks or half-bricks placed on different parts of the hive cover to denote, according to position, the requirements of the marked colony. I have used them in my own apiary several years, and find them a great assistance. The apiarist can and will soon decide in his own mind what each position of a brick denotes better than another can suggest positions to him. Therefore I throw out the hint to those who wish to try the simple system.

I am glad to hear our manufacturers are waking up to the necessity of improving the excluder zinc. Why should we send abroad for what should—nay, ought to be—made at home?

It is my intention to try the use of vaseline on some new hives this year. I remember Mr. Burkitt telling me some years back how much more comfortably one could work in opening up hives where it had been used; but it had slipped my memory till I saw his letter on the subject some time back.

I was very glad to see a jotting from 'A. E.' again in *B. B. J.* More power to your pen, old friend; may we get a few of its spicy, racy sputterings to enliven up our pages as of yore. Where is friend W. B. Webster? I hope the bees are doing well at Binfield this spring, and

that all the time, talent, and attention of our friend will not be used up locally, as I see by a local paper he has assisted at the 'entertainments.' — W. WOODLEY, *World's End, Newbury*.

BEES AND FRUIT-GROWING.

[634.] I was induced to start bee-keeping about six years ago by a well-known bee-keeper at Somersham, and am very glad I did so, as I secured the heaviest crop of gooseberries last season I ever had, mainly, as I believe, through the bees. The weather here in April last year was good, and the bushes in blossom were alive with bees while it lasted; and the result was about a hundredweight of honey by the middle of May, but afterwards very little was gathered. I have about four acres of top and bottom fruit-trees, on a southern slope. My apiary consisted of twenty-four stocks, twelve in double-walled frame hives and twelve in skeps. I lost three skeps during this winter through queenlessness; frame hives are all strong and healthy. I wintered them with thick American cloth on the frames and thick packing on the top, with a board weighted with a brick to keep all close down and warm.

We have had very fair weather this week; bees hard at work at gooseberry-trees again. I shall expect another crop of gooseberry honey if the frost does not cut them. Plum and apple-trees will soon be in bloom. I do hope we shall have good weather for bees, and so secure a crop from that quarter. I thought of going in for extracting, as there is a better sale in this neighbourhood for run honey than for sections. In conclusion, as a practical fruit-grower, I feel certain that if we want fruit we must keep bees. — R. BROWN, *Somersham, Hunts*.

BEES AND VASELINE.

[635.] Permit me to express a gentle but very earnest protest against a growing act of injustice and unkindness towards our beloved bees. I allude to the habit of putting vaseline in their hives to prevent propolisation. Bees are said to have a great antipathy to vaseline. Are we then justified in placing in their 'sweet home' a substance which they hate and are utterly powerless to remove? How should we like a similar treatment? It may be said that smoke and carbolic are forced into their homes; true, but they only suffer from these (to them objectionable) odours for a brief time. With vaseline the case is quite different.

I sincerely hope bee-keepers who are thinking of using vaseline will consider the matter thoughtfully, and not unnecessarily inflict discomfort upon their bees. — HIVE, *Rochford*.

[Our correspondent may rely on us for not pro-

posing or advocating in these pages anything tending to inflict either cruelty or even needless discomfort on bees. As to their antipathy to vaseline, it goes no further than not caring to touch it. There is no smell or taste to be objectionable to the bees, and it is not in any way 'hateful' to them. If applied carefully to the working parts of hives it will remove the unpleasantness arising from propolisation, and we assure our correspondent the bees will suffer little annoyance, and be in no way injured by its use. When we say that Mr. C. N. Abbott has for some years advised the use of vaseline for lubricating the working parts of hives, those who know that veteran bee-master will entertain no fear as to it inflicting cruelty or hardship on bees.—Eds.]

Queries and Replies.

[349.] *Moving Bees*.—I am about to purchase eleven stocks of bees in straw skeps, and should be grateful to you for a little advice and instruction. 1. I can have the use of a horse and light cart. Will this do, and how had I better pack them? I may say I have looked them all over, and could find no food in any; and they feel rather light to handle, as they have not been fed, but wintered safely on what they gathered last season, having no other covering than an earthen milk-pan. 2. Will it do to tie them up in the evening, and let them stand until next day, then bring them so as to arrive in the evening, the distance being eight miles? 3. When put down in the place they are to occupy are the cloths, &c., to be removed at once? I may say I've had some experience for several years in handling bees, but not at packing or carrying them. I should feel greatly obliged if you could give an answer in the *Journal* next Thursday, as I want to get them home this week on account of their want of feeding.—AMATEUR NATURALIST, *Grantham, April 27th*.

REPLY.—A light cart is just the thing required. Choose the first fine day, and with a square of open cheese-cloth or coarse canvas ready, turn up each skep, and if the combs are tough and well built out for travelling, simply set the canvas under the skep and return it to its original position. If the combs in any are likely to give way during the journey, press a ball of crumpled paper between each to keep them apart. In the cool of the evening, when all the bees are indoors, tie the canvas securely. Pack them close (using a little straw in the cart to soften the jarring) so that the combs will remain in an upright position, *bottom upwards, of course*, on the journey, and start when ready. Travel briskly, and on arrival at the new location set the bees on their new stands, remove the cord, free the entrances to allow the bees to come out, and leave them. Next night the canvas may be taken away.

[350.] *Size of the 'Layens' and 'Dadant' Frames*.—Can you give me the dimensions of

the 'Layens' and 'Dadant' hives and the sizes of their frames?—YE SPREAD EAGLE.

REPLY.—*Inside measurements, frames*—Layens: $12\frac{3}{8}$ ins. long or wide; $14\frac{1}{2}$ ins. high or deep. Dadant: 18 ins. long; $10\frac{1}{8}$ ins. deep. *Hives, inside measurement*—Layens: $13\frac{1}{2}$ ins. wide; 17 ins. deep; length according to number of frames. Dadant: $19\frac{1}{4}$ ins. wide; $12\frac{1}{2}$ ins. deep; $16\frac{1}{2}$ ins. long.

SPRING WASPS.

Now that our past severe winter is giving way to a more genial temperature, we may expect to find an unusual quantity of wasps in sheltered places on sunny days. All these are the females which survived from last autumn's brood, each of which will become a queen and progenitor of a busy nest of numbers of destructive and troublesome insects.

After a very hard winter, such as the last, we shall find all the insects which hibernate in the perfect state—or, indeed, in the larval and pupal periods also—to be more numerous than after one of those open, mild winters, when abnormal warmth for a short time awakes them from their hybernal sleep. The same warmth then brings into unusual activity the natural enemy of the insects, such as birds, mice, earwigs, and other predatory 'small game.' These, consequent upon their activity, develop an unseasonable appetite, so that active search goes on for any insectivorous food which they can find. When we consider the great numbers of these enemies of the insects, one may imagine the very considerable reduction made in even a week of mild weather among such things as wasps, humble-bees, and the like, while they are in a half-torpid condition.

All this is the reverse in a hard spell of frost and snow, which in no way injures the insects, but really protects them. Experiments have shown that we may take a larva of a moth, or beetle, in its frozen state and fracture it in pieces with very little pressure of the fingers, so brittle is it. But if, instead of breaking up the caterpillar, we very slowly thaw it out under a glass in a warm room, it will soon revive, and be none the worse for its suspended animation, feeding readily, if the warmth be increased, within a few hours of its death-like condition. So it is also with other insects, whether they be hibernating as ova, larvæ, pupæ, or imagines.

We may therefore, as just suggested, expect, after our long period of protectedness during last winter, an unusual number of female wasps this spring. If these are not in some way lessened before they have commenced to found their numerous families, great will be the destruction of fruit, as well as discomfort of mankind, during the coming summer. Now is the time to save ourselves from this loss by organizing some system of destroying the females before they commence building their nests.—J. T. CARRINGTON, 'The Field.'

Echoes from the Hives.

Haltwhistle, April 27th, 1891.—Bees seem to have passed through their long confinement fairly well; on the whole I think we have had a milder winter than you have experienced in the south. No general examination of stocks having as yet been made owing to the cold east winds prevailing, one cannot give anything like a correct summary of conditions. February, during the latter part especially, was splendid. March came in like the proverbial lion and went out the same cold, bleak month. April has favoured us with a continuation of east winds, with very few 'April showers bringing forth May flowers.' When 'Old Sol' did deign to show his face the bees seemed to be busy on the palms and willows, also on the yellow flowers of the coltsfoot, which grows profusely around here. Yesterday the wind veered around to the S.W., and to-day the same, consequently the air has been much milder. I noticed the sand-martin on Sunday, the first of our migrants I have seen. Let us hope summer weather is also on the wing.—ROMAN WALL.

Notices to Correspondents and Inquirers

Letters or queries asking for addresses of manufacturers or correspondents, or where appliances can be purchased, or replies giving such information, can only be inserted as advertisements. The space devoted to letters, queries, and replies, is meant for the general good of bee-keepers, and not for advertisements. We wish our Correspondents to bear in mind that, as it is necessary for us to go to press in advance of the date of issue, queries cannot always be replied to in the issue immediately following the receipt of their communication.

All queries forwarded will be attended to, and those only of personal interest will be answered in this column.

J. McCREATH (York Place Nursery, Dumfries).—*Queen not Breeding.*—Queen sent is in perfectly normal condition. She has not begun breeding because of having so few bees with her.

G. N. (Whitehaven).—No trace of foul brood in comb sent. Watch the stock when breeding starts, and report if brood does not hatch out right.

UN AMI.—Will appear next week.

E. M. (Berks).—We advise melting the combs down. It is false economy to risk disease for the sake of a few combs.

SIGNALMAN (West of Fife).—We hope to deal with your letter next week.

GEO. A. WRAY (Haydon Bridge).—Bees are Carniolans, crossed with Ligurians or some other of the yellow races.

YE SPREAD EAGLE.—Yours is in type, and will appear next week.

NOTICE.—We request our correspondents in future to address all communications relating to the literary department, &c., to 'The Editors of the "BRITISH BEE JOURNAL," 17 King William Street, Strand, London, W.C.'

THE
British Bee Journal,
BEE-KEEPERS' RECORD AND ADVISER.

No. 463 Vol. XIX. N. S. 71.]

MAY 7, 1891.

[Published Weekly

Editorial, Notices, &c.

USEFUL HINTS.

WEATHER.—The cold winds have at length left us, some much needed rain has fallen, while the sun has warmed the ground, and the effect on vegetation has been so rapid as to work a complete transformation in the face of nature since our last 'Hints' appeared. Here in Kent the acres of fruit-bloom, with its pink-white blossoms, are a sight to see, and make one wonder what the effect would be if there were no bees about to fertilise such a sea of bloom. However, the bees are very much about, and, if the present weather continues, the fruit-honey crop should be a good one, late though it be in starting. Meantime, it will be well in more northerly districts to keep the slow feeders regularly at work—or a cake of soft candy will answer the purpose—and add to warm packing, to guard against low night temperatures. We have used newspapers for packing, as well as for covering quilts, at this time with good effect. When folded large enough to extend down the sides, between hives and outer cases, as a sort of overall to other coverings, they maintain the warmth very effectually.

VASELINE.—A few correspondents seem to dread the bad effects the use of this product may have upon bees if used about hives, as we recommended in 'Hints.' We may, however, assure them their fears are entirely groundless. A lavish use of vaseline was never for a moment intended, and the pictures of hives bedaubed with a greasy substance hurtful to bees are purely imaginary. Nothing beyond slightly lubricating the working parts, to prevent pro-polisation and trouble in manipulating, was advised. If just sufficient vaseline is applied as to ensure smoothness in working the movable parts, it will contribute much towards cultivating good temper in bees

and bee-keepers too, because the avoidance of jarring when removing frames and opening hives has a considerable bearing on these points.

SENDING QUEENS BY POST.—We would remind correspondents who send queens by post that very few indeed, in cool weather, reach their destination alive if sent alone. About a dozen bees should always accompany queens, and besides this it is well to insert a little food—not syrup—in the box. Very fine sugar, made into a thick paste by mixing with honey, is the most suitable food for bees in transit. But the box or travelling package itself is what most concerns us at the present time, seeing that within the last few days queens have reached us in curiously unsuitable packages. One comes by Parcels Post, weight nearly a pound; others not quite so heavy, but still cumbersome to a degree, and costing more for postage than needed. Some years ago a box containing a queen and a few bees was sent to us in a package weighing about seven pounds! A sketch of the proper form of box for sending queens by post is here inserted. Fig. 1 shows its

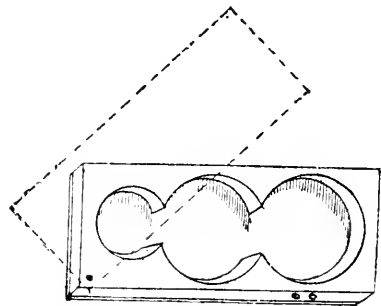

form. With a 'brace and bit' cut two circular holes each $1\frac{1}{4}$ inch in diameter, and a $\frac{3}{4}$ -inch circle above, in a slip of light, dry, yellow pine, $3\frac{3}{4} \times 1\frac{1}{2}$ inch wide and $\frac{3}{8}$ inch thick—all three circles being cut right through the wood, and so close together as to overlap and make a communication be-

tween them, as shown. A piece of stout card, glued on, forms the bottom of box, and a similar card, fastened at the top corner by a tack, makes the movable lid. The food is placed in the small compartment, the queen and her attendant bees occupying the others, and they can freely pass from circle to circle. Two small holes are made with a sprig-bit in either side of the bottom circle for ventilation, as shown, and when the cardboard lid is tied on as in Fig. 2, the package will travel quite safely by post for a penny stamp.

THE COMING CAMPAIGN.—As a consequence of the present fine weather so much activity is now apparent among bees, that preparation for the coming busy season should not be delayed for a day. If May continues as fine a month as its first week has been, plenty of supers will be filling before it is out, and give us good hope of



seeing more honey of the current year at the 'Royal' and others of the earlier shows than we have been favoured with for several years back.

ON THE LOSS OF HEAT IN HIVES.

In the *Revue Internationale* Professor Gaston Bonnier, of the Faculty of Science, Paris, describes the experiments he has been conducting with a view to determining the advantages or otherwise of division-boards for the purpose of concentrating the heat in hives. We are indebted to M. Bertrand for the illustrations kindly placed at our disposal.

M. Bonnier wished to find out the difference between a division-board and one or more frames of empty comb in preventing loss of heat. The operations were conducted in the month of October in one of the apiaries of M. de Layens at Louye. M. Bonnier has occupied himself with bees for the past twenty years, and has endeavoured to determine many questions, some purely theoretical, others capable of practical application. When the experiments were commenced the bees no longer flew out, as the temperature was low, and was below zero Centigrade during the night. The weather was fine during the whole time the experiments were carried on. Accurate thermometers were used, and a case in which an equable temperature could be maintained. Several difficulties presented themselves; for instance, when the thermometers were first introduced into the hives the temperature rose rapidly owing to the bees surrounding the instruments. To get over this

difficulty one of the combs was replaced by a frame on which wire gauze was stretched (G G, Fig. 1). The meshes were pretty large, and the gauze was so placed as to prevent bees passing round the sides. All the bees were driven back from the space between the gauze, G G, and the side, B, of the hive: experiments could therefore be carried on in this part of the hive without disturbing the bees, and a frame of honey-comb, C, was placed next to the gauze partition. The temperature was then taken outside the frame, C (Fig. 1), and close to the division-board, P. A thermometer was placed here. Without disturbing any other parts, the division-board, P, could be replaced by a frame of comb full or empty.

It seems evident that if a division-board is a better preventive of the loss of heat than the comb, all things being equal, the thermometer *t* ought to indicate a higher temperature. A fresh difficulty presented itself from the fact that the external temperature had an influence more or less on the temperature of the hive operated upon. To eliminate this source of error the division-board and comb were replaced alternately at short intervals, and every time the one or the other was removed it was placed in the case that was kept at the uniform temperature. The average temperature M_1 were then taken with the division-board, then the averages M_2 with the comb, and these could be compared. To obviate error occurring from the influence of the variation of the outer temperature, duplicate experiments were made, but in this case beginning with the comb. This second series furnishes fresh averages, M_3 for the division-board and M_4 for the comb. The average of the averages M_1 and M_2 can then be compared with the averages M_3 and M_4 .

Results of Experiments with Hive No. 1.—First Series of Experiments (October 9th, 1890).—The cluster of bees occupies ten frames between the side A (Fig. 1) and the frame covered with gauze (G G). The eleventh frame of comb, C, is placed next to the frame G G, and thermometer *t* by the side of C. Another thermometer (B, Fig. 1) indicated the external temperature. Beyond the thermometer *t* would be placed the division-board P, or this could be replaced by a frame of comb. All the frames were covered with woollen cloths, but the space between P and B was simply covered by boards and a quilt.

In the first series of experiments nineteen observations were made between 6 a.m. and 9.40 a.m., the division-board and frame of comb changing places six times. The temperature inside the hive rose from $+6.75^\circ$ to $+9.25^\circ$, whilst that outside rose from $+6.00^\circ$ to 11.00° .

Second Series of Experiments (October 10th, 1890).—This was carried out like the first, except that it was commenced with the comb instead of division-board.

The results of the two series of experiments were that the average for the division-board in

the first series was =7.54°; the average for the comb was =7.64°.

In the second series the average for the division-board was = 8.23°, and for the comb = 8.08°.

From this it follows that the average of the averages is for the—

Division-board	7.88°
Comb	7.86°

The experiments on hive No. 2 gave for—

Division-board	8.44°
Comb	8.46°

There were nine combs in the brood nest between the side of the hive and wire gauze, then came the thermometer, and it was beyond this that were placed either one or five frames of comb.

The average temperature was with—

One comb	11.00°
Five combs.....	11.25°

Therefore it will be seen that *there is no appreciable difference between the efficacy of one or several combs with respect to loss of heat.*

M. Bonnier points out the objection that

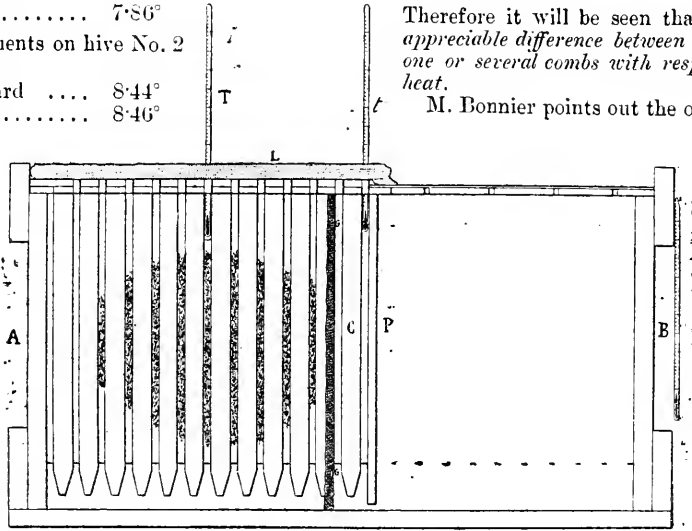

Fig. 1.

From which it results that *the temperature outside the cluster of bees, taken at the same point, is exactly the same whether there is a division-board or whether this is replaced by a frame of comb.*

Experiments with several Combs (October 12th, 1890).—Having arrived at the above unexpected results, M. Bonnier wished to see

might be raised to these experiments, and the means he took to avoid any errors in his calculations relative to the temperature of the cluster in respect to that of the outer air.

Method of Verifying the Experiments.—Profiting one day by the temperature in one of the rooms of his biological laboratory at Fontainebleau, which was steady at -3°, he placed a hive there arranged in the following

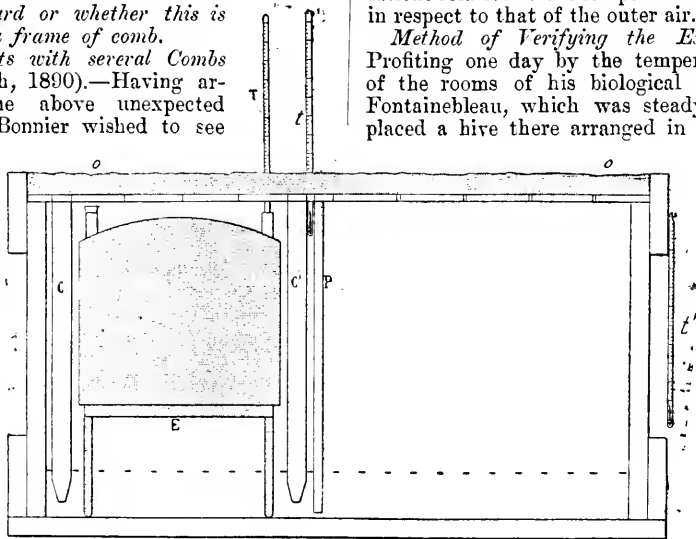

Fig. 2.

what would be the difference in placing five combs at a time one behind the other instead of the division-board,

manner:—The cluster of bees was replaced by a tank of glycerine (E, Fig. 2), heated to a given temperature. A frame of comb was

placed on each side of this tank, one (C, Fig. 2) against the side of the hive, the other, C¹, towards the centre. The thermometer, *t*, was placed next to this, and the temperature of the tank was observed by another thermometer, T. Outside C¹ could be placed either a division-board or a frame of comb. The division-board was covered with wadding on both sides, so that there should be no passage for air except at the bottom. The top of the hive was covered with boards, which were in turn covered with wadding, the entrance was open as in winter, and was in direct communication with the outer air, which stood at -3° . Thus arranged the hive was placed in the cold chamber, and the division-board and frame of combs were interchanged alternately.

The tank was allowed to cool gradually. It is evident that if the effect produced by the division-board and comb are the same, the temperatures indicated by the thermometer, *t*, must decrease in a regular manner. It would be otherwise if the loss of heat were greater with the one than with the other.

The experiment proved that the thermometer, T, in the tank fell gradually from $+35.5^{\circ}$ at 3 hrs. 45 mins. p.m. to $+31.5^{\circ}$ at 5 hrs. 15 mins. p.m. So also the temperature indicated by the thermometer, *t*, fell from $+15.00^{\circ}$ to $+14.00^{\circ}$ in the same time, the exterior temperature being constant at -3.00° . The division-board and comb took each other's place alternately, being changed four times.

The general conclusion M. Bonnier comes to is that *one or more combs are just as efficient with respect to the prevention of loss of heat in a hive as a division-board.*

In endeavouring to ascertain the reason for this astonishing equality he sums up in the following way:—

The heat produced by a cluster of bees can be dissipated on the empty side of the hive in three different ways:—

1. By conductivity.
2. By radiation.
3. By the current of air produced at the bottom and sides of the hive.

A.—Wax is not quite such a good conductor of heat as wood, which gives a slight advantage in favour of the comb.

B.—Of all bodies wax allows the least amount of heat to pass by radiation (Tyndall's experiments), which gives a second advantage in favour of the comb.

C.—The division-board is closed at the sides, and only allows air to pass at the bottom, which gives an advantage in favour of the division-board.

The above results show that the advantages of the one over the other are about evenly balanced, and that there is really no advantage in the division-board with regard to retaining heat in a hive.

GLEANINGS.

In the *Deutscher Bienenfreund*, O. Krancher explains the tones caused by the vibration of the wings of the honey-bee. Humming in the musical tone of *A*, its wings vibrate 440 times a second, and only when tired out after a long flight the tone may become lowered to *E*, which represents 330 vibrations per second. When the number of vibrations is reduced to 190 the humming is over an octave lower than the note *A*.

BEE RAMBLES IN SAVOY.

(Continued from page 197.)

Albertville was our terminus, the railway going no further, and we decided to have dinner at the *Hôtel Million*. There we had a characteristic Savoy dinner, a great variety of different dishes and delicacies; amongst other things, livers of small birds, stuck on to a silver skewer alternately with small pieces of bacon. We had already made a good dinner, and when this arrived there was no appetite left for the *bonne bouche*; but the waiter pressed us to try it, saying it was a very rare dish, and the *chef* would feel grieved if we did not do so. We therefore tasted them, and found them delicious, but we could not help feeling that many small and useful birds had been wantonly slaughtered for the sake of this epicurean dish. Our own preference would have been to see these birds flying about, and to hear their sweet song. At last our dinner came to an end, and we engaged an open carriage, which was to take us as far as Moutiers, a distance of about twenty miles.

On leaving Albertville our road took a sharp turn, following the course of the Isère, and entering the district known as the Tarentaise through a succession of beautiful scenes. The low ranges of the mountains are beautifully wooded, the valley narrow and pastoral in its character, sainfoin being seen in all directions. Several ruins of castles were seen on heights that jut out on rocks from the rich background of forest trees, and the road itself winds through pleasant shades overhung by walnut and chestnut trees. We passed the village of La Bâtie, and here we found several bee-houses containing large straw and the old-fashioned box hives, as well as some shallow wooden hives, storified three and four high. Several such houses, under the shade of trees, were seen—at some of them the bees hanging out in large clusters. M. de Layens told us, *apropos* of these hives in the shade, that he had two apiaries, one situated in a wood and another in a garden. The hives in the wood were completely in the shade, and at the inspection he gave them before he came to Switzerland he found them to contain one-third more capped brood than those in the garden, although they had all been wintered under similar conditions. Moreover, those in the garden had consumed six pounds more of their provisions. He considered that wintering under the shelter of trees is better than in the open air, and

thinks that the hives are better protected from the winds and sudden changes in temperature.

After leaving La Batie we passed a fine cataract which dashes amidst immense rocks, and a portion of whose waters works a saw-mill. A few miles further on we came to Aigueblanche, and here we got out, with the intention of going up to Le Bois to visit M. Ruet. A climb of a little over half an hour brought us to a small hamlet of a few houses scattered on the slope of the mountain, and we had not much difficulty in finding M. Ruet. When we presented ourselves at his workshop door we found him busy at work making frames. He did not know we were coming, and when M. Bertrand told him who we were he looked quite

he has eighteen frames of double the usual depth—making the hives equal to thirty-six frames. The colonies were enormous and gathering honey in abundance. There was another bee-house where the hives were arranged on two shelves, with a passage at the back. When a hive has to be examined a temporary platform rests on the shelf and a ledge at the back; on it are two guides which correspond to similar guides on the shelves. The hives are on rollers which run between these guides, so that they can be rolled back on to this platform. One of these hives was examined M. Ruet standing on one side and we on the other, and we very much admired this neat and simple contrivance for getting over the difficulty of inspecting hives on

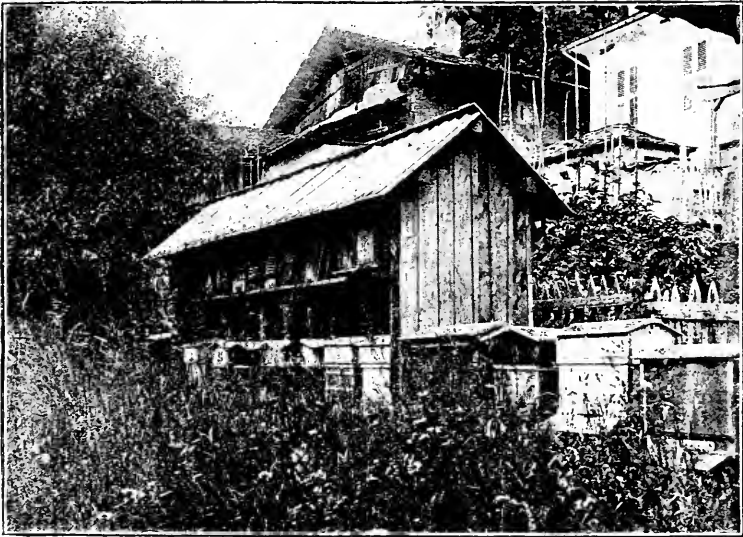

APIARY OF M. RULLIER.

perplexed, and did not seem at all pleased to see us, in fact he received us very coldly. However, he asked us to go in and have some refreshment, and made us partake of bread and cheese and honey before he warmed up. After this hospitality, however, he became most enthusiastic and communicative. He afterwards confided to M. Bertrand that although he knew us all very well he was so amazed at seeing us three before him that he could not realise if it was reality or only a dream, for he never expected that we would ever come up to his mountain home. He makes all his hives himself, and has a nice circular saw with which he cuts out his small work. We then went to see the bees. He had a number of hives standing out in the open, six of these of the Layens pattern besides a number of the Burki pattern. Several hives were examined and then an inspection was made of a bee-house which contained twelve colonies on Burki frames, only instead of the twelve frames

shelves. These bees were Cyprians crossed with blacks, but very quiet. Last year they gave a swarm weighing 5 kilos. 100 grammes, which built eight frames and gave eighteen sections of honey. The stock made thirty sections and fifteen kilos. of extracted honey. Another colony we examined had given twenty-eight double sections, that is sections of two pounds, besides fifteen kilos. of extracted honey. M. Ruet has also four Dadant-Blatt hives at Les Avanchets, about one hour higher up, and the honey from this place, which we had an opportunity of tasting, was remarkably fine, almost as smooth as butter and with a distinct almond flavour. In addition to his own hives M. Ruet looks after 116 other hives in the neighbourhood, all on the movable comb system, and all of which have been started through his instrumentality.

The people about here are taking to modern methods, and bee-keeping is spreading rapidly.

There was one bee-house with large straw hives which were used for furnishing swarms.

M. Ruet was communicative enough before we left, and insisted on accompanying us down to Aigueblanche, where he saw us off, and promised to be with us at Moutiers the next day. After leaving Aigueblanche the road rises for some distance, in order to avoid the deep gorge through which the Isère passes, and then after making a turn round a projecting piece of mountain descends to Moutiers. Here we stayed at a comfortable little inn, kept by M. Bertoli, and in course of conversation we found that he was an Italian, and a cousin of M. G. Bertoli, of Valsesia, whose bee-keeping on Monte Rosa is described on page 8 of this year's *B.B.J.* Unknown to us M. Ruet telegraphed to M. Rullier, at Bellentre, to say we were staying at Moutiers, and to our surprise next morning, as we were at breakfast, in stepped this gentleman, having walked four or five hours to this place to see us.

This was a quiet day for us, and M. Ruet walked over from Aigueblanche to dine with us, and we found him most agreeable, and very different to what he appeared at first. He had got to know us better, and realised that we were but humans, and not the ogres he must have fancied us at first. In the afternoon M. Bertrand and M. de Layens drove over with M. Ruet to Brides-les-Bains, a bathing establishment, the Doctor, who is also the principal, being a bee-keeper, and supplying his guests with honey produced by his own bees. There was not much of interest in Moutiers except the river and a few ruins of what were formerly salt works. At six next morning another start was made, as we wished to get to Bourg St. Maurice as early in the day as possible, and we had to drive uphill all the way for twenty miles, which meant going at a walking pace. M. Rullier walked back to Bellentre the night before, and promised to be ready to receive us in the morning.

In a district where the scenery is generally fine it is difficult to pick out anything especial for separate notice, but we certainly were much charmed with the grandeur of the scenery through which we passed. The road ascends the right bank of the Isère, and the valley becomes very narrow, so that the road has to be carried over a neck of rock for some considerable distance at a great height above the foaming torrent. In several places there are tunnels cut through the rocks overhanging the river. The view looking back upon St. Marcel, with the snow-topped mountains in the distance, is very fine. We could not help on our return journey taking a series of views of this picturesque part of the road. We passed through one tunnel, and over our heads roared a cataract, which dashed into the torrent below, and reminded us very much of the galleries on the Simplon Pass. Just beyond, the valley was again wider, and several villages were scattered about, which lent enchantment to the view.

We saw several bee-houses containing straw skeps, and learnt that this district of the Tarentaise was famous for its honey, which was much sought after. In 1881 there were 19,600 hives in the department, which, according to the returns, yielded 83,200 kilogrammes of honey and 16,600 of wax. Longefoy, which was specially pointed out to us, on the slopes of Mont St. Marcel, and of which we saw the church and spire high above our heads, standing out in relief against the sky, is particularly famed for its honey.

We then passed Aime, containing ruins of an old castle and a large disused convent, and were not long before we reached Bellentre, where we found M. Rullier awaiting us. M. Rullier is the schoolmaster of the village, and was able to dismiss his school and devote that day and the next to us. He is the President of the Bee Association of the Petit St. Bernard, and is quite an important personage in the district. Of course, after our long drive we were ready for breakfast, after which we made an inspection of the apiary.

The illustration on p. 219 gives a good idea of the apiary. M. Rullier has in all thirty-six hives of various patterns. In the bee-house different sorts of hives are placed on two shelves. Here we found straw, box, and ordinary frame hives. On the boxes racks of sections were being worked, and there were two hives with frames $13 \times 13\frac{1}{2}$ inches. Along the front will be seen seven Dadant and four Layens hives, teeming with bees, and partly hid by the luxurious growth of sainfoin before them. Here, while we were preparing to take this photograph, a bee took a fancy to M. de Layens, and would not leave until it had made better acquaintance with his nose. M. Rullier last season took 300 kilos. of extracted honey, 50 sections of 500 grammes each, and 50 larger sections of 600 grammes each. Hives were opened and examined, and the bees were intent on their work, as this was just the beginning of the honey harvest in this district.

We then went into the house and were shown appliances without number. There were racks of sections and supers of frames ready to put on the hives, which would all be wanted in a few days. M. Rullier instructs the children attending the school in bee-keeping, and on the walls of the schoolroom we found, amongst others, diagrams used in the technical instruction of this branch of industry. The grape-vine is cultivated as far as Bellentre, beyond which it no longer succeeds, but here also bee-keepers thought wine could be profitably replaced by hydromel. M. Rullier makes his own comb foundation on one of Reitsch's machines; but we did not like the look of it very much, as it was very full of holes, which the bees would enlarge rather than fill up. However, we were told this was not a good sample, and certainly the combs that were examined were found to be all that could be desired.

(To be concluded next week.)

Correspondence.

The Editors do not hold themselves responsible for the opinions expressed by correspondents. No notice will be taken of anonymous communications, and correspondents are requested to write on one side of the paper only, and give their real names and addresses, not necessarily for publication, but as a guarantee of good faith. Illustrations should be drawn on separate pieces of paper.

Communications relating to the literary department, reports of Associations, Shows, Meetings, Echoes, Queries, Books for Review, &c., must be addressed only to 'The Editors of the "British Bee Journal," 17 King William Street, Strand, London, W.C.' All business communications relating to Advertisements, &c., must be addressed to Mr. J. HUCKLE, Kings Langley, Herts (see 1st page of Advertisements).

* In order to facilitate reference, Correspondents, when speaking of any letter or query previously inserted, will oblige by mentioning the number of the letter, as well as the page on which it appears.

EXCLUDER ZINC—VASELINE.

[636.] Now that the above is on the carpet, it may be well to give it a good airing. To judge from the advertisements, &c., it appears we are going to have a very superior article to that formerly used in the way of excluder zinc to keep our queens in proper limits. Has the new pattern been practically tested, and proved to be better in any way than the ordinary pattern, or does the improvement remain at present only in theory? We have many times seen complaints respecting defective zinc. Sometimes the defects are said to be irregular perforations, and many times *weakness* of the material, when, as soon as placed into a heated hive, the expansion of the metal has caused buckling, which, of course, would enlarge some holes sufficiently for a queen to pass. In the new pattern I notice the perforations are longer, and less material is left between them than the ordinary kind, which, of course, materially weakens the sheet, and would increase the buckling tendency; while, on the other hand, the more metal there is cut out the less obstruction is offered to the passing bees. Personally I am quite content with the old sort, which I got from Messrs. Abbott, I believe. I have used it now four or five seasons with most satisfactory results, have never known a fertile queen to pass it, or ever had the least difficulty to get the workers through it.

Vaseline on our frame-ends, dummies, and section racks would no doubt make them *run lighter*, as most things do when well greased, but how will it fare with the poor bees when chilly autumn comes on, with innumerable small holes and chinks between and under frame-ends, and around dummies and badly fitted quilts, and all so vaseline bedaubed that they cannot stop the intolerable draught which, led by unerring instinct, they are sure to do if possible for their own comfort and safety? I fancy I can see the little creatures standing peeping into these little crannies, shivering with the cold draught, and yet quite unable to stop them. Our microscopic friends owe the editors their best thanks; they have had a grand treat, I should think.—HY. NEVE, Warbleton, Sussex.

[There can be no objection to 'airing' the subjects alluded to by our correspondent, and we

shall welcome expressions of opinion having any real bearing upon the points at issue. At the same time it must be borne in mind that opinions expressed by editors carry with them a measure of responsibility from which the ordinary communication of correspondents are free; this responsibility we shall not seek to avoid. In view of this we must be allowed to state that the initiatory steps towards obtaining a more perfect make of queen-excluder zinc emanated from ourselves, and were rendered necessary by bee-keepers justly complaining of the defective kinds now sent out. In the interest of readers we recommended a pattern of zinc free from the defects complained of, including those mentioned in the above letter, for our correspondent is altogether wrong when stating that in the new pattern 'less material is left between the perforations than in the ordinary kind' (see *B.J.* for April 9th, p. 176). As to the use of vaseline, we need merely refer readers to our remarks last week, on p. 213.—EDS.]

WATER FOR BEES, ETC.

[637.] During the spring months bees carry a large quantity of water into the hives, and as very many perish in the attempt to obtain it from soft-water cisterns and tubs, bee-keepers should provide water for them close to the apiary. An excellent plan is one that I found out quite by accident. Two years ago, being much interested in certain bog-plants—*Sundews*, *Butterworts*, *Pimpernel*, and several orchids—I filled a pan with these plants and a large quantity of sphagnum moss. This pan stood in a larger one, kept full of water, and formed a miniature bog. On a warm day the bees swarm on this sphagnum, and I counted fifty-two on it recently at one time. I believe it is no exaggeration to say that an apiary of fifty hives would take a quart of water a day in this way.

I notice the 'bee-papers for winter reading' are still continued. This is as it should be, for there was ice as thick as a shilling on our fowls' water on April 17th! The Chinese name for honey, which being translated means 'sting-bug juice,' reminds me of the natives of Tahiti (in the tropics), who on first seeing a horse named it the 'man-carrying pig!'

In your reply to W. H. Dallas, page 191, I was surprised to see the nasturtium mentioned as a bee-flower. In this district, so far as I have observed, it is rarely visited by hive bees, but is great favourite of the humble-bees. Besides those flowers you name I would recommend the Canadian balsam, a very good autumn plant, which flowers profusely till cut down by severe frosts. This is the plant that causes our bees to look like so many dusty millers. They cannot get at the pollen on the thorax with their legs, and so have a mouldy appearance, sometimes for weeks. A bee-keeping friend of mine was quite frightened at this apparent mouldiness until I explained the cause. An interesting thing about this plant is the way in which it scatters the seed. The valves of the pod or capsule, when ripe, have a wonderful elastic

power, bursting with a sharp report and scattering the seeds far away with considerable force.

I should like to know if others have seen bees working the nasturtium. They may do where other flowers are scarce, for it is well known that in some places the hawthorn is well worked, while in others the honey-bee passes it by and hurries on to the sycamore, fruit-tree blossom, or some other greater attraction. It is a fact that neither of these two flowers are worked by the bees of—LORDSWOOD, M.W.B.K.A.

SECTION-FOLDING.

[638.] 'The time of the singing of birds is come;' and so the time for the folding of sections is at hand. For the benefit of other readers of the *B. B. J.*, I send description of 'folder' made and used by myself, so that any who are of a mechanical turn may construct one for themselves. It is after the style of the iron press sold by Mr. Meadows, of Syston. A reference to sketch (Fig. 1) will show its construc-

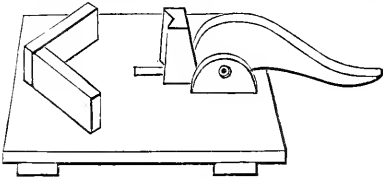

Fig. 1.

tion, while the trouble of making it will be far outweighed by its usefulness and the saving of time, the sections being folded in a second, square and true, by simply uplifting the handle of eccentric lever.

Fig. 2 is drawn on a $1\frac{1}{2}$ -inch scale, i.e., $1\frac{1}{2}$ inch to the foot, so that the size of the several

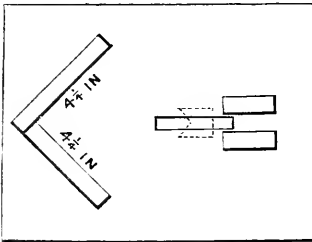

Fig. 2.

parts may be at once ascertained. The bottom board may be $\frac{5}{8}$ -inch thick; the square, cramp, lever, and blocks should be 1 inch, either red deal or hard wood; the square and blocks to be firmly screwed to board to withstand pressure. Up the front of cramp (which slides in a mortise) is cut a square V groove, to hold corner of section. The bottom of cramp is shouldered, leaving tenon of sufficient length to be flush with under-side of board, a block being screwed to tenon underneath, holding cramp firmly, but giving sufficient play to move easily. Sections are best and easiest folded by putting dovetail corners next cramp.—UN AMI.

YE EXPERIENCE OF YE SPREAD EAGLE.

[639.] I commenced 1890 with two double-walled hives (standard frames), one straw skep (on examining which later in the spring I found the bees had gone over to the majority), and one single-walled antiquated *consarn* (built about the time of Noah), with bars ten inches deep: to gain a little experience I determined to place the bars therefrom in a box, which was placed on another double-walled standard hive with full sheets of foundation in the frames. They certainly did go down, and eventually used the seven ten-inch bars as their pantry, of which I took charge at one time, but came to the conclusion that it was very slow work, and not worth trying again; still, I had not the bother of a swarm.

On Whit-Sunday a man rang my bell about 9 a.m., and told me that he thought my bees had swarmed and were going into the wall of an old house. I went to look and soon came to the conclusion that they were not mine, but soon would be, *nem. con.* On the next day (Whit-Monday) having seen all my *bee-neighbours* without finding an owner, I set to work, getting a ladder, hammer and chisel, a saw, and a cold chisel. The old house, where the bees had taken up their quarters, being built—like a great many in Sussex—on the weather-board principle: some of your readers may know what that means, but for those who do not I will try to explain, viz., the sides of the house are built of bricks in the ordinary manner, while the front and back have a wooden framework of battens, with laths and plaster on the inner side, while the outer side is covered with tiles, slates, or weather-boards. The interspace, being hollow, is sometimes inhabited by a truant swarm of bees, as in the present instance.

I provided myself with a hive, carefully putting in a frame of brood, with one or two frames containing food, and nearly filling up with frames of foundation, leaving room to shake the bees into the back of hive, when I had succeeded in getting them. Having got all in readiness, business commenced by putting on my Cardigan (which I always wear when manipulating), filling a stock of pipes, then choosing the largest which was carefully lit, the veil was put on, and mounting the ladder I was soon at work, pulling off the tiles—which were thrown to some distance in case of a hasty descent being necessary; but on this occasion all went as merry as the proverbial marriage bell. Judging by the colour and toughness of the combs, it was evident that several generations of bees had first seen the light there.

The combs were placed in a slanting direction about eight or nine inches in breadth, and some of them at least nearly two feet in depth, and fairly crowded with Carniolans, 'all very fine and large.' With the aid of smoker and pipe the combs were cut out one by one and carried down the ladder; the bees were then shaken into the back of the hive and covered with a cloth. I was a little bothered at not being able to find

the queen, but by the time I had about two-thirds of the combs down, I noticed some of the bees fanning on the floor, or rather alighting-board. I therefore came to the conclusion that her Majesty was at home, and I simply threw the remaining bees on the alighting-board as I brought them down.

This took me the best part of the afternoon, but I was well satisfied with this (my second) venture at removing bees from a similar building. There was, as usual, some bad language floating round, but only by the bees; your correspondent *did not* get stung, or—well, never mind, he didn't. After dusk the hive was carefully carried home and placed in the garden. They swarmed again and I made four nuclei from them as well.

One of my old stocks gave me sixty good sections, about forty of which were first-class.

Last December I had to remove my hives from Sussex to Northamptonshire; the ventilating floors were opened and the entrances securely blocked, they were placed in a furniture van, and had a journey as follows: five miles by road to rail, thence 50 miles to Victoria; across London to St. Pancras; thence to our station, about 64 miles, and again by road $3\frac{1}{2}$ miles; total distance, as near as I can tell, $122\frac{1}{2}$ miles. They were put into the vans on *Thursday* and taken out on the following *Tuesday*.

I should mention that the five hives were brought in this manner: three double-walled all round; one double at sides, but single front and back with half-inch dummy in front; and one single-walled all round. On an examination during the first warm days in February, the unfortunate beings in the *single-wall* had gone over to the majority, one of the double-walls had lost a great many, but the others not so many as I expected; and what was most cheering, all had sealed brood, and some had hatched out and looked strong and healthy. They look at present *fit and well* and likely to do good service here.—
YE SPREAD EAGLE.

NOTES BY THE WAY.

[640.] We have entered into the 'merry month of May,' when, as the old song says, 'bees from flower to flower do hum.' The boisterous wind with which the month was ushered in, reminded one of the beginning of March rather than May; but Nature has been, and is still, putting on her verdant robe, and the woods echo with the trilling and warblings of our feathered songsters, proclaiming that spring is here, and before the end of the month no doubt we shall hear of swarms of bees in some of the sheltered forward districts. We have had a beautiful rain so much needed after nearly three weeks continued dry weather, coupled with cold searching winds, which have retarded the growth of vegetation very much in our district.

The opinion that foul brood has been propagated by the use of foundation made from wax from infected colonies, appears from the *American B.J.* to have received its *quietus*, and any fears entertained on that point are groundless, as

wax, before making into foundation, requires to be kept at a high temperature so many hours for any impurities to settle at the bottom of the vessels containing the wax. Pasteur, the French *savant*, has ascertained that all the seeds of disease which may exist in wine, can be destroyed if the wine is heated to a temperature of 140° , and as beeswax does not melt below 148° , there can be no doubt that the spores of foul brood would be destroyed; but as Mr. Dadant observes that their firm, probably the largest manufacturers of foundation in the world, keep their wax liquid for at least twenty-four hours, and that they in the first boiling mix the wax with water, and keep the temperature at 212° , and that any scum that arises is taken off and placed in barrels out of doors to which their bees have free access, and visit freely, yet they have never contracted the disease during the past fourteen years, this points to the fact that we need not fear infection by using foundation.

The present month will be an opportune time to discuss self-swarm hivers. Will those who tried them last year kindly give us their opinions on the matter, also on style of automatic hiver used?

Thanks, Mr. Brown, for your letter *re* Bees and Fruit-growing. An ounce of practice is worth a pound of theory, and items of fact, such as your letter, are a grand refutation of the detractors of the busy, useful bee.

Vaseline, I take it, will be used in small quantities, simply rubbed on the wood runners, and the sides and ends of the metal ends, or wood shoulders of frames, to prevent propolisation of the movable parts of the hive, and instead of looking at it in the light of an infliction on my bees, as our Rochford friend seems to imply, I had looked forward that it would save the bees much labour, collecting propolis; there is very little scent to the bottle of vaseline we have in the house, nothing obnoxious to my olfactory nerves, though what effect it may have on my bees' more highly strung nerves I have not had an opportunity of knowing at present. Our good friend E. H. Leeny, speaks very highly of its utility: I suppose—nay, more, I hope—his use of vaseline in no way affects the mortality in his apiary, for want of propolis to fill up all crevices and keep out all draughts; but information to hand from private sources, speaks of other causes for heavy mortality this past winter. One says his losses are chiefly among the old-established (propolised?) stocks, while his success has lain, this season, with driven lots fed up quickly at end of summer. Another says he has successfully wintered some small lots of driven bees in nucleus hives; while I myself can aver that two stocks of bees that are strong now, had crates of empty combs and empty sections left in all the winter till I looked in and removed them a month back, and only two thicknesses of hemp carpet over the top of crates; one crate had only six sections of empty comb, the remainder of crate was empty, with dividers lying crosswise just as they fell when the honey was taken off last summer. Yet others in straw skeps, with food in store, had died off during winter,

standing all in the same row, and wintering on the same natural stores gathered by the bees. Why is this?—W. WOODLEY, *World's End, Newbury.*

Queries and Replies.

[351.] *Four Bee-way Sections.*—Being anxious to make for own use some four bee-way section racks, what would you advise as a substitute for Hooker's metal supports (p. 50, *Guide-book*). I'm taking it for granted that four bee-way sections are better than two bee-way.—Box, *Feltham, Middlesex.*

REPLY.—The advantage claimed for the perforated supports is that the bees can reach upper stories without travelling over the combs of lower ones. No substitute will quite accomplish this. However, if slotted dividers are used and the sides of racks are hollowed out to allow a bee-passage from section to section they will answer your purpose.

Echoes from the Hives.

Paignton, South Devon.—My stocks are working with good-will, thanks to the bright sunshine we are having all through this month, although the easterly wind remains with us still. Generally stocks in this part have stood the severe weather well and are strong and healthy. Trusting your own bees are equally well favoured.—GEORGE JOHN FREEMAN.

Morchard Bishop, North Devon, May 2nd.—The weather here has been very cold and windy; flowers of all sorts are backward. To-day I see the bees hard at work and carrying in lots of pollen. I heard of a swarm (?) on the 24th coming out and making their way into a neighbouring hive, and settling peaceably with the lot already in possession. I do not think we shall

have any natural swarms here for the next fortnight.—W. F. TRONSON.

Notices to Correspondents and Inquirers.

Replying to the notification on p. 203 of *B.J.* for April 23, Mr. Geo. J. Freeman, of Glenmire, Paignton, South Devon, writes:—'Failing any reply from a "Bee Expert," I should be pleased to give the lady at Staverton, near Totnes, any advice on practical experience that lays in my power, should she feel disposed to write me; I am only a few miles by road from her abode.'

DR. TINKER'S BOOKS.—A correspondent who writes concerning these under date 24th April and signs himself 'J. C., a Donegal Bee-keeper,' will be communicated with on sending his full name and address.

T. G. (Staffs.)—We regret your inquiry has been mislaid for a few days. The bees may be got into condition for gathering supplies by mid-June if the dwindling has not been excessive and the queens are fairly prolific. Feed regularly and pack very warm.

CHARLES M. ELLIS (Llanfairfechan).—We advise your beginning to build up stocks at once, to be ready for clover by the second week in June.

R. PUTTOCK.—*Hiving Swarms.*—Refer to *B.J.* for May 15th, 1890 (p. 231), or we will send the number post free for three halfpenny stamps.

W. F. TRONSON (Morchard Bishop).—Comb contains only pollen, which has been kept fresh by being covered with honey or syrup. If there are no signs of foul brood in the hive, the combs may be used again.

* * * *Communications from 'Augustus,' T. Kirwan, and Dr. Miller, together with some queries, are in type, and will appear next week.*

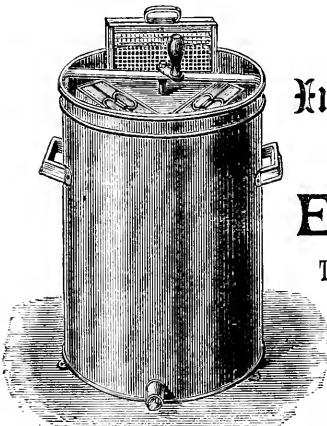

No. 1.—Price 21s.
Packed in Case, 1s. 6d. extra.

LOWTH'S Improved Patent 'Unique' Bar-frame and Section EXTRACTORS.

Twelve High-class Awards at Royal & County Shows.

These Machines are suitably adapted to meet the requirements in both large and small Apiaries.

Illustrated Circulars Free. Full Instructions.

INVENTOR AND PATENTEE:

T. LOWTH, Riseholme, Lincoln.

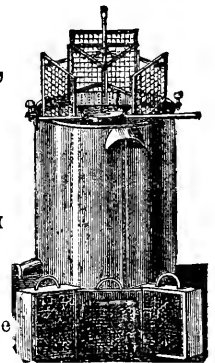

No. 2.
Price 7s. 6d.
Postage 9d.

THE
British Bee Journal,
BEE-KEEPERS' RECORD AND ADVISER.

No. 464 Vol. XIX. N. S. 72.]

MAY 14, 1891.

[Published Weekly

Editorial, Notices, &c.

**BRITISH BEE-KEEPERS' ASSOCIATION
AND TECHNICAL EDUCATION.**

A conference of members and representatives of County Associations was held on Wednesday, May 6th, at five o'clock, in the Board-room of the Royal Society for the Prevention of Cruelty to Animals, 105 Jermyn Street, S.W. Mr. T. W. Cowan presided, and the following gentlemen were also present:—The Hon. and Rev. Henry Bligh, Mr. W. Broughton Carr, Captain Campbell, the Rev. F. T. Scott, Mr. Harris, Dr. Rayner, the Rev. W. E. Burkitt, Mr. Garratt, Mr. Sollas, Mr. New, Major Fair, Mr. Hooker, the Rev. E. Davenport, Mr. Meggy, Mr. Morris, and others.

The special subject for consideration had reference to technical education, and to grants to be given by County Councils on its behalf, and as to the best way of urging on those bodies the claims of bee-keeping as an important rural industry, for obtaining subsidies for the purpose of teaching the theory and practice of it, and otherwise encouraging the pursuit.

The Chairman (Mr. Cowan), in opening the proceedings, said that the meeting had been called in consequence of letters from County Associations written to the Committee, and brought forward at their last meeting, asking for information as to how the County Council grants were to be obtained in favour of instruction in bee-keeping. The matter was originally brought up, as some might recollect, at the last conversazione, when Mr. Meggy was good enough to point out that County Councils had large sums of money at their disposal for the furtherance of technical instruction. Since then the subject had been referred to in the *B.B.J.*, and in that way the attention of bee-keepers had been called to it. The letters were considered at the last Committee meeting, when it was decided that a meeting of representatives of County Associations, and members who took an interest in the matter, should be convened. It would not be necessary for him to enter into the question of the advisability of technical education. On that point they were all agreed. As regarded technical education generally, this country was late in taking action, compared with other countries. But, as Lord Grimthorpe said the other day,

'John Bull is a slow beast and takes a deal of rousing, but when once roused he can make a noise.' Certain it was that a great stir was being made now about education, and he had little doubt that free education would soon be adopted in England, thus following the example of other countries. Technical education was taken up much more extensively on the Continent than here, and was imparted in elementary and primary schools abroad. Every schoolmaster in Germany understood the theory, and to some extent the practice, of bee-keeping, and was obliged to qualify to teach it. In France, Belgium, and Switzerland, technical instruction was considered important, and the schools of the Moravian Christian Brothers were renowned as technical schools. Visitors to Neuwied on the Rhine would have an opportunity of judging for themselves the class of men and women turned out from the technical schools there. It is estimated that about one-fourth of the population of this country was dependent on agriculture; it is therefore quite evident that agriculture ought to be fostered and encouraged, especially if it was desired to prevent the overcrowding of towns and keep up a country population, and in order that the latter might compete successfully with foreign rivals they must have technical education, or they would fall far behind other countries. Starting with the postulate that bee-keeping is a branch of agriculture, then as such it must form part of an agricultural training. That had been recognised by a good many writers, and Mr. James Long, in a paper read before the British Association at Bath, said with reference to technical education in agriculture:—

'In particular districts, special subjects applicable to those districts should be more fully taught, such as dairying, fruit-growing, hop-growing, and bee-keeping.'

Then, in the *Journal of the Royal Agricultural Society*, issued on March 31st last, Professor Fream (Professor of Agriculture) wrote as follows:—

'But it is necessary to not only interest the boys and girls; we must get at the parents also. To promote this object there should be some properly defined system of education working from a recognised centre. There might be instituted a series of lessons in what might be termed rural economy, which would certainly attract the attention of farm labourers, and possibly of their

wives as well, and if the older people were secured the children would follow. Practical instruction might be given upon the making of butter, the management of bees, and the keeping of poultry, whilst a lecture or two upon the pig would find attentive listeners. Bees, poultry, and pigs would afford safe staples to work upon.

That was sufficient to show that the Royal Agricultural Society admitted the importance of bee-keeping as a branch of agriculture. Again, the Science and Art Department had distinctly recognised bee-keeping in the same category, and on his (the Chairman's) recommendation, Mr. Cheshire was engaged to lecture on bee-keeping to agricultural students at South Kensington. The Education Department had also allowed it to be taken up as an extra subject in schools. Unfortunately, however, little good had resulted from that step. The Inspectors appointed to examine were not acquainted with bee-keeping, and probably it was rather a bother for them to have an extra subject to get up; thus apiculture was not encouraged by them. With regard to the funds available for technical education, first of all there was an amount at the disposal of the Board of Agriculture of 5000*l.* a-year. The following was the clause of the Act by which the Board was enabled to use the money:—

'The Board of Agriculture shall also undertake the collection and preparation of statistics relating to agriculture and forestry, and may also undertake the inspection of, and reporting on, any schools which are not public elementary schools, and in which technical instruction, practical or scientific, is given in any matter connected with agriculture or forestry, and the aiding of any school which admits such inspection, and in the judgment of the Board is qualified to receive such aid, and the aiding of any system of lectures or instruction connected with agriculture or forestry, and the inspection of and reporting on any examinations in agriculture or forestry.'

Five thousand pounds a-year would go a very little way in the country; fortunately the Board had an increased grant for the present year, namely, 8000*l.* It was possible that at some future time there would be a chance of getting money from the Board of Agriculture to supplement subsidies from elsewhere. The other source of funds, from which bee-keepers had great expectations, was in the hands of the County Councils; and it was concerning these that they were assembled that evening for discussion. The County Councils have large sums at their disposal. These vary for different counties. Mr. Meggy, Hon. Secretary of the Essex Association, says that his county has something like 17,000*l.*; Kent has, I believe, 22,000*l.*; Wilts, 9000*l.*; Lancashire as much as 39,000*l.* These sums have been derived from beer and spirit duties by an Act passed in 1890, which is called the Local Taxation (Customs and Excise) Act. This statute, in placing various sums of money at the disposal of the Councils, says:—'The Council of any county or county borough may contribute such sum, or

any part of such sum, for the purposes of technical education within the meaning of the Technical Instruction Act, 1889, and may make that contribution over and above any sum that may be raised by rate under that Act.' It should be noted that the word 'may,' not 'must,' was used. Now, it might be asked, What was 'technical education?' And, luckily, the Act gave a close definition of it. In order to avoid all misunderstanding, the Act said:—

'The expression, "technical instruction" shall mean instruction in the principles of science and art applicable to industries, and in the application of special branches of science and art to specific industries or employments. It should not include teaching the practice of any trade or industry or employment, but, save as aforesaid, shall include instruction in the branches of science and art with respect to which grants are for the time being made by the Department of Science and Art, and any other form of instruction (including modern languages and commercial and agricultural subjects) which may for the time being be sanctioned by that Department by a minute laid before Parliament, and made on the representation of a local authority, that such a form of instruction is required by the circumstances of its district.'

Bee-keeping, therefore, clearly came within the definition, because it included the science and art applicable to a specific industry. After the article on the subject of the County Councils' grants appeared in the *B.B.J.* a letter by Mr. McClure, County Councillor for Lancashire, was inserted therein, the writer pointing out that possibly the funds in question might be withdrawn in the future. The Chancellor of the Exchequer received the money from the beer and spirit duties, and it was quite possible that a time might arrive when such funds could not be raised. Mr. McClure said:—'It must be borne in mind that the present and future Chancellors of Exchequer are not bound to provide these funds in the future; consequently whatever move is made towards giving technical education in bee-keeping should be done in such a way that the work could be continued even though the county grants were withdrawn.' With regard to that, however, he (the Chairman) perhaps could set the minds of bee-keepers at rest. A question was asked in the House of Commons by the Marquis of Hartington on this subject, when Mr. Goschen replied as follows:—'If County Councils set themselves heartily to work to utilise the grants for important educational purposes, it will probably be difficult for any minister to persuade Parliament to divert them.' In addition to that Lord Hartington spoke encouraging words at a meeting of the National Association for the Promotion of Technical and Secondary Education, when he said:—

'Perhaps I may be allowed to supplement the answer of the Chancellor of the Exchequer by a consideration which I think of an important character. It is desirable to remember the source from which these grants come. They proceed from an additional tax placed upon spirits and beer. It is quite possible that a state of things might arise

under which these articles would not bear the additional duty, and it would then become a question whether the grant should not be made up from some other source arising from the general taxation of the country. If the grant had been placed to the reduction of rates alone, the question would arise whether Parliament would consider itself justified in imposing a new taxation upon the community to reduce the burden upon the ratepayers. It is impossible to say what answer Parliament might make to such a question; but if this grant should be applied to the establishment of important educational work, which would be beneficial to the whole community, it becomes almost morally certain that it would be incumbent upon any Government that might be in power at the time not to deprive the local authorities of the grant. We are, therefore, justified in suggesting to local authorities that it would be a short-sighted economy to apply the grant solely to the reduction of the local taxation. The best way of securing the fund will be to see that it is used for the purpose for which it was originally granted, by stimulating existing institutions in the work which they are now doing, by adding a scientific and practical side to schools, and providing new schools where such do not now exist.

That was very satisfactory, and seemed to indicate that if schools should be established no Government would be prepared to throw them overboard. The matter came before the House of Commons on Monday night last, when a question was asked by Mr. Fowler as to how many counties and county boroughs had decided to apply the money at their disposal to technical education, to which Sir William Hart-Dyke, in answer, said:—

‘From the replies received to the circular of the Science and Art Department, sent out in March last, it appeared that out of the fifty county councils and sixty county boroughs who had replied, sixteen of the former and twenty-five of the latter had decided to apply the whole share of the residue to the purpose of technical education. Nine county councils and two county boroughs had made a grant of nearly, or to within a small proportion of, the whole amount to the same purpose. Twelve county councils and seven county boroughs had the matter under consideration, and in many cases their committees had already recommended the allocation of the whole, or a great part, to the same purpose.’

Mr. Fowler then asked further, whether, in view of the fact that a great number of the authorities, following the sad example of the Council of London, had resolved to devote the grant to purposes other than technical instruction, the Government would take steps to make such an application of the grant compulsory; upon which Sir William replied that such a suggestion might be worth consideration. All these circumstances combine to show that there is little fear of any diversion of the funds from the channel contemplated by Parliament, or of their withdrawal. In reply to a question addressed by Mr. Morgan the night before, Sir W. Hart-Dyke said that, so far as he was aware, only two counties—London and Middlesex—and only one county borough—Wolver-

hampton—had applied the whole of their quota of the contribution made from the beer and spirit duties to technical education towards the reduction of local rates. He (the Chairman) was very sorry for the counties of London and Middlesex, which were likely to be shut out from the benefits which should accrue to technical education for an indefinite period. It was very difficult for bee-keepers to know what course should be taken until they had examined for a little while the action of other countries. A good deal, perhaps, had been done by agricultural societies and others in the way of technical instruction, especially with migratory dairies, as the report of the Lancashire County Council before him bore witness to; but he thought they must go to Switzerland for examples in respect to bee-keeping, there being nothing of the sort here. The Government of the canton of Vaud had established schools where a complete course of agriculture was taught, one of the studies taken up being apiculture. The whole subject was gone into from beginning to end at the Institute at Lausanne, which had a museum, where all necessary appliances were to be found, so that the lecturer who attended could give a demonstration as well as lecture. The courses of lectures were all free, the lecturer being paid by the government of the canton. [Mr. Cowan here exhibited a syllabus and time-table of the winter course.] Besides, a number of free lectures were delivered every spring in different parts of the canton. The lectures lasted six days, and at one of these courses at Nyon there were as many as fifty pupils for part of the time. The morning was devoted to theoretical work, and every afternoon to practical work in an apiary on the spot. In other instances, if there was no apiary near at hand, an arrangement was made with the owner of one in the vicinity. Another programme of a course of lectures and instruction, which he produced, was carried out at Cernier, in the canton of Neuchâtel, where a series of lectures were delivered on bee-keeping, the practical application, and theory combined with practice. That course was also an agricultural one, and lasted several weeks. In German Switzerland there was a very complete system in existence. They had not only elementary technical education in bee-keeping, but an advanced course for the instruction of teachers. The course this year lasted from four to six days, theoretical work being done in the morning and practical work in the afternoon. In that instance students had the advantage of being on the spot where there was a very large apiary of some 300 hives, owned by a gentleman who always placed it at the disposal of the professors. Pupils came from all parts of German-speaking Switzerland, bearing their own expenses of travelling and lodging. Instruction was entirely free, the cost being defrayed by subsidies from the Government and the agricultural societies. Those facts would give an idea of what was being done in Switzerland, which he took as an example, simply from

his being more intimately connected with that country, there being many other such schools in different cantons, and (replying to a question interjected by Mr. Harris) practically the same might be said of Bavaria, and also in all Germany. The question now was, what should be done in England? Of course, every county must determine for itself what form the scheme for technical education should take within its own particular limits. He had a report before him of the Essex Association, which was one of the first which made an application for a grant. They asked for 335*l.* for the following purposes:—

'1. Advice and practical assistance to be given to bee-keepers at their own homes, in whatever part of the county they reside, by competent expert or experts, twice yearly, without other charge than a nominal payment of 1*s.*, 2*s.* 6*d.*, or 5*s.* per annum, according to status. *Grant asked for—50*l.**

'2. Lectures, descriptive of the advantages of bee-keeping as an industry, and the most profitable treatment of bees. These lectures to be delivered in the bee-tent belonging to the Association, and to be illustrated by demonstrations with live bees and the exhibition of appliances. No charge to be made for entrance. The lectures to be delivered during the summer months in every town and village in the county where arrangements can be made to hold them in connexion with local horticultural and cottage garden shows and village gatherings. These lectures can be given now only when their cost is defrayed by those wishing to have instruction of this kind given in their neighbourhood, and as a consequence very few districts are visited. The cost varies, depending upon the distance tent and bees have to be carried. It averages about 5*l.* *Grant asked for—150*l.**

'3. Winter lectures to be given by the appointed lecturer of the Association, or some other competent bee-keeper, in towns and villages where it is desired to create or foster a knowledge of bee-keeping. The lectures are illustrated by lantern views specially prepared for the purpose, and are found an excellent means of giving first instruction. The Association wishes to send lecturers into every district where they think technical education in the subject of which they treat is required, and to give the same free of all charge. At present very little is done under this head, as, with few exceptions, those desiring the lectures have to pay the cost. *Grant asked for—100*l.**

'4. For distribution of literature. *Grant asked for—10*l.**

'5. Awards for excellence. *Grant asked for—25*l.**

It should be noted that the Herts County Council were giving 300*l.* for a travelling dairy to the Herts Agricultural Society. Now, that was clearly something similar to what would be required for practical instruction in bee-keeping. But he would venture to suggest two ways by which the object could be accomplished, either of which could be adopted by itself, or the two could be combined. First, by introducing technical instruction in bee-keeping in connexion with existing agricultural technical schools, or such schools as are about to be formed, and by asking for a grant in aid of

such teaching. By this means the instruction would be under the supervision of proper educational authorities, and would be carried out at comparatively small cost. Of course, where such classes were formed, whether in the day or evening, it would be necessary to find suitable instructors, and a set of appliances used in apiculture. All the theoretical, and to a certain extent the practical, work could be done at the schools, whilst an arrangement could be made with some owner of an apiary in the neighbourhood to have practical demonstrations on the spot. In this way useful work could be done.

A second plan is for several counties to group themselves together and start a technical school on their own account, and for instruction in bee-keeping only. Such schools should be migratory, so that the instruction can be carried to the very doors of the people. A competent instructor, who can combine both theory and practice, should be secured at a fixed salary. He should be provided with appliances that could be easily packed for travelling, diagrams, and all that he may be likely to require for his course.

It would be advisable to have the course of instruction in a schoolroom, and the course ought to last from six to ten days. If possible two courses should be given during the year, an elementary course and an advanced course. Pupils should be encouraged to take notes at lectures and make sketches, and at the close of each course an examination should be held and prizes awarded. This would stimulate the pupils to take a greater interest in the subject.

To start such a school and to thoroughly equip it would require an expenditure of at least 50*l.*, and an annual expenditure of 200*l.* to 250*l.* This would provide salary of the instructor, say 100*l.* to 150*l.*, and 100*l.* for travelling expenses, cost of moving apparatus from place to place, rent of rooms, and prizes.

Whether the pupils should pay fees was a debatable point. The dairy schools generally demanded 5*s.* per week, or one guinea for the whole course; the Bath and West of England Society charged one guinea for the whole course, or 1*s.* for one week; the Kilmarnock schools 10*s.* the first week, and 5*s.* per week afterwards. At Kilmarnock the remuneration to the principal instructor was 400*l.*, to the assistant, 60*l.*, and to the butter instructress 52*l.* per annum. The Bath and West of England Society paid the instructor 70*l.* a-year and the cost of board and lodging during the time of teaching, equal to about another 70*l.* In Lancashire it is proposed to have the instruction free, those who like to pay fees being permitted to do so; but the education committee proposed to go further than that, and in necessitous cases to pay the travelling expenses, and even board during the period of instruction. (Laughter.) The authorities in that county have just engaged with Dr. H. G. Webb to deliver a course of forty lectures, and with Miss Maidment to give a course of lectures on dairy processes, and conduct migratory butter-making schools in dif-

ferent parts of the county. It has been suggested that a sum of 500*l.* may be granted for the assistance of dairy work in the county, and as that is a recommendation of the Technical Education Committee, the request will doubtless be granted. The scheme proposed by himself was merely to afford food for discussion. His idea of combining counties was that it would be easier to work two or three counties with a moderately large sum than each county separately with a trifling amount. He did not know what success was likely to attend the Essex application, but 335*l.* was an amount that some County Councils would not, he felt sure, think of granting. About 300*l.* a-year between six counties might very reasonably be expected, and much good work could be done with it. Each county might ask for 50*l.* with a good prospect of getting it, whilst a request for 200*l.* or 300*l.* would most likely be fruitless. In conclusion, he invited the opinions and suggestions of all present.

(Report of the discussion and the proceedings which followed will appear in our next.)

BRITISH BEE-KEEPERS' ASSOCIATION.

Committee meeting held at 105 Jermyn Street on Wednesday, May 6th. Present—T. W. Cowan (in the chair), the Hon. and Rev. H. Bligh, Rev. T. F. Scott, Captain Campbell, W. H. Harris, and J. Garratt, together with J. M. Hooker, Rev. W. E. Burkitt, W. B. Carr, and Dr. Rayner (ex-officio).

Communications were read from the Rev. Dr. Bartrum (who had previously attended a sub-committee meeting), Mr. McClure, Mr. Jonas, Rev. R. Errington, and the Treasurer, regretting their inability to be present.

It was resolved 'that endeavours be made to hold a third-class examination at the Bath Exhibition.' The Committee discussed and resolved upon a number of matters connected with the Bath and Doncaster Exhibitions. At five o'clock a conference was held with representatives of County Associations and others interested in the matter to consider the best means of promoting the action of County Associations in endeavouring to obtain a grant from County Councils for education in bee-keeping. The proceedings are reported on page 225. Subsequently a Committee was formed, consisting of the Chairman (Mr. Cowan), Messrs. Carr, Garratt, and Harris, with full power to take prompt action in the matter.

BATH SHOW.

Appliance dealers should note the fact that entries for the above Show close on the 23rd inst. The present favourable weather will no doubt give a considerable impetus to bee-keeping, and dealers, especially those located in the adjoining counties, will have a favourable business opportunity, as the Show takes place just at a period of the year when sales are brisk.

BEE RAMBLES IN SAVOY.

(Concluded from page 220.)

M. Rullier now accompanied us on our journey, and we stopped at Bon Conseil, a small hamlet just beyond Bellentre, to see M. Tressalet, who is the Maire of Bellentre. This old gentleman, we found, was very fond of his bees, and soon showed us that he was quite up to all that had been written about them, and knew thoroughly the books written by all three of us. He had a bee-house containing fourteen hives, amongst which there were four Burki, one Blatt, one Langstroth, and four of the Berlepsch pattern. The hives were painted on the outside and decorated in front with fantastic figures. Here we could not resist taking a photograph, with M. de Layens by the side of the bee-house. M. Tressalet accompanied us in the carriage to Bourg St. Maurice. Here we got a sight just above us of the glaciers and untrodden snows of Mont Pourri. As we ascend the valley the pass of the Petit St. Bernard comes in sight, and the valley expands into a sort of basin surrounded by mountains on all sides, with Bourg St. Maurice in the centre.

We drove right into the town, to the Hôtel des Voyageurs, where, to our surprise, we were welcomed by a number of bee-keepers who had come to meet us. Without our knowing it M. Rullier had telegraphed to the bee-keepers in the neighbourhood who were members of the Bee Association to come there to meet us, and many of them had come long distances, M. Emprun, the Vice-President, coming down no less than eighteen kilometres from Villaroger. Before we got introduced all round it was amusing to hear some of the remarks made and the questions asked; but when they found we could speak their language their reserve soon vanished, and we were before long absorbed in bee-talk. They related their feelings when the telegrams were received, Hilaire Arpin saying that he could hardly believe his eyes when he read the telegram, and saw that we three were coming together. M. Emprun said with considerably dry humour that he knew Mr. Cowan had been to Italy, Germany, America, and to many other places besides, and he was sure he would not forget them up in the secluded parts of the Savoy mountains.

They brought several specimens of honey with them for us to taste, and these we had with our dessert. Some of the honey had a delicious flavour and fine grain, and one frame of comb was brought from Val d'Isère, from a height of 1849 metres. M. Emprun said the flavour of honey in the same district frequently varied. When it was wet the flowers had not the same perfume as when it was fine, and he found that it required great heat to bring out the aroma of honey. After dinner a short excursion was made to the apiary of M. Hilaire Arpin, situated about half-an-hour's walk up the mountain. He had two bee-houses, one of which we have illustrated, with the group of bee-keepers forming the company.

The one on the extreme right is M. Emprun, and next to him M. Hilaire Arpin, the owner of the apiary. The old gentleman sitting down without a hat is M. Tressalet, with M. Rullier just behind him, while on his right is M. Alphonse Rullier from La Thuille, about an hour's walk higher up the mountain, where he has thirty hives. Standing against the house is M. Bertrand, and on the opposite side M. de Layens, while between them is M. Brunet, a surveyor who lives at Grenier above Aime, where he has twenty hives. M. Arpin has eighteen frame hives with supers, as seen in the illustration, and eight straw hives.

After looking into two or three hives the farthest one on the lower shelf was examined, as

and most of the bees went into this hive. He then took the hive to the new place and put in it two combs of brood which made a good swarm and they at once began queen-cells. The next day a few bees came back to the old place, but he put them back into the hive and this ended the matter. M. Emprun's hives are in the snow more than a metre deep, and he only placed a sloping board in front to prevent the entrance getting blocked; thus his hives are completely buried for several months in the year, and as the snow begins to melt he removes the board and allows the bees to fly out. He has twelve frame hives and thirteen straw, and gets a good return although he has a very short summer.

M. Tressalet, the Maire of Pellentre, said our

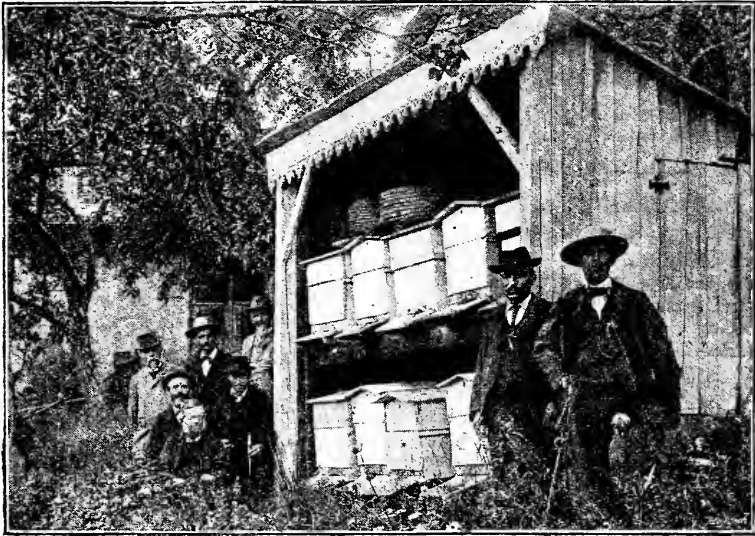

APIARY OF M. HILAIRE ARPIN.

M. Arpin thought it had foul brood. So it had in a mild form, and he was recommended to try naphthaline, as he was already using camphor. M. Alphonse Rullier said he also had foul brood, and had been using camphor with success. He said when he took away the camphor foul brood broke out again, but when it was put into the hives the disease diminished. He thought at any rate if it was not a complete cure for the disease it kept it in check, and he did not intend to do without camphor. The whole party descended to the town and looked at a few hives scattered about the place, and then adjourned to the summer-house in the hotel garden to partake of coffee, and stronger beverages for those that liked. Here the rest of the time was spent relating experiences and talking of the progress of bee-keeping in the district. M. Emprun, amongst other things, said that one day he had to move twelve hives only 200 metres from his place, so that a large number of bees came back. He then put in the place a hive with some combs,

visit would be a memorable one for them and would be entered in the archives of the Commune. It will also be a memorable one for us, for we shall never forget the hospitality of these Savoy mountaineers and the kindness shown to us. We were very much struck and impressed with the advance bee-keeping was making in that country, although this district was much later than others we had visited, and, owing to its altitude, it was not quite so good. We found all the bee-keepers we came across most intelligent, and they were doing their best to spread a knowledge of modern methods amongst their neighbours. There were already in this district 200 frame hives, besides 300 common ones. M. Brunet, whose apiary is already situated at an altitude of 1200 metres, carries his hives, when the harvest is ended in his neighbourhood, several hundred metres higher up: and in this way he gets a second harvest, or rather a continuation, for the flora is similar, although later. Moun-

tains and valleys surrounded the inhabitants; thus the honey season lasts from spring to autumn, vegetation being constantly luxuriant within a small area and at different altitudes, according to the time of year.

At last the time arrived, after a friendly meal, to take leave, we retiring to rest and the others dispersing to their various homes. Although we saw no more of our bee-friends, we carried away a pleasant recollection of the hospitality of these members of the Petit St. Bernard Bee Society, and will often think of them amongst their wild and lovely pastures and passes.

Next day M. Rullier accompanied us part of the way on our journey, and told us much about the bee-keeping in the neighbourhood of the places we passed. We descended much more rapidly than we came up, and reached Albertville in time to catch the train for Aix-les-Bains, where we intended to break the return journey. It was very curious that, although the weather had been unsettled for some time before we started on our excursion, it cleared up the day before we left Switzerland, and all the time we were away the weather was superb. We had not been prevented by rain from carrying out all that we had planned; but now, as though to make up for it, no sooner had we entered the railway carriage than large drops of rain began coming down, and these were only the precursors of a tremendous storm that burst over us before we had got very far. There was a regular downpour of rain, and we were very glad when we reached Aix and got into the hotel. Next day we left early, and here parted with M. de Layens, who was going on to Lyons; and before he left we came to the unanimous conclusion that we had spent a very pleasant and profitable time together, and hoped that at some future period we three might again make a similar excursion. We had visited nineteen apiaries and examined several hundred hives, and during the whole of that time only one of our party had got stung, which will give some idea of how busy the bees were at work. Our trip was now at an end, and, after a rather tedious railway journey, dropping M. Bertrand at Nyon, we reached Lausanne in the afternoon, much improved in health by reason of our 'Bee Rambles in Savoy.'

Correspondence.

Communications relating to the literary department, reports of Associations, Shows, Meetings, Echoes, Queries, Books for Review, &c., must be addressed only to 'The Editors of the "British Bee Journal," 17 King William Street, Strand, London, W.C.'

BEES FIGHTING.

[641.] I herewith enclose some bees which were killed under very extraordinary circumstances, as the following facts will show:—Saturday, the 25th April, being a bright day, I exposed outside some surplus frames removed

from stocks which had been shifted into fresh hives (a thing I seldom or never do and highly disapprove of). I uncapped what honey remained in them (mostly heather), and the bees cleaned it out fairly well, though, as heather honey is very thick, they were somewhat slow about it.

I kept a close watch on them during the whole time, to see that no fighting took place on the combs as they were being emptied; but all went on right, and I removed them when empty.

Now here comes the curious part. About 5:30 in the afternoon I observed a few dead bees in front of my best stock, but thought little of it. By this time the bees in the other hives were singing their evening song and all quiet. I returned in about an hour and found a good number of dead bees about the same stock. I brushed these away, but I still surmised all was not right, for, on returning before going to rest, I found a fierce battle raging and scores of dead bees scattered around the entrance. On going in the morning to note the state of affairs I was disgusted to find my best stock a mere wreck! There is not the slightest doubt that these bees fought among themselves, for the other hives were perfectly quiet when the strife began and equally so in the morning. The sample of bees enclosed were just swept from the flight-board into the box, and if they can throw any light on the affair I will be glad. I have kept bees some sixteen years, and I never saw them fight among themselves in that manner, and most sincerely hope will never again.

The same stock (as were all the others) is carrying in pea-flower, is also busy on the gooseberries, which are now in bloom with us. I can't say I noticed the bees struggling or fighting with each other, but they came rolling out at the entrance in great numbers. I gave them a puff from the smoker and some warm syrup before leaving them for the night, but all to no purpose. The hive had not been disturbed for seven days, nor the stock next it, *i.e.*, both these stocks were put into clean hives the previous Saturday, and have been working steadily since. It also has brood in all stages.

I shall be glad to have your opinion on the case, and will be also very pleased to furnish you with further particulars, if needed.—*AUGUSTUS, Renfrewshire, April 27th.*

[We cannot think the bees have fought among themselves, as suggested. Examine the combs and note if there is so serious a diminution in numbers as to warrant the statement that the stock is 'a mere wreck!' If it is, we shall, under the circumstances, be very much surprised indeed. The dead bees sent offer no explanation whatever of the affair, though we cannot help suspecting they belong to some other hive.—EDS.]

BEE-KEEPING IN IRELAND.

VASELINE IN BEEHIVES.

[642.] Seeing in the *Bee Journal* of April 23rd reference to the use of vaseline, I thought you might like to hear of the experience of

those who have used it. From something I read in the *Journal* last year, I used it freely the greater part of last season, and would strongly advise its use. I found frames, supers, &c., treated with it could be moved with little or no disturbance. Using divisible supers, I found I could put on one crate under another almost unknown to the bees until it was on. I found the sections when taking them off finished, nearly as clean as when put on, and easily taken out of the supers.

I also tried Mr. Abbott's suggestion, with three or four hives, of putting the second crate over the first, though the bees took to the second freely, and did quite as well as in the others, still I would not like to try it again, as, not having used vaseline then, the crates being on from May to late in September, I could scarcely get them off the hives, the disturbance was so great. The sections were very much discoloured, and much too thickly sealed, and there seemed to have been relays of brood hatched in most of the sections; also it was nearly impossible to get them out of the boxes without breaking them.

I had a fairly good season last year. I commenced with twelve frame hives. I sold 394 sections, for which I got 15*l.* 1*s.* 1*½d.*, less commission, and had nearly 100 not quite finished; besides, three of the twelve swarmed twice, and I did not get ten sections from them; two were, from robbing, not as strong as the others, and only gave between twenty and thirty each; the other seven supplied the rest. I am just commencing this season with twenty hives, only losing one from having moved it too late, when the frost had gone.—T. KIRWAN, *Dunmore, co. Galway.*

WINTERING BEES IN CELLARS.

[643.] By some means my *British Bee Journal* for February 19th was belated. In it Mr. Woodley refers to an item in the *American Bee Journal* in which Mr. Pearce reports his bees as not losing weight for a month. Mr. Woodley says this was after the bees were put in the cellar, and I do not much wonder at his so understanding it, as the item was somewhat mixed; but if he will look again he will see that it is not so stated. The weighing was done 'the last of September,' and 'again in a month.' That, you see, would be very early cellaring. As a matter of fact they were not put in the cellar till about November 20th. So there was nothing so very strange about the matter, for they may have gathered from some source, even in the month of October.

By the way, the tendency seems to be towards lengthening the time of cellaring at both ends. I put a few colonies (twenty-seven) in the cellar October 28th and the rest ten days later, taking them out April 16th. That makes 160 and 170 days' confinement. I do not think one in twenty-five showed any signs of dysentery. Success to our English cousins.—C. C. MILLER, *Marengo, Ill., U.S.A., April 17th, 1891.*

NOTES BY THE WAY.

[644.] Since I wrote last week we have had a few days of bright, warm, spring weather, which has infused life into the apiary, and hope has been renewed in the breast of the bee-keeper. There is a grand promise of fruit I hear this season; the trees are white with bloom in our immediate district. We have only a few trees in each hamlet or village, but those are covered with bloom, as are also the wild cherry-trees in the woods.

Water for Bees.—I notice 'Lordswood' (637, p. 221) recommends sphagnum moss in water for bees to drink from. No doubt this is a good plan—the only difficulty is to get the moss. Many bee-keepers will not be able to get a supply, but every bee-keeper can get spent tea-leaves, and this I find, year after year, to be a good medium by which bees can drink without the possibility of their getting drowned. I have five drinking-places in my apiary, and although we have a roadside pond within a hundred yards of the apiary, it is rarely that any bees visit the pond for water. We always save the leaves as emptied from the teapot into a dish, and when this is put out at the back, it is covered with bees, although on the cold, shady side of the house. This proves that bees, like many of the *genus homo*, are fond of a decoction of tea. I feel sure that these drinking-places near the apiary are the means of saving a great amount of bee-life in the early part of the season.

There appear to be large numbers of queen-wasps about this spring. I looked through a neighbour's apiary a few evenings since, and killed seven fine queens that had located themselves among the wraps for the night, and in the roof of my own hives I have killed a great many, four or five per day, when feeding the bees, and still they come; therefore I advise a sharp look-out for them now one has the chance of catching them. In a week or two's time they will be starting nests in various holes and other suitable places, and our only chance of capturing them then will be when they are on the wing during the day.

I have been hoping to glean ideas on bee-escapes and super-cleaners from those who have used them in past seasons; surely some of our progressive bee-keepers have given them a trial. I have had some made, and shall be pleased to give my experience after I have tried them, but that cannot be till towards the end of coming honey season.

Supering Bees.—The past few warm days have given the bees a good start, setting their home in order, clearing out dried pollen, many pellets of which are strewed on or below the alighting-boards of strong colonies; but except in fruit districts, or where a goodly number of sycamore-trees are, or fields of turnip or swede-seed is grown, I should not advise putting on supers. To show how bee-keepers are easily influenced by two or three warm days, I may mention a gentleman called on me asking if I was open to buy his apiary. I said, 'Yes, if we

can agree in price; but I could not, owing to previous engagements, attend to the matter till late the following week. Accordingly I went on Friday, only to find that he had overhauled his apiary and put on his supers ready for the honey harvest next month, and did not want to sell unless at a high price. The weather had changed his ideas on bee-keeping, and he is looking forward to having several hundred sections of honey for sale, and then possibly he may sell out. I pointed out that unless the warm weather continued (which, alas! it has not) he would retard the development of his colonies by putting on supers so early.—W. WOODLEY, *World's End, Newbury.*

JOINING BEE ASSOCIATIONS.

[645.] Some time ago I noticed in the *B.B.J.* a report of the Ulster Bee-keepers' Association giving in detail the progress bee-keeping was making in the north of Ireland, and the good work the Association was rendering. Considering that in this district there is quite an army of beginners, like myself, I made application to become a member some months ago. Judge my surprise at receiving from the Assistant Secretary a letter informing me that my nomination had fallen through for lack of a seconder. Now, sirs, if all applicants are treated in a similar manner, I would like to know what good the Association can do to any except the chosen few? Personally, however, I may say my bee-keeping prospects are not the least daunted by remaining outside the Association, and when the proper time comes, perhaps not a few from this part will be able to compare results favourably with the more privileged, and testify that without any assistance we are not so far behind our neighbours in the matter of honey production.—JOHN D. McNALLY, *Laurencetown, co. Down.*

[If the Association you name reserves to itself the right of 'blackballing' persons seeking membership, you cannot complain of their exercising that right, though we must say the opposite course is usually adopted in most Associations we know of, the rule being to welcome bee-keepers desirous of joining.—EDS.]

WEATHER REPORTS.

BUCKNALL, LINCOLNSHIRE.

April, 1891.

Maximum, 66° on 30th. Rain:—1.08 inches.
 Minimum, 19° on 25th. Average, 5 years, 1.16.
 Mean max. 52.2° Heaviest fall, 0.30 on
 „ min. 33.0° 4th.
 „ temp. 42.6° Rain on 9 days.
 „ of 5 years. . 42.8° Frosty nights, 15.
 Range of temp. 19.2°

Remarks.—April has been about the average as far as absolute temperature, but the dry, cutting winds have made it seem very cold, and very much retarded brood-rearing.—J. BINT.

WESTBOURNE, SUSSEX.

April, 1891.

Maximum, 60° on 27th. Rain:—98 inch.
 Minimum, 25° on 1st. Heaviest fall, .48 on 4th.
 Minimum on grass, Rain on 9 days.
 20° on 1st. Average, 1.71 inch.
 Frosty nights, 5. Sunshine, 131.55.
 Mean max. 50.9° Brightest day, 2.3rd.
 „ min 35.5° Sunless days, 6.
 „ temp. 42.9°

Remarks.—A cold and dry, but dull, month. Bees doing little for the first fortnight, and very backward. Stores almost entirely consumed. Losses of bees in skeps about seventy per cent.—L. B. BIRKETT.

COMPARATIVE WEATHER REPORT OF FIRST QUARTER OF 1891 AND 1890.

BLAIR-ATHOL, PERTSHIRE.

(420 feet above sea level.)

January, 1891.

Maximum, 49.5° F. on 11th. Mean max., 40.0°.
 Minimum - 8.6° on 8th. „ min., 29.0°.
 Rain on 17 days, 2.05 inches.
 Bees flying on 11th, 12th, 13th, and 25th onwards.

February, 1891.

Maximum, 58.0° F. on 15th. Mean max., 42.8°
 Minimum - 18.0° on 26th. „ min., 27.8°.
 Rain on 6 days, 0.45 inch.
 Bees flying throughout the month with very few exceptions.

March, 1891.

Maximum, 56.2° F. on 1st. Mean max., 43.0°.
 Minimum - 10.0°, 9th and 13th. „ min., 26.6°.
 Rain on 14 days, 2.41 inches.

January, 1890.

Maximum, 54.0° F. on 31st. Mean max., 45.0°
 Minimum - 16.0° on 24th. „ min., 32.5°.
 Rain on 25 days, 6.94 inches; 100 per cent. above average.
 Bees flying on several days.

February, 1890.

Maximum, 54.5° F. on 24th. Mean max., 42.0°.
 Minimum - 15.8° on 15th. „ min., 27.5°.
 Rain on 9 days, 0.65 inches.
 Bees seldom out, but carrying pollen on 24th.

March, 1890.

Maximum, 54.5° F. on 31st. Mean max., 47.0°.
 Minimum - 13.5° on 3rd. „ min., 31.5°.
 Rain on 19 days, 2.57 inches.—A. C.

HONEY IMPORTS.

The total value of honey imported into the United Kingdom during the month of April, 1891, was 7334l.—From a return furnished by the Statistical Office, H.M. Customs.

Queries and Replies.

[352.] 1. How is it that, though we have so many orchards around, we rarely get surplus from the bloom? Do you think the following plan would succeed in bringing in a good honey crop this season? I have four skeps, and thought of dividing two and joining the bees as one lot in a frame hive on the old stand of the stronger stock, then putting the two skeps one above the other on the other stand for three weeks to hatch out brood; then removing top one and putting on sections, and the same treatment with the other two skeps. I like to have one or two straw skeps to look at, and the frame hives for the real work.—W. F. TRONSON, *Morehatch Bishop, North Devon, May 2nd.*

REPLY.—1. We see no reason why bees should not store surplus from the orchards of Devon if the weather be favourable for honey-gathering. 2. The fault of your proposed plan lies in your treatment of the two skeps after bees of both have been driven. The brood in them would surely be chilled to do as you propose. We should rather further strengthen two already strong stocks in frame hives by setting one of the skeps and brood over each, with queen-excluder between; removing the skeps in three weeks and replacing with sections instead.

[353.] *Mouldy Combs.*—What would you advise me to do so that I might freshen up over fifty bar-frames filled with comb, as they are slightly mouldy, having come from hives in which the bees died during the winter?—H. C. SCLATER, *Littlehampton.*

REPLY.—If the combs are sprayed with salicylic acid solution and dried, they will be all right.

Echoes from the Hives.

Oldbury, Bridgnorth, South Shropshire, May 6th, 1891.—The warm weather of the past few days has been a welcome change for the bees. Damson, plum, gooseberry, and currant bloom is exceptionally good this year, and bees are freely working these sources. Young bees (workers) in strong stocks are now daily hatching out by scores, but I have not yet noticed any drones. Bee-keepers and fruit-growers will do well to note that queen-wasps appear to be very numerous this season. I have this day destroyed half a dozen in my own garden.—J. E. RODEN.

Bishops Waltham, Hants, May 11th, 1891.—*Early Swarms.*—My three stocks have wintered well; one swarmed on the 7th of May, and one to-day, the 11th—both good strong swarms. I took all the top honey from them on bars and in sections last autumn, and have not had to feed them once.—J. IVES.

New Philadelphia, U.S.A., April 12th, 1891.—Our bees here are in splendid condition, and

blossoms just beginning to open. The prospect for a good crop of honey seems fully assured.—DR. G. L. TINKER.

Notices to Correspondents and Inquirers.

All queries forwarded will be attended to, and those only of personal interest will be answered in this column.

T. BONNER CHAMBERS.—An exactly similar implement, and used for the same purpose, *i.e.*, impressing the base of cells on wax, is described and illustrated on p. 69 of the late Mr. Alfred Neighbour's book, *The Apiary*, published in 1865.

AMICUS.—Messrs. Abbott's full address is given in their advertisement.

FRANK LIGHT.—Full instructions for hiving swarms are given in *B.J.* for May 15th, 1890. See reply to R. Puttock last week.

DOWNCAST (Lowestoft).—Sugar sent is not Porto Rico at all. The latter has a finer grain than sample.

* * *Report of proceedings of the B.B.K.A. occupies so much space this week, we are compelled to hold over several articles till our next.*

SWARMS! SWARMS! SWARMS!

TENTH SEASON.

3 lb. SWARMS, 10s. 6d.; larger if desired at same rate. Boxes to be returned, or 1s. 3d. added to remittance.

Orders executed in rotation.

C. N. WHITE, Somersham, Hunts. 237

British Bee Journal and Bee-keepers' Record.

OFFICE:

17 KING WILLIAM STREET, STRAND, LONDON, W.C

PURE CANE SUGARS.

For the accommodation of Bee-keepers, guaranteed Pure Cane Sugar will be supplied in large or small quantities through this office at the under-mentioned rates:—

CRYSTALLISED.

4. DEMERARA	} Neat bags, 14-lbs. 28-lbs. 56-lbs. Cwts.			
5. BARBADOS		Crystals 2/9	5/4	10/6
6. TRINIDAD				

REFINED CANE.

7. WHITE CRYSTALS (Small)	5/0	11/6	22/6	
8, 9. (Medium and Large sizes, 1/- per Cwt. extra.)				
10. LUMP (Cut Loaf) ... Boxes,	3/3	6/3	12/3	23/6
11. LUMP DUST ...	3/0	6/0	11/9	22/9

All above guaranteed made from CANE SUGAR only, and free from BEET, CHEMICALS, etc., etc.

CARRIAGE PAID on Orders over 5/0 (or 28-lbs. Sugar) to London and Suburbs.

COUNTRY ORDERS, not less than 2-cwt. carriage paid at 1/0 per cwt. extra.

(Scotch and Irish orders, special arrangements.)

Cash to be sent with order, and purchasers will please observe that if samples are required or replies asked to inquiries, a stamped addressed envelope must be sent, as we cannot undertake cost of postage.

British Bee Journal,

BEE-KEEPERS' RECORD AND ADVISER.

No. 465. Vol. XIX. N. S. 73.]

MAY 21, 1891.

[*Published Weekly*]

Editorial, Notices, &c.

USEFUL HINTS.

WEATHER.—Yet another 'experience,' such as surely none but dwellers in Britain ever go through. After calculating on a week or two, at least, of settled weather,—in fact, after enjoying several successive days of real summer warmth—a change for the worse occurred on the 15th, simply marvellous in its completeness. Reports from various parts of the country show that the astonishing and unlooked-for disturbance in the weather conditions on that day extended over the whole of the kingdom, some parts of course feeling it in increased severity, but everywhere strong winds and squalls of hail and snow have been more or less severely felt. In London the temperature did not exceed 47° all day, which, with the exception of one day in May, '69, and May 18th, '72, is the lowest day temperature during the latter half of May for over forty years. Few counties escaped damage to fruit-bloom through the fierce hailstorms which poured down on the tender leaves and bloom with such tremendous force. Incredible though it seems, ice an inch thick is reported on ponds in north-east Lancashire on the morning of the 17th. It is fortunate that many varieties of fruit are so late in blooming this year as to escape serious damage, but a considerable amount of mischief has no doubt been done in some parts. Here in Kent, however, the storm was less furious than elsewhere, while the copious rains must have done an incalculable amount of good everywhere, and it would appear as if the worst had come and gone, for to-day (19th) the weather is bright and warm, so we may now hope for that most delightful of all spring conditions when vegetation seems to make such progress in the moist, warm soil that we can almost see it grow.

SWARMING.—Bee-keepers have already had a taste of what to expect if hot weather comes, for we note that swarming was quite common a week ago. It will be well, therefore, for those who have newly-hived swarms on hand, to remember how necessary feeding is while cold weather lasts. Artificial swarming is less often practiced among beginners than was the rule a year or two ago, and nothing is lost by the change, for many were the mishaps through undue haste in increasing stocks before safe conditions had been reached. In the hands of the ordinary amateur, natural swarming is in every way preferable when increase is desired, and if waiting for natural swarms is sometimes rather weary work, by reason of the persistency with which they refuse to 'come off,' it suffices to pass away the time until the arrival of swarming weather, when it is more safe to perform the operation of artificially swarming stocks. No bee-keeper should now allow a day to pass without preparing for swarms by fitting frames with foundation, and arranging a few hives for immediate use.

SUPERING.—The question has been lately asked, 'When am I to begin supering?' to which we replied, 'When the hives are fairly full of bees, and honey is coming in.' Then our querist retorts, 'But how am I to know when honey is coming in?' We have requested our correspondent to look in this week's 'Hints' for a reply; and yet we hardly know how to word it. An 'old hand' can make a very safe guess 'when honey is coming in,' but he cannot quite express in words what the outward and visible signs are.

Nor can he suggest to the beginner to examine the frames every day for ocular demonstration of the fact; and so we must ask our querist to content himself with the assurance that he will soon acquire the knack of knowing many things which are taking place within the hive if he carefully observes the ways of bees from the outside. We may say that the bees work as if they

meant *work* when honey is coming in. Moreover, the weather must be warm and plenty of bloom about. He can also, when giving supers, assist the bees by carefully covering supers in any way which will tend to keep them warm. We always insert folded paper with one edge pressed sharp, so that it may be passed in between the junction of hives and supers, to keep out the cold and make a 'tight joint' all round. Precautions of this kind will not seldom keep bees working in supers even during cold nights, when they would otherwise desert them for the warm brood chamber below.

Referring to the storm on the 15th, we had a personal experience, novel in more ways than one, for we found ourselves among the sheltering wayfarers who took refuge in the nearest doorways, gazing on a perfect storm of hail, snow, and rain, which came on us in a moment. Hailstones as large as horse-beans whitened the roadway, and formed quite a winter scene in a few minutes. A flash of lightning and a sharp thunder-clap, however, ended the downfall. Crossing the street we reached our destination, which happened to be the new premises of Messrs. Abbott Bros., in High Holborn. The firm occupy the whole building from floor to roof, the ground-floor being entirely devoted to bee-appliances of all kinds, while, on the upper floors are displayed a large stock of household decorative articles manufactured by the firm. Here we thought our inspection over, but Mr. Abbott producing a stout ladder observed, 'Oh, you mustn't leave without seeing *the Apiary!*' and, mounting the ladder, he pushed open a trap in the roof. We followed, and sure enough, on the flat, lead-covered roof of the building, were located a couple of stocks of bees *at work*. It seemed almost cruelty to animals to watch the plucky little fellows coming out of the clouds around us, as it were; where they found flowers to dive down to, and, more than all, how they succeeded in threading their way among the thousands of chimney-pots to that particular stack behind which their 'town residences' stood, seemed a marvel quite beyond anything bees in the country accomplish in the way of 'homing.' And when Mr. Abbott assured us they were carrying in pollen quite briskly the previous day, we recanted our former doubt as to the sincerity of the writer who records his belief that 'bees would gather if located in the dome of St. Paul's.'

BRITISH BEE-KEEPERS' ASSOCIATION.

DISCUSSION ON GRANTS FOR TECHNICAL EDUCATION IN BEE-KEEPING.

(Continued from page 229.)

Mr. Meggy said that of course the amount which each bee-keepers' association was likely to get from his county depended on the size of that county, and the amount at its disposal. In Essex there was 17,000*l.* available. The County Council felt there was great difficulty in reaching the rural population, and of instructing people in their own districts. They had decided first of all that the whole 17,000*l.* should be devoted to technical education, and that a certain grant should be made to the Agricultural College for the promotion of dairying and farriery. That, at present, was the only grant proposed. He did not doubt for a moment that a portion of the grant would be given to bee-keeping; but it was a question whether it would come through the County Bee Association, or the Agricultural Society, or through what was known as the Essex Field Club, which had a big scheme for teaching technical education. He (Mr. Meggy) was using his influence to obtain the funds for the local Association, which, he argued, was an organization already in existence for the teaching of that particular branch of technical education. He thought the feeling of the County Council in his district was that they did not want to fritter their money away in small doles, but preferred to give out a good sum for the furtherance of useful objects.

Captain Campbell said that a meeting had been held in Guildford to consider the county grants, the result of which was that 5000*l.* was to be asked for on behalf of the Science and Art Classes and King Edward's Grammar School. It had been decided to leave any application in favour of technical instruction in bee-culture to the British or Parent Association rather than ask for small sums.

The Chairman explained that the B.B.K.A. could not apply for any of the grants, but that the applications must come from the County Associations themselves.

Mr. Garratt thought the first step to be taken was to come to some sort of agreement as to how, in the event of funds being granted, they were to be applied. It was necessary to be provided with some reasonable scheme, which should be so framed as to commend itself to the County Council. Another point was, how should application be made? Should there be a kind of concerted action, or should each Association apply in its own way? The Council of his Association (Kent) had considered the matter, and drafted an application which embodied the plan they thought most suitable for the appropriation of any money that might be obtained. After reading the application made by his Association, he suggested the appointment of a small Sub-Committee to draft the application form to be recommended by the B.B.K.A.

Mr. Harris said that Captain Campbell's remarks plainly intimated that the local Association at Guildford was looking to the B.B.K.A. for advice and assistance in the matter of these grants; and he thought the parent body would do wisely to draw up a scheme which should be sent to the various county associations suggesting the form their applications to the County Council should take. It was most desirable to incorporate therein arguments something like the following in support thereof:—(1) That apiculture was distinctly recognised as an object for State help on the Continent, in several countries where bee-keeping had attained success. (2) It was well fitted to be encouraged as one of our minor rural economies, not solely because it could be conducted with financial success, but because it gave the poor man something to think about and employ his leisure hours, and was likely to morally elevate him. (3) That it was a most important factor in fruit-growing. (4) That it was of greater importance still in relation to seed-growing. He also considered it advisable to formulate suggestions with regard to the line which should be taken in respect of the proposed lectures; a syllabus might be drawn up as a guide, which would be of practical help. In regard to the Chairman's recommendation that several counties should unite any grants they might obtain, he thought it would be difficult for them to make suitable arrangements during the bee-season for the whole of the counties to be properly visited and practical instruction given throughout their entire area. He hoped Mr. Garratt's suggestion of a Sub-Committee would be adopted.

Mr. Carr thought that the programme carried out on the Continent was an excellent example to be followed in this country. He considered that Associations could not do better than adopt the system successfully carried out abroad as a basis upon which to frame their applications to County Councils. If Government recognition had been obtained there, why should not the same be achieved here? In supporting the proposal for a Sub-Committee, he thought the most practical way of using the grant would be by appointing travelling lecturers, who would have little difficulty in obtaining the use of apiaries when necessary for practical instruction.

Mr. Garratt doubted whether the Swiss system could be adopted entirely with advantage in this country. He feared that the school and the professor at its head would always lack students. He had some experience in those matters, having done his best to popularise bee-keeping in his own county, but found it impossible to overcome the apathy thereon. He believed it would be best to adopt the plan of the dairy schools, which were to be migratory and travel about where there was a disposition to appreciate the services rendered.

Mr. Carr thought Mr. Garratt's view too desponding. If the instruction were entirely free and adapted to young people he hoped for better

results. Most people were disposed to accept 'something for nothing.'

A long discussion ensued as to the best way of approaching the County Councils, the Chairman, Messrs. Hooker, Garratt, Carr, Harris, and Davenport taking part therein.

Mr. Hooker and the Rev. Mr. Davenport did not think it necessary that the applications should enter into minute details, which were matters for after-consideration should the grants be forthcoming, a general outline of the proposed disposal of the grants being sufficient. Ultimately, on the motion of Mr. Garratt, seconded by Mr. Harris, it was unanimously agreed, 'That a Sub-Committee be appointed to draw up in outline a general form of application to County Councils for grants towards technical instruction in bee-keeping.' It was also unanimously agreed that the Sub-Committee consist of the Chairman, Mr. Garratt, Mr. Harris, and Mr. Carr.

It was deemed advisable that not a moment should be lost by the Sub-Committee in getting on with the business, especially as some counties had already begun to apportion the grants, and the Bucks and Nottingham Associations were waiting advice. The Sub-Committee therefore arranged to meet the next day.

A vote of thanks to the Chairman concluded the proceedings.

BEE-KEEPERS' ASSOCIATIONS AND COUNTY COUNCIL GRANTS FOR TECHNICAL EDUCATION.

The B. B. K. A. having been asked in several instances to advise County Bee-Associations with regard to obtaining grants from the funds now at the disposal of County Councils for technical education purposes, it has been considered advisable to call the attention of all the County Bee-keepers' Associations to the following points:—

Firstly.—That considerable sums have been allotted by Parliament to County Councils, which may be devoted in whole or in part to—(a) the reduction of rates, or (b) the promotion of technical education.

Secondly.—That, as far as is yet known, in only two cases has the former of the purposes been adopted, while in the large majority of instances the second object only has been recognised.

Thirdly.—That, in the rural counties, agricultural subjects will be chiefly those for which grants in aid of practical instruction will be given, and that bee-keeping is distinctly acknowledged as being included in such agricultural subjects.

Fourthly.—That, in making application to County Councils for money grants for teaching apiculture, the following points should be specially set forth:—(a) Apiculture has long been admitted among continental nations as a subject of technical education; (b) it is recognised by our own Education Department as a subject for teaching and examination in elementary schools; (c) the leading Agricultural Societies in Britain give bee-keeping a definite place in technical

education in agriculture; (d) as one of the minor rural economies, bee-keeping may, and should assume an importance equal at least to poultry-raising; (e) in view of a probable large increase in fruit-growing, the extension of apiculture has a most valuable practical bearing, while its relation to successful seed-growing (e.g., mustard, turnip, rape, and white clover) is equally certain and important.

Fifthly.—That much will depend on setting forth with distinctness the uses to be made of any funds which may be granted to bee associations. Among these uses may specially be noted the payment of teachers and experts for—(a) The delivery of courses of lectures, elementary and advanced, in different suitable localities, and with or without fees, according to circumstances (For such lectures diagrams and apparatus would have to be provided.); (b) the manipulation and management of bees in skeps and in bar-frame hives; (c) the systematic inspection of apiaries, and giving advice in cases of bee-diseases, deficient stores, and difficulties in bee-keeping in general.

Sixthly.—Most of the requisite machinery for promoting the extension of apiculture already exists in County Bee-keepers' Associations.

We append a form of application to County Councils, which secretaries of County Bee-keepers' Associations may find suggestive and helpful. It will probably need supplementing, or otherwise modifying, for special localities.—
T. W. COWAN, *Chairman B.B.K.A.*

[Suggested Form of Application.]

TO THE COUNTY COUNCIL.

Re Grants of Money for the Promotion of Technical Education.

On behalf of the Bee-keepers Association I beg to present an application for a portion of the fund allotted to technical education.

The Association has for its chief objects the development of bee-keeping as one of the minor, but important, rural industries.

The following facts are worthy of careful consideration:—

(a) Apiculture has long been admitted among continental nations as a subject of technical education.

(b) It is recognised by our own Education Department as a subject for teaching and examination in elementary schools.

(c) The leading Agricultural Societies in Britain give bee-keeping a definite place in technical education in agriculture.

(d) As one of the minor rural economies, bee-keeping may, and should, assume an importance equal at least to poultry-raising.

(e) In view of a probable large increase in fruit-growing, the extension of apiculture has a most valuable practical bearing, while its relation to successful seed-growing (e.g., mustard, turnip,

rape, and white clover) is equally certain and important.

(f) English honey has greatly advanced in popular estimation, and is now much in demand.

Should the Bee-keepers' Association be so fortunate as to secure a grant from the County Council, the sum allotted will be chiefly devoted to the employment, with suitable equipment, of a *travelling lecturer*, who shall work systematically throughout the county. His principal duty will be to afford each eligible locality a full opportunity of becoming acquainted with the theory and practice of bee-management, just as dairy schools, in different counties, are imparting instruction in improved methods of making cheese and butter. I beg, therefore, respectfully to ask that the sum of £..... may be granted to the Bee-keepers' Association for the furtherance of the above-named portion of its educational work.

Hon. Sec. Bee-keepers' Association.

EXPERIMENTS IN APICULTURE.

We have received Bulletin No. 9 of the Rhode Island State Agricultural Experiment Station, which treats of experiments in apiculture conducted by Mr. Samuel Cushman. The pamphlet contains a report of trials of artificial heat for promoting brood-rearing, hives on scales, sources of honey, and Carniolan bees. There is also a chapter on foul brood. Two hives were prepared for heating. They had double walls and cork-dust between. Before artificial heat was applied on May 14th the readings of the thermometer in the corner of the hives was—

Time.	First hive.	Second hive.
10 o'clock	73°	74°
12 "	78°	76°
2 "	81°	76°
4 "	82°	76°

The difference in the heat received from the sun accounts for the change in the temperature the first hive receiving much less early in the morning, the second receiving none after noon.

That night four stone bottles, each holding a half-pint, were filled with boiling water, and placed behind the division-board of first hive. This was renewed each morning and evening until June 20th, while a record was kept of the thermometer readings for the remainder of the month. The next morning, before the water was removed, the thermometer stood in No. 1 at 68° and No. 2 at 65°. The thermometer among the bees showed a temperature morning and night of 86° in No. 1, and in No. 2 it stood at 84° and 87°.

The record for the rest of the month showed that where the heat was used the average temperature of the cluster at night and in the morning was no higher, and that when there was any difference between the two the temperature of the cluster where the heat had been given was lower. This was as might be ex-

pected, as it is well known that the cluster expands as the surrounding temperature rises, therefore it would go no higher. The records also show that where the hot water had been given the temperature of the hive outside the cluster was many degrees higher. The weather was cold and changeable, and the artificial heat was found of the greatest value during the nights, or chilly, sunless days, and better enabled the bees to cover the brood. On May 31st, just before the thermometer was removed for the season, No. 1 indicated 94° in the cluster and 73½° out, No. 2 showed 94° and 71°. No. 1 gained brood and bees steadily till artificial heat was discontinued on June 20th. No. 1 overflowed the brood nest long before No. 2 had used all the combs, and by July 1st occupied two brood chambers and was about twice as strong. On July 18th, No. 1 gave thirty-five pounds extracted honey and No. 2 fifteen pounds.

Owing to the arrangement being rather crude the record of the temperature in the cluster is of no value except to compare the two hives, but the simplicity of the arrangements makes it more practicable for apiarists to follow the same plan, and with any number of hives. The stone bottles were wrapped in bagging, so that the heat was given off slowly, and when room was wanted in the body of the hive for frames, the bottles were placed on the top of the frames. The result, Mr. Cushman thinks, promises well, and he hopes that the plan will be tried. This plan is similar to that recommended some years ago in the *B.B.J.* by Mr. Abbott.

The hives on scales showed that the flow of honey lasted from June 15th to July 10th. A second flow commenced on July 23rd and ended on August 3rd. The largest amount of nectar brought in on one day over the amount consumed was eight and a quarter pounds, the largest on two consecutive days was fifteen pounds, and the greatest gain on three days was nineteen and three-quarter pounds. The greatest loss was the day following the removal of the first lot of honey, consequent on the excitement, and the bees consumed three pounds more than they gathered. After the bloom of golden rod in September, and while the colony was still active, they took from half to two and a half pounds each day; but after October 1st, as they became less active and clustered more closely, the loss was less, and was shown to have been one-third to one pound only. After the 10th the scales showed loss each second or third day, while from 21st to 27th the loss was not enough to be shown by the scales used.

Mr. Cushman does not recommend Carniolan bees, but thinks that to produce the finest comb honey, common black bees, or black and Italian crossed, are the best.

BEE SHOWS TO COME.

June 3rd to 8th inclusive. Bath and West of England Agricultural Society at Bath. Entries close May 23rd. J. Huckle, Kings Langley.

Correspondence.

The Editors do not hold themselves responsible for the opinions expressed by correspondents. No notice will be taken of anonymous communications, and correspondents are requested to write on one side of the paper only, and give their real names and addresses, not necessarily for publication, but as a guarantee of good faith. Illustrations should be drawn on separate pieces of paper.

Communications relating to the literary department, reports of Associations, Shows, Meetings, Echoes, Queries, Books for Review, &c., must be addressed only to 'The Editors of the "British Bee Journal," 17 King William Street, Strand, London, W.C.' All business communications relating to Advertisements, &c., must be addressed to Mr. J. HUCKLE, Kings Langley, Herts (see 1st page of Advertisements.)

* * * In order to facilitate reference, Correspondents, when speaking of any letter or query previously inserted, will oblige by mentioning the number of the letter, as well as the page on which it appears.

WHEN DOCTORS AND PROFESSORS DIFFER!

A YOUNG QUEEN HATCHING IN A HIVE ABOVE QUEEN-EXCLUDER, PLACED ON THE OLD BROOD CHAMBER.

[646.] Dr. Tinker's book, p. 29, 'Preventing Increase,' the bottom lines read: 'If the bees have a good queen below the excluder, the young queen will be balled and killed.'

Doolittle's book, 23rd chapter, referred to by the German *Illustrated Bee Journal*, p. 375, 1889, which I translate: 'To raise two beautiful queens in a hive which has a laying queen without the least loss seems marvellous—was thought an impossibility. If you wish to raise two queens, do so . . . &c., &c.'

Exactly on the same plan and on the same lines as stated by Dr. Tinker, when the young queen is balled and killed.

Other large American bee-masters have tried and approved Doolittle's practice. I shall try it this summer.

Dr. Tinker's book reads much like Mr. Simmins' *Non-Swarming System*, or Mr. Munz's German books, which I followed years ago.—J. G. K., *Grove House, Southborough, Tunbridge Wells.*

[In making comparisons we think it more satisfactory to go straight to the authorities themselves, and not to the translations, for passages often suffer from translation and retranslation. It is so in this case, for we have carefully compared the passages our correspondent quotes in the *Bienenzeitung* and Doolittle's book, and find that in the former a free translation, or rather a summary, of Doolittle's plan is given. Now, comparing the plan advocated by Doolittle for rearing two queens above excluder zinc, and Dr. Tinker's plan for preventing increase, we find that these two plans differ in one very important point, but we are not prepared to say without further observation whether this makes all the difference in the results attained, or any difference at all. Doolittle raises his queens above the excluder zinc and bores a hole at the back of the upper chamber, to enable the queen to fly out for fecundation, so that she is not obliged to go through the main body of the hive at all. Dr. Tinker does not make a hole, so we must suppose that the young queen, when she makes the attempt to get through the main hive for the purpose of mating, is balled and killed.

In the one case the young queen does not intrude or trespass on the domain of the old queen, whereas in the other she does. Possibly our correspondent has overlooked the following passage which we translate from the *Illustrierte Bienenzeitung*: 'If the two queens of the honey chamber are to be fecundated, two flight-holes must also be provided for them.' This certainly implies the necessity for these holes, and that the absence of them would lead to non-success. Now, in Doolittle's book, on p. 96, he makes a great point of having these holes at the back, and not on the same side as the entrance, because in the latter case 'now and then a queen will go to the entrance upon returning from her wedding tour, and as the bees are all of the same family, this young queen will be allowed to go in and kill the one reigning below.' Here we would point out that Mr. Doolittle and Dr. Tinker are both agreed that one of the queens will be killed, but they do not agree as to which of the two succumbs. Dr. Tinker says the young queen is killed, and Mr. Doolittle asserts that the old queen is always killed. There is a discrepancy here which is of importance to the bee-keeper, and which should be settled by experiment. We should be glad to hear what these gentlemen, or any others who have had experience, have to say on the matter.—Eds.]

FOUL BROOD AND INFLUENZA.

[647.] On reading the subjoined letter, cut from the *Birmingham Daily Post* of yesterday's date, it struck me as possible that the same cause—i.e., the burning of rotten and decayed wood in our smokers—might be the origin of foul brood, and that if so sulphur, used, of course, in moderation, might also prove the cure for foul brood as for influenza. At any rate, I throw out the suggestion, and leave it to wiser heads than mine to decide the point.

It might, however, be as well for bee-keepers to eschew the use of rotting and decayed wood in their smokers until the question is decided one way or the other.—JAMES HUTCHINSON, *Cheltenham*.

'The present epidemic of influenza may be averted in its earlier stages by the following simple remedy, namely, by inhaling the fumes of burning sulphur. The incipient stage of the disease is a dry irritating feeling in the throat. The animalculæ by which the disease is propagated have lodged in the throat, and are living on the juices of it. When these are exhausted they go deeper, and the disease assumes a more virulent form. It is to the earlier stage that I would direct attention. Take a piece of ordinary roll sulphur, lay it on a fire-shovel on the floor of a close room, and touch it with the point of a hot poker to start it into flame. The person afflicted should be in the room, but some distance off the burning sulphur at first, as the fumes are very irritating to any one having the disease. In about two minutes the irritating symptoms subside, and the patient can then inhale them with deep inspirations, and standing directly over the burning sulphur. He will feel a stinging feeling in the throat, which is the evidence of the remedy proving complete. It is also curious that the patient seems to feel instinctively at this stage that he is being cured. The irritating

feeling when first breathing the fumes may be eased by taking a sip of water, but the less the better.

'I have lived in Russia, and have been familiar with the disease on the spot. It is caused by animalculæ, generated between the bark and the wood of their firewood. When these billets of firewood are laid on the fire, the germs of disease are warmed into life and float off upon the air to spread the disease wherever the wind carries them. The reason of the disease being more virulent this year is in consequence of the long, severe winter, a greater demand has been made on firewood, and in many instances the rotting and decaying timber at the bottom of the stack has been drawn upon to a larger extent than in a mild season.—*Pro Bono Publico*.'

FERTILE QUEENS.

[648.] If any of our friends have any of these to spare, by all means advertise them in the *Journal*. There is a heavy demand for them (natives preferably). I was not able to supply one-sixth part of the applicants in answer to my little advertisement, and I should like to hereby inform intending applicants that I have sold out.—HY. NEVE, *Warbleton, Sussex*.

IN THE HUT.

'A mimic shower
Just shaken from a branch, how large it sounded,
As 'gainst our canvas roof its three drops bounded.'

R. W. GILDER.

[648.] The Hut has a *felt-covered roof*, but it doesn't matter: I drag in the quotation to draw your attention to the glorious rainfall we are having; the sounds of the drops falling on the hut are even more welcome to 'X-Tractor's' ear (why do they always put this auricular appendage in the singular?—it is singular!) than even the hum of bees. Rich fertilising showers make one wish to be young again, and free from rheumatics, just to get wet through for the fun of the thing.

I see many of our readers are going in for using vaseline as a preventive of propolisation. In August, 1888, readers of 'Hut' notes were made acquainted with its value. I was indebted to Mr. Stephen Abbott for the idea, who probably obtained it from that worthy 'grand old' bee-keeper, his father (I beg his pardon for the hinted political comparison); indeed, you tell us so on p. 213. This brings me to the 'very earnest protest against a growing act of unkindness and injustice towards our beloved bees,' by 'Hive,' on the same page, and as he or she also writes under a *nom de plume*, I am free to criticise. It makes one 'so wild, you know,' to hear this pleading from one who excuses the use of carbolic acid and smoke. How are we to do about naphthol, camphor, and many other things good bee-keepers use about hives? And how does 'Hive' know that the bee does not positively feel a thrill of gratitude travel the length of its dorsal vessel, and drop on its tibia, whilst its ocelli are moistened with a token of

thankfulness at the kind provision of the thoughtful bee-master who saves it a vast amount of trouble by stopping air-currents between frames with such an innocuous substance? Use it 'early and often,' bee-keepers; but to extreme susceptibilities I would say—Never tear the bees' home to bits any more, by removing quilts and dividing frames; leave the whole thing entirely to nature and the bees; in fact, the bees would perhaps thank you to leave them too!

I was particularly pleased to see the old familiar 'Mel Sapit Omnia' of your erstwhile well-liked correspondent, 'Amateur Expert.' During his long self-imposed exile, I can assure you 'X-Tractor' has felt very lonely in your columns. There is, indeed, a close friendship of the pen, and well I mind the times he speaks of the results of this friendship.

I am at present experimenting with two stocks of about equal strength, both having plenty of natural stores and equal conditions all round. I started slow stimulation with them, and found the usual amount of resultant 'vino.' Next I removed the feeder from No. 1, when, lo! the impetus slackened off, and the feeder has to go on again. 'Just what any one could have told you,' says one. Precisely so; and that is why one keeps on *trying and proving*, year in and year out, for how many hundreds of bee-keepers are there at this moment who are saying, 'Yes, they're all right; they've plenty?' It is the excitement caused by hauling down syrup that stimulates the workers into stimulating the queen. We know 'everybody knows it,' but we need to bear it in mind.

('In quires, &c., here followeth'—*la grippe*.)

And now, after ten days' punishment, never having spent a day in bed before, that remains of 'X-Tractor' sits at his bedroom window on a glorious bright morning, with a splendid stretch of brilliant green fields, purple distance, and blue sky before him, and takes up his pen in the fond endeavour to complete these notes—not 'In the Hut'—in the same flippant style as when he broke off.

I had plenty of time to ponder over the mysteries of microbes, 'as I laye a-thynkynge, a-thynkynge, a-thynkynge,' and wonder if the distinctly *alkaline* medical treatment would at all apply to that other microbe bee-keepers are all so interested in—and, to tell the truth, I gave a passing thought to the obituary column. . . .

'Tis still,—and yet what woody noises loom

Against the background of the silent gloom!

One well might hear the opening of a flower,

If day were hushed as this.—*Gilder*.

And I, to-day, have thought I saw the daisies and dandelions opening in sheets of bloom, just as at this time I fancy, as 'evening's twilight gathers round,' I can see them close together their petals, to protect their stigmas and anthers from the gently falling rain. It is no great stretch of the imagination for the opening of flowers to be *heard*. I have heard the opening of buds like the hissing of wave-tops and the cracking, rending, ripping of bark, startling like

the sound of musketry—here a shot, there a shot—this in the Braemar forests, at the close of a hot spring day. Do we always remember that trees and roots are elongated only by growth at their tips, and that growth of girth must, in trees, be accompanied by bursting of barks? Hence the marks and channellings.

If I have forgotten the bees, reader, they have not forgotten me, at least I must suppose so, for one or two have darted past my window to-day, as if they would say they have stolen a march on—X-TRACTOR.

DRIVING-STICKS.

[650.] I find sticks for drumming hives when driving bees got up as below very useful. Two pieces of wood, eighteen inches long and one inch square. At end of each screw on a cork at right angles to length of stick. Round the other ends, for comfort in handling. They save one's fingers, and crush fewer bees than plain sticks.

Our Irish bees in this neighbourhood seem to have stood the winter very well. The number of extinct colonies is not much above the average. The frost of March was the most trying. Cool days and frosty nights have kept our little friends back so much that I fear we shall have but few May swarms. Slowly but surely the bar-few is taking the place of the skep.—AN IRISH PARSON, *Belturbet*.

BEEES IN VALENTIA.

[651.] What could have induced me (in 631, p. 210) to say that Valentia was in the north-west of Ireland, when no one knows better than I do that it is in the south-west? Not worth while to correct it, I dare say, but it is such a stupid mistake.

I said it was windy down there, didn't I? Well, so it is; we read in the papers sometimes of 'a gale in Valentia.' Fresh from the Atlantic, the wind blows before it has had time to conform to the manners and customs of civilised life. Didn't it lift a large pleasure-boat, lying at the end of our house one day, across the lawn of more than fifty yards, over the wall, across the road, down the strand, into the sea? Yes, it did all this, and as the result of this and many similar pranks, I am obliged to drive the posts of my bee-stands firmly into the ground, to fasten the hives to the stands with iron hooks and eyes, and fasten also the roofs to the hives in a similar manner. With all these precautions, I have more than once found the roof of a hive carried over a high bank into the adjoining field. Nevertheless, the bees seem rather to enjoy the fun of a good blow.

There are, I think, about five bee-keepers in the island, the largest apiary being that of Miss Fitzgerald, the sister of the Knight of Kerry, very beautifully situated at Glanleam, surrounded by large gardens, woods, and everything to give delight to her bees, which I trust

have come well through the long winter. We have no foreign bees in the island, and, as I think, in consequence, we know nothing of foul brood.

Why don't some of you English bee-keepers, when out for your holidays, come down to see us? Nothing much to look at in the way of bees, but a hearty welcome, and as fine a bit of Irish coast scenery as you will find anywhere. Will you come, some of you? The Valentia hotel would give you all the comfort and attention you require, kept a short time ago by Dan Cremsie and his five handsome daughters. But poor Dan has gone to 'the undiscovered country,' and three of his daughters would persist in getting married (is this also an undiscovered country?). However, there are still two of the daughters left. Only I would caution any young fellows likely to be smitten not to come, for 'the daughters of Erin' and all that—you know!

Then we have other things to show you. Here it is, as some say, that a good deal of the weather is brewed, as to which, Mr. Cullum of the Meteorological Office would give you much information and explain his wonderful instruments—such as those for measuring the sunshine (alas! so little as yet this year); for registering the dew and rainfall; also the one about the wind, which would be so useful to some of you if it be true that it is an instrument for 'raising the wind' as well as registering its force. Here also is the Anglo-American cable station, with its wonderful arrangements and its large and intelligent staff of clerks working night and day, with some thousand messages going and coming across the Atlantic. By the grace and favour of the superintendent, Mr. Graves, you might be allowed to send and receive a message across to Heart's Content, with reference to the weather in that far-off land. Only don't trouble him during the 'stock period,' when they are busy enough, and are perhaps sending a message from London to New York, and will get an answer back to London in one minute!

Here also you can see the fishing fleet of fifty or sixty vessels from Belfast, Isle of Man, Kirkcaldy, and other ports, engaged in mackerel fishing. For their well-conducted crews we are this year building a reading-room, to be used also for amateur concerts, and other purposes.

I think this is all I have to say about the island. Oh! there is the big fuchsia in the Knight of Kerry's garden, the largest in the world, I believe, and I am afraid to say how many yards in circumference. But there, you see flowering shrubs grow so luxuriantly down here.

Now, if I don't say a little about bees, this article will scarcely be acceptable for the *B. B. J.*, so I will ask you to come and look at one other thing and that is an old hive full of comb. A year or two ago there was a great discussion in the *Journal* as to whether parallel frames or right-angled ones were the best for the bees. It is in reference to this controversy that I want you to look at this skep. I had a swarm rather

late in the season and very weak, and, unfortunately, this swarm was robbed to death. They had built three combs parallel to the entrance. When they were all killed, I preserved the hive, and early the next summer I put in another swarm. Says the queen, or chief architect, or whoever arranges their plans in the hive, 'this is not the right way to work at all,' and forthwith they began to build their combs at right angles to the entrance, and so they filled and finished the skep. Odd, isn't it, that the two lots of bees did not agree as to which way was the best? Not odd, therefore, that our most expert bee-keepers did not agree either! I dare say I shall be home in Valentia about swarming-time. Will you come?—C. C. P., *Horsham*.

BEE-FLOWERS.

[652.] Like your correspondent, 'Lordswood' (637, p. 221), I was surprised to see the nasturtium mentioned as a bee-flower. I have a large quantity of them in the garden, and never noticed a single instance of them being visited by bees. I cut a very large bunch of the blossoms, and placed them in a jug near the hive, to satisfy myself on the point, and not the slightest notice was taken of them. A large pailful of branches of giant balsam similarly treated was visited by hosts of bees until they were exhausted. If any of your readers are unable to get plants of the giant balsam, and will write me, I will send them a few. I think I must be the only bee-keeper in this neighbourhood, as I see no other bees about, of which I am rather surprised, as there is an open space quite as large as Battersea Park, and a great deal of fruit grown there.—G. NEWMAN, 57, *Coldharbour Lane, Camberwell, E.C.*

[Bees will neglect nasturtiums as they will other flowers, when better forage is about, and we have known the giant balsam, of which our correspondent speaks so highly, to be entirely unvisited by bees until other plants preferred were over. Setting branches of bloom by a hive is also a very unreliable test of its quality as a bee-flower.—EDS.]

AN EARLY SWARM.

[653.] On Monday, May 4th, a very fine swarm of bees issued from a straw skep in the apiary of Rev. E. Davenport, of Stourport, Worcestershire. This, so far as we have been able to ascertain, is the earliest swarm of which we have any record for the present year.

'SWEETNESS AND LIGHT'

[654.] A correspondent of *Notes and Queries* says that the expression 'Sweetness and Light' is meaningless unless we know the context. It may therefore be useful to give it. In Swift's

Battle of the Books there is a dispute between a spider and a bee. Afterwards AEsop takes up the cause of ancient authors, whom he likens to bees, and says that 'instead of dirt and poison (such as are collected by modern authors or spiders), we have rather chose (*sic*) to fill our hives with honey and wax, thus furnishing mankind with the two noblest of things, which are *sweetness* and *light*.'—Communicated by REV. DR. BARTRUM.

Queries and Replies.

[354.] *Combs Broken Down*.—1. What had I best do with my bees under the following circumstances:—In the autumn I put two swarms together into a frame hive on four frames filled with honey and as much syrup as they would take down. They have lived well through the winter, but on examining I find the combs broken away after removing the tapes, and they are built across the frames. What can I do to remedy this? 2. I put three weak swarms into another hive on five frames, and these also are doing well. How soon may I add additional frames to the lot, and how many may I give at one time? 3. I have two box hives, which I intend to unite in one bar-frame hive. When will be the best time—now, or in the autumn? 4. Looking into one of these through a glass at the back, I see the combs near the bottom are spotted with a yellowish excrement. Is this an indication of dysentery, or of any disease? 5. I send herewith a couple of bees and some of the comb, and should be greatly obliged if you could say whether there is any disease? 6. Will it be safe to put the combs in a bar-frame hive to start a swarm with? 7. I notice also two or three dead bees in front of each of the other stocks: is this right?—INQUIRER, *Launceston*.

REPLY.—1. Much depends on the actual condition of the combs as they now stand. If the four frames can be lifted out *en bloc*, it may be possible to separate the combs one by one, and by using spare frames re-tie them in without moving the hive or causing much disturbance. The middle of a warm day must be chosen, and the stock carried to a sheltered corner while being operated on. Place a hive—with a frame or two of comb in it—on the old stand, to receive the bees as the latter are shaken from the combs and allowed to run into it. When all have gone through, the beeless combs may be taken into a warm room and tied into spare frames, care being taken not to chill or damage the brood. Replace in the hive as soon as possible, setting the four combs together in the centre. 2. Extra combs may be given as soon as the others are well covered with bees. Add only one at a time—on the outside—till the weather is settled and warm. 3. If both stocks are now doing well, defer uniting till autumn. 4. Not necessarily. It may be merely the result of long confinement last winter. 5. Bees or comb have not been received at Kings Langley,

where your queries have been wrongly addressed (see instructions on front page). 6. Yes; but if there is any suspicion of disease, *i.e.*, sealed cells in the combs, they should be disinfected. 7. Two or three dead bees in front of hives are quite common and mean nothing.

[355.] *Using Combed Sections*.—Having a number of sections well filled with comb without honey over from last year, would you advise me to give them, or the best of them, to the bees this year instead of new ones? Some are rather green-coloured, as most of my honey was last year.—READER, *Glanmire, Cork*.

REPLY.—The sections will have a brighter and cleaner finish when filled with this season's honey if you cut down the combs with a very sharp knife until the cells are reduced to half-depth from the midrib.

[356.] *Foul Brood*.—Last summer I found my bees were attacked by this disease, and wrote for your advice. I regret to say three out of my four stocks are in a worse plight than ever. No. 1, strong in bees, with about a tenth of brood diseased. No. 2, strong in bees, and almost in perfect health. Nos. 3 and 4, rather weak in bees, and about one-third of brood diseased. Last autumn I burnt the combs that were very badly affected, sprayed remainder with salicylic and borax, as per your instructions, and gave same in syrup. In the autumn there was little or no disease, and I was hoping it was gone. This spring I served them similarly as soon as I found they were diseased. 1. Can you give me any further advice or cure? 2. I have an idea of uniting the two weak ones, first depriving them of their present combs, put the bees into a skep for a couple of days, and then give them a new hive fitted out with whole sheets of foundation. Do you think this will answer?—W. J. G., *Exmouth*.

REPLY.—1. Naphthol has been successful where salicylic acid has failed, so we advise a trial of it, though much, of course, depends upon the thoroughness with which any remedy is applied. 2. A fortnight hence will be the most favourable time of the whole year for trying the starvation method of cure, so there is every chance of success if the bees are sufficiently numerous.

Echoes from the Hives.

Weston, Leamington, May 8th, 1891.—At last we have had a grand week for the bees; they have revelled to their hearts' content in such a mass of bloom as I do not recollect seeing for many years. I have been looking over stocks, giving room where necessary, at the same time noticing the new honey shining in the cells, also there is a decided fragrant smell all among the hives. We all hope that this nice weather will last, for we have had a good dose of the opposite kind. Yesterday evening the wind was blowing

very keen from the east, so we must not count too much on the fine weather calmly for fear of being disappointed. The hedgerows (where there is blackthorn) are quite white—so great is the profusion of blossom. Sycamores round here, too, have been alive with bees, and horse-chestnuts also look very promising, as does also the whitethorn, which in all probability will be in bloom and over before we have any white clover in bloom, so that we cannot have honey from whitethorn and clover, as our old friend Rusbridge had at Sidlesham many years ago. The recent heavy rains have set all vegetation on the move: the clovers especially look healthy and vigorous. A bee-keeper of the old school came to me for a queen last week. I gave him one, and, seeing my bees out in great force, he could scarcely believe his own eyes. His own management (?) of his skeps and the untoward weather had reduced his stocks down to two! He is a non-believer in bar-frame hives. I showed him a half-inch hive in which I had safely wintered a nucleus of four frames.—
JOHN WALTON.

Notices to Correspondents and Inquirers.

Letters or queries asking for addresses of manufacturers or correspondents, or where appliances can be purchased, or replies giving such information, can only be inserted as advertisements. The space devoted to letters, queries, and replies, is meant for the general good of bee-keepers, and not for advertisements. We wish our Correspondents to bear in mind that, as it is necessary for us to go to press in advance of the date of issue, queries cannot always be replied to in the issue immediately following the receipt of their communication.

S. WILLETT (Kettering).—*Webster's Carbolic Fumigator*.—Seeing that the inventor himself sells the fumigating agent used in the above, it can hardly be expected that he will furnish particulars of the method of preparing it. Besides, a bottle, costing sixpence, will last several seasons, so it would not be worth any one's while to purchase materials to prepare it for themselves.

W. HAWKES (Royston).—1. *Syrup for Spring Feeding*.—Seven pints water to ten pounds granulated cane sugar, boiled gently for one minute. 2. *Boiled Honey*.—This is not injurious to bees, but why boil it?

A. HOLMES (Harrington).—Dr. Tinker's book is scarcely adapted for a beginner. *Modern Bee-keeping*, price 6d., or Cowan's *Guide-book*, price 1s. 6d., would suit you better. Either can be had from J. Huckle, Kings Langley.

G. B. (Craven Terrace).—The arrangements for supplying sugar are already completed (see next column). 1. Syrup is the most suitable food for a swarm. 2. Supers are needed as soon as hives are fairly full of bees and honey is coming in. 3. The bluebell is not a bee-flower.

K. M. PUGHE (Whitehaven).—*Balling Queens*.—The queen sent has been 'balled' and killed by the bees, without doubt, and it is also safe to assume that it was due to the excitement

caused by opening the hive on previous day. There is, however, no reason why so simple an operation as inserting a comb should cause excitement and consequent 'balling' of queens, unless in some way mismanaged. The bees will raise another queen, but it is for you to say 'if it would not be best to purchase another queen?' It would save time, no doubt, but there is the cost and risk of safe introduction as a set-off.

* * Several letters, &c., are unavoidably held over till next week.

British Bee Journal and Bee-keepers' Record.

OFFICE:

17 KING WILLIAM STREET, STRAND, LONDON, W.C.

PURE CANE SUGARS.

For the accommodation of Bee-keepers, guaranteed Pure Cane Sugar will be supplied in large or small quantities through this office at the under-mentioned rates:—

CRYSTALLISED.

4. DEMERARA	} Neat bags, 14-lbs. 28-lbs. 56-lbs. Cwts.
5. BARBADOS	
6. TRINIDAD	} Crystals 2/9 5/4 10/6 20/6

REFINED CANE.

7. WHITE CRYSTALS (Small)	3/0	5/10	11/6	22/6
8, 9. (Medium and Large sizes, 1/- per Cwt. extra.)				
10. LUMP (Cut Loaf) ... Boxes,	3/3	6/3	12/3	23/6
11. LUMP DUST ...	3/0	6/0	11/9	22/9

All above guaranteed made from CANE SUGAR only, and free from BEET, CHEMICALS, &c., &c.

CARRIAGE PAID on Orders over 5/0 (or 28-lbs. Sugar) to London and Suburbs.

COUNTRY ORDERS, not less than 2-cwt. carriage paid at 1/0 per cwt. extra.

(Scotch and Irish orders, special arrangements.)

Cash to be sent with order, and purchasers will please observe that if samples are required or replies asked to inquiries, a stamped addressed envelope must be sent, as we cannot undertake cost of postage.

APIARIAN SUPPLIES.

WE make undoubtedly the Finest PERFORATED ZINC, and the Nicest WHITE POPLAR SECTIONS now made. Any style of ZINC, or FOUR-PIECE SECTIONS desired.

Address for CATALOGUE,

DR. G. L. TINKER,

New Philadelphia, OHIO, U.S.A. 235

SWARMS! SWARMS! SWARMS!

TENTH SEASON.

3 lb. SWARMS, 10s. 6d.; larger if desired at same rate. Boxes to be returned, or 1s. 3d. added to remittance.

Orders executed in rotation.

C. N. WHITE, Somersham, Hunts. 237

THE British Bee Journal, BEE-KEEPERS' RECORD AND ADVISER.

No. 466. Vol. XIX. N.S. 74.]

MAY 28, 1891.

[Published Weekly

Editorial, Notices, &c.

HUBER'S LETTERS.

We wish to inform our readers that, by the courtesy of Count Mouxy de Loche, we have had the original letters of François Huber entrusted to our care. These letters were referred to by us in 'Bee Rambles in Savoy,' on page 172 *B. B. J.* We shall be pleased to show them to any of our friends who are interested in seeing these curiosities at the office of the *Journal* on Thursday and Friday, May 28th and 29th, and on Monday, June 1st, between two and five o'clock in the afternoon. The letters contain many subjects of interest, and have never yet been published. We hope those who can avail themselves of this opportunity will do so.

BEEES AND ORCHIDS.

At this time of the year bees will be seen entering hives carrying what to a casual observer would appear as horns on their heads and between the antennæ. Every spring we have such bees sent to us, and this season has not been an exception. We have one before us having several such horns (Fig. 1), and our correspondent who sends it supposes it to be a fungus of some sort. Now, these are nothing more nor less than pollen masses, or pollinia, as they are called, of orchids, in this particular instance it being *Orchis mascula*, in full bloom just now in many of our moist woods, meadows, and shady places.



Fig. 1.

Fertilisation is effected in orchids quite differently to what it is in such flowers, for instance, as those of our apple and pear trees. In these the pollen is in a powder, which sticks to the hairs of the bee, and is collected and transferred to the pollen-baskets on the hind legs. The bee, in passing from flower to flower, is almost sure to bring some of the pollen-grains on its body in contact with the sticky stigma, and in this way cross-fertilisation is effected.

If we examine an orchis bloom from the front (Fig. 2) we shall get an idea of its structure,

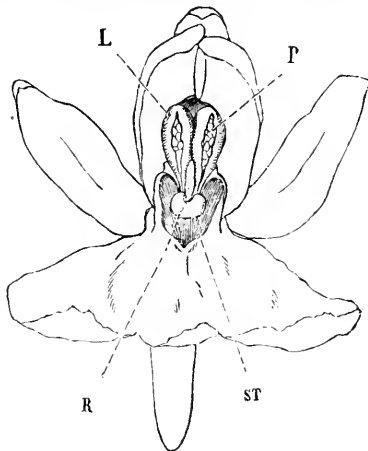

Fig. 2.

Fig. 3 giving a side view of the same flower on rather a smaller scale. The wrinkly stalk is seen in Fig. 3, and just below it, and between R



Fig. 3.

and ST, Fig. 2, is the nectary or tube in which the nectar collects, and down which the bee has to put her tongue in order to reach the nectar. The stigma, ST (Fig. 2), is bilobed, consists of two almost confluent stigmas, and lies just under the pouch-formed rostellum, R. The anther just above it, L, consists of two—one of which, on the opposite side, corresponds to L—widely separated cells, which are open longitudinally in front, and each cell contains a pollen-mass or pollinium, P.

The pollinia removed from these cells, and showing their relative positions, are seen at Fig. 4. Each pollinium consists of a number of packets of pollen-grains united together by elastic threads. These threads unite at the lower end of each pollen-mass, and form what are termed the *caudicles*, at the bottom of each

being attached a viscid disc. Each pollinium has its own separate disc, and the balls of viscid matter constituting these discs lie enclosed to-

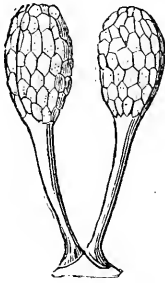

Fig. 4.

gether within the rostellum. The rostellum is almost a spherical, somewhat pointed projection overhanging the stigma, and seen in Fig. 3 just over the opening of the tube. Without going into full details of the structure of this complicated organ, we can explain that the pollen-masses are enclosed in two pouches, with the viscid discs downwards, these being covered by a very delicate membrane whilst in position. To understand how these pollinia get transferred to a bee's head, and fertilisation effected, we must watch a bee; and we shall see her alight on the lower petal or *labellum*, as it is called in orchids, and at once insert her head as far as she can get it into the tube. This is not far, for it is stopped by the projecting rostellum, this act, rupturing the thin membrane, and exposing the viscid discs, which now adhere to the bee's head. The viscid matter has the property of becoming hard and dry in a few minutes.

After taking the nectar, when the insect withdraws its head, one or both of the pollinia will be firmly attached to the head, and project like horns. The firmness of the attachment is very important, for if the pollinia were to fall sideways or backwards, they could not fertilise the flowers. Now, the most marvellous contrivance exists by which the pollen-masses are brought into position for touching the stigma. The caudicle has the power of contraction in such a way that it causes the pollinium to sweep through an angle of ninety degrees, but always in the direction towards the proboscis of the insect, in the course of thirty seconds on an average. The time it takes to complete this movement is about sufficient to enable a bee to fly to another plant. On a bee entering the flower from the alighting-place, the thick ends of the pollinia exactly strike the stigmatic surface. This is also viscid, but not so viscid as to pull off the whole of the pollinium from the insect's head. It is sufficiently viscid to break the elastic threads, and leave some of the pollen-grains on the stigma, and in this manner the insect may, by means of one pollen-mass, fertilise several stigmas, until nothing but the caudicles remain. Darwin, in his *Fertilisation of Orchids*, describes how the whole of the process of removing the pollinia

may be shown by inserting the point of a pencil into the nectary. The pollinia stand at right angles to the sloping side of the pencil, and if this is held still for half a minute it will be seen that the pollinia sweep towards the point of the pencil until they lie in a horizontal position (Fig. 5). We have many times used

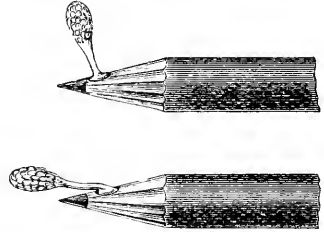

Fig. 5.

this means of illustration, which has always caused astonishment and admiration of this contrivance for ensuring the fertilisation of these flowers.

BRISTOL BEE-KEEPERS' ASSOCIATION.

The Bristol District Bee-keepers' Association for South Gloucestershire and North Somerset held their annual general meeting in that city on Tuesday, May 5th—Mr. J. B. Butler in the chair. The Secretary, Mr. H. M. Appleton, on behalf of the Committee, presented a very encouraging report, showing that the Society is making great progress, that the work of its Expert, Mr. J. Martin, is much appreciated, and that the subscriptions are rapidly increasing. The report stated that money is put to the best advantage in the encouragement of bee-keeping. The tent of the Association has visited a number of horticultural shows, and most instructive lectures have been delivered by some of the more energetic members, showing how much more profitable it is to keep bees on the new system. The report was unanimously adopted. Lady Smyth was re-elected President, Mr. J. B. Rutler, Treasurer, and Mr. J. Brown, of Baldwin Street, Hon. Secretary. It was unanimously resolved to have a show of honey, bees, &c., in connexion with the Long Ashton flower show, which is to be held in August, and to issue at an early date a schedule of prizes.

WARWICKSHIRE B.K.A.

The annual meeting of the above Association was held on Thursday, the 21st inst., at the Midland Hotel, Birmingham. Mr. Richard Ramsden presided, and was supported by Dr. Savage, Miss Savage, Mr. R. Bowen, Mr. S. Round, Mr. R. H. Smith, Mr. and Mrs. Young, Mr. Barwell, Mrs. Sargent, Mr. J. N. Bower (Hon. Secretary), Mr. J. R. Inglethorpe (Assistant Secretary), &c. Letters of apology for non-attendance had been received from Lord Leigh, Mr. J. Chamberlain, M.P., Mr. Jesse Collings, M.P., Mr. Joseph Rowlands, &c.

The report for the year 1890 stated that the Association is now free from debt. The income from all sources amounted to 39*l.* 4*s.* 6*d.*, and the expenditure, including an adverse balance from the previous year of 8*l.* 2*s.* 7*d.*, to 29*l.* 1*s.* 3*d.*, leaving in hand 10*l.* 3*s.* 3*d.* The work of the Association had been very much impaired for lack of funds, and the Committee had consequently been unable to carry out fully the objects of the Association; but they now hoped at this turning-point that all members would make a good effort during the current year to enable the Committee to arrange not only for the two tours, but a good county exhibition. The report and balance-sheet were unanimously adopted.

The officers, with the addition of Mr. Richard Ramsden as Vice-President, were re-elected.

A vote of thanks was also given to Mr. Summerskill for his services as expert to the society, he having received another appointment. Mr. Summerskill afterwards gave a short address on the hive bee.

Bee Shows to Come.

June 3rd to 8th inclusive.—Bath and West of England Agricultural Society at Bath. Entries closed. J. Huckle, Kings Langley.

June 22nd to 26th.—Royal Agricultural Society at Doncaster. Entries closed.

July 2nd.—Kent Association in conjunction with the Rose and Horticultural Society at Farningham, Kent. Entries close June 27th. Jesse Garratt, Hon. Sec., Meopham, Kent.

August 5th, 6th, and 7th.—Yorkshire Agricultural Society at Bradford. Entries close June 27th. Marshall Stephenson, Sec., York.

Correspondence.

The Editors do not hold themselves responsible for the opinions expressed by correspondents. No notice will be taken of anonymous communications, and correspondents are requested to write on one side of the paper only, and give their real names and addresses, not necessarily for publication, but as a guarantee of good faith. Illustrations should be drawn on separate pieces of paper.

NOTES BY THE WAY.

[655.] I don't think it will require any excuse this week if I refer to the weather first. The foreigner makes fun of us English because we always talk 'weather' when we meet, and often avers with some truth that we get only samples of weather. Well, it is a consolation to us bee-keepers that the present 'cold wave' or 'depression'—call it which you like—is only a sample: it must be some remnant of winter that has got out of its true course. Why, less than a fortnight ago we fondly hoped we had reached the period of the year when we were safe from the ravages of 'Jack Frost,' but last Saturday and Sunday taught us a stern lesson and dispelled our hopes of an early swarming season. The question for a few days was, 'Have you had

a swarm yet?' and to a negative answer I got the rejoinder, 'Why, you are all behind this May; I had two out on Wednesday, and Farmer Mathews two swarms the same day.' That was on the 13th inst., the last day of spring weather, and since then we have returned to the period of frost and snow, of hail and sleet, of cold, dull, wet, sunless days, and at the time of writing—2:30 p.m.—the barometer stands steady at 29 in. rain, and the thermometer at 42°. The trees, erstwhile white with blossom, are seared and brown now, and our prospects of fruit very meagre. The apiary, still and quiet as 'the great lone land,' made more noticeable after the few hot days we had early in last week when every colony was busy, and the strong ones were booming and roaring as they generally do towards the end of June.

I trust those who were fortunate enough to secure swarms have taken them in charge and given a constant supply of food to them, or many must have died if the bees were driven to seek food in such untoward weather.

We have had a considerable rainfall during the last few days, which was badly wanted, as the ponds and tanks in which our stores of water are kept for future use were all getting very low, and the crops also required rain, especially the grass, so that, notwithstanding the check it has given to bees and bee-keepers, we must console ourselves with the knowledge that, given seasonable weather during the next two months, we may eventually be thankful for the rain that has come just at the opening of our busy swarming season.

I was surprised to see Mr. J. D. McNally's letter (645) re the exclusiveness of the Ulster Bee-keepers' Association. Is it from clannishness, or must we go to a lower level—*i.e.*, jealousy—to find a cause for non-admission to one bearing a honoured name among leading bee-keepers in the northern part of our land? For my own part, I should have expected that any association of bee-keepers would have been proud to add the name of McNally to their list of members; it is to progressive bee-keepers that we owe our present position in the apicultural world.

Thanks, Dr. Miller, for correction (643), which quite explains the reason for the stationary condition of hives as regards weight at the two weighings.

I was very sorry to see in last issue that friend 'Extractor' has been in the grip of *la grippe*. I extend my sincere sympathy, and trust he will be able to write his next article in 'The Hut.'

Bee Flowers.—I, too, have never seen bees working on nasturtiums, but it does not follow that bees do not visit this flower on other soils. On looking through an apiary for a lady friend recently, we talked bee-flowers, and she praised the *Myosotis* (garden forget-me-not) as a capital bee-flower. Now I have never seen a bee working them, although I have some in bloom every spring, so that possibly the kind of soil on which our flowers grow may have a great influence on

the honey production; thus the same species may produce honey on some kinds of soil and not on other kinds.

Excluder Zinc.—Now that the season is at hand when excluders will be in use, I would mention that our American brethren in the craft use slatted excluders—*i.e.*, a strip of zinc and a strip of wood alternately—and I notice Dr. Tinker is advocating that strips of zinc should be only two holes wide, so that the bees, on reaching the tops of the combs, may still run up the edges of the wood through the holes in the zinc. This suggestion is very reasonable, and I think is worthy of adoption, as it stands to reason that a bee loaded with honey can get through the perforations in the excluder quicker and better if it has a foothold below, just as in like manner we can get over a stile if there is a step quicker and easier than without one; or perhaps a better illustration of what I mean will be a trap-door which one can scarcely reach, but if we can place a stepping-stone or stool how much more quickly and easily we can get through.

I notice that in America they have had a beautiful spring, and bee-keepers are looking forward to one of the good old-fashioned honey harvests this year.—W. WOODLEY, *World's End, Newbury.*

VASELINE A STING-PREVENTER.

[656.] There have been many notes lately in the *Bee Journal* in reference to the uses of vaseline in hives. It will be found to be equally as useful as a sting-preventer. Four or five years ago I suffered badly with eczema of the hands. It was painful to touch anything, and it made me very sensitive to the stings of bees. I tried the best recommended sting-preventing lotion, but, though it pacified the bees, it had a bad effect on my hands by drying the skin. I therefore had recourse to vaseline, and found that, in addition to benefiting my hands, it had as good an effect, as a sting-preventer, as any remedy I have tried. Perhaps this information may be of use to others. The remedy is cheap, efficient, and a benefit to the hands.—JOHN RUDGE, *Dursley, May 22nd.*

JOINING BEE ASSOCIATIONS.

[657.] Under the above heading (on p. 233, No. 645) I read Mr. McNally's letter with deep regret. Who would have thought, after the great effort made last season by that gentleman to champion *Irish honey* against the world, that he should now be denied membership in the Ulster B.K.A.?

This flourishing Association, I think, can hardly be guilty of such discourtesy when we remember the good it has done, and, I trust, will continue to do, for the bee-keeping fraternity in the north, by holding its annual shows, giving lectures, &c., at various centres throughout Ulster.

I only became acquainted with Mr. McNally last year, having met him at Newtownards Show, where his exhibits of honey were awarded premier honours, and the previous week the gold medal at Larne. The style and finish of Mr. McNally's exhibits at the said show were the admiration of all who witnessed them, and clearly demonstrated the fact that in the matter of honey-showing he had no rivals. Surely it is not jealousy on the part of the Ulster Association, yet why should they slight one so competent, one so worthy of a place amongst them, as the gentleman in question? There can be no doubt that the action of the Association or its representatives will be justly condemned by every bee-keeper in Ulster 'outside the chosen few' until some explanation is forthcoming why the application for membership by Mr. McNally was refused.—J. M., *Dunmurry, co. Antrim, May 18th, 1891.*

SIZE OF HIVES FOR THE NORTH.

[658.] There seems to be an idea among bee-keepers in these parts that a hive containing nine frames is large enough for all practical purposes so far north. Will you kindly allow any northern bee-keepers to give us their experience in the *Journal* on this point? We had most severe weather here last week. Thirteen degrees of frost were registered not far from Ripon, and all the leaves were killed on the beech-trees, and now crumble away when touched. The bloom on the sycamores was destroyed, and there was a *deep* fall of snow, much of which was lying the following morning. Need I add there are no reports as yet of bees swarming?—ARTHUR J. H. WOOD, *Bellwood, Ripon, May 23rd.*

VASELINE AND BEES.

[659.] I should esteem it a great favour if you would allow me to express to 'X-Tractor' my deep regret that my remarks on vaseline should have made him 'so wild' as to have apparently brought on an attack of influenza. I beg to assure 'X-Tractor' that in future I will endeavour so to shape my remarks that they may not excite his 'extreme susceptibilities' for becoming 'so wild, you know.' I have also a feeling of sympathy for the members of his household and for his dear bees. My bees are very naughty, but they will have it that, in some way, the 'ten days' punishment, never having spent a day in bed before, was associated with the being 'so wild, you know.' They are also of opinion that in 'X-Tractor's' case the use of vaseline on the various parts of the hive would be advantageous.—HIVE.

BEE EXPERIENCES.

[660.] I started bee-keeping about five years ago, and so great is the interest I now take in it that it seems part of my life. My hives are all

home-made, each holding nine standard frames, and when the bees have filled one box I add another. Last year one stock had three such boxes, one on the top of the other. My queens have the whole run of the hive. I never use excluder zinc, although not condemning it, because I have always done very well without it, both for sections and extracting. If the queen does stray into the top boxes I don't mind, because any extra brood combs come in handy in the autumn for driven bees. I never let my bees swarm more than I can help; it don't pay, as I can get plenty of bees in the autumn for the driving of them. I use galvanised roofing for roofs; a seven-foot sheet cuts into three roofs, and I don't wish for anything better. My bees were wintered on nine frames, but this winter I tried a stock in two boxes, one on the top of the other, with plenty of sealed food. There were plenty of bees in the lower box, but scarcely any food. Now, talk about wintering your bees on six frames, as some of your correspondents do, why that lot of bees with eighteen frames will very soon have a crate of sections on; they are the strongest lot I have.—OWEN BROWNING, *Kings Somborne, Hants.*

HULL AND EAST RIDING DISTRICT BRANCH OF THE YORKSHIRE B.K.A.

[661.] I regret to have to inform your readers that the above Branch Association has taken the liberty of dying, and has handed over its effects to me.

Mr. H. E. Holmes, the Hon. Sec., desires me to acknowledge receipt, through your columns, of the books, cash balance *£12s. 10d.*, an extractor, thirty-five copies of *Modern Bee-keeping*, and several copies of the *Bee-keepers' Record*.

I can only add, it seems a pity, on looking back to the good show this Association made at Hull in 1889, that it should so soon have burst up. But, to any one acquainted with the peculiar disadvantages under which it laboured, it is no mystery.—R. A. H. GRIMSHAW, *Cray Hill, Horsforth, near Leeds, May 18th, 1891.*

FOUL BROOD.

[662.] On looking through my hives I find that foul brood is again visible in three stocks, so that—the various remedies tried notwithstanding—it has only been 'scotched,' not cured. The stock which was worst last year, and which was re-queened, is not so very bad at present; possibly the progeny of her young majesty having greater vigour of constitution are not so susceptible to attack. In feeding this spring I have used naphthalised syrup; but now supers are on, and this cannot be done. I have noticed that when new combs are built out, the percentage of diseased grubs is greater than in old combs.

Can our friend Mr. Woodley give us the benefit of his experience as to which coloured

enamel on the metal cases harmonises best with the colour of the comb? Last season I used bronzed cases, and liked them very well.

I should be glad if you will allow me to ask whether any reader of the *Journal* living in a moorland district could oblige by sending me a fresh specimen of *Pilularia*, *Chara*, or *Nitella* (stoneworts), and *Salvinia*? I would gladly pay postage. The specimens would travel well if packed in damp moss or cotton-wool, or even in a small tin box.—THOS. BARCOCK, *Southfleet, Kent, May 25th.*

NOTES FROM IRELAND.

[663.] Early in the present year there passed from our midst one of the most promising bee-keepers in Ireland. I refer to the late Rev. J. McNeece, A.M., of Tullylish, an eminent servant of God, revered and loved by all who knew him, and always the more the larger the personal acquaintance. He was as well in point of bodily health apparently as any of us, and more likely than some to see increase of days and usefulness. He was taken away by a sudden and unexpected death. It is not necessary to refer at any length to the character of the noble man whose loss came upon the community at large, and especially the bee-keepers, as a stunning blow almost impossible to realise. It may require a mind somewhat akin to his own to be able fully to appreciate and adequately describe his many high qualities, the relation in which they stood to each other, and their mutual influence on those with whom his ministerial office brought him in contact; but the more prominent features were within the observation of, and were felt by, all classes. His self-sacrificing spirit endeared him to all who knew him. By his teachings not a few of the bee-men in this district attained their success.

Some time ago Mr. W. G. W. Flynn, another prominent bee-keeper, removed from Laurencetown to Banford House, near Gilford. On Friday last, May 22nd, I had the pleasure of paying him a visit there, and inspecting his apiary. His stocks (seven in number) are in splendid condition, and should favourable weather set in he is certain to have a large yield of honey, the locality is so well adapted for bees, with unlimited forage of every description. For a number of seasons bees have got under the roof of Banford House, and while there I watched them busy working away. It is intended to make a raid on their retreat at the end of the season, and I trust the efforts of those who undertake the job will be rewarded with a large haul of honey. Mr. Flynn has his bees beautifully arranged on the lawn in front of the house, and when driving along they present from the road quite a picturesque appearance, being all in well-made frame hives. As the pioneer bee-keeper of the district he still holds the lead, and last season was a very successful exhibitor. I have no doubt he will be able to give a good account of himself during the coming season. We have no swarms in this part so far,

but a number of leading lights are busy making self-hivers in order to test their merits. For my own part, after what I saw of these last year I will prefer running the risk of allowing my bees to swarm naturally.—JOHN D. MCNALLY, *Laurencetown, co. Down.*

[664.] TO 'X-TRACTOR.'

Alas, alas! the other day
Much grieved was I to find
That 'X-Tractor' *la grippe* had got,
And had thought o' the broad black line.

Long may he reign o'er 'Hut' and home,
And his mighty smoker yield!
Long may his pen more mightier still
Those spicy writings yield!

May much warm sun and merry hum
Recruit 'all that remains,'
Is the wish of one, who now to him
This sixth huge beaker drains!

PHORMIC.

SWARMING.

[665.] I had a swarm yesterday weighing just over three pounds, from a skep which had wintered well, and been carefully spring fed. I think this is fairly early for so backward a season. It has come in very hot the past few days, and plenty of pear-blossom.—A. J. GORWYN, *Torquay, May 13th.*

COMPLAINTS OF DEALERS.

[666.] We often see complaints from customers that advertisers do not attend to their orders; but what is an advertiser to do when he receives a postcard without signature, such as the enclosed, on which was written as follows:—'N. Petherton, 9491.—Please send per return post 1 lb. formic acid, with instructions with invoice of the same, advertised in *Bee Journal*, Sept. 18th, 1890. Will return cash on receipt of same.'

The above was received by me bearing a Bridgewater postmark. Now, what was I to do? Send '1 lb. formic acid' to Mr. —, N. Petherton, Bridgewater? I rather think the postman would have some difficulty in finding the nameless one. Moreover, as the gentleman who forgot to sign his name could quote the date of advertisement, why wait till he received the acid before remitting? The advertiser *must* be located, whilst the gentleman may be nomadic, and, beyond the promise in postcard, the advertiser has no guarantee that he will ever hear again from N. Petherton, or any other place. Should this meet the eye of the sender, he will understand how it is that he has not heard of the acid.—HAROLD H. LINDON, *The Apiary, Higher Bebington.*

THE MALAGASY BEE (*APIS UNICOLOR*):

ITS HABITS, ENEMIES, AND CULTURE.

If we agree with those entomologists who consider that the honey-bee has wandered westward from India and the East, spreading northwards and southwards over Europe and Africa, and owing to climate and isolation has slightly altered its habit and appearance in the different regions where varieties are found, then the comparison of the English (*Apis mellifica*) with the Malagasy bee (*Apis unicolor*) presents special interest, for in them we can see in what way, and to how great an extent, the two opposite extremes of migration have differed during thousands of years of separation.

Supposing also that the social bees have, as is only in accordance with the laws of evolution, sprung from the solitary bees, we must admit, I think, that this development must have been complete before the great westward migration began; for had this not been the case, it is scarcely likely that there would have been so great a similarity in the result, as I shall point out in the course of this paper. Yet, again, there must have been some land connexion, or else some great change of habit common to all the varieties—which is contrary to the supposition above—seeing that it would be impossible for a swarm headed by its queen to cross so large a stretch of water as the Mozambique Channel, or perhaps even the English Channel, or, if not impossible, yet contrary to all present habits; and yet a single queen, or a queen followed by one or two neuters only, cannot raise a colony. Thus we see that there is no small geographical and scientific interest in the subject before us.

Apis unicolor differs but little in appearance from *Apis mellifica*, so slightly in fact that one is surprised; many of the European varieties differing much more from each other, as also some African varieties. *Apis unicolor* is smaller, darker, and less hardy, with less decided rings on the abdomen. The drones are nearly identical. In both, the queens have reddish-brown legs, whereas the workers have black legs; the queen of *Apis unicolor* perhaps having redder legs than that of the European variety, and in general appearance the latter more closely resembles the worker. The queen of the Malagasy bee has a most beautiful bluish-black sheen over its abdomen, and the hair on the thorax is lighter than that on the neuter. Both varieties have the peculiarity of a curved sting in the queens, and a straight sting in the workers. We thus see how 'true' the bee has kept through countless generations and under vastly different circumstances. No other domestic animal has varied so little or thrown so few 'sports,' for there are only twelve species of *Apis* known, and but few varieties, differing slightly in colouring and habits. This, no doubt, is due in a great measure to the extreme difficulty of artificial selection, yet *Apis* is emphatically an

in-breeder, brother and sister almost invariably pairing when in their native haunts; so that varieties, or even malformations, might have been expected to a much larger extent than is the case.

In a country, too, so isolated as regards its fauna as Madagascar, we might easily have expected some more decided type of *Apis*, or none at all—as is the case in Australia—but such we see is not the case; in appearance and in habits, too, there is as great a resemblance. They choose the same situations for their hives if left to nature. They multiply in the same way, by the old queen leading the first swarm, and the young ones the casts.* This last fact is important where the geographical distribution is concerned, for an old queen is generally heavy with eggs, and in any case is not accustomed to fly far, certainly not across the sea; whereas the young, active queens who lead the casts are still unfertilised, and must be in the proximity of the drones after a site has been found, for not only workers but also drones must follow in her wake. Then again, the drones are idle and are killed off at certain seasons. Fertile workers appear if the hive is queenless, but, as in England, only produce drones. They gather the same food in the same manner. Even in the minutiae of habits they are the same. They hum if excited and when ventilating their hives. They only gather from one species of flower at one flight, a habit among the solitary bees as well. Even their enemies are the same, the wax-moth, the *Sphinx atropos* (death's-head moth), and the rat. Some of the diseases I have not found, but possibly these are products of a higher state of domesticity. Their very behaviour when robbed or queenless is the same. Both will rear queens from worker eggs on an emergency, and in precisely similar a manner, by enlarging the worker cells and altering the food; both diminish the entrance if harassed, and cling in clusters for warmth and for wax-making.

Yet there are many slight differences. Drones seem to be bred with much more regularity by the English bee. There is one great breeding just before the swarming season, and another small one later on; whereas the Malagasy bee seems to breed drones on and off all the year round. There is seldom a month in the year, summer or winter, when drone brood cannot be found. Then, again, the English bees kill their drones off in autumn, the massacre lasting perhaps a day, and not a single drone being left, except in the case of a queenless hive; but the Malagasy bees, though they kill them off to a large extent when food begins to run short in autumn, yet they seem always to leave a few, even in the most prolific colonies—in fact, the greatest number was left in the hive that had the most fertile queen among mine last year.

* A 'cast' is a swarm led by a newly hatched or virgin queen. The first swarm is led by the mother queen; all others that follow from the same hive are 'casts.'

This year, however, all the drones were killed,† but not in one day, only a few at a time. This, I fancy, was owing to food being short on account of the ravages of *Sphinx atropos* earlier in the year.

Difference of climate most likely accounts for this, for the drones being perfectly lazy, collecting no honey and consuming a considerable quantity, would in England help to exhaust the stores before spring, and hence greatly endanger the chance of the colony surviving the winter; but in Madagascar the bees work all the year round without intermission—except, perhaps, a day or two at most in Imèrina—consequently there is no such danger, for they even find sufficient food to raise brood during the winter months. Only in one month during the whole of last year did I notice the hives without brood, and possibly there may have been some then, for not having the colonies at that time in hives with movable frames, I could not examine the centre, where in all probability it would have been. The fact of the bees keeping their useless drones after the swarming season was past, and breeding more, would, one would think, point to a second swarming season in countries where brood can be raised all the year round; yet I have never seen or heard of such a thing here—in fact these bees seldom swarm at all unless cramped for room. I have now two hives that have not swarmed for three seasons; but one that was in a small native water-pot, and full to the mouth, threw a very large swarm and four casts in one season, which weakened it to such an extent that, eventually losing its queen during fertilisation, it died out. I watched it to see if there were any fertile workers, which I found to be the case. These fertile workers are supposed to be those which have been bred near the royal cells, and have inadvertently obtained a small amount of the royal food during the larva stage; but they never produce the eggs of workers, only those of drones, and cannot save a colony from extinction.

(To be continued.)

Queries and Replies.

[357.] *Disinfecting Hives, and Granulated Honey.*—1. What is the best mode of disinfecting empty hives and combs? My bees have had a touch of foul brood, and I want to be on the safe side and disinfect all empty hives and combs. If necessary, with half a day's labour I could take all and put in a steam chest and use sulphur; but if naphtha, Naphthol Beta, or ordinary carbon would in any way disinfect as effectually, that of course would save me time and trouble. 2. How to keep honey liquid for the following reason and purpose:—I sold to

† Since writing the above I have discovered the presence of drones in two of my hives which have fertile queens.

a grocer doing a first-class trade a quantity of honey in one-pound and half-pound bottles, which of course in a short time became granulated. With this granulated honey on the counter he had another sort, bearing the label of a London firm, which I may say is a straw-coloured honey, and to this day has not set, as I have the sample before me as I write. Preference was given to the last-named article on account of its liquid state. I have taken every pains to have mine nice and clean, neatly labelled, and in screw-top jars, &c. In order not to have my honey a burden to any one, I have taken back thirty shillings' worth. This was a damper to me, as I have of late been trying to raise a connexion. People seem to prefer it in the liquid state around here, so if I could surmount that difficulty with your help and advice, I should be grateful.—ARTHUR COLE, *Luton, Beds.*

REPLY.—1. No method of disinfecting can be more effective than using the steam chest and sulphur, as proposed. Neither naphtha nor ordinary carbon have ever been recommended to bee-keepers as disinfectants to our knowledge, and Naphthol Beta is only used for medicating bee-food, as it is too costly for sprinkling on floor-boards. For the latter purpose *naphthaline* is used, and is very inexpensive. 2. Granulated honey may be liquefied by placing the vessel containing it into hot—not boiling—water, and leaving it till thoroughly melted. A few pebbles should be put into the hot water to raise the honey vessel from the bottom of the pan. We should like to examine a sample of the non-granulating honey sold by the London firm, for honeys of that character are nearly always adulterated with glucose.

[358.] *Vaseline in Hives.*—Is there any danger that putting vaseline round the edges of section crate where they touch the hive, and also on the inside of crate where the sections rest on, will in any way prevent the bees from going up—it is, of course, the smell I allude to?—F. J.

REPLY.—No ill effects will be felt from the use of vaseline. Of course, it should be used sparingly, for the sake of cleanliness, &c. There is no smell about it.

Echoes from the Hives.

Usworth Village, Washington Station, co. Durham, May 6th, 1891.—My fifteen stocks of bees, in single-walled hives, are all doing well. I only lost one lot in the winter, so it speaks well for single walls. To-day they are carrying in the golden pellets with a will, and working on the gooseberry bloom. It is a delightful sight to see young bees strolling about on the combs, and brood in all stages in frame hives, and how different to the straw skep o' olden days! I called upon an old skeppist the other night to inquire how his bees were getting on. They had never been fed in the back end of last

year, and in consequence there is about a half-pint of bees in one skep—the other two had died. The old story of leaving the poor bees to take their chance. As the old man is about seventy, it is too late for him to learn better ways.—W. B. CHAMBERS.

Alyth, Perthshire, May 12th, 1891.—The bees here about stood the winter well, and were breeding in February, but the cold, stormy weather of March and April prevented them from making headway. However, the weather has improved, and they are now working away busily, getting a little honey and pollen from fruit-blooms and from whins. About a month ago I put pea-flour on the crocuses and other flowers, and the bees carried away a good quantity of it. I might say that I put five hives on the heather, two of them doubled and three with worked-out sections. One of the doubled ones was about filled from top to bottom; the nine frames of the top story weighed fifty-one and a-half pounds gross weight. From the three with sections I got nearly thirty pounds of honey.—EAST PERTH-SHIRE.

Nyon, Switzerland, May 12th.—The weather for some days has been splendid, and my bees are at least ten days in advance of the usual time. I have been obliged to put supers on most hives. The bloom of the fruit-trees is splendid, and the hives, on scales, show a daily increase of 600 to 1100 grammes, which I have never known before at this season.

May 22nd.—Bees are all up in the supers; sainfoin is just coming into flower. We only now want fine weather. Just as I write we are having sunshine and showers alternately, and the hives do not increase in weight.—ED. BERTRAND.

Honey Cott, Weston, Leamington, May 18th.—'There! that is the last of the honey!' Such were the words made use of by my better half on Whit Sunday morning at breakfast-time, as she placed a small jar on the table with not more than a quarter of a pound of honey in it; 'I do not recollect being driven so close for many years.' What a medley of thoughts passed through my brain while having my breakfast: visions of honey seasons when there was honey everywhere, and plenty to eat, too; also visions of bad seasons, when we had scarcely any honey at all. What thoughts and surmisings about this season's crop! Late-ly, for a few days, we have had some very hot weather, 80° in the shade (too good to last as I said, and found out later), for the last two or three days have been very cold indeed, with heavy rain, hail and snow storms, and a temperature scarcely exceeding, and oftentimes lower than 50°. In the early morning of Whit Sunday there had been a sharp frost (2½°), and everything as white as snow, making it look like midwinter instead of getting on into the summer. On Sunday night the temperature was down to 35°, and it was snowing!—which continued all night, and on Whit Monday morning the ground and fruit-trees and

beehives were covered with snow, although the temperature had only just gone down to the freezing-point. I pity the poor bees; where hives have been supered it must have done them a lot of harm, except they were very strong. Two or three nights ago I went round my hives and shut up the entrances to their usual spring size, as I had opened them a good bit a few days before, when it was so hot. Have been tacking three-eight-inch strips on sides of some shallow frames of comb that I had used for extracting, thus making the top bar full one and a-half inches; also when the extracting-boxes are tiered up there is not so much liability for the bees to join the top of the frames with the bottom of the other; also it makes thicker combs, so that they will hold more honey, consequently there will be fewer combs to extract for a certain amount of honey.—JOHN WALTON.

The Apiary, Higher Bebington, May 18th.—The weather here the last few days has been quite like winter; too much so, I fear, for the poor bees, who, with the fine weather immediately preceding this cold spell, have been breeding fast, and I fear that much brood will be chilled. To-day (18th) the weather is again fine, and as the day gets on will probably be warm.—H. H. LINDON.

REVIEW OF THE BEE JOURNALS OF GERMANY AND AUSTRIA.

By J. DENNLER.

1. *Bienenwirtschaftliches Centrallblatt*. Twenty-seventh year. No. 3. Lehzen, editor.—This German bee journal has the most readers, 12,000, in consequence of its being the organ of several large societies of bee-keepers. The article, 'Monthly Work,' is edited this year by Rud. Dathe, the Director of the celebrated bee-establishment of Eystrup, in Hanover. In the report R. Dathe gives of the results of his system of heating, we read that the interior temperature of his apiary was raised as the outer temperature decreased. During the intense cold weather the outer entrances of the hives were closed. His colonies both in the heated apiary and those not heated have been free from dysentery. The bees in the upper stories suffered a little from thirst, as did also those that were not supplied with syrup in the autumn to make up their deficiency in provisions. These colonies were at once supplied with water, and the disease disappeared. The heating during the month of December required three hundredweight of coal and three hundredweight of coke. The bees consumed during the same month 1.9 pounds of food in the non-heated apiary, and 1.3 pounds in the heated apiary. Otto Bannesdorf treats of swarming in connexion with the movable-comb system, and demonstrates that it is prejudicial in hives with movable combs; the bee-keeper using such hives should not allow his bees to swarm, but,

on the contrary, he ought to provide room for his bees to store and to work, they will not then think of swarming.

2. *Zeitschrift für Bienenzucht*. First year. No. 1. The Editor, A. Alberti, is the inventor of a leaf hive (*Blatterstock*), and the author of a work on apiculture, which describes the management of bees in this hive. W. Ohly recommends giving bees water in winter, and more especially in the spring, by means of the Ziebolz bottle.

3. *Blätter für Bienenzucht*. Sixth year. No. 1. Editors, Kühne and Binder.—The latter describes a new competitor of sugar, *saccharine*, a chemical product derived from coal tar, which contains 280 times more saccharine matter than sugar. Thus, for example, in sweetening a certain quantity of water with one gramme of saccharine, to arrive at the same degree of sweetness with sugar it would require 280 grammes of the latter. Only saccharine does not possess any nutritive qualities, and can, therefore, not serve as food—either for man or bees. These will not even touch it.

4. *Oesterreich-Ungar. Bienenzeitung*. Fourteenth year. No. 2. Editor, P. C. Schachinger.—This number contains an account of a voyage made by Father Schachinger in Italy, Egypt, and Syria. He gives interesting descriptions of bee-keeping in these countries, and also a description of an apiary in a cloister near Rome. He also calls attention to a number of bees, carved, chiselled, and cast, which are found in the interior of St. Peter's at Rome, dating back to Pope Urban VIII., who completed this fine church. These bees are found on hisescutcheon, which is attached to different parts of the church. Schachinger thinks the movable-comb system should not be recommended to poor peasants, but they should be assisted to cultivate bees in skeps in a rational way. To subdue bees Hippauf recommends a spray of water, administered by means of a spray-producer, instead of smoke.

5. *Ungarische Biene*. Nineteenth year. No. 1. Editor, Grand.—François Hill treats on parthenogenesis. Reiter describes the agave (*Agave Americana*), a plant whose origin is Mexico, cultivated with us in greenhouses. Planted out in the borders in summer, the flower produces such a quantity of honey that it is always covered with bees.

6. *Der Bienenater aus Böhmen*. Seventeenth year. No. 1. Editor, Schusser.—Diseases of bees in winter. As such are described, diarrhoea, want of water and air. Hives wintered in good condition are exempt from these.—In No. 2. F. Gut has a long article on heating hives in winter. Brother Zeno, from a convent of Trappists, in South Africa, gives a description of the bee of that country. The South African bee is a little smaller and darker than the German bee, and easily supports great heat, the sole condition being that the hives are placed in the shade. Generally speaking, they are very quiet, but during the principal honey harvest, and on the approach of a storm, the

bee-keeper must be on his guard, for they then become veritable furies.

7. *Der Deutsche Inker aus Böhmen.* Editor, Böhm.—C. J. H. Gravenhorst describes a simple method of inducing activity in a colony. As soon as the bee-keeper notices that a hive is not very active he removes two frames of capped brood and replaces them by two similar frames from a vigorous hive. Junginger has noticed that after having pounded and rubbed honey in a porcelain basin for an hour the aroma became much more distinct and the flavour more delicate, making it more suitable for medical purposes. This would lead one to suppose that nature had neutralised the medicinal properties in honey (possibly through the formic acid), and that it is by the electricity produced by friction that these properties become more efficacious.

(To be continued.)

Notices to Correspondents and Inquirers.

Letters or queries asking for addresses of manufacturers of correspondents, or where appliances can be purchased, or replies giving such information, can only be inserted as advertisements. The space devoted to letters, queries, and replies, is meant for the general good of bee-keepers, and not for advertisements. We wish our Correspondents to bear in mind that, as it is necessary for us to go to press in advance of the date of issue, queries cannot always be replied to in the issue immediately following the receipt of their communication. All queries forwarded will be attended to, and those only of personal interest will be answered in this column.

R. DE B. SAUNDERSON.—*Chilled Brood in Hive.*

—1. Remove the dead brood as soon as possible. The remedy for chilled brood is to have the hives well filled with bees, and to keep the brood as warm as possible, especially avoiding exposing it to the cold. It does not necessarily 'eventuate in foul brood,' but it creates just the condition favourable for the propagation of that disease.

T. GAVIN JONES.—Comb sent contains only food and pollen, but the bees show signs of dysentery.

JOHN DOYLE (co. Wexford).—If the sections are intended for sale, separators should be used. Otherwise their use is quite optional. Two-inch sections are most saleable.

A NOVICE (Beckenham, Kent).—*Beeswax from Syrup.*—1. Yes, bees will build combs when fed with sugar syrup just as they would if gathering honey in the natural way. 2. Dobbie's *Bee Pasturage*, price 1s., is the only book we know of entirely devoted to that subject.

J. H. P. (Camborne).—If both stocks are weak, and not making much headway, you had better unite them, preserving the best queen, and feeding regularly till honey comes in.

J. C.—The 'simplest and cheapest' super-clearer we know of is the cone-shaped one described in *B. J.* for August 28th, 1890.

LEICESTER.—Give supers when the hives are well filled with bees and honey is coming in, not before.

APIFUGE.

The Original and ONLY PERFECT Preventive against STINGING.

Quality Improved & Price Reduced.

In 1/- & 2/- Bottles; British postage 2d. extra. All orders must be accompanied by remittance. Special Terms to the Trade.

One Correspondent says:—'I have used it on removing a particularly irascible colony into a clean hive, with perfect success.'

Another says:—'I have kept bees for thirty years and have lately purchased a bottle of this wonderful stuff, and cannot persuade my bees to sting me do what I will with them.'

DARCY GRIMSHAW, Horsforth, Leeds.

Invaluable to Travellers Abroad as an Insectifuge.

PROTECT your FRUIT TREES and SEED BEDS.—Tanned Netting, 100 yards by 2 yards wide, 10s. 6d.; 50 yards by 4 yards wide, 10s. 6d.; 24 yards by 8 yards wide, 12s. P.O.O. or cheque to accompany order, made payable to L. WREN & SON, 139 High Street, Lowestoft. 2566

FOUL BROOD.

FORMIC ACID, packed, post free, with instructions, 3s. 6d. per lb. PHENOL (Cheshire's Cure), ditto, 1s. 2d. per oz. NAPHTHOL BETA, 1s. per packet, post free. Address H. H. LONDON, The Apiary, Higher Bebbington, Cheshire.

GLEANINGS IN BEE-CULTURE. Edited by A. I. ROOT.

Published Fortnightly. Post free, 5s. per annum.

J. HUCKLE, Kings Langley, Herts.

British Bee Journal and Bee-keepers' Record.

OFFICE:

17 KING WILLIAM STREET, STRAND, LONDON, W.C.

PURE CANE SUGARS.

For the accommodation of Bee-keepers, guaranteed Pure Cane Sugar will be supplied in large or small quantities through this office at the under-mentioned rates:—

CRYSTALLISED.

4. DEMERARA	} Neat bags, 14-lbs. 28-lbs. 56-lbs. Cwts.			
5. BARBADOS		Crystals 2/9	5/4	10/6
6. TRINIDAD				20/6

REFINED CANE.

7. WHITE CRYSTALS (Small)	3/0	5/10	11/6	22/6
8, 9. (Medium and Large sizes, 1/- per Cwt. extra.)				
10. LUMP (Cut Loaf) ... Boxes, 3/3	6/3	12/3	23/6	
11. LUMP DUST ...	3/0	6/0	11/9	22/9

All above guaranteed made from CANE SUGAR only, and free from BEET, CHEMICALS, etc., etc.

CARRIAGE PAID on Orders over 5/0 (or 28-lbs. Sugar) to London and Suburbs.

COUNTRY ORDERS, not less than 2-cwt. carriage paid at 1/0 per cwt. extra.

(Scotch and Irish orders, special arrangements.)

Cash to be sent with order, and purchasers will please observe that if samples are required or replies asked to inquiries, a stamped addressed envelope must be sent, as we cannot undertake cost of postage.

THE British Bee Journal,

BEE-KEEPERS' RECORD AND ADVISER.

No. 467. Vol. XIX. N. S. 75.]

JUNE 4, 1891.

[Published Weekly.]

Editorial, Notices, &c.

USEFUL HINTS.

WEATHER.—At length it would appear as if the weather had settled down into normal condition, for we have had a whole week of sunny days, varied only with an occasional gentle shower of what felt very like *warm* rain—a very welcome change for bee-keepers, for farmers, and it may be said for the whole of the dwellers in the land. Surely we shall have no further outbreaks of wild storm for some time to come, seeing that sunny June is now with us, and all the bad weather that could come *has* come, and after doing its very worst has quieted down, fairly worn out and exhausted, let us hope.

STIMULATIVE FEEDING.—It is late in the day to allude to this subject. A correspondent, however, writes as to the principle involved in the stimulation of a stock kept in by bad weather. 'Can,' he says, 'the dribble of syrup allowed the bees for the purpose of stimulating them, be *too* small so long as it is absolutely continuous? Or, put in another way, judging from your own experience of feeding-bottles, if it were possible to supply the said stock with *less* than the amount given down by *one hole*, but *quite continuously* day and night for weeks, would it answer the purpose as well?' To the above very pertinent query there can be but one reply, viz., feeding, to be stimulative, must be *felt* by the bulk of the bees, and to reduce the quantity given to microscopic proportions would make this impossible. A pint of syrup should last nine days, and if the taking of it down can be so regulated as to occupy the bees for the whole period, we should call that the perfection of stimulative feeding. No doubt, if an ordinary wide-mouthed bottle can be covered with a cotton or woollen material, so thick that the syrup could only be licked from its slightly moist surface by the bees, it would be a

more perfect form of stimulative feeding than taking it through one hole of a regulating feeder. We have covered bottles with such a material, which has answered well when using thin syrup, but it is a matter requiring some trial and a little trouble in arranging. At the same time, if about 20 ozs. be accepted as a proper quantity for seven days' stimulative feeding, it must be understood that the bees have other food in store, and not that it is taken as sufficient for the daily supply of a strong stock with no other food to depend on, and brood-rearing in full swing.

USING NAPHTHALINE.—We must give a word of caution regarding the use of this substance in hives, in consequence of some mischief wrought by a correspondent among his bees by the excessive use of a very impure form of the product. In the proper kind for use with bees as a disinfectant the crystals are *pure white*. In that used by our correspondent they are dark grey in colour, and very offensive in smell—the kind, in fact, used by gas-fitters in their work. In the case referred to, instead of a pinch of the purer kind sprinkled on the floor-board of the affected hive, two teaspoonfuls of the impure sort were used, with the effect of causing the poor bees to desert their brood, almost suffocated by the fumes; and a good deal of chilled brood has resulted in the stocks so dealt with.

NAPHTHOL BETA.—Some uncertainty also exists in using Naphthol Beta, of which a large quantity has been sent to various readers the *B.J.* It should be distinctly understood that Naphthol Beta is for use in *bee-food*, not for sprinkling on floor-boards. For the latter purpose naphthaline, besides being far less costly, is the proper remedy, and as much of the crystals as will cover a sixpence is about the correct dose.

USING QUEEN-EXCLUDER.—Our preference for setting queen-excluding zinc close on the tops of frames above brood nests is referred to by a writer on p. 259, who object

to its being used so, because it 'at once blocks up half the perforation.' Now, in the first place, our correspondent's assertion is not quite correct, in so far as he does not start fair. Bees, to reach the excluder, must first pass up the half-inch space between each two combs: therefore the width of the top bar—which is what we suppose is referred to as 'stopping the perforations'—offers no hindrance whatever, because the bee passes through the perforation directly it reaches the top of the half-inch space between the frames. But that is not the point we lay stress on; we prefer the zinc close on the top bars—though it no doubt causes trouble in removing the propolis therefrom at the close of the season—in order to accomplish the end aimed at by Dr. Tinker, and referred to on p. 248 of last week's *B. J.* by Mr. Woodley. The wood-zinc excluder, illustrated in Dr. Tinker's catalogue, has evidently been designed expressly to meet what we have for years contended for, viz., 'that the bees may be enabled to run up the edges of the wood through the holes in the zinc.' If the metal is laid flat on the top bars they can so run, but if the perforations are raised a quarter-inch above, naturally the bee must reach up to the opening and hoist itself through—an acrobatic performance highly objectionable to a tired and heavily laden bee, as we think. But we consider that altogether too much stress is laid on the so-called disadvantages of blocking up or reducing the number of perforations in excluder zinc; there is practically no disadvantage at all—at least, we fail to discover any. If there is an opening for bees to pass every eighth of an inch along the whole space between the combs, what increase in this number of openings, we ask, would further help the bees?

MARRIAGE OF MR. JAMES ABBOTT.

Quite by accident we learn that the above well-known and esteemed bee-keeper was married on the 26th ult. The announcement in the *Standard* runs thus:—

'May 26th, at St. John's Church, Southall, James Andrews Abbott, of 9 Merchants' Quay, Dublin, eldest son of Mr. Charles Nash Abbott, of Fairlawn, Southall, Middlesex, to Mary Anne, eldest daughter of Mr. William Price, of Annesborough, Robertstown, county Kildare, Ireland.'

Few bee-keepers were more actively engaged in the work of publicly furthering and teaching the 'art of modern bee-keeping,' a few years ago, than Mr. James Abbott (or 'Jim' Abbott,

as he would insist on being designated by his friends), and we know of no one more deservedly popular. By his modest and genial bearing he was—and we hope still is—a favourite everywhere, and it has been a mystery to us how so good a fellow managed to remain a bachelor for so long; and now that a 'daughter of Erin' has removed that 'fault' from his character, we are sure that his troop of friends who are readers of the *Bee Journal* in congratulating him will cordially wish long life and happiness to James Abbott and his good wife.

WEATHER REPORT.

WESTBOURNE, SUSSEX.—May, 1891.

Maximum .. 78° on 13th.	Rain:—2.13 in.
Minimum .. 29° on 17th.	Heaviest fall, .43 in.
Min. on grass 23° on 17th.	on 17th.
Frosty nights	2. Rain on 17 days.
Mean maximum .. 55.6°.	Average, 2.52 in.
Mean minimum .. 41.4°.	Sunshine:—209.4 h.
Mean temperature 48.8°.	Brightest day, 31st.
	13.35.
	Sunless days, 3.

The bees have made very little progress the past month. There have as yet (June 1st) been no swarms in this neighbourhood.—L. B. BIRKETT.

Bee Shows to Come.

June 10th, 11th.—Wilts Association at Malmesbury. W. E. Birkitt, Hon. Sec.

June 18th, 19th.—North-East Agricultural Society at Belfast. G. Gerald Bingham, Esq., J.P., Waring Street.

June 22nd to 26th.—Royal Agricultural Society at Doncaster. Entries closed.

July 2nd.—Kent Association in conjunction with the Rose and Horticultural Society at Farningham, Kent. Entries close June 27th. Jesse Garratt, Hon. Sec., Meopham, Kent.

July 15th, 16th.—Armagh. Mr. E. Best, Armagh.

DEATH OF 'A RENFREWSHIRE BEE-KEEPER.'

Just before going to press we learn with deep regret of the death, on the 23th ult., of Mr. John M. McPhedran, better known to our readers as 'A Renfrewshire Bee-keeper.' The deceased gentleman was a few years ago one of the foremost bee-keepers of the day, and numerous articles from his pen will be found in former volumes of the *B. B. J.* He was a warm advocate of the Stewarton system, and very successful himself with hives of that type. The last contribution from Mr. McPhedran's pen in our columns was the biography of Mr. John Love, which appeared in the number for January 22nd of this year.

Correspondence.

The Editors do not hold themselves responsible for the opinions expressed by correspondents. No notice will be taken of anonymous communications, and correspondents are requested to write on one side of the paper only, and give their real names and addresses, not necessarily for publication, but as a guarantee of good faith. Illustrations should be drawn on separate pieces of paper.

Communications relating to the literary department, reports of Associations, Shows, Meetings, Echoes, Queries, Books for Review, &c., must be addressed only to "The Editors of the 'British Bee Journal,'" 17 King William Street, Strand, London, W.C." All business communications relating to Advertisements, &c., must be addressed to Mr. J. HUCKLE, Kings Langley, Herts (see 1st page of Advertisements).

* * * In order to facilitate reference, Correspondents, when speaking of any letter or query previously inserted, will oblige by mentioning the number of the letter, as well as the page on which it appears.

NOTES ON BEE-KEEPING IN HUNTS.

[667.] Bees are having a quiet time here. We had a few warm days in February, which I took advantage of, and got through a good deal of uniting and other necessary work in the beegarden. Since then we have had an almost unbroken continuation of bitter cold weather, and my bees have remained practically undisturbed. I have kept them warm and well supplied with candy, which they appear to be very fond of, and do remarkably well on. I was a long time before I succeeded in making candy of the right consistency; I invariably got it too hard. I have a lot of recipes for candy-making, all of which state that the candy should be soft; but to get it soft enough without having it too soft requires a certain amount of art, which can only be achieved by practice. It was not until I had spoilt several lots of sugar that I succeeded in making a candy that would fully answer to the description given in the recipes referred to. Candy-making is, like most other things, very easy when you know how to do it, and properly made candy is, in my opinion, the best bee-food as a substitute for natural stores that can possibly be obtained; to supply twenty or thirty stocks with sufficient to last two or three weeks is only a matter of a few minutes' work—a very great consideration where time is an object. When pollen is being freely gathered syrup is no doubt preferable, but I have long since discarded the regulating feeder, except for feeding swarms. When I find it necessary to give a stock syrup I put on a pint or a quart, according to circumstances, overnight, and invariably find the bottle empty in the morning—a process which, with me, at all events, has always produced far better results than the slow feeder.

We had a few warm days at the early part of the present month, and the bees had a busy time amongst the fruit-blossom, which I never saw in greater abundance. The weather for a few days was so delightful that it made one think that winter had passed, and that summer had commenced in real earnest; but it was not so—cold north-east winds were soon again prevalent, with rain, snow, and frost. On the night of the 17th inst. it commenced snowing

at nine o'clock, and continued without a break up to eight o'clock next morning—Whit Monday. A good deal of the snow melted as it came down; nevertheless the ground was covered with it four inches deep in the open, and everything bore the appearance of mid-winter during greater part of the day. It was not until quite night that the whole of the snow had disappeared, leaving everything in a very wet state, which was followed by a sharp frost—ice a quarter of an inch thick. Fears were entertained that the whole of the fruit-blossom would be destroyed; but so plentiful was the blossom of all descriptions, that if one out of every ten escaped, the prospects of an abundance of fruit are still good.

Bee-keepers in this district are not in a very cheerful mood just now; several who have been in the habit of keeping half-a-dozen hives find their stocks reduced to one. Larger bee-keepers have had very heavy losses, from twenty to fifty per cent. of autumn count. For my own part, I see no cause for despair; stocks that have been well cared for are making rapid progress, and should we be favoured with a few weeks of really good weather between now and the 1st of August, the results would enable us to forget the bad honey season of last year and the heavy winter losses that followed.—A SHARP, *Huntingdon, May 29th.*

APICULTURAL MEMS.

[668.] *May 27th.*—I am in bed under the influence of the 'hinhphlenza.' Bees around here have wintered extremely well, and are in first-class order. I have only heard of one lot perishing, and I lost a small lot which I omitted to unite.

Quite a commotion was caused here on May 6th, owing to a swarm trying to enter an already tenanted hive of the 'Doctor's.' They, however, met with a warm reception, and most of them were slaughtered. Mrs. H. was, however, on their track, and on entering the Doctor's garden was advised by him to 'go and sort 'em out and take her own home.' This was considered a great joke. I found in the evening that the swarm (?) was a queenless lot that had decamped, leaving an empty house behind.

The weather here has been bad, about on a par with the winter. The first ten days of May were fine, and the bees gathered a surplus from fruit-blossoms. On May 12th the heat here was intense; since May 16th nothing but cold winds and storms of snow, hail, and rain. May 28–29th, fair, showers.

Will not Mr. McNally (663) give us his experience of 'Self-hivers?' My bees are a mile distant, and I should like to try them if a success. I would advise your querist (357, page 251) to use 'Take Notice' labels, as advised in Mr. Cowan's *Guide-book*. I have used them for five years, and my customers now prefer granulated honey to any other.

I have never seen any mention of keeping a 'Diary' of the 'Flora' in one's own district—

viz., time of flowering, comparison of season, *i.e.*, early or late. I have kept such a one for three years past, and I find it of great use for guidance as to the management of my stocks, time of doubling (if necessary), and also most interesting. This, of course, is in addition to my diary relating to the condition of each stock.

In conclusion, I find my 'Blacks' have done best during the past two years, and last year were the only ones that gave any surplus, which was given to my other stocks, and I have them to thank for saving me the trouble of feeding up for the winter. Will some of your correspondents kindly inform me where I can get some 'Take Notice' labels? I applied to Abbott Brothers last year, but was informed they had none in stock.—COLTRIP GILBERT, *School House, Stratton St. Margaret, Swindon.*

EARLY SECTIONS.

[669.] I took off the first completed sections this season in this neighbourhood on Monday, May 18th, for a member of the Essex B.K.A. Had the fine weather of a week prior to that date but lasted a few days longer fruit-bloom would have yielded a good surplus.—J. W. SHEPPARD, *District Secretary, Woodford.*

[Messrs. Hutchings Brothers, St. Mary Cray, Kent, also report having removed finished sections of fine colour on the 30th May.—Eds.]

TRANSFERRING TO CLEAN HIVES INDOORS.

[670.] Weather about same here as elsewhere: so bad, indeed, that when I transferred three or four colonies in April into clean hives there was not an atom of brood in any one of them. Breeding had been going on two months before, as I saw some in February. It may have been unwise to open hives at that early date, and the mention of this causes me to allude to the plan of transferring stocks to clean hives at night indoors, which I have successfully practised. We often want to overhaul and set in order a stock that has been reduced considerably in numbers, so as to fix them up in a contracted hive and give them a few of the best combs for starting breeding on. Any kind of outhouse will answer for the job, and, with a good lamp, and the place made fairly warm beforehand, no difficulty will occur. Prepare the clean hive ready, and let it have a hot brick inside to warm it. Carry the hive to be transferred into the place, shut the door, and stop the hive entrance with a wisp of grass; remove in the usual way the outside comb, on which there will be no bees, set in the clean hive, after removing the hot brick, which is then set on top of quilts. Lift out all the combs covered by bees and set them alongside the first one. If brood is seen don't stop to look for queen, and when all the bees are removed leave out all the empty frames, and at once cover down with

the quilts; give a cake of softy candy and wrap up warmly. I have always been thrown backwards in this kind of work through the difficulty of doing it outside and in bad weather. Though a bee-keeper for some years, I had no idea this work could be done so easily indoors, with scarcely any disturbance to the bees, and I particularly recommend it to amateurs.—J. W. BLANKLEY, *Grantham, Lincs.*

BEEES FIGHTING.

[671.] You do not agree with your correspondent, 'Augustus' (461, p. 231) as to bees fighting. I can quite agree with him, and my experience proves beyond all doubt, to my mind, that, under certain circumstances, bees will fight among themselves. There is no readier method of making them do so than by giving them combs dripping with honey, especially if the bees get smeared all over with the honey. If a dripping comb be inserted between the other combs of the hive, when the bees get the honey on their wings and legs they appear to lose their tempers, and a rumpus begins, which takes a lot of stopping.

As soon as 'Augustus' found the bees were killing each other, he should have opened the hive, dusted the bees with flour, and covered up again quickly. Nothing will beat this treatment for stopping a riot.—T. W. Y., *Draycott, May 18th, 1891.*

[We must beg leave to differ from the views expressed by our correspondent, and to maintain the opinion expressed on page 231. As to dripping combs causing the bees of a hive to begin 'fighting among themselves,' we have given many thousands of such combs to bees to be cleared up after extracting, and have never seen any approach to a 'riot' caused thereby.—Eds.]

A NATIONAL HONEY SHOW.

[672.] Noticing your comments in *B.B.J.* of April 23rd, with reference to having a national show at the London Dairy Show this next autumn, I would suggest that the contest be for *one single jar or section, or both.* In having these entries would, I am certain, be very numerous, and it should also be distinctly understood that all honey sent would be forfeited to the B.B.K.A. I trust you will further ventilate the subject in *B.B.J.*, notifying those who intend to compete for champion honours to prepare for the battle.—J. D. McNALLY.

[Our correspondent is wrong in his inference, as we have heard of no intention on the part of the B.B.K.A. to make the event referred to a 'national honey show.' To do so, and make the exhibition at all worthy of so pretentious a title, would involve considerable effort, to say nothing of the creation of a special fund for covering the expense, and so far nothing in this direction has been even mooted at the B.B.K.A. meetings. At the same time bee-keepers may themselves make the honey competition at the Dairy Show as 'national' as

they please by staging exhibits from various parts of the kingdom, and we shall be very pleased to see a good entry of honey thereat. We cannot agree with the suggestion of our correspondent that the competition should be restricted to a single one-pound section, or a single one-pound jar of extracted honey, unless it included *both*. Take, for instance, an entry of 150 single one-pound sections of comb honey; among these would probably be a dozen or more so nearly equal that it would be 'past the wit of man' to choose between them. If this were so, where would the 'championship' honours come in? As well might lots be drawn amongst the best exhibits as to which should be dubbed 'champion.' If, however, the class consisted of one section and one jar of extracted honey (or, better still, two of each), the competition would be a much more legitimate one, and in consequence yield more satisfactory results.—Eds.]

CANE SUGAR.

[673.] Bees still in winter quarters and not yet overcrowded. Only two short days' work this year so far, besides bits and snatches. I am afraid pollen is getting scarce. I have been confined to the house for over a month and shall be for some time yet (influenza), and can only get a man who is frightened of bees to feed them very irregularly. The weather here at this date is cold and raw, with rain-squalls. On Whit Sunday it snowed all day.

My grocer assures me there is no such thing as pure cane granulated sugar at the present time; the so-called is only part cane. The sugar he recommends is that in seven-pound bags, known as preserving sugar, at 11. 4s. per cwt. of him. There is a printed guarantee on the bag and a printed paper within declaring it pure and free from chemicals.—ALPHA, *Stanford, May 26th.*

[We must ask you to accept our statement regarding pure cane sugar as perfectly accurate, even at the risk of differing from your grocer. The sugar supplied through this office is pure cane, and we guarantee it to be so.—Eds.]

QUEEN-EXCLUDER ZINC.

[674.] Before last year I used this on every hive I had, but was somewhat shaken in mind through seeing so many leading bee-keepers speaking of it as unnecessary. So I went back again to using it only below extracting supers. But, oh! the sections I got! Well, 'never more for me.' I have got an excluder for every hive now. But I cannot see, with Mr. 'Useful Hints,' *re* laying it flat on top of frames, which at once blocks up above half of the perforations. This, to my mind, is 'going back.' With strong stocks, a few ready-built combs in sections, and warm wraps, there is no trouble with me in getting bees upstairs, provided always honey is coming in.—J. W. BLANKLEY, *Grantham, Lincolnshire.*

[Our correspondent's comments are referred to in 'Useful Hints' on p. 255.—Eds.]

THE MALAGASY BEE (*Apis UNICOLOR*):

ITS HABITS, ENEMIES, AND CULTURE.

(Continued from page 251.)

Apis unicolor is much more gentle when handled than *Apis mellifera*, and, like the Carniolan bee, which has been introduced into England from south-western Austria, can be managed easily without the need of smoke or veil; yet this is not always the case, for I have known some colonies much more fierce than others. Two of my hives I could never open without a lighted cigar in my mouth, though they would allow me to do anything I liked with them *with* that accompaniment. I have even taken a cluster of bees from some hives with my bare hand, and have thus cleared the combs with impunity; and, when cutting out comb from a native hive, the bees always seem to be much more intent on saving the honey spilt than on attacking the intruder. It is a well-known fact that if a bee is smoked it immediately fills itself with honey, and when gorged is much less inclined to sting than at other times; but in the case of the cigar it was otherwise, for I seldom used it to smoke the bees, but merely held it between my lips; possibly they recognised their master by the smell. One might imagine that such gentleness was the outcome of long intercourse with man, but, considering in how very few places the honey-bee is 'cultivated' in Madagascar, and how very great a percentage of them are wild, or come directly from wild stock, this can scarcely be the reason; more especially when we remember that the English bee has been 'cultivated' to a very much greater extent and yet is the more savage of the two. It may be that the Malagasy bee, never having had to contend against the larger enemies, such as the bear, has less inclination to use its sting against man; but it is much more likely to be simply a difference of temperament, often noticeable in wasps as well as in the different varieties of *Apis*.

Another difference, which points to a less highly domesticated state, is the great difficulty of hiving the swarms. In England you take your swarm, throw it gently down in front of the hive you wish the bees to enter, and they immediately run in and take possession. In Madagascar, if you do the same, you will be woefully disappointed; they will run in and perhaps stay there an hour, sometimes even a day, sometimes not five minutes, and then find out it is not to their liking. Tempt them with comb filled with brood—a temptation which rarely fails in England—and they will not look at it. Confine the queen by force, and if it be a 'cast' they will soon forsake her, to die of hunger. Confine an old queen, and they will occasionally stay, but even should she have begun to lay, and you enlarge the opening, there is every chance she will lead out the swarm and leave her progeny to die.

If left to themselves, they will choose the

most inhospitable-looking places, and, unlike the English bee, seem indifferent as to the comb being exposed to view or not. I have seen a swarm in half an old clay cooking-pot with the bottom knocked out, and it was not from any love of an old home, for there was not above an inch of comb formed, and that had no brood or even eggs in it. I have seen another in the middle of a low palm-tree entirely exposed, but this was unusual.* Heat or damp seem to have but little effect on them, for I have not unfrequently seen hives with an inch of water in the bottom, and the side combs full as well, yet the bees were working hard, and were to all appearance in no way inconvenienced; yet this must have happened every week, if not more frequently, during the rainy season.

When the Malagasy wish to increase the number of their hives, they place several of the hollowed tree-trunks they use for that purpose in the neighbourhood of a wild colony in the forest. As soon as this throws off a swarm, it usually takes to one of the many convenient places put in readiness, and thus a new colony is started; then the trunk is taken to the village. But sometimes, in taking a wild nest, they catch the queen and amputate a wing, so as to render flight impossible; they then place her in a hive, which they fix as nearly as possible in the position of the nest destroyed, and the bees cluster round her.

Owing to the difference of climate, these bees will rear a colony from a very much smaller beginning than is possible in England, where sufficient bees must be bred to ensure a high temperature during the winter as well as an abundance of food, for in Madagascar the temperature is seldom, if ever, low enough to kill the bees, or even to render the queen unfertile—a not unfrequent event in England. I once saw a swarm here—the whole of it, comb, bees and all, would have gone into a tumbler—it was quite exposed to the wind and sometimes to the rain, yet the bees were working quite happily, and the queen was fertile. I took it and placed it in what I considered a most comfortable bar-framed hive, with combs worked out ready for them; next day they left it. I found them on a tree near, and put them back, confining the queen and giving them young brood; they took no notice of the brood till it was dead, and they then sucked the juices out of the larvæ and began to clear the comb. A few days afterwards, when they had begun to gather pollen, I enlarged the entrance, and they swarmed again. I happened to find them, and put them back once more, confining the queen. She soon began to lay, and they increased quickly; seeing there was every chance of the little community working itself up, and having no further interest in that direction, I thought I would help them, so I added about 500 bees from another hive;

there was very little fighting, and the newcomers soon clustered on to the comb. Next day they all swarmed, leaving only about twenty bees in the hive, and I never saw them again. The few remaining bees set about rearing a new queen from an egg of the last, but they died out before she became perfect.

There is another peculiarity about these bees when throwing a cast: the casts will often leave the hive and cluster, but after about half an hour will return to the hive. At first I naturally supposed it was owing to the queen not having joined them; but as it occurred frequently, often twice in an afternoon, I began to doubt if such were the case, so I examined the cluster and found the queen with it. Thinking they would not then return, I put them into a new hive, and they seemed inclined to stay, as it was already evening; but early next morning they joined the old hive, and swarmed again the next afternoon, when they once more returned. I then put the queen in a bar-framed hive, leaving only sufficient space for the egress of the workers: they, however, forsook the queen, and she herself made every effort to follow them, rushing about the hive as if distracted and seizing the woodwork in her mandibles. A very few of the workers stayed with her, and one or two from outside joined her, but eventually they too left. This was a virgin queen, but I hope to be able to try the experiment with an old queen leading the first swarm.

I have stated that these bees continue to store honey during the winter months. This is not altogether in accordance with Huber's idea that honey is not to be found during long protracted heat, cold showers, or a north wind,* for the two former conditions are those normal to a winter in the forest in Madagascar, the natural haunt of the bee, and yet honey is stored. In Imerina the winter is as a rule very dry, only a cold drizzle every now and again, barely sufficient to wet the ground. This continues from May to October, yet honey is almost continuously stored. So great is the flow that often large combs are built and filled, yet, curiously, the honey is scarcely palatable, being extremely bitter, probably owing to some winter-flowering shrub, perhaps the *Seva* (*Buddleia madagascariensis*, L.), or the *Tsiüfakömby* (*Cesalpinia sepiaria*, Roxb.).† It is also very thick, almost gelatinous, and of an oily appearance. I have never yet seen honey at all poisonous in Madagascar, though it varies very much in flavour and in quality, nor have I ever heard of people being at all inconvenienced by eating large quantities of new honey.

As regards the bees themselves, they differ slightly in size, according to the age of the comb in which they were reared; those from old combs are smaller, owing to the cells being

* The Malay bee (*Apis dorsata*) builds its comb hanging from the branches. *Apis dorsata* is, as it were, at the third great terminus of migration.

* *Natural History of Bees*, by F. Huber; translator's preface, p. xviii.

† The peach honey, gathered about the same time, has a bitter flavour.

partially filled up by the old silk cocoons left in them. I have sometimes wondered if it were possible to increase the size of the workers by *very gradually* increasing the size of the foundation cells given to them.

I have sometimes fancied that I have noticed a difference in colour among the bees, but I imagine it is only from the difference in size, the larger naturally looking lighter. I have also carefully examined bees from different places on the coast, and from the central provinces, but can detect no difference whatever, either in size or colouring.

These bees work in all weathers. In England a cloud passing over will often send all the bees in the fields hurrying home; whereas the Malagasy bee will take no notice, even should rain begin to fall. This is noticed among the different varieties now established in England: the Cyprian bee being extremely cautious about flying in heavy winds, yet both it and the Italian bee work earlier and later than the English one. But it is marvellous in what weather the Malagasy bee will continue to work. I have seen them both entering and *leaving* the hive during a heavy thunderstorm, when I should have thought it impossible for them to fly twenty yards without being beaten down, the wind at the same time being very strong. Any ordinary rain seems not to affect them in the least, and I have seen them rushing in and out of their hives—what the natives call ‘playing’—a habit they have when breeding freely, during the heaviest rain. When the day is rainy and the bees heavily laden, they often fall near the hive, but are seldom if ever chilled, as in England, but after resting a short time they reach the hive.

I have several reasons for thinking that the death-rate among these bees is not so great as among the English. Many trustworthy writers in England state that the average life of a worker during the summer months is from about six to eight weeks—in winter, as there is no work to be done, it is much longer—yet several colonies which I have left queenless during the height of summer have usually lasted from four to six months. Again, they seem to diminish much less rapidly than the English when the breeding stops; however, as I have stated, this is seldom the case, and naturally there is not so much work done in a queenless hive as in one with a fertile queen.

The *enemies* of the Malagasy bee are not so numerous as in other countries, especially tropical countries, and what there are are common to the English. I have never heard of any bird enemies, or of any indigenous mammal that attacks them; though no doubt there may be, if more were known of the forest mammalia. The Norwegian brown rat, which is fast spreading over the island and driving the light-grey native rat before it, is very destructive to bees, eating through the native wooden hive and stealing the comb. Insects, however, are their chief enemies.

(To be continued.)

Review.

Webster's International Dictionary of the English Language. Revised and enlarged under the supervision of Noah Porter, D.D., LL.D. (London: George Bell & Sons.)—This is an entirely new edition of this standard work, and is the most complete revision that the work has undergone during the sixty-two years that it has been before the public. It contains 2118 pages, or 200 more than the last revision, and nearly 4000 illustrations, about two-thirds of which have been specially done for this edition. A superficial comparison with the last edition will show to what an extent the revision has been carried, for almost every page has been treated as though the book was entirely rewritten. The work of revision was commenced ten years ago, and 100 paid editorial assistants have been engaged upon it, besides many other learned men who have, in various ways, contributed to the work. The various definitions have been supplied by specialists of eminence. Many errors existing in the former edition have been eliminated, and it is certainly made more valuable by the addition of new material, to make room for which certain condensations have been made, which we think very much improve the work. To make room for the increased number of words the page has been enlarged and the number of pages increased. In addition to the dictionary of words, their pronunciation, etymology, and meaning, illustrated by quotations and 3500 woodcuts, there are several valuable appendices, comprising a gazetteer of the world, vocabularies of Scripture, Greek, Latin, and English proper names, and several others, including a biographical dictionary with 10,000 names. New and recently coined scientific and other words are not forgotten, and in this respect the dictionary will be a great help to the reader, as such words now abound in every publication of the day. It is compact, being in one volume, and cheap enough, so that it should find a place on the bookshelf of every household.

Queries and Replies.

[359.] Having purchased two stocks of bees this spring, I notice one stock is continually bringing out dead brood, which for the greater part are larvæ or grubs, quite white, wet, and heavy, although some are young bees which have almost reached maturity. These latter appear to be dead until warmed, when they are seen to have life in them. I have enclosed a few as a sample. I have lost hundreds in this manner during the last fortnight, and being only a beginner this spring, I should feel greatly obliged if you would reply in your journal.—CHAS. BRADLEY, *Church Road, Tottenham.*

REPLY.—Food should be given to the bees without delay, and continued until the natural

supply can be had from the outside. White mutilated larvæ, thrown out as described, are a sure sign of scarcity of stores.

Echoes from the Hives.

Thurton Walton, Norfolk, May 19th, 1891.—Bees here have stood the winter well, and are in splendid condition. The crab-apple, pears, and hawthorn show plenty of blossom; I do not remember ever seeing such an abundance of bloom before. I hope we shall get some of the hot weather prophesied by 'X-Tractor.'—BE THANKFUL.

Oak Apiary, Great Yeldham, Essex, May 17th.—I have not noticed many early swarms yet, so wish to say I had a good fourth swarm from a skep on May 13th.—JAMES HARDY.

Grantham, Lincolnshire, May 21st.—The bright sunny weather we have had for ten days, which has put new life in both bees and bee-keepers, has taken a sudden change, and whilst I write it snows. It was something wonderful for the 18th of May to see the hedges, trees, and ground nearly an inch thick with snow, looking like Christmas again. On the 14th and 15th it was very hot here, the glass marking 185 degrees and 207 degrees in sun, 80 degrees in shade; 18th, every appearance of a sharp frost; 19th, seven degrees of frost; 20th, five degrees of frost: this morning, 21st, eleven degrees. All early potatoes cut down. Change for better during to-day—bright and warm.—J. W. BLANKLEY.

Rawcliffe, near Selby, Yorks, May 29th.—A late season in this neighbourhood; bees only getting to work these last few days. No drones seen as yet. Weather warmer, but nothing to gather from except fruit-bloom.—R. S.

Hawkhurst, Kent, May 30th.—Glorious weather come at last! Two good bee-days together! And how needful is this welcome change, for on the 28th and 29th one of my stocks was bringing out drones, and I found over twenty on the ground in front of one stock. Although they had been gently fed during the last three weeks of bad weather, they are very short of stores, where three weeks ago they seemed to have plenty. I am not alone, for two neighbouring bee-keepers have had drones brought out this week, although they were feeding. Since then I have given about three-quarters of a pound of syrup a-day, and shall continue if weather is unsettled. I hear of several sceptical old skeppists that have lost their bees lately through starvation, but there are not many skeppists here now, thanks to the teachings of the Association. Queen-wasps are most numerous.—JOHN COLLINS.

East Lincolnshire, May 30th.—The bees with us, with few exceptions, came through the late severe winter anything but favourably, whether in skeps or bar-frame hives, and are now mostly weak in numbers. Some are in fair condition

and ready for the honey-flow, but they are few and far between. There has been a great drain on their stores recently, and not a few have died from starvation—one gentleman, a large bee-keeper, having lost some in that way, he not liking to examine them in the late cold weather, thinking they were well provided with stores; but not seeing them flying as usual one of the recent few fine days, he examined and found them dead, with four frames of brood—a painful sight; and several skeppists I fear will be in the same plight, as they will not feed their bees. My own stocks are, as a rule, weak, but it is wonderful how they have progressed lately. My driven bees have done badly so far, and are very weak, while usually they have been among my strongest stocks at this time. The late rain has done great good to the clover and meadow-fields, which look promising. Bees to-day hard at work on sycamore and apple-blossom.—E. L.

Mount Pleasant, near Tenby, May 30th.—To-day I had a four-pound swarm from a cast of 1890 (hived in a tub) which I purchased last November. In addition to the honey it had previously stored, I regularly fed on soft candy made from white granulated sugar. The swarm was most conveniently located on a currant-bush near by. My other stocks are in straw skeps, and preparing to swarm. Notwithstanding this place is wholly exposed to the elements, the little creatures have come well through the long and severe winter, and I have hardly seen thirty dead ones all the while. Flowers are fairly abundant, and the gorse is a mass of bloom.

OUR LIBRARY TABLE.

Since our last review of books quite a number have accumulated on 'our library table.' The first of which we have to notice is

Langstroth on the Hive and Honey Bee, revised, enlarged and completed by Chas. Dadant & Son: published by Kegan Paul, Trench, Trübner & Co., London. This is a revised edition of that issued in 1889, and has had a few alterations made, which bring it up to the times. Little need be said of this well-known book, which is recognised as a standard work on the subject. Originally written by Langstroth, it has been considerably enlarged and revised, and this having been done by such practical and successful bee-keepers as Messrs. Dadant & Son is a sufficient guarantee that the information is reliable in every respect. The book is profusely illustrated, well printed, and written in paragraph form, each paragraph being numbered, and when reference in one part of the book is made to another, the number of paragraph is quoted in brackets. It is a book that should find a place on the book-shelf of every bee-keeper.

L. L. Langstroth. L'Abeille et la Ruche: ouvrage traduit, revu et complété, par Charles Dadant. Genève: Librairie R. Burckhardt. 7 fr. 50 c.—This is a French translation of the above work. When we say translation we do not mean a literal translation, for several

alterations, additions, and omissions have been made in order to bring it more in conformity with, and make it more applicable to, European bee-keeping. The work has been considerable, and Mr. Dadant expresses his indebtedness to our friend M. Bertrand, who has not faltered in the task he undertook of revising and correcting the manuscript and proofs, and superintending the publishing of it. Mr. Dadant says if the reader finds some interest in reading and studying this book he must give some credit to M. Bertrand, for without his disinterested assistance so generously offered, its publication would have been indefinitely put off, possibly for ever. Fortunately for French bee-keepers M. Bertrand did not recoil from this work, and the result is that this valuable work is at their disposal as well as of those who read only the English edition. There are several improvements in the French edition; for instance, all that is taken from the original book of Langstroth is in brackets, so that the reader can at a glance see what is Langstroth's and what to attribute to Dadant. Extracts from other works are in smaller type, and great care is taken to acknowledge all the sources. Some of the illustrations are also improved, and as a frontispiece there is a capital autotype portrait of Langstroth; and in the body of the work, besides engraved portraits of the leading bee-keepers in Europe and America, there are autotype portraits of Bertrand and Layens. European apiaries are also illustrated, and the most recent remedies for foul brood are given, such as treatment with Naphthol Beta. Altogether the work is a valuable addition to our bee literature, and even those who have the edition in English, and are acquainted with the French language, would find much fresh matter in this work to interest them.

Répertoire de l'Apiculteur Fixiste et Mobiliste. Par J. B. Voirnot, à Villers-sous-Prény, par Pagny-sur-Moselle. 1 fr. 50 c.—A little of everything will be found in this little book. A few pages are devoted to a brief history of the contents of the beehive; then comes a monthly calendar of operations, a blank page for notes being given to each month. There are a number of illustrations, to which, however, no reference appears to be made; short articles on various subjects, practical, humorous, and instructive, as well as a few recipes and some verses. M. Voirnot propounds his theories in several articles, and there are others by such well-known bee-keepers as M. Dadant on 'Bee-keeping in the United States,' and M. Denler gives a review of German periodicals similar to the articles that appear from his pen in the *B. B. J.* M. Guillon writes about bee-keeping in England in very complimentary terms. This gives some idea of the variety of subjects treated of, and putting on one side the theories, with some of which we cannot agree, this little book contains much that is practical and instructive, and is one that can be taken up for recreation when a few minutes are at liberty.

Passeka petrovskoi selskoi-hoziaistvennoi aka-

demiei. By P. Kuleshoff and N. Petroff.—This pamphlet contains a report of the Petrowsky Agricultural Academy in Russia. M. Kuleshoff is Professor of Agriculture at the Academy, and in this report gives the results of his experiments in bee-keeping. A summary is given of bee-keeping according to English and American methods, and it is shown that the results obtained by hives such as we use are superior to those of the German pattern. After two years' trial M. Kuleshoff gives the preference to Root's chaff hive as more suitable to the cold climate of Russia. The pamphlet is well written, but, being in Russian, it would be of little use to the majority of our readers.

Roukovoditel Angliiskaro Ptschetovoda. By T. W. Cowan. Translated by A. de Zoubaroff St. Petersburg.—Another Russian book, being a second edition, and a translation from the tenth English edition of the *British Bee-keepers' Guide-book*. Bee-keeping is making rapid progress in Russia, and it is very satisfactory to find that English methods are found to succeed in that country, and that a second edition of this book has been so soon called for.

Thos. Wm. Cowan's Führer des Englischen Bienenzüchters. Translated by Tony Kellen. Braunschweig: published by Schwetschke & Sons. 2 marks.—This is a German translation of the *British Bee-keepers' Guide-book* from the tenth English edition. It is well got up, with an introductory preface by the translator. Much prejudice exists in Germany against English methods, which it is hoped this book will be the means of removing.

Thirty Years among the Bees, by Henry Alley, Salem, Mass. (50 cents), is a book of seventy pages, giving the author's experience of queen-raising as practised at his apiary. It contains much useful information.

Notices to Correspondents and Inquirers.

Letters or queries asking for addresses of manufacturers or correspondents, or where appliances can be purchased, or replies giving such information, can only be inserted as advertisements. The space devoted to letters, queries, and replies, is meant for the general good of bee-keepers, and not for advertisements.

LUTON.—*Ants in Hives.*—There are several methods of preventing ants from entering hives—perhaps we should say hive roofs, for they rarely enter the brood nest of a hive. 1. Set the legs of stands in vessels of water. 2. Wrap tarred cord round each leg. 3. Make a broad chalk line round each leg a few inches above the ground. 4. A piece of rag kept damp with paraffin or carbolic acid—in fact, any strong odour—they will not face, and it only needs renewal to make any of the above remedies effective. Ants may also be trapped by soaking a piece of sponge in sweetened water, and when squeezed out set it in their haunts. They will enter the sponge and be unable to get out: drop it into hot water and their dead bodies will be easily washed out of the sponge.

G. G. DRAKE.—Skeps nearly always yield a second swarm in from eight to twelve days after the issue of first or 'top swarm.' Nine days is the usual interval if weather conditions are favourable. Sometimes a third swarm, or 'cast,' will issue a day or so after the second; but you may ascertain if there is a probability of this latter event by listening if 'piping' is continued on the evening of the day on which the second swarm came out—if it is, look out for a third swarm next day.

DUSKY (Stirlingshire).—*Vagaries of Bees.*—There is little analogy between your case and the one you refer to, though one is as difficult to comprehend as the other. For bees to roll out in a ball with a queen in their midst; for the bees then to return into the hive, leaving the queen to fly off and be seen no more, is an experience in regard to bees altogether new to us. You ask if we, or any of our readers, can account for the following:—'A ball of bees, fifty or sixty strong, was seen rolling on the alighting-board, and on inspection a large queen was seen with them. The bees re-entered the hive shortly, leaving the queen walking about on the alighting-board. Presently out comes another ball of bees, with a drone this time, the bees leaving him to re-enter the hive as before. The drone took wing, and a minute later the queen followed in the same direction, neither queen nor drone being seen again, though watch was kept for some time.' Candidly, we cannot say why the bees acted as above—can 'any of our readers?'

CHARLES POOLE (Brighton).—Comb sent is badly affected with foul brood. No matter how strong the stock is, as you say, it can make no headway against the disease with combs in the hive like that sent. Since you ask our opinion as to 'the best course to pursue' with so had a case, we should say shake the bees into an empty skep, tie them up, and keep them in a dark place indoors for a couple of days, while you burn the combs, frames, and contents. Then disinfect the hive with sulphur fumes or some other powerful disinfectant; fit it with new frames and full sheets of foundation. Return the bees, and feed with medicated syrup. The alternative plan would be to burn the hive, bees, and combs.

C. H. CUTLING (Derby).—Bees, when clustered on combs, frequently pass the food from one to another.

A. E. W. (Aylesford).—Queen sent is a young one.

E. F. S. (Uplands, co. Wicklow).—When white grubs are carried out, it is a sign of want of food.

NINA (Cornwall).—No doubt the wasps you killed were queens. They always attempt to sting when being killed.

Q.—Of the samples sent, we think No. 1 is entirely beet, and that No. 2 is part cane sugar, but mainly beet.

APIFUGE.

The Original and ONLY PERFECT Preventive against STINGING.

Quality Improved & Price Reduced.

In 1/- & 2/- Bottles; British postage 2d. extra. All orders must be accompanied by remittance.

Special Terms to the Trade.

One Correspondent says:—'I have used it on removing a particularly irascible colony into a clean hive, with perfect success.'

Another says:—'I have kept bees for thirty years and have lately purchased a bottle of this wonderful stuff, and cannot persuade my bees to sting me do what I will with them.'

DARCY GRIMSHAW, Horsforth, Leeds.

Invaluable to Travellers Abroad as an Insectifuge.

'PERFECTION' QUEEN-EXCLUDING ZINC.

THOMAS B. BLOW begs to announce that he is sole Wholesale Agent for HARVEY & Co.'s New Pattern QUEEN-EXCLUDING ZINC. This particular perforation is absolutely perfect for its purpose, and is an exact reproduction of one of the patterns known as

DR. TINKER'S QUEEN-EXCLUDING ZINC.

Purchasers are cautioned to be careful to observe that they get zinc with the exactly correct width of perforation (which this is), as much of the zinc at present on offer is either too large or too small—thus either letting the queen pass through or excluding the worker-bees.

For retail prices see Catalogue, sent free on application. Special quotations, according to quantity, will be given to dealers.

THOMAS B. BLOW,
MANUFACTURER OF BEE-KEEPING APPLIANCES
WELWYN, HERTS.

PROTECT your FRUIT TREES and SEED BEDS.—Tanned Netting, 100 yards by 2 yards wide, 10s. 6d.; 50 yards by 4 yards wide, 10s. 6d.; 24 yards by 8 yards wide, 12s. P.O.O. or cheque to accompany order, made payable to L. WREN & SON, 139 High Street, Lowestoft. 2566

Yorkshire Agricultural Society.

Patron: H. R. H. THE PRINCE OF WALES, K.G.
President: S. CUNLIFFE LISTER, Esq.

THE FIFTY-FOURTH GREAT ANNUAL SHOW

Will be held at BRADFORD,

ON THE

5th, 6th, and 7th of AUGUST, 1891,

When Prizes amounting to £3190

WILL BE OFFERED FOR

CATTLE, SHEEP, PIGS, HORSES, SHOEING, BEE APPLIANCES, BUTTER, AND DAIRYING.

The Entry Closes on Saturday, 27th of June.

Prize Lists and Forms of Entry for Stock and Implements will be forwarded on application to

MARSHALL STEPHENSON,
York, May 23rd, 1891. Secretary. 240

THE
British Bee Journal,
BEE-KEEPERS' RECORD AND ADVISER.

No. 468. Vol. XIX. N.S. 76.]

JUNE 11, 1891.

[Published Weekly.]

Editorial, Notices, &c.

**BATH AND WEST OF ENGLAND
AGRICULTURAL SOCIETY'S SHOW
AT BATH.**

The annual show of the above Society opened in beautiful weather at Bath on the 3rd, and was continued till the 8th inst. The programme of the five days' proceedings offers so many attractions to the general public at these meetings that, given fine weather, a large attendance invariably results, and it is matter for regret to bee-keepers that the early date on which the show is usually held seriously interferes with the display in the bee and honey department. This season, when everything has been so backward, and honey-storing has scarcely begun, it had the effect of entirely limiting the display of honey to last year's produce, and consequently very much reduced the number of exhibits staged in this division. Only one of the five honey classes could be considered as at all representative, viz., Class 9, for granulated honey in jars. Nine exhibitors competed in this class, and some really good samples were staged, the majority being so evenly balanced in quality that it took some considerable time to decide fairly on their respective merits. So many of the ordinary guiding points are absent when the honey under consideration is old and granulated, that the usual conditions of 'judging' are entirely altered, and it illustrates the care with which the awards were made when it was afterwards discovered that with samples so nearly equal in quality all three prizes had gone to the same exhibitor. The other honey classes call for no special comment, except regret that the lateness of the season made it impossible for intending competitors to put in an appearance.

Appliances.—Class 1, *Best collection of bee-appliances*, was not well filled, consequently Messrs. George Neighbour & Sons easily carried off the first prize. Their collection, however, would have been difficult to beat, for after a close examination of every article staged, we failed to discover a single faulty one. The second prize went to Mr. C. Overton.—Class 2, *Best observatory hive stocked with bees*. Messrs. Neighbour were again placed first with a very fine stock of Ligurians, and Mr. Overton also again took second with a smaller lot of Carniolans.—Class 3, *Best and most complete hive for general use*. Seven competitors ex-

hibited in this class, and the same number in Class 4, for the *most complete and inexpensive hive for cottager's use*, but in neither class could the competition in any sense be considered a keen one, seeing that about one-half the hives staged had faults so conspicuously the result of careless workmanship, that it would have been absurd not to pass them over as practically disqualified in a prize competition. One would think that some appliance dealers were either lamentably ignorant as to the requirements of a workable hive, or imagined that judges were very easily satisfied indeed if they supposed that such glaring faults would be overlooked or condoned. What excuse, we ask, is there for a manufacturer or dealer who stages a hive wherein there is an inch and a half space to which the bees have free access at one side of the surplus chamber? Can it be supposed for a moment that the bees will not fill that space up with comb and honey? Or where is the sense of sending a hive for judicial criticism with three-eighths of an inch top bars to the frames and dummies, the said frames being fitted with cast metal ends, while the dummies have no ends on them at all, thus leaving an opening of one-eighth of an inch wide along both sides of the surplus chamber when the latter was in position on the frames?

Again, a sheet of queen-excluder zinc is framed in wood so thick as to leave the bee-space (?) above the top bars so deep that a bee preparing to mount into the chamber overhead would be like a man trying to touch the ceiling of a room with his hands! Several hives also had such imperfect supering arrangements that it was impossible to prevent the escape of both warmth and bees from the brood chamber when section racks were on. Transparent faults like these—so easily remedied, too—disqualify an exhibit, and it is well that exhibitors should be told of the fact if they are so ill-informed as not to be aware of it themselves. We make these comments in the true interests of dealers as well as of bee-keepers, because badly constructed hives bring untold discomfort and annoyances to the bee-keeper using such, and tend to discourage, if not to disgust, him with the pursuit.

Having said this much it is an agreeable relief to turn to the more satisfactory side of the appliance classes, and refer to those exhibits which were efficient and well built, as hives should be.

The first-prize hive was a model of accurate machine-made joinery, so true in cut and finish

that all its movable parts—roof, lifts, outer case, frames, &c.—worked beautifully smooth and easy. The roof, also, while light, was strong and about as water-tight as a roof could be, which is saying a great deal. The only fault we discovered in it was the legs being fastened to the floor-board. A separate stand would to our mind have been an improvement. Both first and second prizes were awarded to hives of the same type, *i.e.*, with loose outer case and free air-space between it and the hive proper; but the second-prize hive was built of heavier timber, and was consequently not nearly so handy in use as the other.

In Class 4, the seven exhibits were priced respectively 19s. 6d., 13s., 10s. 6d., 12s., 10s. 6d., 14s. 6d., and 6s. 6d. These prices hardly reach one ideal of a cottager's hive, 19s. 6d. and 14s. 6d. being almost prohibitory to a man of that class. We do not say the hives staged were dear at the prices affixed, but too much 'completeness' was aimed at.

Class 5—*best feeder*. Here was shown a novelty in the shape of a 'rapid' and 'slow' feeder combined in one. This exhibit was awarded first prize, and we hope, later on, to give a fuller description of it. The second prize was given to a regulating feeder of the Raynor type.

The remaining class (11, for novelties) only brought two exhibits, and a third prize was given to a super-clearer, clearly an adaptation of the American article known as the Dibern bee-escape.

LIST OF AWARDS.

Appliances.

Class 1. Best collection of hives and appliances.—1st prize, George Neighbour & Sons; 2nd, C. T. Overton.

Class 2. Best observatory hive, stocked with bees and queen.—1st, George Neighbour & Sons; 2nd, C. T. Overton.

Class 3. Best and most complete frame hive for general use.—1st, George Neighbour & Sons; 2nd, C. T. Overton.

Class 4. Most complete and inexpensive frame hive for cottager's use, unpainted.—1st, George Neighbour & Sons; 2nd, J. Trebble.

Class 5. Best feeder.—1st, W. Perkins; 2nd, George Neighbour & Sons.

Honey.

Class 6. Best twelve 1-lb. sections of comb honey.—1st, not awarded; 2nd, Rev. W. Bancks; 3rd, E. Hancox.

Class 7. Best six 1-lb. sections of comb honey.—1st and 2nd, not awarded; 3rd, C. T. Overton.

Class 8. Best twelve 1-lb. jars of run or extracted honey (not granulated).—1st, not awarded; 2nd, S. Agg.

Class 9. Best exhibit of granulated honey in jars, not exceeding 1 lb. each, the gross weight to approximate 6 lbs.—1st, Captain Ord; 2nd, Captain Ord; 3rd, Captain Ord.

Class 10. Best and most attractive display of

honey, in any form, not less than 56 lbs. gross weight. 1st, not awarded; 2nd, C. T. Overton.

Miscellaneous.

Class 11. Most interesting and instructive exhibit of any kind connected with bee-culture.—1st and 2nd, not awarded; 3rd, T. A. Flood.

DEVELOPMENT IN THE HONEY-BEE.

By R. A. H. GRIMSHAW.

(Continued from page 210.)

At this point it seems proper, when considering the mingling of varieties, to say something regarding what may be the birthground of the German brown bee, for it is not indigenous to this country.

At the commencement of this article we took it for granted that many of our readers would hold to the belief that most living things were created somewhere about the tropic of Cancer, (or, at least, within 2000 miles of the equator), according to the narrative inferences of the Old Testament; and that from a very circumscribed area all things were distributed to people the earth—northwards and southwards, eastwards and westwards. Following this distribution we accompanied the honey-bee, in imagination, down the Nile to Egypt, the home of the writer of Genesis, northwards and eastwards into Asia Minor. Stopped by the Caucasian mountains it was supposed to travel westwards, crossing the Dardanelles into Europe, leaving a branch of its species to develop for ages in *Cyprus*, in the valleys of the mountain ranges capped by Olympus.

A descent into Greece, and a spread into the islands of the Archipelago would be easy, aided in all probability by man, the hereditary honey-stealer. On the north the Balkan mountains would divert the emigration westwards into Servia and Bosnia, along the coast and amongst the islands of the Adriatic, until the high lands of *Carniola* again turned the stream westwards over the plains of Lombardy, until the well-known province of *Liguria* is reached, when the Alpine chain effectually stops further natural migration. It will be easily called to mind how surely and steadily the bee has developed, and, so to speak, perfected distinctly characteristic varieties in those regions (*Cyprus*, Greece, *Carniola*, and *Liguria*), where they have been compelled by natural barriers to suspend their migratory instincts and interbreed, until, in long periods of time, these variations, slight at first, appear to us in well-developed, clear marks, absolutely fixed sports from the type of the *Apis mellifica* of the equator, or of the neighbourhood of the Euphrates valley. Whatever the writer personally believes on the subject of the original home of our honey-bee is of little importance, but, as stated in an early chapter, the evident course of the Mediterranean bee seems distinctly to point to the neighbourhood in which we are told our first parents were created.

But, in common fairness to the students of geology, ancient botany, and zoology, we must tell quite a different tale when dealing with the supposed history of the German honey-bee. Supposing the earth in its earliest history to have been a mass of molten matter, revolving on its axis, we should expect it to be greatest in diameter (as is the case at this day) at the equator, and flattened at the poles. It would be in time surrounded by an envelope of gas given off by itself; oxygen and hydrogen would combine to form water (even if in a superheated form), oxygen and carbon would unite to form carbon dioxide (ultimate plant-food). Water and carbonic oxide, obeying the same laws then as now, would rise towards the outer edge of the gaseous covering, their places being taken by newly-formed compounds. Constantly driven upwards they would become condensed, and becoming colder could only reach their proper level in the gaseous strata by taking a northerly and southerly direction. Circulation then, as now, would be the result, the cooled gases would strike the regions of the poles, cooling them in their southern passages towards the equator, to be again superheated in a never-ending alternating cycle. Where, then, is the surface of the earth to be first so much cooled that a film of fire-formed rock may be termed, very appropriately, its crust? If we look at the amount of dry land on the globe (in the proportion of a square mile of land to three of water) we shall notice a great predominance of the dry land in the Arctic and sub-Arctic regions. In cooling there was necessarily contraction, and as the liquid matter gradually occupied less and less space its hardening envelope must perforce have become wrinkled into folds, which would in time overlap each other and spread gradually southwards from the north pole, forming the veritable flooring of the earth. The configuration of the northern hemisphere, the leaf upon leaf history of geological strata, tell us this was the case. If we examine the deposits of limestone, they tell us that, at least since life first appeared on the earth, the poles have been where they are at present, so that any disturbances must have been fractional and of little moment.

Again, if we take note of the overlapping of the skin-like covering strata, we find them in circles and parts of circles, having the present poles as their centres; and, coming nearer to the subject of this article, when vegetable life, with its accompanying insect myriads, was luxuriant on the cooled surface of dry land, when water was condensed and collected over at least three parts of the whole globe surface, when what we term the coal measures were growing and being deposited in layers of varying thickness, according to the suitability of the plant surroundings, we find, again, in digging them up for fuel, that they were gradually spread from the north. Leaving the almost entirely green vegetation of coal formations, advancing in the scale of the plant kingdom until coloured flowers were developed, with their accompanying and all-necessary in-

sect clouds (all these being varied to suit their surrounding conditions), we can trace those richest and most plentiful back to a home originating within the present polar circle. If we seek amongst fossil plants, we have the conviction forced upon us that the oldest, most extensive, richest discoveries are in the regions of Greenland, Labrador, and to the north of Newfoundland. What we now consider tropical and subtropical vegetation travelled southwards as the more southerly land became fitted for its reception, and as the land in the neighbourhood of the north pole became cooler. Suitable forms of life were developed and forced on the skirts of their predecessors, this process being continued until vast ice-sheets forced all animals and plants southwards, until the heat of the sun and the radiation from the earth formed a temperate region, perhaps not far in latitude from our own Mediterranean, beyond which the ice-cap might not travel. At the edge of this ice-sheet would be found representatives of plants and animals now classified as the Arctic flora and fauna, and amongst these rich and most suitable surroundings I should expect to find the German honey-bee, always found as a migrant northwards and upwards to the verge of snow and ice.

When we investigate the flora of Great Britain we are driven to the conclusion that in the post-glacial period, when the ice-fields retreated northwards and left the earth warmer again, they were followed northwards by Arctic and sub-Arctic flora and fauna, these being followed up by plants, insects, and other animals luxuriating in a temperate climate. A northerly and north-westerly migration would thus flow back over France, Germany, and Britain, joined together as they were by land only now slightly submerged by the German Ocean. If we examine our present flora, we find it consisting principally of plants which have come from Eastern Europe, following the retreat of the glacial ice-fields. Amongst the vast sheets of nectar-yielding plants, never having voyaged south of the Alps, we should, without doubt, find our brown honey-bee, a true descendant of northern climes, bearing all the characteristics of northern hardihood, like the frost-resisting plants it loves to feed on, fighting in retreat with them inch by inch, and returning with them, as at the present time, aggressive on the margin of frost and snow. In fine, when dealing with the ancestry of our bee, I can come to no other conclusion in my own mind than that it is a true lineal descendant of the first honey-bee ever existing in the northern hemisphere, of which family there has been an immense contingent, void of such vigour as would enable it to fight along with the rearguard of animal life, driven further south with its food-plants, but following again the subsequent northern attack, until arrested by peninsulas and mountain-chains, at which barriers they have sported and developed.

(To be continued.)

HONEY IMPORTS.

The total value of honey imported into the United Kingdom during the month of May, 1891, was 6070*l.*—From a return furnished by the Statistical Office, H.M. Customs.

THE MALAGASY BEE (*APIS UNICOLOR*):

ITS HABITS, ENEMIES, AND CULTURE.

(Continued from page 261.)

The wax-moth may generally be seen in the neighbourhood of the hive, into which it dodges, with remarkable skill and presence of mind, past the sentry bees, who, as soon as they have recovered from their astonishment, turn and chase the intruder. But when once in, it is not easily dislodged, running swiftly about the sides of the hive until it finds some shelter, and, as opportunity offers, laying its eggs among the *débris*. Here they hatch out, and the grub, protecting itself with a silken cocoon in the form of a pipe, eats its way through comb and brood with impunity. They, however, do little or no harm in a strong colony, confining themselves, or rather, being confined by the bees, to the *débris* alone. Possibly they may even do good, for they eat up the particles of wax that are too small for the bees to clear away. Weak or queenless hives they destroy in a very short time. I have never seen a hive without them.

Ants, again, are more troublesome, perhaps, than dangerous. They hang about the hives, forming their nests in or about the sides, or under the bark that is used as a shelter, and do the work of scavengers. Any bee which is sick unto death will of its own accord leave the hive, to be immediately seized upon by the ants. Bees are very cleanly insects; they do not allow dead bodies to remain in the hive, and as a rule carry them to a considerable distance before they drop them; yet during the massacre of the drones there are many left near the hive, for they are too heavy and large to carry away—so in cases of that sort the ant is a help; but it likes honey immensely, and is always trying to thieve. To prevent this the bees have recourse to a very ingenious method. As soon as an ant—it is only the small species that rob—appears on the alighting-board, a sentry bee runs up to it. The ant is too small and nimble to be seized by the bee's mandibles; so by turning its head and raising its abdomen, the bee brings its wings into a proper position, and with one buzz and a sharp twist round to the right, the ant is sent flying into space. Should there be many, the process is repeated, first to the right, then to the left, and so on, until the board is cleared.

The greatest enemy of all is the death's-head moth, *Sphinx atropos*, which is very common. In the evening, should you watch a hive, you will soon hear a sound as of distant thunder, and then a rush. A huge moth hovers for a

second over the hive and then alights. Without fear or hesitation he pushes his way to the entrance. If the bees are strong and not accustomed to being robbed, they will give battle, crowding on to the moth's back in a mass, and striving to lay hold of his slippery fur or sharp-spined legs. With one flutter of his large wings he sends his despised opponents hither and thither, and slowly enters. The guards have no power to stop his huge frame, for sting they cannot, they can get no grip, and their stings cannot pierce that tough, soft skin, but merely slip along it harmlessly. As soon as he is within, he keeps his wings vibrating with a low humming noise, and leisurely sucks his fill—a very big fill. Then he rests lazily, hanging from one of the combs, utterly heedless of the weight of bees that cluster over him. The bees, too, have learnt their powerlessness and attempt no more to dislodge him. How long he stays I know not—sometimes a fortnight, and sometimes only a short time, but the damage he does is immense, and in any other climate would be fatal. I have known a hive sucked dry during six months of summer weather, and not so much as a drop of honey to be found in it, although a very strong colony, and upwards of two hundred bees a minute leaving and returning. All this immense harvest has been taken day after day. From that hive alone I took ten moths in one fortnight. I left them to test Huber's words, where he says that the bees themselves will close the entrance. Mine did not; they closed a few places, but obstinately left a large one open, and when I closed it for them with wax they opened it again. This hive had quite given up resisting, and the moths walked in and out as if the place belonged to them; but I often took a moth from it and placed it on the alighting-board of another hive, and in ten seconds it was one black mass of bees; sometimes more than a thousand bees at once clustered upon it, but they could never kill it. I killed one and put it on the board; this they tore to pieces, as of course it could not vibrate its wings, but though so many bees were trying to sting it, not a sting entered until it was torn piecemeal. I repeated this experiment often, but with the same result, no sting piercing the intact skin.

Another thing I noticed was, that the moth never used its peculiar squeaking noise to effect an entrance. It has been repeatedly affirmed by European writers* that the noise of this moth enables it to subdue the bees; and the reason given is, that it is the same noise as that made by the queen-bee when approaching the queen-cells with the intention of destroying them. As long as she is silent the bees prevent her doing so, but directly she emits the noise they all give way, putting their heads down and remaining as if paralysed. Now, though the noise to human ears seems the same, yet I have no hesitation in saying that the bees recognise the difference, and pay no respect to the

* Huber: preface, *Circle of the Sciences*, p. 144.

moth when emitting the sound; if there is any difference, they attack it with greater force. I have tried over and over again, and have watched very many moths, both when entering the hive and when actually inside, and in no one case did I hear the sound emitted, but the moth evidently knew that the bees were powerless to hinder it. However, wishing to know if the bees could be subdued by the noise, I caught a moth and held it gently between my finger and thumb, thrusting it among the bees. As is its custom, it began squeaking under the restraint; but the bees flew to the attack and crowded on to it, quite disregarding my hand, but intent on the moth. I then took another and made it squeak on the alighting-board; the bees at once rushed out to give battle. These experiments I have repeated at least a score of times, with the same results. In every case, as soon as the moth was released from my fingers it stopped the squeaking, although it was still surrounded by the bees.

The queen-bee and the *Sphinx atropos* are not the only insects which emit the same sound; there is another Malagasy *Sphinx* which does it, and also a hymenopterous wingless insect very common here. The reason for it, or the means by which they do it, are, I believe still unknown. The larva of the *Sphinx atropos* emits a similar noise, but yet slightly different. When doing so it sits in the position which gives rise to its name of *Sphinx*, with its head raised, and works its anterior pair of pro-legs, as if mandibles. I have, on several occasions, found old battered specimens of the moth dead in the hive, but whether killed by the bees, or whether having died from natural causes, I do not know.

There is another thing, perhaps, worth mentioning about this moth, and that is, its larvæ feed for the most part on the potato-plant, both here and in Europe. Now, considering that the potato is an introduced plant in both places, it is very curious that such exclusive feeders as the larvæ of moths should change their diet—and that, too, in widely different regions—to a non-indigenous plant. The native plant they feed on is a vetch, and as different to the potato as one can well imagine, both as to appearance and the texture of the leaf; yet one finds only about one in ten on the native plant. I have tried them on tomato, and on many of the native nightshades, but they prefer dying to eating what is evidently unclean to them. I have heard people, who ought to know better, say that the larvæ of butterflies and moths eat the leaves of the shrub on which the perfect insect laid its eggs, and once having begun on that, will not change. The absurdity of such a statement is obvious to any one who has bred caterpillars to any extent, or who has watched the habits of the imago. Besides, why should the moth choose the potato? While I am digressing I might add that another *Sphinx* caterpillar feeds on arum, fuchsia, vine, and balsam, and refuses all else, the native wild balsam being its indigenous food.

(To be concluded next week.)

Correspondence.

The Editors do not hold themselves responsible for the opinions expressed by correspondents. No notice will be taken of anonymous communications, and correspondents are requested to write on one side of the paper only, and give their real names and addresses, not necessarily for publication, but as a guarantee of good faith. Illustrations should be drawn on separate pieces of paper.

Communications relating to the literary department, reports of Associations, Shows, Meetings, Echoes, Queries, Books for Review, &c., must be addressed only to 'The Editors of the "British Bee Journal," 17 King William Street, Strand, London, W.C.' All business communications relating to Advertisements, &c., must be addressed to Mr. J. HUCKLE, Kings Langley, Herts (see 1st page of Advertisements.)

COUNTRY VISITORS—NOTES IN THE COUNTRY.

[675.] One lives, it is true, to learn, but one also lives to unlearn. Something that may suit Somerset will not, perhaps, suit the inhabitants of Essex. Cicero (Tully, as he was called, curiously enough, half a century ago) tells us that among the pleasures of age is the fact that it is always increasing its stock of knowledge. He refers to the boast of Solon, that every day he added to the store he had already gathered. And no doubt it is important to keep the mind fresh and young, by *studium et industria*, to the very end of life. Still, as I have said, it is necessary sometimes to unlearn as well as learn. Let me illustrate my meaning by a recent experience.

My hives, bought at various times, have usually had some kind of slide in front, running in a narrow wooden cover outside, so that the opening could be enlarged or diminished as desired. These slides, 'cabined, cribbed, confined' in this wooden covering, were often unwilling to 'move on' when required, so bloated had they become in a moist climate and in wet weather. So I had them all, together with the covering, taken away. Blocks of wood, on the American plan, were substituted. Now I am in a worse plight than before! The blocks of wood are constantly knocked out of position. The hives are often almost closed at night, yet the doors are opened wider than ever in the morning. Just as many children living in the country go off at eventide, first to feed their guinea-pigs, their pigeons, and other darlings, and then to shut them up for the night, so I go to the hives, and almost close the entrances, after a sunny day, against the cutting winds. (How strange, by-the-by, it is that the bees have not had *la grippe*, like our beloved 'X-Tractor,' after this long 'grim' winter and bitter spring!). Well, again and again these blocks of wood have been disturbed. Sometimes they have been actually knocked off the landing-stage! The gardener's boys, of course, were called to account. A boy is always a convenient creature in a garden. Everything that goes wrong, every ruddy strawberry, blushing rose, Hesperian apple, or golden pear that is missed, can be charged to him! But what infatuation could lead a country lad—imagination is not

usually a leading feature of their lives—to knock away these blocks of wood? I told the gardener that the wheelbarrows were evidently knocked against the hives, but he assured me they were not—‘The boys were not so fond of bees as all that.’

At length the secret was out. One evening, as I approached to discharge an almost daily duty, I observed a small four-legged creature that has a very keen scent and a great appreciation of sweets. He most joyously ran up the side of the hive—as nimbly, indeed, as a sailor runs up a rope ladder, or an Irish hodman a builder’s ladder. He was on the landing-stage in a moment, and at once began to disturb the entrance-doors. But now it was my turn, and I soon gave him notice to quit. Your readers will have guessed that this four-legged creature was a rat. He has taught me to unlearn, as well as to learn—that the old method, after all, is better than the new.

What a veritable problem these rats are to those who lead a country life! It is not every one who loves the country or can be happy in a country village. The *fallentis semita vitæ* is a path which one may not choose on one’s own account; yet, once chosen, it may be a very useful and a very pleasant path. If, then, you live in the country, and indulge in country tastes, you must face the great rat problem. These wretches, as evening approaches, sally forth from their hiding-places, like the ‘Bill Sykes’ and the ‘Artful Dodger’ of our large cities. Night after night the coachman mounts guard with his gun; a lady, too, may be seen armed with what looks, appropriately enough, like a *needle gun*. Still the cry is, ‘They come, they come!’ In the winter they enter the out-houses and too often manage to munch the combs and devour whatever wax they can reach. Wood will not keep anything securely. Poison is sometimes tried, but poison is double-edged, and may kill the wrong party. Others believe in cats. Formerly I detested them; now I love them. Cats love a house, a kitchen, a cushion, a fire, a haystack, a mouse; but a man or woman—never! Forgive me, fair reader! I don’t believe in a cat’s love. Why, then, do I love them?

Because they hate rats, and in many cases will keep the coast clear of them. Many a cat is more than a match for a rat; but here, again, I have had to unlearn. Every kitten but one, when four or five little blind beings arrived, was formerly consigned to a watery grave. The survival of the fittest was the universal law. Not so now! Each one is carefully kept, tenderly treated, gratefully fed. Yet all our efforts are in vain. Why? Because, if the truth is to be told, those who love the game don’t love cats.

A lady friend who is fond of bees, and who lives not far from a farmyard, tells me that her skeps were invaded by a number of mice on one occasion and were all destroyed. A rick had been threshed, the mice had been driven out, but not killed, so that, deprived of the bread, they betook themselves to the honey.

It is surprising how fond the bees in Essex are of human habitations. I have three settlements of bees in my own house. They are in a very inaccessible position, and give me no annoyance, except that I am forced to guard my hives most carefully against robbers. On the other hand, they assist in fertilising the fruit. It is all-important, in my opinion, to have bees close at hand if a good crop of fruit is to be assured. In such weather as we have had this spring bees won’t fly any great distance; but they will avail themselves of every opportunity to do their special work and gather their daily bread. Sitting recently as a guest at a farmer’s house—what jovial fellows many of these farmers are!—he told me that he had bees in the roof of his house, and his son assured me that his experience was the same. If the bees did not fertilise the clover, they had no clover seed to sell. Some of your readers may not know the story which our dear departed friend, George Raynor, used to tell about Kelvedon Church. He was curate of Kelvedon for a time. A swarm of bees settled in the porch of his church. So the country boys used to poke up the bees shortly before service-time. The effect may be imagined! Mr. Raynor’s aid was invoked, and the bees were removed.

In the parish next to me, a large tree, in which a colony of bees had long lived, has recently fallen. The guardian of our peace, the village policeman, an excellent bee-keeper, not afraid of men, boys, or bees, has cut out the log which forms their habitation and has taken them to his home.

It is pleasant to note the steady progress which bee-keeping is making. Vaseline seems to me to be the great discovery of later days. It appears an established fact that it checks propolisation. It is probably a safeguard against stings. This very morning, when my gardener and I were examining our supers (bees, by-the-by, were more plentiful than blackberries in autumn, or grapes in a cluster, but honey was as scarce as wisdom in infancy, or health in a hospital), I told him to ‘vaseline’ his hands as a prevention against bee-poison. We were not stung, it is true, but I am not about to argue that vaseline therefore is a perfect protection. Others, however, assert that it is, and I, for one, intend to give it a thorough trial. But in one respect, as it seems to me, there is still some room for improvement. We want a better feeder at a reasonable price. The Raynor, Blow, and other feeders are all, of course, good; but large, or even medium-sized bottles, are often inconvenient. They are awkward to cover, and require a high top. If, too (as has been the case with me this year), when the hives are crowded, and the supers are on, it is necessary from a change of weather to feed the bees, bottles on the top of supers are most inconvenient. Some persons may say, ‘Take off the supers.’ The game, I reply, is not worth the candle. The trouble is excessive. The east

wind, too, may be blowing. You suspect, perhaps, that influenza is *en route* to your residence. The holes, moreover, in the bottles sometimes become clogged. You think the bees are being fed, but they are not. I asked Debnam, the Essex expert, to send me the best feeder he knew. He sent me what I believe is called the Simmins' feeder. It is circular in form, but flat on the surface, about $2\frac{1}{2}$ inches high, and therefore does not require a high roof. The bees enter from the hive into the centre of the feeder, and take just as much as they can carry off. There is no system of holes, nor any graduated feeding; but frequent doses, easily administered, are probably as effectual. The cost, however, is serious. Two shillings for every feeder, besides the carriage, is more than a poor man can afford, and more than a careful man will give. A good, cheap feeder, in my opinion, is still a *desideratum*.—E. BARTRUM, D.D., *Wakes Colne Rectory, Essex.*

P.S.—Since writing the above, I have met my friend Mr. Fitch, the well-known bee-keeper of Sible Hedingham. He assures me that his bees as yet have gathered no stores. My gardener and I have vaselined our hands today, and our faith is confirmed.—E. B.

WHY BEES FIGHT AMONG THEMSELVES.

[676.] Referring to 641 (p. 231) and 671 (p. 258), I am inclined to differ from you all. A few years ago I was indebted to a bee-keeping friend for solving the problem of why bees fight among themselves or with their own fellow-workers. I believe that in nine cases out of ten it can be traced to the bees entering worn-out hives of one kind or another, such as the deserted home of a stray swarm which has lived for a season in the trunk of a tree or house-roof, and, succumbing to the rigours of winter, has left stores behind; or to weak or defunct hives in your own or neighbour's apiary.

Since my friend pointed out the cause to me, I have been able to trace fighting, in almost every case, to old combs. Here is a case in point:—My friend only ten days ago found the bees in one of his best hives slaughtering each other like a miniature 'Waterloo,' and, as a few hives belonging to a cottager were located about two hundred yards away, he at once guessed the true state of affairs, and going to the said hives, found his bees busy robbing a defunct hive, and as sure as they entered that hive and gorged themselves with the honey they were doomed; flying off with it, and alighting on the entrance-board of their own home, so sure were they met with their own kith and kin, to be hurled overboard and killed.

I have for years now formed a fixed conclusion ament bees fighting among themselves, and that is, if you allow your bees to enter hives containing old combs and honey, and carry away with them the odour peculiar to that

comb, you will have fighting. Dripping combs may be hung in reach of the bees without any bad effect. The danger exists only when the bee carries away with it the smell peculiar to the strange hive. I have no doubt in my mind that bees are known to one another by their scent only, and when that scent is destroyed or replaced by another, fighting begins. I have also seen fighting started by giving a comb of strong-smelling foundation: so sensitive are bees to odours.—CROFTAME.

NOTES BY THE WAY.

[677.] We have reached the greatest and best bee-month of the year, leafy June; would that I could say, also, sunny June. Instead of sunshine, so much needed to bring the flowers to perfection, we are getting dull, cold, sunless days, with a cold north-east wind, and a correspondingly low temperature. This retards the bees breeding so freely as under more favourable circumstances, and makes swarming late this year; in fact, at time of writing, I have not heard of any swarms except two or three that were 'rushed out,' so to speak, about the middle of May, when we had a few summer days, and the sycamore-trees were in full bloom. I hope to get a speedy change, as I have a number of swarms ordered, and have no doubt, if weather is suitable, I shall fill several ere this appears in print, as I have had drones flying for nearly a month past, showing that preparations are made by the bees for sending out new colonies as soon as the opportune weather arrives.

I have tried vaseline on the runners of some new hives when transferring some stocks to new hives, and find that the frames run very easily and with less irritation to the bees. This is especially noticeable where the hive is made to correct size, and the frames have become propolised underneath, making a 'tight fit' without the vaseline.

Self-hivers.—Now that we have reached the swarming season, will our brethren in the craft kindly give us their experience of self-hivers. There was a very simple form of self-hiving arrangement illustrated in the *American Bee Journal* lately, the invention of Mr. Alley, of queen-raising fame. The means of communication between the parent hive and the hive which was placed by the side of the parent hive to receive the swarm was by means of three oblong queen-excluders—or, should I say queen-includers? The first was constructed of ordinary excluder zinc, and placed at the entrance of the parent hive, then another similar placed at the entrance of the new hive, with holes at the top side, by the ends nearest together; then on the top of these queen-confiners was an oblong wire-cloth passage, with holes corresponding, and covering the holes near the top ends of the entrance excluders; the entrance and exit from the wire-cloth passage was formed cone-shape—this arrangement would prevent the return of the queen to the parent hive even if

she wished to do so, as the probabilities would be against her finding her way through the points of two wire cones. I have no doubt any of our leading appliance makers could make the passages according to Mr. Alley's directions and drawings in the *A. B. J.*, or possibly our editors could give us a drawing. To a busy man, or one whose business calls him away from home all day, or whose apiary is located at some distance from his home, the development of self-hivers will prove a boon. Then to the commercial bee-keeper, who runs out-apiaries—what a feeling of security against loss of valuable swarms will be engendered by knowing that the instinct of the bees will be allowed full play, and at the same time the swarms secured without the expense of hired help, on which one cannot always place full confidence! There is certainly the expense of these makeshift hives, many of which will not be wanted except for a short time during the summer months. But, just show our enterprising appliance manufacturers that there is a demand for makeshift hives that will take apart and stack in a small space during the winter, and you may depend the hives will be forthcoming to meet the requirements.

Our American brethren in the craft are beginning to find out some of the bitters of the 'McKinlay tariff.' The said 'Act' has saddled them with an import duty of twenty per cent. *ad valorem* on imported queen-bees, and the importation of queen-bees through the mails from Italy is prohibited by law, and if so imported, the sender would be liable to fine or seizure. Brother Jonathan is up in arms against the restrictions, and intends testing the law at an early date; possibly the loss to Italy may be a gain to us in this country if we have any queens to spare. Beeswax seems going up in price in all parts of the world, and consequently bee-keepers will have to pay more for their foundation. Is it the modern system of bee-keeping that restricts the production of beeswax, or is more of the commodity used than formerly? I am well aware that many tons of beeswax are in constant use in bar-frame hives, and this must make some difference; though what we put into the hive we take out again when we break up the colony, with very little, if any, loss, unless the moths riddle the combs before melting.—W. WOODLEY, *World's End, Newbury.*

BEEES FIGHTING.

[678.] I am pleased to see another correspondent, 'T. W. Y.' (671, p. 258), has come to the front in connexion with the above subject. I own—I frankly own—that had any other person told me that his bees had fought in a similar manner to mine I would have been very much inclined to regard the whole affair as a fairy tale. I hesitated for a time in writing to the *B. B. J.*, thinking readers might be inclined to doubt my accuracy and to regard 'Augustus' as rather an imaginative individual. But my own experiences do not at all coincide

with 'T. W. Y.'s,' for I have not only given stocks dripping frames to be cleared up after extraction (as our worthy Editors remark), but up till very lately regularly sprayed my bees over with their syrup when uniting in order to prevent fighting, and which I believe it did. Feeding as I did is by no means to be recommended, but in the case of 'T. W. Y.' it is quite the reverse, for if bees fight, or even have fought, under such circumstances it is much to be deplored, as I have always considered it an excellent plan, and attended with no risk whatsoever. But the Editors, I think, are rather inclined to doubt the whole affair, as per the footnotes, and it is certainly a very strong position to take up; but as my bees fought when the evening was advancing, and when no other stocks were astir, and as the havoc was done by night, not the remotest particle of doubt exists in my mind but that the bees of the same stock destroyed one another, and I will make bold to say that one and all of the bees which I sent our Editors for examination belonged to the same stock.

But we must congratulate ourselves that such disasters are few and far between—at least in my case, and I sincerely trust in that of 'T. W. Y.' Perhaps some other correspondents who have had similar experiences will come to the front and give their views on the matter; but if 'T. W. Y.'s' bees will vow never to repeat the same again I am quite sure we're both willing to let the Editors' opinion hold good in the meantime; but we are certain to be up in arms against them when our little favourites quarrel amongst themselves over cleaning up a few extracted frames. I beg to thank your correspondent for his kind hint, viz., dusting the bees over with flour. I think it would have done nicely under the circumstances.

Stocks are far behind in this district as compared with last season. I have not heard of any swarms here yet, though in Fife there have been a few; but I think swarming is the exception there, not the rule.—AUGUSTUS, *Renfrewshire.*

KILLING QUEEN-WASPS.

[679.] As there are a large number of queen-wasps this season, and the number that I killed in the spring among the wraps and roofs of the hives did not satisfy me, I have hit on a plan that is new to me for killing them—that is, by placing a few cakes of candy in convenient places about the apiary to attract the wasps' attention, and when the queens are busy feeding, press on them with the forefinger, or with a small stick. I beg to send you the number that I have killed the last few days in this way:—May 23rd, 1; 25th, 3; 26th, 3; 27th, 2; 28th, 3; 29th, 6; 30th, 2; 31st, 6; June 1st, 2; 2nd, 10; 3rd, 15. This will be 53 queen-wasps killed these last few days in my apiary, besides those found in the roofs of hives in the spring. I hope to kill a good number more yet.—W. W. PRYOR, *Welwyn, Herts, June 4th.*

WEATHER REPORT.

BUCKNALL, LINCOLNSHIRE. B.M. 25.

May, 1891.

Maximum, 76° on 12th. Rain:—2.78 inches.
 Minimum, 19° on 17th. Average, 5 years, 2.03.
 Mean max. 58.4° In 24 hrs. '50 on 24th.
 " min. 37.7° Rain on 18 days.
 " temp. 48.1° Frosty nights, 7.
 " of 5 years. .50.1° Range of temp. 20.7°

Remarks.—May has been cold. Bees quite a month behind. No swarms heard of in this neighbourhood yet. About two inches of rain so far in June.—J. BINT.

Queries and Replies.

[360.] *Doubling for Prevention of Swarming.*

—1. I have four very strong colonies of bees, and they look very like swarming. I propose to double the strongest one by taking two or three frames out of each of the others, and putting them into an empty hive and on to the top of the one to be doubled, and then to put sections on the others, and work the double one for extracted honey. Would you recommend this? 2. I have a lot of run honey which I took off in a straw super last season, and not worth sending to market. Is there any way of utilising it if it is not required in the apiary? Could you give any recipes, say, for sweets or mead, &c? 3. I have a fifth hive in a wooden box (not framed), which is not very strong. Could I utilise this as a nucleus hive, so as to have a spare queen in case the others swarm or lose a queen? How would you advise me to proceed?—CLUTHA, *Greenock, N.B.*

REPLY.—1. Doubling is very advantageous at times, but you must take care the stock to which the brood is added has bees enough to cover all the combs given them. 2. Recipes for making mead have frequently appeared in our pages. One is given in the *B. J.* for February 20th, 1890; another in number for December 4th, the same year. We will send you both these numbers for two stamps. 3. The box referred to is altogether unsuitable for a nucleus hive, in which movable frames are a *sine qua non*.

[361.] *Joining Bees.*—Will you kindly tell me whether it would be safe to join a swarm to a stock in cottage hive which has been a few weeks queenless, or whether the bees would be likely to destroy the queen? Also whether a stock in frame hive, with four good seams of bees, is any good for this year, the harvest being over about middle of July, or whether it should be united?—S. D., *Leeds*.

REPLY.—It would be 'safe' for an experienced hand to do as you propose, but far safer for one not well versed in bee-management not to attempt it. Your best course will be to join the queenless lot to the stock on four frames, and to do this only needs to bring the two stocks close together by moving a couple of feet each

day till a yard apart, then sprinkle both lots with flour from a dredger and unite.

[362.] *Queen Injured.*—1. Can you tell me what is the matter with the enclosed queen? This time last year a swarm was given me; it soon worked up, the queen was apparently a very good one, and the bees became so strong that they gave me very little honey.* They came safely through the winter, however, and when I last looked at them, about a fortnight ago, there were four or five frames of brood. This afternoon, when going to put super on, I was surprised to find the combs quite broodless, though the stock is still strong. I put in a frame of brood, in which I cut a hole under some eggs, and in the evening also gave them a half-completed queen-cell. Five or ten minutes afterwards I noticed a little excitement at the entrance, and found they were turning out the enclosed queen half dead. Is the queen unfertile? If so, why? 2. Why did the bees not turn her out before? Was it on account of the frame of brood or the queen-cell? My bees are very strong, and so are stocks I have looked at for other people.—E. M., *Twynford, Berks*, June 6th.

REPLY.—1. The queen sent is a very prolific one, her ovaries being full of eggs. She has, however, been hurt or injured by some misadventure, and in consequence has ceased ovipositing. The damage has probably happened when you examined the hive 'about a fortnight ago.' 2. The bees have 'balled' and deposed the queen, probably during the excitement caused by the introduction of a queen-cell.

[363.] *Queen-rearing in Full Colonies without first Removing the Brood.*—Did Mr. Alley ever publish full particulars as to the letter bearing his name on p. 497 of the *B. B. J.* for October 11th, 1888, on queen-rearing, or was the plan not a success?—EAST KENT.

REPLY.—The information will be found in the pamphlet mentioned on p. 263 *B. B. J.*, *Thirty Years among the Bees*.

Echoes from the Hives.

Cawsand, near Plymouth, May 30th.—The weather in this neighbourhood has been generally unfavourable to bees during May. Cold—at times very so—heavy showers, with strong breezes, have visited us frequently since the 12th, when the thermometer stood at 74° Fabr. in the shade. I am now feeding my bees with syrup, as they were able to gather little food from the fruit-blossoms. To my surprise and regret, I found yesterday that Porto Rico placed in Simmins' dry feeders had been almost untouched in six hives. I cannot account for this re-

* You got very little honey last year because the season was a bad one, and to say the stock 'became so strong that they gave you very little honey' is misleading.—Eds.

fusal on the bees' part, as there is no lack of water, and of course they have enamel-cloth quilts on. Owing to cold weather, perhaps. Have not heard of any swarms in this part yet.—Wm. VICTOR ROWE.

Goonhavern, Truro, June 4th.—Bees have come fairly through the winter, a small percentage only of losses being reported. We have a hardy strain on the north coast of Cornwall. In evidence, though I have had a fair amount of experience, I have never seen foul brood. With the exception of, say, half-a-dozen fine days, weather has been bad since February. The way stores have disappeared since brood-raising commenced in earnest is alarming, and great care has been necessary to keep the bees from starving. Still, my stocks are in good condition, and ready for supering as soon as the honey-flow commences, which here is about mid-June.—W. TRESIDDER.

Notices to Correspondents and Inquirers.

Letters or queries asking for addresses of manufacturers of correspondents, or where appliances can be purchased, or replies giving such information, can only be inserted as advertisements. The space devoted to letters, queries, and replies, is meant for the general good of bee-keepers, and not for advertisements. We wish our Correspondents to bear in mind that, as it is necessary for us to go to press in advance of the date of issue, queries cannot always be replied to in the issue immediately following the receipt of their communication. All queries forwarded will be attended to, and those only of personal interest will be answered in this column.

C. F. MILLS.—*Home-made Foundation.*—Instructions for comb-foundation making will be found in the *Bee keeper's Guide-book* (T. W. Cowan), but we cannot recommend any bee-keeper to make his own. Skill and experience are required, and the necessary plant is costly, so that it is more convenient to buy it ready made.

F. J.—Comb is perfectly healthy and contains wholesome pollen only. The 'yellow to brown contents' of the majority of the cells is pollen gathered from various plants. The white covering to some of the cells of pollen is mildew.

ALBERT ARMITAGE (Huddersfield).—We do not think that either of the samples sent are 'pure Demerara cane sugar.'

THOS. KENDALL (Knittleton).—The queen sent is the old one, and has been 'balled' and killed by the bees themselves. Carniolan bees are very prone to this 'balling' of their own queens during the excitement caused by frequent opening of hives in spring. You may be quite sure the hive has not swarmed.

W. H. JENKINS (Swansea).—We have carefully considered your letter, and can arrive at no other conclusion than that the preparation of the food has been in *some way* faulty, combined, of course, with the long confinement bees had to endure last winter. We have used the sugar named for syrup, and it never had the same taste as your sample. There is a greasiness in the latter we cannot at all under-

stand, and the flavour is entirely different from ours. Not only so, but we had modified our opinion that refined cane sugar was best for winter food, because of the uniformly good results yielded by the granulated unrefined sort you name.

CONFERENCE OF BEE-KEEPERS AT DONCASTER.—Mr. A. G. Pugh, Hon. Sec., Notts B.K.A., writes: 'I am sorry to see so little notice is being taken in your correspondence columns and elsewhere of Mr. Coxon's suggestion that a friendly gathering should be convened at the Royal Show at Doncaster. I am sure many of us who propose attending would have been delighted to have known at what hour, date and place we should be able to meet a few of the fraternity, and I trust it is not too late to have it inserted in your *Journal*. I trust it may be on Thursday, the 25th, as that will be likely to be the most popular day.'

* * Several articles are held over for want of space and will appear next week.

ON HIRE, BEE TENT.—For Terms apply to A. J. BROWN, Hon. Sec., Bradley, Wotton-under-Edge, Gloucester. 238

'PERFECTION' QUEEN-EXCLUDING ZINC.

THOMAS B. BLOW begs to announce that he is sole Wholesale Agent for HARVEY & Co.'s New Pattern QUEEN-EXCLUDING ZINC. This particular perforation is absolutely perfection for its purpose, and is an exact reproduction of one of the patterns known as

DR. TINKER'S QUEEN-EXCLUDING ZINC.

Purchasers are cautioned to be careful to observe that they get zinc with the exactly correct width of perforation (which this is), as much of the zinc at present on offer is either too large or too small—thus either letting the queen pass through or excluding the worker-bees.

For retail prices see Catalogue, sent free on application. Special quotations, according to quantity, will be given to dealers.

THOMAS B. BLOW,
MANUFACTURER OF BEE-KEEPING APPLIANCES
WELWYN, HERTS.

LINCOLNSHIRE AGRICULTURAL SOCIETY.

BRIGG EXHIBITION, 1891.

PRIZES to the amount of £25 are offered for HONEY, HIVES, and BEE APPLIANCES, to be exhibited at BRIGG, on the 23rd and 24th of JULY next. Entry closes July 7th.

For PRIZE LISTS and FORMS apply to

STEPHEN UPTON,
St. Benedict's Square,
Lincoln, 3rd June, 1891.
Secretary.

THE British Bee Journal,

BEE-KEEPERS' RECORD AND ADVISER.

No. 469. Vol. XIX. N. S. 77.]

JUNE 18, 1891.

[Published Weekly.]

Editorial, Notices, &c.

BEE-PAPERS FOR WINTER READING.

No. 7.—COMB HONEY PRODUCTION.

In dealing with the production of comb honey, we shall treat the subject mainly from the commercial point, taking for granted that the bee-keeper intends the bulk of his produce for sale in the open market. It should, therefore, be understood at the outset, that the reader whose only object is to raise honey for ordinary family use may relieve himself of much of the trouble and care required when the product is intended for sale. In the latter case, an attractive appearance is almost as important as the quality of the honey itself, and, to obtain it in this form, a considerable amount of experience combined with 'nattiness' is required. Of late years section honey, as it is called, has nearly superseded all other forms of comb honey produced for sale, and the folding wood section-box, as made in America and imported into this country, cannot well be improved upon as a portable and convenient receptacle for storing comb honey in.

In Scotland there still exists some preference for boxes of comb, and for single combs of heather honey, weighing three to four pounds each, but elsewhere the one-pound section is in universal demand, very few producers using even the two-pound section-box. Premising, therefore, that the bee-keeper who only requires comb honey for home consumption will use such receptacles for its storage as are more convenient to handle, and less hampering to the free working of the bees than a rack of sections, with its twenty-one little clusters of bees divided one from the other by tin or wood separators, and all the rest of it, we pass on to the consideration of the work absolutely necessary in order to produce comb honey in attractive and saleable form.

The first point for consideration is the choice of a 'rack,' or box, in which the sections are to be worked on the hive. Fig. 12 is the form most frequently made and sold just now. In it are placed twenty-one sections, fitting quite close together and against the wood of the rack on three sides. On the near side a movable dummy, of wood or glass, is pressed close

against the sections by a spring, as shown, keeping all firm and close together. Between each row of sections is placed a slotted divider,

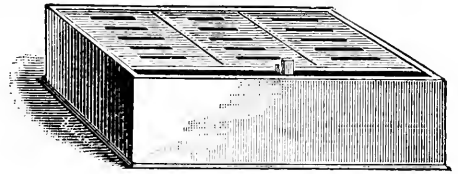

Fig. 12.

usually of zinc or tin, and cut in the shape shown in Fig. 13, these dividers being impera-

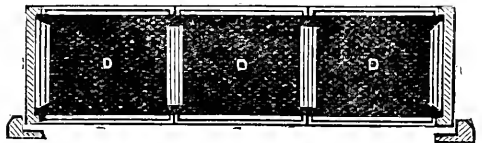

Fig. 13.

tively necessary if section honey is to be properly prepared for sale.

The working of this particular form of rack, however, is not, and never has been, to our liking. The sections are often so difficult of removal, and withal are so awkward to handle piecemeal when on the hive, in any but the most experienced hands, that we have long looked upon it with a good deal of disfavour. Attempts have been made to overcome the faults indicated by the introduction of what is known as the 'Raynor' or divisional section rack, which allows of sections being removed or handled in single rows, so that the centre row may give place to those outside when the former is nearly completed. This was a step in the right direction, but we have always considered that sections should be worked in some form of box which would allow of an easy handling and examination as a box of shallow combs, and yet so completely cover and protect the wood of the sections from becoming soiled by the bees, that they could be turned out for sale as clean and fresh-looking as when put in.

The cut (Fig. 14) gives our idea of a workable section box for a ten-frame hive. In it are seven frames, two inches wide, and each holding three $4\frac{1}{4} \times 4\frac{1}{4}$ sections. There is the usual space at sides and below the frames. The separators are of wood, permanently fixed to the near side of each frame, the dummy, or 'fol-

lower, having a full bee-space on the face next the separator, to prevent crushing bees when closing up. There is also a free passage between the sections on all four sides, and a very little trouble will enable the bee-keeper to reduce the number of sections to as few as the bees can complete as the season closes. A wedge, cut so as to be capable of easy removal, is inserted on the right of each frame, and presses the sections close up together. When ready for removal, this wedge is withdrawn, a thin-bladed knife passed round the outside of sections, and when they are turned face down, the frame may be gently lifted off them, as they will come out by their own weight. Hand-holes are provided for lifting by, and the small circular hole seen on the right is to allow of the escape of any odd bees which may get into the space below the ends of top bars when the section boxes are being storified one above another. There is nothing very new or original in this box, so far as working sections in frames goes. The idea has been acted on ere now in several forms, notably in the wide frame for securing sections of comb honey in hive-bodies or brood nests; but the results have hitherto been so generally unsatisfactory, that few now use them, except in getting sections started for removal after-

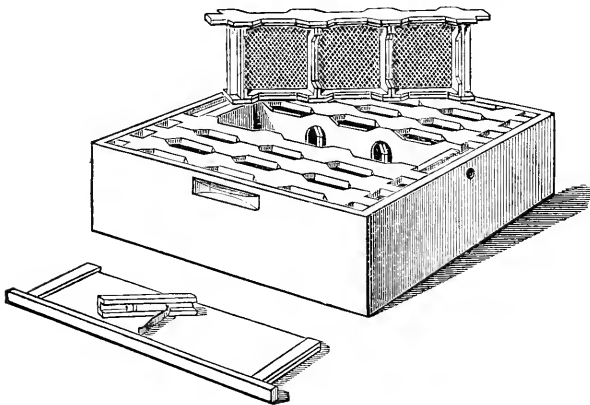

Fig. 14.

wards into the ordinary rack. What we do think has been secured in the box (Fig. 14) is the removal of the faults and imperfections found in others of the same type, so that, as we said at the outset, sections may be worked as readily and as comfortably as shallow frames for extracting are. So far as our experience has gone in using these boxes this season, they accomplish the purpose admirably. And so, having indicated our own preference, we leave readers to make their own selection.

Preparing Sections for Use.—Sections are sold



Fig. 15.

in the flat, and usually made from bass-wood in one piece, the strip of wood forming the folding

box, or section, having three V-shaped grooves cut equi-distant across its width and nearly through the wood. Each end is tongued, as in the cut (Fig. 15), so that when the section is folded, as in Fig. 16, it holds quite firmly. The section illustrated is that known as the four bee-way one, as distinguished from those with openings through which the bees pass on their top and bottom sides only, and called two bee-way sections. Although possessing some trifling disadvantages, we consider the four bee-way section best for general use, as it tends greatly to the building and sealing of the comb close to the wood all round, thereby making it travel better, saving 'drip' or leakage, and giving it a better appearance in the eyes of a purchaser. If the sections are very dry when being folded, turn a bundle of them edge up, and pour a thin stream of hot water down each row of V-shaped grooves to wet the flexible folding joint, and so prevent its breaking.

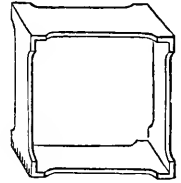

Fig. 16.

Comb Foundation for Sections.—For guiding bees in building straight combs, very thin foundation, made from a superior quality of beeswax, is used. Too much importance, however, is given to the colour of the wax used in making super foundation. Light-coloured wax is, of course, desirable for this purpose, but there is no need for its being white, as some think. Personally, we prefer using pale yellow foundation for comb honey, mainly because bees themselves like it better, nor can we see the slightest difference in the colour of the finished comb whether the one kind or the other is used. The point is to have it made as thin as possible, and from pure beeswax only. Several new methods of fixing foundation in sections have been devised since the using of full sheets

has come into vogue. Formerly only a small triangular-shaped slip of foundation was used as a guide, but the grooved section, and that with a divided top bar, introduced a year or two ago, have done much to popularise the full sheet of foundation as a means of securing more complete combs. Some bee-keepers, however, still use the triangular-shaped guide and the simple little implement made from a bent spoon (Fig. 17), in



Fig. 17.

which the wax is heated over a lamp and poured while hot along the edge of the foundation where it touches the wood, for fixing it to the top of the sections.

Many, again, prefer the wood roller and block

introduced by Mr. Abbott (Fig. 18). In this the foundation is fixed before the section is folded,

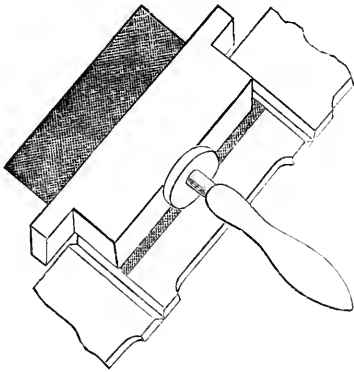

Fig. 18.

the sheet or strip of wax being laid flat on the the upper side of the section, and the wooden guide-block placed in position, when the roller, held firmly in the hand, is run along the edge of the wax, using some pressure at the same time. The guide-block is then turned over on to the just-pressed edge of the wax sheet, and held there while the latter is raised to its position at right angles to the joining. If the wooden wheel is kept slightly damp, and the wood of the sections perfectly dry, this method of fixing is quite secure, while, with a little practice, it can be done very rapidly.

Then we have the ingenious plan of fixing foundation, perfected by Mr. Howard, in which the top bar is divided and the sides of the section grooved. The cut (Fig. 19) illustrates the method of attaching the foundation to the bar,

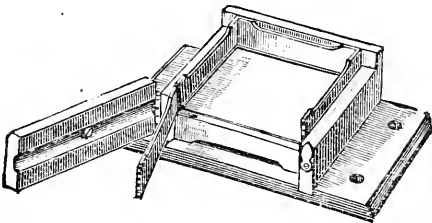

Fig. 19.

which is divided, as shown. When the section is folded it is placed in the block, the sheet of foundation being laid on the face of the wood, with its edge close to the split top bar. By closing the jointed flap on the left the upper half of the top bar is pressed home, and fastens the sheet firmly, and, once fixed, it cannot give way unless the wax breaks down. A section grooved on all sides has also been brought out expressly for using with full sheets of foundation. In this the section, after folding, is placed—top bar pointed upwards, as in Fig. 20—in a block which holds it perfectly square; the sheet of foundation, cut to the exact size, is then slipped down the groove till it rests on the bottom, when the top bar is folded down on to it.

Finally, we have the old, and with many still preferred, method of fixing foundation by means of wax made very hot in the well-known smelter (Fig. 21) designed by Mr. Abbott several years ago. No apiary is complete without one of these useful little implements, and another known as the 'Carlin Cutter' (Fig. 22), for cutting up sheets of foundation. After fitting up recently a lot of the grooved sections last mentioned, we have just 'tacked' the foundation on its top side with melted wax from our smelter, to prevent any risk of a breakdown. Whenever uncertainty

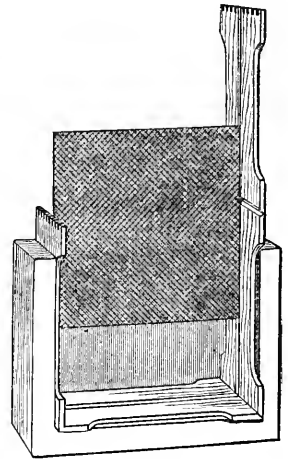

Fig. 20.

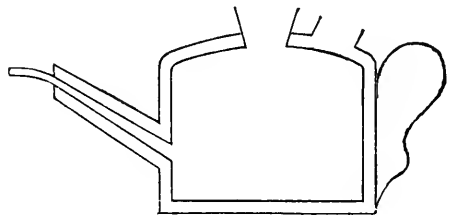

Fig. 21.

exists as to the stability of the various methods of fixing foundation, a little hot wax will always make it safe, and those who find any difficulty in using full sheets, owing to their liability to bulge or sag, can always ensure freedom from risk in the triangular piece of foundation for a guide and the wax smelter for fixing it. If full or even half sheets of foundation are fixed in this way, a guide block—made by nailing a piece of $\frac{7}{8}$ inch board, $3\frac{3}{4}$ inches square, on to a slip of light wood 6×3 inches—is used to hold the foundation in position while being attached. The section is slipped over the square piece on the block—the latter being held in one hand—the foundation is then placed on the square, with its edge touching the wood of the section. While in this position a little molten wax is poured from the smelter on to the junction, and allowed to run up and down by inclining the section to the necessary angle until the wax has cooled and set.



Fig. 22.

Queen-Excluders below Sections.—The use of

these is another moot point with bee-keepers, among whom we have always advocated their use when working for extracted honey, and now that we are in a measure compelled, by change of location, to do some sectioning, we find ourselves with excluders below all our surplus chambers, whether section-boxes or combs for extracting. In our own case the excluders are set close on to the top bars, with the length of the perforations, as usual, running across the spaces between the frames, for the reasons already given on p. 256, and once the bees pass through the excluders into the free space below and around the frames in which the sections hang in our new section box, there has been no hesitation in their taking full possession of the sections and starting work. We lay stress on the need for keeping sections as warm as possible in the early part of the season, using newspapers as coverings over the quilts above and around the sides of boxes, in addition to slips of paper between the junction of hive and section box, for the purpose of maintaining the heat therein.

Various methods are adopted to induce bees to take possession of sections, one of the most successful being the insertion of a square of comb with honey in it—freshly gathered if possible—in one of the section boxes. The bees pass through into the upper chamber attracted by the odour of the honey, and (as the bee-keeper hopes) stay there. As to the most suitable or proper time for setting on sections, no date can be given. So much depends on the honey resources of the district—to say nothing of the preparedness or condition of the stock—that no guidance can go beyond saying that when the hive is fairly full of bees and honey is being gathered surplus chambers should at once be put on, and the precaution as to maintaining warmth, already indicated, carefully attended to.

Using Ready-combed Sections.—These are seldom satisfactory owing to the fact that they usually have a coarse, rough appearance when refilled by the bees with honey. They may, however, be used with advantage if about one-half depth of the cell-walls are removed, and the bees allowed to lengthen them out again with newly formed wax. Partly drawn-out sections of comb are valuable for future use, and should be carefully preserved from moths and dust when removed from the hives at the close of the season.

Storifying.—While all agree that several racks or boxes of sections may be worked at one time on a hive, some difference of opinion exists as to whether the additional room in storifying should be given above or below the chamber already on the hive. Our own view is that the judgment of the bee-keeper and the circumstances at the time should guide him. It is very undesirable to have a lot of half-finished sections left on hand, but no rule of action can be laid down and not departed from when so much depends on the season, &c. For instance, we have this year given our first surplus room

in the shape of boxes of ready-built shallow combs. These hold the slowly gathered honey stored earlier on, and, now that the weather has become propitious, sections have been placed over the first boxes, which latter will remain on probably till the close of the season, as bees can do no harm by travelling over and soiling the surface of sealed combs intended for extracting. But we shall, in the event of fortune favouring us, raise the section boxes when well forward and set a second lot over the extracting frames but *under* the first sections. The object is to get sections worked out and filled as rapidly as possible. Once finished, remove them from the hive without delay, and when indoors, keep them fresh and clean for market, by storing in a crate like Fig. 23.

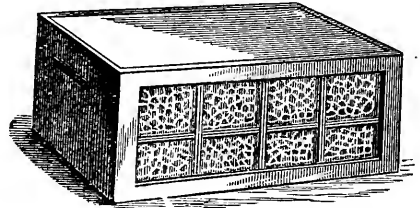

Fig. 23.

Grading Sections for Market.—Experienced honey producers have long ago realised the importance of grading their sections into several qualities when marketing. The simple business rule observed in all trades applies here, and the best will command the highest price. Hence it is that he exercises his skill in getting as many of the best and as few of the worst as he can. Two or three poor sections will spoil a crate holding a couple of dozen, and tend to lower the price, though all the rest be good ones, so they should never be mixed. Besides, buyers soon know how to estimate the judgment of the producer, and once a man can be relied on for sorting his produce aright he has little difficulty in finding regular customers. Some bee-keepers have, unfortunately, almost no idea of the importance of fully considering these points, and the result is that many retailers will on no account buy comb honey without seeing samples, or having some knowledge of the seller or of his method of preparing the product for market. It is perfectly certain that the trade in honey has been hitherto much hampered and limited in its scope in consequence of the poor fashion in which sections are prepared for the market; therefore, when we hear complaints of slow sales it should be borne in mind how much fault lies with the bee-keeper himself.

Section Cases.—Some laudable attempts have been made to introduce a case suitable for displaying sections of comb honey in, while affording safe protection from dust and damage, and several of the articles so designed answer the purpose admirably in all respects save one. They have removed a long-standing difficulty on our show-tables, and are recognised as a real boon at exhibitions, where nearly all sections

are now staged either in tin or cardboard cases—glassed on both sides—which safely protect them from leakage and robber bees. Besides these, there are cases of tin and of wood, made to fold over and protect sections in transit, each neat and efficient to a degree in themselves; yet none of these cases seem to be popular with the Italian warehouseman, or with the florist or grocer who sells section honey across his counter. Our experience goes to show that they each and all prefer the sections of honey sent to them in a crate like Fig. 23; and to entertain the idea that ‘beauty unadorned,’ &c.—that is, that if the wood of the section be perfectly clean, as when made, free from propolis, and the combs sealed over with cappings of transparent purity and whiteness, no covering of any colour or kind is needed to add to their attractiveness, but that it rather spoils a fresh section to cover it up with anything.

We close this paper with the advice that all comb-honey producers should aim at an ideal section, which looks best when offered to buyers just as it comes from the hive.

BRITISH BEE-KEEPERS' ASSOCIATION.

All communications to the Secretary from this date until Thursday, 25th inst., should be addressed to 67 Cunningham Road, Doncaster.

The Secretary will be glad to receive small parcels of cut flowers, clovers, &c., for embellishing the Bee Department of the Royal Show. Carriage will be paid on such parcels. They should be sent by parcels post, unless within an easy distance of the show, when they may be forwarded by rail, addressed, ‘The Secretary, Bee Department, Show-ground, Doncaster,’ so as to be received by the 22nd or 23rd inst.

CONFERENCE OF BEE-KEEPERS AT DONCASTER.

We have just received the following note:—

‘Sir,—I fully endorse the remarks of Mr. Pugh in last week’s issue respecting the friendly gathering of bee-keepers at the Royal Show. I shall try to get over, merely for the apiarian department, and should be most happy to meet “a few of the fraternity,” as I consider this golden opportunity should not be lost. To me, a chat with others in the craft is one of the greatest luxuries connected with bee-keeping. I hope something definite has been arranged.—C. WOOTTON, *Draycott, Derby, June 15th.*’

Our correspondent overlooks the difficulties attending his proposal. First, there is no room or building available for such a meeting within the show-ground, and second, it is quite certain that a meeting held outside would not be well attended. We, therefore, can do no more than say that both Editors of the *B.J.* will be present on the 22nd, 23rd, and 24th, and Mr. Cowan, as steward of the Bee Department, will of course remain until the close.

THE MALAGASY BEE (*APIS UNICOLOR*):

ITS HABITS, ENEMIES, AND CULTURE.

(Concluded from page 269.)

Another caterpillar of a *Bombyx* feeds on the Eucalyptus (red), geranium, and a native shrub, and nothing else, and will readily change from one to the other. What is there in common between such dissimilar plants? There is a field open for investigation here, and one in which, after three years’ careful study, I have myself made no progress. Some moths will lay their eggs on a wall near which at least ten different kinds of plants grow, all equally remote from the eggs. As soon as the young are hatched, instinct leads them to one, and one only, of these ten bushes. I have taken the eggs and put them so that there was no plant on which they commonly feed near. The young, when hatched, wandered helplessly about and perished. There are many caterpillars which will eat anything, more especially the hairy kinds, but very many are most exclusive. (The readers of this paper must excuse the digression.)

The other enemies of the bee that I have noticed are a parasitic solitary wasp, which lays its eggs in the hive; and another, which seizes the bees returning to the hive for the sake of their laden honey-bag. It kills the bees with wonderful celerity.

I have also found a parasite of small dimensions on the drones, and sent a description of it to Mr. T. W. Cowan, who informs me that it is different to any he has noticed on the European bees.

A few further particulars about native bee-culture may be of interest. The hives the Malagasy use are hollowed tree-trunks, much the same as those employed in many other countries. A rough plug of wood is inserted in either end, through the interstices of which the bees find entrance and exit. Some natives fix a piece of comb by means of a split bamboo in new hives, so as to induce the bees to build at right-angles to the trunk; the combs containing honey can then be got at more readily without destroying the brood, which is usually in the centre combs. The natives, when taking the honey, open one end, and holding a piece of burning rag, blow the smoke gently in; this drives the bees to the further end, when the combs can be cut out without fear. Then, going to the other end, they do the same, leaving the centre combs untouched.

I have already stated their method of increasing the stock. They have a good general idea of the economy of the hive, and of the habits of the bees. They usually find the wild nests by watching the flight of the laden bees, and then by listening during the hot part of the day, when the bees are ‘playing.’ There are only two villages that I know of where bees are kept to a large extent; at most other places the people know of a certain number of wild nests, over which they keep supervision.

When the honey is taken they pound up the comb, honey, and pollen all together, placing it in gourds, and then take it to the market. In many places they make large quantities of mead, more especially when the rite of circumcision is being observed.—C. P. CORRY, *Madagascar Magazine*.

Correspondence.

The Editors do not hold themselves responsible for the opinions expressed by correspondents. No notice will be taken of anonymous communications, and correspondents are requested to write on one side of the paper only, and give their real names and addresses, not necessarily for publication, but as a guarantee of good faith. Illustrations should be drawn on separate pieces of paper.

Communications relating to the literary department, reports of Associations, Shows, Meetings, Echoes, Queries, Books for Review, &c., must be addressed only to 'The Editors of the "British Bee Journal," 17 King William Street, Strand, London, W.C.' All business communications relating to Advertisements, &c., must be addressed to Mr. J. HUCKLE, Kings Langley, Herts (see 1st page of Advertisements).

*** In order to facilitate reference, Correspondents, when speaking of any letter or query previously inserted, will oblige by mentioning the number of the letter, as well as the page on which it appears.*

SALTED SYRUP FOR BEE-PARALYSIS.

[680.] Having gained a great deal of information from the experiences of others regarding bee-matters in the *B.B.J.*, I feel it is a duty devolving on me to give my experience of the disease called bee-paralysis (*Bacillus depilis*). On May 10th I noticed one of my stocks—which went into winter quarters fully covering seven frames, and which had during the bad season of 1890 yielded upwards of forty pounds of honey—was suffering from this disease, which I had never seen or heard of until last year in the *B.B.J.* But once seen, it could not be mistaken, as scores of bees, black and shiny, were running about on the ground, trying to fly, but quite unable to do so. On the 11th matters were very much worse, and there were hundreds of them dying and dead; and as some of your correspondents had tried salt and water with only partial success, I gave the bees a dose of syrup *strongly* salted—so much so that I had doubts as to whether they would touch it. Next day, however, I was agreeably surprised to find that they had not only taken down the whole of the syrup, but that at no time during the day were there more than half-a-dozen bees on the ground at one time. I continued the salted syrup for ten days, and have seen no trace of the disease since. I overhauled this hive on 12th May, and found there were not sufficient bees left to cover four frames, and only two small patches of brood, about four inches square; but on examination to-day, find there is a good increase in numbers, and the queen seems determined to make up for lost time, for there are now five frames crowded with brood in all stages, and a fair prospect of the bees being fully prepared to give a good account of themselves before the season is over. That all bee-keepers will have a better harvest this sea-

son than they did last is the earnest wish of—
J. S. M., *Myland Road, Colchester, June 8th.*

OVERDOSING BEES WITH NAPHTHALINE.

[681.] I found to my horror a few days since that five out of my fifteen stocks were more or less affected with foul brood, which I attribute to using two super-clearers last autumn after they had been used in an apiary where foul brood existed, although unknown at the time. I have been a subscriber to the *Bee Journal* ever since I began to keep bees, some six years ago, and have often read therein about foul brood and its treatment. Salicylic acid used to be recommended as a specific; then Mr. Cheshire came to the front with phenol as a certain cure. Later came formic acid, and now naphthaline and Naphthol Beta are the popular remedies. From all which I infer that no real and sure cure has yet been discovered. When I found that my own apiary was suffering from the disease I hastened to procure some naphthaline and also some Naphtho. Beta. I put some naphthaline just inside the dummies, and as I had not seen anything as to the quantity to be used I just shook some out of the bottle into my hand and dropped it in, giving, I dare say, a good table-spoonful. This morning I received the *Journal*—I get it with other papers from the bookstall on Saturdays—and there, in 'Useful Hints,' I saw that the proper quantity to use was 'as much as would lay on a sixpence!' Going to the hive least affected, and which was fairly strong in bees and brood, I found comb after comb of brood in the imago stage apparently dead, and the bees had been tearing open the cappings and pulling some of them out. It gave me the heartache to see it, and my time being gone, I have not examined the others, but fear they are the same. Would that I had had the information a week or two earlier.

You speak of a case where an impure sort used in excess had caused the bees to desert the brood, which had become chilled in consequence; but it seems to me that the nymphs were poisoned by the vapour. I did not notice that the young grubs were injured, though I am not sure on the point. The bees did not leave the hives, so how could the brood be chilled in my case? Did not inhaling the vapour kill them, for the capping, I take, is not air-tight? I send you herewith a little of the naphthaline I used, and I would ask—1. If it is the right sort? 2. How often should it be applied? 3. What would you advise under my present circumstances? Would it be wiser to let the bees clear out the dead brood and start afresh, or to take away the combs and give foundation? or would you destroy the lot, and so make sure of stamping out the disease, instead of trying uncertain methods of cure. As I am a poor man, I wish to do the most profitable thing. When I was a boy at home in South Wilts I remember hearing bee-keepers talk of their custom of cleaning down their bee-stools (skeppits) on St. Valen-

tine's Day, and salting them. I have never read of this custom of salting in the *Journal*: have you heard of it before? But it occurs to me it might be useful to destroy insects and contagion that might get on the floor, though I should think it tended to keep the floor-board damp.—SIGNALMAN, *June 6th.*

[Foul brood among bees, like influenza, consumption, and other germ diseases among humans, is not yet mastered (would that it were!); and scientists are applying the knowledge acquired by modern researches in endeavouring to find out a means of destroying those mysterious bacterial germs so destructive to many forms of life. Meantime we must apply ourselves to find out what remedy is most effective as it touches bees. This is all that can be said, except to urge more care in the application of the remedy than was unfortunately displayed by yourself. Replying to your questions, we should say—1. Your sample is quite right, and as much as will cover a sixpence is the correct dose. 2. Once a week. 3. In a case like yours, where foul brood is actually present, it would be a fatal policy to leave dead brood in the combs. The decaying larval matter is the very best medium for developing the spores or germs of the disease, and, as such, should be removed and destroyed. If the stocks are strong we should not hesitate to reduce them to the condition of swarms, and by feeding with medicated syrup allowing them to build new combs in disinfected hives. The stocks less badly affected might be cured by using Naphthol Beta in the food and a pinch of naphthaline on the floor-boards, as advised above.—Eds.]

BEEES AND HORSE-FOOD.

[682.] Could you or any of your correspondents kindly inform me how it is that bees frequent the stable-meat cooler so much? It has often been noticed that when the man takes the cooler round the back of the steading to the boilers he is met by a perfect swarm of bees, and they wait about until the cooler is brought outside and again filled with the meat, which consists of barley, beans, turnips, and chopped hay all boiled together. We fancy the bees know when the food is comatable by the noise the iron cooler makes in going over the causeway in the courtyard on its way to be filled, and after it is filled it is literally covered with bees.—CLUTHA, *Greenock, N.B.*

BEE-MANAGEMENT.

[683.] The question as to how stocks of bees can be most profitably increased must be one of very great importance to a large number of bee-keepers at any part of the active season, but it is of the utmost importance at the commencement. In the early spring most bee-keepers find that there has been a more or less severe loss in the number of their stocks during the winter months, and that their usual number will need to be made up for active work during the season, as well as for the autumn preparation for winter. It will generally be found, where a large number of colonies are kept, that there is a loss in wintering. How that loss can be repaired in the

most efficient manner, and with the best results, must of necessity become a subject of the greatest importance to the generality of bee-keepers; especially will it be the case with those who have been taught to depend, to a certain extent on the surplus store gathered by their bees to assist them in maintaining an honest and independent living.

The first thought will be, 'What is the best method to be adopted?' The choice would be between either natural or artificial swarming; both systems have for advocates men of eminence in the profession, many of whom have had large experience, but possibly the latter has the greater number, and they are gradually increasing in proportion as improved methods are practised and understood. The most common objections to natural swarming are: The time spent in watching; the loss of queens by the bees mixing; the loss by swarms flying away; the queens laying less, and the bees storing less, when preparing for swarming. The general uncertainty of their swarming may very seriously affect the profitableness of the colony. The most powerful argument used by the advocates of natural swarming is that it imparts a greater amount of energy to the bees when they are allowed to swarm naturally. The success of artificial swarming greatly depends upon the experience of the bee-keeper and the method he adopts. The first can only be overcome by careful practice; the other by comparing his own with that of others who may have been more successful.

The second thought would be, 'When would be the proper time to make the swarm? Should it be before the main honey-flow begins, during the time of the flow, or after it has ceased?' The correct answer to these questions would very much depend on the condition of the bees at these various times. To divide a weak stock at any time would not be considered a very judicious act by the most intelligent bee-keepers: only bees which are sufficiently numerous could be in a proper condition for dividing. Some of bee more timid and less experienced among the the-keepers might be disposed to ask, 'When are the bees in the best state for dividing?' The reply being 'When the brood nest is full of overflowing with bees.' It is possible that even below that standard they may be divided to advantage. There is no doubt the age and general condition of the queen must have due consideration if the division is to be a success. If the queen is old, or her general condition has been impaired, though she may have been formerly prolific, there might be cause for doubt if she could maintain the brood nest at the normal state. In such case her successor would have to be provided.

If a colony is sufficiently forward in numbers that it would admit of being divided at a time before the honey-flow, so that both colony and swarm would be able to fill their brood nests with a large proportion of sealed brood before the flow commenced, under such conditions it would be the best to divide: there would be two colonies to work instead of one; but if the

period would not allow of more being done than filling the greatest part of the brood nest with eggs and larvæ, to divide under such circumstances would be a questionable good. The young larvæ would need the attention of the older bees, and, consequently, many would be at home which might have been in the fields gathering honey, and a large proportion of the stores brought home would be consumed by the brood, and less surplus could be stored. Some eminent bee-keepers have strong objections to late-reared queens. They are said to be short-lived, uncertain in their prolificness, having no security that they are properly fertilised.—R. M.

FOUL BROOD AND FOREIGN BEES.

[684.] Accept my best thanks for your reply to my inquiry respecting foul brood. It may perhaps be of interest to you to know that I keep about a dozen stocks of bees in frame hives, and have kept bees for upwards of twenty years, and up to this spring have never suspected foul brood. Two years ago I became possessed of two Carniolan queens. These two stocks I have kept with difficulty to this spring, and I am glad to say both are now dead. It was from one of these stocks I sent the comb—I think the worst piece I could find; but throughout each hive a few cells were to be found, and both suffered very much with dysentery.

After my experience with foreign bees I shall have no more. I have no doubt my remaining stocks are more or less affected, but none of them, I hope, seriously. I shall take every precaution, and hope to soon have a clean bill of health.

I had my first swarm on May 31st, very early for this district, and the earliest I have heard of.—C. C., *Dalkeith, N.B.*

BACILLUS MINOR AND B. DEPILIS.

[685.] Thanks for reply to my note. I was inclined to be incredulous at first on your deciding so definitely that the comb I sent was badly infected with foul brood, as the disease has been until now quite unknown in this district, and I have kept up to a dozen hives for the last twelve years. I take it, however, you are likely to be correct in your opinion.

The question with me now is, What ought I to do? I must say that for a few years back, at least, I have occasionally noticed a few cells in some combs with similar appearance to those now condemned, and yet it does not seem to have spread rapidly, nor yet impaired the vitality of my hives, for I consider my average yield has been very satisfactory.

The hive from which the comb was taken was much weakened last season by the appearance of a disease referred to in the *B. B. J.* as paralysis. The bees seemed to be effected only on very warm days, and by August it seemed to have spent itself. I now find my best hive is also showing signs of the same disease, and a large number of dead bees are lying in front of

the hive, so I presume that that hive is also doomed.

I have now ten hives, all with frames, and standing about a yard or so from one another, and I do not know but that some of the frames from the diseased hive have been *interchanged with the others*. I have now closed up completely, and destroyed the remaining bees in the affected hive.

From what has appeared in the *B. B. J.* of the experiences of others in dealing with foul brood, I am not inclined to be sanguine about the powers of so-called 'cures.' It seems the disease, in some cases, may be stayed for a time only to appear again.

I infer that you advocate the use of disinfectants, and if so, will you kindly say which is the best to use?

Is it necessary to destroy the complete hive as well as combs? One certainly grudges to lose or burn valuable hives, still, if *absolutely* necessary, I, at least, would be quite prepared to do so.—H. B., *Kilmarnock, N.B.*

[Your experience, as detailed above, goes far to show that the disease under which the bees have been labouring 'for a few years back' is the mild form commonly known as *Bacillus minor*, and, no steps having been taken to combat it, the wonder is that the more malignant *Bacillus alvei* has not developed itself ere now. Until it is known which of the other hives (if any) are affected with foul brood, we advise the use of a pinch (not more) of naphthaline, once a week, dropped down on to the floor-brood at the back or side of the hive as a preventive. But where it is known that any stock is foul-broody, use formic acid or else Naphthol Beta as directed in former pages of *B. J.* There is no need to destroy hives in which diseased stocks have lived. Sulphur fumes properly applied will destroy any infectious germs completely.—Eds.]

A CHEAP FEEDER WANTED.

[686.] I quite endorse what Dr. Bartrum says re cheap feeder. Cannot you, dear sirs, urge some dealer to bring out a good, yet cheap, feeder? I am in want of half a dozen now, but the price is a big item at present rates.—C. N. P.

Bee Shows to Come.

June 22nd to 26th.—Royal Agricultural Society at Doncaster. Entries closed.

July 2nd.—Kent Association in conjunction with the Rose and Horticultural Society at Farningham, Kent. Entries close June 27th. Jesse Garratt, Hon. Sec., Meopham, Kent.

July 8th.—Middlesex B.K.A. County Show at Hampton. Hon. and Rev. H. Bligh, Hon. Sec.

July 15th, 16th.—Armagh. Mr. E. Best, Armagh.

July 15th, 16th.—Notts Agricultural Society at Nottingham. Bees, honey, and appliances. Entries close June 20th. For schedules, &c., A. G. Pugh, Hon. Sec., N.B.K.A., 49 Mona Street, Beeston, Notts.

Queries and Replies.

[364.] *Foul-Brood Remedies—Controlling Swarming.*—1. Which of the three cures for foul brood—viz., (a) phenol, (b) formic acid, or (c) Naphthol Beta—do you consider the best and most certain? I have three stocks in my apiary affected with foul brood. One especially, which seemed quite cured last autumn, has within the last three weeks become again badly attacked. Would you advise removing it some distance away or destroying it altogether? Are not the healthy stocks in danger of getting infected, being all in the same garden? Kindly say how Naphthol Beta should be used. 2. Is there any method of preventing the recurrence of swarming? I only want to take one swarm from each of my hives, and I have found that in spite of taking away the queen and returning second swarms, they keep on swarming several times, and the sections are, in consequence, deserted, and the principal flow of honey—viz., the clover—often lost. I have tried cutting away the sealed queen-cells, but have not found this of much use. Do you recommend putting the swarm into the parent hive, and removing the latter, viz., the brood combs and bees adhering to them, to another stand?—H. B., *Galway*.

REPLY.—1. We are only able to judge of the efficacy or otherwise of the several remedies named by general results in the hands of ordinary bee-keepers: (a) though no doubt effective in proper hands, has failed so frequently that we have ceased to advise its use, except in food as a preventive of infection; (b) has done a good deal of good in a general way, and stocks have been reported as quite cured by it; (c) we are very hopeful that this remedy will prove an effective one, as it has the merit of possessing few of the drawbacks of the others. It is easily mixed with the food, the bees evince no dislike to it, and, if used in conjunction with a sparing use of naphthaline on floor-boards, will, we trust, prove a boon to bee-keepers. Directions for use accompany the remedy. 2. If an artificial swarm is taken in the usual way from each hive, there should be no difficulty in preventing the old stock from swarming naturally a second time. Cut out all queen-cells found, save the best and most forward one, ten or twelve days after the swarm is taken from the stock. It is not a good practice, however, 'to take one swarm from each hive,' because the dividing of stocks seriously interferes with the chances of surplus honey-storing the same season.

[365.] *Melting Combs for Wax—'Deaf Comb.'*—In this district (Cornwall) people say that no wax can be obtained from what they call 'deaf comb.' The method of obtaining wax from combs is to put the combs in a cloth and boil them in a saucepan or some suitable vessel for some time. The saucepan is then removed from the fire, and the wax is allowed to solidify

on the surface of the water. They say here that the deaf comb remains in the cloth with other useless matter. Why should this be? 1. What is deaf comb? 2. Does any change occur in the wax of comb used for breeding, so as to make it less meltable than the honey-comb?—H. C., *Cornwall*.

REPLY.—1. We have heard the term 'deaf comb' applied to combs in which the cells are so full of pollen as to be useless for breeding purposes. 2. Yes. Very old brood combs yield little wax, and are not worth the trouble of melting down. The cell-wall consists of numerous skins left behind by the bee when it emerges from the cocoon state; and this seems to absorb the little wax left when the whole is melted in hot water.

[366.] *Sting-Prevention.*—Can you tell me—1. If you know a *certain* preventive to rub on hands to protect from stings? I have tried winter-green oil and others, but they are not sure. 2. I have two stocks, not strong enough. Would the bees go back to their old place a few yards away if I united them and then removed one hive?—H. C.

REPLY.—1. Not using any preventive against stings ourselves, we cannot do more than advise a trial of such remedies as are recommended by those who do require such things. Vaseline has just been tried by some of our readers, and found effectual, but we think a good nerve and a steady, quiet method of handling is, after all, the best preventive. 2. Yes. It is necessary to bring the two colonies close together before uniting them.

Echoes from the Hives.

Leicester, June 3rd.—Getting Bees into Sections.—The book (Tinker's) you lent me I was pleased with. Here and there I found some very good ideas, but there were others not practical with the ordinary English standard hives. I should not care to follow the book as a guide in everything. I think our books and journals are really more practical here in England. *Modern Bee-keeping* cannot easily be beaten for beginners. A new edition with a few changes and some additions would, I think, make it perfect for all ordinary bee-keepers. My bees are doing well. The weakest lot (youngest queen) at the middle of April is now my best. I have supers with ten shallow frames in each on *three* hives, all crowded with bees; the *fourth* hive I have put sections on. At first bees would not go up, so I put on the top of sections a drone comb with a little honey, which I took out of the hive. This brought them up to clear it, of course. It has now been removed two days, and the bees are now crowding the sections, so I hope to get some this year. I have got a friend to do the same with his, and I believe it will succeed. We have abundance of

bloom—apple, laburnum, horse-chestnut, crab, &c. The apple will last a full week yet, the chestnut more, and then there will be May-blossom and beans, &c.—T. D.

Parracombe, near Barnstaple, June 10th, 1891.
—Bees have done fairly well here during the past winter. I packed ten stocks in autumn, and looking over them a month since, I found they had come through safely, four being very good, four good, and two weak, but all abundantly supplied with food. Since that date, however, both the weak ones have collapsed, leaving eight in good trim. A neighbour of mine has lost several stocks through robbing, and some others perished in the snowstorm on March 10th. The bees being in an exposed position, the snow drifted in all day through the entrances, and passed up between the combs and chilled them. Several others around here have lost rather heavily, but in many cases a little better management might have prevented it. Somehow bees cannot manage to live without food any more than we can, and some folk won't feed them. I examined eight stocks for a farmer about a fortnight ago, and found them doing splendidly, almost every stock crammed full of bees, ready for sections as soon as weather gets a little warmer. I hear of several swarms having issued a few miles away, but none here as yet, though drones are flying. Beautiful weather here for the last few days, and I hope we shall soon see sections filling.—A. DELBRIDGE.

Bradford-on-Avon, Wilts, June 12th, 1891.
—I have this last winter lost seven out of ten stocks. Have kept bees now four years, and never before lost one. They had plenty of stores, and were covered up thoroughly, but the frost penetrated, and killed them, I suppose. My bees have gathered a great deal of honey of late. Some bars with foundation, put in ten days ago, are filled, and yesterday (11th), I put about a dozen standard frames on top of hives. I may say I bought half a dozen more stocks two months ago; all were weak, but they are now very strong.—H. C.

Notices to Correspondents and Inquirers.

Letters or queries asking for addresses of manufacturers or correspondents, or where appliances can be purchased, or replies giving such information, can only be inserted as advertisements. The space devoted to letters, queries, and replies, is meant for the general good of bee-keepers, and not for advertisements. We wish our Correspondents to bear in mind that, as it is necessary for us to go to press in advance of the date of issue, queries cannot always be replied to in the issue immediately following the receipt of their communication.

All queries forwarded will be attended to, and those only of personal interest will be answered in this column.

H. S. W.—Queen is an old one. All queries should be forwarded to editorial office in London, not to King's Langley.

EAST LINCOLN.—We should have no objection to try the remedy if a sample were sent; but it is scarcely reasonable to ask us to purchase

an article for the purpose of gratuitously advertising it.

R. McC. (Paisley).—Queen bears the appearance of an adult, but a very small one. The body is quite unfit for *post-mortem* examination, being quite dry and hard.

L. A. W.—Comb sent is affected with foul brood.

MATTHEW H. READ.—The mutilated queen has lost a portion of two legs by some misadventure; after fertilisation, we think. Her subsequent unprolificness is simply the result of her inability to move about on the comb.

C. WALDY (Sutton-on-Derwent).—The insects sent are the common burrowing sand-bee. They belong to the class *Andrenidae*, of which there are several varieties. Their habits are entirely different from the hive-bee, though they resemble the latter very much in appearance.

J. W. WRIGHT (Wakefield).—Comb sent is foul-broody.

ON HIRE, BEE TENT.—For Terms apply to A. J. BROWN, Hon. Sec., Bradley, Wotton-under-Edge, Gloucester. 238

'PERFECTION' QUEEN-EXCLUDING ZINC.

THOMAS B. BLOW begs to announce that he is sole Wholesale Agent for HARVEY & Co.'s New Pattern QUEEN-EXCLUDING ZINC. This particular perforation is absolutely perfect for its purpose, and is an exact reproduction of one of the patterns known as

DR. TINKER'S QUEEN-EXCLUDING ZINC.

Purchasers are cautioned to be careful to observe that they get zinc with the exactly correct width of perforation (which this is), as much of the zinc at present on offer is either too large or too small—thus either letting the queen pass through or excluding the worker-bees.

For retail prices see Catalogue, sent free on application. Special quotations, according to quantity, will be given to dealers.

THOMAS B. BLOW,
MANUFACTURER OF BEE-KEEPING APPLIANCES
WELWYN, HERTS.

LINCOLNSHIRE AGRICULTURAL SOCIETY.

BRIGG EXHIBITION, 1891.

PRIZES to the amount of £25 are offered for HONEY, HIVES, and BEE APPLIANCES, to be exhibited at BRIGG, on the 23rd and 24th of JULY next. Entry closes July 7th.

For PRIZE LISTS and FORMS apply to

STEPHEN UPTON,
St. Benedict's Square, Secretary.
Lincoln, 3rd June, 1891.

THE
British Bee Journal,
BEE-KEEPERS' RECORD AND ADVISER.

No. 470. Vol. XIX. N. S. 78.]

JUNE 25, 1891.

[Published Weekly.]

Editorial, Notices, &c.

THE LATE MR. J. M. MCPHEDRAN.

We have already alluded to the death of the 'Renfrewshire Bee-keeper' on page 256 of the *Bee Journal*, and are now able to give a few particulars of his life which, we hope, will interest our readers.

Mr. McPhedran was born at Greenock in 1827. His father was Archibald McPhedran, whose ancestors were from Inverary. His mother was Miss Mary McCulloch, daughter of Mr. John McCulloch, of Craigbet, Bridge of Weir. He had two sisters and a brother, the latter dying of fever at the age of fourteen.

Mr. McPhedran was educated under Dr. Brown at the Grammar School in Greenock, and when his education was completed he entered the mercantile office of Mr. McCurn, Excise Buildings, Greenock. There he remained some years, and this period of his life was most useful to him, for it laid the foundation of those exact business methods which distinguished him all through his after-life, and which those who have had anything to do with him could appreciate. In 1854 he gave up business and retired to Craigbet, which he had inherited. Since that time he has led the life of a country gentleman, taking special interest in Ayrshire cattle and Leicester sheep, for which he obtained a good many valuable prizes at various agricultural shows.

It was soon after he settled at Craigbet that he took up bee-keeping, into which he entered with an enthusiasm which he retained to the end. Even during his illness he did not forget his bees, alluding to them in a letter he addressed to us so late as the 11th of April last, in which he mentions the mildness of the weather, and his seeing the bees busily flitting amongst the crocuses, while he was a prisoner indoors, suffering from bronchitis. It is interesting to know how he was first induced to take a special interest in the honey-bee. He heard of washing-tubs full of honey-comb having been removed at the destruction of colonies of bees established in the roof of an old mansion in the district, and of a neighbour utilising a similar possession by getting a portion of the laths and plaster removed, and a board with buttons to keep it in its place substituted, and that this gentleman, with no little pride, would order his butler to

cut out and set on the breakfast or dessert table honey-comb warm from the hive, to the admiration of his friends. Mr. McPhedran decided to try a similar plan with some colonies of bees that he found in the roof of his own house. He opened up a couple of the many stocks of bees which had from time to time established themselves in the roof of his house. Each colony occupied the vacant space between the rafters forming the roof, their combs being attached to the inner side of the boards to which the slates were nailed externally, and from whence they were carried down to the lath and plaster, a depth of about ten inches. To compel the bees to extend their combs out into the boxes he had prepared and set up to fit the square space cut out of the lath and plaster, he had the spaces below the combs boarded off level with the bottom of the boxes. Their ends fitting into the spaces were quite open, and top and bottom fitted with bars and slides for supering and nadiring, with glass fronts and thermometer for observation.

The plan succeeded so well that the first season he took from these two hives half a hundred-weight of beautiful honey. The following season, to prevent swarming, he had to go on nadiring till he had one of the colonies occupying four roomy breeding-boxes. He took much interest in watching the proceeding of the bees through the front windows of the boxes, and became so deeply engrossed that he diligently read up all he could get hold of on the subject. He determined to transfer some of these colonies to bar hives, and during winter he carefully removed the board of the boxes to which the combs were fastened, and in their stead substituted tier upon tier of bar-frames, but found it a great difficulty to fix the combs in these. By patience and perseverance the difficulty was overcome, and at length the bees were safely lodged in these hives, and he was rewarded the following season by quite a haul of honey.

Although he kept the key of the loft in his pocket, necessary operations during summer would set a few workers free and they would get into the house, much to the annoyance of its inmates. He was consequently obliged to indulge his growing passion for bees by purchasing a couple of stocks from a weaver at the village, transferring the contents of the musty old skeps into his improved bar-frame hives.

It chanced that about this time he saw some beautiful supers of honey in Stewarton boxes in a grocer's shop in Glasgow, which attracted his

attention, and, asking the price, he found three guineas asked for one of the best. Next season he again visited the shop, and was told by the dealer that the honey all came from Ayrshire, and was chiefly the product of white clover. He was previously familiar with the milking qualities of the Ayrshire cow, and from this display of honey was naturally led to the conclusion that that county was literally a 'land flowing with milk and honey.' He therefore determined to explore the system that could produce such honey, and with this object in view made a tour the following season.

Authority after authority on the bee was ransacked in vain for the Stewarton system—all were alike silent. The projected trip was carried out, and so pleased was he with what he saw that he determined to try it himself. Stewarton hives were procured, and by painstaking study of the system he very soon succeeded. It was not long, however, before he found he could improve the hive, and this he did by altering the bars, which were $1\frac{1}{2}$ inches wide, with $\frac{3}{8}$ -inch slides between them, to $1\frac{1}{8}$ inches for the breeding-boxes. He also increased the depth of these from 7 inches to 9 inches, and later added frames to the central bars. He was always a warm advocate of these hives, and maintained that the Stewarton was the best hive for working men, whose object was to get a good supply of honey. He also invented a queen-introducing cage, and other things, which he described in the earlier volumes of the *Bee Journal*.

His first contribution on bees was made in 1860 to the *Cottage Gardener*, and he continued to write regularly for that paper (latterly known as the *Journal of Horticulture*) until the death of Mr. Woodbury, who conducted the bee-department of that periodical. When the *British Bee Journal* was started, he commenced writing for it from the first number in 1873, and has been faithful to the *Journal* ever since. In this *Journal* he brought the Stewarton hive into prominent notice, tracing its origin to Sir Christopher Wren. The Rev. R. Saunders questioned this, and suggested *Mewe*. This he later accepted, and admitted that the invention of the octagon hive was due to Mr. William Mewe.

Mr. McPhedran wrote under the *nom de plume* of 'A Renfrewshire Bee-keeper,' and stated that his reason for doing so was that when he first wrote to the *Cottage Gardener* he found Mr. Woodbury, who was the leader, had adopted the *nom de plume* of 'A Devonshire Bee-keeper,' which carried with it an idea of the writer's whereabouts, for comparison of seasons, &c. This *nom de plume* Mr. Woodbury used down to the last, and Mr. McPhedran determined to follow him, and hoisted the 'distinguishing pennant,' a 'Renfrewshire Bee-keeper.' He was in frequent correspondence with Mr. Woodbury, and was supplied by him with the first Ligurian queen, and also imported foul brood from Devonshire.

Mr. McPhedran was an able writer and critic, and in all his controversies he was always

courteous to his opponents, though firm in the advocacy of his principles. Of a broad, liberal, and well-cultured mind, he was one of the most genial and interesting companions one could find. It is a good many years ago since we first made his acquaintance, and we have been in constant and frequent correspondence with him nearly up to the end, his last letter being that of April 11th, in which he tells us about his attack of bronchitis, and being obliged to have an eminent physician from Greenock.

He was a faithful friend to the *B.B.J.*, and not only introduced it to his friends, but never failed to send us anything of interest culled from local papers. Not only has he obtained new adherents, but on several occasions he purchased 100 extra copies of the *B.J.* at one time to circulate among his bee-friends. The biography of Miss Macdonell, of Glengarry, pleased him so much that he forthwith ordered 150 copies of *B.J.* to be sent to him. His last contribution was the biography of Mr. John Love, which appeared in the number for January 22nd of this year.

Mr. McPhedran had a serious illness about two years ago, from which he appeared to recover thoroughly, and when we then visited him he seemed in perfect health; but it was, doubtless, a forerunner of the speedy end. In the beginning of March of this year he caught a cold, which developed into an attack of bronchitis, and this continued with more or less obstinacy to the end. Behind this, however, there was a valvular affection of the heart, and the physician's certificate showed 'cardiac disease' and 'pulmonary congestion.'

By the decease of Mr. McPhedran we have lost an estimable man, whose like we see at long intervals only. He was a fine, strong-built man, and retained his vigour almost to the end. He had been visited by his clergyman (Rev. Thos. Duncan) less than twenty-four hours before he died, and after prayer, in which he always very heartily engaged, he wished his minister a hearty good-bye.

Mr. McPhedran was a Presbyterian, and at home he was most careful of the religious and Scriptural training of his household. He was a regular attendant at his church, and to his minister and family there never was a truer or kinder friend. Every new boy who entered his employ received a Bible and a 'Shorter Catechism.' He was questioned on them every Sunday, and a prize was given for exact repetitions of Catechism and Psalms. In fact, Mr. McPhedran represents a class of noble and pious men, some of whom still remain, but many also seem to have passed away. Writing of him, Miss Macdonell says: 'I never met with so many excellent qualities combined in one as I always found in him. Some faults he must have had, but his kind-hearted, generous usefulness, and his religious opinions showing through his words and actions, always struck me as very beautiful and very uncommon.'

His living was most temperate. Spirituous liquors he never touched, and it was with diffi-

culty his physician constrained him, within a week of his death, to accept the least quantity of it even as a medicine. Such power had his conscientious scruples with him that, on being asked to become a Justice of the Peace, his sense of the responsibility incurred in granting licences for the sale of liquor prevented him accepting the position.

In 1881, Mr. McPhedran was dragged into litigation with a claimant for Craigbet, but the claim was declared utterly groundless. The litigation, however, caused him a good deal of trouble, and, doubtless, also expenses arose, although his adversary was saddled with them. Mr. McPhedran was never married, but had a sister living with him at Craigbet, who survives him. He was very fond of flowers, and we were much pleased with his garden, which was always a picture of neatness. Always generous with his flowers, it was in gathering some to send away to a friend that he caught the cold which had so fatal an end. He took a great interest in Quarrier's Homes for Destitute Children, and left 1750*l.* to build a cottage in connexion with these homes.

As one of the leading Scotch bee-keepers he will be missed by bee-keepers generally, and as a friend and neighbour by a still larger circle of friends. To his sorrowing relations we extend our sympathy. Personally, we feel the loss of our esteemed friend greatly, for we had so many interests in common that very soon after our acquaintance a friendship sprang up, and a constant correspondence was kept up to the last, even to his writing to ask us to advise him what had cured our attack of bronchitis. Honey and lemon was recommended, and the letter of 11th April before alluded to was the last in response.

USEFUL HINTS.

WEATHER.—What bee-keeper, we wonder, is complaining of the weather now? In the south it is, as we write, glorious for bees, and they know it, and show it too! Had the 'Royal' Show at Doncaster been fixed to take place a week or so later, a large display of honey would, no doubt, have been staged. As it is, we fear many have been reluctantly compelled to withdraw their entries, for, though supers are filling fast with us, nothing is sufficiently forward for removal. If the present high temperature does not culminate in a thunderstorm, and stop operations, a deal of honey will be secured in the next ten days.

SWARMS.—How do they come? We hear of four and six in one day in comparatively small apiaries, and, as many stocks have perished since last autumn, no doubt in most instances they will be accepted gladly to fill up empty hives. If dead colonies

have left clean and healthy combs behind, these latter will be of the greatest service in helping on swarms to fill surplus chambers during the current year. We arranged a hive for the occupation of a fine swarm of our own the other day by giving four frames of worker comb, two of foundation, and two combs nearly full of sealed brood—most of which we uncapped—left in a stock which succumbed last winter. A box of shallow combs, nearly built out, was placed over the body-box, with excluder between, and the bees, we suspect, have carried much of the stores given them into the surplus chamber in addition to newly-gathered honey, for they are rapidly filling it. The eight frames will form a sufficiently capacious brood nest for this time of year. Swarms treated in this way may easily yield very good returns this year.

When time is so precious, it is folly to give swarms more labour in comb-building than is really needed. Some work in that line must be provided, because it is the comb-building impulse—so characteristic of a newly-hived swarm—which makes the bees labour with such increased energy once they leave the old home to establish a new one, and if this instinct is made the most of this season we shall hope to hear of swarms doing considerably more than merely filling their hives with combs and food for themselves. Some we hear of, only hived ten or twelve days ago, have over twenty pounds in surplus chamber already.

SANDING ALIGHTING-BOARDS.—Why do not bee-keepers more frequently use sand on alighting-boards? The other day we saw the honey-laden bees in an apiary struggling to mount the smooth painted surface of alighting-boards cut at a steep angle, and it was to the tired little creatures very much like 'climbing a greasy pole' to enter their domicile. They slipped again and again in their efforts to get indoors. The owner acknowledged it was very disadvantageous, but had never thought of the 'dodge' of painting the surface of the alighting-board after the day's work was over, and sprinkling a handful of fine sand over the wet paint. His bees in future will have no further trouble in that line.

SELF-HIVERS.—A report appears in this issue of the successful use of one of these the other day. We also note that a firm of appliance manufacturers have brought out a 'hiver' in a somewhat changed form from those in use hitherto. The idea is a

good one; it removes the disadvantage hitherto felt in placing the hive intended for the swarm with its face opposite to that of the full stock. Some hindrance to the free working of the bees resulted from this arrangement, and the new plan is to make the hives in triangular form, thus:

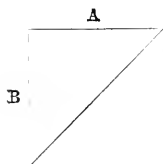

so that the hives are placed at right angles, with their respective fronts facing A and B. The hive fills up the space between. The bees are directed to take a 'curving sweep'—in the act of swarming—from the parent

hive into the new one, and judging from appearances we think it should work well.

SURPLUS HONEY.—'Sectioning' and the filling of combs for extracting will demand most attention now. The value of ready-built combs in stock will be appreciated, much to the advantage of the extracting system as we think, for a world of trouble is saved when it is but necessary to add boxes of combs, the work of a couple of minutes, and the longer they are left on undisturbed the better, until the honey inflow begins to wane. Honey for extracting ripens and is preserved in better condition by remaining on the hives till required for market. Sections, on the other hand, are best removed at once when sealed over; they also require careful attention to secure them in good form and of fine quality, and in view of these things it is quite worth considering whether the production of well-finished sections is adequately remunerative when compared with that of extracted honey. At all events, we consider our honey-producers well deserve all they earn in disposing of good sections at present prices.

CARNIOLAN BEES.—It will be an unmixed blessing to bee-keepers when these bees have absorbed so much of the characteristics of our non-swarmer races as will tone down their excessive swarming propensities. At present they give much trouble to those who work on the non-swarmer system, and so far as reports serve to guide us in forming an opinion, there seems no reliable plan of controlling them. A case has just occurred in which a full body-box of frames, with starters only, had been set below the brood chamber of a hive for some time with the view of stopping swarms, yet the first warm day out they came, though given ventilation, room, and plenty of comb-building to do, at which last operation they had re-

fused to make a beginning. Carniolans have some good points without doubt, but if their faults are not soon 'improved out of them,' we fear they will lose favour in this country.

THE PROSPECTS OF THE SEASON.—It is gratifying to chronicle so favourable an outlook as the present weather affords. After much disappointment there seems to be a very hopeful prospect of a good bee-season; and not a whit too soon, many will say, for bee-keepers will be apt to forget what a real bee-year is unless some reminder of the old days comes around again ere long. The remembrance of a glut year, with 'honey everywhere,' is becoming quite a 'memory of the past' with us, and we shall welcome any approach to a season which will serve to remind us of the good old times, of which the grand weather as we write seems to give us a foretaste. Northern bee-keepers, however, will be likely to reap more advantage from the present fine weather, if it continues, than Southerners, the season with the former having scarcely begun yet; while with the others three weeks of it are already gone.

BRITISH BEE-KEEPERS' ASSOCIATION.

Meeting of the Committee, held at 105 Jermyu Street on Wednesday, June 17th. Present: T. W. Cowan (in the chair), Hon. and Rev. H. Bligh, Rev. Dr. Bartrum, Rev. F. T. Scott, W. O'B. Glennie (Treasurer), J. M. Hooker, Dr. Raynor (*ex-officio*), and the Secretary.

Communications were received from Mr. Jonas, Captain Campbell, Mr. Carr, and Mr. Garratt, regretting their inability to be present. The Finance Committee presented their report, recommending the payment of the prizes awarded at the Bath Exhibition, and also of certain accounts connected therewith. Resolved, that the best thanks of the Association be given to Mr. A. F. Martin for the valuable services he had rendered to the Committee in connexion with the Bath Show.

The Chairman announced that Dr. Bartrum had very kindly invited the members of the Association to spend an afternoon at Wakes Colne. Resolved, that the best thanks of the Association be given to Dr. Bartrum for his kind invitation, and that endeavours be made to arrange for an excursion party from Liverpool Street Station, Great Eastern Railway, on Saturday, July 11th.

Members of the Association desirous of joining the excursion party to Wakes Colne, Essex, by the kind invitation of the Rev. Dr. Bartrum, on Saturday, July 11th, are requested to communicate with the Secretary, J. Huckle, Kings Langley, Herts, not later than Monday, July 6th.

ESSEX BEE-KEEPERS' ASSOCIATION.

The annual county show of this flourishing Association was held at Maldon on June 10th and 11th. Mr. Jesse Garratt had accepted the post of judge, but owing to his serious indisposition, was unable to keep the engagement, and at the last moment Mr. T. W. Cowan kindly consented to fill his place, an honour which the bee-keepers of Essex duly appreciated. As for some years past, the show was held in connexion with the Essex Agricultural Society, forming the Honey and Hive Department of their annual county show, which is the largest got together by any single county, and more nearly approaches in size that of the Bath and West of England Society. Not the least interesting department of the show was the bee and honey exhibition which was placed under the management of Mr. F. H. Meggy, of Chelmsford, as Hon. Secretary of the Essex Bee-keepers' Association, and which occupied a spacious tent and range of shedding adjoining, centrally situate in the ground. The classes were divided into twenty-four competitions. The entries were about the same as last year at Chelmsford, and if the last few weeks of the season had been favourable there would have been a grand show of this year's honey. In accordance with the plan adopted by the British Bee-keepers' Association, most of the honey classes this year were open to the exhibition of either old or new honey, and some very good exhibits were staged; but owing to the inauspicious season there were only two unfinished sections of 1891 honey in the show. Messrs. Dines & Son, the well-known makers of Maldon, and Mr. W. Debnam, of Chelmsford (the expert of the Essex Association), were the only two firms who exhibited in the class for collection of hives and appliances, the latter showing the new Canadian super-clearer. Mr. A. Gayford, of Hervey Street, Ipswich, was a competitor against them in the class for the most complete frame hive. A very useful lot of hives, with all the latest improvements, were exhibited. Wax formed two very strong classes, and the quality was of such an even character that the judge had not an easy task in awarding the prizes.

An admirable syllabus indicating the times on each day at which 'talks about bee-keeping' would be in progress in the bee-tent, had been scattered broadcast over the town and show-ground, and partly as the result of this, no doubt, there were at intervals numerous gatherings of those interested in the scientific culture of bees.

The talks were given by the Rev. E. Bartrum, D.D., Wakes Colne; Mr. E. Durrant, Chelmsford; Mr. C. R. Finch, Great Baddow; and Mr. F. H. Meggy.

Mr. F. H. Brenes, Brentwood, and Mr. F. Tunbridge, Broomfield, rendered valuable assistance in the tent, where an observatory bar-frame hive of four frames, well stocked with bees, proved a great attraction.

Representatives of the Association were pre-

sent in the tent during the whole time the show was open to interview those who came in between the lectures, and to answer questions with regard to bee-keeping.

The driving was chiefly done by Mr. W. Debnam, expert of the Association.

Dr. Bartrum examined two candidates for the B.B.K.A. certificate of proficiency in practical bee-keeping, but neither satisfied the examiner.

Nearly fourteen thousand people paid for entrance to the grounds during the two days of the show.

The Essex Agricultural Society gave 10*l.* towards prizes, and provided covered shedding. The local Committee granted 10*l.* to ensure the attendance of the bee-tent and free lectures. Mrs. Watson and Miss Colvin, sister of the President of the Agricultural Society, took this department under their special patronage, and gave 5*l.* towards the prizes, and special prizes amounting to upwards of 5*l.* were given by Mr. C. W. Gray, M.P., Mr. L. Bental (the Mayor of Maldon), Messrs. L. Belsham, Ed. Durrant, Dines & Son, F. H. Meggy, and J. T. Weston.

PRIZE LIST.

Class 127. Collection of hives, &c.—1st prize, certificate and 1*l.* 10*s.*, Dines & Son; 2nd, 1*l.*, W. Debnam.

Class 128. Frame hive.—1st, 10*s.*, Dines & Son; 2nd, 7*s.* 6*d.*, W. Debnam.

Class 129. Inexpensive ditto.—1st, 10*s.*, Dines & Son; 2nd, 7*s.* 6*d.*, W. Debnam.

Class 130. Pair of section racks.—1st, 10*s.*, Dines & Son; 2nd, 7*s.* 6*d.*, W. Debnam.

Class 131. Frame hive with pair of section racks, by amateur.—1st, withheld; 2nd, 10*s.*, W. Barthrop.

Class 132. Honey, 40 lbs. to 50 lbs.—1st, certificate and 30*s.*, A. Barnard; 2nd, 10*s.*, W. Debnam.

Class 133. Honey, 12 lbs. to 20 lbs.—1st, certificate and 10*s.*, Mr. W. Christie-Miller.

Class 134. Three frames filled with comb honey.—1st and 2nd, withheld; 3rd, 5*s.*, Mrs. T. Jackson.

Class 135. Twelve 1-lb. sections of comb honey.—1st, 10*s.*, Mr. Christie-Miller; 2nd, 7*s.* 6*d.*, W. Debnam; 3rd, 5*s.*, J. C. Chillingworth.

Class 136. Twelve sections 1891.—No exhibits.

Class 137. Six 1-lb. sections of 1890 comb honey.—1st, 10*s.*, W. Debnam; 2nd, 7*s.* 6*d.*, the Rev. F. M. Sparks; 3rd, 5*s.*, F. H. Brenes.

Class 138. Single-section 1891 comb honey.—No award.

Class 139. Twelve 1-lb. jars of extracted honey.—1st, hive value 15*s.*, Mrs. Cobb; 2nd, 7*s.* 6*d.*, W. Debnam; 3rd, 5*s.*, J. C. Chillingworth.

Class 140. Six 1-lb. jars of extracted honey.—1st, 10*s.*, A. Mayell; 2nd, 7*s.* 6*d.*, Mrs. Cobb; 3rd, 5*s.*, W. Debnam.

Class 141. Twelve 1-lb. jars of granulated honey.—1st, 10*s.*, F. H. Brenes; 2nd, 7*s.* 6*d.*, W. Debnam; 3rd, 5*s.*, Mrs. T. Jackson.

Class 142. Beeswax, from 2 lbs. to 3 lbs.—1st, 5s., Mrs. Cobb; 2nd, 3s., W. Debnam; 3rd, 2s., A. Mayell.

Cottagers' Classes.

Class 143. Collection of honey, 12 lbs. to 20 lbs.—1st, certificate and 10s., C. M. Collins; 2nd, 7s. 6d., G. Gibson; 3rd, 5s., A. Mayell.

Class 144. Section of 1891 comb honey.—1st, withheld; 2nd, 3s., J. Winter.

Class 145. Six 1-lb. sections of comb honey. 2nd, 5s., A. Mayell.

Class 146. Six 1-lb. jars of extracted honey.—1st, 7s. 6d., A. Mayell.

Class 147. Beeswax, 2 lbs. to 3 lbs.—1st, 5s., A. Mayell; 2nd, 3s., J. Winter; 3rd, 2s., C. M. Collins.

Class 148. Home-made hive.—1st, certificate and 10s., F. Tunbridge.

Bee Shows to Come.

Secretaries will please forward brief particulars of any Shows not included for insertion in this column, as early as possible to: 17 King William Street, Strand, W.C.

July 2nd.—Kent Association in conjunction with the Rose and Horticultural Society at Farningham, Kent. Entries close June 27th. Jesse Garratt, Hon. Sec., Meopham, Kent.

July 8th.—Middlesex B.K.A. County Show at Hampton. Hon. and Rev. H. Bligh, Hon. Sec.

July 15th, 16th.—Armagh. Mr. E. Best, Armagh.

July 15th, 16th.—Notts Agricultural Society at Nottingham. Bees, honey, and appliances. Entries close June 20th. For schedules, &c., A. G. Pugh, Hon. Sec., N.B.K.A., 49 Mona Street, Beeston, Notts.

July 23rd, 24th.—Lincolnshire Agricultural Society at Brigg. Stephen Upton, Sec., St. Benedict's Square, Lincoln.

July 28th to 31st.—Highland and Agricultural Society at Stirling. Mr. T. D. Gibson-Carmichael, Melrose, N.B.

August 5th, 6th, and 7th.—Yorkshire Agricultural Society at Bradford. Entries close June 27th. Marshall Stephenson, Sec., York.

Correspondence.

BEEES FIGHTING AMONG THEMSELVES.

[687.] I intended to write to you a fortnight ago on the above subject, but was prevented by pressure of various kinds. I have not the slightest doubt of the correctness of the suggestion made by a correspondent that the apparently unaccountable quarrels of bees of the same hive occur through confusion of odours, consequent on part of the community feeding on honey given to them from some other stock, and possessing a strong and very different aroma from that stored by the particular community. A friend of mine in this

neighbourhood—a member of the M.B.K.A.—had detailed to me, some weeks ago, the account of a serious fight which had taken place in one of his hives after he had supplied them with frames of honey from another stock. On his inquiring what could be the reason of the occurrence, I at once suggested the above explanation, the truth of which seems to me beyond doubt.

The subject is of great importance. A sure preventive would be to spray the combs of the stock, and those to be introduced from another hive, with weak syrup slightly scented with peppermint.—W. H. HARRIS, *Ealing, Middlesex.*

CARNIOLAN BEES.

[688.] May I trouble you with my troubles? I am the fortunate (?) possessor of two stocks of Carniolan bees. I have two neighbours who hold six or seven stocks of the same nationality. Not one of these gave us one ounce of honey last year, they did not even store enough for their own sustenance. This year their frames are not worked full of comb, and the cry is, 'The Carniolans are swarming again!' They invariably settle on the highest trees, in the most inaccessible places (to the bee-keeper). The trouble they give, as compared to blacks or Italian hybrids, is in proportion to the maximum of honey stored by blacks to the *nil* stored by Carniolans. Their much-vaunted gentleness I must call 'cussed laziness.' They are too idle to sting. Why? Because they are too idle to store, so they have nothing to protect. Do they come from a colder climate than ours, that the genial temperature of some days in our summer is more than they can bide? If so, do you think I could get a Greenland queen from the 'icy mountains' to restore the balance by mating with one of our numerous Carniolan drones? I have studied and valued the *B. B. J.* for nearly two stages of my life, and I am in this position. A young lady wished to commence bee-keeping, and upon the faith of opinions in the *B. B. J.* I bought her a stock of what have turned out to be 'cussed lazy ones.' She reminds me now that for twenty months she has kept bees, as they would not attempt to keep themselves. So consider how I have fallen in the opinion of one under whose sunny glance I would have risen—I dare not say how much! Awaiting your help,—TINKER, *Hertford, June 15th.*

SELF-HIVERS.

[689.] Just a line to say that I hived a swarm by means of the 'self-hiver' on June 4th, after being on only two days. This is considered early for this district.—W. PATTINSON, *Sunderland, June 7th.*

NOTES BY THE WAY.

[690.] Well, Mr. Editor, we have entered on summer at last. Though long wished for, and late in coming, it has not failed us, verifying

the old, old text, 'Summer and winter, seedtime and harvest, shall not fail.'

My bees have changed from want to plenty. Only a short time back we were feeding to keep them from starving, and now they are booming and roaring—literally rolling in wealth. Swarming has become general, the tone of the skeppist is changed from doleful strains to a good 'brag,' and all goes merry as wedding bells. In my home apiary we have had swarming in all directions—to the right and to the left, in front and in the rear, while swarms that located themselves in prepared hives with combs last Sunday now want supering (Thursday), showing what British bees are capable of if only the weather is right.

Queen-wasps are still numerous, and every one is killed that it is possible to reach. I look forward to some trouble with them this coming 'barley harvest.' I never remember them so numerous as this spring, showing the rascals are hardy.

I can endorse the argument of 'Croftamie' (G76, p. 271), on scent in bees, and have no doubt his idea is very feasible about bees entering and cleaning out old combs, thereby getting perhaps a musty scent, and with such are not allowed to enter their home without molestation.

I hope the weather will hold up all the time of the 'Royal Doncaster' this week, and that the honey classes will be fairly well filled. If this grand bee-weather had come a week sooner, we should have had a good show of honey staged. The 'Royal Counties' is at Portsmouth this year, but owing to the exclusiveness of the Hants and Isle of Wight Association, the show of honey must be of a limited quantity, as it is confined to the county of Hants and three miles outside—but as a great part of this three-mile boundary is water, it does not include many bee-keepers. I must conclude these short notes, as another swarm is on the wing, and where is the bee-keeper who can pleasantly write when bees are swarming? *Au revoir.*—W. WOODLEY, *World's End, Newbury.*

CHEAP FEEDERS.

[691.] Your readers may find the following letter, which was kindly addressed to me, interesting and useful.—E. BARTRUM, D.D., *Wakes Colne Rectory, Essex, June 12th.*

'DEAR SIR,—I have just been reading your letter in the *Bee Journal* and remarks about cheap feeders. I venture to describe a plan of my own, which is cheap enough and which I find answers very well. It consists of the lid of a coffee tin, or, when I want to give more food, an old sardine tin, with a hole punched through the centre with a large wire nail. Then I have a little piece of tin about the size of a sixpence, which also has a hole punched through the middle, with a wooden peg fixed tightly in it. This fits loosely into the hole in the box, and the syrup gets under it. The bees take it, I dare say, by their mouth; they shake the peg,

and so promote the flow. I then lay a piece of glass on the top, and it is complete. When feeding I move the glass a bit on one side, and pour in till the food touches the glass. If at any time it gets clogged, all one has to do is to take hold of the peg and raise it, and it clears itself. It is important, of course, that the little piece of tin should be quite flat, or the syrup might escape too quickly. I find that by this plan I can feed five or six hives in a very few minutes, with hardly any mess and without making my hands sticky. For filling these feeders, at least the small one, I use an oil-can with a long spout, but with the sardine tin a bottle or jug will do. It is a simple matter, and it is very cheap. The feeders stand on a bit of wood with a hole in it.—J. W. NAPIER.

ULSTER B. K. ASSOCIATION.

[692.] A letter headed 'Joining Bee Associations,' on p. 233 of your issue of 14th May last, signed 'J. D. McNally,' though not of general interest, concerns me, so I beg leave to trespass a little on your valuable space to correct an erroneous impression it seeks to give, *i.e.*, that the Ulster Bee-keepers' Association is a select or exclusive association.

Your remark on 'blackballing' is hardly applicable in this case, as I will show, nor can I find that any one was ever blackballed by this Association, nor, except in this case, did any one to my knowledge ever fail to gain admission thereto.

Mr. J. D. McNally classes himself as a 'beginner,' so, perhaps, he may not be the Mr. McNally who exhibited honey at the North-East of Ireland Bee-keepers' Association Show in 1888. I believe, however, that at least one member of the Committee present at the meeting when Mr. McNally's name was proposed, was under the impression that he was the same. The name was proposed by me in the usual way, but was not seconded, so could not be put to the vote. Regretting that your pages should be occupied with such a matter as these letters—J. FREW, *Assistant Secretary, U.B.K.A., Belfast, June 13th.*

NAPHTHALINE AND FOUL BROOD.

[693.] I am sorry to have to trouble you again after the pains you took last year with a case of foul brood in my apiary, and I tender you my thanks for the advice you then gave, which I think has proved successful. The stock then affected is now apparently perfectly healthy; but will you kindly give me your opinion of the piece of comb sent by this post, which I have to-day taken from another stock? I don't think it is foul brood, as two years ago the same stock was similarly affected, and you then pronounced it not foul brood. I also submitted to you a similar piece of comb from another strong stock in the village, which you pronounced not foul brood; but the question is,

If this is not foul brood, what is it? and why two years ago, and again now, should the brood die in this manner?

If you find foul brood it may be interesting to you to know that this stock has been carefully spring-fed every night with Naphthol Beta in syrup (seeing you are now very much recommending it), and that rather more than a week ago, in cutting out comb to send to you, I put a teaspoonful of naphthaline on floor-board, same as that sent to you, and in examining to-day was agreeably surprised to find only one dead grub in the whole stock. This, to me, speaks highly for the naphthaline. I hope you will not conclude it is chilled brood, as the piece of comb was taken from the middle of a strong stock. The only mention I can find in my bee-books of anything similar is in Simmins's book, where he attributes brood dying to the want of vigour in the queen—but that certainly cannot be the case with mine, as the stock is very strong. Is the sample of naphthaline enclosed the right kind? My chemist tells me it is pure naphthaline, but I am afraid it has not sufficient odour to be effectual. It certainly is not so strong as that I used last year.—L. H. W.

[We have very carefully examined with the microscope the contents of comb sent, and can find no trace of foul brood. You ask us 'not to say it is chilled brood,' and we would gladly not do so, since it is so difficult to realise that the brood can have become chilled under the circumstances stated; but there are all the usual symptoms of chilled brood in the remains of the dead larvæ under the microscope, and we can offer no other explanation of the fact. The naphthaline sent is the kind known as albo-carbon, sold in sticks and pounded. It is scarcely so powerful as the pure white crystals we use, but we are glad to notice its beneficial effects in your case. Mind and not overdose the bees with it, as some have done recently.—Ems.]

CHEAP FEEDERS.

[694.] In Dr. Bartrum's letter (675, p. 269), he asks for a bee-feeder that can be used with less inconvenience than those now in use.

I have recently taken out a 'provisional specification' for a hive I have named the 'English' hive, in which this matter was considered, with the result that, with this hive, the bees can be fed at side of hive at all times (with or without crate on top), with either syrup or dry food. Next week I hope to send you plan and particulars of the hive.—A. T. WILMOT, *St. Albans*.

TRADE CATALOGUE RECEIVED.

WM. McNALLY, GLENLUCE, N.B. (32 pp.)—Mr. McNally has this season extended his neatly got-up price-list, and included in it is to be found almost every necessary required for bee-keeping purposes. The specialities of this catalogue are metal roofs for hives, a list of prices for hives in the flat, honey-comb designs, and recipes for candy and syrup-making.

Queries and Replies.

[367.] One of my stocks (a hybrid Carniolan) is on ten frames, with ten empty frames fitted with half-inch starters underneath, as I wish to prevent swarming if possible. There was also a crate of sections on, partly worked out. On Saturday, the 13th inst., the bees were seen coming out in large numbers, the air appeared full of them and the ground strewn, and my people at home thought, of course, the bees were swarming. My wife threw a wet cloth over the hive, and in about ten minutes most of the bees had returned to it, and matters quieted down. I was told, that when the bees returned, they hung in a large mass from the alighting-board, and also completely covered one of the hive legs.

For two or three days previously the sections appeared full of bees, but little work was done. On reaching home about two p.m., I opened the hive, cut out four or five sealed queen-cells, placed an outside frame, which had no brood but only some stores, in centre of hive, and a second crate of sections underneath the first, and the bees yesterday seemed inclined to work; anyway, they did not cluster in the upper sections, but flew freely. Can you account for the commotion? Is it possible the bees attempted to swarm, but the queen refused to go? I do not think any actually went, as although I did not see the queen afterwards, it may be because I did not look carefully for her. The bees were so thick on the combs that I had to shake them off before I could see the queen-cells.

Have I done the best thing, or what could I have done better? Can I do more to prevent swarming, and would you advise me periodically to look for and cut out queen-cells? I do not like pulling the hive to pieces more than need be.—EAST DULWICH.

REPLY.—You should clear up the uncertainty as to the queen being still with the bees or not. If the swarm has returned to the hive through some mishap to the queen, your action in destroying all the queen-cells will be disastrous unless eggs are given the bees, from which to raise another queen.

[368.] *Decoy Hives*.—My hives cannot be constantly under observation. If I were to place an empty hive, fitted with comb foundation, alongside the hive I expected to throw off a swarm, would the swarm be likely to take possession of it? Would there be any harm in placing such an empty hive alongside a full one? Would it create the inclination to rob? An answer will oblige.—SUBSCRIBER, *June 17th*.

REPLY.—The chances are very much against your own swarm taking possession of the vacant hive, though it is quite common for stray swarms to enter hives left prepared for occupation. No harm will result from your placing the hive as proposed.

[369.] *Separating Queen from Bees and Brood*.—I have a stock wintered on a double set of frames, but which are working in the top story only. There is plenty of brood in this top story, and I wish to place the queen in bottom story, and confine her there. Is it best to change the bottom frames to the top and *vice versa*, or brush the bees from top frames, leaving the bees in latter case to return to brood and hatch out, leaving queen in bottom meanwhile?—J. G., *Great Wyrley, June 17th.*

REPLY.—On no account do as you propose. If you did, the bees would probably pass through the excluder to the brood above, and leave the queen alone in the body-box below to die. If you move the queen at all into the lower chamber, the brood and bees must be moved with her.

[370.] Have you, or any of your friends, ever tried the 'Conqueror' hive, and does it carry out all the Crown Bee Company claim for it?—EAST KENT.

REPLY.—We have not, but cannot answer for others.

Echoes from the Hives.

Honey Cott, Weston, Leamington, June 13th, 1891.—At last we seem to have got a whiff of summer, although the nights are very cold—and don't the bees enjoy it! We have hawthorn out in abundance; also the beans are just coming into bloom. I was coming across a field on the 10th (after going to hive my second swarm at a small experimental out-apiary), and saw quite large patches of white clover just breaking into bloom, showing unmistakably that it is no myth to get whitethorn and clover honey. Have got a lot of stocks supered, and hope that we may soon have some honey, as I should like to try the bee-escape. Just a word to friend Woodley: There is a lot of *forget-me-not* in my garden, and my bees have worked on it a good deal. Whether they get much out of it or not I cannot say.—JOHN WALTON.

Willsnack, Germany, June 15th, 1891.—We have had here all through May and June the worst imaginable weather for bees—night-frosts, rain, and such weather that bees are unable to fly. New and old colonies have had to be fed. Swarms of May 22nd, notwithstanding daily feeding, have not been able to build out two inches of comb.—C. J. H. GRAVENHORST.

Stratton St. Margaret, Wilts, June 15th, 1891.—A 'bee-autiful' week's weather for the bees. Our doctor had two swarms on Wednesday last and one on Saturday. Our season is very backward—quite a fortnight later than usual. Our main 'flow' will not commence for a week yet. No grass has yet been cut. To-day is very windy, with sharp showers this evening.—C. J. G. GILBERT.

Rivington, Chorley, Lancashire, June 15th.—Bees here have at last had a glorious week, working on the hawthorn and carrying in water; and how delicious the smell of the hives in the

evening!—it cheered me up to the extent of putting ten frame supers on two or three hives, and now, alas! the weather has changed, and the cold N.E. winds have come again. This year the bees are fully a fortnight behind. I have not heard of any swarms about here. I find corks, cut in two or three pieces, and put in the water, prevents the bees from drowning better than anything else. I do not like tea-leaves, as they decay. I sprinkle a pinch of salt in the water every two or three days, as I once noticed a number of bees drinking on the grass, after a shower of rain, where some salt had been accidentally spilt, and ever since I have supplied them with it, and they seem to like it.—A. AULSEBROOK.

Notices to Correspondents and Inquirers.

Letters or queries asking for addresses of manufacturers of correspondents, or where appliances can be purchased, or replies giving such information, can only be inserted as advertisements. The space devoted to letters, queries, and replies, is meant for the general good of bee-keepers, and not for advertisements. We wish our Correspondents to bear in mind that, as it is necessary for us to go to press in advance of the date of issue, queries cannot always be replied to in the issue immediately following the receipt of their communication.

A. W. PING (Auchtertool, N.B.).—Queen sent is an old one; she shows no trace of Ligurian blood.

W. J. S. (Woodford).—We should say the best districts, at the distance named, are on either the G.N. or S.E. lines.

ELLIS E. CRISP (Stafford).—Queen was dead when received; she is evidently old and exhausted, hence her breeding only drones.

ANXIOUS (Draycott, Derby).—The queen looks much older than one year. Are you not mistaken in her age? The body is too dry for dissection.

COL.—If you will send another piece of comb with dead brood we will examine it under the microscope, and report. From inspection with the naked eye we should say it is not foul brood. No stamped envelope was enclosed.

E. C. R. W.—If you will read the *Guide-book* carefully, you will not find any inconsistency in the two passages you allude to. You have overlooked the fact that in the chapter on 'Nucleus Hives,' the time of fertilisation is given from the time of inserting queen-cells, and not from the laying of the eggs. Deduct 'three or four days' from 'the week, or little more,' and you will find the period of flight agrees with the passage alluded to.

S. A. HUGHES.—Something in the nature of a race between bees and pigeons is supposed to have taken place in Germany a year or two ago, and the matter has several times been referred to in our columns.

R. DUTTON (Witham).—Queen is an old one.

R. GODSON (Alford, Lincs.).—The bees have evidently deposed and killed the queen themselves, and the 'turn-out' witnessed would be just due to the excitement. It has been very common this spring for bees to destroy their queens in this way.

ON HIRE, BEE TENT.—For Terms apply to A. J. BROWN, Hon. Sec., Bradley, Wotton-under-Edge, Gloucester. 238

'PERFECTION' QUEEN-EXCLUDING ZINC.

THOMAS B. BLOW begs to announce that he is sole Wholesale Agent for HARVEY & Co.'s New Pattern **QUEEN-EXCLUDING ZINC**. This particular perforation is absolutely perfection for its purpose, and is an exact reproduction of one of the patterns known as

DR. TINKER'S QUEEN-EXCLUDING ZINC.

Purchasers are cautioned to be careful to observe that they get zinc with the exactly correct width of perforation (which this is), as much of the zinc at present on offer is either too large or two small—thus either letting the queen pass through or excluding the worker-bees.

For retail prices see Catalogue, sent free on application. Special quotations, according to quantity, will be given to dealers.

THOMAS B. BLOW,
MANUFACTURER OF BEE-KEEPING APPLIANCES
WELWYN, HERTS.

LINCOLNSHIRE AGRICULTURAL SOCIETY.

BRIGG EXHIBITION, 1891.

PRIZES to the amount of £25 are offered for **HONEY, HIVES,** and **BEE APPLIANCES,** to be exhibited at **BRIGG,** on the 23rd and 24th of **JULY** next. Entry closes July 7th.

For **PRIZE LISTS** and **FORMS** apply to

STEPHEN UPTON,
St. Benedict's Square, Secretary.
Lincoln, 3rd June, 1891.

NAPHTHOL BETA.

AS we find that some of our Subscribers are not able to procure the right sort of **NAPHTHOL BETA,** we shall be pleased to supply any who are not able to obtain it through the usual sources, at 1s. a packet, post free. The packet contains an ounce, and is sufficient to medicate 145 lbs. of sugar. Printed instructions accompany each packet. *British Bee Journal* Office, 17 King William Street, Strand, London.

BRITISH BEE-KEEPERS' PRACTICAL NOTE-BOOK,

With Rules for the General Management of Movable Comb Hives.

By **THOS. W. COWAN, F.G.S., &c.,**
Editor British Bee Journal.

Consists of a Series of Tables by means of which the Bee-keeper can keep a record of all his Observations and Operations. A Pocket-companion indispensable to the practical Bee-keeper.

Price 1s., postage 1d.

Bee Journal Office, Kings Langley, Herts; and 17 King William Street, Strand, W.C.

THE HONEY BEE:

Its Natural History, Anatomy, and Physiology.

By **T. W. COWAN, F.G.S., &c., &c.,**
Editor of the British Bee Journal.

Cloth gilt, price **2s. 6d.;** postage $2\frac{1}{2}d.$

London: **HOULSTON & SONS,** Paternoster Square;

ALL BOOKSELLERS; AND

British Bee Journal Office, Kings Langley, Herts; and 17 King William St., Strand, London, W.C.



W. P. MEADOWS,
NEAR
SYSTON, LEICESTER.

PATENT EXTRACTORS.

A SPECIALITY.

- THE RAYNOR 30/0**
- THE GUINEA 21/0**
- THE WINDSOR 12.6**

THE VERY BEST AND CHEAPEST MADE.

New Gearing with Ball Bearings.

NEW CATALOGUE POST FREE.

My Specialities are—

- EXTRACTORS.** | **XL ALL HIVE.**
- NEW FRAME.** | **W.B.C. ENDS.**
- FEEDERS.** | **SECTION CASES.**
- DIVIDERS.** | **SMOKERS, &c.**

FOLDING SECTION CASE (Registered)

Sample, with Glass, 6 STAMPS, 12 Plain Tin, 10 Glass, 18 STAMPS.

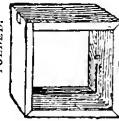

Perforated at Corners so as to be easily folded.

WITH GLASS,

22/- per Gross; 2/- per Dozen.

PLAIN TIN, NO GLASS,

10/- per Gross.



FLAT, FOR TRAVELLING.

Beautiful Enamel at half usual price. Send for List.

THE

British Bee Journal,

BEE-KEEPERS' RECORD AND ADVISER.

No. 471. Vol. XIX. N. S. 79.]

JULY 2, 1891.

[Published Weekly.]

Editorial, Notices, &c.

ROYAL AGRICULTURAL SOCIETY'S SHOW AT DONCASTER.

We are glad to record a very successful week at Doncaster. Beginning with the journey down, the 'bee-keeper' arose within us at the sight of extensive sheep-pastures white with clover-bloom following each other in rapid succession right through Herts, Lincolnshire, and on into Yorkshire. It made one sigh for 'a good time on it' for the bees, and so far the weather has been all on our side. Excepting a brief but heavy downfall of rain on the third day, it has been warm and bright, favourable for the show and for the bees at home. A hundred acres of the town moor, or racecourse of St. Leger fame, were boarded off for the requirements of the show, and its fine park-like turf was admirably adapted for the purpose. Moreover, the people of Doncaster are so accustomed to 'handling' great crowds, that half the elements of success were there beforehand.

The broad highway known as the York Road, allowing free driving-room for six or seven lines of vehicles, was quite a sight with its never-ending stream of conveyances going and coming to and from the 'course'; then the roomy footway for pedestrians, flanked by noble trees, which, affording a grateful shade from the hot sun, tended to give one the idea that the place had been designed and laid out with the special object of providing for the passage of large bodies of people from the town to the racecourse. Anyway, it served that purpose well last week, for there was no inconvenient crowding, no 'blocks' of vehicles; indeed, it was quite a 'comfort' to either walk or ride the mile and a half of distance between the town and show-ground, forming a marked contrast to the constant stoppage and difficulty of locomotion in the 'long walk' in Windsor Great Park a couple of years ago.

Arrived at the ground we at once made our way to 'the bees.' By the way, let us here give a 'hint' to all bee-men who attend 'Royal' shows, and often experience some trouble in finding out where the bees are located, the same spot being arranged for each successive year. If the visitor, on entering the ground, bears round to the left, keeping close to the outer line

of the stands on that side, he may continue his walk till he reaches the bee department, surmounted by a flag with the large black figure of a bee upon it.

The first view of the frontage to the bee-shedding impressed us favourably; indeed, county secretaries and those who have the management of shows would do well to adopt either the same arrangement or some modification of the plan wherever the extent of the exhibition warrants it. Mr. Huckle has worked now for some years improving and perfecting his method of displaying the exhibits to the best advantage, and we venture to say that, if all the entries for honey had been staged, the show at Doncaster would have been the best-arranged one yet held.

The total length of shedding occupied was 125 x 25 feet, a stand running right round the shed on its three inner sides. Here were staged the several collections of appliances, a fine Observatory hive stocked with bees dividing each exhibitor's goods from those of his neighbour, and as the bees of all these had free flight to the outside they worked comfortably and laboriously every day while the show lasted. The bees confined in Unicomb Observatory hives—of which three were staged—had a less happy time of it, and it would be an improvement if it were made imperative that all bees shown must have the means of flight provided.

The frontage of the shedding was mainly occupied by the single hive classes, and that for extractors, the whole of which were staged on a low platform, sixty feet long. Raised above the hives at the back ran a light open shelving, on which exhibits in the several classes for comb and for extracted honey were displayed, both sections and glass jars being well seen from both sides. At each end stood a table, about seven by four feet, intended for the accommodation of Class 311, *For the best and most attractive display of Honey*; but, as only four exhibits of the nine entries put in an appearance, all were staged at one end.

The bee-tent, wherein manipulations and lectures took place, was admirably situated about thirty yards away, just in front of the main portion of the department, a most convenient position, as the attention of visitors could be easily directed to it, and large audiences were present at each of Mr. Green's lectures.

On Friday, Sir Jacob Wilson, hon. director

of the show; Earl Cathcart, chief steward; the Mayor of Doncaster; Mr. Ernest Clark, secretary, and several members of the Council, who were accompanied by Lady Wilson and other ladies, paid a visit to the bee department. They were received by Mr. Cowan, who explained various matters connected with bee-keeping to them.

At a special lecture which was arranged for them, the visitors expressed themselves much pleased with all they had seen and heard. Altogether the incident of the visit afforded a further proof of the interest taken in the bee department by the leading members of the Council and their friends.

The attractiveness of the bee-exhibits was considerably enhanced by the beautiful flowers and plants generously sent, in response to the Secretary's request made in our columns, by Miss Cooper, Leicester, and Messrs. Hodgeman, Boding, Kent; Pickering, Elmswick, Yorks.; Sells, Alfreton; T. Giles, Cowfield Apiary, Salisbury; and Green, Rainham, Kent. Several boxes of fresh flowers arrived during the week, and Mr. Huckle is indebted to the senders for enabling him to keep all so bright and attractive while the show lasted.

THE EXHIBITS.

The total number of entries in the fifteen classes connected with bees, hives, honey, &c., was 143, and, excepting those for honey of the current year, there were few absentees. Class 300, for *collection of hives and appliances* (seven entries) was a good one, Messrs. George Neighbour & Sons taking the first prize of 5*l.* with an excellent display of goods, well made and thoroughly efficient from the practical point of view. The second prize of 2*l.* 10*s.* went to Mr. W. Dixon, of Leeds, who was run very close for second place by another northern exhibitor, Mr. A. C. Jemieson of York, the latter being highly commended. The winning points in the second prize exhibit were gained in the 'other distinct articles beyond those enumerated in the schedule.'

Class 301. *Best observatory hive stocked with bees.* (Seven entries.)—Some fine hives were shown in this class, the first prize being an especially good stock of bees on six combs, while the second and third were on four combs respectively. A fine colony of Carniolans—completely filling a thirteen-frame glazed hive, besides a single comb in a separate unicombed hive filled with bees, and the presumed queen of the hive below—was unnoticed by the judges, probably in consequence of its not fulfilling the requirements of the schedule.

Class 302. *Best hive for general use.* (Nine entries.)—The first prize was taken by a hive known as 'Neighbour's W.B.C. Hive,' with the general features of which readers of the *B.J.* are familiar. Here, again, the accuracy of make in the article staged was much in its favour. It consisted of body-box and shallow-frame chamber, each with ten frames, and the section box described on page 276 of our issue for June 18th. The only feature in the hive we did not

care for was an alteration in the original size of the outer case. Here the maker, in order to secure some supposed advantage in making the outer case square, has reduced the space between the back of the hive and the outer case so as to render packing at that part difficult. We advise a return to the more oblong form as in the original, where there is nearly one and a half inches of packing space on three sides. The second prize was awarded to Mr. C. Redshaw for a well-made hive of the same type, but with a different porch and entrance, and an ordinary rack of sections in lieu of that shown in the premier exhibit. Mr. Redshaw also gained third prize for a double-walled hive of somewhat similar construction to his 'Nottingham' hive, the difference consisting in the substitution of a shallow-framed surplus chamber for the second body-box of standard frame, with its unsightly double porch, and the lift in two parts, as introduced into the same hive at Plymouth last year.

Among the six unplaced exhibits in this class were some very good hives. No. 296, staged by Mr. E. C. Walton, had an uncanny look by reason of the numerous 'buttons' fixed to each of its various parts to keep all together. It was a cheap hive at the price (15*s.*), and included a ten-frame body-box of standard frames, with shallow-frame super, convertible into a cover for section rack if needed. No. 297 was a very commodious hive, suitable only for very good honey districts. The body contained thirteen standard frames, and there were, besides, two shallow-frame surplus chambers, with thirteen frames in each—in all, thirty-nine frames for brood and honey. Messrs. Neighbour, who exhibited this hive, do not often allow 'faults' to exist in their goods, and this fact impels us to notice one blemish in an otherwise excellent hive—the same fault also existed in Mr. Walton's exhibit just mentioned—viz., the open space below the lug of the frame ends, in which stray bees are imprisoned only to perish when stori-fying the surplus chambers one above another. No. 301—Meadows' 'XL all' hive—has the advantage esteemed by some bee-keepers of having its various chambers square in form, so they can be worked at will with frames either parallel or at right angles to entrance. We do not like Mr. Meadows' method of fixing the porch to the floor-board. It is surely better to lift it off and on along with the outer case.

In Class 303—for an *inexpensive frame hive for cottagers' use* (eleven entries)—Mr. Redshaw took first and second prizes with hives priced at 10*s.* 6*d.* and 12*s.* 6*d.* respectively, the cheaper article getting first place. Both these hives are well-known ones of Mr. Redshaw's make, and are excellent articles for the money. An adaptation of his 'XL all' hive by Mr. Meadows was awarded third prize, the body, frames, roof, and stand being priced at 8*s.* 3*d.* Of the remaining exhibits in the class some were too high-priced, hives at 19*s.* 6*d.*, 15*s.*, and 14*s.* 6*d.* each scarcely meeting the idea of 'an inexpensive

hive for cottagers' use,' as specified in the schedule.

Class 304. *For the best honey extractor.* (Three entries.)—Mr. Meadows received first award for the 'Raynor,' with an improvement (?) in the form of a 'gearing' similar to those used in tricycles. The maker takes the precaution to include with the machine means for dispensing with the multiplying gear and for using the simple handle affixed to the shaft, which would seem to meet all requirements. Messrs. Neighbour's second-prize machine could easily be made much less cumbersome by reducing the diameter of the cylinder without in any way detracting from its efficiency. It is practically the 'Rapid' designed by Mr. Cowan some years ago, and holds two shallow frames in each of the swinging cages, in which the combs reverse without removal. A 'highly commended' was given to Lowth's improved 'Unique' machine, which is now made to take in standard and shallow frames as well as sections.

Class 305. *For the best pair of section racks.* (Eight entries.)—Messrs. Neighbour got first prize for a pair of section boxes illustrated in our pages recently in the article on 'Working for Comb Honey.' It is called Neighbour's 'W. B. C.' section box, and needs no further description than has already appeared. Mr. C. Redshaw took second prize for a good pair of racks of the well-known type in general use, and Messrs. Neighbour were highly commended for their second exhibit.

Class 306. *Best rapid feeder.* (Seven entries.)—Manufacturers are still busily occupied in improving and perfecting this useful implement in the apiary. Slow feeders are well-nigh as perfect as they will be, but the more recently introduced rapid feeder has not yet exhausted the ingenuity of inventors, judged by the exhibits staged in this class. Complaints have been justly made against wood for the syrup-troughs, because of frequent leakage, and its becoming soured by frequent use, and rather tending to induce fermentation. But for these defects it is quite possible the commended exhibit of Mr. Meadows might have been placed first. It is a very practical attempt to combine a slow and rapid feeder in the same article, and if after full trial it develops no weak points in the way of leakage, we hope to see it again stand in competition with those placed before it at Doncaster.

Mr. Redshaw's exhibit, which took first prize, is a dual feeder, and may be used in combination, or singly on two stocks. Priced at 3s., it is a remarkably cheap article, and a good one for the purpose. But along with Messrs. Neighbour's second-prize article it had the fault of requiring the removal of the 'lift,' generally used when large feeders are on before the glass cover can be removed for refilling. Messrs. Neighbour were awarded second prize for a large feeder, in which leakage is avoided by the syrup-trough being made of tin. It is a good article, but would be improved by raising the central wood portion of the feeder one-eighth of an inch above

the tin trough to allow free passage for the syrup below. Though well worth the money, the price (6s.) is rather against it. We should also like to see all rapid feeders so made that covers may be raised or lifted off for refilling, without the necessity for disturbing the 'lift'—nearly always used to raise the roof when the feeder is on the hive. Most makers overlook this point. Taken altogether, the articles staged in this important class were very good indeed.

Passing for the present the honey classes, we come to—

Class 312. *For useful inventions introduced since 1890.* (Fifteen entries.)—This was a fairly interesting class this year, though several of the exhibits were obviously *not* 'inventions introduced since 1890,' and had to be passed over in consequence. The most ambitious exhibit in the class was that of Mr. P. Harbordt, who made a meritorious attempt to design a hive which may be sent out in the flat and put together almost entirely without nails. The hive staged was but a hand-made one to illustrate the principle of its construction, and 'it is intended eventually to have it made entirely by machinery.' After a severe test we must say the 'twin-dovetail' used makes a remarkably stiff, strong, and rigid joint, and (if it will not loosen by shrinkage) it is quite as firm as if nailed together in the ordinary way. The judges awarded a silver medal for the exhibit, and we shall await with some interest the further development of the idea. Messrs. Neighbour also got a similar award for the 'W. B. C.' section box already noticed, and a bronze medal was given to Mr. W. P. Meadows for his new registered frame. The very attractive little rack of glass sections exhibited by Mr. Redshaw was highly commended. For those who appreciate a handsome case of glass sections to show to friends, in which the bees can be seen at work above and on all sides, this will be much admired. A 'swarming arrangement,' staged by Mr. Dixon, would, we fear, prove a 'blocking' arrangement unless some frames were removed to allow free ingress into the new hive while the 'rush' was on. The new 'Hill' smoker, shown by Mr. Meadows, arrived too late for competition.

Class 313. *For the best-designed model of a tent.*—This brought but one entry, by Mr. P. Harbordt. It was more in the form of a 'screen' than a tent, and will require some alteration in the arrangement of the guy-ropes, or we fear visitors standing round to watch the manipulations inside the screen would be uncomfortably hampered by them. The use of strong bamboo canes for the ordinary tent poles is a good idea; and as the designer hopes the whole tent will be put up and taken down in a few minutes, while the total weight is estimated at only eighty-four pounds, it is a commendable attempt to introduce a portable tent for use at small shows, where the 'expert' may carry it off with him and take it by rail as personal luggage, thus avoiding the expense and delay in transit which so frequently causes trouble with the ordinary

bee-tent. The judges awarded a silver medal to Mr. Harbordt, though expressing their feeling with regard to the small defects of the exhibit.

Class 314. *For the most interesting exhibit not mentioned in the foregoing classes.* (Three entries.)—Mr. W. Dixon, of Leeds, was awarded a second prize for an interesting case of specimens, natural and otherwise, among them being a swarm of bees clustered on a branch, a honey-comb design, specimens of bees preserved in spirits, photographs, and numerous other things possessing interest to bee-keepers.

A notice of the honey classes, together with the full prize list, will appear in our next issue.

THE BEES OF THE OLD WORLD.

If we draw a diagonal line, beginning at Genoa, Italy, and ending at Tripoli, Africa, across the Mediterranean, we find the bees east of this line inclining to the yellow race—Italy, Greece, Turkey, and Egypt having the banded bees, while Tripoli, Tunis, Algeria, Morocco, Spain, and France have the black bee. Just as the banded Italian differs from its fellow-insect in Egypt, so does the black of France from that of Tunis and Tripoli. On the north of the Mediterranean the Alps are the limits, while on the southern shore the Lybian Desert forms a barrier. Again, if we compare all countries where Mohammedism has had its sway for any length of time, we find those countries lying like a big crescent, one tip beginning at the Pyrenees, the concave line running down below Italy, and mounting again to the Bosphorus, including Greece. These have hives lying horizontally, and, as a general rule, worked more humanely than those in the region of the 'cross.' Italy forms the vertical axis; the hives stand upright, and the bees are sulphured every autumn, to take away all wax and honey. In southern Europe the bar-frame hives are finding their way with great difficulty.

In the south of France the bee-keepers (or, rather the keepers of bees, for there are none that are real apiculturists) possess between five and one hundred hives, which they keep in long square boxes, about three feet high and one foot broad. The top is nailed with a board, while the bottom is open, and put simply on a flat rock or stone, the unevenness of which forms different flying-holes. Some are also kept in hollow tree-trunks with big flat stones on the top, on an inclined plane for the rain to run down, and, at the same time, by its weight to keep the hive from falling in case of wind. Generally they place them against a wall, to shelter them against the north and west winds. They expose them to the south and east.

It is a very curious sight to see a number of those hives standing upright and irregular, just as a flat rock may be right or left, up or down, in crooked trunks, with huge stones on top. I confess the apiaries away in Palestine or on the borders of the Nile, or in the wild recesses of the Atlas Mountains in Algeria, do not present such a novel and altogether savage aspect as

does such an apiary in a civilised country, where everything is flourishing except apiculture. How often since I have been wandering about the Provençal Alps, and finding such neglected apiaries, have I put the question to others as well as to myself, 'Why is apiculture so low in such a beautiful country, abounding in fruit-trees, red and white clover, thyme, rosemary, heather, and a deal of other plants too varied to enumerate?' They are free from taxes. The only answer I invariably got was, 'The cruel winter kills so many bees, thus discouraging the farmers.' I came across an old bee-book, written by an 'Abbe Della-rocca,' in Syria, in the Grecian Archipelago, and printed in Paris in 1790. The book is very ably written—or, rather, the three volumes—and it seems that, more than a century ago, the bees were treated here just the same as they are now; and the desolate priest says the cause of neglected apiculture in France is because the noblemen had a certain right on beehives; and, second, when the farmer could not pay the heavy taxes asked for the treasury, the tax-gatherers would take away his hives to fill up the sum. Disgusted with such robbing, they finally gave up bee-keeping. Since then the French Revolution has put a stop to all these abuses; but, still, apiculture has not come to its bloom. It was inevitable that this discouragement should then become so general that a century has not sufficed to wipe away the bitter feelings that have so fast taken root in the French country people.

The way they now work the hives is as primitive as can be imagined. The swarms are lodged in a box or trunk of a tree, as above described, and left alone. In autumn all hives are visited and 75 per cent. are left untouched 'for seed' as they call it. The other 25 are sulphured, and the combs, with the honey, sold to dealers who come yearly to buy all they can. The 75 are the stock left to swarm the following spring. Such hives are full of honey and pollen, and are capable of giving good swarms. This part is very humane, but not very remunerative to the owner. If the 75 have wintered safely, a good stock and strong apiary follow next spring. They never (but in a very few cases) take out a part of the honey. In consequence of such treatment, they want no smokers, no veils, and, generally speaking, no bee-keeping utensils. The honey and wax merchants are experts in this kind of apiculture, and take the hives destined to be sulphured to death and weigh them. They then deduct the possible weight of the empty hive, and pay for the wax and honey per pound. They scrape out comb, honey and dead bees, and put the whole into wooden tubs, taking as much as 150 lbs. of comb. The hives are then covered, and they thus go around from one apiary to another. When the waggon is well loaded they drive home. The comb is now broken up into the smallest possible pieces, and put into a stone trough having a wooden sieve at the bottom, thus permitting the honey only to pass; and by an outlet into a receptacle, such a trough may easily take over a thousand

pounds. This first honey is sold on the market as virgin honey, mostly stored away in wooden barrels, holding between 140 and 190 pounds of honey. The residue of the trough is now put into flat baskets, having a small opening at the top to introduce the comb; and half a dozen such flat round baskets are now put under a large press, with a big wooden screw acting on the pile of baskets. On top of the baskets a board is laid to produce equal pressure. The honey from this pressing is impure, and is sold as second-rate honey in the same receptacles as the virgin honey. A good deal of honey is sold to the factories of Montelimar, Arles, Aix, Nîmes, Narbonne, &c., where honey cakes are made. No Frenchman will pass his Christmas without having a taste of these honey cakes, called *nougats*. Hundreds of thousands of pounds are consumed yearly. They are made of honey, sugar, and almonds. The trouble is, they keep only during the cold season. As soon as the hot weather comes on they begin to flow. Thus they are sure to be fresh every year. The comb pressed out is now put into a big cauldron and boiled. When it is well fluid this is put into the same baskets again, which are now furnished with long straw, and, as quickly as possible, put under the press again, and received in wooden receptacles. While the pressing is going on, boiling water is poured over the pile of baskets to keep the wax flowing. In some cases the farmers do the whole work themselves, pressing out the honey with their hands, and putting the boiled wax into a sack, and twisting at both ends to get the wax out. This wax is generally of a nicer colour, as being better strained, while the honey is not as pure, having a mixture of pollen, wax, &c.

The bee in the south of France is black, showing some white bands at the first and second rings. The fuzz is strongly inclined to yellow; a slight tinge of orange marks both sides of the first ring. Very few men (as a rule no bee-keepers) have any movable-bar-frame hives, either Langstroth, Abbott, or Bastain. None of them have an extractor. They can have only a very little more honey than the 'fixists.' About Toulon, Cannes, and Nice, they move their bees on mule-back to the higher Alpine regions in summer, putting the hives individually in sacks, tied at top. In autumn they bring them back again, and then take the honey in the manner above described. In Nice a single woman had a beehive in a cork-oak trunk, only the bark being used as a hive. She was selling comb honey right out of the hive. The bees, naturally enough, had been sulphured previously. The hive was well filled with sealed comb, and might have contained 40 pounds of honey. No robbing was going on, as the hives are kept some distance from town; and even Nice had such weather in January as to keep bees at home. They seldom have ice here, though. Flowers are sold all the year round. Foreigners from England, and even America, flock here in winter.—PH. J. BALDEN-SPERGER, in 'Gleanings.'

Correspondence.

The Editors do not hold themselves responsible for the opinions expressed by correspondents. No notice will be taken of anonymous communications, and correspondents are requested to write on one side of the paper only, and give their real names and addresses, not necessarily for publication, but as a guarantee of good faith. Illustrations should be drawn on separate pieces of paper.

Communications relating to the literary department, reports of Associations, Shows, Meetings, Echoes, Queries, Books for Review, &c., must be addressed only to 'The Editors of the "British Bee Journal," 17 King William Street, Strand, London, W.C.' All business communications relating to Advertisements, &c., must be addressed to Mr. J. HUCKLE, Kings Langley, Herts (see 1st page of Advertisements).

* * * In order to facilitate reference, Correspondents, when speaking of any letter or query previously inserted, will oblige by mentioning the number of the letter, as well as the page on which it appears.

IN THE HUT.

'Like the leaves of the forest when summer is green.'

[695.] Green, leafy June here, and 'X-Tractor' has lost six weeks of life! Slipped by like a dream, and *la grippe* is but a memory! *Lost*, say I? Not entirely so, for in my enforced abstinence from business and all literary work I found that, certainly amongst our fraternity, I was thought kindly of by many more than I wot of, and this I expressed to you in a letter privately. I have still a further penalty to bear, I find. I cannot spare even a day on my way up to town for the 'Royal Show,' where I had anticipated meeting so many old friends in the craft; and again, I must also miss entirely my county show, at which I should have some duties to perform.

I would like Dr. Bartrum to know that I did not fail to see the point, the 'grim' point, of his kindly reference to myself on p. 269.

'All thing, which that shimeh as the gold
Ne is no gold, as I have herd it told.'

CHAUCER.

Yet year after year I have had what I called golden bees come into my hives, bees as richly golden and glistening as a nugget in the sunlight, but until to-day I have not known whence came the glittering chrome-hued pollen—it is from the gorse. The overhanging, bent bow-like stamens manage to rub their dust quite on the back of the bee, on the thorax (as the bee seeks the nectar), whence it is difficult to dislodge it.

A week ago I was in Dublin, and could not fail to notice (where bee-appliances were sold) what a profusion there was of straw skeps on sale—higher and rather narrower skeps than our own. There seems to be plenty of work in Ireland for modern bee-teaching in the way of wooden hives. Abbott Brothers make a prominent display on Merchant's Quay. The last of Ireland I saw was a bit of true Emerald Isle—far away across the sea, on Bray Head, bright green fields surrounded clear yellow patches of wild mustard (charlocks and ketlocks we call them), and when I get home I find this very

stuff the only sustenance worth mentioning for my bees. Two stray heads of white clover give promise of a good time for bee-keepers, although it is certainly three weeks late. Being so late I fancy bee-keepers will score off the farmer for once. The grass is much too short to think of cutting, so I think the white clover will get a fortnight's start of the haymaker; they generally mow it down hereabouts just when it is in its pride of bloom, so as to prevent it shedding its seed on the field, and thus robbing the hay of much weight and nutriment.

Having got sections and shallow frames on, I have, of course, stopped feeding, but have put on the outside of the super one or two half-filled frames of heather honey, of no other use to one except in mead-making. I find they are removing the honey, drawing out or renewing the cell walls with immaculately white wax, and working on the foundation with a vicious 'vim' particularly characteristic of heather honey-getting. To go near them means to soon withdraw from the unpleasant society of those omnipresent bees who consider it part of their duty to see one safely (?) out of the garden.

Everybody will have noticed how the beech-trees were blasted by the May blizzard, but we have yet to notice how conspicuous the sycamore bloom is by its absence. A bee-keeper I spoke to to-day says the frost nipped the bloom, which dropped off in withered bunches: yet still we must not murmur, for we cannot alter things one jot, and must be thankful things are not what they might be, for although we cannot say—

'Oh, fragrant is the scent of new-mown hay,
Which telleth June is here—the sultry June;'

we know—

'The fields are green, the skies are bright,
The leaves are on the tree;
And 'mong the sweet flowers of the thyme,
Far flies the honey-bee.'

And to-morrow also to fresh woods must fly—
X-TRACTOR.

FINDING THE QUEEN.

[696.] Has it occurred to you, Messrs. Editors, how many of your readers must be, to a great extent, deprived of scientific pleasure in their bee-keeping by not being able to find the queen? Take my case. I have kept bees long enough to be able to handle them gently and fearlessly, and I love to watch them. I have four colonies, and the enthusiasm for forty. In a small hive I can sometimes find Her Majesty, but in the case of a teeming hive—and it is just then that the question of her whereabouts is often most important—I am constantly at fault. Hence failures of introduction, and loss of time and money.

Now, cannot you do something for us? Doubtless with yourself, and most of those who write in your columns, it is a matter of routine to open any of your hives and find the queen.

But can you not recollect the time when you couldn't manage it?—the feeling of shame when, with an inward apology to the patient or, occasionally, somewhat ruffled bees, for having disturbed them so long for nothing, you shut up the hive and went away dejected? How did you get over the difficulty? Please do not answer, 'Practice and the personal instruction of an expert.' The latter we cannot all of us command, while there must be many hints to assist the practice; many little signs in the behaviour of the bees, &c., to tell where to look; ideas as to what the queen is likely to be doing—all of which would be most useful.

Any hints that you or any experts can give will be received with gratitude by many of your subscribers, and especially by—A SOUTH DEVON ENTHUSIAST.

[It is quite impossible to find queens by any 'rule of thumb.' And the 'many little signs in the behaviour of bees' are so difficult to define in print that we cannot do more than say that, when opening a frame hive, the operator should put aside the first two combs he comes to, and confine his first examination to the combs of the brood nest proper. He should also accustom himself to the appearance of the queen, whose legs are longer and lighter in colour than those of the workers.—Ers.]

HIVE TEMPERATURE.

[697.] I have been asked some questions on the temperature of hives which seem quite outside of any book-teaching, either foreign or English, that I can find to refer to. Would you kindly insert the following, if it has any interest for readers; you might tell me if there is any explanation of these observations taken by a very keen bee-keeper, who is more skilful in handling his bees for science' sake than for profit. He writes:—'I am managing three frame hives beautifully this year, at last forming straight combs and strong stocks, but I never succeed much with my supers. I use only strips of calico now directly over the frames, and strip each piece off as I please, and the bees mind it very little indeed. Smoking is so easy, too; run the nozzle along the comb you mean to inspect and no others. A carpet frame also is a great thing: strong square wood frame with carpet bottom to place over these linen strips. It holds all loose carpet pieces, and odds and ends, and ensures a close fit of the warm cover. Why does the hot air of the hive come out of the mouth? Does it mean that a continuous stream of cold air is pouring down from above? If so, surely the upper layers of brood must be easily chilled.

'I have taken the temperature of the draught which came out of my hives. I have proved by smoke that the draught is an outward one, at times quite suddenly violent, rarely blowing in for a moment at one side or another. The temperatures are something like this on an average:—

'Air=55° in shade. Top of bar-combs over

linen and under carpet= 68° . Outward breeze from mouth of hive below= 72° .

'This is the result of some six or seven experiments on four hives, viz., two bar-frames and two skeps. In the mornings there is no such draught, only in the hot evenings. [I suggest that these observations were probably taken during the most excited period prior to the swarming of each hive, when the overcrowding of the bees returning home at night might account for a greater zeal in the fanning at the doorways. Would this be a fair deduction?]

'How can I tell whether a swarm hived four days ago is a cast or not? I have already secured three strong swarms from my four hives but this last one is not strong, and to-day I see that although the bees have built well, the cells have honey in them and not an egg to be seen. Must a cast have a queen, and if there would she be laying eggs in the first-finished cells?

'What is the best modern book which treats of the social life of the bee from season to season apart from the commercial point of view?'—F. H., *Slough*.

[1. It is quite certain that there is an inward as well as an outward current of air in hives, strong or weak according to the temperature outside and in, and these currents are made more rapid in hot weather by the vibration of the wings of the 'fanners.' If a lighted taper is held at the hive entrance, the flame will indicate the different currents. 2. You can only decide whether a swarm is a top swarm or a cast by some knowledge of the stock it comes from. 'Piping' is always heard prior to the issue of a second swarm. 3. Simmins's *Modern Bee-Farm* treats of bee-keeping from the commercial point.—EDS.]

TIMELY HELP.

[698.] In *B. J.* of April 23rd is a query from 'F. K.,' of Bournemouth, which you have answered. The writer desires to set up a poor man with bees and the necessary apparatus. I would willingly supply him, gratuitously, with a lot of surplus hives, &c., which I have no longer use for if you would kindly put me in communication with 'F. K.,' for, of course, a letter so addressed would never reach your correspondent.

I still keep a few bees in my garden, but last year I had sixteen stocks. I have given up trying to carry on a bee-farm here, as we are on a wretched clay, and Ryde is, perhaps, the worst place in England for bees. The southern half of the island is admirable, but we are a good four miles away from it. All the land about here is being laid down in pasture, and very poor pasture it makes. Bournemouth, I know, is quite different, and bees there ought to put many an odd half-sovereign into a poor man's pocket, besides supplying him with a wholesome relish to his bread and butter. Please help me if you can.—C. S. P., *Ryde, Isle of Wight*.

[We are extremely pleased to find that the publication of 348, p. 201, has produced the above generous offer, which has been gratefully accepted,

and there is, therefore, a fair chance of the working man referred to making a very favourable start in bee-keeping.—EDS.]

EXPERTS' CERTIFICATES.

[699.] I should like to have the views of other experts upon the certificate given to those who pass the B.B.K.A. Expert Examinations. I consider it of a most paltry character, and, whereas many of us would be pleased to have a nice, bright, artistic certificate, framed and hung up in our homes, the present one is usually consigned to oblivion.

Considering that a better certificate is given for honey, and that all first and second-class competitors pay the parent Association a fair examination fee, I think we ought to have something better.—A. G. PUGH, *Second-class Expert*.

CARNIOLANS.

[700.] Your correspondent, 'C. C.' (684, p. 282), is evidently 'down upon' everything which is not British, and the gentle, pretty Carniolans in particular. But his experience of them is apparently limited to *two* queens only, and these he thinks undoubtedly were the cause of foul brood in his apiary. Poor dears! they have much to answer for. I doubt very much if they are at all more liable to foul brood than blacks; at any rate, I have kept several stocks for the last five years, and have never seen the least suspicion of disease. We frequently hear them condemned as inveterate swarmers, but here, too often, the management is at fault; nothing less than twenty frames should be used for the brood chamber when a good queen heads a colony of Carniolans.—C. B.

SWARMING IN SCOTLAND.

[701.] At Sandyford, near Paisley, a stock on shallow-bar frames cast a good natural swarm on the 16th ult. The first last year was on the 20th of May—it is, therefore, nearly a month behind last season; this was followed by two swarms on the 19th, one of which, headed by a pure Carniolan queen, was a very large lot indeed, and by another on the 20th.—AUGUSTUS.

AN APRIL SWARM.

[702.] I cut the following from a local paper:—'If the old adage be true, that "a swarm of bees in May is worth a load of hay, and a swarm in June is worth a silver spoon," what must be said of the following incident: On April 28th a swarm of bees flew into the garden of the Rev. A. T. Crisford, Ovington Rectory, and took possession of an empty hive. They soon commenced work, and remain here.'—C. T.

ULSTER BEE-KEEPERS' ASSOCIATION.

[703.] After reading the reply (692, p. 291) of the Ulster B. K. A., through their Assistant Secretary, I may say the explanation, if not edifying, will be found, at least, amusing. Not a word is said as to why my admission was refused, and as to the uncertainty about my having exhibited at a certain show, surely the books or records of shows, meetings, &c., of the Association would clear up the point? Your correspondent also reports me as having exhibited honey at the North-East Show in 1888, and in this he is wrong. The previous year, 1887, I did, in company with my brother, exhibit at Belfast very successfully. But what has that got to do with the point at issue? It appears I am the only individual who has been refused admission, and I must perforce conclude there is something against my character or conduct. That being so, I think I am entitled to ask that some reason should be given in print for refusing me as a member of the Association, so that I may have an opportunity of admitting or denying the charge against me.—JOHN D. McNALLY.

[We have omitted from the above letter a considerable amount of very strong language, which can have no interest for general readers; besides, we wish our correspondent would kindly understand that personal quarrels or disputes are quite unsuited to our pages, and, if allowed to have free scope, would take up space which may be more profitably occupied. Personalities are objectionable in every way, and, as our object is to avoid creating ill-feeling among readers, we shall continue to repress them wherever we can.—EDS.]

ADVANCE IN PRICE OF BEESWAX.

[704.] All readers of the *B. B. J.* are no doubt interested in the recent advance in price of beeswax. The *Apiculteur* for June says on the subject: 'On account of very large purchases for Russia, wax has gone up to a price unknown for several years. The stocks existing in the seaports of Marseilles, Havre, and Hamburg have been bought up in a few days, and our interior stores have exhausted their annual provision.'—PETER BOIS, *Jersey, June 26th.*

VISIT OF THE B. B. K. A. TO WAKES COLNE RECTORY, ESSEX.

SATURDAY, JULY 11TH, 1891.

Arrangements for the day:—Railway Station, Chappel, Great Eastern Railway, half a mile from Wakes Colne Rectory.

A train leaves Liverpool Street (main line) at 12, and should reach Chappel at 1.23. Fare for return tickets, third class, about single fare and a quarter. There is a later train at 2.36, due at 4.12 at Chappel. A return train to town should leave Chappel at 6.49, and is due at Liverpool Street at 8.52. It may be necessary to change at Mark's Tey both in going and returning.

Objects of Interest.—The village of Chappel, as seen on the left-hand side in coming from

Mark's Tey; a high viaduct, with numerous arches, running across the Colne Valley, to be noticed on the way to the Rectory; the village of Chappel, with its church; the Rectory grounds, with garden, orchard, and garden-orchard; the apiary; the old Norman church, opposite the Rectory; two 'rams,' which supply water to the Manor House and Rectory, about half a mile distant (open to inspection by the kindness of Mr. C. Page Wood); the valley of the Colne, opposite to the Rectory, full of rustic beauty and interest; the tennis lawn for players with tennis shoes.

Lunch at 2; tea at 5.45.

A few ladies can be conveyed in a carriage from the railway station to the Rectory and also to the return train.

It might be well for members intending to visit Wakes Colne to send a postcard intimating their intention, to be despatched not later than Thursday, to the Rev. Dr. Bartrum, Wakes Colne Rectory, Essex.

AN EARLY MORNING WITH THE BEES.

With gloom and chilling wind each day,
The wished-for spring has past;
But now, with warm and gladsome ray,
Bursts out the sun at last.

And, see! against the cloudless sky
The apple-blossom fair;
For sun still stays, and will not die
Till it has had its share.

With joy resounds each hill and dale,
Again the cuckoo calls,
And in the woods the nightingale
Sings when still evening falls.

Thou in this joy, too, hast thy part,
O happy, busy bee;
Swift from the hive I see thee dart,
Singing in merry glee.

In sunshine only, wilt thou roam,
Thy honey-bag to fill;
Thou wisely keep'st within thy home
When days are damp and chill.

But when comes glorious summer-time,
The deep-toned murmurous sound,
Of thousands of thee in the lime,
Spreads music all around.

Oh! would that we, in such glad mood,
Sped on our work in life,
Striving, like thee, for others' good,
Calm 'midst its noisy strife.

Of Nature's gifts, since ancient days
Thee most have poets sung,
Praising thy works and wondrous ways,
In lands of ev'ry tongue.

Fly forth, while sun doth brightly glow,
To honey-yielding flowers;
I to the gloomy town must go,
To spend day's brightest hours.

June, 1891.

EVAN FRANKS.

Queries and Replies.

[371.] *Legal right to Bees that have Swarmed.*
—Last week I had a heavy swarm of bees, which were hived the same day. The next day they were seen to leave the hive, and after travelling a distance of 400 yards, they entered an empty hive belonging to a neighbour, who also keeps bees. He refuses to give them up, saying that he has a right to them, because they were not followed in a direct line. To have done so would have been to trespass on other people's property. They were followed round the road and seen to enter the hive, which my neighbour does not deny was empty. I should feel grateful for any advice on the subject.—**LIVE AND LET LIVE, Horndean, Hants.**

REPLY.—If you have witnesses who observed the bees leave your hive, and, without losing sight of them, saw them enter the hive of your neighbour, you can recover the value of the swarm in the County Court if he will not return the bees or pay for them.

[372.] *Photographs of Honey Displays.*—Could I get photographs of successful 'artistic displays of honey,' as exhibited at some of the leading shows? Also, would it be admissible to include in such displays for competition 'shallow frames' of comb honey?—**A. FINLAY, Johnshaven.**

P.S.—Clover out—fair amount of bloom; luxuriant display of 'skellach'; bees storing honey rapidly.—**A. F.**

REPLY.—1. Some photographs were taken of the displays of honey at the 'Colinderies' a year or two ago. Mr. Huckle might be able to inform you if copies can be had. 2. Certainly! Shallow frames of comb, if protected by glass, form a very handsome addition to a 'display.'

Bee Shows to Come.

July 8th.—Middlesex B.K.A. County Show at Hampton. Hon. and Rev. H. Bligh, Hon. Sec.

July 15th, 16th.—Armagh. Mr. E. Best, Armagh.

July 15th, 16th.—Notts Agricultural Society at Nottingham. Bees, honey, and appliances. Entries closed June 20th. For schedules, &c., A. G. Pugh, Hon. Sec., N.B.K.A., 49 Mona Street, Beeston, Notts.

July 23rd, 24th.—Lincolnshire Agricultural Society at Brigg. Stephen Upton, Sec., St. Benedict's Square, Lincoln.

July 28th to 31st.—Highland and Agricultural Society at Stirling. Mr. T. D. Gibson-Carmichael, Melrose, N.B.

July 29th, 30th.—Leicestershire B.K.A., in connexion with the Leicestershire Agricultural Society, at Leicester. Entries (except for honey) close July 11th. Entries for honey may be made up to 22nd July. H. M. Riley, Tower House, Leicester.

August 5th, 6th, and 7th.—Yorkshire Agri-

cultural Society at Bradford. Entries closed June 27th. Marshall Stephenson, Sec., York.

Sept. 5th.—Alderley Edge and District Branch of the Lancashire and Cheshire B.K.A. Chelford Flower Show, Astle, Chelford. Schedules, &c., T. D. Schofield, Alderley Edge, Cheshire.

Echoes from the Hives.

Belle Vue House, Castel, Guernsey, June, 1891.—The weather has been so warm here since the end of April that I was tempted to remove some of the winter coverings from the hives, but your advice in *B. J.* restrained me, and instead I put a crate of twenty-one sections filled with foundation on each of the two strongest. The other lot was weak through having a queen which only laid about a score of eggs daily, so united the bees to another lot, using flour as a pacifier. I did not succeed well, however, for about a fourth of the weak lot were killed. I am now left with three bar-frame hives, one of which, when examined about a fortnight ago, had two frames nearly full of brood, and two others with small patches thereon. On the 15th I peeped into the supered hives, each of which had twelve frames covered with bees before supering, and found that the bees were working well there; so I hope bee-keeping is going to pay here in spite of all I have heard to the contrary. Apple-trees are in full bloom, as are also field beans. Plum, cherry, and pear-trees have nearly finished; everything seems promising so far. I am getting quite interested again over my bees, and would feel very miserable without them. For several evenings I have noticed a peculiar smell (something like a raw potato when cut) coming out of the hives. I don't think it is foul brood, as it has never been heard of in the island. Would it be the pollen or the brood? Do you think my bees are in a fair way to do well this year?—**E. M. R.**

[There is no cause for alarm at the smell noticed. Your bees are evidently doing very well.—**Eds.**]

Notices to Correspondents and Inquirers.

Letters or queries asking for addresses of manufacturers or correspondents, or where appliances can be purchased, or replies giving such information, can only be inserted as advertisements. The space devoted to letters, queries, and replies, is meant for the general good of bee-keepers, and not for advertisements. We wish our Correspondents to bear in mind that, as it is necessary for us to go to press in advance of the date of issue, queries cannot always be replied to in the issue immediately following the receipt of their communication.

All queries forwarded will be attended to, and those only of personal interest will be answered in this column.

T. MARSHALL (Crewkerne).—To establish a legal claim to a swarm you must have a witness who did not lose sight of the bees from the time they left your hive till they entered that of your neighbour. As regards the cash value of the swarm, 25s. is too high; 15s. is as much as could be claimed, seeing that swarms are regularly offered for sale at even less than the latter sum.

J. S. SLOSS (Aberdeen).—The stock is badly affected with foul brood, and should be burnt. We only advise using the hive again after thorough disinfection, but combs and frames should be entirely destroyed.

BEWILDERED (Hexham), and HENSEL (Hawthurst).—Comb is affected with foul brood.

A. J. FISHER (Penkridge, Staffs).—*Pure Cane Sugar*.—The advertisement is only withdrawn for the present. Cheques to be made payable to J. Huckle.

HYBRID.—Yours on 'Bee Associations in the Midlands' will appear next week.

R. W. P. (Notts).—Comb is foul-broody—not very bad, as bees are hatching from the cells while here; but the disease is unmistakably there.

COL. (Swindon).—We have examined comb and bees under the microscope, and find foul brood in the former. The blood of the workers contains bacilli, showing the presence of foul brood. The queen sent also contained a good many in her stomach, but otherwise appeared quite healthy.

*** Owing to the Doncaster Show we are compelled to hold over several communications till next week.*

ON HIRE, BEE TENT.—For Terms apply to A. J. BROWN, Hon. Sec., Bradley, Wotton-under-Edge, Gloucester. 238

WOOD BEE FEEDERS.—Hold 2 lbs. Syrup, 6d. each, by post, 6d. extra; 5s. per dozen on rail. Address J. M. BALMERA, East Parade, Alnwick. 2920

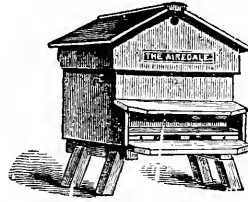

THE YORKSHIRE
Bee-keepers' Supplies.

WILLIAM DIXON,
5 Beckett St., LEEDS.

Hives, Extractors, Smokers,
Feeders, Foundation, &c.
Prizes awarded, Gold, Silver,
and Bronze Medals. 226

PRIZES awarded at the ROYAL AGRICULTURAL SHOW,
held at Doncaster:—
Second Prize for the Best Collection of Appliances.
Second Prize for the Best Observatory Hive, stocked with
Bees.
First Prize for the Best Display of Honey.
Certificate for Swarming Arrangements, and other Prizes.

CHEAP WOOD FEEDERS,

HOLDING ONE POUND OF SYRUP.

Can be used for Fast or Slow supply.

4d. each, postage 3d. No. 88 in List.

Bright Foundation, 1/10 lb. Darker ditto, 1/3 lb.

EDEY & SON,

STEAM JOINERY WORKS, ST. NEOTS.

LINCOLNSHIRE AGRICULTURAL SOCIETY.

BRIGG EXHIBITION, 1891.

PRIZES to the amount of £25 are offered for HONEY, HIVES, and BEE APPLIANCES, to be exhibited at BRIGG, on the 23rd and 24th of JULY next. Entry closes July 7th.

For PRIZE LISTS and FORMS apply to

STEPHEN UPTON,
St. Benedict's Square,
Lincoln, 3rd June, 1891. Secretary.

Hants and Isle of Wight Bee-keepers' Association.

President: H.R.H. PRINCESS BEATRICE.

SHOW AT PORTSMOUTH

IN CONNEXION WITH

THE ROYAL COUNTIES AGRICULTURAL SOCIETY,

JULY 14th, 15th, 16th, and 17th, 1891.

PRIZES FOR HIVES, HONEY, WAX, BEES, &c.

OPEN TO THE UNITED KINGDOM.

ENTRIES CLOSE JULY 7, 1891.

Applications for Prize Lists to be made to

Mr. J. J. CANDEY, 197 Commercial Road, Landport.

THE
British Bee Journal,
BEE-KEEPERS' RECORD AND ADVISER.

No. 472. Vol. XIX. N. S. 80.]

JULY 9, 1891.

[Published Weekly.

Editorial, Notices, &c.

USEFUL HINTS.

WEATHER.—A changeable fortnight has passed since our last 'Hints' appeared. Not bad weather by any means, but just that tantalising quantity of cloud and rain which reduces the advantages derived from the intervals of sunshine. Some places have been much favoured in respect of weather, and so far we think that south-eastern counties have had the best of it, for a very fair quantity of honey has been stored in these parts. Only a few days later than the Show at Doncaster came the County Show of the Kent Association at Farningham, and that few days made an enormous difference in the quantity of honey staged at the two places, there being a very nice show of this season's produce at the latter place last week. Whenever a really good bee-day comes, the honey gathered proves how plentiful it is just now, and if we are favoured with even a single week of warmth and sunshine a very fair harvest will be secured. Further north the chances are still more hopeful, for there is yet a full month of gathering-time there, to say nothing of heather prospects, and white clover is now blooming well everywhere.

Judging by what could be seen in a journey between London and Liverpool on the first days of the month, haymaking was as forward in Lancashire as in the south, and as the first crop of mixed clover was cleared from the fields, some return should be got by the bees from second-crop bloom, now growing luxuriantly after the recent rains.

SWARMS.—Swarming has now extended northwards, and, as with ourselves and swarms of a fortnight ago, northern bee-keepers will be desirous of losing as little as possible of the honey crop through division of colonies by swarming, especially

stocks with a lot of supers partly completed on them. We still advise the plan of accepting top swarms; setting them on the stand occupied by the parent stock; giving a limited brood nest of about seven frames fitted with foundation (or combs and foundation alternately), and at once placing the partly finished super-work above. The bees continue their work in the surplus chambers without interruption, and the comb-building impulse, so characteristic of top swarms, is gratified by the work given them in the brood nest below. By the way, we trust readers of 'Hints' will notice the printer's error on page 287, where, on the eighth line from top of second column, the word is printed 'brood' instead of *food*.

SUPERING.—This is another point requiring careful management in so short a season as this, and a sparing amount of surplus room only should be given while the weather is so treacherous. Upper chambers, in which only a few bees are seen, are better off than on the hives, for it interferes with rapid work below when there is a cold empty chamber overhead.

SUPER - CLEARERS.—These very useful articles, in their latest development, will no doubt be well tried this season, and we trust that reports of success or failure will be sent to us for publication. As to the particular form of clearer likely to become generally used, *that* point will settle itself. If bee-keepers will follow our lead, and try both kinds, it will not take long to decide which is best. In fact, if the simple cone-shaped clearer, which any one can make or buy for a few coppers, will do its work effectually, few will care to invest in the more costly article; on the other hand, if the latter is proved superior in working, we must make one or two clearers do the work of the whole apiary. The difference in the two distinct types of clearer is, that in the one case the super is raised from its position on the hive, the 'clearer' being then placed under it, and the bees gradually

descend to join their comrades in the brood nest below. Having once left the honey-chamber, they cannot re-enter it; and, when all are gone, the super is lifted off, the 'clearer' removed, and all covered down again as before, so that the bees are not cut off at all from communication with the bees in the hive below, but join them at their pleasure. On the other hand, in using the 'cone-clearer,' the first thing done is to very quietly raise the super, place a quilt between it and the hive, and set the rack of sections (or whatever kind of surplus chamber is used) on this quilt, so that communication is at once stopped; and after gently removing the quilts which cover the sections, the bees are allowed to *ascend* and make their escape by the holes in the hive-roof covered by the cone.

ROYAL AGRICULTURAL SOCIETY'S SHOW AT DONCASTER.

(Continued from p. 298.)

Class 307.—*For the best twelve sections of comb honey* (twenty entries).—The lateness of the season caused several absentees in this class, and demonstrated the necessity for the provision of the schedule allowing honey of the previous year to be staged in competition. Had it been otherwise, the class under consideration would have been very poor indeed. The first-prize lot, shown by Messrs. Sells & Son, Uffington, was 1890 honey, good in colour, and very fairly finished. The second prize went to Mr. W. Woodley for some sainfoin sections, unfortunately not finished in sealing, or they would probably have taken the premier place as honey of the current year, and also of very good flavour. Mr. W. Christie-Miller, Chelmsford, got third for a moderate dozen of last year's sections.

Class 308.—*Best six sections of comb honey* (eighteen entries).—A rather remarkable feature in this class was the fact that the sections taking first prize were honey of the present year, gathered so near London as Wimbledon; competing with such well-known exhibitors as Messrs. W. Woodley and W. Christie-Miller—who were awarded second and third respectively—we should fancy Mr. Greenhill being more surprised than any one at his own success in securing first place. The class, however, was only a very moderate one, several intending exhibitors being unrepresented through their sections not being quite finished in time for the Show.

Class 309.—*Best run or extracted honey in jars* (seventeen entries).—Honey of the present year stood a poor chance in this class, for such of it as was staged lacked consistency in a marked degree. The promoters of the Show were indebted to exhibitors of '91 honey for sending it at all, for we feel sure the interest of the Show had more influence with them than the

hope of winning. First prize went to Mr. A. J. Carter, of Billinghamurst, for a good sample of last year's honey, fine in colour and flavour, but rather lacking in specific gravity. Owing to an informality on their own part, Messrs. Sells & Son were debarred from taking the second prize awarded them by the judges, Captain St. G. Ord receiving the second instead of third for an exhibit of this year's honey, thin in consistency, and with what we thought was a decided 'hawthorn' flavour. Mr. C. T. Overton's third-prize lot was thin, like the rest.

Class 310.—*Granulated honey in jars* (eight entries).—This was a good class, Captain Ord's first-prize exhibit being, as we thought, the finest-flavoured honey in the Show. The second-prize honey of Mr. W. Dixon, of Leeds, was also a good sample; and that of Mr. J. T. Harveyson, of Finchley, which took third prize, was not far behind. In fact, had the exhibitors of granulated honey carefully warmed samples of the same honey as shown in this class, and staged them in that for liquid honey, they would no doubt have received more substantial recognition than in the granulated class, several excellent exhibits being perforce unnoticed.

Class 311.—*For the best and most attractive display of honey in any form* (nine entries, only four of which were staged).—In this class Mr. W. Dixon was a very good first, his exhibit, though not large, being varied and neatly arranged. The honey in jars was especially good, so that if the exhibitor was lucky enough to possess more of it he made an unlucky error in not staging some of it in Class 309, where it would have taken a high place. The second prize was awarded to Miss Cooper, of Leicester, for a collection almost wholly of extracted honey. No other exhibits worthy of note were shown in this class.

The following gentlemen were appointed judges:—Rev. J. F. Buckler, Bidston Rectory, Cheshire; Messrs. W. Broughton Carr, Orpington, Kent; Jesse Garratt, Meopham, Kent; and Walter Martin, Wainfleet, Lincolnshire.

PRIZE LIST.

Hives and Appliances.

Class 300.—*For the best collection of hives and appliances.* First, G. Neighbour & Sons; second, W. Dixon; highly commended, A. C. Jamieson.

Class 301.—*For the best observatory hive, stocked with bees and queen.* First, G. Neighbour & Sons; second, W. Dixon; third, E. C. Walton.

Class 302.—*For the best and most complete frame hive for general use (unpainted.)* First, G. Neighbour & Sons; second, C. Redshaw; third, ditto; highly commended, G. Neighbour & Sons.

Class 303.—*For the most complete and inexpensive frame hive for cottager's use (unpainted).* First, C. Redshaw; second, ditto; third, W. P. Meadows; commended, A. C. Jamieson.

Class 304.—For the best honey extractor. First, W. P. Meadows; second, G. Neighbour & Sons; highly commended, T. Lowth.

Class 305.—For the best pair of section racks. First, G. Neighbour & Sons; second, C. Redshaw; highly commended, Neighbour & Sons.

Class 306.—For the best rapid feeder. First, C. Redshaw; second, G. Neighbour & Son; highly commended, W. P. Meadows.

Honey, &c.

Class 307.—For the best twelve one-pound sections of comb honey. First, Sells & Son; second, W. Woodley; third, W. Christie-Miller.

Class 308.—For the best six one-pound sections of comb honey. First, J. Greenhill; second, W. Woodley; third, W. Christie-Miller.

Class 309.—For the best exhibit of twenty-four pounds run or extracted honey in jars. First, A. J. Carter; second, Capt. St. G. Ord; third, C. T. Overton.

Class 310.—For the best exhibit of twelve pounds granulated honey in jars. First, Capt. St. G. Ord; second, W. Dixon; third, J. T. Harveyson.

Class 311.—For the best and most attractive display of honey in any form. First, W. Dixon; second, Miss Cooper.

Class 312.—For useful inventions introduced since 1890. Silver medal, G. Neighbour & Sons; silver medal, P. Harbordt; bronze medal, W. P. Meadows.

Class 313.—For the best-designed model of a tent suitable for lectures, with manipulations of bees, at agricultural and horticultural shows. Silver medal, P. Harbordt.

Class 314.—For the most interesting and instructive exhibit of any kind connected with bee-culture not mentioned in the foregoing classes, to which prizes have not been previously awarded. Second prize, Wm. Dixon.

BRITISH BEE-KEEPERS' ASSOCIATION.

Excursion to Wakes Colne Rectory, Essex, on Saturday next, July 11th, 1891, by the kind invitation of the Rev. Dr. Bartrum.

Train leaves Liverpool Street at 11.50 a.m., arriving at Chappel at 1.11. The return train leaves Chappel at 6.51, due at Liverpool Street at 8.52. Return fare, 5s. 4d.

Wakes Colne Rectory is situate about half a mile from Chappel Station.

Tickets to be obtained at the Liverpool Street Booking Office on production of certificate from the Secretary, J. Huek, Kings Langley, Herts.

For particulars relating to objects of interest see last issue of the *Journal*.

HONEY IMPORTS.

The total value of honey imported into the United Kingdom during the month of June, 1891, was 5614*l.*—From a return furnished by the *Statistical Office, H.M. Customs.*

KENT BEE-KEEPERS' ASSOCIATION.

This Association held its principal exhibition of bees, honey, and hives in conjunction with the Farningham Rose and Horticultural Society at the pretty village of Farningham, in a meadow with a beautifully clear, well-known trout-stream running on one side, the high road from London to Maidstone on another; the opposite side of the road stands the fine old church—altogether as picturesque a spot as could well be found for a show of this kind. It was well attended by the neighbouring gentry, and later in the day by the working class, their wives and children, and was just such a *fête* as one delights to see, all classes making holiday. There was a fine show of roses, cut flowers, and table decorations. It is only necessary to mention Messrs. Cannell, of the 'Home of Flowers,' Swanley; Messrs. Bunyard, of Maidstone, and Mrs. Seale, of Sevenoaks, among those who exhibited, to prove that the flower show was a great success. But it is the Kent bee-keepers' exhibition that is the special object of this report, and the Association may well be proud of the exhibits staged, showing, as they do, first of all, what a splendid county Kent is for the production of honey, especially in such a season as the present, when the honey displayed here (this year's) was superior in quality and three times as much in quantity as that shown at Doncaster in the bee department of the Royal Agricultural Show, open to Great Britain, only a week before, where it consisted chiefly of old honey; and, secondly, that the teaching of the Kent Bee-keepers' Association has not been in vain. Both the comb honey and the run or extracted honey were exceptionally good. There was not an exhibit that did not show that the modern methods were well understood. In Kent, with its thousands of acres of fruit, it is most important that bees should be kept in great numbers, as the crops depend entirely on them for the fertilisation of the blossom, and perfection and weight of the crops. It therefore behoves farmers and fruit-growers themselves to keep bees, and to do all they can to get cottagers and those dependent upon them to do so also, by assisting them in the purchase or loan of frame hives, and in seeing they are properly instructed, that they know how to keep bees profitably without destroying them. Application has been made to the County Council in Kent, as in many other counties, through their Bee-keepers' Association, for a grant from the funds at their disposal for technical education, to be applied for the purpose of teaching bee-keeping as a branch of agriculture, but, at present, nothing has been decided.

The greater part of the honey at Farningham was collected either from fruit or sainfoin.

Class 1. For bees with their queen in an observatory hive.—The first prize was awarded to Messrs. Green & Sons, of Rainham, for a six-frame hive of Carniolans, well stocked with brood and honey in combs worked out from sheets of foundation by a swarm of this year.

Class 2. For a display of honey in any form not to exceed 1 cwt. gross weight.—1st prize, T. Badcock, Southfleet, Kent; 2nd, Green & Sons, Rainham.

Class 3. For the best twelve sections of comb honey.—1st, E. E. Smith, Southfleet (for well-filled sections of sainfoin honey); 2nd, Mr. Hodgeman (chiefly from fruit blossom); 3rd, Rev. F. T. Scott, Hartlip Rectory (from sainfoin).

Class 4. For the best six sections of comb honey.—1st, E. E. Smith (for well-filled sainfoin honey); 2nd, Miss H. L. Hertslet (sainfoin honey); 3rd, Mr. Hodgeman, Bobbing, near Sittingbourne.

Class 5. For display of honey-comb, not sections.—1st, T. Badcock (six frames, 5½ inches deep, in glazed boxes, fine sainfoin honey-comb); 2nd, Green & Sons (shallow super containing eleven frames half the depth of standard frames, beautifully filled sainfoin honey. *Note*: Two of these supers together take a standard frame); 3rd, Mr. Hodgeman (for four deep standard frames of comb honey). Mr. Garratt exhibited, not for competition, twelve well-filled frames, 2 inches thick, 4½ inches deep, of sainfoin honey comb; these frames he uses for holding sections also.

Class 6. For run or extracted honey, about 12 lbs.—1st, E. E. Smith (sainfoin honey); 2nd, Green & Sons (sainfoin honey); 3rd, Mr. Hodgeman (very thin).

Class 7. For finest sample of beeswax.—1st, T. Badcock (from virgin comb); 2nd, E. E. Smith.

Cottagers' Classes.

Class 8. For best twelve sections of comb honey.—1st, E. E. Smith (sainfoin comb honey); 2nd, F. Langley (sainfoin comb honey).

Class 9. For twelve 1-lb. glasses of run or extracted honey.—1st, E. Budd (very good, from raspberries); 2nd, E. E. Smith (sainfoin honey); 3rd, Mr. Hodgeman.

Local Classes.

Class 10. For twelve sections of comb honey.—1st, Miss H. L. Hertslet (sainfoin); 2nd, R. T. Till, Eynsford.

Class 11a. For twelve sections of comb honey. 1st, R. T. Till (sainfoin); 2nd, W. S. Cropley (sainfoin).

The silver medal of the British Bee-keepers' Association was awarded to E. E. Smith for his comb honey; the bronze medal to T. Badcock for his comb honey; and a certificate to Mr. Hodgeman for his honey.

Class 12. For most complete hive.—1st, Green & Sons (hive, and crate of sections, and lift, price 15s.); 2nd, Green & Sons (doubling hive and crate of eighteen sections, price 12s. 6d.); 3rd, Hutchings Brothers, St. Mary Cray.

Class 13. For straw skep with super arrangement.—1st, Green & Sons (skep with crate of sections, can also be used for frames half standard size; good arrangement); 2nd, Hutchings Bros.

Class 14. For best pair of sections.—1st, Hutchings Bros.; 2nd, Green & Sons.

Class 15. For best collection of hives and appliances.—1st, Green & Sons (useful collection); 2nd, Hutchings Bros.

The judge in the Bee Department was Mr. T. W. Cowan, whose awards gave general satisfaction.—J. M. HOOKER, 9 *Beaufort Gardens, Lewisham, S.E.*

WEATHER REPORTS.

BUCKNALL, LINCOLNSHIRE. B.M. 25.

June, 1891.

Max., 78° on 19 & 24.	Rain:—2·58 inches.
Minimum, 32° on 9th.	Average, 5 years, 1·42.
Mean max. 67·6°	In 24 hrs. ·87 on 2nd.
„ min. 46·9°	Rain on 11 days.
„ temp. 57·2°	Frost on 9th.
„ of 5 years . . . 56·6°	Range of temp. 20·7°

Remarks.—The month opened very cold and stormy. From 17th to end has given us some good bee-weather. Swarms have come slowly during the last week.—J. BINT.

WESTBOURNE, SUSSEX.

June, 1891.

Maximum, 73° on 19th.	Rain:—1·61 inch.
Minimum, 35° on 10th.	Heaviest fall, 0·41 on Frosty nights, 0.
Mean max. 66·2°	Rain on 12 days.
„ min. 50·0°	Average, 1·85 inch.
„ temp. 58·2°	Sunshine, 224 hours.
	Brightest day, 17th, 13·59.
	Sunless days, 1.

Remarks.—After the first few days of the month bees made rapid progress. White clover is abundant, and a good deal of honey of the finest quality has been taken. Swarms have been few where proper room has been given.—L. B. BIRKETT.

VAGARIES OF A SWARM OF BEES.

On Saturday last a large swarm of bees left the parent hive at Beechwood, and took up their abode in the hollow of a large ash-tree, from which it was impossible to live them in the usual way; so at nightfall an empty skep was suspended in the tree above them in the hopes that they would take possession of it in the morning; but they showed no inclination to leave the house of their choice, and, on being smoked out, sallied round and returned again to the tree. Ultimately they took possession of the suspended hive; this, however, did not seem to suit their taste, for towards evening they left it and took their departure, being entirely lost.—*Westmoreland Gazette.*

Correspondence.

The Editors do not hold themselves responsible for the opinions expressed by correspondents. No notice will be taken of anonymous communications, and correspondents are requested to write on one side of the paper only, and give their real names and addresses, not necessarily for publication, but as a guarantee of good faith. Illustrations should be drawn on separate pieces of paper.

Communications relating to the literary department, reports of Associations, Shows, Meetings, Echoes, Queries, Books for Review, &c., must be addressed only to 'The Editors of the "British Bee Journal," 17 King William Street, Strand, London, W.C.' All business communications relating to Advertisements, &c., must be addressed to Mr. J. HUCKLE, Kings Langley, Herts (see 1st page of Advertisements.)

* In order to facilitate reference, Correspondents, when speaking of any letter or query previously inserted, will oblige by mentioning the number of the letter, as well as the page on which it appears.

BEE ASSOCIATIONS IN THE MIDLANDS.

[705.] We read occasionally of Bee Associations and their work in various parts of England, but it is a long time since your readers were privileged to learn anything about the Stafford Association, and only once during the last twelve months have the public been made aware through your columns that the Warwickshire Association was still in existence. In and around the salubrious neighbourhood of Tamworth rumour has it that the Staffordshire Association is *non est*. Can it be true? Local bee-keepers, with the majority of whom I am acquainted, seemed to regard this as the Association of the Midlands, and the support those in the fancy, anxious to be taught, obtained from the occasional visits of Mr. Rawlings, the expert, caused a few local bee-keepers to entertain the idea of joining the Staffordshire Association and relinquishing their connexion with the Association belonging to the sister county. Without going into the reasons for this premeditated change, allow me to say how pleased I was, a few days ago, to be privileged to escort into my apiary a real live bee-expert—the first who had condescended to visit me since the celebration of the Queen's Jubilee! I am afraid I was inclined at first not to regard his visit very seriously, but when assured that he (Mr. Webster) had taken up the work of the Warwickshire Association, my heart—not a very generous one at the best of times—went out to him, the past was forgiven, and I again consented to continue my membership.

The irregular visits of experts, I fear, have much to do with making Bee Associations lack members and friends. The complaints under this head around this part of the county are general, and I write now in the hope that Mr. Webster's tour through the county will induce Warwickshire bee-keepers to once more rally around their Association, and gain for it as good a name as Mr. Rawlings gained from the Staffordshire Society in this locality. The majority of the apiaries, I am told, do not present a very flourishing appearance, and the reason of this, I fear, is the lack of that tuition

Associations are intended to supply. I do not think Associations can be expected to prosper unless the experts visit the members both spring and autumn, and now that the Warwickshire Association has secured the services of so able an expert as Mr. Webster, I hope the members will rally around their indefatigable Secretary (Mr. Bower) and, by securing fresh members, make his duties, if more onerous, the more pleasant, and thereby assist in making the Association the best in the Midlands.—HYBRID.

THE LESSONS OF EXPERIENCE IN BEE-KEEPING.

[706.] Another misfortune teaches a new lesson. On the 18th of June I found a sealed queen-cell on the very bottom of a frame, and another cell not sealed on the middle of another frame. The unsealed cell was cut out. Next day a large swarm was thrown off. Examining the hive on July 3rd, in the expectation of finding new brood, I found none, but saw the queen-cell still sealed. I soon unsealed it, and found the immature immate dead, having succumbed, I suppose, to chill. Having no queen-cells to spare, I introduced a frame of young eggs and young brood; but have lost about three weeks of the most precious time of the year, and that with what was my best hive, but is now the worst. The unsealed queen-cell about the middle of the brood nest would probably have given me a queen, while the hive, depleted by the swarm, was not left with bees enough to maintain the heat at the very bottom. The lesson is plain enough now it is learnt.

My best hive, a magnificent double of ten full-sized frames in each, was the only one I had any anxiety about at the beginning of the last winter. It has no excluder, but the top, put on empty, gave me yesterday about five frames handsomely filled with sealed honey, and three more with more or less brood and sealed honey. In this hive it is all work and no indication of swarming. The only inconvenience is interstitial comb in the half-inch space under the super. I suppose I shall have to give up the idea of having everything interchangeable, and cut off three-eighths of an inch from the bottom of the top hive. The other hives, all supered with sections, and with good room given early, filled up grandly, but bees preferred swarming to finishing sections. A double hive with the extractor seems to yield far better results than hives supered with sections.

Queens are very hard to find this year in hives boiling over with bees. I fancy many candidates for the third-class certificate must be plucked. The 'South Devon' call for help (page 300) will find many an echo.—S. JORDAN, Bristol, July 4th.

[We most strongly deprecate the practice which has led to such unfortunate results in your case, i.e. that of any but experienced hands trusting to a single queen-cell hatching out all right. So many queen-cells are abortive, there is always risk in leaving only one.—EDS.]

NOTES BY THE WAY.

[707.] Since my last notes the weather has not been genial and conducive to heavy supers of honey for the bee-keeper—in fact, we in our district have had only about four bee-days during the fortnight. The temperature has been low for June and July, with dull, sunless skies and drizzly rain, just enough to retard the bees in their work, and not enough to benefit the growing crops or fill the ponds. Hay that was cut early in the previous week is still in swath. The above points to a light honey crop for the year, as the time is lost, and no quantity of stores gathered into the supers, while the scythe and machines have laid all the principal fields of honey-yielding nectar plants in swath for hay. The bees have made the most of every shining hour that has intervened, showing they were equal to the occasion whenever it presented itself, and when we *have* been blessed with a day they have simply rolled the honey in, showing what they are capable of achieving if we had had fine weather during the honey-flow. The queen-raiser's lot has not been a happy one where the weather has been cold and windy, as the drones are shy of risking any of the chances of a chill or a drenching, and besides the shyness of the drones there is the self-preservative instinct in the young queens—both male and female requiring a warm temperature to induce them to come out on wedding trips.

Super Clearers.—I promised some time back to give my experiences when put into practice, and I must say they have equalled my hopes. I put three on one evening at 8.30 p.m., and at 6.30 a.m. next morning I removed the crates of sections, and in two of them there was only three bees, while the other had seventeen bees in it. This super had a few cells of drone brood at one corner of one of the sections, and accounted for the bees staying to nurse and keep warm the babies. On another day I put one on, and every bee cleared out, not one remaining to claim the distinction of being monarch of all he surveyed. How to do it is the next question. A hint or two will not be out of place here. I may say all my crates hold twenty-one sections, and my clearers are made the size of the crates. When the crate is full ready to take off, I prise up the crate with a screwdriver, blow in a little smoke, and lift the crate off the hive; at the same time a carbolised cloth covers either the bottom crate, if one is on besides the full one, or the frames of brood. Then place your full crate of sections on the top of your clearer—the cones of wire cloth underneath, of course; now remove your carbolised cloth and replace the sections and clearer on the hive again, and in a few hours, or during the night, the bees will find their way down into the hive or into the super below. Mr. Flood, of Reading, made my clearers to my orders, adapted from the (American) Wright pattern. I notice this question *re* 'Bee Escapes' is the leading query in the *American B. J.* for June 11th, and the consensus of opinion of the leading apiarists of America

is that the escapes, or clearers as we term them, are come to stay.

The latest idea in bee-escapes is the 'Porter Spring Escape'; this has only one passage by which the bees pass out after going into the central hole, but each bee passes between two little springs of flat brass, and when once passed (it is in the turnstile system) there is no return. Mr. S. A. Shuck, an American bee-keeper, speaks very highly of this form of escape, and says he removed 2500 pounds by means of escapes last year, with less uproar and robbing than he frequently had in previous years by the old method of smoking, shaking, and brushing off the bees from the sections of a tenth the quantity.

Foundation.—Last year I sent some wax to friend Howard to be made into foundation, as I was favourably impressed with his foundation at the Royal Show at Windsor, and when it came I was very pleased with the beautifully uniform sheets which, when cut up to size to fit the one-pound section, I found numbered ninety-four to the pound. I wrote Mr. H. suggesting when he made some more for me, he should screw *that machine* a little closer, and see if he could not reach the round number of 100 sheets to the pound cut size of *inside* of $4\frac{1}{2} \times 4\frac{1}{2}$ sections. Time passed on, and in February '91, I dispatched my wax to the 'Model Apiary' again; in a day or two I got post-card acknowledging its receipt, but also saying his large foundation machine was gone for repairs; that he had a new one from America, and if I did not send any objection or reply, he should work my wax up through that. I let the matter drift, knowing it was in safe hands and good judgment. It came in due course and I must say is the finest I have ever used, and the thinnest also, for I have weighed several pounds, and find the thickness uniform, and that there are 100 to the pound to fit the inside of standard sections. So much for its thinness; now a word as to its strength. We only affix the foundation to the top of the sections, and that by pressure only of the little Abbott's-pattern fixer (the wheel), and we have not had a tear off or a breakdown in a single section yet. — W. WOODLEY, *World's End, Newbury.*

A TRUANT SWARM RECOVERED.

[708.] I do not know whether it may be of interest to your readers, but the following is certainly new to me. A swarm of bees issued from one of my hives on Monday, the 22nd ult., but I was not able to trace it among the many small gardens in the neighbourhood. This morning (Thursday) I heard from a lady about a quarter of a mile away that a swarm of bees had been in her garden since Monday morning early, that is to say, three complete days. They were sheltered in no way from the rain, which fell heavily on Tuesday, but it seems strange that they should not try and find a home on Wednesday, which was a fine day.

There was rather an amusing incident in connexion with this. On my calling at the house where the swarm had settled, the maid gravely ushered me into the drawing-room with these words, 'Please, mum, here's the swarm of bees!'—ANTHONY WILSON, 15, *Wells Road, Sydenham, June 25th, 1891.*

THE CONE SUPER-CLEARER.

[709.] Yesterday (1st July) I removed the top crate of three which were on a hive, using one of Harbordt's cone super-clearers, with which I am very much pleased, my only trouble being that when the crate was lifted off the empty box, over which it had been placed, the under-side was all over bees, which would have been crushed if the crate had been placed on the top of the quilts. I tried to sweep them gently off with a feather, which did not answer; then I gave them a little whiff of smoke, and they all ran up, and the crate was safely placed in position. As the afternoon, though warm, became dark and gloomy, the bees only oozed slowly out of the end of the cone, and I began to fear perforations and gorging. The cone was on three hours, and still there were a good number of bees left in it, which, however, were easily swept off the sections with a feather; not a single bee was carried into the house. I fancy a bright morning would be best for the operation. There were no perforations, fortunately, but I shall be much obliged to Mr. Harbordt if he will kindly tell me, through your *Journal*, how to remove the bees from the bottom of the crate without either carbolic or smoke? I think his cone is a perfect little invention, excepting for the bees at the bottom of the crate. Perhaps in Mr. Harbordt's hands they don't act so, but in practice mine do.

My hive roof had three ventilating-holes, besides the one the cone was placed over. I plugged them with cork to exclude the light, and I used several folds of paper instead of a quilt under the crate, as I do not like my quilts to be made sticky. I think a double American leather quilt would be best for this purpose, shiny on both sides, as it could be washed.—BEE SWING, *Carlisle.*

CARNIOLAN QUEENS AND SWARMS.

[710.] From a strong stock of Carniolan bees crossed with Ligurian blood I had a heavy swarm on June 17th, which I duly hived, and supered the parent stock on the 20th, the bees immediately entering the super. On Sunday, the 28th, a cast issued late in the afternoon, which I also hived. About 5.30 to 6 p.m. I found a virgin queen on the roof of the parent hive, but while examining her she took to flight. On July 2nd a second cast came out which I had some difficulty in securing, as it had at least five queens with it. I saw this number. Two or three entered the new hive, one flew, and the remaining one I introduced into a queenless hive.

On July 3rd I found one dead queen outside the new hive early in the morning. At 6 p.m. I picked up two dead queens near the parent hive, and four more at 8 p.m., life not being quite extinct in two of them. Is it usual for so many queens to issue with a cast, and also for so many queens to be bred as I have seen and enumerated? A curious feature, also, is the varied colours of the queens. One or two were perfectly black, others banded, and two at least had almost wholly orange abdomens.—J. F. B., *July 3rd.*

[The number of queens raised in Carniolan stocks at swarming-times varies considerably, as does their appearance, and yours is not at all an exceptional case. We have known as many as twenty-three or more queens to hatch out in one stock at such times.—E.D.S.]

BEEs IN SCOTLAND.

[711.] The biography of Mr. McPhedran is a very pleasing and satisfactory one, and will be read by a great number with deepest interest. Many to whom Mr. McPhedran showed much kindness will feel for a very long time that in his death they have sustained a very heavy loss.

Previous to Friday last strong stocks made rapid progress here in filling supers, but since then more or less rain has fallen daily, putting an end to the work. But stocks generally are about three weeks behind, and only in the warmest and most sheltered places have swarms been on the wing.

Last summer bees got over-crowded, and when, with small stores, the harvest suddenly ended, their energies seemed to get paralysed, and attempts to hatch out brood were abandoned; consequently it rotted in the cells, and assumed the appearance of foul brood, if it were not identical with it, which I had not an opportunity of ascertaining.

At present the weather appears broken, and if it continues so for a couple of weeks, it will spoil the honey harvest in this district. But all kinds of crops, except rye-grass hay, eaten too long, are looking remarkably well, and since rain fell, growth has been very rapid.—R. S., *Tundergarth, N.B., June 30th, 1891.*

BEE-SHOW AT PORTSMOUTH.

[712.] *B.B.J.* just to hand, and I notice that Mr. W. Woodley, of World's End, Newbury (690, p. 291), says:—'The "Royal Counties" is at Portsmouth this year, but owing to the exclusiveness of the Hants and Isle of Wight Association, the show of honey must be of a limited quantity, as it is confined to the county of Hants and three miles outside—but as a great part of this three-mile boundary is water, it does not include many bee-keepers.'

I hope that in Mr. Woodley's 'Notes' in your *Journal* there are not often such mistakes as the

above. He should remember that he himself has not done badly at Portsmouth as an exhibitor in the past, and should first have obtained a schedule and then a map of the county. Surely some one has been playing a joke upon him to prevent him competing!

I enclose you a schedule, and copy from it the classes open to the *United Kingdom*, which even includes 'World's End.'

I shall be pleased to forward a schedule to any one willing to compete. We hope to have a large show, under the presidency of H.R.H. the Duke of Connaught, who has promised to be present on two days of the show.—JOHN J. CANDY, *Commercial Road, Londport, Hon. Show Sec.*

THE NEW SECTION-BOX.

[713.] In the *B. B. J.* for June 18th, p. 276, you described a good frame section-crate (Fig. 14). I should be glad if you would say in *B. B. J.* where the crate can be purchased. Perhaps other bee-keepers will be equally glad with myself of the information.—DORSET BEE-KEEPER, *Dewlish, Dorchester.*

[We have received several letters similar in purport to the above, and must refer correspondents to our advertising pages for the information sought for.—EDS.]

FINDING QUEENS.

[714.] Would it be of any service to 'South Devon Enthusiast,' in looking for a queen, to recommend searching very minutely the frame on which the bees appear to be in the greatest state of excitement? She will probably be there. If he examines his frames, and puts them into an empty hive, or box, and inadvertently puts in the one with the queen on, the bees will immediately set up a roar of welcome. That frame might be taken up and examined again, though if the queen is young and sprightly, she may have escaped and got upon some other frame in the box, or be walking about on the bottom of it.—BEE SWING, *Carlisle.*

[Except in difficult cases, it is not advisable to set frames into an empty box when searching for the queen. Besides, it most frequently happens that the bees are less excited on the comb where the queen is than on others. The best plan is for the operator to accustom himself to the queen's appearance, and acquire a habit of passing his eye over every portion of the comb in turn.—EDS.]

APPRECIATIVE.

[715.] Allow me to thank you most heartily for the splendid papers on 'Mounting Microscopic Objects.' '636' is quite right, these articles—with Cowan's *Honey Bee*, which I selected as one of my science prizes last year—will be 'a grand treat.'—N. C. HAM BROOK, *Shenley, Barnet.*

BUYING HONEY FOR COMPETITION.

The following letter (from which we omit name and address of writer) was recently addressed to a correspondent, who, of course, promptly declined to sell on any terms his honey for any such purpose as is therein indicated:—

'DEAR SIR,—Would you kindly let me know at what price you could supply me with the following:—Four standard frames of comb and one dozen one-pound sections filled and sealed up *perfect* this year. The combs must not be more than twelve months old. The same would not be wanted until July 15th next. Please let me know as soon as you can.'

We advise managers of shows, especially in Wales, to pay attention to the clause in prize schedules, wherein it is expressly stipulated that the honey must be gathered by the exhibitor's *own bees*; and, moreover, we cannot too strongly condemn a fraudulent practice we had hitherto supposed bee exhibitions to be free from.—[EDS.]

Queries and Replies.

[373.] *Swarming and its Anomalies.*—May I ask your opinion of the following?—

June 3rd.—Examined single stock of bees. At end of manipulation queen was lying on the ground, apparently hurt; could not walk straight, but rolled over. Placed her at entrance, and she slowly walked in. Several days later found some very young brood, so queen apparently still laying. *12th.*—Bees swarmed, and were hived; but left hive almost at once and returned. Queen found on the ground as before; put her near entrance, and she again crawled into hive. *13th.*—Bees swarmed again and returned as before. Could not find queen this time. *17th.*—No unsealed brood. Heard noise that might have been 'piping' of a queen. *18th.*—Fine swarm issued; flew very high. Successfully hived. Placed swarm on stock stand. *20th.*—Live queen found on ground outside hive in front of swarm. Put her in at feed-hole, and she ran down. *21st.*—Dead queen in front of stock at 1 p.m. At 3.30 p.m. stock threw a second swarm. Hived successfully, and saw queen go in. *22nd.*—Second swarm came out of its hive and clustered all over the front of it about midday, and then went back into hive and quieted down. *23rd and 24th.*—About seven or eight queens turned out of stock, and on the 24th a dead queen outside the second swarm, in no way disfigured, after manipulation of this second swarm. *27th.*—All three hives broodless, except for sealed brood in stock. Some drone-comb built in each of the swarms, and drones present. *28th.*—Queen left stock, amid a good deal of excitement, at 1.15 p.m.; took wing, flying with her head towards hive, and evidently noting its appearance for a few minutes, and then flew away. Bees rather restless until 2.45 p.m., when I saw

queen return, presumably mated, and bees quieted down.

July 1st.—United two swarms. Both apparently broodless. Could not see eggs in any of the combs. Used peafLOUR. Bees united peaceably. Now and then the bees in the stock drag out a drone, but only about one a day. Both the stock and the first swarm brought in a little pollen, but not much compared to what they had done previously. The first swarm has some pollen stored in new-built combs. The third swarm brought in no appreciable quantity of pollen. The first swarm had begun a queen-cell, though it had no brood.

To-day (the 2nd) I found a dead queen, which I enclose for your inspection, outside the united swarms. She appears to me a very fine one, and is bigger than those that were turned out of the stock. 1. Is she fertile or not? 2. How long is it before the queen begins to lay after mating? Which of the swarms is this queen likely to have belonged to, and why have the bees turned her out? If she is fertile, why was there no brood? 3. Does the presence of an incipient queen-cell in a swarm prove the absence of the queen, when there is no brood? 4. Do queenless stocks ever bring in pollen?

I should be glad to know in what condition the queen reaches you, as I am packing her with bruised laurel-leaves. I do not know if this method has ever been tried for keeping the bees relaxed, so as to be fit for dissection; but I know that moths, if kept in bruised laurel-leaves, are perfectly relaxed, and as fresh as if newly killed, even after a fortnight's time, and I do not see why the method should not be used for bees. Some of your correspondents may find the method a useful one in sending queens for examination, but this is my first trial of it.—HERBERT E. WALLER, *Highbury, London, N.*

REPLY.—1. Unfertile. 2. Usually about two or three days. Surplus queens (or, more correctly, princesses) are nearly always killed and thrown out from hive after the issue of second swarms. 3. The indications named go to prove that the young queen has met with some misadventure, and been lost after the swarm had settled down to work in their new home. If the queen is lost or killed the same day as the swarm is hived, the bees return to the old home; but after a few days' dwelling away as a new colony, the bees become a new stock, and are as strangers to the old hive. 4. Occasionally in small quantities.

[374.] I began the season with two stocks in frame hives and one skep. The latter swarmed on June 5th, and the other two a fortnight later. I united the first of these to the swarm from skep, and when, a few hours later, the other frame hive swarmed, I hived the swarm on six frames. I have therefore five lots, all doing well. I have section racks on three of the five hives, but cannot get the bees into sections in the other one. 1. Should I unite those in skep to this stock? If so, which is the method of doing it? I do not wish to keep

any bees in skeps, nor to increase my stocks' 2. You advise that sections should be removed as soon as completed. Must I take the rack off hive and remove completed sections, or can I take them out as the racks stand? 3. I should also like to know dimensions of section box and frames illustrated on page 276 of *B. J.* for June 18th (Fig. 14), together with such illustrations as would enable me to make one.—MORE LIGHT, *Uxbridge, Middlesex.*

REPLY.—1. The bees should have been driven from the skep and united to the weak stock twenty-one days after swarming. As, however, that date has passed a fortnight or more, do it at once, using flour when uniting, and preserving the young queen of the skep by removing the other before joining the two lots of bees. 2. The rack may be lifted off entire if most of the sections are finished, or they may be removed singly, using a little smoke or the carbolic cloth to keep the bees quiet while lifting them from the rack. 3. The various parts of the section box named are cut by machinery, and would be very difficult to make by hand; but in any case you would require to purchase one as a pattern to work by. Consult our advertising pages for price, &c.

[375.] *Vagaries of Swarms.*—I am sending you a queen which led off a swarm yesterday. Can you tell me what is the matter with her, and whether she is a perfect queen? The swarm issued, and she was picked off the alighting-board. The bees did not cluster in the skep last night, but remained all over the sides of it. They were more compact this morning. What do you advise doing with them? I have put the skep next to parent hive. Is this right? I may say that a nucleus was made from this hive about three weeks ago, but by mistake the queen was put in the nucleus and has not been removed.—R. T., *Leicester.*

REPLY.—The natural inference is that the dead queen sent is one of several in the hive at the time the swarm issued. When the old queen was removed with the nucleus, the bees would in due course raise new queens in the parent hive, and all the subsequent proceedings were just such as occur when second swarms issue. Leave the swarm where now placed, and if no queen remains with the bees, they will return to the parent hive.

[376.] *Bees Gathering from Laurel Leaves.*—Will you kindly say what it is bees are gathering from the back of young laurel-leaves at present?—W. P. LOWE, *Cloverhill, Belturbet.*

REPLY.—On the under-side of laurel-leaves will be found two small brown spots, one on each side of the central sinew, and near the base of the leaf. These are nectaries, from which exudes the substance—honey in some form—gathered by bees at this season.

[377.] *Swarms Returning.*—A swarm has come out of one of my hive four successive times, and they have always gone back again after a few minutes. I fancy something must be wrong

with the queen, as she never comes out with the swarm. I have sections on the stock referred to, and as my hives stand very close together I do not like to examine them in the middle of the day to see what is the matter, as I am afraid the smell of honey would upset all the other bees. If you will kindly tell me what ought to be done I shall feel much obliged.—M. H., *Alton, Hants.*

REPLY.—Examine the stock at once, and if queen-cells are in progress, remove and destroy the queen. There must be some fault about her likely to cause a recurrence of the trouble in the future.

BEEES IN A PILLAR LETTER-BOX.

As our Halstead representative was walking from the town across to Dynes Hall on Monday evening, he saw a man named Plumb, with a skep, pail, &c., standing near the letter-box at Doe's Corner. A good swarm of bees had got into the letter-box, and Plumb had determined, if possible, to 'hive' them in his skep and find a fresh home for them. After waiting a quarter of an hour the mail-man drove up and unlocked the box, but not being a bee-man he evidently did not care for the job of taking out the letters. Plumb came to his assistance, and having got the letters out commenced operations in earnest. He puffed and blew smoke into the bees, pulled them from the walls into a meat cover, and from thence to the skep, but all to no purpose, for the queen-bee clung to the home she had selected and declined to quit at so short a notice. A large number of the bees were, however, persuaded to stay in the skep for the night, and Plumb retired with the hope that better luck would await him in the morning, when he intended to repeat his efforts.—*Essex County Chronicle, July 3rd, 1891.*

Echoes from the Hives.

Shilington, East Devon, June 30th, 1891.—Bees have commenced gathering honey here at last. All through the month of May we had it cold and windy, which prevented anything being done except feeding. My seventeen stocks wintered well, and in February things seemed going on nicely, weather fine, but all of a sudden the cold and snow and wind came on again, and four of my stocks perished. I am pleased to tell you the others are doing well, four out of the thirteen are skeps, from which I have secured five swarms, and one flew away. I put on sections on nine frame hives early in June, and most of them are working away finely. I took off fourteen beautifully sealed sections from one of the hives on June 27th. I also examined the other hives and found a lot of the sections nearly finished. We have just had a regular swarming-time of it around this neighbourhood. I examined a friend's bees, and found they were working in the sections with a will. As a constant reader of the *B.J.*, I owe much of my

bee-knowledge to its valuable pages. Wishing success to all its readers,—J. W. SANDERS.

Dewlish, Dorchester, June 23rd.—My bees are doing very well during this fine weather. I have one hive with two section crates (forty-two sections) which will be ready to come off in a day or two. I hope others are doing equally well.—F. A. KENT.

Bee Shows to Come.

July 14th to 17th.—Hants and Isle of Wight B.K.A. at Portsmouth, J. J. Candey, 197 Commercial Road, Landport.

July 15th, 16th.—Armagh. Mr. E. Best, Armagh.

July 15th, 18th.—Notts Agricultural Society at Nottingham. Bees, honey, and appliances. A. G. Pugh, Hon. Sec., N.B.K.A., 49 Mona Street, Beeston, Notts.

July 23rd, 24th.—Lincolnshire Agricultural Society at Brigg. Stephen Upton, Sec., St. Benedict's Square, Lincoln.

July 28th to 31st.—Highland and Agricultural Society at Stirling. Mr. T. D. Gibson-Carmichael, Melrose, N.B.

July 29th, 30th.—Leicestershire B.K.A., in connexion with the Leicestershire Agricultural Society, at Leicester. Entries (except for honey) close July 11th. Entries for honey may be made up to 22nd July. H. M. Riley, Tower House, Leicester.

August 5th, 6th, and 7th.—Yorkshire Agricultural Society at Bradford. Entries closed June 27th. Marshall Stephenson, Sec., York.

Sept. 5th.—Alderley Edge and District Branch of the Lancashire and Cheshire B.K.A. Chelford Flower Show, Astle, Chelford. Schedules, &c., T. D. Schofield, Alderley Edge, Cheshire.

Sept. 9, 10.—Derbyshire Bee-keepers' Association at Derby. Entries close August 27th. W. T. Atkins, Sec., 12 North Street, Derby.

Notices to Correspondents and Inquirers.

A. B. C. (Leeds).—Bees will swarm from hives without drones, but by no means so freely as where the latter are present.

BEE (Durham).—The probability is that the queen is all right, but you should examine the hive again for eggs in a few days.

E. AULSEBROOK.—The information contained in cutting sent appeared in our pages some time ago.

Box (Feltham, Middlesex).—The bees sent belong to the family of Upholsterer bees. They are called rose-leaf cutters, and make their nests in the earth, in cavities of walls, or decayed wood. In this nest the bee constructs several cells about an inch in length, thimble-shaped, and made from portions of leaves cut from rose-trees and neatly folded together. It is not at all uncommon in this country.

THE

British Bee Journal,

BEE-KEEPERS' RECORD AND ADVISER.

No. 473. Vol. XIX. N. S. 81.]

JULY 16, 1891.

[Published Weekly.]

Editorial, Notices, &c.

BEE ASSOCIATIONS, COUNTY COUNCILS, & TECHNICAL EDUCATION.

At the *conversazione* of the B.B.A.K., held on the evening of February 24th last, Mr. Meggy, hon. sec. of the Essex B.K.A., referred to certain sums of money at the disposal of County Councils by way of grants-in-aid for the purposes of technical education. He also explained that application had been made on behalf of his Association for a share of such grants. Since that time the matter has been fully discussed, and reports of the steps subsequently taken are recorded in our issues for May 14th and 21st. Once definite action had been decided on, and the views of prominent bee-keepers had been placed before 'the powers that be' by such Associations as determined to move in the matter, nothing remained but awaiting patiently the result of the several applications.

It is now our pleasing duty to make known the fact that the Technical Instruction Committee of the Essex County Council has recognised the claims of the Bee Association, if not in quite so liberal a spirit as could have been wished; but once the justice of the claim has been admitted, and it is granted that bee-keeping fairly comes within the scope and objects of the Act of Parliament, it only needs that Bee Associations should carefully husband any sums granted them under the Act, and show that the amount of good done is only limited by the means afforded them, to ensure an augmented grant in the course of a year or two.

We, therefore, welcome this, the first step towards a large measure of ultimate success to the cause, and heartily congratulate the Essex B. K. A.—and Mr. Meggy personally, as its moving spirit—on being

the first Association in the kingdom to receive assistance from the public funds.

The following extract from the proceedings at the quarterly meeting of the Essex County Council, which took place in the Shire Hall, Chelmsford, on Tuesday, the 7th inst. (as reported in the *Essex County Chronicle*), will show exactly how the matter stands, and give to other Associations interested a correct view of the present position of affairs in Essex:—

'The quarterly meeting of the Essex County Council was held at the Shire Hall, Chelmsford, on Tuesday, the 7th inst. The gathering took place in the Ball-room, which has been specially fitted up for the Council. Alderman Andrew Johnston presided, and there were a large number of Aldermen and Councillors present.'

The subsequent portion of the proceedings specially interesting to our readers appears in the report of the Technical Instruction Committee, wherein it is recommended:—

'That a sum not exceeding 500*l.* be granted to the same Joint Committee for the purchase of apparatus and diagrams, which are to be the property of the Council, and that a sum not exceeding 100*l.* be granted to the Committee for the storage and carriage of such apparatus and diagrams; that a sum not exceeding 50*l.* be granted to the same Committee to be expended in lectures under the direction of the Essex Beekeepers' Association; and that local committees throughout the county, especially in rural districts, be recommended to make application to the said Joint Committee or the Essex Agricultural Society, for aid in lecturers or teachers, obtaining apparatus or materials, the conducting of examinations, and seeking help and guidance generally.'

The very fact of 'State aid' being thus afforded to bee-keeping opens up a new page in the history of the pursuit sufficiently important to warrant us in welcoming the new departure as inaugurating a better condition of things in the near future. Hitherto progress has been mainly dependent upon individual effort, and to ensure a succession of men of the right

stamp willing to continue the work begun by others as time passed has constituted a serious difficulty with Associations generally. It can hardly be expected that the active work connected with the management of Bee Associations will be continued for an indefinite period by the same persons; obviously it becomes necessary to look out for successors, and as financial difficulties are perhaps the most trying of all hardships to be contended with, it will afford considerable relief to future officers of Associations when a small amount of the public funds becomes available for work which is, of all things, especially intended for the public good. It can at least be claimed for the labours of our Associations in the past that they have been entirely directed to the philanthropic object of disseminating the most improved methods of bee-keeping, and it cannot be denied that the chief labour has devolved upon a comparatively few persons, who have ungrudgingly given both time and money in promoting what they believe to be a good cause. It will be a source of satisfaction to these gentlemen to see the prospect of a probable lightening of one portion of the cares and anxieties of Association management in the hands of their successors.

One of the strongest arguments in favour of obtaining grants in aid of technical instruction in bee-keeping lies in the fact that, for some years past, our Bee Associations have laboured on much the same lines as are proposed to be now continued with assistance from the public funds. Much of the machinery for the work already exists, and the sober judgment of practical men is available—men as conversant with the difficulties to be faced as with the advantages to be gained. We may, therefore, be quite sure that such Associations as are benefited by the grant will show a good return for the money expended. Fifty pounds in a county will not go very far, we admit; but it is absurd to suppose that the sums first voted will not be augmented if the results are sufficiently satisfactory to justify further expenditure.

In conclusion, we venture to impress upon the executive of such Bee Associations as succeed in obtaining a grant, the necessity for perfecting a scheme of procedure which will commend itself to County Councils, and prove to them that substantial good has been done by including bee-keeping among the subjects worthy of assistance from the

public funds. By doing this they will not only ensure a continuance of the grant, but where necessary may reasonably hope to receive a sum sufficient for carrying out the work in a thoroughly complete and satisfactory manner.

Since writing the above we have to-day (13th) received the following gratifying note from the President of the Northants. B. K. A. :—

'You will be pleased to hear that the Technical Education Committee of the Northamptonshire County Council yesterday voted 25*l.* (the sum I applied for) towards the funds of the Northants Bee-keepers' Association, which of course is to be spent in instruction and demonstrations in bee-keeping within the county.

'Bee-keepers generally should be pleased to hear that our County Council has acknowledged the principle that instruction in bee-keeping is "Technical Education."—A. L. Y. MORLEY, *President Northants Bee-keepers' Association.*'

MIDDLESEX BEE-KEEPERS' ASSOCIATION.

This Association held a show of honey, hives, and bee-gear in conjunction with the Hampton Hill and Hampton Horticultural and Cottage-Garden Society, in the grounds of the Manor House, Hampton, on July 8th. As far as regards the show, it was all that could be wished for, there being plenty of honey, and most of it of very good quality, but owing to the wet the attendance of visitors was very small, and not one-half of the usual gate-money was taken. The arrangements made by the Hon. Sec., the Hon. and Rev. H. Bligh, were admirable, and the bee-tent was placed at the further end of the meadow. No extra charge was made for admission to the manipulating tent, which was occupied by Mr. Baldwin, who, between the showers, interested his audience by explanations of the various operations he was performing.

There was a very fair competition in several of the classes, and in Class 1, for the British B. K. A. silver medal there were twelve competitors, the first prize going to some very fine sections of honey gathered at Hampton Hill by the station-master of that place. In Class 2, the bronze medal went to some excellent extracted honey, gathered at Shepperton. There were some very good white sections from Brondesbury, the apiary being situated within three and a-half miles of the Marble Arch, showing that even in London one need not despair of getting honey, if not for sale at any rate for one's own use. Between four and five in the afternoon there was a veritable downpour of rain, and every one took shelter in the tents. However, later in the day more people arrived, but still the attendance was at no time very large. Those who witnessed the bee-show and manipulations expressed themselves well pleased.

It is a pity that larger prizes are not awarded for collections of hives, &c., so as to encourage more competition. At this show there was only one entry in the collection class. The Rev. Dr. Bartrum was the judge, and his awards gave general satisfaction.

Class 1. Best twelve sections of honey (twelve exhibits).—First prize (silver medal), Mr. Veysey, Hampton Hill; second, Mr. H. Jonas, London (honey produced in Cambridge-shire); third, Mrs. Luscombe, Teddington.

Class 2. Best twelve 1-lb. bottles extracted honey (four exhibits).—First (bronze medal), Mr. J. Gittins, Shepperton; second, Mr. Mitchell, Hillingdon; third, Mr. Harveyson, Finchley.

Class 3. Largest and best exhibit of honey in and out of comb (four exhibits).—First, Mr. J. Harveyson; second, Rev. W. Handcock, Hampton Hill.

Class 4. Best twelve 1-lb. sections (open to members of Southern Province only).—First, Major Fair, Teddington; second, Mr. R. Rees, Hampton Hill.

Class 5. Best exhibit of honey, open to members in Hampton, Hampton Hill, &c. (two exhibitors).—First, Mr. J. P. Kitchen, Hampton; second, Rev. W. Handcock.

Class 6. For the best collection of exhibits or appliances (one exhibitor).—First, Mr. S. J. Baldwin, Bromley.

SCOTTISH BEE-KEEPERS' ASSOCIATION SHOW AT STIRLING.

The fine weather of the last few days, which, fortunately, so far gives no sign of breaking up, ought to have the effect of making the Stirling show memorable in the annals of Scottish bee-keeping. Everything points to a most successful gathering if bee-men themselves will but reciprocate the action of the gentlemen to whose disinterested labour the very liberal prize list and excellent arrangements are mainly due. If the entries are anything like as numerous as they should be in view of the amount offered for competition, and considering the rapid honey-gathering now in full swing, the show will be a great success. We therefore express a hope that British bee-keepers from all parts—but especially Scotchmen—will show their appreciation of the work done for them by the newly organized Association, notably that of Mr. Gibson-Carmichael himself, by making the list of entries as *liberal* as the prize list.

The Highland Society has decided that all admission fees to the bee-department, bee-tent, &c., are to be done away with, and in thus following the example of the Royal Agricultural Society of England they have displayed a wisdom which will have an influence for good on all future shows held under their auspices. We have always considered that to make a charge for admission to that portion of a show which happens to be devoted to bees or to the manipulating tent was a short-sighted policy. It might bring a few pounds into the coffers of the

Bee Association, but it told to its disadvantage in a hundred ways, and we are glad to find admission fees abolished at bee-shows wherever free admission is practicable.

BEE-KEEPERS AT WAKES COLNE RECTORY.

The small party of bee-keepers who availed themselves of Dr. Bartrum's invitation to spend an afternoon with him at Wakes Colne Rectory, Essex, on Saturday last, had a most enjoyable afternoon at the delightful retreat, in which the worthy Doctor has before him, we trust, the enjoyment of many happy years.

But for the difficulty of arranging for the comfort of a large number of visitors, Dr. Bartrum's invitation would have been extended to bee-keepers generally, instead of limiting it to members of the B.B.K.A. However, if the party assembled on Saturday was not a numerous one, it perhaps added to the pleasure of those who *did* go, for there was no dividing into separate groups, but just enough in point of number to form one body, all intent upon making the most of the occasion.

Leaving London in beautiful weather, the prettiest picture on the way down was seen at our journey's end in the charming little village of Chappel, almost toylke in its arrangement as seen from the train above. Dr. Bartrum met the party at the station, and pointed out the various objects of interest—of which there are not a few—on the walk to the Rectory, where all were pleased to see Mr. and Mrs. Cowan, who had been spending a few days there prior to our arrival.

After a passing look at the various and charming surroundings of the Rectory-house—to be inspected at leisure later on—lunch was partaken of, and the party then assembled in front of the lawn, with the flower-covered walls of the Rectory as a background, while a photograph was taken as a permanent record of the visit.

No time was then lost in visiting the apiary, consisting of fourteen hives of various 'makes.' All were in good condition, and apparently doing well—if rapidly gathering honey of good quality fully expresses that happy condition; moreover the bees were on their best behaviour, not even forgetting themselves so far as to leave a single unfavourable 'impression' on the visitors.

Perhaps the most interesting thing from the bee-keeper's point of view was the remarkable automatic smoker used by Mr. Cowan, made for him by his friend, M. de Layens, and now seen for the first time by all present except the writer. The smoker is quite original in form, held by a handle on the top side; the nozzle is flat, and from two to three inches wide. Without going into full details of its make, we may say that once wound up and started going, its interior fan works for an hour or more without winding, and the draught or volume of smoke

can be regulated to a nicety. When it is set on one side of the open hive, the operator is perfectly free to go on with his work without giving the least attention to the bees, the gentle stream of smoke wafted over them keeping all quiet without any 'driving down' of the bees by the volume of smoke poured in among them. The action of the smoker was considered perfect by all who witnessed its working, and we hope to see a sketch of it in the *B.J.* Not that it will be likely ever to come into general use—the beautifully made implement, with its delicate interior clockwork, being too costly for that, but it would interest bee-keepers to know that a perfect bee-smoker can be made if cost is no object.

(To be concluded in our next.)

Correspondence.

The Editors do not hold themselves responsible for the opinions expressed by correspondents. No notice will be taken of anonymous communications, and correspondents are requested to write on one side of the paper only, and give their real names and addresses, not necessarily for publication, but as a guarantee of good faith. Illustrations should be drawn on separate pieces of paper.

Communications relating to the literary department, reports of Associations, Shows, Meetings, Echoes, Queries, Books for Review, &c., must be addressed only to 'The Editors of the "British Bee Journal," 17 King William Street, Strand, London, W.C.' All business communications relating to Advertisements, &c., must be addressed to Mr. J. HUCKLE, Kings Langley, Herts (see 1st page of Advertisements).

* * * In order to facilitate reference, Correspondents, when speaking of any letter or query previously inserted, will oblige by mentioning the number of the letter, as well as the page on which it appears.

THE 'LET-ALONE' SYSTEM.

[716.] On looking at a stock of bees the other day for some friends, I thought I should like to send you an account of how well bees *may* do on the 'let-alone' system.

Last year, about the beginning of summer, the family had a hive of bees sent to them, with supers on, and all ready for work. They knew nothing about bees, and put them down on the lawn in front of the house. But their close proximity to the house proving rather uncomfortable to some members of the family, the bees were unceremoniously moved into the kitchen garden and perished in large numbers, not being able to find their new location. Towards autumn one member of the family ventured to take off the roof to see if there was any honey to be got; but like many more in 1890 the yield was *nil*. From that time to Tuesday, June 30th, they have been left to themselves, with the exception of reducing the door to half an inch in autumn, which was increased to one and a half inches about the middle of June. The section crate was left on—no feeding whatever. There were no quilts except one thickness of Dutch carpet over the sections. The ends of the frames were open, so that the bees had free access to the roof—a means which they had readily availed themselves of when finding room short, for when the roof was removed on the morning of the 30th, when the son, again thinking it was time

to look in and see what the bees were doing (not knowing any one was coming to see to them), he found the bees had taken possession of the roof in strong force, with a good deal of comb and honey. The roof was turned upside down on an adjoining hedge, and the bees left to do as they liked, until a friend who preceded me put some cloths over the hive and tied the roof on again.

By the free use of carbolio cloths we managed to get the bees down *into* the sections and body-box. The section crate was removed with some difficulty, being so tightly sealed down, and the bees dislodged by a series of bumps round the garden path, when we took out twenty-one sections filled and sealed to a cell with beautiful honey, besides some four or five pounds in the roof after the bees had been freely carrying it away all day. We were rather in a fix as to what to do to give surplus room, my friend having no bee-gear whatever, and about a gallon of bees hanging out on the front of the hive. However, we decided to bring the crate home with us, some seven miles, and refit from my stock, my friend volunteering to return and put it on first thing next morning; and I hope they are now busily engaged in filling the second crate as well as they did the first.

I am afraid, Mr. Editor, I have made this much too long; but I thought you would like to hear of such good results from such a meagre bestowal of care or management.—G. C. LYON, *Hastings*.

WINTERING BEES.

[717.] If the subject of 'wintering' bees is not altogether unseasonable in the midst of a sunny July, it may interest some of your readers to hear how one stock of mine came alive through last severe winter under most unfavourable conditions.

On January 8th last I noticed a hive, apart from the rest, standing upon the gravel path with the roof lying by its side, and no cover remaining but one thickness of old green baize and the calico quilt. How this came about is not quite clear, and I will not trouble you with surmises; but upon inquiry I found that it had been in this state since the end of October. On examination I was surprised to find that many bees were still alive, so the hive was at once carried into a warm laundry, where ironing had been going on, and all dead bees and damp removed, and the survivors made as warm and dry as possible. Their master confesses his sins of neglect before the bee-world, and sighs to think of the hardships endured by his charges while left roofless, to be at one time thatched by the snow, and at another slated with ice, and occasionally saturated with water when their temporary cover thawed.

This hardy stock is now working hard in two crates of sections. I have read many accounts of the merits of single and double-walled hives, but I have never yet heard of a stock surviving the coldest months of a winter so severe as the last without any roof!—G. M. E.

A JOURNEY FOR QUEEN-CELLS IN SOUTH DEVON.

[718.] It may be refreshing to you to know my surroundings, so I will give you a rough idea of a journey for queen-cells made the other day in company with my son. Having a necessity for such, we walked to Dittisham, about five miles from here. The day was fine, in fact an ideal bee-day. Starting from Paignton, which is situated on the inner shores of Torbay, and commanding views of Torquay on the left and Brixham and Berry Head on the right, we made our way along the main road, from which grand views of the coast and bay are seen. Leaving the main road, we struck across the common, down the lane to Glampton village, thence along the road to Greenway Ferry: the 'peeps' command the creek running in from the Dart (or English Rhine, as it has very aptly been named). Glampton, by the way, enjoys a small ship-building industry. Arriving at the ferry, we crossed to Dittisham, of plum renown: orchards cover the slopes to the river for many an acre. Imagine yourself walking up the roof of a house, and you would have the correct idea of the main street of Dittisham. My friend's abode is at the top, where in due course we arrived, and made our way to his apiary, which is situated on the hill-side. The hives, forty or fifty in number, are rather too shaded in my simple idea, but having no open space, I think it is 'Hobson's choice' with him. Swarming has been an almost every-day occurrence lately, but his hives are rather of a small make. Having cut out the requisite number of queen-cells, and enjoyed a quiet chat—of course, on bees—we wended our way homewards in the cool of a most beautiful evening, and could not help thinking our editors would have enjoyed a similar trip amid such beautiful surroundings. I suppose it is too much to think you will ever pay this part of the country a visit, but (if you should journey this way) I enclose my card, and hope you will not hesitate to come and see—*DRONEY, Paignton, South Devon.*

P.S.—My hives are doing well. Most hives have two crates of sections, or shallow-frame supers, on. Some are good enough for three. Weather now dull and inclined to be wet, but warm. I hope for sun again soon, as the clover is plentiful and in its prime.

[We had the pleasure some years ago of walking over the ground referred to, and have a pleasant recollection of the beautiful scenery and surroundings of the district. Thanks for your kind invite, which we will bear in mind should we ever again visit South Devon.—EDS.]

CARNIOLANS AND CARBOLIC ACID.

[719.] Owing to the accounts of Carniolan bees which appear in the *Journal* from time to time, I got a queen last autumn from F. Benton. I find they are the best honey-gatherers I ever had, besides being good breeders. I took some sections from them on Friday, the 3rd, the first I have taken this season; but they refuse en-

tirely to be driven with carbolic acid. I purchased some of Calvert's No. 5, and diluted it with about one pint of water to an ounce of acid, but the bees took hardly any notice of it. Then I used the undiluted acid, but I might as well have tried to move the earth as drive them out of the sections with it; they would not stir one jot, so I had to use smoke. Can you account for this indifference to the acid fumes, for I can assure you the bees don't care for it a bit? The weather here was very bad all the spring for bees, but the past fortnight has been a grand change.—*THOS. KENDALL, Knittleton.*

[Before we can quite decide why the bees refused to move when the acid was applied, you must make it clear whether it was used in the form of a 'carbolic sheet' or in your ordinary smoker, after the fashion of Webster's fumigator. Refer to 'Notices to Correspondents' for reply to your other question.—EDS.]

CARDBOARD WRAPPERS FOR SECTIONS.

[720.] Three years ago I bought from the 'British Bee-keepers' Stores,' 23, Cornhill, E.C., one gross of scored cardboard wrappers for 1s. 6d. They were plain pieces of cardboard, scored, made just to fit around a $4\frac{1}{4} \times 4\frac{1}{4} \times 2$ section of honey. I tried last year, and again this year, unsuccessfully to get any from several of the principal advertisers in the *B. B. J.* Can you tell me where to get them?—*F. P. CHAMBERLAIN, Soley, Ramsbury.*

[Perhaps some reader or advertiser will furnish our correspondent with the desired information.—EDS.]

A SWARM INSIDE A HOBBY-HORSE.

[721.] We often read in the *Bee Journal* of bees, when they swarm, entering into strange places, and making use of them as hives. The following may be of interest to your readers:—A month ago a neighbour of mine, named Coppin, had a swarm, which was seen to leave one of his hives, and fly away without settling, and as there was no one near able to follow them they were lost. About two hours afterwards Coppin was told that a swarm of bees had been seen on a horse at the Rye House, but he, thinking it was a hoax, took no notice of it at the time.

The Rye House (scene of the Rye House Plot) is situated about five minutes' walk from where we live. During the summer months the castle, gardens, and grounds are open to pleasure parties. There are all sorts of amusements in the way of swings, roundabouts, &c. After the season is over the roundabouts are taken down and packed in an open shed. The wooden horses are hollow inside, having a space about 2 ft. 3 in. \times 9 in. \times 7 in. The iron rods, which are suspended from the roof, pass through the middle of the horses, and are secured by a nut screwed underneath. For convenience these rods are taken out when the horses are packed away, thus leaving an entrance to the space inside the

horse. It was through this hole that Coppin's bees found their way in.

A fortnight ago the horses were wanted for use, and were taken out of the shed and put together on the roundabouts. The horse with the bees in it was one of the centre ones. When the iron rod was put in it closed the entrance, and the bees were imprisoned inside the horse. After a day or two they found a way out. The wooden plug which fastens the horse's tail in did not fit the hole tight, and by the side of this the bees made a new entrance. Meanwhile the horses were being used, but it was soon too warm a quarter for the visitors. The men in charge of the horses stopped up the holes, but the bees managed to get through again, and soon cleared the course, driving the visitors to a safe distance, which was a loss to the owner of the roundabout. He sent word, asking us to go and destroy the bees. So last Wednesday evening, after the visitors had left, we went, taking with us an empty skep, smoker, and some tools. We took the horse off the iron rod, took its tail out, which left a hole about one inch in diameter; over this hole we placed the skep, stopped up the hole in the horse's back, and gave an injection of smoke through the rod-hole on the underneath side. After about a quarter of an hour's driving we had about two quarts of bees out, and safe in the skep. We then made the tail-hole large enough to put one's arm through, and proceeded to get the comb out. The inside of the horse was quite full. The combs were built very irregular, and were a shapeless mass—no doubt the centrifugal force caused by the horses going round displaced them. There was a fair amount of brood, and a nice lot of honey. Altogether we had a good painful of comb. We took the bees home, and now they are working very well, and seem none the worse for their visit to the old Rye House, and their ride in the hobby-horse.—HENRY INSTON, *Whithy Road, Hoddesdon.*

CARNIOLANS AS NON-SWARMERS.

[722.] Having read in the *B. J.* many praises of Carniolan bees as being a good swarming sort, and seeing in the summer of 1889 choice young Carniolan queens advertised for sale at 4s. each, I thought I would try one. She arrived all right, and was safely introduced in the month of August. The bees went into winter quarters very strong, and came out well in the spring of 1890, but did not swarm as I expected. I waited day after day, and though the hive was crowded no swarm came off. What was I to do? Swarm they would not! so I decided to place a second frame hive over the first one, and they at once took to it. The hive then contained fifteen standard combs crowded with bees; they filled the top frames and I extracted twenty-two pounds of honey from them, returning the frames the same evening. In about a week they had filled the combs up again with honey, so I took them off and examined the lower body-box, and to my

surprise found that the eight frames in it were well filled with honey, on which they wintered, so that I got nearly forty pounds of honey for myself last year. This season (1891) they were very strong early in May; towards the end of the month they lay outside the hive in a large ball. I again waited day after day to see if they would swarm, but no! they still hung out, the cluster of bees getting larger every day, but they flatly refused to swarm. The fine weather was passing away and I did not like to see them idle, so after waiting nine or ten days I decided to give them surplus room again; they have now sixteen frames this year, and are working well. If the fine weather lasts I am hoping for a good harvest. I may here say my Carniolans are the best stock I have. All being well you shall hear what they have done later on.—T. LINTER, *Alma Road, Winton, Hants.*

[Are you quite sure the bees are Carniolans? —'non-swarming' being altogether foreign to the nature of these bees.—Eds.]

THE NEW SECTION BOX.

[723.] In the *B. B. J.* of June 18th you described a section crate (Fig. 14). In your issue of the 9th inst. 'Dorset Bee-keeper' asks you who is the maker, and you refer him to the advertising pages. I have eagerly sought the desired information in every issue since the description appeared, and cannot find it. Is there no way you can convey the information to your readers without appearing to favour one manufacturer of bee-appliances more than another? There are many of your readers who would be glad to know where to obtain the section box from, and among them, yours—THOS. MORGAN, *St. Wenegrid's, Malvern, July 11th, 1891.*

P.S.—I keep about twenty stocks of bees myself.

[We are pleased to find the firm who made the article referred to are now advertising it for sale in our columns.—Eds.]

Queries and Replies.

[378.] *Should Bees be transferred from Skeps in July?*—I bought a stock of bees in a skep the beginning of June, and to shelter from heavy rains put them, skep and all, into a bar-frame hive, and put crate of twenty-one sections on top. I examined them on Wednesday, and found the skep full of comb and bees, the outside of skep also being thickly covered with bees, but they do not seem to be filling the sections anything like so quickly as those of some of your correspondents, only four being full and ten in different stages of completion. Will you kindly advise as to whether I had better transfer the combs in the skeps to the frames at once, or leave them till later in the season, there being four unsealed queen-cells at the bottom of comb, or would it be better to drive bees only out of skep and let them build

fresh comb in the frames, and the best time of year to do it?—T. BARRY, *Sutton, Surrey, July 11th.*

REPLY.—By the time this appears in print the bees will either have swarmed or be on the point of doing so. If not too late to deal with the swarm, we should advise its being hived on full sheets of foundation, set on the old stand, and the uncompleted sections, along with a few more, being given to it to finish, the parent hive, of course, being moved to a stand some distance away. On no account do any transferring, such as you suggest, at this season.

[379.] *Bees and Superfluous Wax.—Painting Hives, &c.*—1. If combs from which the honey has been extracted are put back into the hive for the bees to refill, what do the bees do with the wax scales secreted in their bodies, and with which they would otherwise construct cells? 2. Is it advisable to paint a hive occupied at present? 3. Whether is an old straw hive with flat crown or super or a new movable frame hive the more suitable for taking to the heather? 4. What does the early killing of drones, averaging one per diem, signify?—DUMBARTON-SHIRE, *Kirkintilloch, July 9th.*

REPLY.—1. Bees only secrete wax when it is required for their own purposes, and any superfluous wax-scales are usually dropped on the floor of the hive. 2. If urgently needed, painting hives at this time will do no harm, care being taken to paint the front portion and top of roof after the bee-work of the day is over. Should the alighting-board be painted, a handful of fine dry sand must be sprinkled lightly over it while the paint is wet. 3. All depends upon the construction of the frame hive. Supposing it to be of a type suitable for moving to the moors, we should prefer taking a frame hive to a skep for the heather harvest. 4. It signifies nothing.

[380.] *Hatching Bees in Incubators.*—1. Has honey stored in combs previously occupied by brood an unpleasant or different flavour from that stored in new combs? 2. Is the young worker-bee always fourteen days after leaving the cell before she flies to gather honey? 3. In the spring I took some frames of sealed brood from hives, and placed them in warmth. The bees came forth in due course. Meantime young brood was produced in hives in added frames. Has this kind of artificial incubation ever been tried on a large scale? Would it not be an easy means of increasing stock, as the bees usually clustered to give warmth to sealed brood might, during the fortnight the brood is sealed, bring on two sets of combs from the egg to sealing? 4. To make sure of swarms, why not clip the queen, and place an empty hive or one with foundation on the ground opposite the hive from which a swarm is expected?—N. SMITH.

REPLY.—1. Honey is not so good when stored in old combs as when extracted from clean, virgin combs, never occupied by brood or pollen. 2. No; much depends on the weather, though the young bee does do a certain amount of

nurse-work while gaining strength of body to enable it to undertake the harder labour of foraging. 3. Yes. Experiments have been tried in that direction, not with any encouraging amount of success, we fear; we shall be glad to have the results when you have given your plan a trial. 4. This also has been tried, though with what success we cannot call to mind. An American writer reports being able to secure 'clipped queens' and swarms by placing a bough of a tree in front, up which she climbs.

[381.] *Using Carbolised Sheets.*—I have only just commenced to use the carbolic sheet instead of smoke. 1. Please say whether it is correct to let it remain on top of frames as long as the hive may be open, say a quarter of an hour or more, merely turning back the end to take out such frames as one may wish to manipulate, or should it be removed after a minute or so, and if thus what is to prevent the bees crowding up again? The former plan is the one I have adopted. 2. A queen raised from a *hybrid Ligurian* egg in a *hybrid Carniolan* stock—would she partake in any degree of Carniolan nature in consequence of the feeding, &c.?—EAST DULWICH.

REPLY.—1. The best material for use as carbolic sheets is coarse open canvas, and if this is used the sheet not be removed till the examination of the hive is completed. On the other hand if a close or impervious material is used, the fumes of the carbolic acid might drive the bees almost *en masse* from the hive. 2. No.

[382.] *Covering for Hives.*—What is the best covering for bees in bar-frame hives for winter? Last October I had a stock, strong and well stored with honey. In March, to my surprise, I found the bees dead and mouldy, and the comb damp and offensive; three woollen quilts on the top (covered with a piece of oilcloth) all wet and rotting. I directly examined four other stocks, on which an oilcloth or enamel-cloth lay first, and other woollen quilts above, and found all right, dry and healthy. Do you advise thin board, enamelled cloth, or hempen carpet, as a first covering?—A CHARLBURIAN.

REPLY.—To cover frames with pervious coverings or quilts, and place over these an impervious covering of oilcloth, means nothing less than condensing and preventing the escape of any moisture which may arise from the warmth of the hive below. The oilcloth, if used at all, must be placed directly on the top bars and the quilts above it. Our own practice is to cover with oilcloth, next set on the quilts, and over all we place a covering of board in three pieces.

[383.] *Removing Glass Supers.*—Will you kindly advise me as to best means of removing a glass super to prevent bees piercing the caps? Said super being five sheets of glass fastened with transparent cement, and intended for exhibition, therefore I cannot smoke or use carbolic from above the combs. If I draw a carbolic cloth between super and frames, would not this cause bees in super to at once begin on

the sealed combs at top.—GEORGE CORBYN, *Snettisham*.

REPLY.—The carbolised cloth will do more harm than good in your case. The only course is to use one or other of the super-clearers which have been described in our pages, and to proceed as gently as possible in raising the super from the hive, so as not to excite the bees.

THE PERILS OF BEE-KEEPING.

A good instance of the perils of bee-keeping may be found in the story, first given, we believe, in a bee-newspaper some years ago, of two men who were transferring five straw hives to a lonely cottage on the moors, in order to reap the late honey-harvest of the heather. The conveyance used was a spring-cart with two wheels. When the men reached their destination they unharnessed the horse, put him in the stable, and shut the door. Meanwhile they had propped up the shafts of the cart upon a fence. So far so good; but the taking of the hives out of the cart proved to be a delicate business. One of the men climbed into the cart, and began to hand out the skeps one by one. But the man in the cart (to avoid periphrases we will call him A) forgetting how insecurely the vehicle was balanced, incautiously stepped over the seat, holding one of the straw hives in his hands. The shafts instantly tipped upwards, the whole cart turning on its wheels like a sea-saw on its fulcrum. The other man, B, with great presence of mind, seized the tail of the cart with both hands, and tried to hold it up by main force. But A had hopelessly lost his balance, and floundered heavily forwards upon B. As he fell, the floor-board of the hive which he held in his hands dropped off, and he rammed the hive down upon B's head like an extinguisher upon a candle. Then followed a complete collapse. Two boys, who were sitting on the fence, began to laugh immoderately at first, when the catastrophe took place, but in a very few minutes they were running away as fast as they could, hitting fiercely about with their caps. This shows that one should not laugh prematurely at the misfortunes of others. The story has several variants; if we remember aright, A and B, although badly stung, recovered in due course, but the five colonies of bees were hopelessly lost.—R. C. D.—*Graphic*.

Echoes from the Hives.

Honey Cott, Weston, Leamington, July 10th 1891.—The three stocks at my small out-apiary have done fairly well. Last Saturday, as the weather looked promising, I went and put crates of sections under those that were well on the way. I may say one lot had two crates on, and some were filled; however, as it was too late to take any off, I just slipped another crate under other two stocks, thinking they would go on and fill them. Well, it came on to rain for three

days; I quite expected to find, when I went after it cleared up, that the bees had taken a lot of the honey down. Judge of my surprise when I uncovered the sections to find them quite deserted—the under empty crate and the cold nights had made the bees entirely withdraw, so that I took off forty splendidly filled sections, and scarcely a bee, not more than twenty amongst them; the cold nights and the empty crate had acted as a perfect bee-escape. If we can but have some nice warm weather (and it seems to look more like it now), there will be some honey yet. I do not think I have seen so much white clover round here since 1881. The last few days of wet have made stocks start queen-cells, and English bees seem determined to swarm as well as others. Had two immense swarms join yesterday, and, after taking out queen-cells from old stock and putting eight frames of combs and foundation under the old stock, and excluder on again, I gave them two more extra boxes of shallow combs, putting one with bees and honey on top, and throwing united swarms back in the evening. Truly this has been a curious season.—JOHN WALTON.

Bee Shows to Come.

July 23rd, 24th.—Lincolnshire Agricultural Society at Brigg. Stephen Upton, Sec., St. Benedict's Square, Lincoln.

July 28th to 31st.—Highland and Agricultural Society at Stirling. Mr. T. D. Gibson-Carmichael, Melrose, N.B.

July 29th, 30th.—Leicestershire B.K.A., in connexion with the Leicestershire Agricultural Society, at Leicester. Entries (except for honey) close July 11th. Entries for honey may be made up to 22nd July. H. M. Riley, Tower House, Leicester.

August 5th, 6th, and 7th.—Yorkshire Agricultural Society at Bradford. Entries closed June 27th. Marshall Stephenson, Sec., York.

Sept. 5th.—Alderley Edge and District Branch of the Lancashire and Cheshire B.K.A. Chelford Flower Show, Astle, Chelford. Schedule, &c., T. D. Schofield, Alderley Edge, Cheshire.

Sept. 9, 10.—Derbyshire Bee-keepers' Association at Derby. Entries close August 27th. W. T. Atkins, Sec., 12 North Street, Derby.

REVIEW OF THE BEE JOURNALS OF GERMANY AND AUSTRIA.

By J. DENNLER.

(Concluded from p. 254.)

8. *Deutscher Bienenfreund*. Twenty-seventh year. Editor, Krancher.—Near Oeningen, a small village in Baden, is situated a stone quarry, in which Professor Heer, of Zürich, discovered some years ago 844 species of fossil insects dating from the Tertiary period. Amongst them is also found a bee, well preserved, and at present in the Museum at Zürich. The size is about that of our ordinary worker.

part of the tongue, the thorax, wings, and abdomen are well displayed. In the head are easily distinguished the two compound eyes and two of the simple eyes. It was called *Apis adamitica* by Professor Heer. [We fully described these fossils and the flora of the period in the *B.B.J.* for 1844, page 94, showing that the *Apis adamitica* could not be looked upon otherwise than as the ancestor of our present bee.—Ed. *B.B.J.*]

9. *Bienenzeitung*. Forty-seventh year. Editor, Vogel.—Dobratz recommend *Wistaria chinensis* as a honey plant. This is a climbing plant, flowering in June, some of the flowers even postponing their opening till August. The blue flowers resemble those of the acacia, and are much visited by bees. The *Wistaria* came originally from China. Professor Caspar Wistar, of Philadelphia, who died in 1818, gave it his name. This plant climbs to a height of thirty metres.

10. *Elsass - Lothringischer Bienenzüchter*. Nineteenth year. Editors, Dennler and Zwilling. No. 1.—Scarcely has Pastor Baelz, of Würthemberg, sounded the funeral knell of the Koerbs comb foundation than two others make their appearance. A Saxon named Cesar Beyer claims to have invented a machine by means of which comb foundation can be produced having cells one to two centimetres deep. He has patented this invention, which he calls '*Edi foundation, patented.*' An Austrian dealer has manufactured combs of tin. Cells the depth of natural ones, and even double, were filled with honey by the bees and then capped just the same as though they were waxen combs. Several specimens of these combs filled with honey were shown at the Agricultural and Forestry Exhibition at Vienna last season. Jules Steigel, of Pernersdorf, is the inventor. [Unfortunately for him, this invention is not new, such combs having been made by Quinby in 1870, and were not only filled with honey, but were also used by the queen for brood-rearing. The fact was demonstrated that bees would accept and occupy combs made of foreign materials, but after thoroughly testing them it was evident that the weight and the expense of such combs would render them impracticable, and they were given up.—Ed. *B.B.J.*]

Adulteration of wax.—In order to determine if comb foundation is pure and contains only beeswax, put a small piece of foundation in a basin and melt it, without, however, overheating it. In another basin dissolve a piece of soda about the size of a nut in two spoonfuls of hot water. Then mix the two. If the comb foundation is of pure beeswax the resulting mixture is white mass. If, on the contrary, the foundation contains ceresine, this floats on the surface in the form of an oily substance. Ceresine does not saponify with soda.—No. 2. Dennler gives an instance where a young queen stung him three times. Vierling had a young mated queen that laid sterile eggs—*i.e.*, eggs from which neither workers nor drones were produced; he was obliged to replace her by another.

Notices to Correspondents and Inquirers.

Letters or queries asking for addresses of manufacturers or correspondents, or where appliances can be purchased, or replies giving such information, can only be inserted as advertisements. The space devoted to letters, queries, and replies, is meant for the general good of bee-keepers, and not for advertisements. We wish our Correspondents to bear in mind that, as it is necessary for us to go to press in advance of the date of issue, queries cannot always be replied to in the issue immediately following the receipt of their communication.

All queries forwarded will be attended to, and those only of personal interest will be answered in this column.

MR. A. J. CARTER, of Billingshurst, Sussex, requests us to state that the honey for which he was awarded first prize in Class 309 was gathered this year. [We gladly insert the above correction, and must congratulate the winner on what must have been a very exceptionally warm clover corner to have secured such honey when the failure was so general everywhere else.—EDS.]

THOS. KENDALL (Knittleton).—All subscribers have their *Journals* posted the same day, and should be received on the Thursday of publication. Your postman must, we think, be at fault; else why do not other subscribers complain of late delivery?

W. FARNWORTH (Swindon).—*Swarms taking Possession of Empty Hives.*—It is quite impossible for us to advise you what to do with only the scant details given to guide us. Were the empty hives prepared for the swarm—*i.e.*, fitted with comb foundation or with ready-built combs, and are they perfectly free from disease? If the bees persistently refuse to enter the hive, there must be something wrong in the interior. If a fair portion of the swarm has taken to the hive, and the queen is with them, eggs and brood will be found in the cells by the time this appears in print. But if the 'discontented bees' have no queen, they cannot possibly raise another unless eggs be given them from the other hive.

JAMES HUTCHINSON (Cheltenham).—'Our idea of a workable section box' is given in the article you refer to, and we cannot very well give further information regarding it except saying that if you purpose making similar boxes it would be necessary to procure a pattern to work from.

MOUCHE-À-MIEL (Wolverhampton).—1. To divide colonies at this time will certainly lessen very considerably your chance of obtaining much surplus honey. 2. To a great extent, yes. 3. Yes.

JAMES RYDE.—*Bees Refusing to Enter Supers.*—The bees in question are not increasing so rapidly as your other stocks, or they would certainly take to the supers, all other things being equal. Perhaps the present rapid inflow of honey will put things right.

* * Several letters have been received to which replies will be given next week.

BALDWIN'S

is the Oldest Establishment in the United Kingdom wholly devoted to Bees and manufacture of

Bee-keepers' supplies. His prices will compare most favourably with those of any other Maker, while for quality of material, suitability and workmanship, he has no rival.

'Why can he give better value for money than others?' Because he spends less in large 'puffing' advertisements, buys in the best markets for prompt cash, has no rent to pay, and personally conducts his own business.

For prices and full particulars of Goods see Baldwin's Bee-keepers' Instructor (and Illustrated Catalogue combined), which 'contains more practical and reliable hints than all the large, expensive books,' post free for 2d. stamps. Address **S. J. BALDWIN, The Apiary, Bromley, Kent.**

N.B.—More than 500 Silver and Bronze Medals, First and other Prizes, and Testimonials innumerable.

BEST FOUNDATION for WIRED FRAMES, 2s. 3d. per lb. (about 9 Sheets). Best SUPER, 2s. 7d. per lb. Perfect SMOKER, 2s. 6d. FRAMES, 10d. per doz. SECTIONS, 2s. 6d. 100. METAL ENDS, 5d. doz. METAL DIVIDERS, 10d. doz. **CATALOGUE FREE.** Innumerable Testimonials received. **G. STOTHARD** (1st Class Expert), Welwyn, Herts. **WELWYN LUBRICATING GREASE for CARTS, 2s. 6d. per 28 lbs.** 2489

CHEAP WOOD FEEDERS,

HOLDING ONE POUND OF SYRUP.

Can be used for Fast or Slow supply.

4d. each, postage 3d. No. 88 in List.

Bright Foundation, 1/10 lb. Darker ditto, 1/3 lb.

EDEY & SON,

STEAM JOINERY WORKS, ST. NEOTS.

ON HIRE, BEE TENT.—For Terms apply to **A. J. BROWN, Hon. Sec., Bradley, Wotton-under-Edge, Gloucester.** 238

British Bee Journal and Bee-keepers' Record.

OFFICE :

17 KING WILLIAM STREET, STRAND, LONDON, W.C.

PURE CANE SUGARS.

For the accommodation of Bee-keepers, guaranteed Pure Cane Sugar will be supplied in large or small quantities through this office at the under-mentioned rates:—

CRYSTALLISED.

4. DEMERARA	} Neat bags, 14-lbs. 28-lbs. 56-lbs. Cwts.
5. BARBADOS	
6. TRINIDAD	} Crystals 2/9 5/4 10/6 20/6

REFINED CANE.

7. WHITE CRYSTALS (Small)	3/0	5/10	11/6	22/6
8, 9. (Medium and Large sizes, 1/- per Cwt. extra.)				
10. LUMP (Cut Loaf) ... Boxes,	3/3	6/3	12/3	23/6
11. LUMP DUST ...	3/0	6/0	11/9	22/9

All above guaranteed made from CANE SUGAR only, and free from BEET, CHEMICALS, etc., etc.

CARRIAGE PAID on Orders over 5/0 (or 28-lbs. Sugar) to London and Suburbs.

COUNTRY ORDERS, not less than 2-cwt. carriage paid at 1/0 per cwt. extra. (Scotch and Irish orders, special arrangements.)

Cash to be sent with order, and purchasers will please observe that if samples are required or replies asked to inquiries, a stamped addressed envelope must be sent, as we cannot undertake cost of postage.

APIFUGE.

The Original and **ONLY PERFECT** Preventive against **STINGING.**

Quality Improved & Price Reduced.

In 1/- & 2/- Bottles; British postage 2d. extra. All orders must be accompanied by remittance. **Special Terms to the Trade.**

One Correspondent says:—'I have used it on removing a particularly irascible colony into a clean hive, with perfect success.'

Another says:—'I have kept bees for thirty years and have lately purchased a bottle of this wonderful stuff, and cannot persuade my bees to sting me do what I will with them.'

DARCY GRIMSHAW, Horsforth, Leeds.

Invaluable to Travellers Abroad as an Insectifuge.

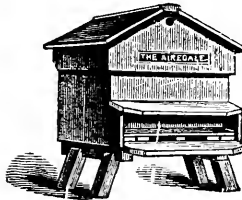

THE YORKSHIRE Bee-keepers' Supplies.

WILLIAM DIXON,
5 Beckett St., LEEDS.

Hives, Extractors, Smokers, Feeders, Foundation, &c. Prizes awarded, Gold, Silver, and Bronze Medals. 226

PRIZES awarded at the ROYAL AGRICULTURAL SHOW, held at Doncaster:—

Second Prize for the Best Collection of Appliances. Second Prize for the Best Observatory Hive, stocked with Bees.

First Prize for the Best Display of Honey. Certificate for Swarming Arrangements, and other Prizes.

WOOD BEE FEEDERS.—Hold 2 lbs. Syrup, 6d. each, by post, 6d. extra; 5s. per dozen on rail. Address **J. M. BALMERA, East Parade, Alnwick.** 2920

THE HONEY BEE:

Its Natural History, Anatomy, and Physiology.

By **T. W. COWAN, F.G.S., &c., &c.,**

Editor of the British Bee Journal.

Cloth gilt, price **2s. 6d.**; postage 2½d.

London: **HOULSTON & SONS, Paternoster Square**

ALL BOOKSELLERS; AND

British Bee Journal Office, Kings Langley, Herts; and 17 King William St., Strand, London, W.C.

BRITISH BEE-KEEPERS'

PRACTICAL NOTE-BOOK,

With Rules for the General Management of Movable Comb Hives.

By **THOS. W. COWAN, F.G.S., &c.,**

Editor British Bee Journal.

Consists of a Series of Tables by means of which the Bee-keeper can keep a record of all his Observations and Operations. A Pocket-companion indispensable to the practical Bee-keeper.

Price 1s., postage 1d.

Bee Journal Office, Kings Langley, Herts; and 17 King William Street, Strand, W.C.

THE
British Bee Journal,
BEE-KEEPERS' RECORD AND ADVISER.

No. 474. Vol. XIX. N. S. 82.]

JULY 23, 1891.

[Published Weekly.]

Editorial, Notices, &c.

USEFUL HINTS.

WEATHER.—After a severe thunderstorm, with a deluge of rain on the 8th and 9th, we have had ten days of fine weather, so fine generally that bee-keepers north and south have but little cause for complaint. Moreover, a good deal of honey has been secured, and the numerous swarms appear to have done uniformly well. It will be quite a common occurrence this year for swarms located in good districts, and hived from four to six weeks ago, to yield forty or fifty pounds of surplus. Our dread just now is that the warm, dry days, so frequent, may tend to promote a too plentiful supply of honey-dew; but sufficient for the day is the *good* thereof, and, with white clover abundant, bees are kept busy on its bloom without having time or inclination to forage about in search of the objectionable stuff just named. It is quite abnormal to look upon white clover in full bloom in the south at date of writing (July 21st), when we were accustomed to see it nearly over by the same date in our former more northerly location of West Cheshire. The reports reaching us of the prospects of a good year are uniformly satisfactory, while in some places we hear of 'honey coming in by the hundredweight.' Those who still cling to the Briton's inborn belief that a dry 'St. Swithin' means a dry fortnight following were in great 'form' this year, for the good saint's day was free from rain in most parts. Said one bee-keeper to us, after anxiously noting the sky on the evening of the 15th, 'We're all right now for a fine fortnight!' And certainly it was as nearly 'all right' as could be wished until the evening of the 19th, when a heavy downpour occurred—clearly proving, of course, that there must have been rain somewhere on St. Swithin's Day. The tre-

mendous downfall which took place in Kent on the 19th will remove any mischief from honey-dew for some time to come, so we must be thankful for small mercies.

SURPLUS HONEY.—Sections, when completely sealed, should be got off the hives and be removed indoors without delay. Where hanging frames are used, the sections are quite readily removed from them if dealt with before any adhering propolis becomes hard. Frames intended for extracting may, on the other hand, be left on the hives till the honey is wanted, or till the income begins to fail. Unlike comb honey in sections, it does not 'spoil' by being left on the hives, and it ripens there better than anywhere else. Sections should be kept free from dust, or the slightest soiling by handling, or their market value will be thereby lessened. The advantages of working sections in hanging frames will be most felt as the season draws to a close, when, by removing centre ones—which are nearly sealed and finished off—to the outside, and those least forward to the centre, the work of completion is helped on, and it only gives a tithe of the trouble to transpose sections in frames compared with doing it when ordinary racks are used.

CLEARING BEES FROM SUPERS.—There is just this difference between clearing bees from comb honey—either in sections or in supers—and from extracting frames, that whereas with the former the greatest care must be taken not to have the cappings of the comb pierced by the bees—as they will when filling themselves with honey under influence of fear—or by soiling the combs under the same influence. To avoid this, the new super-clearers will be of the greatest service, for if the rack of sections on the super is handled very gently, the bees will be unconscious of what is being done, and when the 'clearer' is in operation they leave the combs of their own accord without doing any damage. With combs for extracting, on the other hand, we simply shake

off the bees from each comb on to a board in front of the hive as they are lifted out, exchanging empty combs from the 'carrying box' for the full ones removed. Should the bees be at all unruly, or if no honey is coming in at the time of removing surplus, and robbing is prevalent, the super-clearer may be used instead of the rough-and-ready plan given above.

THIN LATHS FOR QUILTS.—A correspondent, who writes on another page (726, p. 328) regarding these, is so pleased with them, and so anxious that bee-keepers should share the advantages gained by their use, that, at his request, we have given them a trial. They answer the purpose named by 'A Kentish Bee-keeper' very well indeed. But, besides their special adaptability as a covering next the frames, these laths will be most useful in the apiary for a score of purposes, and, when propolised and rendered unfit for use as a covering for frames and sections, will be worth all the cost as fuel for smokers or for firewood. At all events, we have been wise enough to take our friend's hint and have secured 2000 feet of them, 'just to go on with.' *Verb. sap.*

BRITISH BEE-KEEPERS' ASSOCIATION.

Committee meeting held at 105 Jermyn Street, on Wednesday, July 15th. Present—T. W. Cowan (in the chair), Hon. and Rev. H. Bligh, W. Lees McClure, J. Garratt, with W. Broughton Carr and J. M. Hooker, *ex officio*, and the Secretary.

The Finance Committee presented their report in reference to the Doncaster Exhibition, recommending payment of the several accounts relating thereto.

A letter was read from the British Dairy Farmers' Association intimating that the council of that Society had accepted the proposal of the British Bee-keepers' Association for the inclusion of classes for honey in their prize list for the next dairy show.

The prize schedule of the Royal Show was considered and amendments made thereto. The Secretary was requested to have proofs of the same prepared previous to the date of the next meeting.

Resolved, that the question of adopting some preventive measures against the spread of foul brood, more especially by the action of experts who may have gained a certificate of the B. B. K. A., be taken into consideration at the next meeting.

Resolved, that application be made for outstanding subscriptions of the current year.

The Committee adjourned until the third Wednesday in September.

VISIT TO WAKES COLNE RECTORY.

(Concluded from page 318.)

Passing from the bees, Dr. Bartrum invited his guests to have a look at the other live stock. First in order came the pigs, and what a well-fed, happy family they were! the plumpest, blackest, merriest, and certainly the biggest families of future porkers we have seen for many a day. A mother and her daughter seemed to vie with each other as to which could do the 'biggest thing' in brood-rearing, as we bee-keepers have it. It was quite alarming to our non-maternal instincts to think how the 'feeding-bottles' necessary for the abnormal number of black and shiny baby-porkers could possibly keep up the needful supply, considering the tremendous demand made. A satisfactory solution of our doubts, however, came from the Doctor himself, when he observed, 'These are capital mothers, and, you see, we feed them three times daily, and always keep the *water-troughs full*.' Happy mothers of large porcine families, may you and yours continue to thrive and increase at Wakes Colne as ye do now, and thereby still keep on filling with sixpences the pockets of the worthy fellow who so carefully tends you.

Dr. Bartrum takes special pride in making his various hobbies *pay*, and in securing this very desirable end the plan followed is to give his managing man a percentage of all produce sent to the market. Surplus fruit, honey, eggs, poultry, and pigs all yield their share of profit to the Doctor's man as well as to himself. And this liberal arrangement, the latter assures us, works most satisfactorily to all concerned. Certainly, if results are to be judged by the—to any but a fond mother—alarming number of healthy four-footed little rascals with which each sow was surrounded, the 'sixpence per pig' falling to the man's share is a wise investment, and we advise any reader who 'raises pigs' to take the 'useful hint' here given, and do likewise.

In laying out and planting the extensive new orchard the same economic principles are carefully followed, only the best and most productive varieties of each kind of fruit being planted, while the growing, pruning, and general treatment of every tree and bush is managed in accordance with the experience of the best authorities. Everywhere around there appeared a healthiness and vigour about the—to us—curiously trained young trees, and such fine crops were seen on quite a bewildering number and variety of apples, pears, plums, and ever so many etceteras, that it was a matter of wonder how the names of the numerous 'sorts,' and the various 'habits' of each variety of fruit-tree could be retained in one man's memory. Fortunately the soil at Wakes Colne seems well adapted for fruit-growing, and to this, no doubt, in a large measure is Dr. Bartrum's success due.

On the principle that 'the proof of the pudding,' &c., a 'friendly visit' was next paid to the Doctor's strawberry-beds, not the least

pleasant part of which was the heartiness with which their owner enjoyed the operations of the 'attacking party' among the luscious 'British Queens' growing in abundance around. 'I always consider,' said one well-known bee-keeper, 'that there is nothing so fine as a good strawberry just picked from the plant,' a sentiment in which several other well-known bee-men concurred in thoroughly practical fashion. Next came a tour through the garden orchard, wherein the older trees were in many instances literally bending down with the weight of the crop of fruit. The rose garden, also, though passed its prime for this year, had still a wealth of bloom. Indeed, the soil appears to be as well suited for flowers as for fruit-growing, everything looked so well.

Leaving the Rectory grounds, the interesting old Norman church close by was inspected. Several little Norman windows are seen near the roof in perfect preservation. Passing beneath the old oak porch, inside which the ivy climbed to the roof in quite old-world fashion, we passed a pleasant half-hour inspecting the quaint interior, speculating and discoursing on the various styles of architecture visible in the sacred edifice, each of which marked an epoch in its history.

Very much delighted with all we had seen, it was now time to think of the fifty-mile journey back to town, and so, after partaking of tea at the Rectory, and enjoying another pleasant half-hour's chat, we made our way to the station, where we bade good-bye to our genial host, every one, we are quite sure, carrying away what will be a happy memory of the visit to Wakes Colne Rectory.

WORCESTERSHIRE B. K. ASSOCIATION.

An interesting event took place in the Guild-hall, Worcester, on the 8th inst., when a special meeting of the Committee was held for the purpose of presenting an illuminated address to Mr. A. H. Martin, 'in appreciation of his long and devoted services in the work of the Association.' The Mayor of Worcester (Alderman Higgs), who was accompanied by the Mayoress, presided, and in making the presentation alluded in complimentary terms to the work done in connexion with the Society by Mr. Martin. The Rev. E. Davenport—who succeeds to the office of Hon. Sec.—also referred to Mr. Martin's services, and hoped the time might come when he could see his way to resume the duties of Secretary.

Mr. Martin—who held the post of Hon. Sec. to the Association from its inception in 1882 to within a few months ago—replied in a few appropriate words to the complimentary way in which his past services had been referred to by the previous speaker; and, in conclusion, assured the meeting that, though compelled by increase of professional duties to give up the secretaryship, he should always be at their command if he could in any way promote the interests of the W. B. K. A.

A vote of thanks to the Mayor for presiding closed the proceedings.

Correspondence.

The Editors do not hold themselves responsible for the opinions expressed by correspondents. No notice will be taken of anonymous communications, and correspondents are requested to write on one side of the paper only, and give their real names and addresses, not necessarily for publication, but as a guarantee of good faith. Illustrations should be drawn on separate pieces of paper.

Communications relating to the literary department, reports of Associations, Shows, Meetings, Echoes, Queries, Books for Review, &c., must be addressed only to 'The Editors of the "British Bee Journal," 17 King William Street, Strand, London, W.C.' All business communications relating to Advertisements, &c., must be addressed to Mr. J. HUCKLE, Kings Langley, Herts (see 1st page of Advertisements.)

In order to facilitate reference, Correspondents, when speaking of any letter or query previously inserted, will oblige by mentioning the number of the letter, as well as the page on which it appears.

BEE ASSOCIATIONS IN THE MIDLANDS.

[724.] I have been much interested in reading the letter of your correspondent, 'Hybrid' (705, p. 309), and having been connected with our County Association since the year 1882, can speak with some little amount of experience. I cannot agree with the statement that the reason the County Associations do not prosper as they should is because the expert cannot or does not visit the members both during spring and autumn. This certainly is not so as far as Worcestershire is concerned. You may have an active committee and an 'indefatigable secretary,' but this is no element of success unless members themselves will do something both individually and collectively to promote the objects which our Associations have been formed to promote, and unless bee-keepers will support them by the regular payments of their subscriptions and induce others to do likewise without being applied to several times during the season, and not even sending answers to letters written at the cost of much time and labour. The apathy extending among members has, in my opinion, far more to do with the want of success attending our efforts than the irregular visits of experts, and it is by removing this apathy that our Associations will be made more vigorous and prosperous.—A. H. MARTIN, *Evesham.*

NOTES BY THE WAY.

[725.] As I am penning these few notes the apples are being christened, and notwithstanding a rising barometer the rain comes down, which, after the past few days of hot weather, is very acceptable to the agriculturist—also to the bee-keeper, for it will give the white clover a new lease of life, and rehabilitate the fields and pastures in a garment of blossom, and in our immediate district it will freshen up the foliage and flowers of the lime-trees that are just beginning to bloom, so that, given fine weather afterwards, which a rising barometer indicates, we may hope to get some lime honey stored during the coming week.

My note in a previous number of the *B. B. J.*,

re the 'Royal Counties' Society's Show at Portsmouth has called forth a protest from Mr. Candy. If I had received a schedule of the show before I wrote the note, the reason for my calling attention to the limits of the Hants and Isle of Wight Association, and the exclusiveness apparent by the schedule of 1890 at Winchester, would not have existed. My contention has always been that the Royal Counties' Show should be open to the residents in the 'Royal Counties,' though I am glad to see the Association have seen their way to throw several classes open to all-comers, and I hope have had a good number of entries. I myself sent some entries on receipt of schedule, and had I known or expected there would have been open classes, I should have made preparations for more exhibits. As regards results of show, I know nothing at time of writing, except a post-card from station-master at Newbury, to inform me my returned cases have been received by him and await removal; from which I gather the exhibits have not been sold, as I hoped they would be.

Progress.—Our American brethren in the craft have, by persistent appeals to the 'Treasury Department' in America, induced the authorities to relax the new stringent clause in the McKinlay Bill, excluding queen-bees, except by payment of heavy duties, from foreign countries. That is a progressive step on the other side—now for the progress on this side of the Atlantic (*vide* page 315 of *B. B. J.*, in the editorial), and I trust secretaries of Bee Associations will press the matter on the attention of County Councils. I am pleased to be able to add that the Berks Association (unfortunately under a cloud just at present, owing to a split in the camp) is in a fair way to regain its former prosperity, as we have extended to us the hope of help from the C. C. of 50%, coupled with the appointment of Miss Carr Smith as Hon. Secretary. This augurs well for the future usefulness of the Association, when we form one harmonious whole in the coming years as we have in the years that are past.

What of the bee-escapes or super-clearers, brethren? Have you succeeded with them this season, and will you give us your ideas on the subject, please?—and perhaps by so doing we may, by comparing notes, arrive at something better for another season. I will add, I find my clearers, with a plain zinc bottom to the centre exit-hole, answer better than with a perforated zinc bottom to the hole; I think it is because the perforated holes allows a freer circulation of warmth from the hive to the super than a plain one, and the few bees left are in more comfortable quarters, and therefore less inclined to clear out. The American bee periodicals have many letters unanimous in their praise of bee-escapes, both in working for extracted honey and also for sections.

Have any of our friends used the self-hivers this season? if so, which make? or has the season for swarms been so bad that the many have not had a chance of proving the utility of self-hivers?

A closing word to *honey-selling* bee-keepers. Don't forget, friends, to use the means established to protect your interests in the sale of your product, and don't rush all your year's produce on the market at once, or you may depend the middle-man will reap the greatest share of the profit connected with bee-keeping. If you have a few hundredweights to dispose of advertise it in *B. B. J.*, and stand up for a fair price for a good article. A Californian bee-keeper started in London a few years back with eighty tons of honey, and he sold the lot in London at a profit to himself for the enterprise. Surely what a stranger, coming nearly four thousand miles, did, you can do in your own country!—W. WOODLEY, *World's End, Newbury.*

BEE-SUGAR—WOOD LATHS FOR QUILTS.

[726.] I am very much obliged for your notes on 'Bee-Sugar.' Every one who has used it, I have no doubt, will have had as much success as I have. It is most important in feeding that the sugar from which the syrup is made should be pure. I fed many stocks this last spring, and (with between thirty and forty) did not lose a single one.

I would also draw the attention of bee-keepers to a novel and very useful article for use as a practical bee-quilt. It has been to me quite a 'find,' and I am simply delighted with it. I refer to the bundles of laths advertised in your pages at 3s. per 2000 feet, or say 1s. for 250 laths. Eight of these laths—costing less than a halfpenny—make a quilt for an ordinary-sized hive. During the short time I have tried these laths I find they are much more convenient than the ordinary quilt, and am very much pleased with the result. My practice is to have one side of the lath planed, and to rub a little vaseline on the smooth side which goes next the frames. I shall be glad to know if you approve of the idea.—A KENTISH BEE-KEEPER, *Chatham.*

[We have referred to the above on another page.—Eds.]

A HOME-MADE SIMPLE QUEEN-CAGE.

[727.] I send you a queen-cage made, as you will see, from a common fusee or match-box. In making the cage the bottom of the inner box is cut out and replaced by a bit of glass same size, with 'stamp-edging' gummed round to keep glass in position. A slip of gauze wire $2\frac{1}{2}$ inches long by $1\frac{1}{2}$ inch wide is bent up at each end so as to slip into the glazed box and occupy two-thirds of its length. In using it I first of all furnish it with some food in the shape of a little diluted honey on a morsel of sponge fastened into the end which is free from the gauze by a paper-fastener, so that the queen when on the hive may feed in peace if the bees in hive are not friendly disposed towards her. Next, put in the queen to be introduced and

shut the box, take it to the hive to be operated on, and cut a small hole or slit in the quilt, between two combs, over the centre of brood nest. Open the box as far as the gauze will permit without the queen escaping, and invert it over the hole. You can then see through the glass bottom how the bees in hive behave. Cover all up *warm* for twelve hours, then slide the box over the hole and let, say, *one* bee come in. If that one is for peace, slide the box again over the hole, and let queen go down into the hive at her leisure; if the one bee is for fighting,

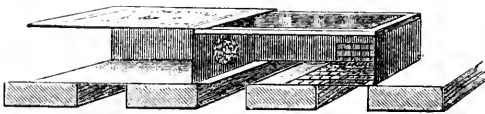

shut the box up and take off the hive, letting the worker escape again, and put the hive on as at first. The description may appear long, but the process is simplicity itself. I have introduced several queens with it, and been successful in each case. I enclose you sectional sketch of the box, which will explain its working.—F. J. CRIBB, *Morton, Gainsborough.*

[A very excellent and simple contrivance, which any one can make, and which will no doubt answer the purpose very well.—Eds.]

CONE-SHAPED SUPER-CLEARERS.

[728.] On Friday, the 10th inst., I was sent for home about 1.30 to take a swarm of bees. On arriving, to my surprise I found they had taken possession of an old velvet turban or hat, which had found its way into the garden to answer the purpose of a scarecrow. The said hat happened to hang on a row of peas, and the bees hived themselves into it without trouble, to be afterwards transferred into the frame hive. The only two natural swarms I have had in my ten years' bee-keeping are the one above referred to and one on July 6th, 1889. I keep pure natives, and foul brood has never, to my knowledge, been in these parts, and properly managed the pure native bees (with me) never seem to want to swarm. The swarm of 1889 alluded to did not come out until the bees had given me 115 pounds of honey above the zinc excluder.

The cone-shaped super-clearer recommended by Mr. Harbordt I have had an opportunity of trying, and am simply delighted with it. I had previously made myself about a dozen and fixed them on hives. In the first hive I tried, communication was cut off from the crate of section below it by a thick quilt made from old bed-ticking, and not a bee remained in the sections. On a second hive a piece of net gauze took the place of the ordinary quilt. This crate was boiling over with bees, and only from forty to fifty remained behind. The crates were set going at 8.30 a.m., and cleared away at 8.30 p.m. Fine day. Mr. Harbordt

deserves the hearty thanks of bee-keepers for so kindly bringing this to the front.—J. W. BLANKLEY, *Denton, Lincolnshire.*

BEES IN CANADA.

SEASON UP TO JULY 3RD, 1891.

[729.] It may be of interest to readers of the *British Bee Journal* to know how bee-keepers in Canada have fared up to date. Winter broke up early, spring appeared to go from one extreme to another, first very warm, then cool, or even cold, with frost, the last frost being towards the close of May, slightly injuring grape-vines and perhaps fruit-bloom. The spring and summer to date have also been remarkably dry in some localities, little rain having fallen from April 20th to July 2nd. The bees are in consequence backward in swarming, and generally have not stored an average crop. Alsike clover has yielded well, as high as sixty pounds from one colony at one extracting being taken. From ninety-two colonies in our own yard I have only had five swarms, and from the colonies run for extracted honey just thirty pounds to the colony; the remainder for comb honey I cannot report on, but think they were the best. For four or five years I have managed to have not more than thirty per cent. of increase, but to date the increase is not up to the average. We have had heavy rains within the last twenty-four hours, and we are looking hopefully to linden, which will open early next week, and then to thistle and fall flow. There is no reason why we should not have a good flow from the latter sources.—R. F. HOLTERMANN, *Brantford, Canada.*

SECTION-CASES OR WRAPPERS.

[730.] 'Beauty when unadorned is,' says the poet, 'adorned the most.' That may be true in some instances, certainly not in all. Section honey is often so attractive as almost to justify the epithet 'beautiful.' But encased in wood, there is often very little that is beautiful, or even attractive. A local tradesman tells me that section honey does not sell now as it once did. 'The wood is often dark and dirty, and the appearance is almost repulsive.' His customers prefer foreign honey. Now, should we not mend this matter as soon as possible? Sections look very well in some of the cases which we see at shows; but the cost of these—two shillings a dozen, twopence a-piece, in addition to carriage—is too high for sale purposes. A cardboard wrapper as a cover, or an edging to the wooden framework, would set off the honey to advantage. Our dealers would soon devise something cheap and attractive. Glass would not be necessary. We ought also to be able to purchase printed notices for the tradesmen who are willing to offer our goods for sale, such notices, I mean, as these, in large characters: 'Fresh English Comb Honey,' 'English Honey for Sale,' 'Pure English Honey,' and so on. A

short paragraph, pointing out the virtues of pure honey in few words and plain type, would assist the cause. We want, of course, to be good bee-keepers, but some of us also want to sell our honey to advantage.—E. B.

[We quite agree with the quotation, 'Beauty unadorned,' &c., and think it applies with special force to sections of comb honey. If these are preserved perfectly clean (as they should be), there is, to our mind, no 'case' in which the honey looks so 'toothsome' as the clean frame of white wood in which it is encased. The latter tells of 'clean handling' so plainly that it is an attraction of itself.—Eds.]

CONE-SHAPED SUPER-CLEARERS.

[731.] On the 8th instant I took a crate of sections off a hive, using a cone super-clearer, with very satisfactory results. The cone remained on the hive three hours during the afternoon, the weather being fine and sunny all the time. On removing the crate there were not more than six or seven bees left on the sections, which had been packed before. As I use excluder zinc above the frames, the awkward effects resulting from the queen being in the super are minimised.—R. CLAY, *Newcastle-on-Tyne*.

Queries and Replies.

[334.] *Cork-Dust for Winter Packing.—Forcing Hives for Clover Harvest.*—1. Would cork-dust do in lieu of chaff for winter covers? I mean, would it do to fill the bags with to put over the quilt? 2. Would it be advisable to put any insect-repellant in the cork-dust placed in the double walls, to prevent the cork from becoming the home of woodlice, &c.? 3. In our district the bees never seem to do much till the white clover begins, and then they seem able to gather almost any amount of honey, as the district is one of the best for white clover I ever saw. Within 500 yards of my house there are dozens of fields quite white with it at the present time, and mine is the only apiary within three miles. I have noticed that in yield of honey late hives, that is, those that are weak in April, gather as much honey, and are as strong when the honey season begins, as those that are then relatively much stronger; hence it has occurred to me that it is comparatively useless to stimulate in March and April, so as to get the hives crowded with bees in May, some time before there is a real flow of honey. Is this a sound opinion?—PEDAGOGUE, *Notts, July 16th*.

REPLY.—1. Cork-dust is superior to chaff for the purpose. 2. Anything likely to keep away obnoxious insects is useful, but we should not specially urge the need for it. 3. It is sound reasoning to say that there is less need for forcing on bees in early spring in order to prepare for a late harvest, such as clover. Six weeks is the orthodox time for building up a

stock, and if the bees will make themselves strong in time for clover without the forcing process, there is no need for adopting it.

[385.] *Re-queening Hives.*—1. I have no time this summer for rearing queens, and as I have several hives of bees which have been weak all this season, I am writing to ask if it will do to simply kill the queens and leave the bees to raise a fresh one in order to have these colonies strong and with a young queen for next year. Would this be the best time to do it? 2. Is there any way of getting bees to fill sections and seal the comb all round close to the wood? I use Howard's sections filled with full sheets of foundation, and they are often left with about the width of a cell all round between the wood and the comb; these sections do not look well, and do not contain as much weight as they ought to.—W. H. H., *Canterbury*.

REPLY.—1. So long as there are eggs and brood in all stages in the hives you need have no fear but new queens will be raised after the removal of the old ones. No time should be lost in taking the old queens away. Your only care afterwards will be to see that each young queen becomes fertilised. 2. The perfect filling of sections depends very much on the rapidity (or otherwise) with which the honey is coming in when they are being filled, and keeping the wood of the sections as warm as possible. Beyond giving full sheets of foundation you can do nothing to help them in this.

[386.] *Wild Bees.*—1. On opening an empty hive for a neighbour the other day, I found a sort of bee in occupation which had built some curious cells, seemingly of a kind of mud. There were only two or three bees apparently doing the work. I send specimens, and shall be glad if you will tell me what they are. 2. Also I send a specimen of a black bee with very bright brown fur (?) on the back. I never have seen one before, and shall be obliged to you for information. 3. Do you approve of placing a second hive *underneath* the original one? A huge swarm came out of an Italian stock of mine on Friday last, leaving a super of hanging frames, which was not half full—almost empty. I regret now that I did not place a super (?) *beneath* them.—H. S. H., *Taunton*.

REPLY.—1. The mud cells filled with pollen are those of the mason-bees, very common in some parts of the country. 2. It is one of the common humble-bees. 3. As a regular thing, no; though a super may be temporarily placed so in specially constructed hives for removal above after the bees begin working in them, but unless the bee-keeper is at hand at the right time to remove the super to its proper place at the top of the hive, it is best not to attempt operations of this kind. They are the 'finer points' of the pursuit; very advantageous in experienced hands, but—as with the operation known as 'spreading brood'—very apt to go wrong in those of the amateur bee-keeper. You should give the 'half-filled frames' to the 'huge swarm' to complete.

Echoes from the Hives.

Ticehurst, Sussex, July 10th.—The weather here just now is delightful, and there are acres of white clover for the bees to work upon, and the limes are rapidly coming into bloom. A fine swarm I bought on June 20th, putting them on nine frames, and a crate of twenty-one sections were all filled by to-day, and with the exception of a few outside ones were beautifully sealed over, so I have added another crate. Respectfully adding my thanks for the valuable information gained from the *B. B. J.*—A COTTAGER.

Kincardine Cottage, Arriemore, July 12th.—Bees are doing well for the last month, previous to then they had a hard struggle, weather being very cold and backward. I expect a few swarms from straw ruskies some of these days—fully two weeks behind former seasons.—A. CLARKE.

Gainsborough District, July 20th.—Honey has been coming in fairly well this month, although we had several thunderstorms and showers last week, with cold nights. Truant swarms are numerous this year. I have heard of six in this neighbourhood. The enclosed cutting from the *Gainsborough Times* is an example of what may be done by an ardent bee-keeper.—F. J. CRIBB.

A NOVEL USE FOR BICYCLES.—An enthusiastic apiarist, living at Kirton, mounted on a safety bicycle, followed a swarm of bees for two miles on Wednesday afternoon, and after safely hiving the wanderers, returned home with the skep containing the numerous living freight securely fastened to the frame of his machine.

Bee Shows to Come.

July 23rd, 24th.—Lincolnshire Agricultural Society at Brigg. Stephen Upton, Sec., St. Benedict's Square, Lincoln.

July 28th to 31st.—Highland and Agricultural Society at Stirling. Mr. T. D. Gibson-Carmichael, Melrose, N.B.

July 29th, 30th.—Leicestershire B.K.A., in connexion with the Leicestershire Agricultural Society, at Leicester. Entries (except for honey) close July 11th. Entries for honey may be made up to 22nd July. H. M. Riley, Tower House, Leicester.

August 5th, 6th, and 7th.—Yorkshire Agricultural Society at Bradford. Entries closed June 27th. Marshall Stephenson, Sec., York.

Sept. 5th.—Alderley Edge and District Branch of the Lancashire and Cheshire B.K.A. Chelford Flower Show, Astle, Chelford. Schedules, &c., T. D. Schofield, Alderley Edge, Cheshire.

Sept. 9th, 10th.—Derbyshire Bee-keepers' Association at Derby. Entries close August 27th. W. T. Atkins, Sec., 12 North Street, Derby.

N.B.—Exhibitors are particularly requested to follow the instructions given for 'Sending Honey to Shows' in the number of the *British Bee Journal* for 12th February, 1891.

EUCALYPTUS HONEY.

In a paper read before the Pharmaceutical Society of Great Britain, Professor T. P. Anderson Stuart, University of Sydney, N.S.W. speaking of Eucalyptus honey, says:—

The main facts about the honey are that two or three years ago it was reported that a honey had reached Paris from Sydney which was said to be gathered from eucalyptus-trees by the 'black bee of Australia.' Astounding statements were made regarding the productiveness of this bee, and of the properties of the honey. As much as 600 kilos. (about 13 cwt.) were said to be obtained from one hive (generally a hollow tree), and the reported arrival of 6000 to 7000 kilos. of the stuff at Marseilles from Sydney served to give some credence to the statement. But the peculiar thing was that Australians knew nothing about this honey, and several prominent Australasian pharmacists, amongst them Mr. Melhuish, pronounced the thing a fraud. Of course, there is plenty of honey produced in Australia, but it is ordinary honey, Professor Stuart explained, worth 3½d. per pound in first hands. He proceeded to tell the whole history of the honey, the object being to show that the statement that a honey containing 17 per cent. of eucalyptol and other active principles is a natural product is fallacious. There is no doubt that a substance of this character was introduced in France, and was the subject of a discussion before the Academy of Medicine there, M. Herisson, of the Chevrier Laboratory, reporting that it contained 611.6 of sugar (mostly levulose), 1.8 of ash, 215.6 of moisture, and 171 of active principles (eucalyptol, eucalyptum, cymol, colouring-matter, resin, &c.) in 1000, while its specific rotary power was 22°, and its density 1.440. Further, it was related in Christy's *Commercial Plants and Drugs* that the honey was discovered first in 1884 by a traveller named Guillemet while exploring Tasmania. The account given of the discovery sounds most mythical, and it will suffice to state that the traveller said he found his treasure in a tree 7 metres in diameter, which requires 14 natives to encircle it with arms spread out. Roughly, the tree must have been about 60 feet in circumference. It is not surprising, therefore, that the traveller carried away with him the whole hive of honey obtained from the hollow of this tree, and that the sweet load was between 3 and 4 tons in weight! Beside that man the modern Samsons would tremble for their reputation, and it is conceivable that such honey might be possessed of the properties which the Academy of Medicine endorsed—viz., that it is a specific for laryngeal, bronchial, pulmonary, cardiac, and scrofulous affections; an antifebrifuge in malaria and typhoid; a blenorrhagic, and a thing to rely on for catarrhs, especially when influenza happens to be fashionable.

But the curious thing is that the bee which Guillemet described (*Apis nigra mellifica*) is an insect with which Australian experts are unfamiliar; nevertheless, Professor Stuart sought

for one of the kind, and found that in addition to an imported bee, which is the chief honey-gatherer in Australasia, there is a tiny bee, a little smaller than a house-fly, and not unlike it, to judge from the specimens which were shown on Wednesday night. This is the *Trigona carbonaria* (Smith), and it does gather honey, a specimen of which was also shown. This honey is a little darker than golden syrup, and a little thicker than simple syrup, which never crystallises, although the French kind does. Professor Stuart had this examined chemically, and got several specimens, one from Mr. Maiden, of the Sydney Museum. The analysis of this by the Government analyst there will suffice to show what we are dealing with in this case. The sample reduced Fehling's solution readily; gave no precipitate with alcohol, barium chloride, and lead acetate; it fermented with yeast (a thing which the French honey did not); showed the presence of pollen-grains from the wattle (an acacia); gave evidence of the presence of a glucoside and other bitter principles, but gave not a trace of essential oil on distillation. Diligent inquiry was made all over the Australasian continent. Every nook appears, in fact, to have been explored, to find a honey such as the French people have exercised themselves about, but not a trace of it could be discovered; and Professor Stuart quoted authority after authority to show that Guillemet, the traveller, the big trees, the hives, and all the other tall things, have never been seen or heard of in Australia.

In addition to that he gave a good deal that was interesting about the native bee. It is dying off, a victim to the imported bee, which is bigger, harder, and has a sting—all the qualities, in fact, which make it the stronger species in the struggle for existence. The way in which the natives find out the hives of the tiny trigona is curious. They catch one, gum a bit of a flower to it, let it escape, and then run after it over all obstacles until they reach the tree where the wee guide alights. There the hive is, and a section of such a tree was shown. It was scarcely a foot in diameter, had the comb right in the centre, and could not have contained more than five pounds, far less the 10,000 pounds which the imaginative traveller would have us believe.

The ordinary white honey of Australia is gathered by the imported bee, and does not contain essential oil. 'How can it?' says Professor Stuart. Even if gathered from eucalyptus-flowers, which is questionable, they are not known to contain eucalyptol. This, and much more, was told in a very long paper; but what we report suffices to show that natural eucalyptus honey of Australia does not contain eucalyptol—the French article is an artificial mixture.

[At a time when the medicinal value of the Eucalyptus-tree, as well as the honey gathered from it, in cases of influenza is being discussed, the above paper will have especial interest for bee-keepers.—Eds.]

MAKING A SWARM CLUSTER AND STAY UPON A STAKE IN FRONT OF ITS HIVE.

Every bee-keeper knows of the disposition of bees to crawl upwards. To induce a queen to leave a cage, turn the opening up. Those who have watched the motions of a clipped queen in front of the hive from which a swarm has just issued, have probably noticed her disposition to crawl up a spear of grass, or anything of this nature that she can find. At the recent meeting of the Huron, Tuscola, and Sanilac Co. bee-keepers, a Mr. West told how it was possible to take advantage of this climbing disposition on the part of the queen, to induce a swarm with a clipped queen to cluster and remain upon a stake in front of the hive from which it had issued.

This discovery was the result of an accident, or, rather, of a lucky 'happen so.' In front of one of his hives a mullein had been allowed to form a stalk. Coming home one day he found a swarm from this hive clustered upon the mullein stalk. He at once reasoned that the queen, as she alighted in front of the hive, found and climbed the mullein stalk, and the swarm, upon its return, found and clustered about her. Taking a hint from this, he cleared away all rubbish from in front of all the hives, and a few inches in front of each hive he thrust into the ground a branch of an apple-tree. He used branches perhaps an inch in diameter and two feet long, with a few short twigs at the top. The twigs were cut off to a length of four or six inches. The branch was not planted in an upright position, but leaning away from the mouth of the hive. Then it was not in the way of the workers as they passed out and in the hive, while a swarm clustered at the top would be held so far from the entrance of the hive that there would be no danger of its being enticed back into the hive.

This plan proved a perfect success. He had practised it for three years, and one year had as many as sixty swarms, and it had *never failed*. It seemed to me that the queen might not always find the tree to climb, but would crawl off in some other direction, but he said not; that the stake was planted just about where she would naturally strike the ground when leaving the hive, and she *invariably* found and climbed the pole, and that the bees clustered about her and *remained*. As the queen could not take wing, and the bees would not desert her, it naturally followed that they would remain until removed by the bee-keeper.

If this plan only proves as successful as represented, it will be a great thing for the bee-keeper with a small apiary, who cannot always be present with his bees in the middle of the day.—From *American B. K. Review*?

BEEES SETTLING ON THE RIGHT MAN.

As Mr. F. C. Lewis, of Buckland Terrace, Yelverton, near Plymouth, was passing Horrabridge Board School on Saturday, July 4th, a

swarm of bees began to alight on his hat, and he at once placed it on the ground that the bees might quietly settle. Lewis, well known as a clever manipulator of bees, returned to Broad Parks for a hive, and easily secured the swarm, which will, no doubt, repay him for his skill and trouble.—*Communicated.*

TIMELY HELP.

Referring to 698 (p. 301) and our footnote appended thereto, 'F. K.' writes:—'I am very much obliged to you for so kindly inserting my letter in the *Bee Journal*, and very grateful for the most unexpected result. Mr. C. S. P., Ryde, Isle of Wight, has been so exceedingly kind and generous, and has supplied *two* poor men for me with most complete set of appliances. He knows this district, and thinks it a good one on account of the heather, &c., so we are very hopeful of success.'

THE BEES.

First bees in rocks their habitations sought,
Or in hollow trees their wondrous structures wrought,

Till man a more commodious mansion gave,
And called them from the woods and dreary cave.

Invited thus to neat and ready bowers,
They cull the choicest of the vernal flowers,
Survey the enamelled plain on rapid wing,
Range o'er the lawns, and rifle all the spring:
Succeeding blooms their arduous toils renew,
To steal the sweets and sip the nectar'd dew.

Ruled by a queen with all the pride of state,
A numerous guard around their monarch wait;
Some from the busy hive explore the way
In search of sweets amid the blooms of May;
Others the wax in various hues collect,
Part build the comb, and some the work inspect.
What skilful artist better knows to trace
Such cells complete within a given space?

The young, no sooner hatched, impatient try
Their unused wings in air, and boldly fly
O'er groves and meads, for fragrant treasures roam,

And instinct guides the little wanderers home.
Ah! leave them happy in their copious store;
A part they'll give, and why desire ye more?
In just return, the happy race reward,
From chilling winds the peaceful mansion guard;
Regale them, too, upon some smiling day,
Thy tender cares they amply will repay.

BRYAN FANSON BROMWICH, M.A., 1754.

Notices to Correspondents and Inquirers.

Letters or queries asking for addresses of manufacturers or correspondents, or where appliances can be purchased, or replies giving such information, can only be inserted as advertisements. The space devoted to letters, queries, and replies, is meant for the general good of bee-keepers, and not for advertisements. We wish our Correspondents to bear in mind that, as it is necessary for us to go to press in advance of the date of issue, queries cannot always be replied to in the issue immediately following the receipt of their communication.

A SUBSCRIBER (Carnarvon).—Queen sent is a young one, and has not been fertilised.

ROBERT DE B. SAUNDERSON.—*Preserving Sections.*—Sections of comb honey may be preserved from granulating by keeping them in a dry, warm place, and at a temperature of about 60° to 65° (70° is still better). Moreover, the honey should be ripe when stored away. Sealed honey in sections is sometimes thin and poor in quality, and this kind will usually sweat or 'weep,' as it is called, after a time, eventually becoming slightly fermented. The greasy or damp appearance of the capping indicates this condition. Some interesting particulars on the preservation of honey appeared in our monthly, the *Record*, for May, 1889.

JOHNSON (Castle Douglas).—1. Some honey will keep liquid for a long time, while in another year that gathered in the same district will granulate in a month or less. There are, of course, a variety of chemical reasons for this difference, which it would be impossible to explain here. 2. Straining honey means cutting the combs up, and allowing it to strain through some material of open texture into a vessel placed below. 3. No. 4. Bees one mile and a quarter from heather would travel to it no doubt, but could hardly be expected to gather so freely from it as if on the spot. We should, however, not advise incurring the trouble and expense of moving for all the difference it would make.

A COTTAGER (Ticehurst).—Comb contains chilled brood only, not foul brood.

J. B. (Keighley).—No one can gauge the age of adult queens except by their appearance, and then it is more or less guesswork. Queen sent is an adult and of the ordinary native variety.

JOHN WADDINGTON (St. Neots).—There is foul brood in comb sent, but only in a very few of the cells. The general appearance of the dead brood, however, gives the impression that the comb has been put through the extractor, and that the brood has got chilled in consequence.

THE VILLAGE BLACKSMITH.—The honey sent is largely from 'charlock,' or wild mustard, and it has the peculiar property of rapidly granulating. No. 2 is a better honey than No. 1, but both are good.

INQUISITOR (Manchester).—The bee sent is an immature queen. It is not uncommon to see such thrown out of hives after the issue of second swarms or casts.

T. CHARLTON (Chester-le-Street).—The 'Model Beehive' is simply the beginning of an ordinary wasp's nest. The queen wasp often chooses an empty hive in which to start operations, only to desert her work when the hive is opened for any purpose.

J. MORGAN (Pontypridd).—This also is a case of wasps nest-building in a hive, and the bees have actually used a portion of the paper-like material—of which the nest is made—among the wax-cells of their own combs.

C. REDSHAW.—Queen sent is old and nearly worn out; but few eggs remain in the ovaries.

BALDWIN'S

is the Oldest Establishment in the United Kingdom wholly devoted to Bees and manufacture of

Bee-keepers' supplies. His prices will compare most favourably with those of any other Maker, while for quality of material, suitability and workmanship, he has no rival.

'Why can he give better value for money than others?' Because he spends less in large 'puffing' advertisements, buys in the best markets for prompt cash, has no rent to pay, and personally conducts his own business.

For prices and full particulars of Goods see Baldwin's Bee-keepers' Instructor (and Illustrated Catalogue combined), which 'contains more practical and reliable hints than all the large, expensive books,' post free for 2d. stamps. Address **S. J. BALDWIN, The Apiary, Bromley, Kent.** N.B.—More than 500 Silver and Bronze Medals, First and other Prizes, and Testimonials innumerable.

BEST FOUNDATION for WIRED FRAMES, 2s. 3d. per lb. (about 9 Sheets). Best SUPER, 2s. 7d. per lb. Perfect SMOKER, 2s. 6d. FRAMES, 10d. per doz. SECTIONS, 2s. 6d. 100. METAL ENDS, 5d. doz. METAL DIVIDERS, 10d. doz. CATALOGUE FREE. Innumerable Testimonials received. **G. STOTHARD (1st Class Expert), Welwyn, Herts. WELWYN LUBRICATING GREASE for CARTS, 2s. 6d. per 28 lbs. 2489**

CHEAP WOOD FEEDERS,

HOLDING ONE POUND OF SYRUP.

Can be used for Fast or Slow supply.

4d. each, postage 3d. No. 88 in List.

Bright Foundation, 1/10 lb. Darker ditto, 1/3 lb.

EDEY & SON,

STEAM JOINERY WORKS, ST. NEOTS.

ON HIRE, BEE TENT.—For Terms apply to **A. J. BROWN, Hon. Sec., Bradley, Wotton-under-Edge, Gloucester. 238**

British Bee Journal and Bee-keepers' Record.

OFFICE :

17 KING WILLIAM STREET, STRAND, LONDON, W.C.

PURE CANE SUGARS.

For the accommodation of Bee-keepers, guaranteed Pure Cane Sugar will be supplied in large or small quantities through this office at the under-mentioned rates:—

CRYSTALLISED.

4. DEMERARA	} Neat bags, 14-lbs. 28-lbs. 56-lbs. Cwts.		
5. BARBADOS		Crystals 2/9	5/4 10/6 20/6
6. TRINIDAD			

REFINED CANE.

7. WHITE CRYSTALS (Small)	3/0	5/10	11/6	22/6
8. 9. (Medium and Large sizes, 1/- per Cwt. extra.)				
10. LUMP (Cut Loaf) ... Boxes,	3/3	6/3	12/3	23/6
11. LUMP DUST ...	3/0	6/0	11/9	22/9

All above guaranteed made from CANE SUGAR only, and free from BEET, CHEMICALS, etc., etc.

CARRIAGE PAID on Orders over 5/0 (or 28-lbs. Sugar) to London and Suburbs.

COUNTRY ORDERS, not less than 2-cwt. carriage paid at 1/0 per cwt. extra.

(Scotch and Irish orders, special arrangements.)

Cash to be sent with order, and purchasers will please observe that if samples are required or replies asked to inquiries, a stamped addressed envelope must be sent, as we cannot undertake cost of postage.

APIFUGE.

The Original and ONLY PERFECT Preventive against STINGING.

Quality Improved & Price Reduced.

In 1/- & 2/- Bottles; British postage 2d. extra. All orders must be accompanied by remittance.

Special Terms to the Trade.

One Correspondent says:—'I have used it on removing a particularly irascible colony into a clean hive, with perfect success.'

Another says:—'I have kept bees for thirty years and have lately purchased a bottle of this wonderful stuff, and cannot persuade my bees to sting me do what I will with them.'

DARCY GRIMSHAW, Horsforth, Leeds.

Invaluable to Travellers Abroad as an Insectifuge.



THE YORKSHIRE Bee-keepers' Supplies.

WILLIAM DIXON
5 Beckett St., LEEDS.

Hives, Extractors, Smokers, Feeders, Foundation, &c. Prizes awarded, Gold, Silver, and Bronze Medals. 226

PRIZES awarded at the ROYAL AGRICULTURAL SHOW, held at Doncaster:—

Second Prize for the Best Collection of Appliances.
Second Prize for the Best Observatory Hive, stocked with Bees.

First Prize for the Best Display of Honey.
Certificate for Swarming Arrangements, and other Prizes.

WOOD BEE FEEDERS.—Hold 2 lbs. Syrup, 6d. each, by post, 6d. extra; 5s. per dozen on rail. Address **J. M. BALMERA, East Parade, Alnwick. 2920**

THE HONEY BEE: Its Natural History, Anatomy, and Physiology.

By **T. W. COWAN, F.G.S., &c., &c.,**
Editor of the British Bee Journal.

Cloth gilt, price **2s. 6d.**; postage 2½d.

London: **HOULSTON & SONS, Paternoster Square**
ALL BOOKSELLERS; AND
British Bee Journal Office, Kings Langley, Herts
and 17 King William St., Strand, London, W.C.

BRITISH BEE-KEEPERS' PRACTICAL NOTE-BOOK,

With Rules for the General Management of Movable Comb Hives.

By **THOS. W. COWAN, F.G.S., &c.,**
Editor British Bee Journal.

Consists of a Series of Tables by means of which the Bee-keeper can keep a record of all his Observations and Operations. A Pocket-companion indispensable to the practical Bee-keeper.

Price **1s., postage 1d.**

Bee Journal Office, Kings Langley, Herts; and 17 King William Street, Strand, W.C.

THE
British Bee Journal,
BEE-KEEPERS' RECORD AND ADVISER.

No. 475. Vol. XIX. N.S. 83.]

JULY 30, 1891.

[*Published Weekly.*]

Editorial, Notices, &c.

BEEES AND FRUIT-GROWING FOR FARMERS.

As a natural result of the long period of depression under which the farming industry of this country has laboured, efforts have been, and are being, made in various directions to discover some means of restoring to its former more satisfactory condition this important branch of the wealth-producing power of the country.

In considering the question, with the view of finding a remedy, the most casual observer cannot fail to be struck by the fact that large sums are paid yearly for foreign produce of various kinds which are quite capable of being grown or produced in our own country. Take one instance. We learn that last year no less a sum than three and a half millions sterling was paid for fruit imported into England 'from countries the soil and climate of which are no better suited for fruit-growing than those of Great Britain.' If farmers outside these shores can grow fruit, and sell it here at a profit after paying cost of transit and 'handling' by the broker, surely there is something wrong in the methods of the farmer here, beyond the higher rental made so much of, to account for so anomalous a condition of things.

That there are valid reasons for seeking a remedy is seen in the fact that the Fruiterers' Company, of which Sir James Whitehead is chairman, are taking active steps in directing public attention to the subject. A meeting was recently held in London, at the Mansion House, under the auspices of the Company, the Minister of Agriculture being the chief speaker. Mr. Chaplin, in the course of his remarks, showed that he was fully alive to the need for the farmer making some deviation from the old and well-worn track, if he is to keep

pace with foreign competition. Once granted that the British farmer has no chance with the rival who grows corn by the square mile, and who, to use the familiar metaphor, has but to 'scratch the soil and drop in the seed;' or with the ranchman, who raises cattle by the thousand with almost free feeding, he must cast about him for 'new lines' of business until such time as the 'virgin' soil of the colonies in the ordinary process of nature refuses to yield further crops without the cost of tillage and manuring, so necessary here. If he is cut off from the profitable production of corn and beef, he must turn his attention to smaller things, and statistics go to prove that if only a small moiety of the money paid for imported fruit, dairy produce, eggs, poultry, and, may we add, honey, was kept in the country, and spent on home-grown produce, the farming industry would be in a very different position to-day.

But our interest as bee-keepers is not directly with the nineteen millions spent on dairy produce, or the enormous amount for eggs and poultry from abroad, but with the large sums yearly paid for imported fruit and honey into the United Kingdom. Here the fruit-grower and the honey-producer are completely in accord, and it is obvious that the interest of the one is directly that of the other. Now, when an important member of the Government takes sufficient interest in the subject to look up statistics and prepare a—no doubt—well thought-out address to those concerned, we may well hope that ere long bee-keeping will receive more attention at the hands of small farmers than it does at present. We know the latter class, as a rule, do not succeed very well in their bee-keeping, but it is not difficult to tell the reason why, and we may confidently look for a different result if the assistance rendered to the spread of technical education in bee keeping by a few County Councils is extended to all the Bee Associations in the kingdom.

The President of the Board of Agriculture emphasises the fact that 'a good deal of land on which it does not pay to grow wheat might be converted into small holdings for the production of fruit,' &c.; but he acknowledges that 'to bring home the advantages of fruit-farming to the rural population, machinery would be required, involving a considerable outlay. Horticultural education will be necessary. But the cost of this must be defrayed by the County Councils, to whom, and not to the Agricultural Department, the requisite funds have been handed over.' The broad fact being admitted that, in order to make fruit-growing pay, those who follow the pursuit must proceed on intelligent lines and qualify themselves by seeking instruction as to the best methods, we may say exactly the same of bee-keeping, and the man who goes in for growing fruit in this way will be quite sure to include bee-keeping as part of his 'technical education,' because of the inseparable connexion between the two.

In view, therefore, of the encouraging success some few Bee Associations have had in their applications to County Councils, we trust that no effort will be spared to secure the grant for all. The present is an opportune time for making a move in the matter, and the publicly expressed views of the Minister of Agriculture will tend to give force to any application which may be made.

SAD LIGHTNING FATALITY AT A BEE-SHOW.

Just before going to press we learn from the London morning papers that a terrible fatality occurred at a Flower and Bee Show being held at Lacey Green, High Wycombe, Bucks, on the afternoon of the 27th inst., and while the Rev. Mr. Wallace, of Bromley, Kent, was delivering a lecture on 'Bee-keeping' in a tent near a tree. A man named Richardson was driving the bees from a skep, nine men being gathered under the tree watching the operation, when a thunder-storm commenced. A flash of lightning was seen to strike the tree, and the people around were horrified to see all the men lying huddled together. It was found that three were dead; three, including the Rev. Mr. Wallace, badly injured; and the three others very much dazed by the shock, though they afterwards recovered.

HANTS AND ISLE OF WIGHT B.K.A.

The annual county show of the above Association was held, in connexion with that of the Royal Counties' Agricultural Society, at Portsmouth on July 15th to 18th. Favoured with beautiful weather, the attendance was exceptionally good, the bee department being largely patronised.

The Association had arranged an interesting exhibition of bee-appliances, besides showing, by means of observatory hives, how bees worked at home. There was also a large display of honey and wax, &c., and close by was a bee-driving tent, in which the manipulation of living bees was explained in a practical manner. Lectures on bee-keeping were frequently given. Messrs. E. H. Bellairs and S. J. Baldwin were the judges. The entries were very numerous in the honey classes, and the samples sent in were so even that the judges had some difficulty in deciding. Altogether this was the best show yet held.

On the afternoon of Thursday the Duke and Duchess of Connaught visited the show. After witnessing the horse-jumping and a parade of the prize horses and cattle in the horse-ring from the royal box, they were driven in their carriage to the working dairy, the sheep-pens, and then to the bee-exhibit, where Mr. J. J. Candey, on behalf of the Committee, presented their Royal Highnesses with sections from the exhibit of Mr. W. Woodley, World's End, Newbury, which had won the champion prize open to the United Kingdom, and invited them to alight and hear a lecture on bees in the driving-tent. The Duke and Duchess with their three children and their suite having entered the tent, listened evidently with great interest to Mr. Baldwin's racy description of a bar-frame hive, which he manipulated before them, questions being asked by the Duke and Duchess, and by Mr. Charles Simmons, the courteous Secretary of the Royal Counties' Agricultural Society, the answers to some causing great amusement to the royal party, more especially those relating to the queen-bee, royal jelly, and the queen only stinging a rival.

The Duke, on his leaving the tent, heartily shook hands with Mr. J. J. Candey, who was acting as Hon. Show Secretary, and thanked him and Mr. Baldwin for the interesting lecture and the information given them.

LIST OF AWARDS.

Class 1. Champion prize for the best twelve pounds of super honey.—1st, W. Woodley; 2nd, A. Housam; 3rd, Dr. B. J. Guillemard.

Class 2. Best twelve pounds of extracted honey.—1st, H. W. Seymour; 2nd, W. Woodley; equal 2nd, F. Mower.

Class 3. Best ornamental design in honey-comb.—No competition.

Class 4. Best home-made hive.—James Hixon.

Class 5. Best wasp's nest.—1st, W. Woodley; 2nd, F. Mower.

Class 6. Hives, bees, appliances, wax.—No competition. For sale only.

Class 7. Any invention in regard to beehives or furniture.—No competition.

Class 8. Best twelve pounds of super honey.—1st, Miss Medlicott; 2nd, Dr. B. J. Guille-mard.

Class 9. Ditto for cottagers and artisans.—1st, W. Hedgecock; 2nd, E. Ainsley; 3rd, T. Giles.

Class 10. Best six pounds of super honey.—1st, Rev. A. Headley; 2nd, H. Rowell; 3rd, W. J. Green.

Class 11. Ditto for cottagers and artisans.—1st, J. Hixon; 2nd, W. Hedgecock; 3rd, T. Giles.

Class 12. Best six pounds of granulated honey.—1st, T. Giles; 2nd, J. Hixon; 3rd, W. J. Green.

Class 13. Best twelve pounds of extracted honey.—1st, Mrs. Candey; 2nd, J. Hixon; 3rd, T. Giles.

Class 14. Ditto for cottagers and artisans.—1st, W. Hedgecock; 2nd, T. Giles; 3rd, J. Hixon.

Class 15. Best sample of beeswax.—1st, G. King; 2nd, Mrs. N. Hole.

Classes 1 to 7 were open to the United Kingdom, while 8 to 15 were for the county of Hants only.

NOTTINGHAMSHIRE B.K. ASSOCIATION.

This flourishing Association held its annual county show in connexion with the Notts Agricultural Society, in Wollaton Park, on Wednesday and Thursday, July 15th and 16th. The weather was everything that could be desired, and there was a very large attendance, the bee and honey tent coming in for a large share of attention, while the bee-driving contests created a considerable amount of interest.

Class 1, *for collections of hives and appliances* (three entries).—Only two exhibitors put in an appearance, but both made an excellent show, Mr. Walton's collection being especially good, nearly every article required in modern bee-keeping being shown, and all proving the exhibitor to be fully competent to keep up the reputation he has already acquired. 1st prize, E. C. Walton, Muskham, Newark; 2nd, R. W. Pett, Greyfriars Gate, Nottingham.

Class 2, *for the most complete and inexpensive hive for cottagers' use* (five entries).—All the hives exhibited in this class were of sterling value, and the judges had some difficulty in awarding prizes, which were given as follows: 1st prize, C. Redshaw, South Wigston; 2nd, E. C. Walton; 3rd, R. W. Pett.

Class 3, *for best specimen of bees in observatory hive* (nine entries).—This class provoked a keen competition, and was a source of much interest to the visitors. Mr. Walton had an easy first with the hive he exhibited at the 'Royal' show at Doncaster. The second prize was awarded to Mr. Pett for a hive of his own con-

struction, containing two frames, and worked on the principle of a toilet looking-glass, enabling the spectator to turn the frames in the best position for getting full advantage of the light. 1st prize, E. C. Walton; 2nd, R. W. Pett; 3rd, C. Clarke, Loscoe Grange, Codnor; 4th, C. Wootton, Draycott, Derby; highly commended, J. Clarke, Loscoe Grange, Codnor.

Class 4, *best twelve bottles of extracted honey*.—Out of twenty-two entries in this class only fourteen exhibits were staged, owing to the backward season. These were, however, nearly all of exceptionally good colour and flavour, and were only in a few cases rather devoid of consistency. Mr. Wilson, who takes the silver medal in this class, was also the winner of this much-coveted prize last year. 1st prize, J. Wilson, Langford, Newark; 2nd, E. C. Walton; 3rd, Viscount St. Vincent, Norton Disney, Newark; 4th, F. C. Piggin, Hucknall Torkard; 5th, F. H. K. Fisher, Farnsfield, Southwell.

Class 5, *best twelve sections*.—The exceptionally backward weather experienced in Notts was especially shown in this class, for although seventeen entries had been made, only four exhibits were staged, each taking a prize. The first prize—which, with other first prizes, had been given by the President of the Association—was won, together with the bronze medal, by his own sections, much to the satisfaction of the members. He, however, further demonstrated his liberality and good wishes for the cause of bee-keeping by informing the Secretary that the money he won in this and other classes was to be retained towards paying the incidental expenses of the show. 1st prize, Viscount St. Vincent; 2nd, W. Measures, Upton, Southwell; 3rd, E. C. Walton; 4th, R. W. Pett.

Class 6, *for best six bottles of granulated honey*.—Only two exhibitors entered honey in this class, and as neither were good, the first prize was withheld; 2nd, F. C. Piggin.

Class 7.—No entries.

Class 8, *for best sample of beeswax* (seven entries).—The President scored another first in this class with a very superior exhibit. 1st, Viscount St. Vincent; 2nd, J. Wilson; 3rd, H. J. Raven, West Bridgeford, Nottingham.

Class 9, *bee-driving*.—Seven competitors entered for this class, and great interest was taken in it by the public. 1st, G. H. Merrick, Hucknall Torkard; 2nd, A. G. Pugh, Beeston, Nottingham; 3rd, F. C. Piggin; 4th, J. B. White, New Eastwood.

Special class, *for best six pounds of honey produced within four miles of Nottingham market-place*.—This being a new class did not meet with the patronage it is hoped it will do another year. 1st prize, A. G. Pugh; 2nd, — Beecroft, Wilford, Nottingham.

Altogether, the show of 1891 may be considered a very successful one, the only drawback being that the fine weather caused several members who would have been present as competitors to stay at home in the hayfields.

[An esteemed Notts correspondent sends us the above report.—Eds.]

DEVELOPMENT IN THE HONEY-BEE.

By R. A. H. GRIMSHAW.

(Continued from page 267.)

Whether the honey-bees of the genus *Apis*, which are found abundantly in countries east, south, and west of the Mediterranean centre, have originated in, and radiated from, the species known as *A. mellifica*, it is beyond me to speculate upon; but I may not be too presumptuous in offering the suggestion that all bees having similar fundamental structure to our own (such as recesses on the legs for pollen, &c., a honey-sac with a regurgitative apparatus, jointed antennæ, the slit tube and terminal spoon of a nectar-gathering mechanism), are throughout all the ages advancing from, or receding upon, their types in all their respective habitats, and are developing or retrograding, century by century, according to the suitability or otherwise of their surrounding conditions. There is nothing unreasonable in this hypothesis when we find the stings, tongues, and markings so varied in the true honey-bees coming under our individual notice at the present day, and when we reflect that strange structural modifications are evident to any one who will even superficially contemplate other members of the insect world. For examples of these I will merely name the wing-cases of certain species of beetles, fastened together at their edges (and thus rendering useless the beautifully perfect wings they encase), and the balancers of diptera, which appear to be merely degenerated or degraded posterior wings of a previously four-winged insect. We see it all through the living world—species are gradually leaving us, their places being filled in the economy of nature by others more suited and adapted to the work they have to perform in the harmonious chorus of life. Before our eyes we see the red man of North America, and his indispensable food and clothing-yielding buffalo; the elephant, the ostrich, the seal (whether by the hand of civilisation or not matters not, the fact is there); to say nothing of the Hottentot, the aboriginal man of Australia and New Zealand, whole races of men and whole species of animals in South America *disappearing* from the life-chart—others taking their places, no blank space of food-yielding earth being left tenantless. If this occurs before us, in our own paltry day, in chronological record, the inference is that it was and will be so. That it was so is more than substantiated by the readings from the rocks.

We left, then, our honey-bee on sun-warmed slopes of hillsides, in a pastorally perfect home, where, from the same hive, the spring flowers of the valley are followed by the spring blooms of the hills, the fruit-blooms of the orchards and woods succeed these, and are in turn succeeded by meadow flowers yielding an abundance of nectar, whilst autumn work is filled up by the ever-welcome stretches of ling-bloom, giving the bee what honey-eating man has learnt to consider the choicest return the bee can make him. In such a locality, even at the

end of the nineteenth century, the *fin de siècle* bee-keeper houses his bees in domiciles little, if at all, removed from those used centuries ago. He merely gives them a dome-shaped hive of straw, takes his honey and his swarms precisely in the way of his forefathers, and will (as many can testify who have conversed with him at our bee-shows) even contend that his way is still the best, and that modern 'new-fangled' notions are no good. A new light, however, has dawned upon agriculture. The farmer, with characteristic shrewdness, perceives that in the mechanical sowing of seeds, the hoeing and ploughing of the earth, the mowing and reaping of crops, much labour is saved, and the work is done in a cleaner, more expeditious manner. The nett results, too, of scientific farming are so much greater; he is becoming well convinced that, proceeding on the old lines, he would not be able to compete with his more advanced neighbours. So, in modern bee-keeping, there has in the market arisen a class of men who will deign to examine all the latest devices and appliances of the scientific bee-keeper with as much intentness and earnest desire for information as they would bestow on a new churn or mechanical milker.

Quite as rapid strides have been made in our time in bee-keeping as in medicine, mechanism, chemistry, or electricity. The old-fashioned bee-keeper is brought face to face with the fact that he may multiply his stocks *ad infinitum*, and force them to swarm directly into the hive he has prepared for their reception. He may also open his hives and examine the condition of his honey-getters without fear. He may place his shallow-frame supers, or boxes of sections, on his hives, from which, when filled, he can make the bees clear themselves, and after this the honey may be extracted, or the combs removed, without the destruction of even a single bee. The honey is immaculately pure and clear, as opposed to his old-style honey drained as 'virgin' with great waste of comb, or strained and squeezed from other old and foul brood-combs, the result of an atrocious waste of bee-life in the sulphur-pit. Truly, whether or not there has been any development in the honey-bee, our industry has marvellously advanced within the memory of man, and judging from the past twenty years one has every reason to hold the opinion that in a decade or two bee-keeping will be as common as poultry-keeping. In the suburbs of every large town, and in every country town and village, our local authorities will have taught the people cheap, simple, and effective methods of bee-keeping, and this will probably be accompanied by increased devotion of land to purposes of pasture and cattle-rearing; so that if, according to Darwin, there be a logical descent from old maids to clover by way of cats, mice, and wild bees, there may some day be a similar sequence directly connecting the honey-bee with British beef and mutton by way of the clover-fields of the future cultivated in the place of the almost unremunerative acres now devoted to the raising of cereals.

(To be continued.)

CHECKING FOUL BROOD.

With the view of placing within reach of bee-keepers a cheap and ready means of checking the spread of foul brood, we propose to supply County Associations and others with naphthaline, for bee-keepers' use, at a price which will admit of its being extensively used wherever the disease is known to exist.

That some special effort is necessary in order to grapple with an admitted evil no one will deny, and if the executive of Bee Associations, with their many officials—such as local and district hon. secretaries, experts, &c., besides the large body of active members who periodically visit the apiaries of brother bee-keepers in a friendly way—will cordially enter into the scheme, the distribution of so powerful a disinfectant by the hundredweight in every county must have an enormous influence for good on the well-doing of the bees located therein, and tend to remove what may become a serious stumbling-block in the progress of apiculture.

We have for some time past been seriously impressed by the sad plight in which not a few bee-keepers find themselves when their bees are suddenly discovered to be foul-broody. Not a mild attack in a single hive, but several colonies, supposed to have been perfectly free from disease, are found badly stricken, and then comes the inevitable query, 'What must I do to cure it?' How easy to ask 'What?' but, alas! how difficult to supply the recipe and the *modus operandi*, and heads and hands to ensure its being carried out rightly!

The methods, habits, temperament, and the natural aptitude of bee-keepers for effecting a cure of foul brood are as wide as the poles apart. Indeed, the very surroundings and position of our correspondents are as distinct and different as can be, and we have but their letters to guide us in giving instructions, not seldom hopelessly deviated from in carrying them out. In view of all these facts, we are more than ever impressed with the absolute necessity for readers to remember how much 'prevention is better than cure' when bees and foul brood are the subjects dealt with; and the project now put forth has for its object, first, to force this truth home: and, second, to give it practical shape, by placing within reach a powerful lever by which it may be applied.

For some time past the use of naphthaline has been recommended in our columns

as being a preventive easily applied, and not liable to cause mischief in using in the hands of the ordinary bee-keeper. But even here the 'variableness' in *price*, in *strength*, and in the purity or otherwise of the article, as sold by chemists and others, rendered it liable to go wrong in all sorts of ways, as some know to their cost. To remedy this state of things we have been at some trouble in ascertaining where the right article could be had, and though our arrangements are not yet quite completed, we shall shortly be in a position to supply, through the office of the *Bee Journal* and *Record*, naphthaline in sticks, which may be easily broken into convenient pieces and carried in the pocket. The cost by the hundredweight or half-hundredweight will be less than threepence per pound, and we shall be able to supply a large packet, quite enough for any single apiary, post free for sixpence.

Now, in order to remove some uncertainty which apparently exists, we emphasise the fact that this same *naphthaline* must not for a moment be confounded with *Naphthol Beta*; the latter being a remedy specially for internal use in bee-food, for curing foul brood, while naphthaline is a disinfectant, or preventive against the disease spreading. If foul brood is present in a hive, both remedy and preventive should be employed, but we are now dealing specially with naphthaline as sent out from this office, and the benefit which will arise from its free use about bees and beehives. It is perfectly innocuous, and will not injure the honey or bees if used while supers are on; it may be reduced to powder for blowing in at the entrances in small quantities, or broken into small pieces for dropping down between the frames; it has an odour not at all unpleasant and very wholesome; in fact, if used anywhere and everywhere about the apiary a great deal will be done towards checking the spread of that bane of bee-keeping known as foul brood.

We are now making arrangements for supplying naphthaline at the abovementioned cheap rates in large or small quantities. Meantime we commend the action of the hon. treasurer of one well-known Association where foul brood is causing trouble, who has made a beginning by presenting a hundredweight of the naphthaline to his Association for dispersion throughout the county.

Correspondence.

The Editors do not hold themselves responsible for the opinions expressed by correspondents. No notice will be taken of anonymous communications, and correspondents are requested to write on one side of the paper only, and give their real names and addresses, not necessarily for publication, but as a guarantee of good faith. Illustrations should be drawn on separate pieces of paper.

Communications relating to the literary department, reports of Associations, Shows, Meetings, Echoes, Queries, Books for Review, &c., must be addressed only to 'The Editors of the "British Bee Journal," 17 King William Street, Strand, London, W.C.' All business communications relating to Advertisements, &c., must be addressed to Mr. J. HUCKLE, Kings Langley, Herts (see 1st page of Advertisements).

* * * In order to facilitate reference, Correspondents, when speaking of any letter or query previously inserted, will oblige by mentioning the number of the letter, as well as the page on which it appears.

FOREIGN HONEY.

[732.] I am sending you a sample of honey sold as 'Pure Californian Honey,' which I obtained from a large firm of grocers, sugar-boilers, &c., in Sheffield. I had called to ask if I might send them some English honey. I was informed that English honey, as a rule, was sold only by druggists. On ascertaining, however, that they bought honey very largely, *i.e.*, by the half or three-quarter ton, I asked to see a sample. They showed me some Narbonne honey in jars, candied, at 10½*d.* per pound jar. This appeared to be very good. I was then shown the honey of which I send you a sample, which had not candied during the winter. This was labelled by them as guaranteed pure Californian honey, and sold at 10*d.* per glass jar of one pound. On my expressing my surprise at it not having candied, and suggesting a possibility of its not being altogether the product of the bee, I was assured that every consignment was sampled and sent to the borough analyst, who had certified this to be pure honey. Moreover, I was told they recognised it as pure honey in its action when used for the manufacture of sweets. Inferior honey burned in the pan, this did not. They were aware of the properties of glucose, which they used, as allowed by law, in the manufacture of jam. It (glucose) could be added only at the last moment before removing from the source of heat; this honey could be heated from the commencement.

This Californian honey is not of as great consistency as honey taken from sealed combs out of my own hives, and is, I think, much wanting in aroma. It gives no precipitate or very perceptible turbidity with barium chloride—not more than does virgin honey and not near as much as do most hard waters. Hence, according to the papers you published last December, we may conclude that there is not present potato or wheat-flour glucose. The plane of polarised light passed through it is almost the same, if not identical with that of pure honey, and quite different and opposite in direction from that passed through cane-sugar syrup. We may suppose, therefore, that there is no added dextrose or crystallisable sugar. There is no sign of starch when tested with iodine. This

is, therefore, *as far as I can tell*, pure honey; yet I must say that I should not think it a very difficult thing for any one to manufacture a mixture of sugar and true honey with as much aroma of honey as the sample I send bears, and which would stand all the tests I have named. However, I have no reason for thinking that the sample is other than pure honey.

The fact of this honey not candying is a recommendation to the public, and I believe to some manufacturers who use honey. Candied honey is looked upon as largely adulterated with sugar. I think that we ought all—especially, I think, the members and officers of the B.K.A. ought—to endeavour to overcome this prejudice by writing to the daily papers, periodicals, and especially such trade papers as are taken by grocers, confectioners, &c., to represent the true facts. The price paid for such foreign honey must be one that would pay a British bee-keeper in a good season, and I quite think that if we could supply an equally pure honey, and one which we could convince the tradesman had a very much superior aroma, was of greater specific gravity, and candied because it was the nature of honey to do so unless it had been first heated and half spoiled, that we could get a remunerative price for our honey.

I was much surprised to find the manager of such a large firm considering English honey merely as a drug to be supplied by apothecaries, and yet buying honey by the ton. It is a proof of how much has still to be done by the promoters of the bee-keeping industry.

The manager told me that they had bought some English honey two years ago, but could not sell it, and had had to use it themselves. I remember to have seen this honey. It was in sections, not well cleansed from propolis, &c., not well finished, damaged by travelling, badly displayed, without section boxes, &c., and not inviting to look at. This was their only experience of English honey. The manager was not aware that English bee-keepers could supply honey in the bulk and by the hundred-weight.

I should be glad to have your opinion of the Californian honey. Can you give any particulars as to its collection, importation, &c.?

Upon a more careful examination I find that the plane of polarisation of the Californian honey is *more left-handed* than that of fresh honey, thus showing more *levulose* or uncrystallisable sugar present. No doubt this comes from the *inversion* of a portion of its *dextrose* in heating to remove wax, &c., and this fact will account for its not candying.

I am inclined to think that electricity can be made to invert sugar. If so, artificial honey, flavoured with heather honey, will be, I think, undetectable. Indeed, it will be true honey, chemically, physically, sensibly, and no doubt physiologically in its functions and properties.—W. J. SMITH, *Sheffield*.

[The firm referred to must be lamentably ignorant of the British honey trade. We must

also differ from their deductions generally on the subject of honey. As to being able to test the purity or otherwise of the product by its action when being made into sweets, we consider any assertion of the kind to be absurd. The sample sent is precisely similar in appearance to honeys from the same continent which were proved some years ago to be largely adulterated, and we take leave to doubt very much the purity of the sample. Pure honey always carries with it an aroma of some kind—this has none. Moreover, pure honey, unless kept at a high temperature, will certainly candy and become solid. We may have something further to say of the sample later on.—Eds.]

A LADY'S BEE-KEEPING.

[733.] The *Journal* has been such a great help and pleasure to me during the year and a half I have read it that I feel it is time to report to the Editors how much I appreciate the hints and instructions, and how well my bees have done. I hope that others will be encouraged by reading my report.

Last year I tried to prevent swarming by giving ample room ahead of the bees' requirements, and by placing two or three frames with starters only in front of the brood chamber. Nearly all the hives were doubled—I mean, had a body-box of twelve standard frames or less on top of the other. Some had a large crate of sections besides.

The total yield of honey from the ten stocks was 252 pounds of run honey and 160 sections. The honey was of splendid quality, and four distinct kinds: in May, from fruit-blossom, it had a canary tint; in June, from clover, it was pure white; from limes in July it was considerably darker, and of inferior quality; and in August it was very dark and rich, from heather and blackberry I thought.

This is a splendid district for flowering trees when the season is good.

Last winter four of my stocks died, so this year I started with seven, and have tried to increase them. The hives now number twelve, counting a swarm I bought. Already they have yielded about 300 pounds of honey.

Natural swarms are the best I think, so I allowed them to swarm as they chose, except that when the first or second cast came off I cut the queen-cells out of the old hive and returned the casts. But the queen-cells were very troublesome. When the hive was opened the bees were thrown into a state of excitement and disorder, so failed to guard the queen-cells, for I found that those in the hive were allowed to hatch while I was cutting out a row from a frame, and that row hatched while I was looking at the rest of the hive: so the queens flew about and got lost; but I managed to secure three good ones in my nucleus hive, which have since proved useful.

What plan do you advise to prevent after-swarms? [Returning the second swarm next morning without removing any queen-cells.—Eds.] All mine are Cowan hives except two

which are in a bee-house, and one which was made by Baldwin.

I weigh the standard frames of honey before extracting, then count the number of frames and deduct half a pound for each from the total honey yield, because half a pound is about the weight of a frame of empty comb.

This season the bees got nothing from fruit-blossom as the weather was wet and cold here, and the bees were weak owing to the bitterly cold weather in March.—ETHEL TRESIDDER, *Croydon*.

SEPARATING QUEEN FROM BROOD.

[734.] With reference to query 369 (page 293 of *B. J.* for 25th of June) and reply thereto, on the 24th of June I performed the following operation:—A friend had a skep which she wanted to transfer to a bar-framed hive without losing the brood in skep. I therefore drove the bees into an empty skep. I then made the parent skep fast to a floor-board having a hole 4 x 6 inches in centre covered with queen-excluder. I now carried parent skep and floor-board to original position and inverted the skep. I placed a nucleus hive on top of the floor-board, and then threw the bees I had driven into the nucleus hive. The latter had five frames, four of foundation and one of old comb. I covered up warmly and left them. On the following day I saw the query No. 369, but was unable to investigate the results of my work for a couple of days, when I found the bees had drawn out the foundation fairly well, and had commenced to put honey in. On the 8th of July I found all the combs drawn out and full, so that I transferred the bees to a proper hive and gave more foundation. As soon as I return to Waterford I propose taking the skeps away. I expect to find the bees have taken all the honey out, and that all the brood has hatched out.—H. H. H., *Waterford, July 18th, 1891*.

[Our correspondent in the above letter deals with different conditions to those referred to in No. 369, and in no way impugns the correctness of our reply thereto.—Eds.]

NIL DESPERANDUM.

[735.] In the autumn of last year my apiary numbered eleven hives. In consequence of lack of stores several were united to others better off, and we hoped to save them; but the early spring was so cold that we were afraid to open the stocks to feed them, so consequently they all perished but two. These appeared by no means strong, but we fed them, and the result was that we have already taken forty-two pounds from each of the hives with the promise of twenty-one pounds more apiece, making a total, we hope, of 126 one-pound sections.

The season has been by far the best we have ever had, and the white clover, which in a heavy soil is generally sparse, has been most abundant.

I may mention that the stocks in April were thoroughly overhauled, and that we put them in clean hives, Abbott's 'twin copyable,' the same kind as they were in before. In the process bunches of dead bees and mouldy ones were taken out. I used successfully a clearer of a very simple kind. The section supers were removed into an open shed, and an empty super, covered at the top with brown paper tacked on, with a cross-slit in the middle, was placed on them. They were placed on a floor-board, and a cone of perforated zinc was passed through the hole. The cone was tied to a small blanket, which was made to cover the top of the empty super, and so arranged as not to touch the bottom. Very quickly the bees escaped, and left the comb untouched and completely sealed.

I may add that in May two fresh bars with guides were inserted in front of each hive, and, later on, when the bees threatened to swarm, two more were added. One bar was parallel to the entrance. The result was my bees did not swarm, though others on the premises which were not so treated did, and have not done near so well. They are like mine, slightly crossed Ligurians.

I have endeavoured to be explicit in order that other readers of your valuable *Journal* may profit by my experience. It was from *B. B. J.* that I took the hint of using a clearer to sections. — O. B. T., *Shepton Mallet*.

Queries and Replies.

[387.] *Queens Failing to Mate, &c.*—For nearly two years I have taken the *B. J.* Being a lover of the busy bee, I am claiming the privilege of asking you a few questions about them. I had three lots of bees last autumn—two frame hives and one skep; the former stood the winter well, but the bees in skep died—from queenlessness, I think, there being a quantity of drones left behind. One of the stocks swarmed on June 13th, and the swarm is doing well. On June 24th a second swarm issued, settling on a tall tree. The man in charge in my absence failed to get them, but I think they returned to the parent hive, as the bees were excited next day. On July 9th the same stock was again excited, and on looking round I found a queen running about on the ground. I caught her, but she got away, and, on attempting to fly, fell to the ground. On catching her again, I noticed that her wings looked jagged and cut, like those of an old working bee. I put her in at the hive entrance, and all was again quiet. Next morning the bees were again excited, but before evening all became quiet again. 1. Do you think the queen was out on her wedding trip, but that, being unable to fly, she is not fertilised? July 21st I examined the hive, and found a quantity of bees, but no sign of eggs nor brood; they cover from ten to twelve frames. The supers I took off, as they had only just begun to draw out the foundation, and our honey harvest is

over at the end of this month. 2. Is it likely that the queen, though in the hive, is not laying at all? 3. Were I to give them a bar of brood from first swarm would they be likely to rear a queen while the crippled one is still there, or would she have to be removed? Although I work amongst the bees without veil or gloves, I (like your correspondent 696, page 300) find it difficult to discover the queen amongst such a strong lot. 4. An old-fashioned bee-keeper has promised me some bees if I like to drive them; do you advise me to put a driven lot of bees in with mine, or the bar of brood? 5. When driving bees from a skep into bar-frame, do you advise me to stand the bar-hive on top of skep-stand, and so let the bees fly to it, or should you say drive them into the empty skep and then put them into bar-frame? 6. How much sugar would it require to take them safely through the winter? I think you said last autumn that if fed fast with good syrup they would draw out foundation. 7. Is this so?—H. B., *Winchester*.

REPLY.—If the queen is quite unable to fly, your surmise is probably a correct one. 2. The queen, obeying her natural instinct, would no doubt again make an attempt to fly abroad for mating, and so be lost altogether. 3. Give a comb, with eggs and brood, and it will help you to decide if the queen is still there by observing if queen-cells are raised thereon, for the bees will make no attempt to rear a new queen if the other is still in the hive. 4. Don't accept driven bees unless you can be sure of their perfect healthiness. 5. Follow the last-named course. 6. To establish a lot of driven bees safely for winter about twenty-five pounds of syrup will be needed. 7. Only if there are bees enough to form a very strong lot.

[388.] *Utilising Driven Bees.*—Hearing that a cottager near me was intending to burn a hive of bees some time in August next, I got her consent to allow me to 'drive' her bees instead of her burning them. My object in so doing was, firstly, to try and induce my parishioners to give up the barbarous custom of burning their bees; and secondly, having got a 'flight' or truant swarm hived in a skep, weighing three pounds two ounces, I thought they would make a more satisfactory stock if I could add these doomed cousins to their household. Please, therefore, in the cause of apiculture, of your charity tell me, 1. Is it necessary to capture the queen of driven bees before joining the two lots, or may I leave their majesties to fight it out? 2. If I must capture the queen, how on earth am I to find her and put her in durance vile?—MELISSOSOOS.

REPLY.—1. It is less necessary to capture the queen than it is to drive both lots of bees and mix them well up together in the operation of 'uniting.' If one queen is known to be better than the other, some care may be taken in ensuring her as the future mother of the hive, but not otherwise. 2. Queens can only be discovered among driven bees by their different appearance from that of the workers.

[389.] *A Novel 'Bee-Arrangement.'*—Will you kindly advise me in the following circumstances? During last spring I bought from a neighbour (whom I shall call 'A.') a skep containing what he believed to be a stock of bees on the condition that if this stock was unsatisfactory he would exchange it for two swarms. In the latter case his skep was to be returned to him. The 'stock' turned out to be *non est*, and before I had got a frame hive ready fitted with foundation a stray swarm was given to me by another neighbour, in whose garden it had settled. I lived this in A.'s skep, which contained comb and possibly a little honey. The swarm remained in the skep, and on the 15th inst. itself sent off a swarm, which settled in a garden near, but before I could hive them the bees returned and re-entered the skep. I can't say whether the queen returned too, or was lost. On the following day (a fine one) they did not attempt to swarm, and in the evening I lifted the skep off its floor-board, and placed it on a frame hive fitted with foundation, with excluder and quilt removed, in the hope that the swarm which had issued and returned the previous day would take to the frame hive below the skep, and so save me trouble. Of course they would have to pass through the latter to get in and out. I have arranged with A. that he is to have his skep returned *with bees, comb, and honey* in it—in the condition it would be left after a swarm had issued—the swarm belonging to me, and I now wish to know how best to carry this out.—J. HEATH, *Surrey, July 24th, 1891.*

REPLY.—If A.'s skep was *beeless* when sold to you as a stock of bees, on what ground can he expect you to return him the skep with bees and honey in it? Moreover, you have made an 'arrangement' somewhat difficult to carry out. You had better compromise the matter by allowing A. to have his skep in the autumn with all the honey it contains, while you keep the bees. This would be a very fair offer on your part, as nearly all the honey gathered this year will be in the skep, and the bees in the frame hive may require liberal feeding to make them safe for winter.

HONEY IMPORTS FOR 1890.

Owing to the retirement of the gentleman at the Statistical Office, the return of honey imports for 1890 ceased in May. To complete the returns for the year we have received the following:—

	cwts.	Value	£1774
June	1228	„	3304
July	1460	„	3981
August	2298	„	3868
September	2405	„	3196
October	1982	„	3793
November	2183	„	1747
December	814	„	

From a return published by the Statistical Office, H.M. Customs.

Echoes from the Hives.

Northampton, July 18th.—A few inquiries among the bee-keepers of Northampton have elicited the fact that since the 8th inst. honey has been coming in fast, and that the season will yield more than an average crop.—E. B.

New Ross, July 16th.—I have taken forty sections off four hives during the last week, and have found the Naphthol Beta and naphthaline very beneficial as a cure for foul brood. I am in hopes of getting rid of it by their use.—R. DE B. S.

Notices to Correspondents and Inquirers.

R. L. G. W. (California).—No such race of bees as you name is known to entomologists, nor do we know any one who has cultivated them. Until we have some trustworthy information the account you allude to provokes an incredulous smile. No doubt the old proverb 'A fool and his money are soon parted' still holds good, and it is quite possible some may be found gullible enough to believe the fabulous stories.

SPENCER L. ARNOTT (Newcastle-on-Tyne).—The queen has been deposed by the bees themselves, and the probability is a successor will have been raised in the hive. It will be well to examine the combs as soon as the sections are removed.

M. SOWREY (Gloucester).—The laths are only sold by the advertisers you refer to, and can still be had.

W. O. MILLER (Fakenham).—*Super-clearers.*—The cone-shaped super-clearer is described and illustrated in *B.J.* for August 28th, 1890 (p. 416), which will be forwarded on receipt of 1½d. in stamps.

RICHARD DUTTON (Witham, Essex).—The queen sent is a young one from the queen-cell given. The microscope will prove whether dead queens (if fresh when sent) are fertile or not by examination of the ovaries, but their age is judged more by their outward appearance.

APIFUGE.

The Original and ONLY PERFECT Preventive against STINGING.

Quality Improved & Price Reduced.

In 1/- & 2/- Bottles; British postage 2d. extra. All orders must be accompanied by remittance.

Special Terms to the Trade.

One Correspondent says:—'I have used it on removing a particularly irascible colony into a clean hive, with perfect success.'

Another says:—'I have kept bees for thirty years and have lately purchased a bottle of this wonderful stuff, and cannot persuade my bees to sting me do what I will with them.'

DARCY GRIMSHAW, Horsforth, Leeds.

Invaluable to Travellers Abroad as an Insectifuge.

BALDWIN'S

is the Oldest Establishment in the United Kingdom wholly devoted to Bees and manufacture of

Bee-keepers' supplies. His prices will compare most favourably with those of any other Maker, while for quality of material, suitability and workmanship, he has no rival.

'Why can he give better value for money than others?' Because he spends less in large 'puffing' advertisements, buys in the best markets for prompt cash, has no rent to pay, and personally conducts his own business.

For prices and full particulars of Goods see Baldwin's Bee-keepers' Instructor (and Illustrated Catalogue combined), which 'contains more practical and reliable hints than all the large, expensive books,' post free for 2d. stamps. Address **S. J. BALDWIN, The Apiary, Bromley, Kent.**

N.B.—More than 500 Silver and Bronze Medals, First and other Prizes, and Testimonials innumerable.

BEST FOUNDATION for WIRED FRAMES, 2s. 3d. per lb. (about 9 Sheets). Best SUPER, 2s. 7d. per lb. Perfect SMOKER, 2s. 6d. FRAMES, 10d. per doz. SECTIONS, 2s. 6d. 100. METAL ENDS, 5d. doz. METAL DIVIDERS, 10d. doz. CATALOGUE FREE. Innumerable Testimonials received. **G. STOTHARD (1st Class Expert), Welwyn, Herts. WELWYN LUBRICATING GREASE for CARTS, 2s. 6d. per 28 lbs. 2489**

CHEAP WOOD FEEDERS, HOLDING ONE POUND OF SYRUP.

Can be used for Fast or Slow supply.

4d. each, postage 3d. No. 88 in List.

Bright Foundation, 1/10 lb. Darker ditto, 1/3 lb.

EDEY & SON,

STEAM JOINERY WORKS, ST. NEOTS.

ON HIRE, BEE TENT.—For Terms apply to **A. J. BROWN, Hon. Sec., Bradley, Wotton-under-Edge, Gloucester. 238**

WOOD BEE FEEDERS.—Hold 2 lbs. Syrup, 6d. each, by post, 6d. extra; 5s. per dozen on rail. Address **J. M. BALMERA, East Parade, Alnwick. 2920**

FOUL BROOD.

FORMIC ACID.—Draper's 'B' brand, guaranteed pure. As used and recommended by Mr. Sproule in *Bee Journal*. Stopped bottles, 1 lb., 3s. 6d.; 4 lbs., 11s. 6d., post free. Address **EDMONDSON BROS., Bee Appliance Warehouse, 10 Dame Street, Dublin. 246**

JONES'S PATENT No 3928



Patent Hatherley Steps.

BEE-KEEPERS' SUPPLIES,

ALSO **POWLS' HOUSES, GATES, STEPS, EASELS, &c.** Catalogue Free.

EDWD. J. BURTT,

Bee Appliance MANUFACTURER, **GLoucester.**

Orders promptly executed.

2806

WILT'S

BEE-KEEPERS' ASSOCIATION.

THE COUNTY SHOW will be held **August 19th**, at the **SWINDON HORTICULTURAL FETE**, when the Medals and Certificates of the **B. B. K. A.**, and sundry Money Prizes will be competed for.

W. E. BURKITT, Hon. Sec., Buttermere Rectory, Hungerford.

Entries close August 14th.

SHROPSHIRE

Bee-keepers' Association.

The Annual Exhibition of Bees, Honey, Hives, and Appliances,

Will be held in

THE QUARRY, SHREWSBURY, in conjunction with the

HORTICULTURAL SOCIETY'S GREAT FETE, On Wednesday and Thursday, Aug. 19th & 20th. PRIZES to the Value of £35 will be awarded.

For Prize Lists, Entry Forms, and Information, apply to **T. WHITTINGHAM, Water Lane, Shrewsbury.**

Yorkshire Agricultural Society.

Patron: **H.R.H. THE PRINCE OF WALES, K.G.**

President: **LORD MASHAM.**

GREAT SHOW at BRADFORD,

WEDNESDAY, THURSDAY, and FRIDAY, August 5th, 6th, and 7th, 1891.

Magnificent Exhibition of Horses, Cattle, Sheep, Pigs, Implements, Shoeing-Smiths' Competitions, Butter, LIVES, Honey, and Dairying.

ADMISSION.

Wednesday, 9 a.m. to 6 p.m. Half-a-Crown.
6 p.m. to 8 p.m. One Shilling.
Thursday, 8 a.m. to 8 p.m. One Shilling.
Friday, 8 a.m. to 5 p.m. One Shilling.
Season Tickets, Half-a-Guinea each.

MARSHALL STEPHENSON, Secretary.

York, July 25th, 1891.

THE YORKSHIRE Bee-keepers' Supplies.

WILLIAM DIXON
5 Beckett St., LEEDS.

Hives, Extractors, Smokers, Feeders, Foundation, &c.
Prizes awarded, Gold, Silver, and Bronze Medals. 226

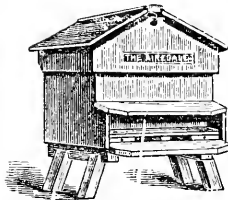

PRIZES awarded at the **ROYAL AGRICULTURAL SHOW,** held at Doncaster:—

Second Prize for the Best Collection of Appliances.

Second Prize for the Best Observatory Hive, stocked with Bees.

First Prize for the Best Display of Honey.

Certificate for Swarming Arrangements, and other Prizes.

THE
British Bee Journal,
BEE-KEEPERS' RECORD AND ADVISER.

No. 476. Vol. XIX. N.S. 84.]

AUGUST 6, 1891.

[*Published Weekly.*]

Editorial, Notices, &c.

USEFUL HINTS.

WEATHER.—Another break in the weather, and one which we fear will seriously diminish the chances of a good finish to the honey season. The last change has been more than usually disappointing, for there has been warmth and sunshine enough to make good working days for the bees, but the intermittent downpourings of rain which, as we write, are following each other at intervals of an hour or two, have spoiled everything—Bank-holiday included—and sadly reduced the amount of honey gathered during the last few days. In our last 'Hints'—written a fortnight ago—the unusual lateness of the white clover bloom was remarked upon, and yet it is to-day as fresh and full of bloom as ever. Moreover, it is not 'honeyless,' as was the case last year, for the bees still work on it very laboriously whenever a dry, warm day occurs. In little more than a week we shall know the best (or worst), and be able to calculate results pretty fairly; meantime, we must still wait and hope.

Farmers have had rather a bad time of it in Kent, and southern counties generally, a great portion of the grain crops being beaten down and damaged by the heavy rain-storms. In the north, also, there has, we learn, been far more rain than is good for either bee-keepers or farmers, but, of the two, the bee-keeper has the most reason to be satisfied, seeing that honey has been freely gathered when the weather was kind. Whatever is still in store for us, we think it is safe to assume that winter provision is ensured for the great majority of stocks, and the quantity of honey seen at recent shows clearly indicates that a fair amount of surplus has been secured, and with this we must be content.

REMOVING SURPLUS.—A careful watch

must be kept on surplus chambers with unsealed honey in them, for a few days of wet, combined with a low temperature, will often cause bees to begin carrying their stores down into the hive-bodies. To guard against this, every means should be taken to keep supers as warm as possible, and, where several racks of sections are on, all completed ones should be removed. The unfinished ones may then be sorted, placing those most nearly sealed over to the outside, and contracting the size of surplus chambers wherever it can conveniently be done. Sometimes all the unfinished sections may be got into a single crate after removing one or more full ones, and this crowding of the bees by reducing the space helps on the completion of the remaining sections very much. In the same way, where sections are worked in hanging frames, the number of frames may be reduced and the unfinished sections set in the centre by using two dummies, and covering the top bars to keep in the warmth. We have found the thin laths mentioned in our last 'Hints' very useful for laying on the top bars to keep in the bees when reducing space in this way, covering all with warm packing when the laths are in position.

ROBBING.—The time is now approaching when bees will begin to develop any robbing propensities they may possess, and a little judicious care may be well employed in adopting precautions to avoid a beginning of the mischief. When honey is being removed, bees so disposed are specially on the alert. Very much depends on the selection of a suitable day for taking honey. When work is brisk and there is forage abroad in the fields is the best time; but if we have not the choice of a suitable day, and the act of removing honey causes trouble through robber-bees, better desist altogether for the time being. Another day all may go on quite orderly, and no harm follow; but work of this kind is now rendered vastly more easy by the use of super-clearers. Previously

the great trouble was to rid surplus chambers of the bees; now they rid themselves of their stores, and these useful clearers will tend to do away with much of the autumn mischief formerly caused by 'robbing' when honey-taking time arrives. If the bee-keeper allows no honey to lie about, but bestows it safely indoors as soon as cleared of bees, no disturbance whatever in the apiary need follow.

PREVENTIVES AGAINST FOUL BROOD.—Most bee-keepers will, ere long, be removing surplus and examining brood chambers prior to beginning winter preparations. Many also—ourselves among the number—are located in districts where foul brood is known to exist. We can, in a great measure, prevent our own stocks from being robbed, but know not how to restrain our bees from robbing others. In view, therefore, of the risks which cannot be avoided under such circumstances, and hoping to keep free from infection, a piece of *naphthaline* will be dropped into every hive we have. Moreover, if the smallest trace of disease is found, the stock in which it appears will, in addition, be fed on syrup medicated with *Naphthol Beta*. We shall rely on the usual dose of salicylic acid in the food given to healthy stocks, but the preventive first named will be used all through; and, having so far secured immunity from the disease, spite of all our handling of 'specimens' of foul brood, we hope to still be able to keep it at a safe distance.

THE FATALITY AT A BEE-SHOW.

As we more than half anticipated, the details of the sad fatality at Lacey Green on the 27th ult., copied from a London morning paper, in our last issue, were altogether inaccurate. The facts were as follows:—

The bee-tent of the B. B. K. A. was sent down to the show in question, Mr. Baldwin, the well-known expert, being engaged to lecture and manipulate the bees therein. The tent had already been erected, and about three p.m. a skep of bees for driving purposes was brought on to the ground and placed in a convenient spot beneath a cherry-tree, a few yards away from the tent. Mr. Baldwin went forward to release the bees prior to using them in the course of his lecture; he lighted his smoker, and was in the act of stooping down to untie the hive from its floor-board, when there was a flash, and in an instant fourteen persons who had gathered beneath the tree were struck down. Three men were killed, and several others more or less seriously injured; among the latter was Mr. Baldwin, who probably escaped instant

death through his stooping position at the moment; the three men killed having stood close by, watching his movements at the time of the occurrence.

The narrow escape our friend Baldwin had may be judged from the fact that he was rendered insensible for about an hour, and it was found that the electric fluid had struck him on the side of his head, which was discoloured for some distance below the burn. A box of matches he had in his pocket at the time was also ignited. He was got home next day, and though still weak, besides being a good deal prostrated, is getting on very well, and hopes soon to be quite right again.

The clergyman of the parish writes to say that he is endeavouring to start a subscription for the widow and children of George Adams, one of the unfortunate men killed. Adams was a farm labourer, employed in the neighbourhood, and as we understand the case to be a very urgent and deserving one, we venture to ask for a little help towards the fund from any charitable readers who may feel disposed to assist.

Contributions, however small, will be thankfully received and acknowledged by the Rev. W. F. Kelly, Lacey Green Vicarage, High Wycombe, Bucks; or J. Huckle, Kings Langley, Herts.

LINCOLNSHIRE B. K. ASSOCIATION.

SHOW AT BRIGG.

The annual show of this Association was held at Brigg on the 22nd, 23rd, and 24th of July, in conjunction with that of the Lincolnshire Agricultural Society.

We are glad to find that this, one of the oldest of the affiliated Associations, has, under new management, shaken off the lethargic condition into which it had of late years fallen. It was reorganized in 1889, and has the Lord Bishop of Nottingham for its President, with a long list of noblemen and gentlemen as Vice-Presidents. The Acting Committee consists of seventeen gentlemen, most of them well-known bee-keepers residing in different parts of Lincolnshire. Nine of their number have undertaken to act as district Hon. Secs. in their respective localities, new rules have been drawn up, and the officers were elected at a general meeting held during the show, as reported on next page.

Lincolnshire is one of the most favoured counties for the production of honey, and the district in which the show was held this year (although the people are somewhat slow to give up their skeps) cannot be surpassed.

Here white clover is grown as one of the crops for sheep-pasture, and the fields are white with it; mustard, turnips, rape, and heather also abound.

The bee-tent appeared to be quite a new and a great attraction to the agricultural labourers, who came to the show in great numbers on the last day. Many of them, we were informed, had twenty to thirty skeps of bees, and they

only knew of the cruel plan of smothering the bees in order to take their honey. Mr. Baldwin lectured to large crowds of attentive listeners, who were amazed at the ease with which the bees could be driven from their stores, and we heard one or two say they intended to try modern ideas of management. The district Secretary for Brigg (who, by the way, obtained the first prize for the largest and best exhibition of comb or extracted honey and the silver medal of the B.B.K.A.) will have plenty of opportunities for teaching modern bee-keeping in the neighbourhood, and making converts to the frame hive and the extractor.

The comb honey in sections was not so well finished as such a district, with intelligent management, ought to produce; the season, no doubt, had something to do with this.

The extracted honey, principally from clover, was exceedingly good. For the year, we consider the show of honey a great success.

The class for hives was not a good one, and those shown not up to the mark, either in material or details. The hive marked 'Too late for competition' was far and away the best hive in the show.

In the collections of hives there were three entries, some of which contained a large quantity of things, many of which were entirely out of date and not necessary, according to present ideas. It is a pity that manufacturers should be at the expense of sending such a number of things, when, if the schedule is carefully read, it will be seen that the prize is offered for the things most applicable to modern bee-keeping—the best, not the largest, collection.

The awards were made by Mr. John M. Hooker, and were as follows:—

Best exhibit of comb and extracted honey.—1st prize, 2*l.* and silver medal of the B.B.K.A., Geo. W. Edlington, Brigg (150 lbs.); 2nd, 1*l.* and B.B.K.A. bronze medal, Herbert J. Banks, Wragby (120 lbs.).

Best twelve 1-lb. sections.—1st, R. Godson, Tothill, Alford; 2nd, Thos. Sells, Uffington, Stamford; 3rd, Wm. Sells, Uffington, Stamford; 4th, Wm. Taylor, Wrawby, Brigg.

Best 24 lbs. extracted honey.—1st, Wm. Taylor; 2nd, E. C. Walton, Newark; 3rd, Geo. Catley, Gaxhill, Hull; 4th, Percy Taylor, The Bank, Caistor.

Best observatory hive stocked with bees and queen.—1st, E. C. Walton; 2nd, H. O. Smith, Louth.

Best collection of hives and bee-furniture.—1st, 5*l.*, W. P. Meadows, Syston, Leicester; 2nd, 3*l.*, S. J. Baldwin, Bromley, Kent.

Best rapid feeder.—1st, Chas. Red-haw, South Wigston, Leicester; 2nd, W. P. Meadows.

Best slow feeder.—1st, W. P. Meadows; 2nd, S. J. Baldwin.

Best frame hive for general use, price not to exceed 12*s. 6d.*—1st, E. C. Walton; 2nd, W. P. Meadows; 3rd, S. J. Baldwin. Mr. C. Red-haw's exhibit in this class arrived too late.

Best honey extractor.—1st, W. P. Meadows, the 'Windsor improved,' price 12*s. 6d.*; 2nd, W.

P. Meadows, the 'Raynor,' price 30*s.*; highly commended, W. P. Meadows, 'the Guinea,' price 2*l.*

For the best pair of section racks, price not to exceed 3*s. 6d.*—1st, S. J. Baldwin; 2nd, W. P. Meadows.

For interesting and instructive exhibits not before mentioned.—1st, W. P. Meadows, bee-keepers' 'factotum,' samples of new frames, new 'Hill' smoker, &c.

LINCOLNSHIRE BEE-KEEPERS' ASSOCIATION.

The annual general meeting of the Association was held on Thursday, the 23rd ult., at noon, on the show-ground of the Lincolnshire Agricultural Society, Brigg—Gerrard Young, Esq. (Vice-President) in the chair. After having introduced the new Hon. Secretary (Mr. R. Godson, of Tothill, Alford), a thoroughly practical, successful bee-keeper, the members proceeded to pass the minutes of the last general meeting at Boston, and also those of the last Committee meeting, on July 9th. Mr. H. O. Smith was appointed Hon. Secretary for the Louth district, and five fresh districts were formed, thus extending the sphere of action of the Association. Arrangements were made for the autumn tour of the Expert, and a proposition unanimously carried asking W. Martin, Esq., C.C., of Wainfleet, to support the Association's request to the County Council for a grant of 25*l.* from each of the three divisions of Lincolnshire. A hearty vote of thanks to the Chairman closed a very successful meeting.

LEICESTER B. K. ASSOCIATION.

SHOW AT LEICESTER.

The annual show of the above Association was held in connexion with that of the Leicester-shire Agricultural Society, on the 29th and 30th July, on the show-ground of the Society at Leicester. Entries were numerous and exhibits good, and the success of the exhibition would have been complete but for the rain, which interfered sadly with the show, from a visitor's point of view, on both days. Our special concern was, of course, the bee department, and it was the best display of honey we have yet seen this year. Some hundreds of good sections were shown, all the present season's gathering, the total weight of honey staged being over a thousand pounds, while most of it was produced in the county of Leicester. For an Association which makes no pretence to be considered among the largest organizations of the kind, this weight of honey in a moderate season is most creditable to the Association, and we were somewhat at a loss to account for the good display made by its members, until an explanation was forthcoming in the fact that another show of honey takes place on August 4th, in connexion with a very popular annual exhibition known as the 'Abley

Park Flower Show.' The good people of Leicester make this show quite a *fête* day in the town, and as the bee department takes the form of a great honey fair, there is no difficulty in selling the produce of members' apiaries at good prices. The date of the show fits in well with the close of the ordinary season, and taken altogether it forms a capital incentive for the encouragement of honey-production when so good a market is provided. The idea appears to be so successful that it is worth the consideration of Bee Associations whether similar advantages could not be found in other places.

But to return to the show under notice.

In Class 1, for *observatory hives, stocked with bees* (four entries).—All the hives shown were similar in type, with glass sides and top, holding from twelve to sixteen frames, and each having one frame with bees and queen of the stock in a unicorn hive above. This type of hive scarcely meets the idea of an 'observatory,' which should have its combs visible on all sides, but each stock shown was a very excellent exhibit of its kind.

Class 2, for *sections, the produce of one apiary in 1891*.—Each of the five competitors staged fifty sections, which made up a capital class, the prize ones being all good.

Class 3, for *the best exhibit of extracted honey of 1891, not exceeding fifty pounds*.—There were twelve entries, and this also was an excellent class, though the quality was, curiously enough, not so uniformly good as that for sections. The rule of the season has hitherto been 'sections poor, but extracted honey good;' here, however, the sections were the feature of the honey display.

The same remarks will apply to Class 4, for *the best twelve one-pound sections*, and Class 5, for *the best twelve one-pound jars of extracted honey* (ten entries in the former and eleven in the latter).

Messrs. Meadows and Redshaw, as usual, staged collections of appliances not for competition.

Class 6, for *the best frame hive, price not to exceed 10s. 6d.*—Here the local manufacturers, Messrs. W. P. Meadows and Chas. Redshaw, were each too strong as exhibitors, and too well known to invite any rivalry, and so no other competitors put in an appearance. The hives shown by the above named were, however, so excellent, that we had but one fault to find with them, and that is expressed in five words: 'Too good for the money.'

Class 7, *Best frame hive for general use*.—Here Mr. Redshaw showed a capitally made 'W. B. C.' hive and section box, while Mr. Meadows staged his 'X L all' hive.

The remaining two classes were for members who should, in the quickest, neatest, and smartest manner, *manipulate a frame hive* by taking out, turning, and exhibiting bees and their queen, replacing, covering up, &c., with the least excitement to bees, &c.

We were much interested in the above competitions, containing, as they do, a 'new de-

parture' in bee-shows, and one which we think will be productive of much good. The unfortunate weather, however, made it impossible to go on with them on either day.

The awards were as follows:—

Class 1, Bees.—1st, C. Redshaw, South Wigston; 2nd, H. M. Riley, Tower House, Leicester; 3rd, Miss S. J. Cooper, Leicester.

Class 2, Honey.—1st, W. P. Meadows, Syston; 2nd, J. R. Truss, Ufford Heath, Stamford; 3rd, T. E. Poxon, Lockington, Derby; Highly commended, F. Parry, Ratcliffe College.

Class 3.—1st, Captain W. H. G. Ord, Bury St. Edmunds; 2nd, T. B. Widdowson, Leicester; 3rd, J. R. Truss; highly commended, T. Adcock, Desford.

Class 4.—1st, T. J. Clarke, Leicester; 2nd, R. Tyler, Old Humberstone; 3rd, T. Wild, Little Dalby; highly commended, F. Parry.

Class 5.—1st, Miss Chester; 2nd, Miss E. Cooper, Leicester; 3rd, Miss S. J. Cooper.

Class 6, Hives.—1st, C. Redshaw; 2nd, W. P. Meadows.

Class 7.—1st, C. Redshaw; 2nd, W. P. Meadows.

SCOTTISH BEE-KEEPERS' ASSOCIATION.

Amongst the principal bee-events of the year, and one that is likely to produce most important results in bee-keeping in the north, is the show just held by the Scottish Bee-keepers' Association in connexion with and under the auspices of the Highland and Agricultural Society.

The Caledonian Apiarian Society used to hold an annual show, also in connexion with the Highland Society; but, owing to insufficient support, it has for some time ceased to exist. Early in the present year an entirely new society was formed, with Mr. T. D. Gibson-Carmichael as secretary, and it is due to his indefatigable zeal for the cause and energy that the most successful show ever held in Scotland has just been held. It was well known that many of the directors of the Highland Society were strongly opposed to having a bee exhibition in connexion with their shows, and well they might say that there was not much interest shown, inasmuch as there being an extra fee to pay to see the bee and honey show, comparatively few took advantage of the opportunity of visiting the bee department. Some of these directors have, however, quite changed their opinion after seeing the crowd of eager spectators who thronged the bee department, sometimes to such an extent as to cause fear for the safety of the exhibits.

Whatever differences of opinion there might have been on the committee as to charging for admission to the bee department, the directors having intimated that they would not allow any charge to be made, there could not be two opinions as to the success attending this new departure. Not only were there large numbers of bee-keepers present with whom we were

pleased to become personally acquainted, but a large number of people who had never kept bees were interested not only with the exhibits, but also with the practical manipulations. So sceptical were the directors of the Highland Society as to the success of the show, that they did not allow all the space asked for; the result was, that the exhibits were much more crowded than they ought to have been, and the appearance would have been much improved had the sheds been at least twice as long. We hope the directors will realise the great value of the bee department, and will work as well with the Scottish Bee-keepers' Association as the 'Royal' does with the B.B.K.A. The arrangement of the exhibits was very much on the plan of those of the 'British' shows, the honey being staged on shelves of six tiers. All who saw it declared it was the finest exhibition ever seen in Scotland.

The show was held in the King's Park, just under Stirling Castle, and surrounded by distant hills, with Ben Lomond in the far distance. A more lovely situation could hardly be conceived. The bee department was put out of the way in the farthest corner of the yard. In the longest shed were arranged the exhibits for competition, and in a smaller shed there were the observatory hives, and a large educational collection brought together by Mr. Carmichael, illustrating the natural history of bees and different Continental methods of bee-keeping. In this department there was a huge model of a bee, showing all the internal organs *in situ*, models of combs and bees, a wasp's nest with wasps at work, a swarm of bees working out foundation, another on guides only—and both being started on the same day the advantages of comb foundation in the more advanced combs was practically demonstrated. This was very striking on the fourth day of the show, when those on foundation were worked out into full combs, whilst those on guides only did not much more than fill one-third of the hive. There were also diagrams, appliances of all sorts, and statistics of honey imports. So great was the crush in this shed that it was deemed advisable to remove the central stand. This part of the show was under the supervision of Sergeant Hill, who explained the various exhibits, while Mr. Carmichael at frequent intervals explained the model bee.

In the principal shed the exhibits of honey of course formed the most attractive feature. The honey was all good, and the competition was very severe, the competitors being from the three countries. In Class 9, Mr. Roebuck staged a very fine collection of honey in sections, supers, and glasses; but, unfortunately, just before the judging commenced his staging gave way, and the whole of the exhibit, together with some fine supers in other classes, became one mass of ruins. However, from what remained a sufficiently good show was made to receive first prize. It was in the section classes that the competition was the most keen. The class for 2-lb. sections only brought five exhibitors, the first prize far outdistancing the second one in appearance, finish, and flavour.

This went to English honey. In Class 12, for 1-lb. sections, there were fifteen entries, and in this all the prizes went to England, the finish of the sections and flavour of the honey being considered by the judges as very superior. In the next class, sixteen entries, the prizes again went to England. In Class 18, for run honey (24 lbs.), English exhibitors were again to the fore. In Class 20, for three jars, there were eighteen entries, and here honours were divided, first prize going to England, second and third to Scotland, and Ireland was commended. No less fine was the honey in the classes open to Scotland only, although in these the competition was not so keen as in the open classes.

The *appliance* classes were not very well filled, Mr. Howard and Mr. Steele being the only exhibitors. In consequence of this, the judges did not award a first prize. This, we think, was a mistake, considering the cost and trouble entailed in bringing collections to the show. One of the conditions in the *hive* classes being that they should be made for transmission to the heather, many of the exhibits were passed over as not complying with this requirement. For the best hive Mr. Redshaw took first, and Mr. Howard second and third for beautifully made hives. In the 'cheap hive' class the first prize was taken by Mr. Robinson for a very compact essentially heather hive. This was fixed to floor-board, and the alighting-board, with perforated zinc upon it, could be turned up, the zinc just covering the entrance for ventilation. We intend later to give a full description with illustrations of this, as well as the prize hives in Class 4, and also some of the others deserving mention and not finding places in the prize list. There was a class for a honey press, or other instrument for extracting heather honey. This class was evidently misunderstood, or we should not have had an ordinary extractor shown in it. Any one who has had anything to do with heather honey knows that a very great pressure is required to get heather honey out of the combs. An ordinary extractor will not move it, and we do not think any of the lever presses shown would be much more effectual.

The judges gave the preference to a machine consisting of a cylinder of perforated sheet tin; a piston works up and down, and is actuated by the foot. The honey-comb is put into this cylinder and pressed against the lid, and the honey is supposed to pass through the sieve. We fear that the whole thing is much too slight to allow of sufficient pressure being exerted for effectually expressing the honey from the combs. We think the most perfect way is by means of screw pressure, and specimens of combs pressed by a new machine were exhibited, which were declared to be the best-pressed combs ever seen. These were done in a press by Mr. Barton, which we hope to describe and illustrate in the *B. B. J.*

In the class for new inventions or improvements Mr. Howard was awarded a prize for the 'Hill' smoker, and another for a very simple queen-cage for travelling and introducing; Mr.

Robinson for a section crate; and Messrs. Johnstone & Co. for improvements in hive hinges.

The show was visited by a large number of bee-keepers from different parts of Scotland, and the greatest friendliness of feeling existed. Members were being enrolled very rapidly, and Mr. Carmichael was able to announce at the meeting held on Thursday that up to that time 130 members had joined the Association, and altogether about 150 before the close of the show. At this meeting, when upwards of 100 persons were present, it was resolved to have a show of honey some time in the autumn, and Mr. Carmichael was empowered to make arrangements to hold such a show in connexion with a flower show either in Edinburgh or Glasgow. Altogether, the weather was all that could have been desired, and the exhibition in every way a great success. There was only one disappointment, and that was in the number of honey exhibits which arrived in a broken condition. As a rule, those from England arrived in good condition, while those from different parts of Scotland, although they had a much shorter journey, owing to improper packing were sadly damaged. This was in striking contrast to the beautiful supers sent from Scotland to the Crystal Palace show in 1874, which arrived without damage, and were a lesson to English bee-keepers by which they profited.

One bee-keeper present (Mr. William Sword) at the meeting reminded us that he was the only survivor of the Scotch bee-keepers who accompanied that exhibit. It was a great pleasure to us to meet him again, as well as other leading Scottish bee-keepers whose acquaintance we had made on previous occasions, and also to make the acquaintance of some of our numerous readers and correspondents in Scotland. Mr. Carmichael is to be congratulated in having carried out all the arrangements so well, and for his indefatigable perseverance in bringing this show to so successful an issue, and we trust he may receive the pecuniary support the Society deserves.

The operating tent was in charge of Mr. J. Howard, and his lectures were attended by throngs of interested listeners, who gazed in astonishment at his manipulations.

The judges for hives and appliances were the Rev. J. B. Robertson, Messrs. F. McConnel and J. Stewart; and for honey the Rev. R. McClelland, Messrs. R. J. Bennett and T. W. Cowan.

(The full prize list will appear next week.)

HONEY AT THE DAIRY SHOW.

We are glad to announce that the British Dairy Farmers' Association have acceded to the proposals of the British Bee-keepers' Association and have added four classes for honey to their schedule. The B. B. K. A. contribute 10*l.* towards the prizes. The entries close on September 14th. Application for prize lists should be made to the Secretary, Mr. W. C. Young, 191 Fleet Street, London, E.C. We trust the classes will be well filled.

Correspondence.

The Editors do not hold themselves responsible for the opinions expressed by correspondents. No notice will be taken of anonymous communications, and correspondents are requested to write on one side of the paper only, and give their real names and addresses, not necessarily for publication, but as a guarantee of good faith. Illustrations should be drawn on separate pieces of paper.

* In order to facilitate reference, Correspondents, when speaking of any letter or query previously inserted, will oblige by mentioning the number of the letter, as well as the page on which it appears.

NATIVE BEES IN INDIA.

[736.] As to the tiny bee of Australia, referred to in *B. B. J.* of July 23rd as *Trigona carbonaria*, I met that bee, or one very like it, in the Central Provinces in India. The manner of our meeting was in this wise: I was leaving my bungalow for a time, and went round to see that its doors and shuttered windows were properly secured before starting. Finding a window with its shutters left open—glass was not used—I hastily slammed it, and a small swarm of *Trigona carbonaria*, or a near relative, flew in my face.

I have never had a shovelful of hot ashes thrown in my face, but the sensation suggested it, and the stings tingled and smarted for a long time. I was much struck by the minute proportions of my assailants, which were, as you say, a little smaller than a house-fly, and their Lilliputian comb was elegance itself.—AMANI-SHAH, *Bideford*.

EXPERTS' CERTIFICATES—FINDING THE QUEEN.

[737.] I can fully endorse your correspondent A. G. Pugh's ideas with regard to Experts' Certificates (699, p. 301). I have gained some few certificates when younger from the Science and Art Department, and I can confidently say they were all better, and easier to me to obtain at that age, than the B. B. K. A.'s certificates are at my present age; and I think that candidates ought to be better repaid for all their trouble and brain-racking work, especially in the second-class examinations. I should like something worth exhibiting to my friends, as I consider the entry fee quite sufficient, but I would willingly pay a little extra, if needed, to gain a certificate which was presentable. I don't like to hear the remark: 'Is that all you got for your trouble?'

With reference to another correspondent's request (696, p. 300) *re* finding queen, he will find patience and practice the only things that make perfect; but if the few hints given below are of any service to him, he is quite welcome:—When examining a comb, commence at the outsides and finish in the middle, as queens are very shy, and will quickly run from one side of comb to the other. Generally the queen will be found on combs in the brood nest having unoccupied cells or that contain eggs which have just been laid.—H. HILL, *Second-class Expert*.

A NEW HIVE.

[738.] My object has been for some years past to construct a hive which, whilst retaining all the advantages of the ordinary bar-frame hive, would winter the bees well, and get them forward early in the spring, points in which I consider the ordinary hive deficient for the following reasons, viz., that the hive, being square, the heat passes off from the cluster of bees to the corners, and there condensing, makes the hive damp, which is exceedingly injurious to the bees. The other reason is, that too much of the warm air is allowed to escape at the top of the *hive*, which, whilst it to some extent removes the dampness, yet renders it difficult for the bees to keep up the necessary warmth in cold weather.

Another objection is, that the bee-keeper who would stimulate his bees in spring must cut holes in his quilts, which also allow the warm air to escape, and he is further obliged to remove the roof every time he wishes to feed them, or to see that they have food.

In the 'English Hive' I have not only remedied these defects, without in any way affecting the uses of the ordinary bar-frame hive, unless it be that this hive cannot be increased laterally, but I have improved the crate by making it either a section or extracting-crate as desired, and have further introduced an outer case, which I have called an 'Overall,' and which I have no doubt many bee-keepers will find useful.

I have omitted the porch, which in this hive is certainly quite unnecessary, as also the slides, which are not required, as I consider any contraction of the entrance in winter injurious to the ventilation of the hive.

It is generally conceded that bees winter best in dome-shaped skeps, but I claim for this hive that, even without the overall, it will bring bees through the winter in a superior manner to any skep wintered in the usual way. I append a description of the hive.—A. T. WILMOT, *St. Albans*.

DESCRIPTION OF THE HIVE.

The surface of the floor-board is $16\frac{1}{2} \times 15$ inches in measurement. The sides are chamfered to allow the rain to fall off. The bees

obtain access by means of the alighting-board, passing up under the floor-board, and through it into the hive.

The eke is the same as the body would be if its lower half were cut away and without feeding-box.

The eke is both for the prevention of swarming and for making artificial swarms; it can be placed on the body, and, when the bees have commenced on the foundation guides, removed to the bottom, where it can remain, its top forming a capital floor-board for the body above; or, if increase of stocks be desired, it can be removed before the end of the honey glut, its top bars taken out, and placed in an empty body (see body), and an artificial swarm made.

N.B.—The frames and side top bars in this empty body will be removed, and the four central bars of the eke made into frames. The eke can be purchased without the top bars.

The body differs from the ordinary bar-frame body, inasmuch as pieces are placed across the four corners, making the inside octagonal in shape; three of these corners are filled up with shavings for warmth, the other, on the left side of the back of the body, is made into a feeding-box, and contains a stage fitted with removable slotted zinc, on which

rests a one-pound eight-hole feeding-bottle, accessible to the bees from the inside, and to the bee-keeper by a door cut in the side, as shown. The bottle is taken in and out by means of a pair of clippers, kept in the feeding-box.

The outside of the body, as represented in the plan, is $16\frac{1}{2} \times 15$ inches, the inside, $15\frac{1}{2}$ inches and $13\frac{1}{4}$ inches across respectively, and 9 inches deep.

There are four central frames with top bars $15 \times 1\frac{1}{8} \times \frac{3}{8}$ inches, and having comb-space 12×8 inches. There is a similar removable top bar placed on each side of the four central frames, and the remaining space is filled up by two bars $3\frac{3}{8}$ inches and $3\frac{1}{2}$ inches wide respectively; these two latter may be furnished with guide comb or not, as suits the bee-keeper.

The top bars are kept in place by means of ten gauge-pieces $1\frac{1}{2} \times \frac{1}{16} \times \frac{3}{8}$ inch, these latter preventing the escape of heat, as is the case with metal ends, runners, &c. The slots be-

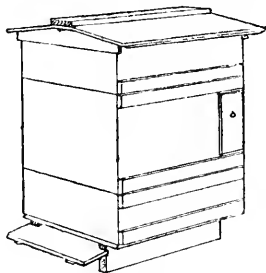

Fig 1.

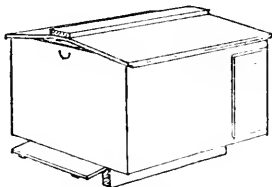
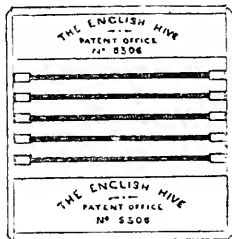
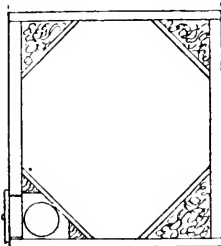

Fig 2.



Plan 1.



Plan 2.

tween the six central bars are $\frac{3}{8}$ of an inch wide, and it is hoped this will render queen-excluder zinc quite unnecessary.

N.B.—In summer, if it be desired, a body without corner-pieces, containing ten of the central frames and dummy, can be used either with or without metal ends and runners.

A speciality about the section or extracting-crate is that it fits on the walls of the body, and, therefore, does not require any strips of carpet or other material to fill up the spaces around it. It is made of $\frac{3}{4}$ -inch wood, its inside dimensions being $15\frac{1}{2} \times 13\frac{1}{2}$ inches. Another speciality is that the centre girders are made of strips of tin turned down on each side, thus, , which, while they render propolis almost *nil*, allow the crate to carry either twenty-one one-pound sections, or nine wired extracting frames $13\frac{1}{2} \times 4 \times 1\frac{5}{8}$ inches.

The roof is covered with zinc, and is 20 inches square, having a flat piece on top on which the feeding-bottle, &c., can be placed when filling it.

The overall is an outer case without top or bottom. Its outside measurement is 19×18 inches, and is about 10 inches deep. It is easily attached to the roof by means of two pins, and drops over the body in winter. It has a door on its left side to enable the bee-keeper to get at the feeding-box.

Note.—The overall should not be considered as an essential part of the hive, but it is believed it will materially add to the well-being of the bees in winter, and also can be advantageously used over the section crates in summer, or, with the roof, it will make a capital outdoor shelter for a skep or makeshift hive.

Queries and Replies.

[390.] *Curing Foul Brood.*—I regret to have to trouble you again, but after I wrote you about my bees, I found that two or three more stocks were affected with foul brood. I destroyed the affected parts of the combs in the hive from which I sent you a sample, thoroughly disinfected the hive with sulphur fumes, and joined the bees to another stock affected, but not so badly. Further than this, I have done nothing, as supers are on. All the stocks got very strong, and the *most affected* swarmed once, in spite of the supers. What I propose to do with them is, to melt up all the combs, disinfect the hives with sulphur fumes and carbolic acid, then replace the bees on foundation, and let them build fresh combs; at the same time to feed them with honey or syrup, medicated with Naphthol Beta, and keep naphthaline on the floor of the hives. I shall be glad if you will kindly inform me in the *B. B. J.*—1. If this plan is likely to be successful? 2. If so, the latest date I may safely do it, as I would like to keep the supers or sections on as long as I can? 3. As the honey I have by me for feeding was taken this spring from destroyed stocks (it is last year's honey) and is slightly granulated, I

shall be glad to know the best way to prepare it for use with the Naphthol Beta. I shall understand your reply to suppose fairly fine weather in September.—B. H.

REPLY.—1. Your proposed plan of reducing the stocks to the condition of swarms, and compelling the bees to build new combs on foundation, is the best which, under the circumstances, could be followed. It is because few will trouble to take such drastic measures that we do not more often advise its adoption. The points to watch are—1. Not to delay the operation beyond the last week in August. 2. To have plenty of bees in each hive to build out the combs; otherwise to join two lots together; and, 3. To feed liberally while the bees are comb-building and until they are well supplied with food for winter. If sulphur fumes are properly applied there will be no need for carbolic acid. Dilute the honey with water, boil for a minute, and medicate the food with Naphthol Beta, according to the printed instructions on the packet.

[391.] *Bees Attaching Combs to Separators.*—1. Will you kindly inform me how to prevent bees joining the comb to the division boards between the sections, which extend up to top of same and are about $\frac{1}{2}$ -inch thick? 2. Would you advise extracting from frames which have sections on in which bees are not working? If not, when should extracting be done? The frames, I believe, are all full. 3. When should bees be driven from skeps—'compelled to be used, not having frame hives sufficient'—and united or put into a frame hive? I have three strong stocks, this year's swarms, full of honey, one supered.—W. A. FIELD, *Grimby*.

REPLY.—1. Except in cases where sections are filled with ready-built combs, and too little space is allowed between these combs and the separators, there is no reason why the bees should build brace combs. Occasionally they will do so; but, with proper management, it rarely happens. Separators should not 'extend up to top of sections,' but be cut so as to allow the bees to pass above and below them. 2. If bees persistently refuse to enter sections, and frames below are full of sealed honey, they may have their contents removed. As a rule, however, we deprecate extracting from combs in brood chamber, and would leave any which contain brood severely alone. 3. Early in September.

[392.] *Varieties of Heather.*—In our district we have about twelve hundred acres of heather, and herewith send you four samples, marked 1 to 4, which we would thank you to name, and also to say which is the best honey-producing variety. We hold corresponding samples.—J. BROWN, *Hon. Secretary, Bristol District B.K.A.*

REPLY.—No. 1, *Erica cineria* (white variety). No. 2, *E. tetralix* (true). No. 3, *E. cineria* (variety). No. 4, *E. cineria* (true). None of these are of any *real* use to the bee-keeper, the flower-bell being too long for the bee's tongue. Odd flowers on dwarfed plants may, however,

be worked just to keep body and soul together, The humble-bee and also certain insects, snails and slugs, may pierce and bite out bits, then our bee may get a little nectar. Our correspondent, however, if he looks a fortnight hence in his district, will find the true honey heather, *Calluna vulgaris*, the ling, the great honey-yielder (conspicuous by its inconspicuousness); a *much* smaller bloom, and paler in colour. This also has its white varieties, as sports from the type.

[393.] *Metal Screw Tops*.—Does honey act upon lead? I have got some honey bottles, and the screw tops appear to be lead. Is there any danger in using these, lest the honey, acting upon the lead, should form sugar of lead, or any other poison? The screw tops are fitted with cork wads, but this does not altogether prevent contact.—CHAS. FEETHAM, *Bath*.

REPLY.—The screw tops of honey jars are not lead. The metal used is more of the nature of pewter, and we do not think there is any danger whatever in using the metal tops.

[394.] One of my frame hives gave me a second swarm on 13th July, which returned in about three hours. They have not swarmed since, and show no inclination for swarming now. 1. Do you think queen has got killed, or do they ever return and not swarm again? I have always seen them swarm next day after returning. My largest frame hive (Abbott's) swarmed twice and returned; the third time the bees stopped in skep. 2. Do ever first swarms return to parent stock after swarming? 3. Is piping heard in hives before first swarm leaves? 4. What time would I hear piping in hives before swarming? 5. Where is the best and cheapest work on bees, &c., obtainable. Bees about this district have been swarming for last three weeks or month.—J. A. A., *Kesh, co. Fermanagh, Ireland*.

REPLY.—1. Some mishap has most probably happened to the queen, but if a swarm, with its queen, did happen to return to the parent hive after some hours' absence, a duel between the queens might result in no further swarming. 2. Yes. 3. Some have asserted that it is, but we have had no experience of such a thing, and it must be very rare. 4. Usually on the evening of the day before. 5. From J. Huckle, Kings Langley, Herts.

Bee Shows to Come.

August 5th, 6th, and 7th.—Yorkshire Agricultural Society at Bradford. Entries closed June 27th. Marshall Stephenson, Sec., York.

August 13th.—Goole and District Branch of Yorkshire B.K.A. at Goole. Entries close August 10th. A. Woodhead, 99 Edinburgh Street, Goole.

August 29th.—Forfar B.K.S. at Forfar. James Hutchinson, Secretary, Yeaman Street.

September 2nd and 3rd.—Lancashire and Cheshire B.K.A. at Birkenhead. Entries close

August 15th. For schedules apply Arthur H. Edwardson, 28 Hamilton Street, Birkenhead. Liberal prize list open to all comers.

Sept. 5th.—Alderley Edge and District Branch of the Lancashire and Cheshire B.K.A. Chelford Flower Show, Astle, Chelford. Schedules, &c., T. D. Schofield, Alderley Edge, Cheshire.

Sept. 5th.—Bramhall and Woodford District Horticultural Society at Bramhall Hall, near Stockport. Entries close August 22nd. Particulars of William Slater, Fern Lea, Bramhall, Stockport.

Sept. 9th, 10th.—Derbyshire Bee-keepers' Association at Derby. Entries close August 27th. W. T. Atkins, Sec., 12 North Street, Derby.

Notices to Correspondents and Inquirers.

Letters or queries asking for addresses of manufacturers or correspondents, or where appliances can be purchased, or replies giving such information, can only be inserted as advertisements. The space devoted to letters, queries, and replies, is meant for the general good of bee-keepers, and not for advertisements. We wish our Correspondents to bear in mind that, as it is necessary for us to go to press in advance of the date of issue, queries cannot always be replied to in the issue immediately following the receipt of their communication. All queries forwarded will be attended to, and those only of personal interest will be answered in this column.

AMATEUR (Bath).—Both samples of honey are good; No. 1 especially so. The colour and appearance of the capping in sample No. 1 are excellent for show purposes, the other points being to secure sections with the comb built out close to the wood on all sides, and with every cell sealed, if possible.

T. J.—*Bees and Second-crop Red Clover*.—Everything depends on the weather. Do not, however, leave the supers on till the bees carry the contents below. The end of August is soon enough to begin winter feeding. Five-pound bottles will answer the purpose very well. Use muslin—not flannel—for coverings, and cut an opening in the quilts on which to stand the bottles. Don't put perforated zinc between. Syrup may be given cold. Sugar sent is made from beet, and not suitable for bee-food.

MOUCH-À-MIEL.—*Vicious Bees*.—It is generally conceded that hybrid, or cross-bred bees are more vicious than the pure varieties. It is not always safe to say that any particular cross will be sure to produce quiet bees. Experience proves the contrary, because a stock will sometimes produce vicious bees for no reason that can be adduced, and when this occurs the queen should be promptly destroyed, and the hive re-queened. Queens may, as you observe, be introduced in early summer.

JAS. BREWER.—*Re-queening Hives*.—The plan of joining casts or second swarms to stocks with old queens after removing the latter is an excellent one. Follow it by all means in your case and in the manner proposed. In uniting, drive the bees into a skep; when driven, set it on a large floor-board, wedge it up and shake off the bees from the frames and let them join the driven bees by running in. Shake all up together in the skep, and then

knock them out in front of the frame hive they are to occupy, dredging the bees with a little flour as they run in. Of course the old queen must be removed beforehand.

A. Scor (Stirling).—The dead queen is the old one. It not seldom happens that bees depose their queens in this way and raise new ones.

J. A. A. (Kesh).—*Bees casting out Drones.*—When bees begin killing drones and casting out brood, it is a sign of the approaching end of the honey season, or an indication of scarcity of food in the hive.

T. R. (Durham).—*Re-queening Hives.*—By leaving the old queen till about this time, all the bees likely to be useful at the moors will be produced from eggs already laid, so the young queens may be introduced at once after removal of the old ones. Bees do remove unsealed honey into sections overhead if they lack room below for breeding. The unfinished sections had best be put on the hives at the moors for completion.

R. P. DOXFORD.—1. No one can say exactly why some swarms fly off and are never seen again. —2 and 3. There could not possibly be brood of the young queen sooner than from sixteen to twenty days after the top swarm took flight.—4. Not under circumstances named.—5. Queens hatched from cells on the 24th would most likely be dead when your note reached us (on 25th) unless dealt with by an experienced person.

INQUIRER (Staffordshire).—We cannot say it is unlawful for a bee-keeper to prepare his hives for the reception of swarms in any way he may see fit, and leave them open, too, if he so desires; but if swarms, other than his own, enter hives so prepared, they may be claimed by their owner if not lost sight of between the time of leaving the parent stock and entering the strange hive.

T. G. (Staffs).—1 and 2. Sugar is not pure cane, and is therefore unsuitable for bee-food. 2. You can do nothing but wait till young queen is fertilised; super had better be removed, as no work will now be done in it. 3. There are several things very 'unusual' in what you describe, and which, on the details sent, we cannot explain or account for. Young queens seldom hatch out in less than eight days after top swarm leaves.

C. S. REID.—*Boxes for carrying Driven Bees.*—The boxes used are old 'washing powder' or 'Hudson's soap' boxes. Beyond cutting the holes (good-sized ones) and covering with perforated zinc, little is needed in the way of 'making.' No entrance is required, the bees after driving into the skep are thrown out on to a newspaper and allowed to run into the open box, propped up to receive them. Box and bees are then lifted on to the loose lid; all is tied together with cord, and they are ready for carrying. The box and bees, minus lid, may be set on the old stand to gather in the flying bees, if time allow it.

BALDWIN'S

is the Oldest Establishment in the United Kingdom wholly devoted to Bees and manufacture of

Bee-keepers' supplies. His prices will compare most favourably with those of any other Maker, while for quality of material, suitability and workmanship, he has no rival.

'Why can he give better value for money than others?' Because he spends less in large 'puffing' advertisements, buys in the best markets for prompt cash, has no rent to pay, and personally conducts his own business.

For prices and full particulars of Goods see Baldwin's Bee-keepers' Instructor (and Illustrated Catalogue combined), which 'contains more practical and reliable hints than all the large, expensive books,' post free for 2d. stamps. Address **S. J. BALDWIN, The Apiary, Bromley, Kent.** N.B.—More than 500 Silver and Bronze Medals, First and other Prizes, and Testimonials innumerable.

WILTS

BEE-KEEPERS' ASSOCIATION.

THE COUNTY SHOW will be held August 19th, at the SWINDON HORTICULTURAL FETE, when the Medals and Certificates of the B. B. K. A., and sundry Money Prizes will be competed for.

W. E. BURKITT, Hon. Sec.,
Buttermere Rectory, Hungerford.
Entries close August 12th.

SHROPSHIRE

Bee-keepers' Association.

The Annual Exhibition of
Bees, Honey, Hives, and Appliances,
Will be held in

THE QUARRY, SHREWSBURY,
in conjunction with the
HORTICULTURAL SOCIETY'S GREAT FETE,
On Wednesday and Thursday, Aug. 19th & 20th.
PRIZES to the Value of £35 will be awarded.
For Prize Lists, Entry Forms, and Information,
apply to **T. WHITTINGHAM, Water Lane, Shrewsbury.**

THE GOOLE AND DISTRICT Bee-keepers' Association.

Show of Flowers, Fruits, Vegetables,
and Honey,

At **GOOLE, August 13th.**
Special Classes for Members of the Yorkshire B. B. K. A.
ENTRIES CLOSE AUGUST 10th.
Schedules, &c., of **A. WOODHEAD, Hon. Sec.,**
EDINBOROUGH STREET, GOOLE.

FOUL BROOD.

FORMIC ACID.—Draper's 'B' brand, guaranteed pure. As used and recommended by Mr. Sproule in *Bee Journal*. Stoppered bottles, 1 lb., 3s. 6d.; 4 lbs., 11s. 6d., post free. Address **EDMONDSON BROS., Bee Appliance Warehouse,** 10 Dame Street, Dublin. 246

THE
British Bee Journal,

BEE-KEEPERS' RECORD AND ADVISER.

No. 477. Vol. XIX. N. S. 85.]

AUGUST 13, 1891.

[*Published Weekly.*]

Editorial, Notices, &c.

WILFUL DESTRUCTION OF BEES.

On Tuesday, the 4th inst., Charles Clarke, a schoolmaster, of 24 Itley Road, Hammersmith, appeared before Mr. Plowden at the Hammersmith Police Court in answer to a summons (issued at the instance of Mr. William Soar), charging him with having, on the 27th ult., wilfully destroyed a swarm of bees belonging to the complainant by syringing them with water and afterwards setting fire to them.

The defendant pleaded guilty to destroying the bees, but urged in extenuation that at the time he did not know to whom they belonged, and that the measures he took were only for the purpose of ensuring protection for himself and family against what he deemed to be noxious insects. Under these circumstances the magistrate invited both sides to consider whether the matter could not be settled out of Court by the payment of compensation for the damage done, he offering to adjourn the case for a week in order that the parties might have time to think over the suggestion. The defendant, however, elected that the case should proceed.

Mr. William Soar then entered the witness-box, and deposed as follows: I live at 30 Itley Road, Hammersmith, and am in business as a picture-frame maker. I am also a bee-keeper. My bees swarmed on the 27th of last month. I did not see them swarm, but my wife did; and, in consequence of what she told me, I called on the defendant, and asked him if my bees were in his garden, and if he would allow me to take them. He replied that they were, but he would not permit me to go into the garden. My wife had previously informed me that she had seen him in the act of destroying the bees. I told the defendant it was very wrong of him to destroy them, and that he was liable to be punished for doing so. I also said that no one would have been harmed if he had allowed me to take them away. He answered that he would take the risk of any legal proceedings; that he was quite at liberty to destroy my bees if they went into his garden, just the same as he would destroy a cat or dog, or any other animal, that trespassed there; besides, his children were in danger of being stung.

Cross-examined by Defendant: I knew when I called on you that the bees had been partly destroyed. You did not say you were unaware that the bees had an owner, nor did you tell me that one of your children was very ill in consequence of a bee-sting. It is not true that you offered me any compensation, conditionally or otherwise.

Mrs. Emma Soar, wife of the last witness, said: I saw the bees swarm and settle in the garden of No. 22, next door to the Defendant's house. I then went to the front door of No. 22, and saw the lady of the house, and asked permission to go through to the bees. She would not allow me to do so, but said she would speak to her son (meaning the Defendant, who is her son-in-law). I waited at the door, when the Defendant came out. I asked him if he would allow me through to take the bees. He said no; he was going to kill them. I cautioned him against doing so. The old lady at No. 22 afterwards let me go to the back of the house, where I saw the Defendant put fire under the shrub where the bees were. I thereupon went home, and to a back window upstairs, from which I could see the tree all ablaze. I did not afterwards see what became of the bees. I told my husband the circumstances when he came home.

Mr. William Edward Soar, a cousin of the Complainant, stated: I live at 30 Itley Road. On the day in question I was standing at one of the top windows at the back of the house, and saw the swarm leave our garden and alight in the garden of No. 22. It had only just reached there when the Defendant came out in his own garden with a large syringe, the contents of which he squirted on to the tree where the bees were. He repeated this performance three times. I did not see the effect this treatment had on the bees, as I left the window immediately afterwards.

The Defendant, in answer to the charge, contended that he did not destroy the bees with any malicious intent, as he did not know that they belonged to any one at the time he commenced to kill them. They were an intolerable nuisance, one of his children having recently suffered with a bad hand resulting from a bee-sting. He had been annoyed from time to time by bees settling under the bedroom window-sill. He had no idea, until these proceedings, that any man living in London would keep bees. He had to use all kinds of extraordinary means

to preserve his flowers against earwigs and other noxious insects, and he classed bees in the same category. He had been afraid for his family to go into the garden during the last two months.

Mr. Plowden said he did not think the Defendant intended to do any wilful damage, but that he acted more with the object of protecting himself and family from what he conceived to be a danger. He (the Magistrate) was inclined to believe that the Defendant did not know to whom the bees belonged. Under these circumstances the complainant could not succeed on the summons before the Court, which must be dismissed. He was far from saying there was not ground for proceeding in a Civil Court, for it certainly appeared to him that the case was one in which equity demanded that the owner of the bees should receive some reparation for the loss he had suffered.

[In view of the importance to bee-keepers of the issue involved in the above case we had it specially reported, and we are glad to say the expression of opinion on the part of the magistrate has caused the parties to come to a satisfactory settlement without further proceedings.—Eds.]

HONEY IMPORTS.

The total value of honey imported into the United Kingdom during the month of July, 1891, was 3102*l.*—*From a return furnished by the Statistical Office, H.M. Customs.*

THE SCOTTISH BEE-KEEPERS' ASSOCIATION.

(Continued from page 350.)

AWARDS.

Class 1. For the best observatory hive stocked with bees and queen.—1st, Mrs. Gibson-Carmichael; 2nd, G. Neighbour & Sons; 3rd, James Johnson.

Class 2. For the best collection of appliances.—1st, Not awarded; 2nd, J. H. Howard; 3rd, R. Steele.

Class 3. For the best hive for general use and transmission to heather.—1st, C. Redshaw; 2nd, J. H. Howard; 3rd, J. H. Howard.

Class 4. For the best hive for cottagers' use and transmission to heather.—1st, R. Robinson; 2nd, W. Dodds.

Class 5. For the best press for extracting honey.—1st, A. Godman.

Class 6. For the best marketable super.—1st, C. Redshaw; 2nd, J. H. Howard.

Class 7. For the best rapid feeder.—1st, C. Redshaw; 2nd, G. Neighbour & Sons.

Class 8. For the best display of honey.—1st, Sidney Roebuck.

Class 9. For the best super, not being a sectional super of comb honey.—1st, W. Wilson; 2nd, W. Wilson; 3rd, Sidney Roebuck.

Class 10. For the best super of honey not exceeding 10 lbs.—1st, W. Wilson.

Class 11. For the best six sections of comb honey, 12 lbs.—1st, Tom Sells; 2nd, Sidney Roebuck; 3rd, James Crawford.

Class 12. For the best twelve sections of honey, 12 lbs.—1st, Jesse Garratt; 2nd, Miss Gayton; 3rd, Tom Sells; commended, Captain W. St. G. Ord.

Class 13. For the best three sections of comb honey, 3 lbs.—1st, H. W. Seymour; 2nd, Tom Sells; 3rd, W. G. W. Flynn; commended, Rev. R. M. Lamb.

Class 14. For the best exhibit of comb honey in sections, 6 lbs., by bees kept in Scotland.—1st, James Findal; 2nd, C. Carnegie; 3rd, Sidney Roebuck.

Class 15. For the best exhibit of heather honey, 8 lbs.—2nd, J. McDonald.

Class 17. For the most attractive display of comb honey put up in any attractive form.—1st, Sydney Roebuck; 2nd, W. G. W. Flynn.

Class 18. For the best run or extracted honey in jars, 24 lbs.—1st, A. J. Carter; 2nd, J. H. Howard; 3rd, Captain W. St. G. Ord; commended, Sidney Roebuck.

Class 19. For the best exhibit of run or extracted honey, 6 lbs., by bees kept in Scotland.—1st, W. Wilson; 2nd, John Kemp; 3rd, C. Carnegie.

Class 20. For the best three jars of run or extracted honey, 3 lbs.—1st, Rev. R. M. Lamb; 2nd, W. Wilson; 3rd, C. Carnegie; commended, Captain W. St. G. Ord, and W. G. W. Flynn.

Class 21. For the best granulated honey, 12 lbs.—1st, Captain W. St. G. Ord; 2nd, R. Steele; 3rd, A. J. Carter.

Class 22. For the best run heather honey, 12 lbs.—1st, C. Carnegie; 2nd, Mrs. Gibson-Carmichael; 3rd, D. Paterson.

Class 23. For the best display of British beeswax.—2nd, R. Steele.

Class 24. For the best single cake of beeswax, 2 lbs.—1st, A. J. Carter; 2nd, James Johnston.

Class 25. For the most interesting collection of useful articles in the manufacture of which honey or wax enters.—1st, W. Griffin.

Class 26. For invention or improvement introduced since 1889.—J. Howard, two awards; R. Robinson; J. Johnstone & Co.

Class 28. For the most instructive exhibit not included in above classes.—1st, W. Dixon.

YORKSHIRE BEE-KEEPERS' ASSOCIATION.

The annual show of the above Association was held in connexion with that of the Yorkshire Agricultural Society at Bradford, on August 5th, 6th, and 7th.

The exhibition of bee-appliances, together with the products of the hives, formed, as usual, a very interesting feature of the show, and the labours of the judge in these departments extended to well on into the afternoon. The show in these classes generally, though not as large in the quantity of exhibits as in some previous years, is, as regards quality, in front of anything that has been seen in past shows. This fact is

the more remarkable when it is remembered that the season has not been a favourable one, and that the period of sunshine has been unusually short. Districts in which the white clover abounds have been the most favoured as regards the honey crop. It is evident, from the exhibitions at this and kindred shows, that the increase in the demand for honey has given a great stimulus to its production, and it is a point, in the opinion of persons in authority, whether the scope of the competition should not be so enlarged as to attract south of England exhibitors. The bee-appliances did not present many novel features, but the articles shown were remarkable for their durability and cheapness. A leading place among the exhibitors was, as usual, occupied by Mr. William Dixon, of Beckett Street, Leeds, who, in addition to taking several prizes, exhibited (not for competition) some very interesting designs worked out in honey-comb by bees. Mr. E. C. Walton, Muskharn, Newark; Mr. W. P. Meadows, Syston, Leicester; Mr. A. C. Jemieson, York; Mr. T. Lowth, Riseholme, Lincoln; and Lady Hawke were also among the successful exhibitors.

At the bee-tent lectures on bee-management and displays of bee-driving were given jointly by Mr. G. H. L. Rickards and Mr. William Dixon, of Leeds. The cold and damp weather militated against the complete success of this feature, but in the afternoon several exhibitions were satisfactorily got through, and were listened to and watched with interest by good audiences. Mr. Rickards explained in an intelligible and attractive style the remarkable working of the bees in their hives, paying special attention to the queen-bee and her influence on the rest of the hive. Mr. Dixon also gave illustrations of the easy removal of bees from one hive to another, and demonstrated the ease with which they can be manipulated.

PRIZE LIST.

Most complete frame hive.—1st prize, W. P. Meadows, Syston, Leicester; 2nd, E. C. Walton, Muskharn, Newark.

Most complete frame hive, price not to exceed 10s.—1st, W. P. Meadows; 2nd, E. C. Walton.

Honey extractor.—1st, W. Dixon; 2nd, A. C. Jemieson, 26 Colliergate, York.

Honey extractor for sections.—1st, T. Lowth, Riseholme, Lincoln; 2nd, W. Dixon.

Exhibit of bee-furniture.—1st, W. Dixon; 2nd, A. C. Jemieson.

Novelties or useful inventions brought out since 1889.—1st, A. C. Jemieson; 2nd, W. P. Meadows.

Observatory hive.—1st, W. Dixon; 2nd, E. C. Walton.

Comb honey in sections, weight not to exceed 18 lbs.—1st, Rev. R. M. Lamb, Burton Pidsea Rectory, Hull; 2nd, the Lady Hawke, Wighill Park, Tadcaster.

Comb honey in sections, aggregate weight not to exceed 12 lbs.—1st, E. C. Walton; 2nd, Rev. R. M. Lamb.

Heather honey in six 1-lb. sections, gathered in autumn of last year.—1st, W. Dixon.

Best exhibit of extracted honey, not to exceed 12 lbs.—1st, Rev. R. M. Lamb; 2nd, T. N. Cheesman, Winterton, Lincolnshire.

Exhibit of granulated honey, aggregate weight not to exceed 8 lbs.—1st, Captain W. St. G. Ord, Farnham House, Bury St. Edmunds; 2nd, W. Dixon.

NORTHAMPTONSHIRE B.K.A.

The annual show of the above Association was held at Delapre on August 3rd and 4th, in conjunction with the Northamptonshire Horticultural Society's great summer show. The judges, Rev. R. A. White (St. Giles's), Mr. Shaw (Moulton Park), and Mr. J. R. Truss, awarded the prizes as follows:—

Class 1. Best section honey.—1st prize, C. Cox, Brampton; 2nd, W. L. Bird, High Street, Daventry; 3rd (given by the President), G. Smith, Boughton.

Class 2. Best extracted honey.—1st, C. Cox; 2nd, W. Baldwin, Brampton; 3rd, G. Smith; 4th, H. Williams, Collingtree.

Class 3. Best super of honey.—1st, C. Cox; 2nd, H. Ringrose, Boughton.

Class 4. Best beeswax.—1st (given by Johnson & Wright), H. Collins, Berry Wood; 2nd (given by Mr. Collins), C. Cox.

Special prize, a cottager's hive (given by Mr. W. Bazeley, Sheep Street), for the best twelve 1-lb. sections.—1st, C. Cox.

Class 5 (open only to those who have not before taken a prize for honey). Best six sections.—1st, F. O. Adams, Northampton; 2nd (given by R. Hefford), S. Lowick, Harlestone.

Six 1-lb. bottles extracted honey.—Equal, J. Cox, Badby, Daventry, and S. Lowick.

Glass or glass and wood super of comb honey.—1st, F. O. Adams.

On the first day of the show Mr. J. R. Truss lectured in the bee-tent to large audiences. The following day was very showery. Mr. E. Ball gave lectures, &c., and Mrs. Ball rendered valuable assistance throughout the show.

BERWICKSHIRE BEE-KEEPERS' ASSOCIATION.

The annual show of the above Society was held at Duns on August 7th, in connexion with the Berwickshire Agricultural Society. The show of honey was a very good one; the competition in the class for six 1-lb. sections more especially was very keen, and it took the judges a considerable time to decide upon the first and second prizes. There were eleven entries in this class for ten prizes, and most of the sections were shown in tin cases. The extracted honey was also very good indeed. There was only one exhibitor of hives and appliances, and it is a pity that the dealers threw away such a chance of showing their goods and doing business, for the show was well attended and great interest

was shown in the exhibits. The President, the Rev. MacDuff Simpson, and the Hon. Secretary and Treasurer, Mr. Robert Greig, attended, and to the latter are due the admirable arrangements, for the judges were able to work comfortably, every one but the Steward of the department and the President being excluded from the tent. Fortunately the weather, which at first threatened to be bad, cleared up, and enabled a large number of people to take advantage of the display.

The judges were the Rev. John Kerr, Messrs. T. D. Gibson-Carmichael and T. W. Cowan.

LIST OF AWARDS.

Class 1. Six 1-lb. sections.—1st prize, J. Turnbull; 2nd, T. Weatherston; highly commended, J. Pringle, C. R. Wilson.

Class 2. Six 2-lb. sections.—1st, D. Conels; 2nd, J. Pringle.

Class 3. Six 1-lb. jars.—1st, T. Douglas; 2nd, R. Wilson; highly commended, A. Anderson.

Class 4. Best single super. — 1st, William Jamieson; 2nd, John Laing.

Class 5. Best octagon super.—1st, J. Pringle; 2nd, R. Greig.

Class 6. Largest harvest from one hive.—1st, J. Turnbull; 2nd, R. Greig.

Class 8.—Best 20 lbs. honey.—J. Turnbull.

Class 11. Heaviest cap of honey.—J. Pringle.

Class 13. Best 3 lbs. of beeswax.—1st, T. Thomson.

British Bee-keepers' Association silver medal—J. Turnbull; bronze medal, J. Pringle.

For the best collection of hives, &c.—Medal to T. Douglas.

BRISTOL AND DISTRICT B.K.A.

One of the prettiest shows it has been our privilege to attend for some time was held, in connexion with the above Association, on Monday, August 3rd, at Long Ashton, on the grounds of Sir Greville Smythe. A special tent was provided for the exhibits of honey and bees, and under the skilful guidance of the energetic Hon. Secretary (Mr. Brown) they were very tastefully arranged. A plentiful supply of flowers and ferns, in addition to the beautiful sections and supers of comb honey, made the tent appear really charming. The greatest credit is due to the Hon. Secretary and also the Expert, Mr. Martin, for the great pains they must have taken to arrange the exhibits in so attractive a form.

Altogether there were forty-six entries in the various classes, and each class was keenly contested. The classes for extracted honey were well filled, and most of the honey was of such fine quality that the judges found it most difficult to decide which was best. Sections were not quite up to standard mark, but one or two lots were all that could be desired. Some straw supers of honey were very fine indeed.

The awards in the various classes were as follows;—

Collection of honey in any form.—1st prize, J. Martin, Bedminster; 2nd, H. H. Tripp, Winford; 3rd, J. M. Rawbone, Kingswood.

Twelve sections of comb honey.—1st, H. H. Tripp; 2nd, W. Hemmings, Wick, near Bath; 3rd, W. Webley, Brentry; highly commended, J. Fenner, Henbury.

Twelve bottles of extracted honey.—1st, A. H. Walters, Barrow Gurney; 2nd, J. M. Rawbone; 3rd, G. Gibbons, Timsbury; highly commended, H. H. Tripp.

Super of honey in any form.—1st, H. H. Tripp; 2nd, J. M. Rawbone; 3rd and highly commended, J. J. Brittan, Bishopsworth.

Six sections of comb honey.—1st, W. Webley; 2nd, H. H. Tripp; 3rd, J. Fenner.

Collection of wax in any design.—1st, G. Lovell, Wrington; 2nd, J. J. Brittan.

The judges were the Rev. E. Davenport, of Stourport, and Mr. G. Lovell, of Wrington.

Lectures of a popular and instructive character were given during the day by the Rev. E. Davenport to very large audiences.

Under the earnest leadership of the new Hon. Secretary (Mr. Brown) and the energetic Expert (Martin) this young Society seems to have a prosperous future before it.

ULSTER BEE-KEEPERS' ASSOCIATION.

At a show of honey and appliances, held in connexion with the Armagh Show on the 15th and 16th ult., the following prizes were awarded:—

Super of honey, over 10 lbs., not sectional.—1st prize, Mrs. T. G. Peel; 2nd, W. J. Anderson.

Super of honey, 10 lbs. or under, not sectional.—1st, W. G. W. Flynn; 2nd, J. D. McNally.

Twelve 1-lb. sections.—1st, W. J. Anderson; 2nd, W. G. W. Flynn; 3rd, G. Running.

Six 1-lb. sections.—1st, W. J. Anderson; 2nd, W. G. W. Flynn.

Six 2-lb. jars of honey.—1st, Mrs. T. G. Peel; 2nd, J. Tufft.

Six 1-lb. jars of honey.—1st, J. D. McNally; 2nd, Mrs. T. G. Peel.

For the best hive for cottager's use.—1st, W. Henry; 2nd, Mrs. T. G. Peel.

For the best collection of hives and appliances.—1st, Mrs. T. G. Peel; 2nd, W. Henry.

The judge was the Rev. H. W. Lett, Loughbrickland.

IRISH BEE-KEEPERS' ASSOCIATION.

A meeting of the Committee was held on the 4th inst. Present: Rev. R. Seymour (in the chair), Rev. Canon Sadleir, Mr. Read, Mr. Gillies, and Mr. Chenevix (Hon. Sec.). Arrangements were made for providing a judge, if desired, for the show of honey and bee-appliances at Parsonstown on the 20th inst. It was resolved to hold a conversational meeting on Thursday, the 27th inst, one of the days of the Horse Show. Subscriptions from seven new members in county Meath were handed in by Mr. Seymour.

WIGTOWNSHIRE APIARIAN ASSOCIATION.

The above Association hold their eighth annual show at Stranraer on September 4th. The prize list—which is a liberal one—for honey includes nine open classes, with twenty-seven prizes, ranging from 1*l.* downwards. Only the cottagers' classes are confined to the county of Wigtownshire. For particulars see 'Bee Shows to Come' on another page.

Correspondence.

The Editors do not hold themselves responsible for the opinions expressed by correspondents. No notice will be taken of anonymous communications, and correspondents are requested to write on one side of the paper only, and give their real names and addresses, not necessarily for publication, but as a guarantee of good faith. Illustrations should be drawn on separate pieces of paper.

Communications relating to the literary department, reports of Associations, Shows, Meetings, Echoes, Queries, Books for Review, &c., must be addressed only to 'The Editors of the "British Bee Journal," 17 King William Street, Strand, London, W.C.' All business communications relating to Advertisements, &c., must be addressed to Mr. J. HUCKLE, Kings Langley, Herts (see 1st page of Advertisements).

CURE OF FOUL BROOD.

[739.] I am very glad to see that special attention is being again given to the subject of foul brood, and that there is reason to hope that naphthaline will be found to be a preventive of it, if not a cure; for as long as this vexing and destructive disease is constantly appearing amongst us, I cannot believe that much prosperity can be expected in bee-keeping; but if it could be eradicated, bee-keeping, with all the improvements of the last few years, would make rapid progress.

About five years ago it appeared badly in my apiary, just at the most undesirable time, too, viz., at the beginning of the honey-flow; but I managed to cure it by destroying the worst combs in the infected hives, and by the combined use of Cheshire's cure and salicylic acid fumigation. Since then I have not had a sign of it—although it has been in the neighbourhood—until this year, when it again appeared at the same time as before, and rapidly spread from hive to hive. What a source of annoyance and vexation it is! All one's labour seems practically thrown away; and what a serious loss too in the case of a poor cottager or person of limited means! I have asked myself repeatedly what can have been the cause of its reappearance in my apiary? Is there anything which I can have done, or left undone, which can account for it? And the only thing which I can think of is that I omitted this year to mix salicylic acid solution with the bees' spring food, whilst in other years, since its last appearance, I have not omitted it. I have always kept camphor in all my hives, renewing it—except during the winter months—constantly; but this does not seem to have had much, if any, effect. I have been trying the same means of cure as before

with the addition of naphthaline; and the disease seems decidedly checked and almost eradicated; but I do not think that it is completely eradicated, as a few cells still look very suspicious. In the case of one hive I drove all the bees out, and placed them with fresh frames in a fresh hive; but I am not yet quite sure that this is any better than others differently treated. There have been no swarms, and scarcely any honey, from the infected hives; so that, if a cure be effected, a whole season has been practically lost and a great deal of fruitless trouble involved. Heartily, therefore, should I indeed rejoice if some easily applied and certain remedy or preventive could be discovered; and if you can be the means of making known such an one, you will indeed deserve the warmest thanks of all the bee-keepers in the kingdom.

I have tried one of the new super-clearers, and find that it works admirably. This will be a great boon in the future. Have any of our friends had an opportunity of trying the swarm-cluster mentioned in your columns, p. 332? If so, will they kindly favour your readers with the result? The device seems feasible; and if it be really successful it will be a great advantage, especially to those who have not time or opportunity to watch for swarms.—A SUSSEX RECTOR.

NOTES BY THE WAY.

[740.] We have now reached a period of the year when bee-keepers in the southern part of the kingdom are able to decide as to the position the year shall take in the annals of bee-culture, and, as far as I can glean, 1891 will have to be classed amongst the poor honey seasons. There are always exceptions in all cases, and even in a poor season and district generally, there may be a few spots or oases in an otherwise sterile tract of country. In our own immediate neighbourhood this has happened. Bee-keepers of a few skeps have increased by swarming to three times their spring count, and where this has happened the early swarms are fairly heavy, while others with same number of stocks have had only one or two swarms, consequently no honey, from the simple reason they will have no hives to take up; and others, whose bees were retarded by the exceptionally cold, protracted winter and spring from building up to swarming pitch, cast late swarms. These are very light, and with after-swarms, or casts, as we term them, there will be a large percentage of queenless colonies, or drone-breeding queens, this year. This is a sequel to the continued cold, unless weather we had just at the mating-time.

I was rather surprised, though glad, to glean from August *Record* that the present season was a 'good one;' it shows how misleading district results may be when compared with the general results of the whole country, and I trust for the benefit of our craft generally that our Editor's prognostications will be realised.

The schedule of the dairy show to be held in London in October is to hand. I am glad to

find the British Dairy Farmers' Association has again held out the ungloved hand to British bee-keepers. Let us bee-keepers reciprocate the friendly feeling, and do our best to make the honey department a success. I may add that some of my best and largest customers are dairy farmers, and what trade can more fitly introduce to the public our wares than the 'dairyman?' Why, for thousands of years the two products of the cow and the bee has been inseparably connected in the term 'milk and honey.' It was held out as *the* inducement to the children of Israel to leave the fleshpots of Egypt to go up to the good land, 'a land flowing with milk and honey.' Where shall we get a lodgment for our honey where its pristine purity shall be guarded with greater care than in a dairyman's shop? Therefore, I say, let bee-keepers cultivate a trade with the 'dairy' trade. This leads on to another item on the part of the bee-keeper, and that is cleanliness.

What is there amongst the daintiest products of nature or art that can vie with a dish of honey in the comb? Hasn't it been called 'food fit for the gods?' Then I would impress on our fraternity to present the product of their apiaries in the cleanest possible state. This requires attention from the time the snow-white sections are taken from the case till the honey is placed on the counter of the retailer. First, the sections should be folded with clean hands; the crates should be rectangular and of proper dimensions, so that the sections are held square while being filled by the bees, and removed from the hive as soon as they are sealed over. Then, after removal, every little particle of propolis should be scraped off, and the sections packed away till wanted for market.

Where shall we store them? Well, that is a simple, though a wide question. Circumstances alter cases very considerably; therefore I can only generalise. The best place to store comb honey is a dry, warm room, carefully protected from dust, and if no shelf or cupboard is to hand after your crate has been thoroughly scraped and freed from wax, brace-combs, and propolis, lay a piece of clean white paper on the bottom of crate, and replace your full sections in the crate without the dividers, and then wedge them up tight. This crate can be wrapped in paper, and several stored one on the other without damage to the sections, as the edges of crates take the weight off the sections of honey.

The season for robbing will be with us shortly. When the honey fails in the fields bees have an inherent disposition to get honey, even if they rob neighbouring hives to obtain it. This must be guarded against by keeping a watchful eye on the apiary, and keeping the entrances of hives contracted for the next few weeks. This will also act as a preventive against the intrusions of wasps, which I anticipate will be numerous, and with warm weather will prove troublesome to the bee-keeper and fruit-grower. The best preventive measure we can put in force against the wasp is to destroy their nests early. Let the 'boys' know you will be ready

to accompany them on a wasp-nest exterminating expedition, and that you are willing to pay a small premium for location of each nest, and you may depend that very few nests will escape detection. The chance of a few coppers will accentuate the already lynx-eyed propensity of boys when in quest of nests.

Bee-escapes or super-clearers form the topic of last month's 'Review,' and the success of this (to us) new appliance to the apiary is very decided. Men of light and leading in America, where it is computed that over 10,000 bee-keepers own over 500 stocks of bees each, speak in terms of unqualified praise of the 'clearers.' There are several adaptations of the same principal amongst them, which seem to answer the purpose equally well, though for neatness and efficiency the 'Porter' spring escape, by which the bee when once passed out is prevented from returning to the super, apparently has most admirers, and is considered by a strong consensus of opinion to be the *perfect* escape.

The boards in which the escapes are fixed are very useful when working amongst the bees, as I have proved this season. The crate of partly filled sections can be lifted off the hive and placed on the board without crushing a bee, and it imprisons the bees while the hive is being opened for examination. These boards and the carbolised cloth are real comforts to the busy man.

I am pleased to add that our hope in 'Berks' have been realised, our County Council having voted us 50*l.* to further the cause of bee-keeping in the county. The only 'fly in the ointment' in this case was that one of our erstwhile prominent bee-keepers, and a member of the County Council, objected, but failing a seconder his motion fell through; thus, instead of support where we most expected it, we got opposition, and from a former patron of the craft. Our executive has lost no time in calling a meeting, which I was unfortunately unable to attend, though I have received notice of another meeting next week to deal with the matter of application of the money to advance the cause of bee-keeping. —W. WOODLEY, *World's End, Newbury.*

SUPER-CLEARERS.

[741.] As you ask for reports on super clearers I write to say that I have used one, which I bought from Mr. Flood, of Reading, with perfect success on five hives. It is one through which the bees descend into the hive. By putting the clearer on over-night, I find the sections nearly clear of bees in the morning. I then remove the super, taking it indoors, and there I take out the completely finished sections, re-arrange those unsealed and only partially filled, and fill up the vacant spaces with empty sections. The super then goes back to the hive, after lifting off the clearer. The sections which I took were all in perfect order.

The only difficulty which the most inexperienced person would have is in first of all taking off the super. It is also necessary to be careful

that the clearer does not stick to the super when you are about to take it away in the morning. It appears to me that the use of this 'clearer' is a better plan for an amateur than putting a second super below the first one when the latter is nearly filled. When you have got about a dozen sections finished why not remove them at once by means of the 'clearer?'—PURBECK, Dorset.

SUPER-CLEARERS—WAX EXTRACTING.

[742.] Perhaps at this present time when supers are ready for removal it may be of use to many to know how to make a cheap super-clearer. For years I have occasionally used a narrow cylinder of perforated zinc stuck in the bottom of a box, which latter is inverted over a section case, for getting bees out of single boxes of sections; but I found the process inconvenient where many section crates were in use, as it required so many boxes that I preferred a sheet spread over about four crates at a time, which had to be continually turned.

This, again, was a cause of considerable trouble. The cylinder of perforated zinc was recommended by Mr. Abbott years ago in the *Journal*, so that he can claim any priority of invention in it.

Taking the hint from a late number of the *Journal* I have been taking off my crates, then slipping a quilt between them and the body of hive, and then returning crate on the top of new quilt, and standing a cylinder five inches high by two and a half diameter of perforated zinc on the top of crate, over the hole, which nearly every one has for feeding purposes, in the quilt raised to let the bees escape. I have tried it on ten section crates and two upper body-boxes, and with the most complete success. In several cases there was literally not a bee left. The whole thing is done quietly and expeditiously. It takes about four hours on the average to clear the sections. Make the cylinder by just rolling the zinc, round without soldering, &c.

About five years since I tried an ordinary milk sile (strainer) for wax-extracting, and found I got a very fine quality of wax from the process. Fill the milk sile with broken wax which stand in a tin canister with a little water in the bottom and put all into the oven. It is not necessary to grease the sides of canister as the wax falls out when cold. As most cooks object to their ovens being used for the purpose, I have been trying an ordinary copper in outbuilding with the best results, standing the canister with strainer on top on two bricks at the bottom of copper, with enough water to about come up to the top of bricks. I keep four or five canisters going in this way, and the wax is of very good quality when extracted by this plan, which is much cleaner than boiling in a sack, and is more satisfactory in many ways than the ordinary wax extractor, which I have tried and found wanting. Perhaps some of the above hints may interest and be of

use to your readers.—ARTHUR J. H. WOOD
Bellwood, Ripon, August 7th.

[We cannot think our correspondent has clearly or fully described his mode of procedure in clearing sections, otherwise his plan does not appear at all a good one. Given the top surface of an ordinary rack of sections, it is obvious that to compel the bees to escape through the feed-hole in a quilt which covers the whole upper surface, and allows egress only through a small opening in the centre row, is to make their escape from that row as slow as possible, and to prevent escape from the two outside rows altogether unless four bee-way sections are used. Moreover we consider that when surplus chambers are being ridden of bees while on the hives by means of cone clearers, it is most important that no robber-bees have access to the inside of the roof. We must, therefore, caution readers against causing trouble by neglecting this point.—EDS.]

THE BEE-SEASON IN THE NORTH.

A GOOD REPORT.

[743.] Come a little further North, and you will find the weather has been very favourable to the little busy bee. Every one here and for miles around are getting plenty of white honey, and all going to the moors on August 8th in good heart and with a splendid prospect. I never saw the bee-keepers in better form.

White honey is cheap (6d. per pound) I hear at Rothbury. I knew it would be a drug this year. Swarms at some apiaries are plentiful; others, perhaps, a few yards away, none—very singular every way.

Ulgham records fifteen swarms from four stocks, and all have done well. At Lyne, Cresswell (sixty yards from seashore)—all have swarmed and done well, taking sections off weeks ago. Ellington—bees are in fine order with those who have managed them right. Longhirst has also done well. Bee-keepers are A1—clean, natty, and sharp in all their bee-business.

I think the men of Longhirst have first claim to the County Council lecturer (when he comes) (?), and we may some day have a county society here for it. Cragend, adjoining Cragside, is a splendid place for bees; indeed, I don't think there is a place this year around here where bees have done badly. Wishing everybody a plentiful heather harvest,—CARBON *Ashington, Morpeth.*

BEE-KEEPING IN THE MOUNTAINS.

[744.] We have returned from Alleverd, where we spent three weeks, and I followed the cure for my throat most conscientiously. Alleverd is a lovely place betwixt Chambéry and Grenoble. What flowers in the hay, and yet hardly any bees at all! I talked well about it to the peasants. Then we came here a week ago. Such a nice, clean, well-kept *pension*. It is on the slopes of the Moleson—not far up, only three-quarters of an hour from the Château de Gruyère. The day before yesterday I

visited an apiary I saw in passing. Such a fine one! Some 100 hives; but all with enormous lumbering frames—Dadant—weighing some ten pounds when full, and to be lifted sideways! I was so taken in. They gave me *wine*, and behold it was hydromel! They send their bees up the Moleson, and above Monbovon, &c., but this mountain honey has a dark colour—due, I fancy, to the pine-trees. What a bad year we have had, or are having! Such a promise in spring, and then rain when the apple-bloom was out, and on every other day. I may get 200 pounds this year instead of 432 last year, but I only count four hives. The fifth is a new swarm—which I have supered, however—and if they finish the sections I shall be mightily pleased.—A. F. BUSCARLET, *Mont Barry, July 25th.*

ON THE WAY TO THE MOORS.

[745.] I think after carefully reading the South of England notes and your own 'Useful Hints,' I might say that the North of England bee-keepers might be well proud of their having had such a plentiful clover harvest and good prospect for the heather. I am writing this on August 7th, and having got all ready, hope to make a start for the moors to-morrow night at nine o'clock. We travel about twenty miles, and at the Weldon Bridge Hotel there will be seen carts and carts of bees which have come in during the night. After a short rest at the hotel for refreshment, and the usual 'eraek' over our good luck this year, there will be a dividing off on resuming the journey—some going to Crag End Ling; others to Framlington Gate, and some to Rough Castle. I can say it is a most joyous trip, everybody in full glee, and hoping to bring home much heavier loads than we start with.—JOHN WILKINSON, *Morpeth.*

HONEY AT THE DAIRY SHOW.

[746.] I have just received the schedule of prizes for honey, &c., at the above show, but am sorry to see there is no class for granulated honey. I think that instead of two classes for comb honey there should have been one for granulated. It is very important at that time of the year when most of the best honey will be granulated to have a class for the latter. If there could be an extra class added now I would willingly subscribe towards it.—A. J. CARTER, *Billingshurst.*

Queries and Replies.

[395.] *Chloroforming and Driving Bees.*—1. Your correspondents nearly all write of driving condemned bees in the evening. Can it not be done just as well at any other time if an empty skep is put to receive those bees returning from the fields? 2. Would not stupefying the bees

of condemned stocks with chloroform where they stand be easier than either driving or bumping? I presume when stupefied they would fall down on the floor-board, and when in that state two or three lots could easily be swept together into a swarm-box with perforated zinc sides, and when they had recovered be put into a hive furnished with combs, and fed up for the winter.—EAST KENT.

REPLY.—1. Bees may be driven at any hour of the day when they are flying, and so far from evening being the best time, there are many disadvantages in doing it at that time. 2. Some bee-masters do use chloroform, but it requires careful hands and some knowledge of the drug, otherwise harm might follow. Besides, driving is in itself so simple an operation that it will always be preferred.

[396.] I should like some information—1. As to the making of lath quilts for hives, as mentioned in *B. J.* 2. Also, how may I best keep bee candy from turning soft? I have some left over, and hope it may remain good till wanted next spring. 3. I have a hive which I believe to be without a queen. The bees are pretty numerous, and have been carrying pollen during the summer, but they are in much less force than two other hives which stand beside them. Can I do anything to improve them?—AMATEUR, *Taunton.*

REPLY.—1. There is no 'making' required. The laths are simply laid close together on the top bars. 2. The difficulty usually is to keep candy from becoming hard. However, if it goes soft it may be boiled up again for use. 3. If the hive is really queenless there is no remedy but re-queening; if it has a queen, and her being old is the cause of the weakness, her removal will be necessary.

[397.] *Foul Brood and Driven Bees.*—In former years I have been very successful in my bee-keeping; this season I have not. In the autumn I drummed bees from several of my neighbours' skeps, removed the old queens from my own hives, and put in bees and queens of parent hives which had swarmed and second swarms, feeding up with syrup in cases I thought needful, and, as I thought, had all six hives in capital order. Several days after I looked and found that all the queens were laying, and so felt satisfied. In the spring (April) I found one hive queenless, one very weak; three weak, and one fairly strong. I uncapped honey, thinking to get them made strong before the honey came, but up till now I have not got any of them to commence the sections, though I had several crates filled with nice fresh combs drawn out last year. The very weak one dwindled down, so now I have only four, and although they all appear to be getting stronger in bees, I am sure there is something wrong, and I suspect foul brood in one that I found fairly strong in spring. The others I am satisfied are only weak. I send by to-day's post a piece of comb, the worst piece I could see in the hive,

and will feel obliged by your giving me your opinion of it, and advising me what to do. Is it possible for the number of bees to be increasing if foul brood is very bad in a hive? There is a peculiar small in the hive, but it is not particularly offensive.—W. S.

REPLY.—Comb sent is about as bad as it well can be with foul brood. It is to be feared that you have introduced it with the driven bees last autumn. For the sake of your other stocks we advise a removal of the bees from the frames into a straw skep, and the immediate destruction of the combs and frames, together with a thorough fumigation of the hive by means of burning sulphur fumes. If the bees are given full sheets of foundation, and are well fed on medicated syrup, they will stand a good chance of freeing themselves of the disease; but if the trouble involved is considered too great, destroy the stock by burning the lot.

[398.] *Completing Unfinished Sections.*—1. What am I to do with partly filled one-pound sections of honey? Will it keep till next year? 2. I have two crates partly filled on the hive now. Had I better reduce the number to one crate? Even then there will be a number left not filled and sealed. 3. I have queen-excluder on all my hives. Would you leave it on when closed down for the winter? 4. Is it true that as much honey can be had from one strong colony as from several weak ones? I have only one, but I have taken about forty pounds of honey from it. 5. Is that a good average?—MARTIN HY. TROTTER, *Coleford, Glos.*

REPLY.—1. Honey in partly filled sections will not keep till next year. It will probably ferment, and will certainly granulate. It should either be extracted or given to the bees to clear out. 2. Yes; reduce to one crate and wrap warmly, in the hope the bees may be able to complete them. 3. Don't leave the excluder on all winter. Dampness may cause the zinc to oxidise, and oxide of zinc is poison. 4. Quite true. 5. A very fair average.

[399.] *Second Swarms supposed Queenless.*—I hived two second swarms on the 22nd and 23rd of last month, and fear that both are queenless, as I cannot find their queens, nor any eggs nor young brood. There are plenty of bees in both hives, and both have been driving out their drones most viciously. I found nine dead drones in front of one of these hives yesterday. Would you advise me to purchase and introduce two new queens? It is too late to give them a frame of eggs, as all the hives are driving out their drones.—BEESWING, *August 8th, 1891.*

REPLY.—The fact of drones being destroyed makes it very unlikely that the swarms are queenless. Feed gently for a few days, and then examine closely, when eggs will probably be found. You can purchase queens a month hence if your fears prove right.

Bee Shows to Come.

August 19th.—Wilts B.K.A., in connexion with the Swindon Horticultural Fête. Entries close August 14th. W. E. Burkitt, *Buttermere Rectory, Hungerford.*

August 19th, 20th.—Shropshire B.K. Association at the Quarry, *Shrewsbury.* 35l. in prizes. For list apply to T. Whittingham, *Water Lane, Shrewsbury.*

August 20th.—Forfar B.K.S. at Forfar. James Hutchinson, Secretary, *Yeaman Street.*

September 2nd and 3rd.—Lancashire and Cheshire B.K.A. at Birkenhead. Entries close August 15th. For schedules apply Arthur H. Edwardson, 28 *Hamilton Street, Birkenhead.* Liberal prize list open to all comers.

September 4th, at Stranraer, *Wigtownshire Apian Association.* Entries close September 2nd. Apply for schedules, J. B. Robertson, Hon. Sec., *The Manse, Leswalt.*

Sept. 5th.—Alderley Edge and District Branch of the Lancashire and Cheshire B.K.A. *Chelford Flower Show, Astle, Chelford.* Schedules, &c., T. D. Schofield, *Alderley Edge, Cheshire.*

Sept. 5th.—Bramhall and Woodford District Horticultural Society at Bramhall Hall, near *Stockport.* Entries close August 22nd. Particulars of William Slater, *Fern Lea, Bramhall, Stockport.*

Sept. 9th, 10th.—Derbyshire Bee-keepers' Association at Derby. Entries close August 27th. W. T. Atkins, Sec., 12 *North Street, Derby.*

WEATHER REPORTS.

WESTBOURNE, SUSSEX.—*July, 1891.*

Maximum, 73° on 26th.	Rain:—2.39 inches.
Minimum, 42° on 28th.	Heaviest fall, .65 on 26th.
Mean max. 65°	Rain on 19 days.
„ min. 51°	Average, 2.55 inches.
„ temp. 58.3°	Sunshine, 192.45 hours.
	Brightest day, 16th, 13.9.
	Sunless days, 0.

Remarks.—A good deal of honey was gathered in the first half of the month, but very little in the last fortnight. Limes a partial failure. Quality of honey excellent, but quantity far below 1889.—L. B. BIRKETT.

BUCKNALL, LINCOLN. B.M. 25.—*July, 1891.*

Max., 74° on 10th,	Rain:—2.55 inches.
13th, 18th inst.	Average, 5 years, 2.47.
Minimum, 36° on 25th.	In 24 hrs. .44 on 22nd.
Mean Max . . . 68.4°	Rain on 21 days.
„ min. 47.38°	Frost on grass, 25th.
„ temp. 57.8°	Range, 21.1°.
„ of 5 years 58.5°	

Remarks.—The month has been dull and showery, giving little honey. The honey season is but little in advance of last year.—J. BINT.

Notices to Correspondents and Inquirers.

WM. BROWN (Selkirk).—Dead bee sent is too dry for microscopical examination. There is no reason for suspecting that the queen is diseased. She may have been injured in some way while you have been examining the hive. Examine the combs and see if queen-cells are being raised.

L. A.—Comb sent is foul-broody.

J. B. (Shrewsbury).—No. 1 is one of the common Scotch thistles, and is in no way akin to the Chapman honey-plant. Neither Nos. 1 or 2 are of any perceptible value as bee-plants.

WM. CLARKE (co. Kilkenny).—*Removing Supers.*—By using super-clearers little or no excitement is caused, and if carefully done there need be no stinging of your visitors. If the supers are left on till autumn most of the contents will probably be carried into the hive below. Uniting may be done any time next month.

COLIN (Sheffield).—*Extracting Heather Honey.*—Heather honey can only be removed from the combs by pressure, and that, of course, destroys them.

WILSON RITSON (Pickering).—*Moving Bees Sixty Miles.*—It will not be safe to move bees over a rough hilly journey of that length till cool weather sets in, or unless an experienced person could pack and prepare them for the journey.

C. G. W. (Mosshead).—*Extracted Honey for Showing.*—It must be carefully strained through very fine muslin or flannel, be perfectly free from any impurities or wax chippings, besides being of good colour, flavour, and consistency.

A NEW BEGINNER (Crake Valley).—Twenty-one days after the issue of the top swarm is the proper time for driving bees from a skep for transference to a frame hive. The evening of a warm day is a suitable time for operating.

H. B. (Winchester).—Casting out drones pretty clearly indicates that the queen is there.

W. HARLAND (Sunderland).—Yates, Seedsman Deansgate. No stamp was enclosed for reply.

T. J. ATKINS (Swanscombe).—There will be some danger in moving a May swarm twenty miles by rail; better leave them till the weather is cooler. Early in September is the best time for transferring bees from skeps to frame hives.

W. P. DAVIES (Aberdare).—Mr. W. Drinkall, Horseshoe Corner, Lancaster, will, no doubt, give you the information asked for if applied to.

H. H. H. (Waterford).—Rhododendrons, if grown in large quantities, are known to be bad for bees. The honey from them is also bad.

Report of Notts B. K. A. Show at Beeston, and several Replies to Queries, are crowded out and will appear next week,

BALDWIN'S

is the Oldest Establishment in the United Kingdom wholly devoted to Bees and manufacture of Bee-keepers' supplies. His prices will compare most favourably with those of any other Maker, while for quality of material, suitability and workmanship, he has no rival.

'Why can he give better value for money than others?' Because he spends less in large 'puffing' advertisements, buys in the best markets for prompt cash, has no rent to pay, and personally conducts his own business.

For prices and full particulars of Goods see Baldwin's Bee-keepers' Instructor (and Illustrated Catalogue combined), which 'contains more practical and reliable hints than all the large, expensive books,' post free for 2d. stamps. Address S. J. BALDWIN, The Apiary, Bromley, Kent. N.B.—More than 500 Silver and Bronze Medals, First and other Prizes, and Testimonials innumerable.

FOUL BROOD.

FORMIC ACID.—Draper's 'B' brand. Guaranteed pure. As used and recommended by Mr. Sproule in *Bee Journal*. Stopped bottles, 1 lb., 3s. 6d.; 4 lbs., 11s. 6d., post free. Address EDMONDSON BROS., Bee Appliance Warehouse, 10 Dame Street, Dublin. 246

ON HIRE, BEE TENT.—For Terms apply to A. J. BROWN, Hon. Sec., Bradley, Wotton-under-Edge, Gloucester. 238

WOOD BEE FEEDERS.—Hold 2 lbs. Syrup, 6d. each, by post, 6d. extra; 5s. per dozen on rail. Address J. M. BALDRA, East Parade, Alnwick. 2920

MODERN BEE-KEEPING. New Edition. Post free, 7d. The most useful Guide for Cottagers and others commencing to keep bees. Nearly 50,000 already sold.

JOHN HUCKLE, Kings Langley, Herts.

British Bee Journal and Bee-keepers' Record.

OFFICE:

17 KING WILLIAM STREET, STRAND, LONDON, W.C.

PURE CANE SUGARS.

For the accommodation of Bee-keepers, guaranteed Pure Cane Sugar will be supplied in large or small quantities through this office at the under-mentioned rates:—

CRYSTALLISED.

4. DEMERARA	} Neat bags, 14-lbs. 2s. 3-lbs. 5s. 6-lbs. Cwts.	
5. BARBADOS		} Crystals 2/9 5/4 10/6 20/6
6. TRINIDAD		

REFINED CANE.

7. WHITE CRYSTALS (Small)	3/0	5/10	11/6	22/6
8, 9. (Medium and Large sizes, 1/- per Cwt. extra.)				
10. LUMP (Cwt. Loaf) ... Boxes,	3/3	6/3	12/3	23/6
11. LUMP DUST ...	3/0	6/0	11/9	22/9

All above guaranteed made from CANE SUGAR only, and free from BEET, CHEMICALS, etc., etc.

CARRIAGE PAID on Orders over 5/0 (or 28-lbs. Sugar) to London and Suburbs.

COUNTRY ORDERS, not less than 2-cwt. carriage paid at 1/0 per cwt. extra.

(Scotch and Irish orders, special arrangements.)

Cash to be sent with order, and purchasers will please observe that if samples are required or replies asked to inquiries, a stamped addressed envelope must be sent, as we cannot undertake cost of postage.

THE British Bee Journal,

BEE-KEEPERS' RECORD AND ADVISER.

No. 478. Vol. XIX. N.S. 86.]

AUGUST 20, 1891.

[Published Wee

Editorial, Notices, &c.

USEFUL HINTS.

WEATHER.—Bee-keepers in the south have had much the best of it in regard to weather during the past ten days; indeed, for a week or more prior to the date of writing (18th) it has been beautifully fine and warm in our part of Kent. Bees have been kept unusually busy for the time of year, the white clover plant having grown so well after the rains of a few weeks ago that quite an abnormal show of late bloom was available for honey-gathering. We never remember a year in which this queen of bee-flowers has bloomed so continuously, and, instead of the usual fortnight or three weeks when bees can gather clover honey, they have had forty or fifty days on which more or less gathering was done. This accounts for the very high quality of the extracted honey staged at later shows. Now comes what is to us quite a new source of supply in shape of many acres of land hereabouts red with the bloom of the kidney bean, grown for the London market. The honey from it is not of very good quality, but it must save the bee-keepers of Kent a lot of autumn feeding; at all events, we confidently look for that desirable result in our own case, for brood chambers are filling nicely, and not an ounce of honey will be taken from them, no matter how heavy they become.

SUPER-CLEARERS.—We have given both types of these a full trial in removing surplus honey, and find that each has its special merits under special conditions, while either can be made to answer the purpose very well if handled properly. If the weather is warm, and bees are flying freely, the cone-shaped clearer works admirably, care being taken to stop up all ventilating holes in roofs, save those on which the cones are fixed. We used two

cones on each roof, and, as our hives have outer cases, the front only of each surplus chamber fits close to the outer case and roof, therefore the bees have free travelling way to the light passing in through the cones, and all march that way to escape. We thought it might be an improvement if a small inner cone was fixed over the ventilation hole, through which the bees would pass into the larger cone, and thence to the outside. The inner cone would prevent bees from re-entering the roof-part after once passing through, as some are prone to do when robber-bees about the cones cause them to be a little less disposed to desert their stores. This, however, is a matter for future trial, as we had no time to put the idea into shape, and if hive-roofs fit close, allowing no bees to enter from the outside while the cone-clearer is at work, and weather is suitable, no further outlay need be incurred than the few coppers they cost.

On the other hand, the American type of clearer, or 'bee-escape'—of which the 'Webster' and the more recent 'Flood' clearers are the English prototypes—are quite superior to the cones in some points and under certain conditions. For instance, they entirely do away with the smallest 'upset' among the bees in the apiary. Once the clearer is fixed in position, the bees leave the surplus chamber without any visible sign outside of what is going on. It generally took a few hours of the day following the evening on which the clearers were put on to get all the bees out, and we found our 'ekes' fixed below the clearer very useful when clearing several surplus chambers at a time. Indeed, without these 'ekes' the bees could not have well found room below. Again, if weather is dull and wet, the latter form of clearer is far superior to the cone-shaped one. So that, looking at the whole question, it may be said that the simple cone-clearer in itself is very good, and will work all right, but it is well worth investing half-a-crown or so in one of the Anglo-American type. What into-

rests us is the fact that a distinct step forward is made in bee-management by the introduction of these handy appliances, and many a weary and troublesome hour will be saved to the bee-keeper by their use.

REMEDIES FOR AND PREVENTIVES AGAINST FOUL BROOD.—We wonder how it is that there are still bee-keepers who go on from year to year preparing syrup for winter feeding and never think of medicating it, or of using anything by way of preventive against foul brood. It seems to us gross carelessness to neglect taking precautions when stocks are known to be quite healthy, but when there is the least suspicion of disease it is nothing short of folly; besides, the expense and trouble involved are now reduced to a minimum, and there is no reason in the world why every pint of food given to bees this autumn should not be medicated with salicylic acid or other remedy, and a small portion of *naphthaline* dropped into every healthy hive in the kingdom. If this were done with all healthy colonies there would be a considerable reduction in the number of foul-broody hives next spring. We cannot rid bees of their predatory habits in autumn, and when robber-bees are on the rampage they have a fatal propensity for rooting out diseased colonies for plundering. On the other hand, when treating known cases of foul brood, salicylic acid has proved quite ineffectual as a means of cure when given in food to stocks known to be diseased; and, in consequence, we must urge the use of a more powerful remedy. We have considerable confidence in the two remedies to which the attention of readers has been directed in the pages of the *B. J.*, viz., *Naphthol Beta* in the food, and *naphthaline* in the hive. So far as our own experiments have gone, either of these when introduced into the cultivating medium stop the growth of the dreaded spores or germs very unmistakably. Hence we view with much interest the recently displayed anxiety to give them a trial, and hope for the best results therefrom.

ROBBING.—We must again refer to this annual trouble to the bee-keeper, and once more urge him to stop it in time, or, at all events, to be beforehand with all his precautions. Entrances must be narrowed at once, and in a week or so reduced again, and still again if trouble threaten. In no case would we leave entrances full width during the late autumn.

DEATH FROM ARSENICAL POISONING.

WARNING TO HOUSEHOLDERS.

We regret to have to announce the death of Mr. Hugh Clement, of Oakleigh House, Walberton, Sussex, which took place on the 31st July last. Mr. Clement was a bee-keeper of long standing, and kept bees formerly in straw skeps. We were fortunate enough to persuade Mr. Clement to take to frame hives so long ago as 1872, and from that date his success as a honey-producer commenced. He was before that time satisfied if he got ten to twenty pounds from a skep, but as soon as he took to the improved methods his takings of comb honey so increased that he was induced to go in for bees on a large scale, and had as many as between fifty and sixty hives, and frequently more.

Although he was not an exhibitor, his honey was well known in the Brighton shop-windows, and being in a peculiarly favourable district, it was always a good colour and consistency, and realised good prices.

Mr. Clement was seventy-six years of age, and had enjoyed generally very good health. His death is attributed to arsenical poisoning. It appears that two years ago a bright crimson druggot was put down, and it was found that, although the family enjoyed good health before and during periods when they were absent from the house, a return always produced sickness. The sanitary condition of the house being all that could be desired, it was difficult to account for this inability to remain healthy under its roof. Mr. Clement was really ill only for a few days, and his medical attendant pronounced the symptoms those of arsenical poisoning, his daughter and a servant being also ill from the same cause.

At the inquest the doctor stated that arsenic was frequently used in crimson dyes, and that it was a cumulative poison. He had no doubt the constant tramping over the druggot on the stairs and landings detached small particles containing arsenic, and that the inmates had been constantly inhaling this for the past two years. The inquest was adjourned, pending the analysis of the druggot and wall-papers, which were also suspected. Mr. Clement, who was much respected in the neighbourhood, will be greatly missed in Walberton. Miss Clement and the servant have been removed from the house, and it is hoped will recover in time.

BEE SHOWS TO COME.

We invite attention to the several bee and honey shows arranged to take place within the next few weeks, and hope that our readers will show their interest in a practical way by entering their produce for competition. There has been no lack of visitors at the shows already held, and those in the more southerly counties are now about over. But several important fixtures in the north are still 'to come.' First there is the Shropshire B. K. A., held to-day (20th) and to-morrow, in connexion with the

popular annual *fête* in the famous 'Quarry' at Shrewsbury. Following this we are glad to note that the Staffordshire Bee-keepers' Association, which, owing to the bad honey season, was unable to hold its annual show last year, has arranged with the Staffordshire Agricultural Society for an exhibition to take place in connexion with that Society's show at Leek on August 20th and 21st. It is hoped there will be a good entry of honey, &c., for the various prizes offered. Then, taking a long flight northwards, comes the Forfar B.K. Society at Forfar, on the 29th inst. Next on the list is the important show of the Lancashire and Cheshire B.K.A., held in connexion with the Wirral Agricultural Society at Birkenhead. A liberal prize list is here offered in competition to all comers, and we trust that southern bee-keepers, many of whom have secured honey of exceptionally good quality this year, will be represented thereat. The Wigtownshire Apian Association show on the 4th September we noticed last week. For the Derbyshire B.K.A. show at Derby on September 9th and 10th, which also promises to be a good show, entries can be made up the 27th inst. The final exhibition of the year is that of the B.B.K.A., held in connexion with the Dairy Show at the Agricultural Hall, London, and we have no doubt the liberal prizes offered will bring together a good number of the winning exhibits from previous shows; in this respect giving the competition something of that national character desired for it by some of our readers. Taken altogether, bee-shows of the present year have been very successful, both from an exhibitor's and visitor's point. The interest everywhere has been well maintained, and much done towards popularising the pursuit.

CO-OPERATIVE BEE-KEEPERS AT THE CRYSTAL PALACE.

An enormous gathering, computed at about 40,000, of Co-operators and their friends took place at the Crystal Palace on Saturday last on the occasion of the fourth annual festival of the various Co-operative Societies of the United Kingdom. One of the chief attractions was the horticultural and flower show, the extent of which may be judged from the number of exhibits staged, which reached well on to 5000, the whole of which were displayed on tables extending about half a mile in length, if ranged in a straight line. A special feature of this department was the honey show, the produce of bee-keepers who are also co-operators. One might be excused for half expecting to see some tinge of amateurishness in the exhibits of bee-keepers who are also bound to be co-operators as well. A very brief glance, however, at the tables would remove the impression if it existed, for not only were some well-known bee-keepers represented, but the quality of the produce in some of the classes was as fine as any we have seen this year. The class

for twelve pounds extracted honey was certainly the best we have seen so far this season, some capital exhibits being reluctantly passed over for lack of prizes to award. A very excellent lot of exhibits were also shown in the collections of honey-producing flowers. Taken altogether the honey staged was most creditable to all concerned, and had it been staged on raised shelving instead of ordinary tables, a capital exhibit would have been formed. We hope to see this improvement effected next year. Messrs. J. M. Hooker and W. Broughton Carr officiated as judges, and the awards were as follows:—

For the best exhibit of comb honey, not to exceed 30 lbs.—1st, L. Bailey, Horsham; 2nd, W. Debnam, Chelmsford; 3rd, T. Duncan, Horsham; 4th, H. W. Seymour, Henley-on-Thames; highly commended, E. E. Smith, Gravesend.

For the best extracted honey, not to exceed 30 lbs.—1st, W. Debnam; 2nd, S. Bailey; 3rd, J. T. Chater, Croydon; 4th, H. W. Seymour; highly commended, T. Badcock, Gravesend; commended, J. Marten.

For the best twelve 1-lb. sections.—1st, S. Bailey; 2nd, W. Debnam; 3rd, H. W. Seymour; 4th, Mr. Christie-Miller; 5th, Mr. Portman, Alcester; highly commended, T. Badcock; commended, E. E. Smith.

For the best twelve 1-lb. jars of extracted honey.—1st, H. W. Seymour; 2nd, T. Badcock; 3rd, S. Bailey; 4th, W. Debnam; 5th, W. Nott, Radlet; highly commended, E. E. Smith; G. Cole, Braintree; and H. Etheridge, Horsham.

Granulated honey, twelve 1-lb. bottles.—1st, E. E. Smith; 2nd, H. W. Seymour; 3rd, T. Duncan; 4th, J. Swain, Malton; 5th, T. Badcock.

British wax from exhibitors' own hive.—1st, T. Badcock; 2nd, W. Debnam; 3rd, T. Duncan; highly commended, S. Bailey; H. Etheridge, Horsham; E. E. Smith; and G. Cole, Braintree.

Prize for best collection of honey-producing flowers.—1st, C. Osman; 2nd, H. Cole, Chislehurst; 3rd, T. Badcock; highly commended, W. Nott; commended, E. E. Smith.

NOTTINGHAMSHIRE B.K. ASSOCIATION.

The above Association, besides its annual show in connexion with the Nottinghamshire Agricultural Society, holds several other exhibitions in connexion with local horticultural and agricultural societies. One of these took place on Bank Holiday, August 3rd, in conjunction with the Beeston Horticultural Society. The morning opened fine, but during the afternoon rain came down in torrents. Notwithstanding this, a fair number of visitors attended the show, the bee and honey-tent coming in for a large share of attention.

Class 1. *Best twelve sections of comb honey.*—This class does not appear to be worked to any great extent by the bee-keepers in Notts, and

only four exhibits were staged, and though each received a prize, there was a keen competition before the awards were made as follows:—First prize, Mrs. Hind; second, Mr. R. Merrick; third, Mr. Measures; fourth, Mr. Pett.

Class 2. *Best twelve 1-lb. jars of extracted honey.*—Fourteen exhibits were staged in this class, all of exceptionally good colour and flavour. A few of the exhibits lacked consistency, owing, no doubt, to the honey being extracted before it was sealed. Mrs. Hind again took first prize; second, Mr. J. Wilson (winner of the silver medal at the county show); third, Mr. Raven, of Bridgeford; fourth, Mr. J. R. Swift, Arnold.

Class 3. *Best observatory hive stocked with bees and their queen.*—Four hives were shown in this class, and were a source of much interest to the visitors, who appeared very anxious to catch a glimpse of the 'queen.' Mr. J. Clarke, of Loscoe, was first with a splendid exhibit stocked with Carniolans, Messrs. R. W. Pett and F. C. Piggin being placed equal second.

Class 4. *Best exhibit of beeswax.*—First, Mr. J. Wilson; second, Mr. H. J. Raven.

Taken altogether, the show was in every way a success, and the stewards, Messrs. Bowler and Bigguley, had bestowed every care in staging the exhibits to the best advantage.

GLAMORGANSHIRE B.K.A. ANNUAL SHOW.

The above show was held in connexion with the Glamorganshire Agricultural Society's exhibition at Merthyr Tydfil on Wednesday and Thursday, July 29th and 30th. A quantity of honey was staged. Comb honey, with the exception of the sections shown by Messrs. James Lewis and E. J. Gibbins, was below the average; but extracted honey was very good. Mr. Gay manipulated in the bee-tent, and great crowds collected to see the manipulations, and were evidently greatly interested.

The following is the prize list:—

Twelve 1-lb. sections.—1st prize, A. H. Sims; 2nd, W. Gay.

Twelve 1-lb. jars extracted honey.—1st, John Morgan; 2nd, A. H. Sims; 3rd, E. J. Gibbins.

Members only.

Twenty-four 1-lb. jars extracted honey.—1st, J. Morgan; 2nd, E. J. Gibbins; 3rd, W. Gay.

Twelve 1-lb. sections.—1st, James Lewis; 2nd, E. J. Gibbins; 3rd, W. Gay.

Twelve 1-lb. jars extracted honey.—1st, J. Morgan; 2nd, E. J. Gibbins; 3rd, W. Gay.

BUCKINGHAM AND DISTRICT B.K.A.

The annual honey show of the Buckingham and District Bee-keepers' Association was held on August 3rd in connexion with the Horticultural Show at Stowe. There was a very large exhibit, and the competition was keen,

the judges having no little difficulty in making the awards.

PRIZE LIST.

For the best twelve 1-lb. sections.—1st prize, with silver medal, Mr. G. Winterburn; 2nd, Mr. E. J. Ridge; 3rd, Mr. W. Sturdy.

For the best six 1-lb. sections.—1st, with certificate, Mr. Woodman; 2nd, Mr. Sturdy; 3rd, Sir Harry Verney.

For the best 12 lbs. extracted honey, in glass bottles.—1st, Mr. Woodman; 2nd, Mr. E. J. Ridge; 3rd, Mr. G. Winterburn.

For the best 6 lbs. extracted honey in glass bottles containing 1 lb. each.—1st, Mr. G. Winterburn; 2nd, Mr. J. Pollard; 3rd, Mr. T. Pollard.

For the best glass super.—1st, Mr. G. Winterburn; 2nd, Mr. E. G. White; 3rd, Mr. J. Pollard.

For the best twelve 1-lb. sections.—1st, Mr. W. Sturdy; 2nd, Mr. G. Winterburn; 3rd, Mr. E. J. Ridge.

For the best 12 lbs. extracted honey in glass bottles containing 1 lb. or 2 lbs. each.—1st, Mr. E. J. Ridge; 2nd, Mr. T. Pollard; 3rd, Mr. G. Winterburn.

PREVENTING SWARMING.

We have repeatedly found that the cutting of the queen-cells when the colony is preparing to swarm has very little effect on them, for the reason that they start new ones, and if crossed in their purpose will even swarm with only eggs or young larvae in the queen-cells newly built.

If we return the swarm forty-eight hours after swarming, the queen-cells have been destroyed by the young queen, and the bees get rid of her or of the old one when the swarm is returned, the swarming fever being usually over by that time. If the young queen is not yet hatched when the swarm is returned, the old queen usually goes about the work of destroying all queen-cells herself. We do not know but that it would be safest to destroy all queen-cells before returning the swarm; but this should be attended to only a few hours before the returning of the swarm, or it will be done to no purpose, as the bees have eggs and larvae at hand from which they can raise new queens without end.

Our aim has always been to take the shortest way of arriving at our purpose, and we will repeat that we have found out two things: 1. Destroying the queen-cells to prevent swarming will avail nothing unless the season proves also unfavourable to the swarming fever, as the bees at once rebuild new ones in the place of those that we have destroyed. 2. After the colony has swarmed it is sufficient to return the swarm after two days, to ensure the destruction of the cells, or of the young hatched queen or of the old queen, at the bees' choice, except, perhaps, in isolated cases which are exceptions to the rule.

Another objection that we have to destroying the queen-cells in any case is the difficulty of making sure of having found every one of them.

As a matter of course, with a great deal of attention a bee-keeper can make sure of that; but it is hardly necessary to tell the reader that during the swarming season a bee-keeper has his hands full, even if he does not run a farm and a bee-supply shop besides.

The words 'swarming fever' which we have used in the above are well known to practical bee-keepers. This term has been used by the old masters, and very fitly describes the condition of the bees when they make preparations for swarming. These remarks are not intended for old bee-keepers, but beginners who read these pages. When the bees have the swarming fever they have no rest till they succeed. We have divided a colony into three artificial swarms while they were making preparations for swarming, and each of these swarms sent forth another swarm. It is this excitement which makes all attempts at prevention so futile on the part of the bee-keeper, unless the weather becomes unfavourable. But when the colony has swarmed, this excitement promptly goes down, unless they are still crowded and ill at ease, and for that reason the returning of the swarm is more likely to be successful, especially if the apiarist takes pains to give more room, more ventilation, and more shade, at this time. This rule is not infallible, but it is the best we have ever found in these circumstances.—DADANT & SON.—*Gleanings.*

Correspondence.

The Editors do not hold themselves responsible for the opinions expressed by correspondents. No notice will be taken of anonymous communications, and correspondents are requested to write on one side of the paper only, and give their real names and addresses, not necessarily for publication, but as a guarantee of good faith. Illustrations should be drawn on separate pieces of paper.

Communications relating to the literary department, reports of Associations, Shows, Meetings, Echoes, Queries, Books for Review, &c., must be addressed only to 'The Editors of the "British Bee Journal," 17 King William Street, Strand, London, W.C.' All business communications relating to Advertisements, &c., must be addressed to Mr. J. HUCKLE, Kings Langley, Herts (see 1st page of Advertisements.)

**. In order to facilitate reference, Correspondents, when speaking of any letter or query previously inserted, will oblige by mentioning the number of the letter, as well as the page on which it appears.*

IN THE HUT.

'Point in his foremost epigram is found:
Bee-like, he lost his sting at the first wound.'

[747.] How galling it is for a bee-keeper in a poor honey-yielding district to be fated to ride through the country, and see thousands of acres of the finest, whitest clover imaginable, in full blow, and the smell of it in full blast, through the railway carriage window! He mourns over his unhappy lot, and, like the music-master, whose super-sensitive ear could not bear the torturing tones emitted by his pupil's violin, wonders, 'What have I done, what crime have I committed, that this should be my fate?' Then, like a wise man, he philosophises, and

blisses the happy bee-man whom Fortune so favours. Somehow, again, he finds a few grains of thankfulness remaining that it is not so bad after all; for, on taking a favourite walk of his—a circle of country lanes round what he calls a bee-flight—'X-Tractor,' for it is him I write of, determines that if his bees get all the honey from only such white clover as comes under his eye, 'twill not be so bad; and this fall he will spread a few pocketsful of white clover-seed by the wayside—for 'a sower went forth to sow,' &c.—where the farmer will *not* cut it down in its prime, and where the natives are so suspicious of their kind that they would not trust anything alone to browse in the lanes, so perhaps the bee may get a chance. He then went home and extracted.

By the way—or, rather, in 'Notes by the Way'—Mr. Woodley inquires anent super-clearers. The cone-shaped clearer, tacked on the ventilation-hole of the hive cover—mind, forgetful bee-keeper! to be 'off with the old love,' &c.; that is, put off the *old* bit of zinc—answers magnificently; no bother, no smoke, no shaking or brushing off of bees, no flipping off odd clingers 'on the gorge,' filling themselves with honey. The night before extracting, or, better, early the same morning, lift up gently the section crate and slide between it and the brood nest a sheet of American cloth, then take off all quilts from the section crate, and replace the hive cover. The swarm-preventer—a broad passage-way of queen-excluder zinc, intended to steer the queen in the rush of swarming into another hive—is not quite such a success with me. I have had two hives, likely to swarm, fitted up with this apparatus, and in each case found it interfere with working. The drones, who, like Sterne's starling, 'can't get out,' kick up a big pother, filling up the holes with their cumbersome bodies, and causing just the heat and excitement one wishes to avoid. Again, the incoming workers lose quantities of pollen-masses in getting through the interstices. However, one swarm came off and lit on a bank; but, knowing the queen was not with them, I did not take the swarm, and they went back: not, mark you, swarming into the place prepared for them. It may be fancy, but I think the struggle through the apertures makes the bees 'waxy;' that is, they wax wrath.

It is too early to speculate on the honey returns this year, for with Huttites the best harvest has yet to come on in the heather—that glorious trip which we would take if the bees yielded us no surplus from the ling, that magnificent time of jollity, fresh air, and stings! Here, as aforesaid, in a miserable locality for fruit and white clover, I am satisfied with seventeen to twenty pounds of good mixed stuff per hive, and fully expect, in an average season, if this turn out such, to get as much more.

Speaking of heather reminds me the birds are so backward that in some districts it was seriously proposed to postpone the date usual for the commencement of the massacre of St. Grouse. Anyway, we did not postpone the

taking of the bees, and on the 9th inst., at six a.m., we started for our usual nine-mile pilgrimage, with a fair prospect of fine weather before us. But, alas! in spite of 'McIntosh & Leggings'—this firm has a good deal to do with the weather—we all got awfu' soaked. A horse who would pull anything anywhere, on a road, repeatedly refused to budge when he got his fetlocks amongst the ling; so in a steeping, slanting downpour we put our shoulders to the back of the waggon, and pushed the lot along! We were rewarded for all our discomfort by finding all had travelled well.

'And now, like swarming bees, o'er many a mile
Forth rush the swarthy forms o' the gilded multitude.'

The ling was just opening, and if the Fates be propitious, and bless us with a month's fine weather, we shall get a respectable second crop of honey; but truly, 'Man never is, but always to be, blessed,' for if we got teeming crops of nectar we should find some complain that 'the quantity brought down the price.' One incident I ought to narrate, although not connected with bee-keeping:—A farmer's horse was observed craning his neck over into a field of juicy 'fog'—rich grass growing after the hay crop—from a well-eaten field he and others had nibbled short. He next planted his fore feet near the hind ones, after the manner of performing Assyrian goats, and repeatedly pushed himself with full force against the stone wall, until he forced it over, then daintily lifted one leg after the other into Arcadia. On passing the place eight hours after, not one of his mates had had even the courage to follow his lead, much to the edification of others besides—X-TRACTOR.

THE BITER BITTEN.

[748.] A friend of mine—a lover and careful manipulator of bees—got word the other day that a swarm had settled on a tree in a certain farmer's hayfield, and that he might hive and keep it. Accordingly he sent his servant with a skep, who very soon secured the bees. Then the farmer, with several of his work-people, appeared on the scene in great wrath, and abused the unfortunate servant right and left for daring to trespass on his ground, and, of course, claimed the bees. In vain the man explained and expostulated. The farmer's wrath waxed stronger, backed, as he was, by his men. By this time the servant saw that his master and he had been made the victims of what was meant for a clever ruse to teach the farmer how to hive a swarm; but his *nous* was equal to the occasion, for, skep in hand, football fashion, he gave it a great kick right among the farmer and his men, saying, 'Well, take your bees then!' when, oh, such a sight! In a moment the farmer and his brave men were flying in all directions, every one with his hat off, beating his head, believing he was surrounded with innumerable bees, the servant laughing the while as though his sides would

split! Soon the bees settled again, when he was graciously permitted to hive and take them. Had the farmer honestly asked the gentleman to secure the swarm for him, it would have been done with pleasure, as he is ever ready, both in word and deed, to advise and assist his neighbours. So I trust the farmer has learnt the lesson, once more taught, that 'honesty is the best policy.'

The bar-frame hive is making steady, if rather slow, progress in this neighbourhood. Very many colonies of bees in skeps died last March, owing to the late spring, supplies having failed. However, those that survived have done well. In one instance a swarm from a small skep was hived at the end of June in a hive of ten frames, with full sheets of foundation, and last Thursday morning a crate of well-filled sections was taken off. This for a first attempt with the bar-frame hive was encouraging to the farmer.—A FRIEND OF THE BUSY BEE.—*Castleblaney, Ireland.*

CLEARING BEES FROM SUPERS.

[749.] In answer to your footnote to my letter in last week's *Journal* (742, p. 361), I ought, perhaps, to have explained that my section crates are all fitted with Abbott's tinned iron girders, so that the whole space between crate and frames is accessible from the centre-hole in quilt. I was under the impression that girders were more generally used, as they are certainly, to my mind, better than any other plan.

I have used the zinc cylinders on several more crates since I wrote last week about them, and in one case excitement was started, but I immediately removed the crate, and no damage ensued. Sixteen out of seventeen cases have been quite successful, but I should say a certain amount of care is required; but then that is the case with many other manipulations.—ARTHUR J. H. WOOD, *Bellwood, Ripon, August 15th.*

CONE SUPER-CLEARERS.

[750.] Having seen several reports in the *British Bee Journal* of super-clearers, I thought I should like my fellow bee-keepers to know how I succeeded with them. Being a tinman by trade, I made two of the cone-shaped super-clearers and fastened them to the roof of the hives, first removing the perforated zinc in the front, and they both answered splendidly. One was put on at nine o'clock and taken off at two o'clock, and the other at two o'clock and taken off at seven o'clock, and there was not a bee left in them.—W. ADAMS, *Welwyn, Herts.*

THE SEASON AT EASTER ROSS, N.B.

[751.] Thus far the season, from a bee-keeper's point of view, has been a fairly good one. During the greater part of June and for the first three weeks of July the weather was sunny and mild with showers of rain, but that unfor-

tunately has given place to a colder and more sunless atmosphere. I commenced the season with four frame hives, all in good condition; from these I have had five swarms, two of which were exceptionally strong, and twenty-six sections of honey, all well sealed: the latter were got most before swarming began.

Clover is still in flower, but the supply is gradually diminishing, and it will be some little time yet before heather is in bloom, of which there is only a limited supply in this neighbourhood.—G., *Easter Ross*.

BIRD STUNG TO DEATH BY BEES.

[752.] The enclosed was found rolling about in front of a very strong stock of bees in a dying state. She breathed her last in great agony some two or three minutes after being freed from the bees, and there were some scores of them attending to her most earnestly. I should hardly think you will consider it to be necessary to hold an inquest, but will be able, on examination, to certify satisfactorily the cause of death. I may state I have removed many of the little darts from the deceased, but there is still exhibited ample proof of the punishment she received for her imprudent conduct.—R. R. GODFREY, *Flaxton*.

ADDRESS ON BEE-KEEPING.

[753.] At the 'Health Receptions' organized by the London Vegetarian Society and the Bread and Food Reform League, held at the Memorial Hall, Farringdon Street, on Thursday, the 13th of August, a short address on bee-keeping was given by Mr. Jesse Garratt, who, in a very happy way, introduced the subject of 'Honey as Food and Medicine,' pleasant to the taste, easy of digestion, and suitable as wholesome food for vegetarians and others, both young and old.

Mr. Garratt exhibited a single-frame Observatory hive, with bees and their queen, on a well-selected comb, showing the various stages from the egg to the perfect bee, with cells of pollen and sealed honey. He touched slightly on the improved methods practised by advanced beekeepers, showing and explaining the use of comb foundation, the manner in which the honey is now taken from the combs free from all impurities by the use of the centrifugal machine known as the honey-extractor, and how the combs are returned to the hive to be again filled. Mr. Garratt had a most attentive audience, who appeared much interested in what they heard and saw.

Among the exhibits in the Hall was a large one of very fine honey in one and two-pound sections, very well filled and fit for any competitive exhibition; also a quantity of one-pound bottles of beautifully clear extracted honey, the property of Mr. Goodrich, a member of the Vegetarian Fruit Farm Colony of Methwold, Norfolk.—JOHN M. HOOKER.

Queries and Replies.

[400.] *Virgin Swarms*.—Could you or any of your numerous readers give an opinion regarding the following points, which a friend of mine had an argument over lately: 1. What is the earliest a virgin swarm has been known to come off? 2. What is considered a virgin swarm? 3. Does the honey that a virgin swarm gathers differ from any other? 4. Are the bees of a virgin swarm different from the parent stock at time of swarming? 5. Which queen comes with it, old or young?—J. C. W., *Dumbartonshire*.

REPLY.—1. We cannot say; usually three to four weeks after the top swarm has been hived. 2. A 'virgin swarm' is one which issues from a swarm hived the same year. 3. No. 4. They consist largely of the same. 5. The old queen, of course.

[401.] I hived a good swarm in a flat-topped skep the first week in July. The bees immediately commenced work, and I supered them at once with some partially finished sections. They took to them forthwith, and I removed from them about a fortnight ago twelve finished sections. I am puzzled as to their movements. Ever since they were hived, although working well and carrying in pollen, they have been hanging about the entrance in a cluster varying in number from a few dozen to nearly a pint of bees. They are there as late as ten p.m., and I have found them out at six a.m. They are perfectly quiet, and the size of the cluster gradually increases during the day. Of course I have not disturbed them by lifting the skep. They are not working in the empty sections that I put on in the place of those taken away. There are a few bees among the sections, but they seem to be doing no work. I have only resumed my bee-keeping within the last few weeks after a lapse of many years, and have lost much of my previous knowledge of them. I have just bought four apparently strong stocks, and have supered them about a week ago with racks of sections. The bees, however, do not seem to take to them, although they are well crowded in the brood combs, and seem to be very cramped for room. To-day they are flying about in great excitement, with a large number of drones *en évidence* almost like swarming. Can you give me any practical hints as to what to do? I should like an expert to see them, but the usual fee is to me almost a prohibitory one.—E. THOMAS, *Fulham*.

REPLY.—Referring to the bees in the skep, a little bottom ventilation would have stopped the clustering outside, and beyond this there was nothing very unusual in the subsequent behaviour of the bees. It is very probable the season in your district is nearly over, and that little honey is now coming in. Besides, it is altogether too late to set on racks of sections in.

August, and this will account for the bees in the stocks last purchased refusing to take to them.

Bee Shows to Come.

August 20th, 21st.—Staffordshire B.K.A., in connexion with the Staffordshire Agricultural Society at Leek. Entries closed.

August 29th.—Forfar B.K.S. at Forfar. James Hutchinson, Secretary, Yeaman Street.

September 2nd and 3rd.—Lancashire and Cheshire B.K.A. at Birkenhead. For schedules apply Arthur H. Edwardson, 28 Hamilton Street, Birkenhead. Liberal prize list open to all comers.

September 4th, at Stranraer, Wigtownshire Apian Association. Entries close September 2nd. Apply for schedules, J. B. Robertson, Hon. Sec., The Manse, Leswalt.

Sept. 5th.—Alderley Edge and District Branch of the Lancashire and Cheshire B.K.A. Chelford Flower Show, Astle, Chelford. Schedules, &c., T. D. Schofield, Alderley Edge, Cheshire.

Sept. 5th.—Bramhall and Woodford District Horticultural Society at Bramhall Hall, near Stockport. Entries close August 22nd. Particulars of William Slater, Fern Lea, Bramhall, Stockport.

Sept. 9th, 10th.—Derbyshire Bee-keepers' Association at Derby. Entries close August 27th. W. T. Atkins, Sec., 12 North Street, Derby.

October 13th to 16th.—British B.K.A., in connexion with the Dairy Show at the Royal Agricultural Hall, London. All open classes. Entries close September 14th. For schedules apply to Wm. C. Young, Sec., 191 Fleet Street, London.

Echoes from the Hives.

Kenilworth, August 9th.—The cold nights and cold weather since St. Swithin have spoilt the honey harvest. I had a swarm on July 26th, and the bees have done very little since. Shallow frames have beaten sections clean out of it again. For my part, I am sick of sections. The only hives I was bothered with swarms and casts from had sections on, and while from one hive I have twenty-two shallow frames full, from another, equally strong in spring, I have ten sections and a single swarm. My experience, too, is that a strong stock with only sections on is sure to swarm, for, however many crates are put on, as soon as the bees touch the quilt they swarm; but with shallow frames and floor ventilation they don't.—A. W.

Inveravon, Ballindalloch, August 10th.—In this district bees have given no surplus. I put crates of one-pound sections on five hives about the middle of June, and the bees entered them in a day or two. About the last days of the month I found the centre sections being sealed

over, and I immediately raised the crates and put empty ones underneath. On the 27th rain commenced, and has continued to fall at short intervals up to the present date. I do not think there have been twenty-four consecutive hours of fair weather. The greater part of this time bees have been confined to their hives, and, when favoured with an hour of sunshine, out came swarms; in some gardens three and four in a day. About a fortnight after adding the second crate four of mine swarmed, and in every case the bees had not attempted to draw out the foundation in the under crate. While the swarm was settling I carried six frames from the parent stock (with all queen-cells), and placed them in an empty hive on a new stand. I supplied the stock with bars fitted with two inches of foundation, replaced both crates, and returned the swarm. I now find all unsealed honey has been carried down. Should favourable weather come I shall expect thirty pounds from my swarms, as the queens were all mated about the first week of August last year, and the top crate is fairly well filled with bees; and, moreover, there is abundance of clover still, while the limes and heather are just coming into blossom. The sprig of heather enclosed I plucked at the base of a hill a few yards off the turpikie road leading from Ballindalloch to Tomintoul. I am glad to inform you of my success in dividing a bar-frame hive of eight frames into four, and introducing these virgin queens into the queenless parts. I have never seen bees manipulated (but if spared I intend going to the Highland Society's show, to be held at Inverness next year). All my knowledge has been derived from reading books and my *B.B.J.*—ALEX. STRATHDEE.

BEE-KEEPING FROM A MAN'S STAND POINT.

A woman in Michigan 'commenced with but two colonies of bees; her net profits the first season were over 100 dollars; the second year but a few cents less than 300 dollars; and the third year about 250 dollars.' The woman who reads that statement and is told that bee-keeping is 'light work, especially fitted for invalids and women,' is likely to go to figuring how much can be done with 100 colonies, and many a one has thus had her head turned.

Let me give you a bit of my experience. In the year 1887, from about 300 colonies my honey crop amounted to 30 dollars, 10 cents per colony, and I then had to buy 2800 pounds of granulated sugar to keep my bees over winter. After paying for my help and other expenses, I was several hundred dollars out of pocket, to say nothing of losing my entire year's work. That's the other side.

As to the 'light work.' When I put in from twelve to fourteen hours a day, in the hottest weather, dripping from head to foot with perspiration, stooping and lifting till I have as much backache as can be packed in one spinal

column, I hardly feel like calling bee-keeping 'light work.'

Having said this much by way of caution, I am bound to say that for those who have the taste for it, I do not know of any more fascinating or healthful pursuit. Your true bee-keeper goes into the business in the first place for the love of it. I have kept bees for thirty years, and for the past thirteen years honey-raising has been my exclusive business, and to be frank with you I must confess that I think I would have been better off in this world's goods if I had never seen a bee; but I am healthier, better-natured, and have a better chance for long life, and every year has been one of enjoyment.

Many a woman engaged in indoor employments might keep a few bees without interfering with her other duties, and find it a delightful recreation, adding greatly to her health, besides adding something to her purse. So, if your taste runs that way, try it. But you must have a taste for it to succeed.

If you have decided to try bee-keeping, don't commence with twenty colonies or ten—two at the utmost. You'll pay from 5 dollars to 10 dollars per colony, depending on kind and where you are, and if you succeed you can increase. But don't try to increase too fast. That's the rock on which so many beginners have split. You can easily make three, five, or six from one colony in a single season, and then—find them all dead the next spring.

If you start with two in the spring—and I wouldn't advise you to buy at any other time—don't try to have more than three or four at the most, at the close of the season.

Get a good text-book and read as you work. Learn all you can as to the habits of bees, and the plans of others. You will find it's a business into which you can put plenty of brains.

Stings?—Of course you'll get stings. You can wear a veil and gloves and make yourself sting-proof, but you are not likely to continue gloves very long. They are uncomfortable and in the way. Still, some do wear them. For your comfort I may tell you that one becomes, to a great extent, hardened against the effect of stings. When I first worked with bees a sting on the hand swelled it so I could not close my fingers, the swelling reaching to the shoulder and lasting two or three days. When I am stung now I think it hurts just as much as ever for a minute or two, sometimes making me groan if I think no one is in hearing.

Bees may be kept even in cities. In Cincinnati a prosperous apiary has, for years, been kept on a flat roof in the heart of the city. But don't keep a hive near a sidewalk or close by a road, where passing people or animals might be stung.

For the past eight years my principal assistant has been a rather slender girl. I favour her somewhat as to the heaviest part of the work, but in many things that require deftness rather than strength, she will accomplish more than I can, do my best, and I wouldn't swap her for any man I could get. She left teaching to work

with me, and I think the outdoor life she has led with the bees has been her physical salvation.

How much can you get from each colony? That depends much upon the flora of your locality. Every flower doesn't yield honey, but the bees will work in all directions—perhaps two miles from home. If you get fifty pounds to the colony you are doing very well. You will get a larger yield per colony with only a few in a place than with many.—Dr. C. C. MILLER.—*American Home Journal*.

COMB SOMETIMES PRODUCED WITHOUT LOSS.

Several days ago I noticed a colony hanging out. It was not a very warm day, and they were under a tree, so the sun did not strike them, except for a short time in the morning. I did not have time to look after them until late in the afternoon. By that time there was a fair-sized swarm hanging in front. I found the upper story full, and no sign of swarming. I took out half of the combs above, and gave empty frames instead. They went in, and by the next morning had several good-sized pieces of comb, and they built those frames full in a very short time. Now, I think if I had given them foundation, or extracted the combs and returned them, that wax would have been wasted; and that, under such conditions, wax is involuntarily produced. I find, during fair weather or a good honey-flow, by keeping about two empty frames in my upper story for extracting over good colonies, I get about as much honey as though they were not building comb, and they seem much better contented—not so liable to swarm, and I have the combs for use in the upper story of new swarms.

I read friend Manum's article in April 15th *Gleanings* with much interest: but I am afraid he will get 'stuck,' or perhaps some one with less experience will try to follow the same plan with his out-apiaries, and will get so much on his hands that he will pretty emphatically wish for some help. A little of my experience may illustrate one difficulty that may come up. This spring I have my home-yard and a yard four miles away. I planned to visit the out-yard once a week, and divide every colony that showed any sign of swarming. My home-yard built up very strong, and swarming commenced. All went according to plan for a while. Then the weather got so that, for some days, the bees could work only an hour or so; this continued several days, bees swarming all the time, as there was plenty of honey when the bees could work. Of course, with my two yards and some one to stay at home, I did not lose many. One cool day, after working at the out-yard, I got home after dark and found my wife had three swarms clustered together on both sides, end, and bottom of a two-story hive, while the day had been so cool that bees had worked only during the middle of the day. Then we had a cool spell of four days, with frost three nights. The first and fourth days the bees flew some;

the second and third days the yard looked like winter—hardly a bee stirring, as there was a cold north wind; and on the fifth and sixth days swarms issued. Now, if I had had more than three yards, even if I depended on dividing, I must have lost more or less swarms, as the weather would not permit of working with them, though the swarming fever kept up.

In making colonies hopelessly queenless to prevent swarming, I should be afraid of fertile workers taking possession; and a colony without queens, or means of rearing one, is of very little account for work with me; and this, I am afraid, would be a greater loss than to raise bees by having a queen with them, though it may work all right in certain localities.—JOHN B. CASE.—*Gleanings*.

STICKING TO OLD NOTIONS.

W. Z. Hutchinson, of the *Bee-keepers' Review*, has somewhat modified his conclusions in reference to the use or non-use of foundation in the brood nest, and in a paper which he read before the Ohio State Bee-keepers' Association at Toledo he gave expression to these words: 'I know it is not customary for authors or editors to acknowledge their errors; but, let me be editor or orator, I shall always proclaim what I believe to be the truth, even if it does conflict with my former published conclusions.' That has the right ring to it, Brother H. Would there were more authors, editors, and orators—or, if you please, *contributors*—who would be willing to retract some of their published statements. If there is any one thing that does the pursuit damage, it is the persistent clinging to old notions. A man who cannot change his opinion occasionally, on reasonable evidence, is a man whose opinion should not be trusted too implicitly. We know of some people among the bee-keeping craft—good bee-keepers and contributors—who, when they have once published a certain view, never change it, and who go still further to bolster up and strengthen that opinion or supposed fact. As our readers know, we have abandoned the ten-frame idea and the bevelled edge on hives—that is, we do not recommend them any more. It is no weakness to change your mind; but when it is necessary, come out and say so like a man.—*Gleanings*.

COMB FOUNDATION.

SOME STRONG ARGUMENTS IN FAVOUR OF FULL SHEETS IN BROOD CHAMBER.

This Spring Gould & Co. established an apiary at the Homedale, and I think any one who would have looked through that apiary of some eighty odd colonies would have been a thorough convert to the use of *full sheets* of comb foundation in the brood chamber. We were very busy for a time, and colonies purchased from all parts of the country, and all grades, from light pure Italians to black German

bees, had their own way as to drone-production, as far as the combs would allow them, and they made good use of their liberties. The time came when, for the sake of the young queens soon to be mated, undesirable drones had to be destroyed, and it was then we found how many there were. We trapped thousands and thousands of drones worse than useless to us, and in the production of which not only much valuable honey had been lost, but, if they had not taken the room, workers would have been reared, meaning another loss in the working force of the apiary. Italian colonies we allowed to rear all the drones their combs would allow, and some of these have so many drones I do not believe they will either swarm or store much in the surplus apartment. Why is this loss? Just because it was desired to effect a saving in comb foundation. But was it a saving? Surely not. A little outlay in the beginning would have avoided this drone comb; and not for one batch of drones only, but for many. I think no one can point out a system of securing with certainty all worker combs. The bees will build worker comb until the first young bees emerge from the cells after swarming; then, if they build at all, the will build drone comb. Of course, we must allow for variations of a slight nature. But to tell a bee-keeper, and especially one of experience, that it is not expensive to use only starters, is, I think, a grave error in judgment. I say nothing about the many other arrangements in favour of full sheets of foundation. There is only one instance in which I use starters, and that is, where I put swarms on them to get comb honey for exhibition purposes. I then sacrifice the comb for a special purpose.—R. F. HOLTERMANN.—*Gleanings*.

UTILISING WEAK COLONIES IN THE SPRING.

Perhaps my method of handling the swarming business will be of some use to some of the readers of *Gleanings* whose bees will persist in swarming, and who find their crops of honey curtailed by the same. Unless the season is an exceptional one it does not pay to build up weak colonies in the spring, at the expense of the stronger ones. Let them get what brood and bees they can; and when swarming commences, give the first swarms in these, saving the queens, which introduce into the colony from which the swarm issued next day. The three or four combs of brood, supplemented by a couple of combs of foundation, will usually be very acceptable to the swarm, and the work-bees will be a valuable addition. Put on the sections, and your honey crop will be scarcely diminished. Introduce the queen in twenty-four hours, after removing all the cells and smoking bees thoroughly, by turning her loose on the combs, and this also will soon have a full working force again. After all weak ones are treated in this manner, give the next swarm on the old stand on half the brood combs and the rest on founda-

tion, or empty combs. Put the brood taken out where it will not chill, and hive the next swarm that issues with this *swarm*, catching the queen as she runs in, and return her and the brood taken out to the hive from which her swarm issued. If she should not be caught as she enters the hive, she will usually be found balled on the bottom board inside of the hive, where she is easily caught. All who have lived two good swarms together during a honey-flow know what honey they will gather with their enormous stock of workers, while the stock to which the queen is returned and brood given will be a rousing colony again in a few days—one that may store a large amount of honey. By this method a comb of brood can be taken here and there for forming nuclei. It does away with the after-swarm nuisance; prevents all increase, keeps all colonies strong and with a laying queen, and scarcely, if at all, diminishes the surplus. After the flow is over, weed out all poor queens.—W. W. CASE.—*Gleanings*.

Notices to Correspondents and Inquirers.

Letters or queries asking for addresses of manufacturers or correspondents, or where appliances can be purchased, or replies giving such information, can only be inserted as advertisements. The space devoted to letters, queries, and replies, is meant for the general good of bee-keepers, and not for advertisements. We wish our Correspondents to bear in mind that, as it is necessary for us to go to press in advance of the date of issue, queries cannot always be replied to in the issue immediately following the receipt of their communication. All queries forwarded will be attended to, and those only of personal interest will be answered in this column.

CHAS. MCGRORY (Campbeltown).—*Bees Transferring themselves to Lower Hive*.—You may try setting the swarm in box on the top of your new hive, but it is not at all certain they will take possession of the lower story when the season is so nearly over. If there is any heather in your district the chances are greater, but it is more than probable that the foundation in lower hive will only be partly worked out when the season closes, and that the bees will winter in the upper box.

H. C. (North Hincksey).—You may with advantage take away a couple of the full combs (if sealed over), and replace with empty combs. It is now too late to put sections on.

T. 'HONEYCOMB' (Sunderland).—Of the two sugars sent, No. 1 is best. Apply to Mr. J. Huckle, Kings Langley, Herts.

T. MATTHEWS (Cardiff).—Honey sent is excellent in quality; it is almost wholly from white clover. As it reached us in perfect condition, and not a particle had escaped, we need say no more as to the 'packing.'

BESWING (Carlisle).—*Returning Swarms*.—1. If a top swarm is returned to the parent hive the morning after it issued without removing queen-cells, it will probably come off again in a day or so. 2. Swarms intended for returning should be set close to the parent stock.

G. G. (Bristol).—*Transferring Bees and Combs from Old Skeps*.—Leave the bees and old

combs where they are till next year, and stimulate them to swarm early. Have new combs built in your new hives by all means.

H. B. (Wonston).—*Dealing with Foul-broody Stocks*.—The present is the worst possible time to do anything by way of treating diseased bees. Beyond slipping in a disinfectant in the evening, when the bees are at rest, nothing should be done till the autumn, when they are most inclined to start robbing.

J. BIRT.—It is difficult to name the exact cause of the bees dying without fuller particulars. Sometimes the weather causes the death of young bees, by tempting them out of the hives at unsuitable times, and they are unable to return; but when the mischief assumes a more pronounced form, it indicates a complaint for which salt in food has been found a useful remedy.

MODERN BEE-KEEPING. New Edition. Post free, 7d. The most useful Guide for Cottagers and others commencing to keep bees. Nearly 50,000 already sold.

JOHN HUCKLE, Kings Langley, Herts.

THE HONEY BEE: Its Natural History, Anatomy, and Physiology.

By T. W. COWAN, F.G.S., &c., &c.,

Editor of the *British Bee Journal*.

Cloth gilt, price 2s. 6d.; postage 2½d.

London: HOULSTON & SONS, Paternoster Square;

ALL BOOKSELLERS; AND

British Bee Journal Office, Kings Langley, Herts; and 17 King William St., Strand, London, W.C.

British Bee Journal and Bee-keepers' Record.

OFFICE:

17 KING WILLIAM STREET, STRAND, LONDON, W.C.

PURE CANE SUGARS.

For the accommodation of Bee-keepers, guaranteed Pure Cane Sugar will be supplied in large or small quantities through this office at the under-mentioned rates:—

CRYSTALLISED.

4. DEMERARA	} Neat bags, 14-lbs. 28-lbs. 56-lbs. Cwts.			
5. BARBADOS		Crystals 2½ 5¼ 10/6 20/6		
6. TRINIDAD				

REFINED CANE.

7. WHITE CRYSTALS (Small)	3/0	5/10	11/6	22/6
8, 9. (Medium and Large sizes, 1- per Cwt. extra.)				
10. LUMP (Cut Loaf) ... Boxes,	3/3	6/3	12/3	22/6
11. LUMP DUST ...	3/0	6/0	11/6	22/9

All above guaranteed made from CANE SUGAR only, and free from BEET, CHEMICALS, &c., &c.

CARRIAGE PAID on Orders over 5/0 (or 28-lbs. Sugar) to London and Suburbs.

COUNTRY ORDERS, not less than 2-cwt. carriage paid at 1/0 per cwt. extra.

(Scotch and Irish orders, special arrangements.)

Cash to be sent with order, and purchasers will please observe that if samples are required or replies asked to inquiries, a stamped addressed envelope must be sent, as we cannot undertake cost of postage.

Special Prepaid Advertisements.

Situations, Publications, Bee Plants, &c.—Twelve words and under, Sixpence; for every additional Three words, One Penny.

Trade Advertisements not inserted under this head.

CHOICE YOUNG QUEENS.—Raised under most favourable conditions. Fertile, 5s.; Virgin, 2s. 6d. Safe arrival guaranteed. Mr. J. H. Howard writes:—'You excel in Queen-rearing.' Address Rev. C. BREFRETON, Berwick, Sussex.

WANTED.—1-lb. Sections of Honeycomb, first quality. Prompt Cash. Packages sent. Well-filled Bell Glasses, Frames and Caps purchased. Address Mr. HURST, Bexhill, Sussex. 242

HONEY JARS, Tie-over, ½-lb., 1-lb., and 2-lb. Price List Free Address FRED. PEARSON, Stockton Heath, Warrington. 243

WALLFLOWERS will give splendid forage for Bees in Spring. Fifty plants, 1s., post free. Address NORMAN PARKIN, Blakenhall, Wolverhampton. K 83

TO BE SOLD.—Two Hives of Bees (Swarms). Price and particulars of W. H. GLOSSOP, Forest House, Babworth, near Retford. K 85

ABBOTT'S 'Little Wonder' 10s. Honey Extractor for 7s. Never used. Address ROLLINS, Stourbridge. K 86

FOR SALE.—Six Stocks of Bees in Standard Bar-frame Hives. £3 the lot. Also Cylinder Extractor, takes two Frames at once, equal to new, price 15s. Cost double. Apply to M. BASKOT, 17 Salt Works, Garston, Liverpool. K 90

CARNIOLAN QUEENS, wonderfully prolific strain, guaranteed healthy and laying, 2s. 6d. each, 10s. half dozen, carriage paid. Address H. NEVE, Warbleton, Sussex. K 91

FOR SALE.—Healthy Driven Bees, 1s. 3d. per lb., and Queen. Packing-box, 6d. Young Queens, 1s. 6d. each. Address E. GARNER, Broom, nr. Biggleswade, Beds. K 93

FOR SALE.—Pure Native Driven Bees, guaranteed healthy, 1s. 3d. per lb., including Queen and packing for 5 lb. lots or over. Fine 1891 Fertile Queens, 2s. 6d. each post free, Safe arrival guaranteed. Address CHS. WHITING, Vallev Apiary, Hundon, Clare, Suffolk. K 94

FOR SALE.—Driven Bees, with Queen, healthy, at 1s. per lb. Package 1s. Address J. DAVIES, Bee-keeper, Newport, Salon. K 95

FOR SALE.—Driven Bees, 1s. per lb., 1891 Queens. Carniolan Queens, 2s. each free, or Hybrids. Address A. NICHOLLS, Hazlemere, High Wycombe. K 96

FOR SALE.—Three large Skeps of Strong Healthy Bees. This Season's Queens. Packed free on rail. What offers? Address Mr. CADNESS, Chadwell Heath. K 97

FOR SALE.—Healthy Driven Bees, 1s. 3d. per lb. Packed free. Ready upon receipt of P. Order. Address JOHN WALTON, Honey Cott, Weston, Leamington.

FOR SALE.—Having had considerable difficulty to obtain suitable Boxes for 1 lb. Sections, and bought larger quantities than required, I shall be pleased to sell at 4s. 9d. per gross, carriage free for cash with order. Address MARTIN, 4 Woodland Place, Fath.

HEALTHY DRIVEN BEES.—I am now booking Orders at 1s. 3d. per lb., in 4 or 5 lb. lots, headed by Young Queen. Safe arrival guaranteed. Box 1s. Extra Queens, 2s. each. A customer at Carnforth writes:—'The Bees I got from you last year are far the best stocks in the neighbourhood.' Another at Stow, N.B., writes:—'The Queen you sent me is leading a very strong colony.' Address A. J. CARTER, Newfields, Billingshurst, Sussex. 248

WANTED.—New Honey in 1 lb., 1½ lb., and 2 lb. Sections. State quantities of each size, and prices expected. Address Mr. ALEX. LEITCH, 208 St. George's Road, Glasgow. Terms cash. 247

ENGLISH QUEENS, tested, 2s. 6d. each, post free. Address C. N. WHITE, Somersham, Hants.

T. A. FLOOD,

MANUFACTURER OF

Bee-keeping Appliances,

Supplies every requisite for the Apiary equal to any house in the trade.

WORKMANSHIP AND QUALITY OF ALL GOODS UNSURPASSFD.—Lewis's best American Sections, 2/6 per 100. Post Free, 3s. Pure Foundation guaranteed.

FLOOD'S IMPROVED SUPER CLEARER, 2/6 Post Free, 3s. A Boon to Bee-keepers.

A GREAT SUCCESS THIS SEASON.

CATALOGUES POST FREE.

Address—T. A. FLOOD, Donnington Road, READING. 239

CHEAP WOOD FEEDERS,

HOLDING ONE POUND OF SYRUP.

Can be used for Fast or Slow supply.

4d. each, postage 3d. No. 88 in List.

Bright Foundation, 1/10 lb. Darker ditto, 1/3 lb.

EDEY & SON,

STEAM JOINERY WORKS, ST. NEOTS.

BALDWIN'S is the Oldest Establishment in the United Kingdom wholly devoted to Bees and manufacture of

Bee-keepers' supplies. His prices will compare most favourably with those of any other Maker, while for quality of material, suitability and workmanship, he has no rival.

'Why can he give better value for money than others?' Because he spends less in large 'puffing' advertisements, buys in the best markets for prompt cash, has no rent to pay, and personally conducts his own business.

For prices and full particulars of Goods see Baldwin's Bee-keepers' Instructor (and Illustrated Catalogue combined), which 'contains more practical and reliable hints than all the large, expensive books,' post free for 2d. stamps. Address S. J. BALDWIN, The Apiary, Bromley, Kent.

N.B.—More than 500 Silver and Bronze Medals, First and other Prizes, and Testimonials innumerable.

NEIGHBOUR'S BEE HIVES.

WELL KNOWN for SUPERIOR & ACCURATE WORKMANSHIP.

Every Description of APPLIANCES kept in Stock.

CATALOGUES FREE ON APPLICATION.

GEO. NEIGHBOUR AND SONS,

127 HIGH HOLBORN, LONDON, W.C. (Corner of Southampton Street.)

THE
British Bee Journal,
BEE-KEEPERS' RECORD AND ADVISER.

No. 479. Vol. XIX. N. S. 87.]

AUGUST 27, 1891.

[Published Weekly.]

Editorial, Notices, &c.

SHROPSHIRE BEE-KEEPERS' ASSOCIATION.

The annual show of this Association was held in connexion with the Shropshire Horticultural Society's great *fête* at 'The Quarry,' Shrewsbury, on Wednesday and Thursday, August 19th and 20th, and the event must be regarded as a great success. The many thousands who attended the *fête* bear an ample testimony to its great popularity, and when it is told that the organizers are able to appropriate a handsome surplus year by year to various benevolent objects, sufficient is stated to create wonder and surprise at the loyalty and *esprit* existing in the county—the manifestation of which, to an outsider, is one of the greatest and most interesting features of all. The splendid site first of all claims our notice. Its grassy slopes, its magnificent and stately avenues of towering lime-trees, and the silvery Severn which flows rapidly past, form a picture of rare attractiveness, the possession of which must be a source of pride to the town, of which it forms an adjunct, and to the county at large. With a grand exhibition of honey and appliances nothing more is needed to explain the enthusiastic interest which the *fête* evokes among the bee-keeping community.

Under the direction of the able and energetic Honorary Secretary, Miss M. E. Eyton, supported by an intelligent and painstaking Committee, the Shropshire Bee-keepers' Association has brought into existence an interest in bee-keeping which embraces all classes, and unites them in a bond of good fellowship; and the writer testifies to the evidence of this in a degree seldom met with in other counties. The exhibits were effectively staged in a marquee of large dimensions, connected with which was a smaller tent provided for the purpose of lectures descriptive of the science of bee-keeping, the exponent being Mr. W. P. Meadows, the well-known manufacturer of bee-keeping appliances, who acquitted himself in a very efficient manner.

The honey exhibited was generally of first-class quality, and denoted that the aim of the Association to improve the knowledge of bee-management had been largely attained. The

judges' duties were rendered difficult and arduous by the evenness of the numerous exhibits in the honey classes, but there is good reason to believe that the awards gave full satisfaction. It may be observed that in the classes for bees the Observatory hive which contained them did not fulfil in a proper degree the requirements of the prize list, viz., that the bees should be secured in an *Observatory* hive. In each exhibit the bees were simply shown in a glass hive, which gave little or no facility for closely and practically observing, whereas a properly designed Observatory should display the bees on both sides of the combs, and provide for close and thorough examination of the bees and combs. The judges were Rev. J. F. Buckler and Mr. W. Lees McClure, of the Lancashire and Cheshire Association; and Mr. J. Garratt, of the Kent Association, their awards being as follows:—

Honey Classes (Open).

Class 1. Forty-eight 1-lb. sections.—1st prize, W. P. Meadows; 2nd, J. E. Roden.

Class 2. Twelve 1-lb. sections.—1st, W. P. Meadows; 2nd, A. J. Morris.

Class 3. Forty-eight 1-lb. bottles of run honey.—1st, J. Carver; 2nd, T. R. Horton; highly commended, Mr. Gregory.

Class 4. Twenty-four 1-lb. bottles of run honey.—1st, J. Palmer; 2nd, W. P. Meadows; highly commended, H. Wood.

Members only.

Class 5. Forty-eight 1-lb. sections of comb honey.—1st, S. Cartwright; 2nd, J. Palmer.

Class 6. Twelve 1-lb. sections of comb honey.—1st, J. Palmer; 2nd, T. R. Horton.

Class 7. Forty-eight 1-lb. bottles of run honey.—1st, S. Cartwright; 2nd, J. Palmer.

Class 8. Twenty-four 1-lb. bottles of run honey.—1st, S. Cartwright; 2nd, T. R. Horton.

Class 9. For the most attractive novelty in honey.—1st, J. E. Roden.

Honey Trophy (Open).

Class 10. For the best and most attractive display of honey.—1st, W. P. Meadows; 2nd, J. Bradley; extra, J. Palmer.

Hives and Appliances (Open).

Class 11. The best hive, price 15s.—1st, C. Redshaw; 2nd, W. P. Meadows.

Class 12. Best and most complete hive, price unlimited.—1st, J. Carver; 2nd, C. Redshaw.

Class 13. Best hive as Class 12, confined to Shropshire makers.—1st, J. Carver; 2nd, J. Palmer.

Class 14. Best collection of appliances.—1st, W. P. Meadows; 2nd, T. Whittingham.

Class 15. The best honey extractor.—1st, W. P. Meadows.

Class 16. Best section rack.—1st, C. Redshaw; 2nd, W. P. Meadows.

Class 17. Best feeder.—1st, C. Redshaw.

Class 18. New invention useful to beekeepers.—1st, J. Bradley.

Class 19. Best 1-lb. stock foundation.—1st, T. Whittingham.

Class 20. Best 1-lb. super foundation.—1st, W. P. Meadows.

Class 21. Best two samples of soft candy.—1st, G. Lloyd.

Bees.

Class 22. Best observatory hive, with foreign bees and queen.—No entry.

Class 23. Best observatory hive with English bees and queen.—1st, T. R. Horton; 2nd, A. Beale.

Class 24. For the best observatory hive with Carniolan bees and queen (restricted to the county of Salop).—1st, T. R. Horton; 2nd, S. E. Roden.

Artisans' Classes.

Class 25. Best 24 lbs. comb honey.—1st, A. Hamer; 2nd, F. Parton.

Class 26. Best 12 lbs. sections of comb honey.—1st, A. Beale; 2nd, F. Parton.

Class 27. Best 24 lbs. run honey.—1st, A. Hamer; 2nd, T. Pritchard; very highly commended, F. Parton.

Class 28. Best exhibition of comb honey in any kind of super.—1st, A. Beale.

Cottagers' Classes.

Class 29. Best 12 lbs. comb honey.—1st, J. Ward.

Class 30. Best 12 lbs. run honey.—1st, G. Croxton; 2nd, J. Evans; extra, T. G. Clark.

Class 31. Best six sections of comb honey.—1st, J. Shuker; 2nd, G. Croxton; 3rd, — Ward.

Class 32. Best six lbs. run honey.—1st, J. Evans; second, G. Lloyd; 3rd, J. Shuker.

Miscellaneous.

Class 33. Best exhibition of bee-flowers.—1st, T. G. Clark; 2nd, Miss M. J. Beale; 3rd, A. Beale; commended, J. Bradley.

Class 34. Best exhibition of bee-flowers (cottagers only).—1st, T. G. Clark; 2nd, G. Lloyd.

Class 35.—Best honey beverage.—1st, F. Pritchard.

Class 36. Best preserved fruit in honey.—1st, T. G. Clark.

Class 37. Best honey confectionary.—1st, Mrs. Shuker.

Class 38. Best 3-lb. sample of beeswax (Salop only).—1st, J. Evans.

Class 39. Best object of general interest to bee-keeping.—No exhibit.

WILTS BEE-KEEPERS' ASSOCIATION.

The County Show was held on August 19th, at the invitation of the Swindon Horticultural Society, in the beautiful grounds of A. L. Goddard Esq., J.P. An excellent tent, in a first-rate position, was provided by the Committee of the Horticultural Society.

The weather, unfortunately, was most unpropitious, there being heavy showers all day with bright intervals, and so the attendance at the flower show was very small. The bee-tent, however, was well patronised, and the money taken was double the amount received in *two* days at the County Agricultural Show at Malmesbury in June.

The entries were fewer than usual, owing to four other shows taking place in the same week at which prizes were offered for honey, and cottagers naturally entered at the shows nearest to them. The following is the schedule, with list of prizes awarded by Mr. W. N. Griffin, the Judge, appointed by the B.B.K.A.:—

Open to Members of W.B.K.A. only.

Class 1. For the best collection of honey from one apiary, not to exceed 1 cwt.—1st prize, S. W. Filtness, Swindon; 2nd, W. E. Burkitt; 3rd, not awarded.

Class 2. For the best twelve 1-lb. or six 2-lb. sections of honey.—1st, S. W. Filtness; 2nd, F. New, Chilton Folliat; 3rd, W. E. Burkitt.

Class 3. For the best twelve 1-lb. bottles of honey.—1st, G. Nailor, Pewsey; 2nd, S. W. Filtness; 3rd, W. E. Burkitt.

Class 4. For the best beeswax, not less than 2 lbs.—1st, Rev. C. W. Hony; 2nd, A. Godding; 3rd, W. E. Burkitt.

Classes 5, 6, 7.—No entries.

Mr. S. W. Filtness exhibited his collection in Class 1 on an octagonal pyramidal stand tastefully decorated with flowers. It consisted entirely of very fine 1-lb. sections and 1-lb. bottles.

Mr. Burkitt's collection did not contain so large a quantity, and his sections were fewer and less even, but a greater variety was displayed. It consisted of 1-lb. sections; one of 'Lee's supers' filled with beautiful comb perfectly filled, net weight 24½ lbs.; a case containing six well-worked shallow frames, net weight 22½ lbs.; and extracted honey in 2-lb., 1-lb., and ½-lb. bottles.

Much of the beeswax shown was very bright and good. In Class 3 all the honey was shown in 1-lb. bottles with screw metal caps of the same pattern, and the exhibits, though coming from places wide apart, were so evenly good that the awarding of prizes was a matter of difficulty.

Mr. S. W. Filtness occupied the whole of one side of the tent with a good and useful collection of bee-furniture from some of our leading manufacturers, for which he has a depot at 8 Newport Street, Swindon. This was *not for competition*. Mr. Filtness, being an energetic member of the W.B.K.A., gave great assistance to the Hon. Secretary in making all arrange-

ments on the spot, and providing bees in skeps and a frame hive for manipulation.

A small Observatory hive exhibited by the Hon. Secretary was a great attraction.

From two till dusk Mr. Burkitt was busily occupied in giving useful hints on bee management, and taking advantage of every gleam of sunshine to drive a skep and open the bar-frame hive, which he was able to do five times without any mishap, although the inhabitants of the bar-frame hive, having never been manipulated, at first resented his attentions most vigorously, to the amusement of the spectators. Mr. Burkitt was assisted at times in the driving by the Rev. C. W. Hony and Mr. Filtness.

Many thanks are due to the Committee of the Swindon Horticultural Society for the excellent arrangements made for the bee-show.

GOOLE AND DISTRICT B.K.A.

The third annual show of this society was held at Goole on August 13th, when, in addition to fruit, flowers, &c., there was a display of honey, bees, and appliances. In all respects, except financially, the show was a success.

The principal feature of the exhibition was the grand show of honey staged on the occasion, and the writer considers that a better show of extracted honey has not been seen in Yorkshire for some time; and it was a difficult task for the Judge (Mr. R. A. H. Grimshaw) to pick out the best where all was so good. However, that gentleman, assisted by his son, Mr. Darcy Grimshaw, performed his onerous duties to the entire satisfaction of all concerned. During the afternoon the show was visited by most of the gentry and professional gentlemen in the district, who listened attentively to the lectures on scientific bee-keeping delivered by Mr. Grimshaw, and afterwards expressed themselves delighted with all they had seen and heard. Mr. Dixon, of Leeds, illustrated Mr. Grimshaw's remarks by the practical manipulation of a frame hive in the bee-tent of the Y.B.K.A. Mr. Dixon also exhibited an interesting collection of useful appliances, diagrams, honey-comb designs, &c., while Mr. Milner, of Skelton, kindly decorated the honey-tables with a variety of plants, giving this part of the show quite an attractive appearance.

PRIZE LIST.

Special Classes.—Prizes presented by the Y.B.K.A., and open to members of that Association and the Goole District Branch.

Class A. Best six 1-lb. sections—1st, R. Waddy, Sutton-on-Derwent; 2nd, A. Woodhead, Goole.

Class B. Best six jars of extracted honey.—1st, W. Aaron, Goole; 2nd, W. Ramsey, Rawcliffe. W. Chester, Goole, who was highly commended in this class, received a special prize given by Mr. Dixon.

Class C. Best two frames of comb honey.—1st, R. Sykes, Rawcliffe; 2nd, W. Aaron.

Open Classes.

Class 1. Best six 1-lb. sections.—1st, Rev. R. L. Lamb, Burton Pidsea, Hull; 2nd, W. Dixon, Leeds.

Class 2. Best six 1-lb. jars of extracted honey.—1st, W. Dixon; 2nd, G. Roberts, Goole. Very highly commended, Rev. R. L. Lamb; highly commended, W. Aaron; commended, W. Ramsey.

Members' Classes.

Class 3. Best six sections.—1st (silver medal presented by Mr. T. Richardson, Goole), W. Chester; 2nd, G. Milson, Goole.

Class 4. Best six 1-lb. jars of extracted honey.—1st, W. Ramsey; 2nd, C. Watson Hook. Very highly commended, W. Aaron; highly commended, W. Chester; commended, G. Roberts.

Class 5. Best three 1-lb. sections and three 1-lb. jars extracted honey.—1st, E. Wainman, Saltmarsh; 2nd, G. Roberts. Special prize (given by Mr. Dixon) and highly commended, G. Milson; commended, Dr. Arbuckle Thorne.—A. WOODHEAD, *Secretary*.

ETWALL (DERBYSHIRE) HORTICULTURAL AND BEE-KEEPERS' SOCIETY.

The inhabitants of this picturesque village, in combination with others residing in the neighbourhood, some time ago decided to start a horticultural and B.K. society, and the practical result was apparent on August 19th, when the initial show was held (by kind permission) in the park adjoining Etwall Hall. It proved an altogether lovely spot for a show of this description. The marquees were pitched on the summit of a hill, from whence visitors commanded a view of as pretty a stretch of well-wooded and undulating country as one could wish to see, while to the right stood the beautiful Hall, in the midst of its own charming grounds. The privilege of having free access here amply repaid visitors from a distance, and it seems very likely that the show now founded will become an annual institution, and will attract even larger numbers to the park on future occasions. Still, the number of visitors exceeded all anticipation, several thousands attending, coming by rail and road. There was a very good display of honey and beeswax. The run honey was in splendid condition, and consequently the competition was very keen; still the awards gave the greatest satisfaction to all the exhibitors. There was also a large show of comb honey. The judge for the honey department was Mr. Atkins, North Street, Derby, who awarded prizes as follows:—

Run honey.—1st prize, Mr. Massey, Dalbury; 2nd, Mr. T. W. Jones, Etwall.

Comb honey, sections.—1st, Mr. T. W. Jones; 2nd, Mr. W. T. Morley, Etwall.

Wax.—1st, Mr. T. W. Jones; 2nd, Withheld, not being weight.

Bees with queen in observatory hive.—1st, Mr. T. W. Jones; no other prize awarded.

The show was in every respect a success; the stewards had bestowed every care in staging the exhibits to the greatest advantage.

MELROSE BEE-KEEPERS' ASSOCIATION.

A good number of persons interested in bee-keeping met in Melrose on August 22nd, and agreed to form an Association for the district. They appointed a committee to draw up rules to be submitted to the next meeting, and agreed that one of the rules should be that 'the members shall meet once a month for discussion of matters connected with bee-keeping.' The annual subscription for members was fixed at 1s. 6d., and it was resolved that the Association, besides having for its object the general advancement of bee-keeping, should from time to time put forward certain definite points, in the working out of which members might co-operate. It was further resolved that the Association should become affiliated to the Scottish Bee-keepers' Association at once, and thus be the first Association to be so affiliated. Mr. Weir, Melrose, was appointed Hon. Secretary of the Association, and there is every reason to believe that the members will soon be numerous.

Bee Shows to Come.

August 29th.—Forfar B.K.S. at Forfar. James Hutchinson, Secretary, Yeaman Street.

September 2nd and 3rd.—Lancashire and Cheshire B.K.A. at Birkenhead. For schedules apply Arthur H. Edwardson, 28 Hamilton Street, Birkenhead. Liberal prize list open to all comers.

September 4th, at Stranraer, Wigtownshire Apiarian Association. Entries close September 2nd. Apply for schedules, J. B. Robertson, Hon. Sec., The Manse, Leswalt.

Sept. 5th.—Alderley Edge and District Branch of the Lancashire and Cheshire B.K.A. Chelford Flower Show, Astle, Chelford. Schedules, &c., T. D. Schofield, Alderley Edge, Cheshire.

Sept. 5th.—Bramhall and Woodford District Horticultural Society at Bramhall Hall, near Stockport. Entries close August 22nd. Particulars of William Slater, Fern Lea, Bramhall, Stockport.

Sept. 9th, 10th.—Derbyshire Bee-keepers' Association at Derby. Entries close August 27th. W. T. Atkins, Sec., 12 North Street, Derby.

Sept. 19th.—Jedburgh and District B.K.A. in the Sessional School at Jedburgh. Entries close Sept. 15th. For schedules apply to Thos. Clark, Sec., Pleasant's School House, Jedburgh, N.B.

October 13th to 16th.—British B.K.A. in connexion with the Dairy Show at the Royal Agricultural Hall, London. All open classes. Entries close September 14th. For schedules apply to Wm. C. Young, Sec., 191 Fleet Street, London.

Correspondence.

The Editors do not hold themselves responsible for the opinions expressed by correspondents. No notice will be taken of anonymous communications, and correspondents are requested to write on one side of the paper only, and give their real names and addresses, not necessarily for publication, but as a guarantee of good faith. Illustrations should be drawn on separate pieces of paper.

Communications relating to the literary department, reports of Associations, Shows, Meetings, Echoes, Queries, Books for Review, &c., must be addressed only to 'The Editors of the "British Bee Journal," 17 King William Street, Strand, London, W.C.' All business communications relating to Advertisements, &c., must be addressed to Mr. J. HUCKLE, Kings Langley, Herts (see 1st page of Advertisements).

* * * In order to facilitate reference, Correspondents, when speaking of any letter or query previously inserted, will oblige by mentioning the number of the letter, as well as the page on which it appears.

PUNIC BEES.

[754.] In your contemporary, the *Journal of Horticulture*, there has been frequent reference to 'Punic bees' by a 'Lanarkshire Bee-keeper,' and in this week's number of that journal there is a long statement by 'A Hallamshire Bee-keeper,' giving the opinions of certain gentlemen who appear to have had some experience of these bees. As none of the names of those mentioned are known to me, would you kindly say if they are known in the bee-world as men of experience, and as pioneers in their own counties? It is, I fear, too much the case for beginners in bee-keeping to catch at anything new whether in appliances or bees, and endeavour to invent something, or to give their opinion as if they had a long and varied experience. Readers of a technical paper, particularly those who are novices, naturally look to its editor, who is supposed to be 'well posted,' as the Americans put it, to be their guide, and not allow them to be misled by admitting articles or statements of a questionable kind without giving some word of caution.

It often happens that after some glowing account of a new hive, a feeder, or a new kind of bee, puffed up by some person having such to sell, or by some friend whom he gets to write for him, and in some cases not even a bee-keeper, that those anxious to have the right thing part with their money, and in the end find that what they already possessed was far preferable. In this way, what was taken up with an idea of making a profit, turns out to be a dead loss. If this is followed by one or two bad seasons, novices get disgusted with bee-keeping and give it up—tell their friends and those they meet that it is a delusion and a snare.

To return to Punic bees. 'Hallamshire Bee-keeper' (by the way who is he, and what is his real name?) says, 'I first received these bees safely in 1886.' How is it, Messrs. Editors, if these bees have been introduced so long, and (as reported in the same article) 'construct hundreds of queen-cells,' that some of your able correspondents have not met with them, or given us some account of them? The introduction of a single queen in 1886 that would raise hundreds of queen-cells would, I should have thought, in

skilful hands, have stocked the whole country by this time. But what does he say? 'I am afraid that I could not count on more than 100 queens in one season.' 'I am charging 5*l.* 5*s.* for them in this country for what I have to spare, and I must say that I consider them cheap at the price.' One can hardly think that any one could be found so rich as to pay this amount for the queen of a Punic race, of which so little is known after seven years in this country.

Will you, Messrs. Editors, for the benefit and protection of your readers, give us any information as to the value of this bee, and what is known of it in its own country? Reference is made to *Cleanings*, the *American Bee Journal*, and the *Ganadian Bee Journal*. Could you give any of the articles?—INQUIRER.

[As a rule we do not like to import into our columns controversies originating in other journals, but as our correspondent asks for information for the benefit of our readers we give all we know about African bees. We know nothing of the experience of the persons mentioned, and have received no reports from any of our numerous correspondents about Punic bees. We know of no such race. Amongst African bees with which we are acquainted are those from Algeria, Morocco, and Tunis—all varieties of *Apis mellifica*. They are prolific black bees, said to be good workers, but which have not sustained their reputation when introduced into Europe. Queens of any of these varieties could be purchased for a few francs, and some years ago Algerian queens were offered for ten francs apiece by M. Feuillebois at Beni-Amran. The variety cultivated by the Kabyles is shiny black, and the workers much smaller than the average European bee; the drones, however, are quite as large. The Kabyles inhabit the mountains lying towards the desert of Sahara, where they live in small villages, and derive a considerable income from honey, and more particularly from wax. These bees are called '*thizoua thik' arrin*,' and are cultivated in cylinders of cork-bark, basket-work, or earthenware. Some of the natives have as many as 500 such hives. They were first imported into France in 1874, and, by their behaviour, showed that they came from a warm climate. They are great propolisers, which shows that they are not used to cold. Although quiet at times, if stimulated they become very savage, and not only attack persons, but even enter the houses in their vicinity. They have not proved satisfactory in Europe, and we know no one now who cultivates them.

We know nothing about the so-called Punic bees and can give no information as to their value. Possessing as we do one of the largest libraries of bee literature in the kingdom, it is strange that we have never found such a race alluded to. The word *Punic* means faithless, treacherous—neither of which should be considered good qualifications for bees. Punic bees are said to come from Africa, but the only varieties of African bees we know of are those alluded to above, besides the various species mentioned on page 366 of *B.B.J.* for 1883. With regard to the American papers above referred to by our correspondent, the only other person besides 'A Hallamshire Bee-keeper' (otherwise John Hewitt) who has written in favour of Punic bees, is E. L. Pratt, a queen breeder and dealer, who is advertising queens imported by 'Hallamshire Bee-

keeper' at 80 dollars (16*l.*) each. We wonder how many bee-keepers will be induced to give this price, or even 5*l.* 5*s.* for one. As so little is really known about these bees we hardly think it necessary to advise our friends in their own interests to wait for reports from experienced and well-known bee-keepers. We shall take care to give any reliable information that may come to hand and be of value to our readers.—EDS.]

NOTES BY THE WAY.

[755.] The weather during the past week has been very unsettled, harvest operations practically at a standstill, while the heavy rains have laid a great part of the corn uncut. This is rather a gloomy prospect for the farmer, though the enhanced prices the breadstuffs are fetching buoy his spirits and brightens his future, if only the weather will take up. The showery weather has suited some jobs, and in my extensive apiary, I have found it an opportune time to secure the honey crop. In the southern part of the kingdom all supers should be removed from the hives, and any spare combs in brood nest should be extracted, and the combs returned during the evening for the bees to clear out, or use if space is required by the colony. If combs or crates of empty combs in sections for the bees to clean up for another year are returned late in the day, the excitement which is always engendered by the sudden influx of honey will be practically over before the morning, and the colony subsided to its normal condition. This is a matter that requires care on the part of the bee-keeper, or robbing may start, and possibly a loss of stocks.

The Berks Bee-keepers' Association has lost no time in dealing with the grant of 50*l.* from the Berks County Council. The executive of the Berks B.K.A. appointed a sub-committee of practical bee-keepers to consider the best means of applying the money to the advancement of humane and profitable bee-keeping amongst the bee-keepers of Berkshire, and in the first place it is intended to send experts to every bee-keeper in the county, as far as possible, not to manipulate or dismantle his stocks, but to give advice where needed and gather information respecting the craft; each expert will be provided with a map of Berks with his part of the county shaded off, and with a tabulated book in which every particular will be entered as to the number of stocks, the owner's name and address, straw hives or bar frames, average output, brimstone or humane system, &c. He will also make arrangements for lectures in certain centres during the winter months. Then, when we have gained this desirable information, and know where the bee-keepers are located, we intend to start quite an innovation in the propaganda of modern bee-keeping, and that is, that another spring we intend to start a 'Berkshire bee-van:' this van will reach places remote from towns where shows agri- or horticultural are held, and where demonstrations have been annually given—the idea is to introduce the bar-frame hive to the notice of

the bee-keeper on the village green, or the rectory or vicarage lawn, and give practical demonstrations and advice in the garden of the bee-keeper on the management of bees in bar frame hives. This, we believe, will induce more bee-keepers to adopt the movable-frame hive and be the means of reaching and teaching a class of men amongst the more intelligent labourers the advantages of keeping bees.

Then, in our extensive tour, we intend to distribute leaflets, showing the advantages of belonging to the Berks B.K. Association, and what benefits the cottager will get for his small investment of 2s. 6d. per annum in the Association: how the expert will visit him, and teach him how to proceed; that he will get a copy of the *Bee-keepers' Record* gratis, in which he will be kept posted in advanced bee-culture; that he will participate in the great advantages of selling his honey through the appointed agents of the Association at a fair price, and the use of the extractors—one of which is located in certain district centres. Then we hope and intend to interest others outside our craft in behalf of the cottager. Of course we cannot give all the aforesaid benefits for 2s. 6d., only we shall want the friends and the labourers to step into the breach and help us. Thus, a lady or gentleman can, by subscribing 10s. to the Association, help four of their poor cottage neighbours, or 5s. per annum help two cottagers to the full advantages of the Association, and it is proposed that these subscribers shall have the privilege of naming the cottagers whom they wish to befriend. This will be introducing the practical system of helping one another, and also at the same time helping those who try to help themselves.

Foul brood is a subject our experts will be instructed to locate and tabulate, and the executive will give the matter of dealing with the subject further consideration, as to the best means of eradicating it from the county. This subject is of such vital importance to the craft that every effort should be made in curing the disease, though I am not sanguine of success until we get the legislature to include foul brood in the 'Contagious Diseases Act,' and make it penal for bee-keepers to knowingly and wilfully keep diseased stocks of bees in their possession. I have no doubt that the pest is spread more at this period of the year than at any other, owing, as you pertinently remark in last week's 'Useful Hints,' on the predatory habits of bees.

The sad death of our brother bee-keeper, Mr. Clements, is another illustration of the need of some supervision by the legislature in the ingredients used in dyeing textile fabrics. It is nearly as bad as 'death in the pot' to be subjected to a slow lingering death by poisoning from inhaling poison from carpets or wall-papers.

Glass sections seem to have fallen out of the running, at least we hear nothing about them this year; I suspect the patentee has not found it a very lucrative speculation. Mailing queens and safe introduction have been reduced to an almost certainty by Mr. J. H. Howard's queen-

cage. This simple though efficient little apparatus introduces the queen and her attendants direct, and completely does away with the old method of handling the queen to place her in the introducing cage, and thereby endangering her life, either by injury while handling, or by giving an offensive scent to the queen by handling, which the bees it is intended shall receive her may resent, and object to receive her. The food compartment is the outlet for queen and attendants at the will of the bee-keeper, while during the time the bees are discovering their queenless state the new arrival is in a position where she and the bees with her are receiving the scent peculiar to the hive. She is to be introduced to them in the gloaming—a gentle push, and the introduction is mutual and safe. I can speak from experience, in fact, all my experience has been on the same lines; that is, I have always introduced in a similar manner, rarely touching a queen with my hands, and my losses have been few and far between. I have always introduced the attendants with the queen, and have never noticed them thrown out next morning, though I have looked for them many times.—W. WOODLEY, *World's End, Newbury.*

NOTES ON BEE-KEEPING IN HUNTS.

[756.] The honey season in this district is over. Where no surplus has been gathered it is now too late to hope for any, and the sooner stocks are prepared for the winter the better. The season has been what the majority of bee-keepers in this neighbourhood term a bad one. The nights throughout the summer have been very chilly, and the days during the last six or eight weeks have been for the most part cold and showery.

There are a few cases, including my own, where bees have done well. Nearly every bee-keeper that I have met complains of the great difficulty that has been experienced in preventing swarming. This appears to have been an exceptional year for swarms, and many a bee-keeper has been driven to his wits' end to know what to do for the best. Personally, I very rarely have any trouble from that source. I keep bees for profit, and cannot afford to let them waste valuable time in swarming. During this wonderful year of swarms I have had five from about twenty stocks; this is a larger percentage than I have had for a number of years. But I did nothing to prevent these, but rather hoped they would swarm, as I had got several empty hives, and was also anxious to obtain some young queens. Two of the said five swarms were hived on ready-built combs, and supered forthwith. They have established themselves for the winter, but have given next to no surplus. The stocks from whence they come ceased working in supers from the time the swarms issued. The other three swarms were treated in a different way. After taking away from each hive that had swarmed three frames of brood, bees, and queen-cells, with which to

form nuclei, and substituting for some three frames of foundation placed in centre of hive, the swarms were returned, and all went on as merrily as though nothing had happened. The nuclei thus formed have been built up into first-class colonies at practically no cost, while the stocks made from the two swarms have cost, by way of honey sacrificed, something like a sovereign each. My stocks worked for run honey have been less trouble, and have given by far better returns than those worked for sections. I am sometimes asked if the present season has been an average one, which question I am quite unable to answer, for the simple reason that I do not understand the term 'average' as applied to bee-keeping. Nor do the Editors, in their reply to 398, page 363, that 'forty pounds per hive is a fair average,' help me at all in the matter. I am willing to believe that in a good season a well-managed apiary could be made to yield an 'average' of forty pounds per hive. But I have a very strong belief that, however perfect the management, it would be a most difficult job to make an apiary of any size produce that average for a period of, say, ten years. And if statistics could be procured, showing the total number of hives kept on modern principles in Huntingdonshire during the last ten years, the average would be—but stop! it is my aim to encourage and not dishearten bee-keepers, so what I was going to say I will leave unsaid, for perhaps, after all, the term 'average' has a different meaning to what I have attached to it. Nevertheless, if any one can furnish data, showing the average yield per hive in the true sense of the term, it would afford most interesting reading, and would be of special benefit to those who may anticipate embarking in bee-keeping on a large scale.—A. SHARP, *Huntingdon*.

NOTES FROM NORTH YORKS.

[757.] I send you a little bee-news from the north of Yorkshire. We have a few hives infected with foul brood, and find it a difficult thing to rid a district of when once it gets a foothold. The disease first appeared in one of my weak stocks, so I destroyed the colony and all its belongings, and fed my other stocks with food medicated with Naphthol Beta. They have been very healthy and prolific this season, not a trace of the disease being present; but I learn it has appeared in other hives in the district, and until we can get bee-keepers to understand the infectious character of the disease, and until we have some law to deal with it, the plague will not be got rid of. We have a Board of Agriculture, and, seeing that swine fever and pneumonia in cattle is looked very sharply after by the Government officials, I think that foul brood should be included in the Contagious Diseases (Animals) Act; until then there is little hope of stamping it out. The Yorkshire Bee-keepers' Association are to be congratulated on the grand display of honey and appliances at Bradford; it was certainly a better show than the 'Royal' at

Doncaster, the honey being of the finest quality and of the best colour. I think if the honey had been on raised shelving it would have shown itself better. I wish the British Bee-keepers' Association could see their way to hold an apicultural show of their own in some central place, later on than the 'Royal,' as it is too soon for honey of any kind—and include driving competitions, &c., as well as the usual prizes for hives and honey. I think it would be well patronised, and in a few years prove a great success. The honey harvest up here has not been up to the average, on account of the shortness of the season, it being very late, and the wet weather coming in July, right in the middle of the season. It has rained nearly every day since, and as I am writing it is still 'coming down.'—JOHN BAMBRIDGE, *Hutton Rudby, via Yarm*.

WEARING BEE-VEILS.

[758.] I send you the enclosed portion of the *Sheffield Telegraph* for the 21st inst., with an account of a rather bad adventure with bees while taking hives to the moors.

I am struck by the fact that a bee-keeper of any experience, as one may presume Mr. Dixon to have been, should have attempted to set right the hive with escaping bees without the protection of a bee-veil. The bees would, no doubt, be in a state of irritation from the jerking of the vehicle over the road, and this he should have known and taken into account.

Is not the practice of experts at our bee-shows rather conducive to this want of precaution? So far as my experience goes they always manipulate without veils. This, no doubt, has its advantage in showing that bees *under favourable conditions* can be reduced to a state of almost absolute harmlessness. But for those whom these displays are intended to instruct I conceive the result is, to a great extent, misleading, and eventually ends in many being discouraged from the pursuit.

Would it not be better for a large part of such public manipulations to be carried out *with the use of the veil*, and thus show that almost absolute immunity from stings can be secured even by the most timid? I find by experience that the use of the veil is the most effective advocate amongst would-be bee-keepers, and even with those who have been accustomed to skeps for many years.

While writing I should like to add that following your advice last autumn I burned the bees, combs, &c., of one hive attacked with foul brood, and have used naphthaline since with, so far, satisfactory results, for I have seen no sign whatever of the infection in my ten other stocks, though at first I had reasons for suspecting its presence to some extent. I am quite satisfied that naphthaline is at least an excellent preventive.—W. WINTERTON, *Northants*.

[Referring to the cutting sent we need not print the needlessly sensational account it gives of a mishap which could only have resulted from care-

lessness in preparing hives for a journey to the heather. Newspaper men usually allow their imagination pretty free play when reporting these cases; at least, we invariably find it so on inquiry. It may be said, however, that a Mr. Dixon, of Hexham, accompanied by his son, was taking some hives of bees to the moors in a pony trap. He had several hives inside the trap and several fastened outside. While on the journey the bees from one of this latter—as we may well believe—began to escape, and Mr. Dixon being unsuccessful in securing them, according to the report ‘the whole hive escaping and immediately attacking their owner, &c.’ Afterwards the pony was stung, and started off, upsetting some of the other hives, and causing, no doubt, some mischief; but in the end we read that ‘Mr. Dixon and all concerned are fortunately recovering from the effects of the accident.’ It goes without saying that when bees are prepared for a journey they must be safely packed so as to prevent any possibility of escape. This is so easily done by any one with the needful experience—and no others should attempt it—that most men will carry their bees to the heather for years without a mishap of any kind. We quite agree with our correspondent regarding the use of bee-veils, and the teaching of this *Journal* is always to the same effect. An expert in the tent may discard his veil to show that under certain conditions it is not needed, but should impress on his auditors the necessity for its general use when working amongst bees, except when stocks are known to be so quiet in temperament as to make it needless. In every case, however, the veil should be on the hat, ready for use.—EDS.]

Queries and Replies.

[402.] *Inconsistent Showing.*—There has been some ‘in-and-out running’ in our local shows of late. This does not necessarily imply dishonesty, but the extremely varying quality of honey shown by the same exhibitors at different places give some ground for doubt. Perhaps, Messieurs les Editeurs, you will help the doubters to a just decision by giving your opinion upon the following cases:—A. and B. who are near neighbours, competed along with others in the extracted honey classes of a show held at C. A. could, presumably, have shown in the three classes, but chose to confine himself to one of twelve bottles. His was a nice exhibit of light amber honey. B. (who is no novice in the craft) showed honey of a dull mahogany colour in the three classes. He could not, he said, produce any better this season, and was quite perplexed to see the exhibit of his neighbour and erstwhile pupil. A show at D. followed, whereat B. showed honey much superior to what his neighbour had shown at C., while A., besides showing the twelve bottles exhibited at C., showed also twenty-four bottles of honey, almost, if not quite, identical with that shown by B. at C. What I wish to know is:—1. whether, in your opinion, A.’s exhibit at C. was that of honey produced by his own bees? 2. Whether it was possible, as he averred was the case, that one of his stocks could have produced the light honey, and the remaining stocks of the same apiary the dark? It was all super honey,

it should be remarked. 3. Whether it was possible that A.’s bees could have produced the very superior honey exhibited at D. between the 22nd of July and the 10th of August of the present season. The quality of the honey gathered prior to the former date should be borne in mind.—J. M., *August 17th.*

REPLY.—1 and 2. While there is much reason for doubt, we could not venture to say it is impossible that A.’s honey could have been gathered by his own bees. B. may have allowed early honey from fruit-bloom or from sycamores to get mixed with that from clover, and so deteriorated the lot, while that of A. was a carefully graded sample. There may be several details known only to A., which would explain the matter. 3. This looks very bad for B, but nothing more appears against A., since the latter only showed honey in addition at D. such as he averred was gathered by all his stocks save one. Viewing the whole facts, we can only say they are strongly suspicious; but stranger things in connexion with bee-keeping have been reported to us which, when clearly and fully explained, were quite capable of proof. Bee-keepers living in the district, and knowing all the surroundings, should be far more capable of forming an opinion than ourselves of the cases in point.

[403.] *Hiving Swarms without Guide Combs.*—Besides being a reader of the *B. J.*, I am quite a beginner in bee-keeping, and am often struck with the information that can be learnt from its pages. I have however got myself into a difficulty, and shall feel grateful for your advice. From my one bar-frame hive I had my first swarm on June 5th, and they are doing well. On June 19th a second swarm came off quite to my surprise, as I had given a second crate of sections to prevent another swarm, and had no hive in which to put them. However I bought one from a friend and got the bees in all right, but, having no foundation at hand I had foolishly put in the frames without guides. The swarm has done well, but, as you may guess, all the combs are built very crooked. 1. Could I (after they have done breeding) take away the misshapen combs and fill other bars with foundation, so as to get them rebuilt straight, if I fed the bees well? 2. What kind of syrup would you advise for feeding? They have six frames, all full of bees. I fed them on syrup made from No. 3 recipe in *Bee-keeper’s Guide-book* for a fortnight after hiving, the weather at the time being dull and wet. 3. I have noticed a great many bees on the raspberries, feeding from the fruit. Is this usual?—G. L., *Bradford Abbas.*

REPLY.—1. The task of straightening the crooked combs would be beyond the skill of a beginner, and you will not get satisfactory new combs built so late in the season as this. If you cannot get the help of an expert or some one sufficiently experienced to examine the hive and put it right, or advise the best course after inspection, we should leave it as it is. The bees will stand a better chance of wintering safely on the crooked combs than if a bad job is made of

an attempt to remedy them. Next year you will be better prepared to put the hive straight. 2. Same as before. 3. The skin of the raspberries must have burst from the wet weather, or being over-ripe. Bees do not attack the fruit except under some such conditions.

[404.] 1. *Dome Shape v. Flat Top*.—I have heard it repeatedly stated that bees winter better in dome-shaped skeps than in those with flat tops. If your experience confirms this, I should be glad to know how you account for it. Is it because the moisture that would condense on the top would trickle down the side, whereas, with a flat top, it might drop on the cluster, and, during a long spell of cold weather, lead to disaster? If so, would not tilting a bar-frame hive on one side, so as to cause the quilt to be of such an angle, have the same effect? After brood is all hatched, it could have no ill effect that I can see. External appearances might be against it, but if bees wintered better with hives in this position that would be an ample set-off. Of course, raising a dome over the frames would answer the same purpose: but, I take it, the necessary angle would leave too much space above the frames. 2. Have you had any experience in wintering a stock with a shallow-frame super on? I am thinking of trying one this winter with a very strong stock. 3. Can you suggest anything to prevent winter syrup from granulating beside so-called malt vinegar? If cream of tartar, or tartaric acid, would not answer the purpose, would acetic acid, such as I use for making raspberry vinegar, one part acetic acid and seven parts water, do?—W. H. JENKINS, *Swansea, August 13th*.

REPLY.—1. In principle the dome shape has some advantage in the heat rising to the highest part, but we never found bees wintered any better in dome-shaped than in flat-topped skeps, and rather think that any disadvantage the latter may possess arises through carelessness in failing to carefully cover up the large openings usually found in the flat-topped skeps. In neither case will condensed moisture 'drop on the cluster' if the bees are sufficiently numerous to maintain a proper temperature in the hive. We should never advocate tilting frame hives to one side as proposed. All sorts of mischief might result from such a practice in careless hands. 2. Yes, and stocks have come out remarkably well under such conditions. 3. Acetic acid will answer the purpose very well, using about one-half as much acid as of ordinary malt vinegar.

[405.] *Transferring from Skeps to Frame Hives*.—1. Is it necessary to move the laths with which transferred brood comb from old skeps is fastened into standard frames with tapes? I have removed the tapes, but in attempting to take off the first lath at bottom I found it fixed so firmly that all the comb fell out with it; I therefore left the others. 2. In feeding the bees for the winter, how am I to know what amount of syrup to give each stock, and will the Barbadoes sugar (brown) be the right kind? I purchased the bees from our

gardener about two months ago: they were then in old straw skeps, and much neglected. I have since made six frame hives, and transferred bees and brood comb into them, uniting two lots where they were weak, feeding until they appeared to be settled. They all seem to be doing well now, and are increasing in numbers fast. No honey will be taken from any of them this year, and I thought with a little syrup to help them they would store enough to carry them through the winter.—A TWO MONTHS' BEE-KEEPER, *Kings Langley, Herts, August 15th*.

REPLY.—1. Laths, when used to support combs, should certainly be removed, but not before the combs are sufficiently secured by the bees to warrant such removal. 2. Refer to *B.J.* for January 15th for full information on feeding bees for winter. You shape well in your bee-keeping to accomplish so much after so short an experience. Transferring old combs into new frame hives, however, is now rapidly going into disuse, and we may hope you have only two or three such frames of comb in each hive, the rest being built on foundation.

[406.] As I am compelled to move my eight stocks of bees which are in frame hives, when is the best time to move them, now or in the spring? After losing several of my stocks during last winter I think you will say I have done very well with the remainder, viz., two stocks. During the first three weeks in July, I took from them ninety-one one-pound sections, and got four good strong swarms. Bees in this neighbourhood have done nothing this month, owing to the cold sunless days. 2. I was obliged to gather some ripe pears from a tree to-day, owing to the bees eating them: I have not noticed this in other years.—II. C. S., *Littlehampton, August 18th*.

REPLY.—1. Bees can be safely moved either during the cold of winter or, perhaps better, about the end of February. At the latter date they will be lighter, and have little brood to take any possible harm. 2. Bees will not break the skin of pears. If they are over-ripe and cracked, or if wasps make the first attack, bees will suck the exposed juice, but not otherwise.

[407.] *Bee-houses*.—Do you think bees have a better chance of wintering in a wooden bee-house, where they can be kept dry, and, if necessary, warmer than standing outside, exposed to all weathers? My stocks were unusually strong last autumn, but they dwindled down a good deal this spring, and I am thinking of having a house built for the hives. I only keep ten bar-frame hives, which are as many as I have time to look after. Of course, I should like to obtain the best results.—R. C., *Doncaster*.

REPLY.—Bees will do very well in properly constructed bee-houses, but as a rule they yield more satisfactory results when kept in the open on separate stands. The fact of your bees dwindling cannot justly be charged to the want of a bee-house to keep them warmer, as our most successful men keep their bees on single stands.

[408.] 1. *Unnecessary Stimulating.*—I see in the *Bee-keepers' Guide-book* that we are to prepare the bees now for winter by *stimulative* feeding. Does that mean that I am to give them *flour candy* or syrup? 2. I have removed all section racks from the top of the frames, but find they have a great deal of honey in the body of the hive—more than they will consume during the winter—I should say ten frames full. When ought I to take, say, one or two frames away, as at present they are all crowded with bees? I have *no* extractor. Perhaps you will be interested to hear that I bought a 'W. B. C.' hive last spring. On the 30th May I put a strong swarm into it. Since then I have taken two racks of twenty-one one-pound sections off, all beautifully sealed over, and find that all ten frames in the body of the hive are *full* of honey. I have never had such luck with a hive before, and shall certainly have no other but the 'W. B. C.' for the future.—HORATIO EDENBOROUGH, *Egham, Surrey.*

REPLY.—1. Hives with abundance of natural stores need no stimulating in autumn. The axiom, 'Enough is as good as a feast,' holds good with bees as with other things, and to feed stocks already stored to repletion is useless. Stimulate in spring, if needed, but not now. 2. Unless the honey is especially wanted, we advise leaving the bees all the brood chamber contains. Probably at end of September the quantity will not appear more than enough. Pray do not suppose we claim that the hive you refer to will enable your bees to gather more honey than others. At the same time, we are very pleased to learn that you like it.

Echoes from the Hives.

Honey Cott, Weston, Leamington, August 21st, 1891.—For three weeks the weather here has not been good for bees, though the white clover is in bloom still; but the temperature is too low for much honey to be gathered from it. I have got a nice lot of honey, but not anything like a full crop. Have been driving stocks a few miles away, and find that the bees have done about the same, or hardly as well, elsewhere as here. I never noticed before anything like this:—A cast had three-parts filled its hive with honey, and nearly all drone comb. On the latter attempts had been made to start three or four queen-cells. I suppose the queen must have been lost while on her mating flight. The old man—who is nearly eighty years old—to whom the bees belonged, said he should not have cared if some more of his stocks had lost their queens, if they had only gathered as much honey as this cast. I drove four or five lots for him, but he still prefers the brimstone-pit to the trouble of driving. The old man and his niece have had good yields for three or four years from two bar-frame hives, but this year these same hives have not done so well. I have used Flood's bee-escape, and it has answered fairly well, although in one case of

a strong stock I placed an empty crate under the escape, and the crate of sections on top, and every bee was not out in two or three days. I am glad to see 'X-Tractor' is all right again. I will let him off this time (for his prophecy anent the weather), because we read, and I have also heard, of some rather heavy takes of honey, showing, at least, that in some parts of the country there must have been some hot weather accompanying the extra large crops of white clover. When I visited, about a fortnight ago, my small out-apiary, I found two out of the three stocks queenless, so I took some nucleus hives, and joined them, and also found the hives crammed with honey.—JOHN WALTON.

Morchard Bishop, August 17th.—I have been using the cone super-clearers lately, and find them succeed admirably. I put them on at breakfast-time and remove after my morning round—twelve to two p.m.—with only about half-a-dozen, or less, bees left. The weather here for the past month has been wretched—next to nothing done.—W. F. TRONSON.

BEE AND HONEY STATISTICS.

In Greece there are 30,000 colonies, producing 3,000,000 pounds of honey; in Denmark, 90,000, producing 2,000,000 pounds; in Russia, 110,000, producing the same; in Belgium, 200,000, producing 5,000,000 pounds; in Holland, 240,000, producing 6,000,000 pounds; in France, 950,000, producing 23,000,000 pounds; in Germany, 1,450,000, and in Austria, 1,550,000, each producing 40,000,000 pounds of honey.

Careful estimates put the number of bee-keepers in the United States at 350,000; over 10,000 of this number keep more than 500 colonies each. The value of the honey produced by them in 1889 was over \$100,000,000, and the value of the beeswax produced for the same year exceeded \$17,000,000.—*American Bee Journal.*

HOW TO CLARIFY BLACK AND DIRTY WAX WITH SULPHURIC ACID.

We have been experimenting for the past few days in rendering wax with sulphuric acid. Although we knew the Dadants and one or two others were using it with excellent results in clarifying old dark wax, somehow or other 'we hadn't got round to it.' For several months back we have been saving up our old inky pieces of wax, and, besides this, the scrapings from the floor, and other odd accumulations from broken bits of comb. This week we procured some sulphuric acid, and proceeded to clarify first the dirty scrapings from the floor, putting them into a copper boiler holding about half a barrel. We first put in about two pails of water, and then about three ounces of sulphuric acid, and afterwards the scrapings. We next let on steam, until the wax began to come to the top. We first dipped off the clear wax floating on the surface, and poured it through a cheese-cloth bag. We next scooped

out the residue, including the dirt, dumped it into the cheese-cloth bag, put it into our wax-press, and squeezed it under a gentle and increasing pressure. The wax, as it oozed out, ran into the vat, and, upon cooling, proved to be nice yellow wax. On former occasions, the same treatment, without sulphuric acid, would give us wax about as black as ink—or, at least, of a very dirty and muddy colour. The action of the acid is to carbonise, or, in other words, burn the organic matter, and this frees the wax that is mingled with it, and allows it to separate and rise to the surface. We have repeated this operation with sulphuric acid on several lots of very dirty cakes of wax, many of them almost perfectly black, and each time we had as a result several nice yellow cakes of wax and a small pile of black organic matter that had been freed by the acid. We followed the proportions given us by friend Salisbury in a recent article, viz., about a pound of commercial sulphuric acid to about a quarter of a barrel of water. Into this we introduced a steam-pipe, and then filled up the receptacle with the wax accumulations, or dark cakes of wax which we desired to lighten up. Sulphuric acid, mixed in water in the proportions given, will not make a solution strong enough to be corrosive to the hand, nor dangerous to the bees after it has been remelted and worked over into foundation. We expect to render all our dark wax into nice yellow cakes, so that it may all be of good colour, and ready for use this fall, or for next season's trade.—*Gleanings*.

Notices to Correspondents and Inquirers.

Letters or queries asking for addresses of manufacturers or correspondents, or where appliances can be purchased, or replies giving such information, can only be inserted as advertisements. The space devoted to letters, queries, and replies, is meant for the general good of bee-keepers, and not for advertisements. We wish our Correspondents to bear in mind that, as it is necessary for us to go to press in advance of the date of issue, queries cannot always be replied to in the issue immediately following the receipt of their communication.

All queries forwarded will be attended to, and those only of personal interest will be answered in this column.

W. F. T. (Morchard Bishop).—*Honey from Foul-broody Hives*.—May be safely used at table, but not for bee-feeding. In following the 'starvation plan' of cure, the bees are usually kept without food till they begin to fall from the cluster through hunger; they are then put into a clean hive, and fed on syrup (not phenolised, as yours was). Healthy combs, or combs alternated with full sheets of foundation, are then given, and plenty of good syrup food. *Naphthaline* is not used in food at all. It is a disinfectant or preventive of the spread of foul brood. Naphthol Beta is for use in the food, as has already been stated in our columns.

ELM GROVE (Taunton).—No. 2 sugar is better for bees than No. 1; but we do not consider either is cane sugar. No 1 certainly is not.

M. R. SOWREY (Glos.).—There is nothing wrong with comb sent, so far as can be judged from the thin strips sent. A larger piece of comb

might help us in comprehending it, but no alarm need be felt.

J. MAINMAN (Knaresboro').—There is no outward sign of ailment about queen sent, and the body is too dry for post-mortem examination. The other portion of your query is too vaguely worded for us to comprehend it.

ORCHILL (Alloa).—Mr. A. Pettigrew died several years since.

G. F. (Chichester).—Comb sent is foul-broody, but not so bad as to make cure improbable if care is taken and proper remedies applied.

BETA (Guildford).—Oilcloth, as sample sent, will do admirably for covering frames, keeping the glazed side down, of course.

NOVICE (Salisbury).—*Straining Honey*.—Muslin if not very fine indeed, will pass any honey save that from heather. Slightly damp the muslin, and tie it over the mouth of a tall earthenware vessel (say, a bread-mug), and allow sufficient 'sag' to hold half-a-dozen pounds; it will then assuredly pass through. Sections may now be removed from all hives save those in heather districts.

CORRECTION.—The reply to our correspondent 'H. B.' (Wonston) last week, should read 'nothing should be done in the autumn,' and not till the autumn.

J. TREBBLE'S BEE HIVES.

All Machine-made.

My 8/6 COTTAGE HIVE beat all comers.

Awarded Seven Prizes this year. Catalogue free on application to J. TREBBLE, Saw Mills, Romansleigh, South Molton.

British Bee Journal and Bee-keepers' Record.

OFFICE :

17 KING WILLIAM STREET, STRAND, LONDON, W.C.

PURE CANE SUGARS.

For the accommodation of Bee-keepers, guaranteed Pure Cane Sugar will be supplied in large or small quantities through this office at the under-mentioned rates:—

CRYSTALLISED.

4. DEMERARA	} Neat bags, 14-lbs. 28-lbs. 56-lbs. Cwts.
5. BARBADOS	
6. TRINIDAD	

REFINED CANE.

7. WHITE CRYSTALS (Small)	3/0	5/10	11/6	22/6
8, 9. (Medium and Large sizes, 1/- per Cwt. extra.)				
10. LUMP (Cut Loaf) ... Boxes,	3/3	6/3	12/3	23/6
11. LUMP DUST ...	3/0	6/0	11/9	22/9

All above guaranteed made from CANE SUGAR only, and free from BEET, CHEMICALS, etc., etc.

CARRIAGE PAID on Orders over 5/0 (or 28-lbs. Sugar) to London and Suburbs.

COUNTRY ORDERS, not less than 2-cwt. carriage paid at 1/0 per cwt. extra.

(Scottish and Irish orders, special arrangements.)

Cash to be sent with order, and purchasers will please observe that if samples are required or replies asked to inquiries, a stamped addressed envelope must be sent, as we cannot undertake cost of postage.

Special Prepaid Advertisements.

Situations, Publications, Bee Plants, &c.—Twelve words and under, Sixpence; for every additional Three words, One Penny.

Trade Advertisements not inserted under this head.

WANTED.—1-lb. Sections of Honeycomb, first quality. Prompt Cash. Packages sent. Well-filled Bell Glasses, Frames and Caps purchased. Address Mr. HURST, Heath, Warrington. 242

HONEY JARS, Tie-over, ½-lb., 1-lb., and 2-lb. Price List Free. Address FRED. PEARSON, Stockton Heath, Warrington. 243

WALLFLOWERS will give splendid forage for Bees in Spring. Fifty plants, 1s., post free. Address NORMAN PARKIN, Blakenhall, Wolverhampton. 83

CARNIOLAN QUEENS, wonderfully prolific strain, guaranteed healthy and laying, 2s. 6d. each, 10s. half dozen, carriage paid. Address H. NEVE, Warbleton, Sussex. 91

FOR SALE.—Healthy Driven Bees, 1s. 3d. per lb., and Queen. Packing-box, 6d. Young Queens, 1s. 6d. each. Address E. GARNER, Broom, nr. Biggleswade, Beds. 93

FOR SALE.—Driven Bees, 1s. per lb., 1-91 Queens. Carniolan Queens, 2s. each free, or Hybrids. Address A. NICHOLLS, Hazlemere, High Wycombe. 95

FOR SALE.—Driven Bees, 1s. 3d. per lb., including Queen. Guaranteed healthy. Queens, 1s. 6d. each. Also 24 dozen 1-lb. Sections, fine quality, First Prize at Hailsham Flower Show. What offers? Address J. FAIRALL, The Church, Hellingly, Sussex. 98

DRIVEN BEES, 1s. per lb., box 1s.; Young Queens, no disease. Extra Queens, 2s. each. Forwarded end of August and early in September. Address S. OATEY, Expert, Prior's Farm, Pitminster, Taunton. 99

WANTED to Purchase, Black English Queens or Driven Bees, headed by same. Prices to J. COOPER, St. Nicholas Square, Leicester. 11

DRIVEN BEES, 1s. per lb. Choice Queens, 2s. each. Address E. HANCOX, Sandford St. Martin, Steeple Aston, Oxon. 12

A RARE CHANCE for Bee-keepers.—For Sale, First-class Strain of Carniolan Bees, with very prolific Young Queens, in new, well-painted 'W. B. C.' Hives. Supers with Comb, and Frames with Fixed Foundation. Boxes with 1-lb. Sections, with Comb, Fixed Foundation, &c., all complete. The Bees carefully packed and put on rail only 3s. cash, worth 4s. Full particulars on receipt of stamped envelope. Extractor, quite new, 15s. Going abroad, because of ill-health. Address D. B. HOWS, Llanbrynmair, Montgomeryshire. 13

FOR SALE.—Five 1-91 Pure Native Fertile Queens, guaranteed healthy, 2s. 6d. each, post free. Safe arrival guaranteed. Three-Frame Nuclei, with Queen, 10s. Packing included. Address CHAS. WATKING, Valley Apiary, Hadden, Clare, Suffolk. 14

DRIVEN BEES.—Orders booked for delivery in September, 1s. per lb., in 4 or 5 lb. lots, headed by Young Queens, and guaranteed free from Foul Brood. Box, 1s., returnable. Choice Young Fertile Queens, 2s. each, post free. Safe arrival guaranteed. Address A. J. CARLLE, Newfields, Billingshurst, Sussex.

WANTED.—One or two acres of Land, with Cottage, within ten miles of London, in a neighbourhood, suitable for Bee-keeping. Apply to 'G.,' B. E. J. Office.

FOR SALE.—Having had considerable difficulty to obtain suitable Boxes for 1 lb. Sections, and bought larger quantities than required, I shall be pleased to sell at 4s. 9d. per gross, carriage free for cash with order. Address MARTIN, 4 Woodland Place, Path.

WANTED.—New Honey in 1 lb., 1½ lb., and 2 lb. Sections. State quantities of each size, and prices expected. Address Mr. ALEX. LEITCH, 208 St. George's Road, Glasgow. Terms cash. 247

ENGLISH QUEENS, tested, 2s. 6d. each, post free. Address C. N. WHITE, Somersham, Hunts.

CHEAP WOOD FEEDERS,

HOLDING ONE POUND OF SYRUP.

Can be used for Fast or Slow supply.

4d. each, postage 3d. No. 88 in List.

Bright Foundation, 1/10 lb. Darker ditto, 1/3 lb.

EDEY & SON,

STEAM JOINERY WORKS, ST. NEOTS.

THOMAS LANAWAY & SONS,
Bee Appliance Manufacturers

AND DEALERS,

26 STATION ROAD, REDHILL.

Catalogue post free on application. 2891

STEAM FACTORY for
Bee Appliances.

ORDERS addressed J. ROSS, Stranraer, Wig townshire, N.B., will be attended to.

BALDWIN'S

is the Oldest Establishment in the United Kingdom wholly devoted to Bees and manufacture of

Bee-keepers' supplies. His prices will compare most favourably with those of any other Maker, while for quality of material, suitability and workmanship, he has no rival.

'Why can he give better value for money than others?' Because he spends less in large 'puffing' advertisements, buys in the best markets for prompt cash, has no rent to pay, and personally conducts his own business.

For prices and full particulars of Goods see Baldwin's Bee-keepers' Instructor (and Illustrated Catalogue combined), which 'contains more practical and reliable hints than all the large, expensive books,' post free for 2d. stamps. Address S. J. BALDWIN, The Apiary, Bromley, Kent.

N.B.—More than 500 Silver and Bronze Medals, First and other Prizes, and Testimonials innumerable.

NEIGHBOUR'S BEE HIVES.

WELL KNOWN for SUPERIOR & ACCURATE WORKMANSHIP.

Every Description of APPLIANCES kept in Stock.

CATALOGUES FREE ON APPLICATION.

GEO. NEIGHBOUR AND SONS,

127 HIGH HOLBORN, LONDON, W.C. (Corner of Southampton Street.)

THE British Bee Journal,

BEE-KEEPERS' RECORD AND ADVISER.

No. 480. Vol. XIX. N. S. 88.]

SEPTEMBER 3, 1891.

[Published Weekly.]

Editorial, Notices, &c.

USEFUL HINTS.

WEATHER.—With bees for one's subject, the weather is so important a factor that, however willingly we would shut it out from the purview, it must come in somewhere—there is no help for it. Moreover, at a time like this, there is little else for the bee-keeper to talk about, seeing that it means so much to him. If the weather is fine, he has his good fortune for a theme; if bad, his disappointments; and the individual known as 'Mr. Useful Hints' must even seek for a comforting word or two for those who read him when the 'disappointments' predominate—as they do now. But, before penning the fortnightly 'Hints' in these columns, let us confess that the writer thereof is at present engaged in the not very onerous task of 'resting' for a fortnight in the North.

Here, then, as elsewhere, there is 'plenty of weather about.' We had not left the roar and bustle of London fifty miles behind before it became unpleasantly apparent that we were going further only to fare worse, so far as weather was concerned; and for a hundred miles or more the Liverpool express dashed along through torrents of rain. Everywhere the scene was dismal and depressing: cut corn lying out soaked and spoiling; cattle standing under the trees, looking about as miserable as was possible; and in some portions of the Trent Valley acres of land on both sides lying under water combined to make up a picture not very cheering to one off for a holiday. On nearing Crewe, however, the rain ceased, and for five days past the weather has proved a very fair counterpart of that experienced in the South for several weeks past. Sunshine and rain has been the rule North and South, but the latter has benefited by its heaviest rainfalls occurring in the night time, whereas here, in the North, heavy

showers have been frequent in the early part of most days, cutting off any chance of honey-gathering there might be. The honey harvest of the Northern bee-man thus becomes a daily diminishing quantity, and he naturally enough grumbles accordingly. Who can blame him?

Few readers will need to be told how completely our pursuit depends upon the weather for any amount of success, fewer still will fail to admit the truth of the homely saying, 'We don't make the weather;' and in the face of these truisms it may be said that the bee-keeping industry has fared very well indeed this year compared with others which, like it, experience good or bad fortune just in the ratio by which they are favoured by good or bad weather during their 'seasons.' Some one has characterised this as 'a summerless summer,' and bitterly complained of its effect on the toilers who look forward to the delights of a holiday in the country, but who have this year found their chief enjoyment to consist in the comfort of getting inside a suit of dry clothes after a 'wetting.' A writer in a leading morning paper with much truth observes:—

'The weather which we are at present very far from enjoying may fairly be described as almost unprecedented for the time of year. People with long experience, and of accurately retentive memories, declare, it is true, that the summer of 1860 was worse even than this one, which threatens to come to a close without having redeemed its character by a single week of consecutive warm and genial days. But it is a poor consolation to be told that nearly a generation ago people were making the same complaints, and suffering from the same disappointments as we are to-day; and, not without some cause, those who have betaken themselves to the country to enjoy the delights of outdoor existence are bitterly lamenting that all their attempts to extract diversion from *al-fresco* social gatherings end, one after the other, in exasperating failure.'

In closing our present 'weather' observations we will be selfish enough to hope that better days are in store for us.

SURPLUS QUEENS.—Seeing how useful a

few surplus queens preserved in nucleus colonies are at certain periods of the year, it is strange that more of them are not saved at swarming-time for future use. We see dozens of fine young queens cast out dead from swarmed hives, which, with a little trouble and hardly any risk, might have become the prolific parents of prosperous stocks, by simply forming nuclei and establishing them therein. Natural swarming usually occurs when the weather is sufficiently warm to minimise the risks connected with nucleus colonies, as well as from chilled brood. Besides, how often do we find the bee-keeper at his wits' end to discover the best means of preventing increase? He cuts out queen-cells or returns the swarm, only to find the latter very shortly re-issue and start his trouble anew. But if, say, a third of the centre combs, with brood, queen-cells, and adhering bees, are removed bodily from the parent hive, and replaced with foundation directly a top swarm has cleared out, the latter may be returned the same evening, and will rarely come off again; neither will it appreciably diminish the honey crop of the stock. Of course, all queen-cells found on combs other than those removed must be destroyed, but this is easily done when so small a number of bees as remain in the parent hive are being dealt with. The removed combs, bees, and brood, may then be formed into a snug little nucleus colony, and kept till wanted in autumn for building-up, re-queening, or a dozen other useful purposes.

AUTUMN FEEDING.—Preparations for this must now be thought of, and one of the first points in the preparatory stage should be the adoption of measures to avoid the beginning of robbing. As has already been urged in this column, wide entrances are the first temptation to marauding bees, therefore we would at once have them reduced to a couple of inches in width—weak stocks to one inch. Avoid open-air feeding at this season, and carefully protect feeders from the visits of strange bees. Surplus chambers, with a little unsealed honey in them, may be left till the contents are taken below. Or, if the bees are disinclined to appropriate the honey, a slight examination of the combs will not seldom induce them to carry it below. After the experience of last winter, we need not say anything by way of making good syrup for winter food, and seeing that cane sugar only is used for it.

STAFFORDSHIRE BEE-KEEPERS' ASSOCIATION.

The honey seasons have been so bad of recent years that we were pleased to see such a good display of the products of the honey-bee exhibited under the auspices of the Staffordshire Bee-keepers' Association. Taking the classes *seriatim*, the first was for specimens of bees, the first prize going to Ligurians, shown by Mr. J. R. Critchlow, and the second to Carniolans, exhibited by Mr. E. Clowes. For twelve 1-lb. sections of comb honey, for which four prizes were offered, there were nine entries, but only two exhibitors competed. For run honey there was a very large entry, there being no less than fifteen exhibitors, and the majority put in an appearance. The honey was generally of very good quality. For honey in any form, not to exceed 150 lbs. in weight, there were three good exhibits. Mr. H. Wood, of Lichfield, who was the largest and most successful exhibitor in the department, made an excellent display, tastefully arranged in pyramidal form, the honey being in receptacles of various shapes and sizes from $\frac{1}{2}$ lb. fancy glass jars to those containing $3\frac{1}{2}$ lbs. There were forty-eight 1-lb. sections, fifty-two 1-lb. jars, and in all 150 lbs., the honey being of very good colour throughout, reflecting much credit upon the exhibitor in a season like the present. In a new class for one 1-lb. section of comb honey (worker comb) and one 1-lb. glass jar of extracted honey, shown in juxtaposition, the prizes offered by Mr. E. Clowes and Mr. S. B. Fox attracted some good entries, and there was also a large exhibit of beeswax. We were sorry the prizes offered by Mr. A. H. Heath for exhibits from *bona-fide* labourers did not attract more entries. The Staffordshire Bee-keepers' Association is indebted to several of its members for the active interest they took in the show, and for enabling the Society to hold the show without trenching on its limited resources. The Leek Local Committee also kindly contributed several of the prizes. Mr. W. L. McClure, of Prescot, acted as judge, and we append his report on the prizes taken in the different classes:—

Class 1. Best specimen of bees exhibited with their queen in observatory hive.—1st prize, J. R. Critchlow, Maer Farm, Newcastle; 2nd, E. Clowes, Black Brook, Newcastle.

We hope to see an improvement in the way bees are exhibited in this class by a closer observance of the meaning of the words 'observatory' hive.

Class 2. Twelve 1-lb. sections.—1st, H. Wood, Paradise, Lichfield; 2nd, E. Clowes.

Class 3. Six 1-lb. sections.—1st, H. Wood; 2nd, E. Clowes.

In Classes 2 and 3 the exhibits were not numerous, nor was the competition severe.

Class 4. Twelve pounds of run or extracted honey.—1st, J. Hancock, Wesley Cottage, Al-sager, Cheshire; 2nd, E. Clowes; 3rd, W. Sten-

dall, Rodbaston, Penkridge, Stafford; 4th, Mrs. R. Wood, Bignall End, Newcastle

The prizes in this class were well competed for, and had they been arranged on stages so that they could be seen through the light, the fourteen exhibits would have made a pleasing show.

Class 5. Honey in any form, not to exceed 150 lbs.—1st, H. Wood; 2nd, S. B. Fox, Maer, Newcastle; 3rd, E. Clowes.

The cost of staging 150 lbs. of honey is too great to draw exhibits for such small prizes as can usually be offered by local committees.

Class 7. 1-lb. section comb honey, and 1-lb. glass jar of extracted honey.—1st, H. Wood; 2nd, E. Clowes.

A single section and a single jar of honey is hardly what should be an open class; as an encouragement to cottagers it would be all very well. I trust the committee will give some consideration to this point, especially looking to the fact that there was only one entry in each of Classes 9 and 10.

Class 8. Beeswax, not less than 2 lbs. nor more than 5 lbs.—1st, H. Wood; 2nd, T. Bailey, Baldwin's Gate, Whitmore, Newcastle; 3rd, E. Clowes.

I have referred to the want of staging. There is still another grievance which I trust the committee of management will look to at future shows, viz., to avoid placing honey near pigs. There is no pleasure in judging under such circumstances, and it must drive many visitors from the exhibit in disgust.—W. L. McCLURE.

TAKING BEES TO THE HEATHER.

I meant to have written the third of this series of letters long ago, but my intention met with the fate which so often comes to the schemes of mice and men, and I can now only ask my readers to find an excuse for my delay in the pressure of work which managing the Show of the Scottish Bee-keepers' Association entailed. One result of the delay is, that I must write about quite other matters from what I had wished. Swarming is now over; bee-keepers have for good or for bad raised their young queens. It is too late now to do anything to strengthen our stocks, and so make them fitter to gather honey this season. The honey harvest itself is finished in many places, and it is to the heather alone that we can now look for much return. Those who are lucky enough to have their bees within easy reach of the moors can hope for this return without giving themselves much trouble. Those who are not, ought now to lose no time in getting their bees moved to a suitable place. The choice of a place must greatly depend on the circumstances of each individual bee-keeper. He must find one where the shepherd is friendly, and to which the road is neither too long nor too rough. But if he does not wish to risk losing bees, he should move them at least three

miles—as the crow or the bee flies, not merely three miles by road—and he must remember that roughness is a relative term, and that a well-prepared hive can be taken across sheep-drains or broken ground with less risk than a badly-packed hive can be moved along a smooth high-road. In choosing a stance, remember that heather yields better honey when growing on a dry hill side than when growing in a moss, and when on high ground than on low ground; that young heather is better than old; that as bees usually fly a little distance before collecting honey, there is no need to have heather up to the hive mouth—indeed, it is often an advantage that it should be some way off, as this lessens the loss of bees in wet weather. If we can we should choose a sunny, bielded spot [sheltered —Eds.] where bees coming home have not to fly uphill, nor to rise over any dyke or fence close by the hives. If possible, there should be heather on all sides, so that from whatever direction the wind may come bees can always work on it, and yet have wind to help them home. We should avoid placing our bees where in coming back laden they have to cross a river or a big wood, into which heavy rain might beat them. If it is not convenient to find a stance right in the midst of heather hills, it is generally best in this district to choose a place where the great mass of heather lies to the north-west.

Having selected a place, we should get our hives ready to send them there. If not too much trouble, it is a good plan to send all hives. The chances are that they will lay up a better store for the winter than they would if left at home. But if sending all implies much work, send only the strongest. Unite any small hives to strong ones, or even join two middling hives together. The proverb tells us 'that ane horse weel whuppit is mony a time better than twa,' and one hive really full of bees is likely to gather a great deal more honey than two of moderate strength will bring in. In uniting, the younger or most prolific queen should be kept; the use of peasemeal, which I described in a former letter, is as simple a way of uniting as there is. It is perhaps better, but by no means necessary, to remove the queen which we do not mean to keep the day before we do the uniting. Do not brush away peasemeal which may remain on the tops of the frames; recent experience makes me think that its presence there tends to prevent brace combs. I also now feel sure that, from its more open grain, peasemeal is better as a bee-quieter than wheaten flour. The bees should be crowded so as to force them up into the supers, and therefore any combs not containing brood may be taken out, and dummies inserted at the sides of the brood-nest to fill their place. But it is best when the body-box is quite filled with frames of brood, the combs in which the most advanced brood is being in the centre. This last point is worth attention; nothing tends more to delay the time when bees *will* store the honey below instead of taking it into the supers than sending them to heather with frames full of newly laid eggs at the outsides, and frames from which

young bees will shortly hatch in the centre of the brood-nest. With the same object I advise spacing the frames close, though many good bee-men disagree with me on that point. Frames should be so secured that the hottering of the cart shall not move them out of their proper places. In my own hives this is done by fixing tacks at the ends of the top bars; but where metal ends are habitually used they may be relied on almost as well to keep the frames steady. A sheet of excluder zinc may be placed over the frames; perhaps I ought to explain what this is.

I had fancied all bee-keepers knew, but at Stirling Show I found a great many who asked me what excluder zinc was. When they asked me I felt much as the old woman must have felt when explaining to the Queen how hotch-potch is made. 'There's barley intil't, and there's peas intil't, and there's carrots intil't,' she explained. 'But,' interrupted Her Majesty, 'what is the "tilt?"' Excluder zinc is a sheet of zinc with holes punched in it of such size that though worker-bees pass easily through them the queen cannot. By its use we are able to keep our supers quite free from brood. The objection mostly made to it is that it somewhat hinders the passage of the bees upwards, but in a well-stocked hive this is hardly felt. I myself used to be much prejudiced against it, for I often found it not successful in keeping the queen down owing to faulty construction. I still prefer working without it, and only use it beneath large supers; but a new pattern has been brought out this year called the 'British' pattern, which seems better than any other, and can be got from any appliance dealer, and, on the whole, I should advise any one wanting good comb honey to use it. A sheet should be cut large enough to cover in all the tops of the frames and the clear passages at the sides, and is easily fixed with a tack in each corner. Over this we put whatever form of surplus chamber we use, whether a non-sectional super or a crate of sections. If we can supply these with fully or partly drawn out combs we give our bees a great help. The crate or super must be so fixed—again I use tacks—that it will not be easily displaced in the cart. A piece of cheesecloth, or any other cloth with an open texture, should be tacked over the super or crate. The object of this is that air may be able to pass freely in and out when travelling. It is of great importance that the surplus chamber should be kept very warm when at the heather, and for this reason plenty of hoppings should be provided, and may now be laid over the crate. All the outer portion of the hive should be secured to each other and to the bottom board. To effect this I use thin slips of wood nailed at each corner to the various parts. A simple way is to put nails or screws into the different parts, and fasten them tightly together with tarred twine. A piece of perforated zinc should be ready to tack over the mouth of the hive, though if this is not easily got, provided there is plenty of ventilation above, the mouth may be stopped up with a cloth just before the hive is moved. There are many hives con-

structed for easy removal to heather; several such were recently shown at Stirling, and one made by Mr. Robinson, of Hawick, was especially noticed by the judges as suited for this purpose, but any hive prepared as I have described would be able to travel safely on most occasions.

Having thus got hives ready, the next thing is to move them. This should be done at night for the sake of coolness. Have your cart standing ready—one with four wheels and springs, if you can possibly get it, is best, but I have seen an ordinary cart made quite excellent for the purpose with straw ropes and fir branches stretched across the frame. Stop up the mouths of your hives one by one, and remove the lid and all coverings except the cheesecloth; set the hives carefully on the cart, so that the combs run parallel to the direction in which they are moved. Pack on your lids and coverings as best you can, and get started. Travel slowly, and do not let the horse go jerkily. If you notice anything loose stop at once and put it right. The great thing is to have plenty of free ventilation at the top. When combs break down in moving it is generally because this has not been attended to. As soon as bees become excited, as they do when moved, the temperature of the hive rises, so that the combs run a risk of being partly melted and easily broken down; but as excited bees also run upwards where they can draw into an empty super, from which the heat passes off through the cheesecloth, this risk is greatly diminished. Having arrived at the moor, get your hives as quickly in place as you can, making them stand level; and, if it is daylight, or as soon as it is, put on all the coverings. It is a good plan to tie down the lids or put heavy stones on them to keep them from being blown off. Remove the stoppings from the hive mouths, leaving them as wide open as possible. The bees will soon take a flight, learn their new position, and, I hope, start working. After that it is only a matter of sunshine; if there is plenty of sunny weather there will be plenty of heather honey.

I forgot to say that in choosing frames to send to heather it is best, unless wired frames are used, to take those from which brood has hatched at least once. Such frames are less easily broken down than quite fresh ones are.—T. D. GIBSON-CARMICHAEL.—*Scottish Border Record.*

PUNIC BEES AND GOLDEN CARNIOLANS.

There is certainly no country where advertising is done on such a large scale as it is in America. We do not know what our readers would say if we filled our paper with advertisements, and gave them only a couple of pages of literary matter. Yet this seems to be tolerated in America, for we find the August number of the *American Apiculturist* contains just barely four columns of literary matter out of the twenty-eight, the twenty-four being taken up with sing-

ing the praises of Punic bees, golden Carniolans, and testimonials from persons who have been supplied with queens bred by H. Alley, who states that the hybrid variety, which he calls 'golden Carniolans,' are the pure Carniolans. It is true H. Alley is a queen-breeder, and runs his paper in connexion with his business, so that it stands on a different footing to our papers; nearly all other bee-papers in America are run by supply dealers, yet we do not find them puffing their wares in the same manner. One of them at any rate is outspoken enough, only the editor of the *Bee-keepers' Review* has made a trifling mistake in his measurements. We said there were four columns of literary matter, but as a matter of fact two and a half columns are taken from other papers, and merely acknowledged by having *Exchange* put at the end. So it leaves just one and a half columns of original matter that is not trade advertisement in the body of the whole paper. This is what the *Bee-keepers' Review* says about it:—

'The *American Apiculturist* for August is but little more than a big booming circular for the business of E. L. Pratt and H. Alley. By actual measurement, more than three-fourths of its reading-matter is devoted to describing, praising, puffing, and pricing of those "wonderful Punic bees," the "golden Carniolans," or to be-rating those who have criticised said bees or the methods of their breeders.'

HONEY IMPORTS.

1888.

January	£465	July	£5820
February	528	August	1365
March	284	September	1114
April	2508	October	1604
May	2009	November	3140
June	1739	December	3033

1889.

January	£3284	July	£6765
February	2992	August	1981
March	1145	September	1528
April	6231	October	1976
May	3420	November	1761
June	557	December	433

1890.

January	£1066	July	£3304
February	657	August	3981
March	2029	September	3868
April	8391	October	3196
May	7515	November	3793
June	1774	December	1747

1891.

January	£2557	May	£6070
February	3845	June	5614
March	2927	July	3102
April	7334		

MARRIAGE OF THE REV. DR. BARTRUM.

We have much pleasure in announcing to our readers the marriage of the Rev. E. Bartrum, D.D., rector of Wakes Colne, Essex, to Marian, eldest daughter of the Rev. R. T. Burton, of Stott Park, Windermere, vicar of Great Tey, Essex. The marriage took place on the 18th August, at Finsthwaite Church, Windermere, and the service was performed by the Right Rev. Bishop Mitchinson. As a member of the Committee of the B. B. K. A., Dr. Bartrum is well known to our readers, and those who were present at his 'At Home' on the 11th July last will long remember his kind hospitality on that occasion. We are sure all our readers will join us in wishing Dr. and Mrs. Bartrum a long life of happiness and usefulness.

Correspondence.

The Editors do not hold themselves responsible for the opinions expressed by correspondents. No notice will be taken of anonymous communications, and correspondents are requested to write on one side of the paper only, and give their real names and addresses, not necessarily for publication, but as a guarantee of good faith. Illustrations should be drawn on separate pieces of paper.

Communications relating to the literary department, reports of Associations, Shows, Meetings, Echoes, Queries, Books for Review, &c., must be addressed only to 'The Editors of the "British Bee Journal," 17 King William Street, Strand, London, W.C.' All business communications relating to Advertisements, &c., must be addressed to Mr. J. HUCKLE, Kings Langley, Herts (see 1st page of Advertisements.)

** * * In order to facilitate reference, Correspondents, when speaking of any letter or query previously inserted, will oblige by mentioning the number of the letter, as well as the page on which it appears.*

FOUL BROOD AND NAPHTHALINE.

[759.] Having acted upon your advice, I have almost cured my diseased stock of bees, and it seems almost incredible that they should have become sufficiently strong to have gathered me twenty-two beautifully sealed sections, for they barely covered four standard frames on May 1st, and now they cover ten frames.

In my opinion the naphthaline treatment will undoubtedly eradicate the disease in time if regularly used. Please to send me directions as to what quantity ought to be used, and how often applied. I have blown mine in at the entrance about every eight or nine days.

My bees have delighted me this summer. From my strongest stock I have taken forty fine sections, eight perfectly sealed shallow frames, and seven partially filled, leaving them with their ten standard frames (not examined) with the appearance of one mass of honey, say, about seventy pounds taken off. Surely this is excellent.

I had a heavy swarm June 15th, and they, working upon eight standard frames for a brood chamber, have filled and sealed ten shallow frames, besides a crate of twenty-one sections, which, when taken off, had fifteen perfect and the remainder partially completed. All my

others, making a total of fourteen, have done equally well considering their condition in May.

My only difficulty now lies with foul brood, as I find it in different directions in this neighbourhood. I am determined, with your aid and others (in *Bee Journal*) to rid myself of it. Would a short account of my experiences with the disease be of any use to bee-keepers in general? I commenced with the disease seven years ago, when I first left school, and have now gained sufficient experience to cope with it.—J. MORETON LORD.

[We shall be glad to have your experience with foul brood, as anything which will help to eradicate this pest is of interest to bee-keepers.—Eds.]

METHEGLIN.

[760.] For some time past I have been a regular reader of the *British Bee Journal*. I also keep a few hives of my own, and am now writing to you to know if any of your numerous correspondents could kindly give me, or inform me where I can obtain, a proper recipe for making 'metheglin.'—HENRY TWIGGER, *Nuneaton, August 25th*.

[There is a recipe for making hydromel, which is the same thing, on page 196 of this year's *B.J.*, on the plan recommended by M. G. de Layens. Would not this answer your purpose? It is very simple, and the results are good.—Eds.]

THE SEASON IN STRATHITAY, PERTHSHIRE.

[761.] Bee-keepers in this part of the world have been favoured so far with a fairly good harvest. A good amount of nectar was gathered and sealed over during some fine weather in June and July, and the veteran bee-keeper, beaming and smiling under his hoary eyebrows, was about to ejaculate, 'The best season for fifty years!' when, in August, the rains descended and the floods came, checking honey-gathering to a considerable extent.

The chief sources of honey in this district are clover and heather. The clover crop has this year been almost a total failure, so that the honey-bee has had to eke out a living on the moors, which are now clad in their purple robes. The only thing needed is a few weeks of fine sunny weather. Would that the Clerk of the Weather were a bee-keeper! Then thunder-claps and hailstorms would be unknown, and the poor bees would revel in luxurious grandeur.

The swarming fever was, in most of our apiaries, pretty acute. From my five stocks I had in all five swarms, five casts, one second cast, and two virgin swarms. The virgin swarms came off both about the end of July—too late for the honey harvest—so I cut out the queen-cells, gave them three section crates each (with nine frames below), and returned them. I may here make mention of an exciting scene which I passed through, and which in

some measure rivalled the 'three-swarm-into-one' incident at Stranraer this year. A cast had issued from one of my hives and settled on an apple-tree in the middle of the garden. Just as I was about to skep the cast a tremendous noise arose in my rear, and on looking round I found that my strongest swarm was sending off a huge virgin swarm. I was so thunderstruck that for the moment I forgot all about the cast on the apple-tree, and stood gazing at the creatures gushing forth. Before I could say 'T tin,' they had reached the middle of the garden, and were quite coolly taking up their quarters just under the cast on the same branch. In five minutes more the two clusters had become one harmonious whole, which I speedily got into a skep and shook down in front of the parental abode of the virgin swarm. There was not the least show of fight on either side, and they at once set themselves down sedulously to work in the sections.

As to honey, I have already taken between sixty and seventy one-pound sections from three of my strongest swarms; one or two of the weaker ones have their crates pretty well filled. I have this year placed vertically in each section a strip of foundation, one or two inches wide, fixed at top and bottom. It is a more economical plan than using full sheets, and the strip acts as a ladder in enticing the bees to fill the section-crate.

Formerly I found the greatest difficulty in removing full crates from the hives, or rather in getting the crates off minus the bees. This operation is now, thanks to T. A. Flood's super-clearer, a tolerably easy one. The bees themselves, I think, should be extremely grateful to the inventor of this useful appliance, for instead of being forced below with clouds upon clouds of bewildering and sickening smoke, they enter the lower regions entirely at the freedom of their own sweet will. My line of action in the matter of removing a super is somewhat similar to that of 'Purbeck, Dorset,' which is described in the *B. J.* of August 13th (741). When the top crate is full, or nearly full, I free it from the crate below by gently pushing it backwards and forwards, and raise it slightly, first at one corner and then at the opposite corner, applying a little smoke each time. I then quickly and steadily lift it off, and set it squarely upon the clearer, which is placed on a flat board near at hand. Most probably at this point a puff of smoke may be needed to drive the bees down into the hive, and when all is clear I lift the crate with the clearer underneath, and place both upon the hive. I give them generally a whole night or a whole day to descend, and they all descend with the exception of a dozen or so weak-chested individuals, who deem a high altitude indispensable to their constitution.

A very essential accompaniment in the use of the super-clearer is a freely-working smoker. It is a curious fact that when you are hard pressed, when bees are crowding up over the sections or frames on all hands, when attacked by a dozen or two infuriated bodyguards, when

you, as a last resource, stretch forth your right hand for your smoker, which a minute ago you saw going full power, nine times out of ten you find that handy appliance 'out!' You have now probably to take to your heels to a remote corner of the garden, where you nervously extract the stings, hurriedly wipe the perspiration from your brow, and set your smoker a-going. Returning to the scene of action, you half-suffocate the poor bees with volume after volume of deadly smoke, arrange the quilts, adjust the hive roof, and draw breath. You now no longer want your smoker, and wish, with all your heart, it would go out, as it did before; but smokers are endowed with a very perverse, pig-headed kind of temperament, and it will probably, if left, burn on for hours out of pure spite.

Mr. Gibson-Carmichael deserves the highest praise for the great treat he was instrumental in affording us at Stirling. What with the useful hints and skilful manipulations of Mr. J. H. Howard, the numerous, lucidly explained specimens and neatly drawn diagrams in Mr. Gibson-Carmichael's own tent, and the splendid appearance of the honey staged, we all returned home in right good humour, and with our knowledge and experience very much enlarged.—*Biz E. BEE, August 28th, 1891.*

HEATING UNCAPPING KNIFE.

[762] Is the following plan too simple to merit a few lines in your columns, or may it prove useful to some fellow-bee-keeper who, like myself, objects to multiplying the paraphernalia of the craft? Procure a tall canister with a lid; punch a slit in the lid sufficiently large to admit the blade of the knife. Then place the canister in an outer vessel considerably larger than itself, such as a large common jug, and fill in the space between jug and canister with plenty of cork-dust or chaff-packing. On filling the canister with boiling water the temperature will remain sufficiently high for a couple of hours.—*A. FRYER.*

SUPER-CLEARERS.

[763.] There has been a great deal said about these lately, so I thought I must try them, and I bought one from a dealer here, and I must say it is the best thing I ever saw for clearing surplus chambers. This is the way I have used it. I lift off the crate, put an empty one in its place, then the clearer and full one on the top. I do this in the evening, and I find in the morning that the crate can be taken into the house. It is done without any disturbance whatever in the apiary. I would not be without it for double its cost.

Bees have done fairly well here on white clover. I have twenty-one hives now, all bar-frames but two. I have had hives from nearly all the manufacturers, I think. I bought one of the Acme hives in 1888, and that one has

given me by far the best results of any. We are hoping to have some fine weather now for the heather, but so far it has been rain, rain nearly every day.—*S. M., North Devon.*

Bee Shows to Come.

September 4th, at Stranraer, Wigtownshire Apiarian Association. Rev. J. B. Robertson, Hon. Sec., The Mause, Leswalt.

Sept. 5th.—Alderley Edge and District Branch of the Lancashire and Cheshire B.K.A. Chelford Flower Show, Astle, Chelford. Schedules, &c., T. D. Schofield, Alderley Edge, Cheshire.

Sept. 5th.—Bramhall and Woodford District Horticultural Society at Bramhall Hall, near Stockport. William Slater, Fern Lea, Bramhall, Stockport.

Sept. 9th, 10th.—Derbyshire Bee-keepers' Association at Derby. W. T. Atkins, Sec., 12 North Street, Derby.

Sept. 19th.—Jedburgh and District B.K.A. in the Sessional School at Jedburgh. Entries close Sept. 15th. For schedules apply to Thos. Clark, Sec., Pleasant's School House, Jedburgh, N.B.

October 13th to 16th.—British B.K.A., in connexion with the Dairy Show at the Royal Agricultural Hall, London. All open classes. Entries close September 14th. For schedules apply to Wm. C. Young, Sec., 191 Fleet Street, London.

Queries and Replies.

[469.] *Bees not Working in Super.*—1. I began bee-keeping this year, bought a swarm June 11th, fed them on syrup with a rapid feeder for fourteen days; then I was advised to give super to them, and let it stay until the bees had filled it. I let it stay four weeks, and nothing was stored in it; then I took out one frame from the body to try and drive them up. I waited another nine days, and no signs of their going up. Then I took it off altogether, and took out another end comb from the body, which was sealed from top to bottom with honey and pollen. I put a frame of comb foundation in its place. That is all the honey I have had this year. 2. How many frames must I leave them to winter on? They seem to me to be a strong stock, and any information you can give to a beginner will be very acceptable.—*CHARLES WADLAND.*

REPLY.—1. Such a season as this, your only chance of getting a super from a swarm would have been to put on the super at the time the swarm was hived. Considering the season, we do not think it strange that the bees did not go up. From the fact that you have been able to get combs of sealed honey, we judge that your bees were not sufficiently crowded in the hive to force them into the super. 2. As many frames as the bees will crowd upon. Remove

the outside combs and close up with division-board. See that the bees have sufficient stores for wintering upon, and, if deficient, feed up rapidly.

[410.] *Driving Bees.*—Perhaps you can give me some information, through your valuable paper, respecting the following:—I went to drive a stock of bees for a neighbour. There were two straw hives, one on the top of the other, so I had to drive them separately. I got the top lot driven very nicely, but the bottom lot caused me some trouble. Instead of going up into the empty hive, the half of them came out on to my hands; and I'm sure I got at least thirty stings on my hands, although I had my hands well rubbed with vaseline and a pair of woollen gloves on. Will you kindly let me know with what results chloroform has been tried? I have driven about half a dozen hives before this, and never had any trouble with them. Any information will oblige.—WM. ALEX. WATSON, August 15th, 1891.

REPLY.—It is not usual for bees to go outside the hive, as you describe, when driven. You should have quieted the bees with a few puffs of smoke, and then, when the hive was turned up, if they were not inclined to run up when you commenced driving, it would have been better for you to place the empty hive close on the inverted one. A little thin syrup sprinkled on the bees often puts them in good temper, and causes them to run up more freely. Perhaps you were too rough in overturning and handling the hive. Chloroform is not suitable for driving bees, as it stupefies them.

[411.] *Italians and Carniolans.*—I should be greatly obliged if you would give me replies to the following queries:—1. Do Italian bees pay? 2. Are Italians more profitable than natives? 3. Would it be well to have a stock of Carniolans, and use them to supply the native stocks, with frames of brood to get cells sealed better? 4. Would it do to introduce an Italian or Carniolan queen to natives now? 5. Can you tell me of a reliable man to get driven natives and queens from?—A. E. M., Bath.

REPLY.—1. Certainly, if you get the right sort, and are careful to keep only the best. Not every Italian queen imported is good, and if you take them as they come the average will not be better than blacks in working qualities. If you discard all inferior queens you can ultimately obtain a strain that would pay well. Too much attention has been paid to colour and too little to working qualities, and it is not the most handsome bees that pay the best. 2. Yes, if only good queens are used. The best workers are the dark, leather-coloured Italians. But to get a good strain you would have to discard about fifty per cent. of the queens after trial. 3. This would be too much trouble, and would not pay. 4. Yes; this is a good time to do so, as imported queens are much cheaper now than during the height of the season. 5. Please consult our advertisement columns; there are driven bees advertised almost every week.

[412.] In the *Journal* of the 20th inst. you recommend 'salicylic' in syrup for autumn feeding. Kindly say in the next *Bee Journal* how much of the above must be used with, say, ten pounds of sugar, so that the proper quantity may be used.—R. WILLIAMS.

REPLY.—Prepare the following solution:—Salicylic acid, $\frac{1}{2}$ ounce; soda borax, $\frac{1}{2}$ ounce; warm water, 2 pints. Keep this as a stock solution. *Autumn food.*—White cane sugar, 10 pounds; water, 5 pints; vinegar, 1 ounce; salicylic acid solution, 1 ounce; salt, 1 ounce. Boil for a few minutes.

[413.] *Hairless Bees.*—I have lately found in one of my hives one or two 'black, shiny bees.' One of these, at any rate, was entirely destitute of hairs. It had placed itself among the fanners at the entrance to the hives, and though fanning, was constantly turning round. It was not allowed, however, to do this long, for it was violently attacked by a worker bee, and after a severe struggle was forced off the alighting board, and it took flight when released. The worker rode on its back and sides, as it would do with a drone. On three different days I have seen one of these bees, always, however, in the same hive, and they were invariably attacked by the workers. I have sent one for your examination. It was my intention to have joined this stock of bees to another. I presume the bees are diseased. Is it safe to do so? Is the disease at all of the same nature as foul brood (I mean infectious). The hive is apparently very healthy, and is yielding a considerable amount of honey. I will be obliged for your opinion.—F. McC., Blackyett, Annan, N.B.

REPLY.—Bees such as you describe, and a specimen of which you send, are frequently found in hives. They have a black, shiny appearance owing to the loss of their hairs. The worker bees look upon them as enemies, and always endeavour to drive them out of the hive. We recollect on one occasion leaving on excluder zinc with round holes and an empty super above, after removing a super filled with honey. This was done because there was not room enough for all the bees in body box when the super was removed. When cool weather came, we removed the empty super and found a large quantity of these bees driven up above the zinc. There is no doubt but that these bees are diseased, but the disease is not anything like foul brood. In such bees there is a bacillus present, called *bacillus depilis*, and the disease is caused by weakness and defective nutrition in individual bees. The disease is not infectious, although it is supposed that one bee can communicate it to another by contact. At any rate, this has not been our experience, and we have found hives having such bees doing quite as well as others. Were a large number of such bees present in a hive at one time it would be more serious, as diseased bees cannot be good for the general health of the community, and if the queen become diseased it might be necessary to remove her. As your hive is

apparently healthy and yielding a considerable amount of honey, we should not hesitate to unite this stock of bees to another. We should feed with medicated syrup, if feeding be necessary.

[414.] 1. Is it safe to place beehives in a row on the banks of a river? 2. Is there any danger of the bees getting drowned? The bank is about four feet high, sometimes less if the river (Epte) is swollen from rains. Very large trees shadow the banks, but the hives would get a good deal of sun from the south-east and the west alternately. The south is quite shaded off, and the hives would be quite protected from the north. Will you please answer a third question? 3. Which do you consider the best honey from a saleable point of view, comb or section honey, or run honey? I prefer section honey, but I do not know if this is a general taste. I have two Philadelphia hives and two good stocks of bees; they are very busy over the sunflowers (for pollen) and in the pumpkins, vegetable marrow, cucumber, and melon-flowers, which all have a delicious fragrant perfume. My hives are almost *in* the chicken-yard, only separated by a wire netting, but the bees never sting a bird.—GIBSONS.

REPLY.—1. This depends upon how close to the water the bank is situated, and whether it is a wide river. We should not care to place hives nearer than ten feet from the water's edge, and very much further if the river is wide. 2. Yes; in heavy winds bees would be likely to be blown down, and many would be lost unless the district is so sheltered by trees as to avoid this contingency. We could tell you better if we knew how wide the river was. 3. This depends entirely upon your market; in some places comb honey in sections sells best, and in others extracted honey, so you must be guided by the demand. Extracted honey is considered less trouble to produce and to market, and we should advise you to go in for this unless you can get a good price for sections in your immediate neighbourhood.

[415.] I examined one of my stocks of bees on Wednesday last, and found plenty of brood and some eggs, but did not see any queen. About two weeks ago I examined the same hive, and failed to see the queen then. On one comb I saw a patch of eggs, but there were two in almost every cell. Does this prove conclusively that there is a fertile worker in the hive? The sealed brood had cappings just like ordinary brood, and not like the raised cappings on drone comb; but these eggs may have been laid by the queen prior to two weeks ago. I dare say you will remember that I lost a swarm from this hive, but I believe that it returned in a day or two, for there seemed as many bees as before, and so the queen may have been lost in this way. There are no drones in hive. Please let me know in next week's *Journal*.—S. GEORGE FIELD.

REPLY.—If the sealed brood is like ordinary brood it cannot be that of a fertile worker, which is always raised with dome-shaped cap-

ings. Queens sometimes are so prolific that they will lay more than one egg in a cell, but you can easily ascertain if the eggs are those of a queen or fertile worker. A queen lays her eggs on the base of the cell, but a fertile worker, whose body is shorter, generally lays eggs on the sides of the cells, as she cannot reach the bottom. The eggs you see now could not have been laid prior to two weeks ago, as the cells would be capped with larvæ in them. The cells are usually sealed over on the ninth day from the time the egg is laid. Eggs are only three days before they hatch. Examine the hive again, and probably you may find the queen.

[416.] Living within ten miles of scores of acres of heather, will you kindly give me a few hints? 1. Whether it would pay to take half a dozen hives there. 2. As to the best form of bar-frame hives for packing and sending, as I make my own hives. 3. The best mode of packing and ventilating the bees during transit.—A BEE-KEEPER, *Torquay*.

REPLY.—1. Yes, if the weather be favourable there is still time for them to store heather honey. 2. The hive should be as simple as possible—a body-box with floor-board, with frames that can be firmly secured so that they do not move, old combs that are not likely to break out during transit, a rack of sections on top, and a good cover over all. This is all that is absolutely required. 3. We should place on the floor-board a shallow raiser a couple of inches high, the same size as hive, and on this place the hive. Fasten the frames so that they do not move, or if they have broad shoulders or metal-ends, the section-case, placed on the top of frames, would hold them in position. Take care that the frames have no lateral movement, and fix division-board so that it is steady. We should prefer the hive filled with frames, and also filled with bees, and if they are not strong enough, unite two lots together. The only way to obtain honey at the heather is to have strong stocks. Cover the top with perforated zinc or cheesecloth, and fasten it down, so that the bees cannot escape. Place a piece of perforated zinc over the entrance, and nail it securely. Take care that all the parts are securely fastened together. Some put screws into floor-board, hive sides, and section crates, and tie together with tarred string. We should prefer three pieces of wood screwed on the outside, putting a screw into floor-board, another into the hive, and another into the super. Put one piece of wood on each side and one at the back. When the bees are placed at the heather, put on quilts, wrap up supers to keep warm, and put on roof to protect from rain. Remove the zinc from entrance. Disturb as little as possible when you have got them to their destination. Carry them on a spring lorry, and let the frames run lengthwise towards the horse.

[417.] *Marauding Bees at 'Sweet' Stalls*.—1. How can I best prevent my bees from visiting toffy stalls in the town, where many hundreds

are killed by the owners? The stalls are held in the open air on Saturday only, when they are literally covered with bees in the afternoon.

2. How can I change my bees from a frame hive, not of standard size, into one of standard size, the combs in the present hive being very uneven and two years old, without loss of brood? It doesn't matter whether this year or next.

3. How is it that my bees are not yet killing the drones? I have two hives, one of which I know for certain to have brood. The other I have not examined lately. The latter, a last year's swarm, is stronger than the former, a this year's swarm.—GEO. T. WILSON, *Kendal*.

REPLY.—1. Only in a measure by endeavouring to keep your bees so well supplied with food at home that they may be as little inclined to 'rob' as you can make them. 2. By cutting out the combs from the present frames and tying them in with tapes to those of standard size, and removing the tapes after the combs have been firmly fixed in the new frames by the bees. 3. Drone-killing at this season is general, and any hives retaining drones now should be suspected of having either no queen or an unfertilised one.

[418.] 1. I have a hive of bees on eleven frames. It swarmed July 16th, the swarm returning after having lost their queen I suppose. On July 20th I saw a young queen. I have examined this hive many times since, and find neither the queen, eggs, grubs, or brood in it. Would you advise giving them a fertile queen? Or, 2. Supposing there is a virgin queen still in, what course would you take? I have two nuclei which I gave queen-cells from the hive when it swarmed, and neither of them are laying yet, as I often see them. The cells were put in July 16th. Perhaps you will pardon my next question, though rather personal. 3. What race of queens do you keep yourselves?—T. G., *Staffs*.

REPLY.—1. Yes, if you have fair reason for supposing the queen unmated. 2. Leave her where she is till you can conveniently replace her. 3. Blacks and hybrid Carniolans, the former being preferred.

[419.] I should feel obliged by your giving me your advice on the following:—I have a stock of bees in a large hollow willow-tree. They have been in since last year, and seem to be strong; enter at a small hole about eighteen inches high. I should like to know, 1. Can I transfer them into a bar-frame hive? if so, 2. Which would be the best method to proceed? 3. Can I remove them after transferring to my garden about a quarter of a mile distant? A few hints will be acceptable.—WILLIAM FRANCIS, *August 25th*.

REPLY.—1. It can be done, but is hardly worth the trouble, being a very difficult operation. 2. You would have to cut down the tree, after stupefying the bees, and then cut out the combs one by one. Great care would have to be taken in doing this. If you knew to what

height the combs extend you could cut the tree just above, and then just at the opening. The circular trunk would then have to be split in two, and the combs removed. We do not recommend you, however, to undertake the task. 3. When transferred, and the bees at work in the hive on or near the spot where they stood, they could be removed to a distance of not less than two miles and a half. After they have been here for a week you could bring them back to your garden.

Echoes from the Hives.

Pubtheli.—I have twelve stocks at present, and they are all from driven bees. This has been a bad summer here for bees, and hope to be able to do better before long. I only started keeping bees three years ago, and am a joiner by trade, so that I can make all the hives, and manage them very well. I read the *Bee Journal* regularly, and like it very much.—H. P. M.

Annan, August 27th.—The heather here is splendid, but the weather horrid—rain and floods. I am gradually removing frames of comb and honey from my hives. I find the carbolic cloth most useful. My man keeps it as much as possible over the combs while I lift them out and examine. I am taking out all honey and leaving all brood, but the latter is much less than it was, and will soon be compressible into one box, and soon after that I winter the two hives in each bee-house, then feed if necessary.—F. M. C.

Moffat, N.B., August 29th.—Bees have done very little at the heather yet, for we have had so much rain. Notwithstanding this they get out whenever it is fine, and make straight for the heather, which is now in full bloom. I lifted the quilts off some of my sections, and I could see that heather honey was coming in, and then it cannot be mistaken by the smell. If only we could have a week of fine weather, we should be satisfied, as it would enable the bees to store sufficient for winter food, even if we do not get any sections completed.—J. M.

Nyon, August 24th.—The honey harvest has been below the average in French-speaking Switzerland.—E. BERTRAND.

Notices to Correspondents and Inquirers.

Letters or queries asking for addresses of manufacturers or correspondents, or where appliances can be purchased, or replies giving such information, can only be inserted as advertisements. The space devoted to letters, queries, and replies, is meant for the general good of bee-keepers, and not for advertisements. We wish our Correspondents to bear in mind that, as it is necessary for us to go to press in advance of the date of issue, queries cannot always be replied to in the issue immediately following the receipt of their communication.

All queries forwarded will be attended to, and those only of personal interest will be answered in this column.

M. E. BROOKE.—If your honey (three or four years old) is much fermented, it is no use as food for bees. You had better make it into vinegar, and use it up in that way.

A. MODERN BEE-KEEPER.—We send you the number asked for, but there is no difficulty in your newsagent getting it if he applied for it. Probably he did not care for the trouble. It does not matter about the combs being black for breeding purposes, but we should prefer newer combs for extracting honey from. Very old and black combs certainly detract from the appearance of the honey, and, to a certain extent, contaminate it.

J. M. S.—The comb contains foul brood, and you should commence treatment without delay. You can give Naphthol Beta in the syrup, and place naphthaline in the hive.

C. N. PARKIN.—Formic acid is quite as good as salicylic acid for the purpose you require. We should, however, try Naphthol Beta, as being simpler and, from reports received, quite as efficacious as any of the other remedies.

M. R. SOWREY.—You can only remove your bees the short distance you propose about three feet a day, not counting days on which they cannot fly. The best plan is to remove them to a distance of two and a half miles, and then bring them back after a week or ten days to the new locality.

ROLLINS (Dudley).—Leave as many frames of comb as the bees can be crowded upon, and feed up so that the bees have from twenty to twenty-five pounds of sealed stores. One comb holds about five pounds, and this may do for a guide. Recipe for food given in answer to R. Williams (page 396).

W. W. B.—Yes, it is foul brood.

S. B. (Hollyfield).—There is no necessity to renew the combs in body-box, unless they are very old and black. These can be removed as you propose, one at a time.

A. M. (Nottingham).—The sample sent is cane sugar.

R. H. A. G.—You will find prices in advertisement column this week.

P. C. CUDDINGTON.—Yes, comb sent is foul-broody. Recipe of salicylic acid is given in reply to R. Williams (page 396). It can be had of a chemist, who would prepare the solution for you. We should, however, recommend you the Naphthol Beta treatment.

NOTICE.

Will be ready in a few days.

A New Edition, the 11th, of

THE BRITISH BEE-KEEPER'S GUIDE-BOOK,

By THOS. WM. COWAN, F.L.S., F.G.S., &c.

Revised and enlarged.

Almost entirely re-written. Much new matter and many fresh illustrations added.

Fcap. 8vo., price 1s. 6d.; or in cloth gilt, 2s. 6d. Postage, 2d.

To be had of HOULSTON & SONS, Paternoster Sq.; all Hive Dealers, Secretaries of Bee-keepers' Associations, and of J. HUCKLE, *British Bee Journal* Office, Kings Langley, Herts.

THOMAS LANAWAY & SONS,
Bee Appliance Manufacturers
AND DEALERS,
26 STATION ROAD, REDHILL.
Catalogue post free on application. 2891

STEAM FACTORY for Bee Appliances.

ORDERS addressed J. ROSS, Stranraer, Wig-townshire, N.B., will be attended to.

NAPHTHALINE AND NAPHTHOL BETA.

Both the above may now be had at the Office of 'THE BRITISH BEE JOURNAL' and 'BEE-KEEPERS' RECORD.'

17 KING WILLIAM STREET, STRAND, LONDON, W.C.
NAPHTHALINE in packets, 6d. post free.

Large packets, containing more than four times the quantity of the smaller ones, 1s. post free.

NAPHTHOL BETA, 1s. a packet, post free.

Instructions for use sent with each packet.

Special prices for quantities.

J. TREBBLE'S BEE HIVES.

All Machine-made.

My 8/6 COTTAGE HIVE beat all comers.

Awarded Seven Prizes this year. Catalogue free on application to J. TREBBLE, Saw Mills, Romansleigh, South Molton.

British Bee Journal and Bee-keepers' Record.

OFFICE :

17 KING WILLIAM STREET, STRAND, LONDON, W.C.

PURE CANE SUGARS.

For the accommodation of Bee-keepers, guaranteed Pure Cane Sugar will be supplied in large or small quantities through this office at the under-mentioned rates:—

CRYSTALLISED.

4. DEMERARA	} Neat bags, 14-lbs. 28-lbs. 56-lbs. Cwts.			
5. BARBADOS				
6. TRINIDAD	} Crystals 2/9 5/4 10/6 20/6			

REFINED CANE.

7. WHITE CRYSTALS (Small)	3/0	5/10	11/6	22/6
8. 9. (Medium and Large sizes, 1/- per Cwt. extra.)				
10. LUMP (Cut Loaf) ... Boxes,	3/3	6/3	12/3	23/6
11. LUMP DUST ...	3/0	6/0	11/9	22/9

All above guaranteed made from CANE SUGAR only, and free from BEET, CHEMICALS, etc., etc.

CARRIAGE PAID on Orders over 5/0 (or 25-lbs. Sugar) to London and Suburbs.

COUNTRY ORDERS, not less than 2-cwt. carriage paid at 1/0 per cwt. extra.

(Scotch and Irish orders, special arrangements.)

Cash to be sent with order, and purchasers will please observe that if samples are required or replies asked to inquiries, a stamped addressed envelope must be sent, as we cannot undertake cost of postage.

Special Prepaid Advertisements.

Situations, Publications, Bee Plants, &c.—Twelve words and under, Sixpence; for every additional Three words, One Penny.

Trade Advertisements not inserted under this head.

WANTED.—1-lb. Sections of Honeycomb, first quality. Prompt Cash. Packages sent. Well-filled Bell Glasses, Frames and Caps purchased. Address Mr. HURST, Bexhill, Sussex. 242

HONEY JARS, Tie-over, ½-lb., 1-lb., and 2-lb. Price List Free. Address FRED. PEARSON, Stockton Heath, Warrington. 243

WALLFLOWERS will give splendid forage for Bees in Spring. Fifty plants, 1s., post free. Address NORMAN PARKIN, Blakenhall, Wolverhampton. £ 83

FOR SALE.—Healthy Driven Bees, 1s. 3d. per lb., and Queen. Packing-box, 6d. Young Queens, 1s. 6d. each. Address E. GARNER, Broom, nr. Biggleswade, Beds. £ 93

FOR SALE.—Driven Bees, 1s. per lb., 1891 Queens. Carniolan Queens, 2s. each free, or Hybrids. Address A. NICHOLLS, Hazlemere, High Wycombe. £ 96

DRIVEN BEES, Pure Natives, 1s. per lb. Box, 1s. 1891 Queens. Guaranteed healthy. Ready for delivery. Extra Queens, 1s. 6d. Stocks in Bar-frames cheap. Address S. OATEN, Prior's Farm, Pitminster, Taunton. £ 99

WANTED to Purchase, Black English Queens or Driven Bees, headed by same. Prices to J. COOPER, St. Nicholas Square, Leicester. L 1

DRIVEN BEES, 1s. yer lb. Choice Queens, 2s. each. Address E. HANCOX, Sandford St. Martin, Steeple Aston, Oxon. L 2

WANTED.—Microscopical Slides of Bee objects. Address HAIGH, Shefford, Cheshire. L 5

FOR SALE.—A Large Stock of Bees, Sixteen Hives, and Honey, weight up to 30 lbs. per Hive, worth 25s. per Hive. What offers? Also one of Neighbour's, and two of Cowan's New Patent Box Hives, with Stocks. No reasonable offer refused. The Box Hives with Stocks would be sold separately. Address H. COLLIER, Corn Merchant, Tunbridge Wells. L 6

FOR SALE.—Four Standard Frame Hives, strong, no disease, 18s. each. Also heavy Skeps, 11s. 6d. each, cash. Address Rev. T. WILLIAMS, Seampston Vicarage, Rillington. L 8

FOR SALE.—Pure Native 1891 Fertile Queens. Post free, 2s. 6d. each. Guaranteed healthy, and safe arrival. Address CHAS. WHITING, Valley Apiary, Hundon, Clare, Suffolk. L 9

FOR SALE.—Four Stocks, in two new Fifteen-bar Hives, and two Ten-bar Hives, with Super to each. All strong and healthy, with a quantity of Honey in the Bars. Price £3 the lot. Address F. HEASMAN, The Mill, Oxted, Surrey. L 10

OFFERS WANTED.—About 800 Sections, with Comb partly and fully worked out. Clean and well packed. Address JOHN CHIVERS, Histon, Cambridge. L 11

HEALTHY DRIVEN BEES, 1s. 6d. per lb. With Queen, Box, and Packing free. Carriage not paid. Choice Natural-raised 1891 Queens, 2s. 3d. Safe arrival, and Carriage paid. Stamp for reply. Address HOLDER, Wimborne, Dorset. L 12

FOR SALE.—Healthy Driven Bees, with Queen, at 1s. per lb. Package, 1s. Address J. DAVIES, Bee-keeper, Newport, Salop. L 13

WANTED to Purchase for Cash, Deposit System, 50 lbs. Pure Extracted Honey. Address MORGAN, 14 Myland Road, Colchester. L 14

PLANT NOW the best early Spring Flowers for Bees. Forget-me-nots, 50 1s., post free.

STANDARD FRAME HIVE, complete with Lift and Shallow Frame for Extracting, New, well painted, 10s. 6d. Address J. D., 23 Beechcroft Road, Upper Tooting, S.W. L 15

DRIVEN BEES.—Orders booked for delivery in September, 1s. per lb., in 4 or 5 lb. lots, headed by Young Queens, and guaranteed free from Foul Brood. Box, 1s., returnable. Choice Young Fertile Queens, 2s. each, post free. Safe arrival guaranteed. Address A. J. CARTER, Newfields, Billingshurst, Sussex.

WANTED.—One or two acres of Land, with Cottage, within ten miles of London, in a neighbourhood, suitable for Bee-keeping. Apply to 'G.', B. B. J. Office.

FOR SALE.—Having had considerable difficulty to obtain suitable Boxes for 1 lb. Sections, and bought larger quantities than required, I shall be pleased to sell at 4s. 9d. per gross, carriage free for cash with order. Address MARTIN, 4 Woodland Place, Bath.

WANTED.—New Honey in 1 lb., 1½ lb., and 2 lb. Sections. State quantities of each size, and prices expected. Address Mr. ALEX. LEITCH, 208 St. George's Road, Glasgow. Terms cash. 247

ENGLISH QUEENS, tested, 2s. 6d. each, post free. Address C. N. WHITE, Somersham, Hunts.

THE 'ENGLISH' HIVE.

Transferring Season now on.

TRY THIS HIVE, it is the best in use, and once used will be always used. No more cutting Quilts necessary, as the Bees can be fed from the side of the Hive. See description in B. B. J., August 6th, 1891, p. 351. Price for Floor-board, Body, and Zinc-covered Roof, 11/6 only. The English Wax Extractor, price 7/6. For particulars apply to A. T. WILMOT, St. Albans.

BALDWIN'S is the Oldest Establishment in the United Kingdom wholly devoted to Bees and manufacture of

Bee-keepers' supplies. His prices will compare most favourably with those of any other Maker, while for quality of material, suitability and workmanship, he has no rival.

'Why can he give better value for money than others?' Because he spends less in large 'puffing' advertisements, buys in the best markets for prompt cash, has no rent to pay, and personally conducts his own business.

For prices and full particulars of Goods see Baldwin's Bee-keepers' Instructor (and Illustrated Catalogue combined), which 'contains more practical and reliable hints than all the large, expensive books,' post free for 2d. stamps. Address S. J. BALDWIN, The Apiary, Bromley, Kent. N.B.—More than 500 Silver and Bronze Medals, First and other Prizes, and Testimonials innumerable.

NEIGHBOUR'S BEE HIVES.
WELL KNOWN for SUPERIOR & ACCURATE WORKMANSHIP.

Every Description of APPLIANCES kept in Stock.

CATALOGUES FREE ON APPLICATION.

GEO. NEIGHBOUR AND SONS,

127 HIGH HOLBORN, LONDON, W.C. (Corner of Southampton Street.)

THE
British Bee Journal,
 BEE-KEEPERS' RECORD AND ADVISER.

No. 481. Vol. XIX. N. S. 89.]

SEPTEMBER 10, 1891.

[Published Weekly.]

Editorial, Notices, &c.

NAPHTHOL BETA AND
 NAPHTHALINE.

Now that the season for feeding bees has arrived, we have been asked to give simple instructions in the above remedies for the cure and prevention of foul brood. Most encouraging reports have been coming in from those who have been trying these remedies, and in many instances cures have been effected. There is, however, a great deal of misunderstanding with respect to which of the two substances to use, and this we would wish to clear up.

Naphthaline is not recommended for trial as a remedy, but only as a preventive, although, in some cases, we are assured that a cure has been effected with the use of naphthaline only. However, we believe it has the power of arresting the growth of bacilli, and so long as it is present in the hive, the disease is held in check. This substance has a powerful odour, and should be pure, for several cases have been brought to our notice where the bees had deserted their brood owing to an impure form of naphthaline having been used. It is sold in two forms, viz., in white crystalline flakes and in sticks. If flake naphthaline is used, about as much as can be heaped on a sixpence should be put on the floor-board of the hive as far from the entrance as possible. The quilt can be lifted up at the back, and the naphthaline dropped in between the combs. If the sticks are used, they should be cut into pieces about the size of a nut, or about three-eighths of an inch long. One or two such pieces can be put into the hive at one time. Naphthaline evaporates; therefore, as soon as it has disappeared, renew it. This can be done at intervals of eight to ten days. Naphthaline must not on any account be used in food, and should only be administered in the manner described. In an apiary where foul brood exists, it would be advantageous to give some to every hive, and the same should be done if foul brood exists in the vicinity. The substance is very cheap, and could be given to cottagers, who might be thus induced to help in exterminating this pest of foul brood.

For the purpose of curing the disease, it is advisable to give Naphthol Beta in the syrup. This does destroy the bacilli which are present in the alimentary canal of adult bees, and given

by the nurse-bees as food to the larvæ, also destroys the bacilli in them. Naphthol Beta is a fine crystalline powder, almost odourless, and is insoluble in cold water, but it dissolves freely in alcohol, and to a small extent in hot water. If, however, it is first dissolved in alcohol, and this solution added to the syrup while still hot, it remains in solution. The proper proportions are three grains to every pound of sugar used. This quantity will cover a sixpence heaped up in the centre to a little more than one-eighth of an inch. Such small quantities, however, are not conveniently measured by every one, and when a good many pounds of sugar have to be boiled up, measuring on sixpences is not the most expeditious plan. The following may be found more convenient, as avoirdupois weights are to be found in almost every household:—

1 drachm Naphthol Beta to	9 lbs. sugar.
$\frac{1}{8}$ ounce " "	18 "
$\frac{1}{4}$ " " "	36 $\frac{1}{2}$ "
$\frac{1}{2}$ " " "	72 $\frac{1}{2}$ "

Those who have apothecaries' weights can use the following table:—

1 scruple Naphthol Beta to	6 $\frac{1}{2}$ lbs. sugar.
1 drachm " "	20 "
$\frac{1}{2}$ ounce " "	80 "

These proportions are not exact to a grain, but quite near enough for all practical purposes.

When the proper quantity is weighed out, dissolve it in alcohol, or rectified spirits of wine, by pouring just as much of this upon it as will dissolve it, and then shaking, and as soon as all the Naphthol is dissolved stop adding the spirits. Boil the syrup in the usual way, and when it is taken off the fire, add the Naphthol Beta solution to it and stir. When cold enough it is ready for use. When Naphthol Beta is used in syrup, there is no necessity to add any salicylic acid, as it takes the place of this. Where foul brood does not exist, half the quantity of Naphthol Beta could be used as a preventive. To medicate candy the same proportions can be used, and when the syrup is taken off the fire and begins to cool, just before stirring is commenced, put in the Naphthol Beta dissolved in spirits of wine. We hope that these instructions will be found simple enough, and will be a sufficient answer to the numerous questions we have had upon the subject. Remember that Naphthol Beta can only be used in food, and naphthaline only as a preventive.

NEW HEATHER HONEY-PRESS.

A good and effective press for heather honey has long been wanted. The Raitt and other presses have not sufficiently met the requirements, as the comb has to be cut up in pieces before it can be put into the press. Those generally used on the Continent are much larger, but are too cumbersome for general use.

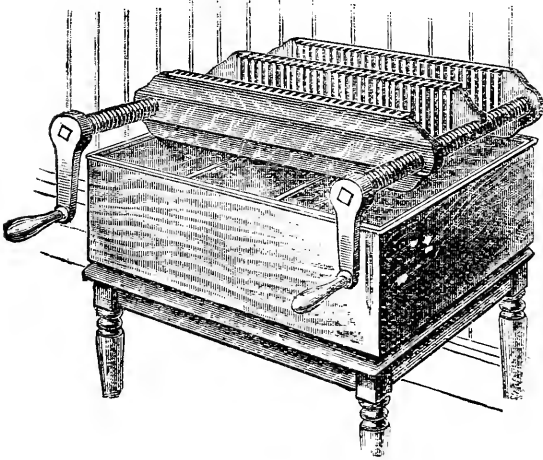

Heather honey from its peculiar nature cannot be extracted in an ordinary extractor. It is like jelly, and no amount of centrifugal force will drive it out of the combs. We were much amused at the Show at Stirling where a bee-keeper wished to purchase an extractor, and we had the greatest difficulty to persuade him that an ordinary extractor would not answer his purpose for heather honey. He thought an extractor was an extractor and ought to do.

What has been wanted is a press that would take whole combs, and that could easily be worked by screw pressure. This we have at last in the press introduced by Mr. Barton, of Garstang, and which appears to be most perfect in its action. In fact, some combs that we had the pleasure of showing to those interested had been so perfectly pressed that there remained merely a sheet of wax, with hardly a particle of honey attached to them.

By referring to the illustration it will be seen that the press has two end plates and a central plate. The central plate is loose, and the other two plates can be brought together by means of the screws. The plates are grooved vertically, each groove being about a quarter of an inch wide by the same depth, and the grooves are a quarter of an inch apart. In operation the press is laid horizontally upon a square box lined with tin, which has two bars running across level with the top. For convenience it is placed at a suitable height against a wall. The back of the press also touches the wall so as to keep it steady when screwing up. The combs are then cut out of the frames, and without uncapping are wrapped in one thickness of

straining calico, on each side of which is placed a piece of woven wire, eleven or twelve meshes to the inch. This must be the same size as the grooved plates. The comb is then placed between the grooved plates, and is prevented from slipping down by the cross-bars. A second comb is treated in the same way, and placed in the other opening. Pressure is now brought to bear on the combs by turning the handles, which draws the plates together. The woven wire prevents the combs from being forced into the grooves when they are squeezed up, and the pressure forces the honey through the straining calico into the vertical grooves, from which it runs down quite clear into the receptacle below. Any amount of pressure can be exerted, and it is so even that every particle of honey is extracted, and nothing remains but a nearly dry sheet of wax. By having additional plates in the centre more combs can be introduced, and the number is only limited by the length of the screws and the number of division plates. We think this press meets a real want, its simplicity rendering it not liable to get out of order, and we have no doubt when its merits are understood it will come into general use.

WOTTON-UNDER-EDGE DISTRICT BEE-KEEPERS' ASSOCIATION.

The annual show of the above Association was held on Wednesday, the 26th August, in connexion with the Horticultural Exhibition. Wotton-under-Edge is a very interesting old town, and is beautifully situated at the foot of the Cotswold Hills, and its annual flower show never fails to bring together a large number of visitors from Gloucester and Bristol.

Bee and honey shows are not such ancient institutions at Wotton as flower shows; but the glory of the former seems to bid fair to eclipse the glory of the latter. For three years in succession it has been the privilege of the writer to visit, officially, the annual show at Wotton, and each one has been greatly in advance of its predecessor. The bee-keepers here seem to be a happy lot, a sort of 'happy family,' each one feeling an affectionate interest in the other. The result is, they are ever ready to help one another and to rejoice in each other's successes. It is to this feeling of mutual sympathy and help that must be ascribed the great success of the last annual show. Each one tried to make it a success, and they succeeded. The Association does not number more than forty members, but they managed to stage about eleven hundred-weight of honey, besides wax, wasps' nests, and appliances. The honey was of the finest quality, and, with only one exception, was free from the odious honey-dew. Some of the classes were numerous and closely contested. This was especially so in the classes for twelve one-pound sections and for twelve one-pound bottles of extracted honey. There were eleven entries for-

extracted honey, and, where all was good, it was difficult to decide which was best. The class for best exhibit of honey in any form brought five competitors, two of whom had arranged their trophies in the most perfect manner; but, as quantity was lacking, only one took a prize. This was much admired, and was one of the features of the show. It was the work of Mr. A. Jones, of Gloucester.

During the afternoon the Earl and Countess of Ducie visited the tent, and displayed great interest in the various exhibits. The Countess, besides being a bee-keeper, is President of the Association, and takes a great interest in its work, helping it by advice, and liberally contributing to its funds. She sent two very fine exhibits, but not for competition.

The Hon. Secretary, Mr. Brown, is the *ideal* of a district secretary, living and moving amongst the members, full of sympathy and civility, ready always to counsel and help any who need it, and he is ably assisted by a united and energetic committee.

The Rev. E. Davenport acted as judge, and during the afternoon lectured in the tent, as opportunity offered, to large audiences, as by the generosity of the Countess of Ducie the committee were able to throw the tent open and free to all.

The judges' awards were as follows:—

Class 1. Honey in any form not less than fifty-six pounds in weight.—1st prize, W. Griffin; 2nd, G. Gunstan; 3rd, A. Jones.

Class 2. Twelve 1-lb. sections of comb honey.—1st, silver medal, C. W. Workman; 2nd, W. Huland; 3rd, W. Griffin.

Class 3. Twelve 1-lb. bottles of extracted honey.—1st, H. A. Brown; 2nd, G. Gunstan; 3rd, Rev. E. M. Farquhar and G. Venn, equal.

Class 4. Super of honey, not sectional.—1st, A. J. Brown.

Class 5. Six 1-lb. sections of comb honey.—1st, A. J. Brown; 2nd, H. Canadiue; 3rd, Mrs. Till.

Class 6. Six 1-lb. bottles of extracted honey.—1st, W. Huland; 2nd, A. Jones; 3rd, G. Gunstan.

Class 7. Bar-frame hive.—1st, A. J. Brown; 2nd, G. Venn.

Class 8. Largest number of queen-wasps.—1st, W. Teagle; 2nd, A. J. Brown.

Wasp's nest.—1st, G. Venn.

Beeswax.—1st, G. Venn; 2nd, G. Gunstan; 3rd, A. J. Brown.

OXFORDSHIRE B.K. ASSOCIATION.

This Association held a show of honey and wax at Kidlington, in connexion with the Kidlington Horticultural Show, on August 25th, which was a source of considerable interest. The tables were arranged with a centre group of honey, weighing upwards of 224lbs., in various forms, including shallow frames, standard frames, extracted honey, granulated honey, section honey, honey in skeps and bell-glasses; one of these was the largest taken in the county,

weighing 25 lbs., the property of Mr. T. Hughes, of Combe, Oxon. During the day exhibitions and lectures on the management of bees were given in the tent by Mr. E. Hancox, of Sandford St. Martin, who very clearly explained that modern bee-keeping was being recognised as one of the minor but important rural industries, and that in view of a probable large increase in fruit-growing, the extension of bee-keeping had a valuable practical bearing, while its relation to successful seed-growing (*e.g.*, mustard, turnip, rape, and white clover) was equally certain and important. English honey had greatly advanced in popular estimation, and was now much in demand. Upwards of 7000% worth of foreign honey had been imported into this country this year which might have been gathered at our own doors. The classes were well contested, the following being the awards:—

Class 1. For the twelve heaviest and best 1-lb. sections of honey.—E. Hancox and T. Hughes, equal 2nd prize.

Class 2. For the best twelve 1-lb. bottles of honey.—1st, E. Hancox, Sandford St. Martin; 2nd, Mr. Packford, Headington.

Class 4.—2nd, E. Hancox, Sandford St. Martin. Class 5.—1st, S. Hancox, Wytham; 2nd, E. Hancox, Sandford St. Martin.

Class 6.—2nd, S. Hancox, Wytham.

Class 7.—1st, T. Hughes.

Class 8.—1st, S. Hancox, Wytham.

Class 10.—1st, H. Edgington, Cassington.

Class 11.—1st, H. Edgington, Cassington.

Class 12.—1st, H. Edgington, Cassington.

Class 13.—1st, S. Hancox, Wytham.

THE DAIRY SHOW.

We wish to call the attention of our readers to a letter in this issue from Mr. W. C. Young, the Secretary of the British Dairy Farmers' Association, and to remind them that the entries close on the 14th September. We hope that those who have any honey to show will do so, and convince the Dairy Association that the honey industry is an important one, and that honey is worthy of co-operating with dairy produce. We would also like to call the attention of appliance manufacturers to this opportunity of bringing their goods to the notice of a large number of visitors. We are glad to hear that already a good many bee-keepers have entered honey for competition, and no doubt the liberal prizes offered will induce many more to compete. The show is held at the Agricultural Hall, London, and is visited by many thousands of visitors, who come up from all parts of the country to it. We hope, also, to find our Scotch and Irish friends competing and taking some of the prizes.

HONEY IMPORTS.

The value of honey imported into the United Kingdom in the month ended August 31st, 1891, was 3594.—*From a return furnished by the Statistical Office, H.M. Customs.*

DEVELOPMENT IN THE HONEY-BEE.

BY R. A. H. GRIMSHAW.

(Continued from page 338.)

No one who has watched the growth of horse-breeding in this country during the last fifteen or twenty years, giving us in this short time a large export of the finest animals in the world in place of a considerable importation, can come to any other conclusion than that, in the early future, pasture land will be much more extensively cultivated than at present, and also that the honey-bee will be a potent factor in this branch of agriculture, performing its infinitely minute, but magnificently vast, services to nature and mankind in the same silent, unobtrusive way characteristic of all the Creator's most important working forces.

To take the bee on its first entrance into its home (skep or bar-frame matters a great deal), the antiquated skep, accompanied by a mother-bee, drones, and workers, young and old, we find, before it issued from its late home, an active swarmer, it had secreted small discs of wax in its wax-pockets; that is, superfluous nutriment in the shape of fat had oozed through the wax glands, and remained 'until called for' in the aforesaid pockets; for who has not noticed the countless bits of wax underneath the place where a swarm has hung for even a short time only? Careful observation in this direction shows us that the bee not only takes with it a supply of raw material wherewith to perfect the substance with which to build the cells of the future home, but has, by an occult impulse, acted as if foreseeing the coming want. She has made the finished wax beforehand, just as the emigrant might take with him a store of bread, besides a supply of flour. When I have found pieces of comb in skeps built in the short time between taking a swarm and hiving it—between noon and evening—I have found plenty of evidence to support me in discarding the old, rigid landmark that the swarm, in its entirety, gorges before leaving. The wax-builders, in the excitement of the hour, seize whatever they can lay their tongues on, the younger and nurse bees gorge, but there is, besides these, a numerous contingent who evidently do not feel it painful to bend the abdomen and sting, and have not gorged themselves before leaving home. I cannot think it is with the least prescience that those who are full have fed, that they have the slightest knowledge of the use the honey is to be put to. Perhaps, and probably, the heat and excitement of over-population culminates at last into such a similar state of terror as we artificially produce on them with the smoker. They hustle themselves rapidly into cells—as the ostrich is said to bury its head in the desert sand—and drown their fear in the nectar bowl. And as, according to the ancients and moderns, 'the bowl affords relief'—alas! only too temporary in its nature—we find the indisposition to sting follow the gluttonous indulgence.

The bee, then, hanging in its festoon from the roof of the hive, or climbing over the backs of its sisters, seeks to fix itself as the anchor, or as a link in another chain, until in time impulse and instinct bring the whole community into a fairly orderly arrangement, when specialists in the craft may resume their ordinary avocations. Workers at once set out (indeed, many of these never suspended work but for the short time of clustering), and cell-builders, with their raw material nearly ready for use, ascend to the tops of the festoons and deposit on the dome of the skep, or on the wax starter in the case of frames, their now prepared contribution. We hold up the bee before an admiring public as being possessed of a surprising amount of intelligence, inasmuch as she is said to build her combs perfectly straight in the hive, so calculated with regard to cell foundation and hexagonal mutually supporting cell walls, that a maximum of stability with a minimum of building material is the result. Is it not a fact that the pressure together of circular cells of plastic wax gives us the six-sided cell wall, especially when pared down so thin that the movements of the bee working at the opposite side of the comb may be felt through it by the extremely sensitive antennæ, the wedge-shaped head of the worker pressing on this now hardening wax resulting in the sharp corners of the cell base? We also find drone and worker comb anywhere and everywhere upon a plentiful incoming of wax-making material, and this happens at swarming-time. When there is a great influx of honey we find drone comb built for storehouses; the queen entering these lays in them eggs, which have passed down the oviduct without being subjected to the results consequent on the action of the muscles attached to the spermatheca, and drone-breeding is the result. We also find the two kinds of cells—drone and worker—joined to each other by what are called accommodation-cells, which are simply attachments of wax built wherever the bee can plaster in wax and others can reach to scrape it away with the jaws. Such cells have been found that the bee could not enter, and these must have been pressed by comb and cluster weight into their shape before becoming hard.

Again, comb has been found—there are specimens in Mr. Cowan's collection—having five and four sides only to each cell, which cannot have resulted from any such cause as designed purpose on the part of the bee, but, I take it, must be from the unequal pressure together of plastic circles. I am therefore forced to the conclusion that the bee has not the wisdom to so utilise its wax as to give us the result of its wisdom in the shape of beautiful hexagons. The true wisdom of the wonderfully formed cell is to be found in the motive impulse inherent in the unconscious insect. The orderliness of comb arrangement is not to be found in the bee's home when left entirely to itself; the combs are built wherever there is space to build, and they hang down perfectly straight, not because they

are built so, but because the soft, tender new comb, unattached at the edges, in a hot hive, probably loaded with bees, and becoming heavy with brood or honey, follows the common law of gravitation, if, indeed, its straightness is not even previously secured, as it is being built, by the weight of the bees working in its building. This can easily be substantiated and proved by examining the building inside hives not set level.

(To be continued.)

WEATHER REPORTS.

WESTBOURNE, SUSSEX.—August, 1891.

Maximum .. 68° on 14th. Rain:—6·75 in.
 Minimum .. 39° on 30th. Heaviest fall, 2·04
 Min. on grass 29° on 30th. on 20th.
 Mean maximum 63°. Rain on 25 days.
 Mean minimum 51°. Average, 2·59 in.
 Mean temperature .. 57°. Sunshine, 158·65 hs.
 Frost on grass on 30th. Brightest day, 30th,
 10·65.
 Sunless days, 3.

Remarks.—The wettest August I have known. Mr. Bint's results have been so much like my own that it will be interesting to compare our respective honey harvests. My average for this year is 55 pounds per hive. The best hive has gathered 110 pounds, and the worst 16 pounds.—
 L. B. BIRKETT.

Correspondence.

The Editors do not hold themselves responsible or the opinions expressed by correspondents. No notice will be taken of anonymous communications, and correspondents are requested to write on one side of the paper only, and give their real names and addresses, not necessarily for publication, but as a guarantee of good faith. Illustrations should be drawn on separate pieces of paper.

Communications relating to the literary department, reports of Associations, Shows, Meetings, Echoes, Queries, Books for Review, &c., must be addressed only to 'The Editors of the "British Bee Journal," 17 King William Street, Strand, London, W.C.' All business communications relating to Advertisements, &c., must be addressed to Mr. J. HUCKLE, Kings Langley, Herts (see 1st page of Advertisements).

* * In order to facilitate reference, Correspondents, when speaking of any letter or query previously inserted, will oblige by mentioning the number of the letter, as well as the page on which it appears.

HONEY AT THE DAIRY SHOW.

[764.] Finding that a number of intending exhibitors of honey at the approaching Dairy Show are under the impression that they will be required to attend personally, or by an agent, to see to the proper staging of their exhibits, will you kindly allow me to state through your columns that the Association will provide the requisite tables, and arrange for the due display of honey entered in the respective classes, provided it is delivered at the Royal Agricultural Hall by six p.m. on Monday, October 12th. Although entries do not close until Monday, September 14th, I am glad to be able to say that present indications point to the conclusion that a good deal of interest is likely to be mani-

fested in the honey classes. A great many applications have been received for schedules of prizes, and I should be pleased to forward a supply to any of your readers who can usefully dispose of them.

It may be interesting to add that we are prepared to give facilities for the exhibition and sale of apiarian appliances, close to the honey exhibits, and that several manufacturers have already taken advantage of this offer.

As in former years, we are endeavouring to make arrangements with the various railway companies for the running of cheap excursion trains, to enable country visitors to attend the Show in large numbers.—WILLIAM C. YOUNG, Secretary British Dairy Farmers' Association, 191 Fleet Street, London, E.C.

NOTES BY THE WAY.

[765.] The weather since my last notes, a fortnight ago, has been of the same chequered kind, rain and shine nearly every day. Mornings of the brightest and most promising for a fine day, have only too quickly changed to a wet afternoon or evening. The rainfall of August has only been exceeded once since 1850, and that was in 1865, when it was 8·508 inches, as against 7·439 in August 1891. This means heavy losses to the tenant farmers, whose crops of corn are growing as it stands in the fields, while some I have seen in stock is grown into a mat of green among the ears. The bee-keeper's lot has not been a happy one this year, but we have not been so hardly pressed as the farmer. Though our crop was light, we have not had it spoiled by the weather; our busy labourers stowed it safe from the elements when they could get the chance.

I am very sorry to hear from friends in Scotland that the weather there is on a par with ours in the south, and that they are losing the heather harvest. Bloom and honey in abundance, yet the weather is so bad the bees cannot make much progress, and, according to the bee-papers of America, they have had a similar season to ours—a late, cold spring, and an indifferent summer; of course, on their vast continent, there are many exceptions, where good yields of honey are reported; but taking the country throughout, the crop is below the average.

Super-clearers.—'That bees do nothing invariably' is proved by the two last issues of *B. B. J.*; in one, our veteran friend, Mr. J. Walton, gives an instance where the bees failed to clear out, and that was when he placed an empty super crate under or between the brood frames and the clearer. Now 'S. M.' (763), in last week's issue, speaks in praise of the clearer, under exactly the same management. I, too, have had just the same experience myself; on two occasions I inserted crates of empty sections under the clearer, and I found a great many more bees in the crates in the morning than where the bees had to crowd themselves into the brood nest below. I have had several clearers in use, and I shall have more

another season: I predict they are come to stay, as they are a very useful appliance with modern bee-keeping, more especially where bees are kept in suburban gardens, and the neighbours over the partition on both sides have had to beat a hasty retreat when the hives have been opened to take off the honey in previous years; but with the clearer, the job can be done with very little disturbance to the bees, and it is strange the few bees that may be left in the sections do not show fright when the quilt is taken off.

Mead or Metheglin.—Mix honey and water to the consistency to bear up an egg; put in boiler (copper or brass preferably), and remove all the scum as fast as it rises, till it reaches boiling-point; then add spices to suit taste—cloves, ginger, and pimento are the usual kinds used, equal quantities of each bruised and put in a long bag that will go in the bung-hole of barrel. This spice should be put in the boiler as soon as it boils, and keep same boiling twenty minutes; then put the liquor into a pan or cooler till nearly cold, and then put it into the barrel, and leave it to ferment spontaneously. At least, that is our plan, though some I know add a little brewers' yeast when it is blood-warm, and allow it to stand twenty-four hours before turning. I may say our mead is considered the best in the neighbourhood.

Your table of 'Honey Imports' last week is suggestive of many facts connected with our pursuit, the principal of which is the growth of our imports in a short time from 23,407*l.* in 1888, to 41,311*l.* in 1890, and in the present year the increase is sustained. This shows conclusively that the public taste for honey is growing and increasing year by year, and also that bee-keeping is not likely to be overdone in this country for many years to come, though I expect to see in the near future a great extension in our ranks. The utility of the busy bee was never in the history of this country acknowledged in so decisive a manner as during the last decade; and as the knowledge is rapidly and constantly extending, the number of bee-keepers will increase, as fruit-growers will see the necessity of keeping bees near the fruit-trees to secure perfect fertilisation of the flowers, and the action of the County Councils in different parts of the country in voting sums of money to aid the county Bee Associations, will infuse new life into the respective Associations, while articles in the press will and do call attention to the craft as one of the most lucrative the cottager or small farmer can adopt, or the dweller in villadom indulge in as a hobby.

Those Punic bees are being discussed—or shall I say puffed?—to raise a 'boom' on the American continent. One party offers them at forty dollars per fertile queen! A humorous writer, 'Veritas,' in *American Bee Journal*, writing on their origin, says they were a cross, during the second Punic war, between the 'African piss-mire and the Roman mosquito,' and that, according to reports, they increase so rapidly that one colony will increase to 20, and gather 1000 lbs. of the nicest honey in one season; the second

year to 400 colonies, and give 20,000 lbs.; and the third year to 8000 colonies, and give 8,000,000 lbs. of honey. There, friends, you have the figures; the facts will come out by practical experience in the years to come, when the African race of bees has been tested and tried side by side with the English, German, Ligurian, and Carniolan races at present with us.—W. WOODLEY, *World's End, Newbury.*

THE SEASON'S EXPERIENCE— FOUL BROOD.

[766.] Now that the honey season is practically over (except for heather honey), there is time to put down the results of one's experience. I cannot let this opportunity pass without expressing the gratitude bee-keepers owe to your *Journal* for the many practical instructions given in it.

From amongst many such instructions, I would refer more particularly to two, namely, uniting with the help of flour, and placing swarms on the stand of the original stock. These two simple instructions have probably enabled me to double my crop of surplus honey during the past season. In this district the past season has been the best, at any rate, since 1885, the year from which my bee-keeping experience dates.

I began the season with eight stocks, and after losing several swarms, I can now count twelve. I have taken off over 450 completed sections. On opening some of the hives to pack up before removing them to the heather, I find that brood frames are absolutely full of honey, so much so that I propose to give the bees breeding-space by inserting some empty frames of comb or foundation in the centre of each hive.

Here the winters are very mild, and the winter consumption of honey, till at any rate the end of April, is very small. I should not hesitate to winter a stock of any size on ten pounds of well-sealed stores.

Last was the most severe winter we have had for many years, and on three or four occasions we had from ten to twelve degrees of frost. I left some hives through all the winter on the heather, with empty section crates on them, and did not bring them home till about May 20th of this very backward year. I found them perfectly crammed with bees, and with at least ten or fifteen pounds of last year's heather honey in each hive. I should add that by June 15th (when honey first began to come in here) all the heather honey was gone, and even the outside frames were filled with brood. Had the season been an early one, breeding would have been checked by the cells being filled with honey.

Before I close I should like to say a few words on the very sore subject of foul brood. I have had a long and melancholy experience with this pest, and in my case mere feeding with disinfectants (salicylic acid, phenol, formic acid, or Naphthol B.) has proved useless. But, early in my troubles, I found that swarms from infected stocks, if put on sheets of foundation in fresh

hives, remained comparatively free from all trace of infection, especially if the new hive was, as far as practicable, saturated with some disinfectant. I have for some time past thoroughly washed my floor-boards and frames (when I had any suspicion as to the stock from which the swarm came) with a strong solution of carbolic acid; but the difficulty has been that this cannot be continued with such a disinfectant when bees are once in the hive. I welcome therefore such a disinfectant as naphthaline promises to be, for apparently it is just what is wanted, as it can be used at any time. But I should advise no half measures in dealing with foul brood. Has this question been ever definitely answered: Does the melting temperature of wax, or what other temperature, with certainty destroy the microbes or bacilli of foul brood?—W., *Cornwall, August 26th.*

[If wax is kept at a temperature of 212° for four minutes, it is stated the microbes are destroyed. In making foundation, wax is kept at this temperature for twenty-four hours.—Eds.]

BEE-KEEPING IN IRELAND.

[767.] I am sure you would like to hear some of my experiences in this part of the country. I began the season with six stocks (four bar hives and two skeps). Some of my bees I keep near Lough Erne, within about twenty yards of it. 1. Would you think it a good locality for bees? The remainder I keep about half a mile from lake. 2. Would you advise keeping all bees at last place? I had six swarms this year; two out of six I lost. One of the swarms I put in bar-frame hive (Abbott's) on eight frames and crate of sections. I intend taking off all my remaining sections on bar hives in a few days, as honey season is over about this district. I have got very little section honey this year, on account of swarming and so much rain. The most I have taken from one hive is thirty-six sections. Bee-keepers about here are all complaining of so little honey, owing to the very wet season; nearly the whole of July and August has been wet, excepting a week or two. I have heard of a stock of bees which left skep and swarmed, as they had no food—this stock was this year's July swarm—but was hived again, and is being fed; so you see it has been a bad honey season here. I intend driving a skep of bees in a few days, and uniting them to a second swarm, which is in a large, flat-topped skep. 3. Can I do this, and which would be the best way to proceed? I have used cone-shaped super-clearer this year on one of my hives with success. Thanking you for insertion of above in your valuable *B. B. J.*—J. A. A., *Kesh.*

[1. Not the best locality, and we should only keep bees here if we had no better place. 2. Yes; we should prefer this locality. 3. Yes. The best way would be to drive the bees into a skep, and towards the evening invert the skep holding the second swarm, taking care to do so in the direction of the length of the combs, so as not to break them down. Then sprinkle the bees well with thin

syrup, and turn the skep back on to a cloth, raising the edge with a stone. Throw the driven bees on to the cloth in front of the hive, and when they are all in, place the skep on its stand.—Eds.]

SWARM-CATCHERS AND BEE-VEILS.

[768.] 'X-Tractor' has my sympathy in his failure to produce a swarm-catcher with a piece of excluder zinc. I tried the same dodge this year, as I didn't want the swarms to go over the garden wall. After a few hours they got used to the impediment, and used to squeeze through like diving ducks. The incoming bees took particular precaution not to drop any of their pollen, for they passed in their pollen legs sideways, and the effect was very ludicrous. I kept the catcher on for about a month, and then had to take it off because the drones were unable to get out, and caused too much excitement. The strange part of the performance was, that when I took the bent excluder off I stood it on a box a few feet away, and nearly the whole of the bees flying home flew to the excluder, squeezed through the holes at the end, then flew to the hive. I notice, for the first time, bees working on the yellow marigold pretty freely. I quite agree with 758 (page 383), anent bee-veils. About two months back I was manipulating without my veil. One bee turned in honey-gathering to manipulate me. It eased itself on my eyelid, which turned out a veritable *multum in parvo*, for within two days one side of my face became like a half-moon, and remained so for a week. I was told by several young ladies that I looked very fascinating. Now respecting intoxicating plants. Nothing seems to overcome the honey-bee, but last week I took drunken humble-bees off dahlias, hollyhocks, and sunflowers, and so far were they gone as to lie on their sides on the ground and hold up a leg for a 'pal' to give them a help up. They disappeared by the morning, but whether they reached home in the 'sma' hours of the twa, or have been invited into the 'proverbial parlour' of the spider, I know not.—G. NEWMAN, *Camberwell.*

INCONSISTENT SHOWING.

[769.] In reading my *Journal* to-day I noticed in 'Queries and Replies' (No. 402) a question headed 'Inconsistent Showing.'

Upon reading this I concluded the writer referred to myself as 'B.' With your permission, I wish to inform 'J. M.' and others who may be interested how my honey was so much superior at the second show to what it was at the first one.

Our district does not appear to be a good one (at least, for early honey)—no fruit-blossom or sycamores, and very little clover; the consequence is the bees have to be fed late into the spring.

Last year, 1890, I could not take any sections off until August, and could only extract about twenty pounds of sealed honey in time to appear

at the county show, held the last week in July, although I took over three hundredweight in the following month of extracted honey of a superior quality, which enabled me to take first place at two of the following shows.

This year all the honey gathered in our district was gathered in July, and, as I had good honey last year, I expected to have some of the same quality this. I had some nice, clean, shallow frames, beautifully sealed over. I extracted until I had satisfied myself that I had all the best honey. When I came to bottle it I found it much darker than last year's; however, as I had entered, I thought I would take it to the show.

I find the reason it is so dark this year is due to the fact that the weather was fine when the wild raspberry-canes were in bloom. There are large patches of them in the woods close by, so that men, women, and children get basketsful of the fruit.

The reason why my honey was so much better on the 12th of August was no secret at the show, and I am surprised to find that 'J. M.' was not aware of it.

I have a small apiary about seven miles from home, and when I found my honey at home was not so good as that of last year I took my extractor down to try my luck, and had about thirty pounds of very good honey, which I was not long in getting ready for the next show, leaving all the other at home.

I have no explanation to offer for 'A.', who says he extracted his honey from sections on the same day that I extracted mine from shallow frames. His bees are somewhat nearer the raspberry-canes than mine.—B.

PUNIC BEES (?).

[770.] I read with some astonishment your note about Punic bees in this week's *Journal*. You profess not to know anything about them, yet that same ignorance does not prevent you giving them a bad character. The word Punic does not necessarily mean treacherous or faithless. The Romans used *punica fides* as a synonym for falsehood for the same reason and possibly with as little reality as Frenchmen of a past generation used *perfidie Albion* to express their detestation of English treachery.

However, my main object in sending you this note is to supply you with my experience of Punic bees. I shall leave the importer to settle definitely their precise location in Africa.

During the past three years I have submitted the Punic bees to careful tests, and I find that they build up rapidly, winter well in our severe northern climate, and come out strong in spring. They are smaller and darker than our native bees, but are more active, working earlier and later. After trial of the various races of yellow bees, I found none to equal Howard's or Raitt's natives, but a cross between these and Punic bees gives my ideal of a good all-round business bee.

By inserting this, the only contribution I

mean to trouble you with on this subject, you will much oblige—W. STOKES, *Balnastraid Farm, Carr Bridge, Inverness-shire, August 29th.*

[If our correspondent had been more careful in reading our remarks, he would not have so hastily accused us of giving Punic bees a bad character. We said we knew nothing about such bees, and did not know any race going by that name. Our correspondent says the word Punic does not necessarily mean treacherous, or faithless, but he does not say what else it does mean. We can supply the omission, as it may interest some of our readers. It is derived from the Latin *punicus*, meaning of, or pertaining to, the Carthagenians; deceitful, treacherous, faithless. *Punica fides*, Punic faith, the faith of the Carthagenians, meaning perfidiousness, unfaithfulness, treachery. *Punica fides* was applied by the Romans to the faith of the Carthagenians because they believed in the perfidy of the latter. Are we to suppose a similar belief has given the name of Punic to bees? We repeat that we know no such race, and the only African bees we know of are the varieties from Algeria, Tunis, and Morocco, which we described, besides the species alluded to, in *B.B.J.* for 1888. The Punic bees have been styled *Apis niger*, and although we are tolerably well acquainted with the bees of Africa, we know no such species, and have strong reasons to doubt the existence of such a species. Our correspondent has not adduced a single fact to prove that what he calls Punic bees are a distinct race or species, or that they may not be the common black bees, which we have mentioned as cultivated in the countries of Northern Africa, with which bees we are acquainted, and which have, as we stated, not sustained their reputation when imported into Europe. It is not enough to assert that there are such bees, we want corroborative evidence to prove it, and until such proof is forthcoming, we must decline to recognise such a species as *Apis niger*, alias Punic bees. We note especially that from our correspondent's three years' experience of so-called Punic bees he is not satisfied with them, and prefers a cross between them and the native races. We should be rather curious to know if he gave 5*l.* 5*s.* a-piece for his queens?—Eds.]

HONEY OR INCREASE?

[771.] May I state to you, as a two-year bee-keeper, the results of this year's care for my bees, in respect to the yield of honey and increase of colonies, and solicit from you a *frank opinion* on the matter? Let me say, first, that my colonies are not under my own care, but are, I believe, good, though at present inexperienced, hands. The hives, too, are in a splendid neighbourhood for honey-gathering. It is two years since I bought two skeps, the bees of which were no good to me. One colony died in the spring of 1890, and the other decamped soon afterwards, when it was found that not an atom of honey was in the old black combs. Two frame hives were then bought and stocked with bees. These hives were removed to their present positions in February last. June 12th I had a swarm from one colony, and on June 24th the other bees swarmed. Both

were hived successfully in frame hives, and are doing well. I have now, therefore, four colonies. Two after-swarms were returned. Supers were put on three, with foundation starters in them. I saw the state of the store-chambers and of the supers beginning of August. The stores seemed abundant, the bees very strong in numbers. The sections in each crate had some sealed comb—more were unsealed, but very nearly filled with honey, while a good many others were not filled with combs even. I waited a fortnight longer, hoping the sections would be completed and sealed; but they were not, so, as I gave up the hope of perfection in the crates, I removed them, and extracted the unfinished sections. All the honey I got from the three supers was about thirty pounds.

The season, therefore, has given me thirty pounds of honey and two extra colonies, and the cost to me in appliances, colonies, unused sections, and food for bees, &c., has been over 14l. But apart from the expenses, do you think that thirty pounds of honey and two extra colonies are a sufficient return for the season? I do not feel it to be so when compared with the return in honey of other bee-keepers. What amount of honey might I have expected from the three colonies, situated, as they are, in a splendid locality for white clover and other honey flowers? I am not soon wearied in a thing I love.—BETA, *September 3rd*, 1891.

[We are rather in the dark as to how you have proceeded, but would say, as a rule, you must not look for increase and a harvest of honey too the same season. To obtain a harvest of honey, you should have endeavoured to prevent swarming, and put on supers so as to give room in advance of the requirements. You do not appear to have done this. Then, when the bees swarmed, the swarm should have been placed on the stand of the parent stock, and the supers from this should have been put on the swarm, when storing in the supers would have been continued. You do not say that this was done. If the hives were allowed to build up during the honey-flow, instead of working in supers, we are not surprised at the small yield; in fact, we are surprised that you got so much. Your expenses have been high, but you have the stock in hand, and if you put a value on it, you will find the interest not so bad for a first season, when nothing should be expected.—EDS.]

Queries and Replies.

[420.] *Extracted Combs.*—1. On 15th ult. I extracted from twenty-four shallow frames, and shortly after I replaced twenty of them in two boxes over the hive from which they had been taken. Over the brood nest were the quilts with small feed-hole. My idea was that the bees should clean up and take below all the honey they could get. I find that they have cleaned up and have even repaired the combs, but the honey has been stored in the cells again, very few of the combs being free from it. Although the ling is in blossom in the neighbourhood, the weather during the past month has been so bad

that the bees can hardly have gathered from it. How can I get the honey stored below? I do not want to extract again, and the hive being very strong, I cannot well put the frames behind a dummy. Will taking the quilts off the top box have the desired effect, or would this chill the brood below? As things are, I fear the bees will store pollen in the combs. They deserve a little honey, for they pulled out their combs, and gave me just a half-hundredweight to bottle.—*Hybrid Carniolans.*—2. In settling the choice of queens, should size go for much? One of my hives swarmed on 18th July. The young queen is small and slim, and did not lay for quite a month. There is little brood. Would you keep her?—H. J. O. W., *Leeford*.

REPLY.—1. The bees have evidently no room to store their honey below, or honey is still coming in. Leave the combs on the hive a little longer, and no doubt the honey will be carried down when they have empty cells to store it. Remove any combs that have been cleaned up. 2. We prefer large, strong queens, and should select such in making a choice. The queen may improve, and those bred so late in the season rarely lay much until the following year. You should only replace her if you have a better one to substitute.

[421.] *Carniolan Bees.*—I enclose two bees* and another like a queen, but it seems rather yellow. I found it on the top of the quilt of a first swarm, which had cast twice, and in which I heard another queen piping after second cast. I shall feel obliged if you let me know what it is, and to what kind or race the bees belong, or if pure. I sent for a stock of *pure Carniolans* from a dealer in England last spring. I said I would take a cross, Carniolan and black, but he said he had none he could recommend, and that he would send on the *Carniolans*. Well, they arrived about the 15th of May. On the 2nd of July they swarmed, and about a week after swarmed a second time, and a few days after a third time. About the 1st of August the first swarm cast, and a week or so after cast a second time. I need hardly say I had got quite disgusted with all this swarming and no prospect of an ounce of honey. Nay, more, it means mostly feeding, and no honey all through. I may state also that I find the bees quite vicious until subdued by smoke. I wrote the dealer twice, asking him if he could let me know for certain that the bees are *pure Carniolans*, or, if not, to let me know what they are, and he has not taken the trouble to reply.—J. McLENNAN, *Ross-shire, August 26th*.

REPLY.—The bees came quite flat, but the yellow insect you think like a queen is a wasp, and one of the bees looks like a *Carniolan*. The other was too much smashed to recognise. Bees for identification should always be sent through the post in a tin or wooden box. You must not condemn a race from experience with one queen. These vary in every race, some being much more inclined to rear swarmers than others. It is evident your hive was too small for the prolific

ness of your queen, and the only way to prevent swarming is to give abundance of room, and so prevent the swarming fever. When once the swarming fever is aroused every device of the bee-keeper will not avail to stop swarming.

[422.] 1. Will you kindly inform me in your next number which is the best way to prevent a hive of driven bees (from a skep to a wooden hive) from robbing the next hive? I have already contracted the entrance, without any result. Ought I to feed them? If so, please tell me what to use, including a mixture to prevent foul brood. 2. A few days ago I was told I might have the bees if I cared to drive them from a skep. On examination, I found the skep full of comb—no honey and no bees; probably been dead two or three months. Is the comb any good for use in a bar-frame hive?—E. W. G., *Newbury, August 25th.*

REPLY.—1. During such weather as we are having driven bees ought to be fed, and no doubt yours are starving. Feed with cane-sugar syrup and Naphthol Beta as a preventive of foul brood. 2. The combs are hardly worth transferring to frame hives, seeing that foundation is so inexpensive. There is also a risk of introducing disease with old combs from skeps.

[423.] In an article by Dadant & Son, in *Gleanings*, quoted by you in your *Journal* of August 20th, Mr. Dadant says: 'After the colony has swarmed, it is sufficient to return the swarm after two days to ensure the destruction of the cells, or of the young hatched queen, or of the old queen, at the bees' choice.' Do you think he means that this may be done without flour, and that the bees would all be friendly—no fighting and loss of bee-life? It would suit me exactly if I could return a swarm in this way, without removing the two or three supers generally on the hive, in order to cut out the queen-cells.—BEE SWING.

REPLY.—During a good honey-flow, bees from different hives can be mixed without quarrelling, but otherwise the usual precautions should be taken, either to have them all scented alike, or to unite them with flour. Another way is to make a swarm of the bees in stock hive, then throw down the two lots on a board in front of entrance, and they will all mix and enter quietly.

Bee Shows to Come.

Sept. 19th.—Jedburgh and District B.K.A. in the Sessional School at Jedburgh. Entries close Sept. 15th. For schedules apply to Thos. Clark, Sec., Pleasant's School House, Jedburgh, N.B.

October 13th to 16th.—British B.K.A., in connexion with the Dairy Show at the Royal Agricultural Hall, London. All open classes. Entries close September 14th. For schedules apply to Wm. C. Young, Sec., 191 Fleet Street, London.

Echoes from the Hives.

Old Eastbourne, August 31st.—As I have the management of my employer's bees, I am sending the result of this summer's honey-taking. We had four bar hives, standard-frame size, to start with in the spring. No. 1 hive swarmed late in June. I returned the swarm again to the same hive. From this I have taken thirty-five pounds of honey. No. 2 swarmed within a day or two of the first, and has given thirty pounds. No. 3 hive had suffered very much with dysentery, and nearly all the bees had dwindled away, when a stray swarm came from somewhere, and took possession of the hive. They filled all ten frames in about five weeks. From this hive I have taken sixteen pounds. No. 4 hive has given thirty-three pounds. Altogether, 114 pounds extracted honey. I have found the honey-extractor very useful. All the sections were taken off in the middle of August. I never take any honey from the standard frames. The result of my own bees will be sent later on.—R. CHATFIELD.

Oakfield, Enfield, August 31st.—It may interest some of the readers of the *Journal* to learn that, in spite of the wet summer, there has been a very fair yield of honey in this district. A neighbour of mine has had upwards of fifty sections from his one hive, while I have taken 260 pounds in sections and extracted from my four stocks, at the same time leaving sufficient for the coming winter. The quality is very good, but many of the sections are not so well worked out as could be wished—owing, doubtless, to the cool nights. There is, of course, nothing novel in the suggestion, but I am very much disposed to believe that if 'doubling' were more generally tried the swarming nuisance would be considerably mitigated. My bees are so prolific that I find twenty standard frames are none too many for the brood chamber, and the result is that, although the stocks become very strong, the disposition to swarm is checked. I do not presume to advise, but would ask those who want honey and not swarms to try this plan next season.—H. L.

Ballindalloch, August 31st.—In this district the month of August has been wetter than July. There have been twenty-seven wet and four dry days, and while I write it is pouring. Heather blossom is at its best, so that we can only count on a fortnight for any surplus. I do hope to-morrow may usher in hot weather.—ALEX. STRATHAM.

New Ross, August 31st.—Naphthaline I have found most beneficial during past few months. Combined with the use of Naphthol Beta in syrup, it has, if not cured, certainly greatly improved the condition of my old stocks, one of which was badly attacked. I have no doubt that its continued use will give me a fair start next year. Thanking you and the *Journal* for the invaluable assistance given me of late in my treatment of foul brood.—ROBERT DE R. S.

Plymouth, August 31st.—I enclose amount of honey taken this year from two hives of Carniolan bees:—Seventy-seven one-pound sections, and eleven pounds extracted honey, total eighty-eight pounds.—J. T. AYLEN.

Notices to Correspondents and Inquirers.

Letters or queries asking for addresses of manufacturers or correspondents, or where appliances can be purchased, or replies giving such information, can only be inserted as advertisements. The space devoted to letters, queries, and replies, is meant for the general good of bee-keepers, and not for advertisements. We wish our Correspondents to bear in mind that, as it is necessary for us to go to press in advance of the date of issue, queries cannot always be replied to in the issue immediately following the receipt of their communication. All queries forwarded will be attended to, and those only of personal interest will be answered in this column.

J. C. (Ballyshannon).—If you have witnesses who observed the bees leave your hive and, without losing sight of them, saw them hived by your neighbour, and can identify the hive, you can claim them, but not otherwise. 2. You can then sue for the value of the swarm in the County Court, if he will not return the bees or pay for them. If you will send your full name and address on stamped envelope, we will send you specimen of veil material you ask for.

M. K. (co. Kilkenny).—The sample sent is raw cane sugar, and is quite unfit for autumn feeding. You must use refined cane.

MISS E. TAGG.—White clover may be sown at any time, as it flowers the second year. It is frequently sown with oats in the spring, or in wheat that has been sown the previous autumn.

AMATEUR (Wolverhampton).—1. To stop robbing, close the entrance so that only one bee can enter at a time; or put a piece of glass 8×5 inches in front of flight-hole, the top resting against hive, and the loose end 1½ inch from entrance. 2. Bees have either got a queen or have been too long without one. It is too late to rear queens now, so you had better get one and introduce. 3. 1½ oz. of Calvert's No. 5 Carbolic acid, 1½ oz. of glycerine, 1 quart warm water. Try the cone clearer, which is more effectual. 4. The *British Bee-keeper's Guide-book* will suit you.

J. A. AIKEN (co. Fermanagh).—1. *Calluna vulgaris*. 2. *Erica tetralix*. Both yield honey, but the first is best.

R. DE B. SAUNDERSON.—1. Bees can make use of wax, and use up the wax from queen-cells in this way. There is no advantage in giving driven bees sections, as they do not generally remove the wax from these for building. The combs could be cut out and placed in frames, but you will not get such regular combs as you would with foundation. The sections, after cleaning up, should be stored away for use next year. 2. Demerara sugar can only be used for spring or summer feeding—not in candy.

J. A. (Tenby).—1. The sample of honey sent is very dark and strong-flavoured, and in a

good competition would not stand any chance of a place in the prize list. 2. You do not say what you did to induce the bees to take to the sections early in the season, or when you put on the supers. 3. The sugar sent is not suitable for bee-food. Use No. 7.

C. PACKARD (Oxford).—It is advisable to use Naphthaline as a preventive as well as medicated syrup.

W. SPROAT.—You can do no more than what you are doing, simply persevere in the treatment.

C. S. (Harringay).—We will endeavour to give the information at an early date.

STEAM FACTORY for Bee Appliances.

ORDERS addressed J. ROSS, Stranraer, Wig-townshire, N.B., will be attended to.

NAPHTHALINE AND NAPHTHOL BETA.

Both the above may now be had at the Office of 'THE BRITISH BEE JOURNAL' and 'BEE-KEEPERS' RECORD,'
17 KING WILLIAM STREET, STRAND, LONDON, W.C.
NAPHTHALINE in packets, 6d. post free.
Large packets, containing more than four times the quantity of the smaller ones, 1s. post free.
NAPHTHOL BETA, 1s. a packet, post free.
Instructions for use sent with each packet.
Special prices for quantities.

NOTICE.

Will be ready in a few days.

A New Edition, the 11th, of
**THE BRITISH BEE-KEEPER'S
GUIDE-BOOK,**

By THOS. WM. COWAN, F.L.S., F.G.S., &c.

Revised and enlarged.

Almost entirely re-written. Much new matter and many fresh illustrations added.

Fcap. 8vo., price 1s. 6d.; or in cloth gilt, 2s. 6d.
Postage, 2d.

To be had of HOULSTON & SONS, Paternoster Sq.; all Hive Dealers, Secretaries of Bee-keepers' Associations, and of J. HUCKLE, *British Bee Journal* Office, Kings Langley, Herts.

**THE MANAGEMENT OF STRAW
SKEPS.** Designed to teach the Cottager how to obtain the best results at the least possible cost. Price 1d. Ditto in Welsh, 1d.

JOHN HUCKLE, Kings Langley, Herts.

THE ADULTERATION OF HONEY.
By Otto Hehner, Analyst to the British Bee-keepers' Association. Price 2½d., post free.

B. B. Journal Office, Kings Langley, Herts.

Special Prepaid Advertisements.

Situations, Publications, Bee Plants, &c.—Twelve words and under, Sixpence; for every additional Three words, One Penny.

Trade Advertisements not inserted under this head.

WANTED.—1-lb. Sections of Honeycomb, first quality. Prompt Cash. Packages sent. Well-filled Bell Glasses, Frames and Caps purchased. Address Mr. HURST, Bexhill, Sussex. 242

WALLFLOWERS will give splendid forage for Bees in Spring. Fifty plants, 1s., post free. Address NORMAN PARKIN, Blakenhall, Wolverhampton. K 83

FOR SALE.—Healthy Driven Bees, 1s. 3d. per lb., and Queen. Packing-box, 6d. Young Queens, 1s. 6d. each. Address E. GARNER, Broom, nr. Higgeswade, Beds. K 93

HEALTHY DRIVEN BEES, 1s. 6d. per lb. With Queen, Box, and Packing free. Carriage not paid. Choice Natural-raised 1891 Queens, 2s. Safe arrival, and Carriage paid. Stamp for reply. Address HOLDER, Wimborne, Dorset. L 12

FOR SALE.—Five Strong Stocks of Bees in Bar-frame Hives, complete, 30s. each. Two Swarms in Skeps, 10s. each. Apply, Rev. E. DAVENPORT, Stourport. L 17

FOR SALE.—Eight Strong Stocks of Bees in Bar-frame Hives, cheap, in consequence of Removal. For price and particulars apply to SAURTHWAITE, Sutton, Retford. L 18

STRAWBERRIES.—Well-rooted plants, Keen's Seedling (early) 2s. 6d. per 100; Laxton's Noble (new, very early), 3s. per 100; Sir Joseph Paxton (best main crop), 2s. 6d. per 100; British Queen (best late), 2s. 6d. per 100. Raspberry Canes, good bearers, 5s. per 100. Address BLANKLEY, Denton, Lincolnshire. L 19

CYLINDER EXTRACTOR for Hire, 2s. per week and railway carriage. Address ROLLINS, Stourbridge. L 20

NOTICE.—I cannot hook any more Orders for Driven Bees this season. A. J. CARTER, Billingshurst.

FOR SALE.—200 Screw-capped 1-lb. Bottles. Finest quality 1891 Extracted Honey, 10s. per dozen on rail. Address ERNEST E. DAVIS, Great Bookham, Leatherhead. L 21

DRIVEN BEES, with Queen, 10d. per lb. Box, 1s. Extra Queens, 1s. 6d. each; five for 6s. Guaranteed healthy. Address S. OATEN, Prior's Farm, Pitminster, Taunton. L 22

WANTED.—One or two acres of Land, with Cottage, within ten miles of London, in a neighbourhood, suitable for Bee-keeping. Apply to 'G.,' B. E. J. Office.

FOR SALE.—Having had considerable difficulty to obtain suitable Boxes for 1 lb. Sections, and bought larger quantities than required, I shall be pleased to sell at 4s. 6d. per gross, cash with order. Address MARTIN, 4 Woodland Place, Bath.

WANTED.—New Honey in 1 lb., 1½ lb., and 2 lb. Sections. State quantities of each size, and prices expected. Address Mr. ALEX. LETCH, 208 St. George's Road, Glasgow. Terms cash. 247

ENGLISH QUEENS, tested, 2s. 6d. each, post free. Address C. N. WHITE, Somersham, Hunts.

THE 'ENGLISH' HIVE.

Transferring Season now on.

TRY THIS HIVE, it is the best in use, and once used will be always used. No more cutting Quilts necessary, as the Bees can be fed from the side of the Hive. See description in B. E. J., August 6th, 1891, p. 351. Price for Floor-board, Body, and Zinc-covered Roof, 11/6 only. The English Wax Extractor, price 7/6.

For particulars apply to A. T. WILMOR, St. Albans.

BALDWIN'S

is the Oldest Establishment in the United Kingdom wholly devoted to Bees and manufacture of

Bee-keepers' supplies. His prices will compare most favourably with those of any other Maker, while for quality of material, suitability and workmanship, he has no rival. 'Why can he give better value for money than others?' Because he spends less in large 'puffing' advertisements, buys in the best markets for prompt cash, has no rent to pay, and personally conducts his own business.

For prices and full particulars of Goods see Baldwin's Bee-keepers' Instructor (and Illustrated Catalogue combined), which 'contains more practical and reliable hints than all the large, expensive books,' post free for 2d. stamps. Address S. J. BALDWIN, The Apiary, Bromley, Kent. N.B.—Move than 500 Silver and Bronze Medals, First and other Prizes, and Testimonials innumerable.

THOMAS LANAWAY & SONS,
Bee Appliance Manufacturers
AND DEALERS,

26 STATION ROAD, REDHILL.

Catalogue post free on application. 2891

J. TREBBLE'S
BEE HIVES.

All Machine-made.

My 8/6 COTTAGE HIVE beat all comers.

Awarded Seven Prizes this year. Catalogue free on application to J. TREBBLE, Saw Mills, Romansleigh, South Molton.

British Bee Journal and Bee-keepers' Record.

OFFICE :

17 KING WILLIAM STREET, STRAND, LONDON, W.C.

PURE CANE SUGARS.

For the accommodation of Bee-keepers, guaranteed Pure Cane Sugar will be supplied in large or small quantities through this office at the under-mentioned rates:—

MOIST. Neat bags, 14-lbs. 28-lbs. 56-lbs. Cwts.
3. MUSCOVADO 2/7 5/2 10/- 19/6

CRYSTALLISED.

4. DEMERARA } Crystals 2 9 5/4 10/6 20/6
5. BARBADOS }
6. TRINIDAD }

REFINED CANE.

7. WHITE CRYSTALS (Small) 3/0 5/10 11/6 22/6
8, 9. (Medium and Large sizes, 1½ per Cwt. extra.)
10. LUMP (Cut Loaf) ... Boxes, 3/3 6/3 12/3 29/6
11. LUMP DUST 3/- 6/- 11/9 32/9
12. PRESERVING 3/- 6 - 11, 9 31/-

FINE.

13. GRANULATED 3/3 6/3 12/3 23/9
14. CANTOR Coarse (15 Fine) 3/9 7/3 14/3 27/9
16. ICING... .. 4/3 8/3 15/9 31/-

All above guaranteed made from CANE SUGAR only, and free from BEET, CHEMICALS, etc., etc.

CARRIAGE PAID on Orders over 5/0 (or 28-lbs. Sugar) to London and Suburbs.

COUNTRY ORDERS, not less than 2-cwt. carriage paid at 1/0 per cwt. extra.

(Scotch and Irish orders, special arrangements.)

Cash to be sent with order, and purchasers will please observe that if samples are required or replies asked to inquiries, a stamped addressed envelope must be sent, as we cannot undertake cost of postage.

THE
British Bee Journal,
BEE-KEEPERS' RECORD AND ADVISER.

No. 482. Vol. XIX. N.S. 90.]

SEPTEMBER 17, 1891.

[*Published Weekly.*]

Editorial, Notices, &c.

USEFUL HINTS.

WEATHER.—Those who read our last hints will remember that a little over a fortnight ago we started for a holiday trip to the north, under the most depressing weather conditions imaginable; the outlook being in no sense cheering, while for the farmer it was dismal in the extreme, and for the bee-keeper almost as bad. We made the return journey on the 12th inst., with the thermometer at somewhere about eighty degrees in the shade, after having enjoyed nearly a week of glorious summer, bright enough and warm enough to have satisfied the most exacting, even of bee-keepers, and to have turned the very moderate season of 1891 into a first-rate one if it had but come at the proper time. Moreover, it would appear as if we are now in for our share of the 'heat wave,' and may look for a continuance of warm weather for some time to come. Verily, the bee-keeper has much to try his temper in such times; summer coming only when summer flowers are dead and gone; glorious weather for bees to work in, and no forage for them; and thus all his chance of success is spoiled in the most tantalising way. We might descant on the advantages a fine autumn affords for getting bees into condition for wintering well; how it conduces to late breeding, and so fills hives with just the robust population which come out strong in spring, and all the rest of it. But all the same, the fact remains that bee-men in the north, with whom we have been in touch for the past few days, have had a very disappointing time this year, and the disappointment is accenuated when the fine weather comes too late to be of any service.

Of course, there is another side to the picture which must not be lost sight of, and we are glad to remember that bee-keepers

whose stocks are safely set down amidst the bloom of the purple heather will be rejoicing at the unexpected change during the last few days. A cold, wet August has been succeeded by a month of September, which bids fair to redeem the character of the year so far as being remembered only as the 'summerless summer,' for we suddenly find ourselves in the midst of as glorious an autumn as could be wished for, and moor-men are, no doubt, reaping the reward of the patient perseverance with which they have kept on hoping for a favourable change, and preparing for it if it should come. It requires no little amount of enthusiasm to induce a man to add still further to his risks by incurring trouble and expense in moving bees to the heather in the face of all the discouragements bee-men have this year had to undergo. The present hopeful prospect is therefore all the more gratifying as promising a well-earned reward for the manful perseverance our Northern readers have displayed in hoping almost against hope, and refusing to believe the weather was to continue irretrievably bad. September is the best month of the year for heather honey if warm days are associated with warm nights; when frosty nights are the rule, of course, a comparatively small amount of nectar is secreted, and the income is lessened accordingly. So far, however, the weather conditions are most favourable, and we look for a good heather harvest accordingly.

AUTUMN FEEDING.—While the weather continues so warm and summer-like some extra care will be needed in feeding up stocks for winter. Bees are actively on the wing, seeking employment and finding none, for in few places will any honey be gathered now, consequently they are very ready to appropriate food being fed to their neighbours. A close look-out should therefore be kept that no headway is made in the robbing propensity which is likely to be developed at such a time. Once begun, it is not easy to stop or control, but, if taken

in time, there is seldom much difficulty in checking it. Giving food in the evening, seeing that all feeders are protected from the outside, keeping entrances contracted, and using carbolic acid freely about doorways in extreme cases, together with a general watchfulness over the bees' movements, are the best preventives.

PREPARING BEE-FOOD.—After the experiences of last winter, and the disasters which followed in the spring of this year, little should be needed in the way of cautioning readers against giving badly prepared food, or using bad materials in its preparation. With the experiences of last year to guide them, one would have thought that bee-keepers had acquired sufficient insight to enable them to distinguish between sugars fit for bee-food and those totally unsuited for the purpose; and yet we have, within the last few days, had samples of raw sugar sent, almost black in colour and as full of treacle as it wold could be, with the inquiry, 'Is it suitable for syrup-making?' About nine out of every ten samples of white crystallised sugar sent are either wholly beet sugar or largely mixed with it, and, as such, they are bad for bees. Some samples received are pure cane, but unrefined, or moist, raw sugars. These, though they may do for spring or summer feeding, are quite unsuitable for autumn feeding. In all cases pure cane sugar should be used, and a reliable tradesman may be trusted to supply this, if he will but take the necessary amount of trouble, seeing that several 'makes' are to be had which can be relied on as pure. The uncertainty in getting the right article arises from the fact that cane sugars are not, and never can be, sold so cheaply as beet sugars; yet they have to compete with each other in the open market, and, in consequence, the grocer naturally prefers to sell what yields him most profit; besides, he may well be pardoned for failing to take 'bee-feeding' into account in his business dealings. Householders generally give little thought to the quality of the sugar used in ordinary course, provided it has an attractive appearance—which all beet sugars have—on the table, and the question has only just arisen as to the preference which pure cane sugar ought to have over that from beet for household purposes. In response to letters received bearing on the point, we have, by request, extended the list of sugars obtainable through this office by adding four kinds suitable for household use.

LANCASHIRE AND CHESHIRE BEE-KEEPERS' ASSOCIATION.

The Lancashire and Cheshire Bee-keepers' Association has the good fortune to hold its annual bee and honey show in connexion with that of the Wirral and Birkenhead Agricultural Society, which latter occupies a position quite exceptional, in that its annual exhibition is not movable as so many are, but is held each year on ground in the occupation of the Society. All the shedding and other offices are therefore more or less permanent wooden erections, which, excepting the canvas roofs, stand from year to year. This arrangement so familiarises visitors with the various departments of the show, whether machinery, horses, cattle, dogs, poultry, horticulture, or bees and honey, that no time is lost in searching for what is most interesting, and the result is very satisfactory all round.

The exhibition took place on September 2nd and 3rd. Notwithstanding the fickle character of the weather of late, and the depressing influence of a perfect storm of wind and rain the day before the show opened, there was very little to complain of on the first day, while the second was beautifully fine and warm until, luckily for the society, the whole gate-money had been secured; some heavy showers afterwards much marred the enjoyment of the crowds of visitors. The sum taken at the turnstiles exceeded by seventy pounds that of last year, though the latter was larger than any previous record since the institution of the society, forty-nine years ago.

The bee and honey department presented a very fine display indeed, considering how moderate a season it has been in the North, and we were pleased to see local bee-keepers coming well to the fore in the various open classes. Only two collections of appliances were staged in Class A, but both were well up to date, few really good necessaries for work in the apiary being missing. The first-prize exhibit contained over a hundred distinct articles, against about half that number in the second-prize one.

Class B. *Best and most complete cottager's hive.*—Though not a large entry, it brought out a few very good and serviceable hives, the same exhibitor taking first and second prize. We have not yet seen a more useful and complete hive at the price (10s. 6d.) than the premier exhibit in this class. Adaptable for sections, for shallow frames, and for carrying to the moors, it is, to our mind, a model 'cheap hive for cottager's use.' The second-prize hive was also a good one.

Class C. *Best and most complete hive.*—Here, again, the competition was limited, only five exhibits being staged in the class. Messrs. Redshaw and Meadows, who took first and second prizes respectively, both staged good hives with outer cases, as did Mr. Harbordt, the latter being highly commended for a hive built on the new idea of a dual dovetail joint, put together without nails. It is not at all unlikely that this idea, so far only shown in the form of hand-

made hives, when carried out with the help of machinery will make some stir in the hive-making trade, as it is capable of being developed to a considerable extent. The exhibitor of the hive priced at 11. 15s. would do well to relegate so well worn and effete a veteran to the limbo of past things, which it certainly belongs to, as it can have no possible chance in competition with hives of modern type.

The honey classes were far better filled than we had expected them to be, and the quality of the honey staged maintained the good reputation the Lancashire and Cheshire Association has earned, especially for high-class extracted honey.

Class D. *Best exhibition of honey* (not less than 1 cwt.) Four entries.—The first prize in this class went to Leicestershire for a good miscellaneous collection of comb and extracted honey nicely displayed. The second-prize collection consisted entirely of extracted clover honey very even in colour and consistency, but no attempt was made to display the exhibit to the best (or, indeed, to any) advantage. In the third prize lot the sections were not very attractive, nor was the extracted honey so good as in the others.

Class E. *Best 12 to 20 pounds comb honey in sections.* Eight entries.—This was for the season a decidedly good class, all four prizes going to sections which, we fancy, have done duty at other shows this season; whether this was so or not, they well merited their respective awards, and were a very fair lot.

Class F. *Best 12 to 20 pounds extracted honey.* Twenty-one entries.—No class in the bee department was so strongly represented as this, nor was there anything like so severe a competition as here. The four prizes went to samples of white clover honey, three of the winners hailing from Cheshire and one from Lancashire. Thus, it would appear that Lancashire and Cheshire bee-keepers have nothing to fear in an open class with exhibitors from north and south. The first and second prize samples were very choice indeed.

Class G. *Best twelve to twenty pounds comb honey in sections* (members only).—If evidence were wanted of the shyness with which Lancashire and Cheshire bee-keepers regard working for section honey, surely it was seen here, when only two exhibitors competed for three prizes.

Class H. *Best twelve to twenty pounds extracted honey* (gathered in Lancashire or Cheshire). Thirteen entries.—A sample of the same honey taking first in the open class was again placed first here, and the winner of the fourth prize in the same class was awarded second and third in this class.

Class I. *for the best twelve to twenty pounds heather honey in comb*, did not produce a single entry, a fact which portends more or less failure this year from that usually prolific source of supply in the north.

Class J. *Best exhibit of beeswax put up in small cakes for domestic use.* Three entries.—This was not a strong class, but we are glad to

see the enforcement of the rule for putting the exhibits up in useful form.

The final class, K, *for useful inventions*, only produced five entries, Mr. W. P. Meadows receiving first for a collection of novelties, including a folding tin section box with an improved fastening, his new frame with partly split top bar, and several other useful little things; and Mr. C. Redshaw second for a new section box with hanging frames.

Mr. H. H. Lindon manipulated in the tent; and Mr. J. Palmer on the first day, and Mr. P. Harbordt on the second, rendered valuable help in lecturing to large audiences.

Messrs. W. Broughton Carr and T. D. Schofield fulfilled the duties of judging, and the full list of awards is as follows:—

Class A.—1st prize, W. P. Meadows, Syston, Leicestershire; 2nd, P. Harbordt, Great Charlotte Street, Liverpool.

Class B.—1st and 2nd, Charles Redshaw, South Wigston, near Leicester.

Class C.—1st, C. Redshaw; 2nd, W. P. Meadows.

Class D.—1st, W. P. Meadows; 2nd, T. Greenhalgh, Newton-le-Willows; 3rd, W. Corkhill, Edge Hill, Liverpool.

Class E.—1st, W. P. Meadows; 2nd, J. Palmer, Ludlow, Salop; 3rd, T. R. Horton, Havely Towner, Much Wenlock; 4th, G. W. Carr, Alfred Terrace, Fleetwood.

Class F.—1st, W. E. Little, Eastgate Row, Chester; 2nd, Geo. Robb, Manor House, Barnston; 3rd, H. Bradbury, Moberley, Knutsford, Cheshire; 4th, G. W. Carr.

Class G.—1st, G. W. Carr, 2nd, J. Wynne, Waverton, Chester.

Class H.—1st, W. Little; 2nd, G. W. Carr; 3rd, G. W. Carr.

Class I.—No entry.

Class J.—1st, Mrs. Harry Wood, Paradise, Lichfield; 2nd, John Outram, Kingsley, Frodsham.

Class K.—1st, W. P. Meadows; 2nd, C. Redshaw.

CASTLE DOUGLAS SHOW.

The annual honey show was held on September 3rd, in connexion with the flower, fruit, and dairy produce show. There was a splendid show of honey, which excited a great deal of interest. Following the custom of former years, this department was 'open to the world,' and ninety-two competitors came forward in the different classes. Regarding the principal class, that for three one-pound jars of run or extracted honey, some exceedingly good samples were shown, which in any season would be hard to beat. The unfavourable season had, however, made its mark, as a few bad samples were shown. The first and second samples were so equal in many respects that the judges decided to divide the prizes. Mr. J. D. McNally's exhibit was clearer than the other, but the latter had a better flavour. In the class for six one-pound sections of honey-comb, the exhibits on the whole were quite

equal to any seen at this show in previous years. The first-prize honey just held its place in point of flavour with the second prize, but in point of work the first was better filled. In the classes for dropped heather honey and dropped honey the samples brought forward were only of moderate quality. In the class for three one-pound jars of run or extracted honey, the first and second honours were divided between Mr. McNally, co. Down, Ireland, and Mr. W. Maskell, Surrey, the third prize going to Mr. W. Scott, Annan, the numerous competitors from Galloway failing to secure any honours. Although apparently the first and second were equal in this class, and the money prize was divided, the judge awarded the silver medal to Mr. J. D. McNally for colour, so as a matter of fact he carries off the highest honour, Mr. Maskell being awarded a bronze medal. The judge placed Mr. Sydney Roebuck, Troqueur Cottages, first for honey design.

Mr. J. H. Howard acted as judge, and his awards were as follows:—

Run or extracted honey, other than heather.—J. D. McNally, co. Down, Ireland, and W. Maskell, Surrey (equal); 3rd, W. Scott, Annan.

One-pound sections of honey comb.—1st, J. Learmont, Balmaghie; 2nd, W. Blackwood, Castle Douglas.

Honey design.—1st, S. Roebuck, Dumfries; 2nd, W. Jardine, Dumfries, and J. C. Graham (equal).

Super under twenty pounds.—1st, W. Hogg, Castle Douglas; 2nd, W. Brown, Chapelton, Rerrick.

Scotch pint dropped heather honey.—1st, J. Thomson, Dalbeattie; 2nd, W. Rae, Dalbeattie.

Two-pound clear glass jars dropped honey.—1st, J. C. Graham; 2nd, W. Brown.

One-pound clear glass jars dropped honey.—1st, W. Blackwood; 2nd, J. Thomson.

and his awards gave general satisfaction. Mr. Jno. Palmer, of Ludlow, carried off the prizes and bronze medal for comb honey, while Mr. Carver, of Wellington, succeeded in obtaining the members' and open prizes, with silver medal for run honey. Among the cottagers, Mr. R. Grainger and Mr. J. Shuker, both of Allscott, were most successful in the honey classes, with very creditable exhibits; while Messrs. Lloyd and Clarke, of Overley, were very busy among the sundries. At one p.m. the prizes were distributed by the Hon. Mrs. Robert Herbert, the President of the Bee Club. A hearty vote of thanks was accorded to the President and Miss M. E. Eyton, to whom the existence and success of this village Club are so largely due. We think the exhibition of 1891 may fairly claim to be the most successful of any yet held. Thanks are due to the Wellington Horticultural Society for the admirable arrangements made for the bee-show.

LIST OF AWARDS.

Club Members.

Class 1. Best six 1-lb. sections. 1st prize, J. Palmer (bronze medal); 2nd, R. Grainger; 3rd, J. Shuker.

Class 2. Best six 1-lb. bottles.—1st, J. Carver (silver medal); 2nd, H. Shuker; 3rd, J. Shuker; highly commended, Hall Fail.

Class 3. Best 1-lb. section.—1st, Mr. Palmer; 2nd, Mr. Grainger; 3rd, J. Shuker.

Class 4. Best 1-lb. bottle.—1st, Mr. Carver; 2nd, Mr. Fail; 3rd, H. Shuker; highly commended, J. Shuker; commended, Mr. Jervis.

Class 5. For best super of any description.—No entries.

Cottage Members only.

Class 6. Best six 1-lb. sections.—1st, J. Shuker; 2nd, Mr. Grainger; 3rd, Mr. Clarke.

Class 7. Best six 1-lb. bottles.—1st, Mr. Grainger; 2nd, J. Shuker; 3rd, Mr. Clarke.

Class 8. Best exhibit of honey (half run and half comb, not less than 24 lbs. in all).—1st, Mr. Grainger; 2nd, J. Shuker.

Class 9. Best and most complete hive, made by exhibitor.—No entries.

Open Classes.

Class 10. Best twenty-four 1-lb. sections.—1st, Mr. Palmer; 2nd, Mr. Cartwright.

Class 11. Best twenty-four 1-lb. bottles.—1st, Mr. Carver; equal 2nds, Mr. Fail and Mr. Horton; highly commended, Messrs. Palmer, Cartwright, Jervis, and Clarke; commended, Mr. Beale.

Class 12. Best twelve 1-lb. sections.—1st, Mr. Palmer; 2nd, Mr. Cartwright; highly commended, Messrs. Hamer and Jervis; commended, Mr. Whittingham.

Class 13. Best twelve 1-lb. bottles.—1st, Mr. Carver; 2nd, Mr. Cartwright; highly commended, Mr. Jervis; commended, Mrs. Austin, Mrs. Evans, and J. Shuker.

Class 14. Best and most complete hive for general use.—1st, Mr. Carver; 2nd, Mr. Palmer.

Class 15. Best collection of apianian appliances.—1st, Mr. Whittingham.

THE WROCKWARDINE BEE CLUB.

The sixth annual exhibition of this Club was held in connexion with the Wellington Horticultural Society in the beautiful grounds of Apley Castle, Wellington, kindly lent for the occasion by Sir T. C. Meyricke, Bart., the President of the Society. This is the first time the show of the Club has been held away from Wrockwardine, and we congratulate its members upon their fine display. For so small a Society, their schedule was a comprehensive one, and the classes all well filled with few exceptions, and many Bee Associations with more ambitious aims than this village Club have failed to make such an exhibition as they displayed. The total number of entries was 105, and upwards of six hundredweight of fine honey was staged, adding greatly to the splendid horticultural exhibits shown in a tent adjoining. Competition was keen, and some of the classes were very difficult to judge, notably Class 11, where, out of nine exhibits staged, no less than eight received mention. The duties of judge were efficiently performed by Mr. Sambels,

Class 16. Best exhibition of bees in observation hive.—1st, Mrs. Austin; 2nd, Mr. Hamer.

Class 17. Best collection of garden bee-flowers.—1st, Mr. Lloyd; 2nd, Miss M. Beale.

Class 18. Best soft candy for feeding bees.—1st, Mr. Lloyd; 2nd, Mr. Clarke.

Class 19. Best 1-lb. sample of beeswax.—1st, Miss Evans; 2nd, Mrs. Evans; 3rd, Mrs. Beale.

Class 20. Best honey beverage (non-intoxicating).—1st, Mr. Clark; equal 2nd, Mrs. Beale and Mr. Lloyd.

Class 21. Best honey vinegar.—No entries.

Cottagers only.

Class 22. Best 2-lb. cake made with honey.—1st, Mrs. Lloyd; Mrs. J. Shuker.

Class 23. Best pot of preserve made with honey.—1st, Mrs. J. Shuker; 2nd, Mrs. Lloyd.

Class 24. Best bunch of bee-flowers.—1st, Mr. Clark; 2nd, Mr. Lloyd.

Cottage Children under Fifteen Years.

Class 25. Best bunch of wild bee-flowers.—1st, Vincent Bremmell; 2nd, Lucy Lloyd; 3rd, George Lloyd.

Class 26. Best bunch of bee-flowers.—1st, Emily Lloyd.

JEDBURGH AND DISTRICT B.K.A.

A special general meeting of this Association was held in Jedburgh on Tuesday, September 8th, to consider the advisability of abandoning the proposed exhibition of honey, &c., for this year. The season in this district has been altogether unfavourable, and the crop secured from clover is not only small, but inferior, while the prospect of heather honey is very poor indeed. The Secretary read a number of letters from district bee-keepers, and almost all expressed the opinion that it would be impossible to hold a satisfactory show this year. It was then unanimously resolved not to hold an exhibition this season.

Correspondence.

The Editors do not hold themselves responsible for the opinions expressed by correspondents. No notice will be taken of anonymous communications, and correspondents are requested to write on one side of the paper only, and give their real names and addresses, not necessarily for publication, but as a guarantee of good faith. Illustrations should be drawn on separate pieces of paper.

Communications relating to the literary department, reports of Associations, Shows, Meetings, Echoes, Queries, Books for Review, &c., must be addressed only to 'The Editors of the "British Bee Journal," 17 King William Street, Strand, London, W.C.' All business communications relating to Advertisements, &c., must be addressed to Mr. J. HUCKLE, Kings Langley, Herts (see 1st page of Advertisements.)

WHY DO WE SMOKE?

[772.] I do not, of course, inquire why one smokes tobacco—though that would be quite a pertinent question, bee-keeping apart—but why bee-keepers use smoke in the subjugation of bees? Even this is scarcely a correct way of putting

the query, seeing that the carbolic cloth and the fumes of the acid are equally efficacious as quellers of bee-acerbity. The commonly received opinion about the charming of bees by more or less dense clouds of smoke is, I believe, that by a fine use of its reasoning powers the bee deems the house on fire, and rushes to the honey-cell, with a view of saving as much as possible of the hoard of honey from destruction. Filling her honey-sac to repletion, the worker—like the proverbial Briton after a good meal—is in a kindly mood, or else, finding it somewhat painful to bend the abdomen sufficiently, is disinclined to use the sting.

It only needs a moment's reflection to show us that the bee never has had any experience of fire, and therefore cannot reason as to cause and effect, even supposing we granted it the possession of this faculty. The only possibility of the bee having any understanding on the subject of fire in the dwelling would be an hereditary impulse, handed down from ancestors who had had the home burnt in forest fires. Even this idea is only tenable for a moment, for we know such ancestral survivors from the fumes and flames must have rushed *en masse* from their tree home and squatted elsewhere. Hereditary dread of fire, gained by the experience of suffering ancestors, would be transmitted to posterity, with the result that on its first approach or earliest symptom the bees would rush forth, even if without stores. No such course is followed by the honey-bee on its first acquaintance with smoke; but precisely the opposite plan is adopted to the one we should most naturally expect. It hurries away from the cloud, buries its head in a cell, or pierces the honey capping, fills its pouch with stores, and remains a sullen, quiet inmate of the hive, from the combs of which it is not desirous of moving, either to preserve its own life, that of the queen-mother, nor those of the brood; not even does it attempt to save its store of honey, as we have been taught is the case.

If we use some kinds of smoke we make the bees angry; the fumes of paraffin oil, or oil of thyme, and many other things even agreeable to us, incense the bees against any interference, and the use of the smoker does not produce the desired effect on bees which have no honey or syrup on which to gorge. The smoke of tobacco, or burning fustian or corduroy, as well as the *unseen* fumes of carbolic and some other acids, seems to make the bees shudder with *horror*—the noise they make as they retreat is strongly indicative of fear; but the effect of carbolic acid appears to pass away sooner than from some other of the substances used in bringing them into subjection. A kick or two on the hive side seems to hurry on the gorging, and forces one to the conclusion that it is extreme terror we really produce when we smoke our bees. We must take care we use not in the smoker a second time any kind of material the use of which has been followed by anger. Many a bee-keeper has condemned his bees as being vicious, and not amenable to the smoker, when

he has only himself to blame for using *wrong material*.

We terrorise the bee as we terrorise wild, unreasoning animals into subjection; its only escape and solace is in the depth of the cell, the darkness of other parts of the hive—the only antidote and soother to the taste and smell of the fumes being found in the taste and smell of the honey on which it fills. I therefore submit that we do not smoke to give the bee the idea of probable destruction by fire, and it does not wisely rush to save its store; we do not stupefy it by the fumes, nor do we puzzle or terrify it by *sight* of smoke; we do not enclose it with merely *objectionable* smells. We find that which *soonest* produces a *lasting* effect; and this subject—the material best suitable for use in smokers—would be one, perhaps, provocative of instructive and interesting debate in your columns or at a *conversazione*.—R. A. H. GRIMSHAW.

NOTES FROM NORTH KENT.

[773.] The honey season of 1891 is over, and supers are all removed; extracting is finished and the frames of comb are being licked out preparatory to being stored away for the winter. All supers and empty combs are exposed to sulphur fumes as a precaution against foul brood and wax-moth.

The weather has lately been very unfavourable—a succession of rough winds and rain, with only an occasional fine day. The progress in the harvest-field has been sadly interfered with, and hundreds of bushels of fruit have been blown from the trees. Bees have been doing very little, though there is plenty of runner-bean blossom, and where the brood chamber has contained but little honey, feeding has been necessary to prevent the brood being destroyed. The yield of surplus has been about equal to that of 1890.

Super-clearers.—The *cone* has proved disappointing, though tried recently on a fine day; after being on all day many bees had to be shaken off the combs and several were seen to re-enter the combs. Moreover, the excitement was considerable, many bees clustering on the front of the hive. As a precaution against robbing, entrances had previously been lessened.

The *board clearer* was quite a success with all the hives on which it was tried. It was easily slipped under the super without any disturbance, the time taken being only a minute. In about three hours not more than a dozen bees were left in each super, and there had been no excitement—quite a contrast to the hives having the cone, and on the same day, too. This clearer is very easily made in about a quarter of an hour and only costs twopence.

Foul brood is still with us. Those stocks which were badly affected last year are now almost free, and work and breed—aye, and swarm too; so some of the remedies have been useful. Other stocks, apparently free before, have now

developed the disease rather badly. Burning the worst combs and giving foundation instead lessens the mischief for a time, at any rate. Most bee-keepers here are using naphthaline and Naphthol Beta.

Granulated honey does not figure at our shows so often as it should do. Granulation is presumptive evidence of purity, and honey will granulate sooner or later, so why not have a class for it at every show? As one purpose of a show is to show what pure honey is like, why not present it in both its forms?

Since writing the above the weather has improved, and to-day (September 7th) hop-picking commenced here. While walking about the hop garden I noticed a number of bees busy on the hops. Each bee thrust its head and tongue within the membranous scales of the hop. I timed several and found they continued sucking with the tongue for about fifteen seconds to each scale. Inside each scale is to be found a seed, and many yellow oil globules of a somewhat sticky nature. Can the bees be gathering the oil, and would it serve for food? No nectar appears to be secreted, nor would any be needed, as the hop is fertilised by the wind, and pollination is long past. Has any other reader of the *Journal* observed bees visiting hops? I never remember seeing it in previous years.—T. BADCOCK, *Southfleet, Kent*.

DOME-SHAPE VERSUS FLAT TOP.

[774.] In your reply to 404 (p. 385) you say you 'never found bees wintered any better in dome-shaped than in flat-topped skeps,' &c.

I can hardly agree with you on this point, although I admit dome-shaped hives would be quite impracticable; still, *prima facie*, the latter shape appears to me to be just the very thing to suit the bees. I cannot speak from experience of my own bees, as I do not keep them in skeps, but skeppists about here reject the flat top, and go back to the dome-shape; but this would, no doubt, in a great measure be due to ancient custom, and also to the fact that the latter has a more rustic appearance. This leads me on to what I consider a case of—

Wonderful Prolificess in Bees.—A farmer in this neighbourhood, who is a dome-shaped skeppist, and whom I cannot by any means induce to try the modern plan of bee-keeping, during the winter of 1889-90 had his stocks reduced from thirty-six to one only (he started some years previously with three stocks only). This one stock gave him five or six swarms, I forget which at the moment. During the past winter some of these died; one of them he generously gave away—which, by-the-bye, swarmed on Derby Day—and of the remaining two, one died, leaving him again with only one stock; this stock has this season produced him eight swarms, and he has now nine stocks.

As some of your readers may like to know what kind of bees these are, I can say that they were originally black English bees—would that

such bees were obtainable now, instead of the wretched, spiteful, honeyless, hybrid bee we now have to put up with!—but, although no foreign blood has been introduced, and there are no other bees nearer to them than one mile as the crow flies, the queens reared from the sister stock (the one referred to as given away), from which I obtained one and have reared others, are many of them of a brown-leathery colour, similar to Ligurians, and producing many bees with three yellow bands. They do not appear very spiteful, but are quite sufficiently so. What their honey-gathering qualities are I cannot as yet say.

I wish to add that I thoroughly endorse Mr. Winterton's remarks (758) as regards wearing bee-veils.—A. T. WILMOT, *St. Albans*.

BOOMING PUNIC (?) BEES.

[775.] There are two men over here, by the name of Pratt and Alley, who are trying to boom the Punic bees. They claim they get them from England, and say they are imported there from Central Africa, and that they will gather more honey than any other race of bees, and cannot be induced to sting. I do not believe all of these statements. Henry Alley is the man that crossed Carniolan queens with Italian drones, then called them pure Carniolans, and tried to *humbag* the bee-keepers with them. Please give me a full description of them; also will you please send me a copy of the *B.B.J.*, and oblige—L. A. LOWMASTER, *Ohio*.

P.S.—Are they from Tunis, Africa?

[We are acquainted with the bees of Tunis, but do not know of the existence of such a race as the so-called Punic bees in that country. For a description of the bees of Tunis, Algiers, and Morocco, see our remarks on pages 381 and 408 of *B.J.*, and if our correspondent wishes we can send him name and address of parties in Algeria to whom he could apply for the bees.—EDS.]

INCONSISTENT SHOWING.

[776.] I am pleased to find that 'B.' (769, p. 407) has identified himself, and volunteered an explanation of the inconsistent showing referred to in Query 402. The explanation is satisfactory as far as it goes. It is sufficient to account for a change in the quality of the honey. The explanation, however, suggests the need of a supplemental one. The questions arise, 'Where is this out-apiary?' and 'How long has it been in "B.'s" possession?' If it was in his possession prior to the show at C., can 'B.' supply the names of bee-keepers acquainted with the fact at that time? I am led to ask these questions because, although I had some conversation with 'B.' at C., which would naturally have brought this out-apiary under review, there was not, so far as I can remember, any reference whatever made to it. Another question also thrusts itself forward—'B.' as a bee-keeper of great experience, knew of the comparative resources of the different districts in which the two apiaries were situated, and could tell without waiting until

extracting was done which would yield the best honey; consequently one is curious to know why he left his best honey out of the county show. It would savour of insult to hint that he did not know this. I believe it is best not to mince matters. Doubts are entertained as to the *bonâ fides* of certain exhibits at C. and D., and, principally in the interests of the exhibitors concerned, and, perhaps, in that of the County Association as well, a thorough clearing up of the matter is desirable.—J. MORGAN, *September 12th, 1891*.

P.S.—That bee-keepers in the county may not be in the dark as to the matter in discussion, it would be as well to substitute names for letters. For A., B., C., and D., read Mr. Sims, Mr. Gay, Merthyr, and Cardiff.

METHEGLIN.

[777.] Your correspondent, No. 760 (p. 394), asks how to make the above:—Save all scraps from the extractor, and spare pieces. At the end of season collect all broken combs which are clean and free from mould. Put them into a copper with sufficient water to cover them, boil till combs are dissolved. Get a large shallow pan and strainer with a cloth in, bail out into the cloth and wring the liquor well out from cloth, and empty wax back into the copper; repeat this until all is used from the copper. Let this stand all night; when cold take off the wax. Now put all the liquor back into the copper again, and boil for one hour. Add some ginger and a little nutmeg according to the quantity of liquor made. Put in about half or three-quarters of a pint of 'yeast'; stir up well; when cold put in small cask or stone bottles. Save sufficient liquor to fill up the cask, as it wastes in fermenting. When fermentation is over bung up; it will then keep for years.—WILLIAM PREECE, *Titchhurst, Sussex*.

FOUL BROOD AND NAPHTHALINE.

[778.] Bees in this neighbourhood are nearly exterminated through foul brood. I have lost some fifteen lots by it, having tried all remedies I could hear of or read about without any good. Having been left with one this spring, and that the worst last year, I commenced using naphthaline, without doing anything to hive or frames, and although it has not cured, it has prevented it spreading; so that they have so increased as to give me fifty pounds of run honey surplus, leaving plenty to winter on.—W. H. ADAMS.

A NEW WAX-EXTRACTOR.

[779.] I send you the accompanying description of a new wax-extractor which I have recently invented, &c., which I call the 'English' Wax-Extractor. It consists of an upright tin vessel, holding about six gallons, into which are placed two removable bowl-shaped bottomless tins, supported one over the other by three

short wire uprights, the upper one having a groove round its bottom for the purpose of tying on a piece of straining material, such as cheesecloth, &c. In addition to extracting wax the extractor can be used for making syrup, or for holding either honey or syrup, or for many other household purposes.

To Use the Extractor.—Place the old wax comb, &c., in the upper bowl-shaped tin, putting some water in the outer tin vessel, and placing it upon a fire or stove; the steam rising will cause the wax to drop through the straining material on to the water in the bowl-shaped tin below, which prevents it from adhering to the walls of the outer tin vessel. If highly refined wax is required, remove the straining material, and put a piece of flannel or other suitable material in its place, and put it back in the tin vessel, but this time upside down, previously placing the wax cakes below the strainer; now fill with water nearly up to the top of the upper inverted bowl and boil as before, allowing it to cool afterwards.—A. T. WILMOT, *St Albans.*

Queries and Replies.

[424.] *Single Egg in Comb.*—On Saturday, July 4th, I got a driven lot of bees given to me by a bee-keeper in this neighbourhood, who was giving up the pastime for the present. He was not quite sure whether there was a queen with them or not. However, we determined to put them in a box with combs, and, if there was no queen, to get one for them. We commenced operations about eight o'clock p.m. by emptying the bees out of the skep—in which they had only been for three days—into a cloth spread from the alighting-board, intending to watch for the queen. After we had thrown them out we found that they had built a couple of pieces of comb in skep, and almost every cell had an egg in it. This satisfied us that there was a queen; we drove them into the box, and did not then examine them minutely. On the following Thursday, the 9th, we examined all our friends, and could not find either queen or eggs; we left them, and examined them again on Saturday, the 11th, and then found, hanging from the bottom of one of the combs, a beautiful queen-cell, but not another egg was in the whole lot. We thought that this must surely be a blind cell, and did not examine them again until the 18th, and the cell was then torn open, and we found a very small queen, but no eggs. We left them for another week, and examined them and found a lot of eggs; and since then the queen has been laying constantly. Could you give me any idea of where the one egg came from that raised this queen? If the old queen had got into the box, I think she would surely have laid more than one egg. I have told this to several bee-keepers, and none of them have been able to give any explanation. Allow me to thank you and Mr. 'Useful Hints' for the great amount of instruction I have received since I became a subscriber

to the *B. J.* and *Record*. I do not now know how I would get on without them.—W. J. D.

REPLY.—Most likely the queen was damaged during the transfer, and in her efforts to lay succeeded only in depositing one egg, and was not able to lay any more. She would, in this case, be superseded by the workers, and a queen-cell reared over the one egg, which would have special attention. The queen laying now is probably the one hatched in the queen-cell, as there was plenty of time for her to become fertilised.

[425.] *Utilising Driven Bees.*—Will you kindly inform me as to the best way to treat some colonies of condemned bees of which I have an offer if I undertake to drive them? I have read up Cowan's *Manual* and the *Bee-keeper's Guide*, but find the above subject scarcely alluded to. There is no mention of taking out the queen or queens. I suppose the bees won't fight, having no stores to defend or 'bungle;' but I think it would be advisable to dredge them with flour to quieten them, so as to be morally certain of their good behaviour. I have two bar-frame hives full of combs uncontaminated with foul brood, of which I am thankful to say I have always kept clear in my apiary, and I should like your advice as to whether you would prefer to put the bees in these hives or give full sheets of foundation. A reply at some length, going into detail, will, I am sure, be very acceptable at this season to many an amateur besides myself. Just a word as to the use of the carbolic cloth. I used to get my hands messy with it. Fancy being told to wring it out! which I did with my bare hands! My plan, which I have lately adopted, is to tack on a piece of cotton or linen cloth to a light deal frame the same size as the top of a bar-frame hive. Having placed the carbolic solution in a wide-necked bottle, I brush the solution well into this cloth, thoroughly saturating every part, and thus entirely avoid the least suspicion of the carbolic acid coming in contact with the skin. The bees are just now having a glorious time on the heather.—W. BARRACLOUGH, *Swainby, September 12th.*

REPLY.—The instructions for the actual 'driving' of bees in Cowan's *Guide-book* are full and complete; there is no need, therefore, to repeat them to you. For dealing with the bees after driving, procure as many small boxes (say washing-powder boxes, which hold a fair-sized swarm) as there are stocks to be driven. On three sides of these cut a hole about $4\frac{1}{2}$ inches by $2\frac{1}{2}$ inches, cover these holes with perforated zinc on the insides, and let the lid be loose. After having driven the bees into an empty skep, fix one of the boxes, with its front edge raised a couple of inches, on a sheet or a newspaper spread on the ground. Throw the driven bees on to the cloth, and allow them to run into the box; when all are in set the box on the stand occupied by the bees before being driven, and allow all stragglers to join them. Then lift the box and bees on to its lid and tie the latter firmly on. Treat all driven lots in-

this way. Tie the boxes three or four together for convenience of carrying, and when transferring the bees to the frame hives treat them exactly as when hiving a swarm. It is often advisable to join two or more driven lots together to make up a strong stock for wintering. This is done by throwing each lot out in front of the frame hive, and sprinkling a little flour over the bees as they are mingled together in a heap. They will then run in without fighting. Unless you specially desire to save a particular queen, take no trouble, but let them settle among themselves which is to reign as mistress of the new colony. Ready-built combs are far preferable to frames of foundation for driven bees. Feed up rapidly, and don't stint the quantity of food given too closely; better give too much than too little.

[426.] *Wintering in Skep.*—Early in August last I wished to transfer a strong stock of bees from a skep to a bar-frame hive; but, having no time for driving, and being anxious to prevent them swarming, I merely placed the skep upon the top of the frames, which were fitted with starters. Upon examination of the hive, after several weeks' absence, I find they have not worked down into the frame hive at all, and I should be glad to know whether it would be better to remove this for the winter, or would there be any objection to leaving it as it is?—A. G.

REPLY.—If the skep is overcrowded with bees let it remain where it is; otherwise, remove the frame hive, and put the skep in its place.

[427.] *Discontinued Breeding.*—In looking over ten stocks of bees yesterday, I found three without any brood in any stage whatever. Is it a usual thing, or is it a sign of a queenless hive? They have plenty of stores, about half of ten frames sealed over, and there are no drones in any of the hives.—T. D., *Wexford*.

REPLY.—Breeding should not have been discontinued so soon, and ought to have been kept up to at least the middle of September. Examine the hives to ascertain if queens are present, and if you do not find them, unite to others having queens.

[428.] *Driving Bees.*—I have three skeps of bees, which I intend to drive and put on frames. The skeps are about twenty feet from each other. 1. Are three lots too many for one hive? 2. If the three lots are driven, could they be placed anywhere in the same garden? I have several stocks in bar-frame hives, and should like to put them (the driven lots) near one of those hives. 3. If I am not asking too much, would you kindly tell me how to proceed? This is my second year of bee-keeping; and I find the *Journal* a very great help.—A MOORLAND SUBSCRIBER.

REPLY.—1. No, three lots of bees at this time of the year are not too many for one hive. 2. Bring the three skeps to the spot you wish the frame hive to occupy, moving them three feet a day, but not on days on which the bees do

not fly. When close together, drive them, and introduce them into the frame hive. 3. Full instructions for driving are given in every bee-book. Look in *Modern Bee-keeping* or *Bee-keepers' Guide-book*, and if you are in any difficulty, we shall be pleased to help you out of it.

[429.] *Autumn Feeding.*—My two stocks of bees were not fed during the wet month of August, owing to my absence from home; consequently, on my return last week (September 3rd), I found no brood, except about one dozen bees just issuing from the cells. The *British Bee-Keeper's Guide* pronounces this state of things as unsatisfactory. One hive has nine frames full of bees, the other eight; can I improve matters now by stimulating, or should I leave them alone? They have ample stores for wintering.—D. W. M., *Clevedon*.

REPLY.—The cessation of income, coupled with bad weather in August, has stopped breeding, no doubt. A little slow feeding during the present fine weather may induce the queens to make a fresh start, and in any case will do no harm.

[430.] *Contracting Hives.*—1. In hives with ten frames, where there are only enough bees to cover six or seven, what is the best thing to do with the other frames—leave them in the hive or take them out and extract the honey? 2. Would the honey extracted from these frames be fit for table use? The honey is sealed at top, but there is some unsealed below, with a little pollen in some of the combs.—GREENHORN, *Harrington, Cumberland*.

REPLY.—1. Contract the space by division-boards to the space the bees will occupy; if there is sufficient food in the remaining frames. 2. Yes.

Bee Shows to Come.

Sept. 19th.—Jedburgh and District B.K.A. This show will not be held. See notice on page 417.

October 13th to 16th.—British B.K.A., in connexion with the Dairy Show at the Royal Agricultural Hall, London. All open classes. Entries close September 14th. For schedules apply to Wm. C. Young, Sec., 191 Fleet Street, London.

CUBAN HONEY YIELDS.

From news which comes to us from Cuba it is a wonderful honey country. The flow begins in December and lasts until May, and does not entirely cease at any season of the year. The honey produced is mainly extracted, of good quality for southern honey, and sells at fifty to seventy cents per gallon in New York City. The yields reported are, some of them, very large, as much as 150 to 200 pounds per colony, from apiaries ranging from 460 to 500 colonies.—*Rural Homes*.

Echoes from the Hives.

Clevedon, September 10th.—Honey came in very fast from end of June to beginning of August. Since then weather has been cold and very wet. August rainfall exactly double usual average. Honey harvest very fair. Average per hive about thirty pounds. Super honey finer quality than usual, but rather pale. I have been a reader of your *Journal* for some time, and find I can never do without it, as it is a capital paper for reference.—E. COTTERELL.

Lauder, September 10th.—Heather honey is a failure here this season. It was conspicuous by its absence from the great fruit and flower show in Edinburgh yesterday.—J. T.

Blackrock, co. Cork, Sept. 11th.—I have done pretty well this year, having taken 258 sections from six stocks and a swarm of this year.—F. JELLICO.

Wallsend, September 11th.—I may say the heather in Northumberland is 'going' fast, and the honey harvest is a complete failure.—G. G. RICHARDSON.

Alderley Edge, Cheshire.—After visiting all the members in my district I can report that the season, though very short, has not been a bad one, and that all bee-keepers who have managed their bees well have taken a very fair quantity of surplus. One man near me has taken two hundredweight from six hives. The honey is also of nice quality.—T. D. SCHOFIELD.

FOREIGN NOTES.

ARE BEES NATIVES OF A WARM CLIMATE ?

One of the mistakes of modern bee-keepers is the saying that bees are natives of a warm climate. Who was the first one to say so, I do not know, but nearly every day we can hear or read this fable here in the United States, as well as in the old country, but I have never seen any proof for it. This question is important because a number of winter theories are based on this, so it will be of interest to look the matter over.

If we take into consideration the present geographical extension of the honey-bee (*Apis mellifica*), we see that this bee nowhere in a tropic climate is native; where we find it, we know it is imported by man. In tropic climates we find some other species of bees. This may prove very little, but it is striking if we see that in such countries the honey-bee now is not native at all.

We know that Germany was a cold and rough country before she got in communication with Greece and Roman civilisation. The oldest notice from Germany about bees we receive from Pythias, living at the time of Alexander the Great (about 330 B.C.).

He says that amber merchants found honey on the northern coast of Germany. Later, we read in Plinius (*Hist. Nat.*, ix. 18), that after the battle of Arballo, in North-western Germany

(about 12 B.C.), a bee-swarm alighted in the camp of the Romans. Herodotus (at 440 B.C.) says that north of the Danube river no invasion into that country was possible, on account of the great number of honey-bees. It may be said, nevertheless, that the bees may have emigrated there from a warmer climate. But we see that the honey-bees of that time must be especially fitted for this rough climate, if we take into consideration that the old Germans hardly knew anything of scientific wintering, of a pollen theory, or any other theory. I am sure those old forefathers of ours were bee-hunters, and understood not much more than to cut a bee-tree, to eat the honey, to make mead out of it, and were masters in drinking it.

But we can prove that the honey-bee was in this country many thousands of years before men were there. Near Peningen, a small village in Baden, Germany, is found a petrified honey-bee. The rock in which it was found belongs to the Miocene, the youngest part of the Tertiary formation. No trace of a human being is found before the Diluvian, so it is sure and sufficient proof that bees were natives of Germany long before man. This petrified bee was found about thirty years ago.

Besides this, we have some other proofs in the habits and anatomy of the bee that hardly any other animal is more specially fitted to stand a severe winter. While a single bee is hardly able to raise the temperature of its body about one degree over that of the surrounding air, we see that a colony of bees, by a temperature of 20° or 10° F. outside, can keep up 60° or 70° F. or more inside of the cluster. To make this possible, the main winter food (honey) is already prepared in summer-time; it is digested and stored for further use, so it can be assimilated at once and changed to heat. We do not know any other animal with a similar power. If we add to this that the honey is capped to keep out the moisture, that the surface of pollen likewise is polished to keep it for use in winter and early spring, we shall hardly find another animal which instinctively makes so much preparation for a long winter.

Further, the anatomy of the bee shows that this animal is especially created for a long winter. We know that bees are confined for five or six months (in Siberia even seven months) to the hive. This is possible only because the bees can accumulate their excrements for so long a time in the large intestine. Practice teaches that they can stand this long confinement as long as they remain healthy. All who have examined the alimentary canal of bees will never doubt that this part of the intestine is expressly fitted, created, or developed for this purpose.

If we, by our scientific and rational methods of bee-keeping, cannot winter our bees without more or less loss, it is a proof that our management or our theories are not correct. So much is sure: that many thousands of years, bees lived and prospered, wintered, swarmed, and gathered honey in a cold climate, and without any help (?) of a scientific bee-keeper.

Another proof that bees are natives of a climate with cold winters is the fact that a colony of bees breed in winter-time, and do this the more the colder the temperature. If a severe temperature in January and February causes a great consumption of honey, we shall find more capped healthy brood than later, after the bees have had a cleansing flight. Whoever examined a colony in such circumstances will never doubt this fact. An insect which in severe weather can breed and can nurse healthy young ones, and for this purpose can raise the temperature fifty or sixty degrees, will remain healthy, using no other food than that stored, disdaining even water, without discharging fæces, is surely created for a cold climate.

We again come to this conclusion if we observe the habits of a colony of bees. A single bee is a feeble thing, but a single bee does not winter. A single bee is, in fact, only a part of an organism, and the colony of bees is the animal proper. In this respect alone we could write many articles. If you want to know how insect colonies act which are created for a tropical climate, let me tell you how the so-called stingless bees do, the melliponæ or trichoptera, and you will find out the difference.—L. STACHELHAUSEN, *Selma, Texas.*

Notices to Correspondents and Inquirers.

BALLYNAHINCH.—The sample of honey sent is of good colour and quality, and will improve in brightness if kept for a short time in a warm place, to expel the enclosed air-bubbles. The flavour is excellent. We shall be pleased to have the account you propose to send.

SALOPIAN.—It is impossible to dissect bees that are dry and hard. The box came broken, and the two bees out of the paper they were sent in. They were both black queens, and one has evidently been balled, as she has her antennæ and legs bitten off. They have shrivelled from being dried up, and would have been much larger when alive.

A. W. EDWARDS.—The two samples of sugar are different, and if you can get a guarantee that they are pure cane you can try them, but we are doubtful about them being pure cane. If we had a larger quantity we could tell better. No. 7 is what you should use, and if you and other bee-keepers could club together to get a quantity it would be to your advantage to do so.

N. D. (Lincoln).—There is no necessity to use both. See *B. B. J.*, p. 401.

W. C. WARREN.—Alcohol is pure rectified spirits of wine, and is much stronger than the latter. Absolute alcohol is stronger still. Methylated spirit should not be used at all, as it is an impure spirit. The stronger the spirit the less you require to use to dissolve the Naphthol B. We supply one ounce Naphthol Beta for 1s., post free.

GISSON.—1, 2, and 3. The situation will do very well for the hives. 4. Worker-bees are dying naturally daily, so it is not unusual to find a few dead ones in front of a hive. If large numbers were dying off it would be abnormal, and we should suspect something wrong. 5. If the seven frames are sealed over on an average of two-thirds of each frame, they would have enough provision for winter if the hives were strong in bees.

BAR-FRAME (Sunderland).—*Bees Deserting Hive.*—The probability is the bees were queenless. If stocks are kept strong there need be no fear of wax-moth. The use of naphthaline is also good for the purpose.

W. BARR (Ewell).—Sugar sent appears to be what is called grocers' 'sweepings.' It is not loaf dust; we should not care to use it for bee-food, unless it is guaranteed as cane sugar, which we doubt its being.

F. JELLICO (co. Cork).—No doubt the peculiar flavour arises from the use of the carbolic acid.

STEAM FACTORY for Bee Appliances.

ORDERS addressed J. ROSS, Stranraer, Wigtownshire, N.B., will be attended to.

NAPHTHALINE AND NAPHTHOL BETA.

Both the above may now be had at the Office of 'THE BRITISH BEE JOURNAL' and 'BEE-KEEPERS' RECORD,'

17 KING WILLIAM STREET, STRAND, LONDON, W.C.

NAPHTHALINE in packets, 6d. post free.

Large packets, containing more than four times the quantity of the smaller ones, 1s. post free.

NAPHTHOL BETA, 1s. a packet, post free.

Instructions for use sent with each packet.

Special prices for quantities.

NOTICE.

NOW READY.

The 11th Edition of

THE BRITISH BEE-KEEPER'S GUIDE-BOOK,

By THOS. WM. COWAN, F.L.S., F.G.S., &c.

Revised and enlarged.

Almost entirely re-written. Much new matter and many fresh illustrations added.

Fcap. 8vo., price 1s. 6d.; or in cloth gilt, 2s. 6d.

Postage, 2d.

To be had of HOULSTON & SONS, Paternoster Sq.; all Hive Dealers, Secretaries of Bee-keepers' Associations, and of J. HUCKLE, *British Bee Journal* Office, Kings Langley, Herts.

Special Prepaid Advertisements.

Situations, Publications, Bee Plants, &c.—Two live words and under, Sixpence; for every additional Three words, One Penny.
Trade Advertisements not inserted under this head.

WANTED.—1-lb. Sections of Honeycomb, first quality. Prompt Cash. Packages sent. Well-filled Bell Glasses, Frames and Caps purchased. Address Mr. HURST, Bexhill, Sussex. 242

WALLFLOWERS will give splendid forage for Bees in Spring. Fifty plants, 1s., post free. Address NORMAN PARKIN, Blakenhall, Wolverhampton. K 83

HEALTHY DRIVEN BEES. 1s. 6d. per lb. With Queen, Box, and Packing free. Carriage not paid. Choice Natural-raised 1891 Queens, 2s. Safe arrival, and Carriage paid. Stamp for reply. Address HOLDER, Wimborne, Dorset. L 12

FOR SALE.—One Hundredweight of beautifully clear New Extracted Honey, in 1 lb. Crew-cap Bottles, ready labeled. Also several dozen first-class 1-lb. Sections. What offers? Address THOS. FORD, Warborough, near Wallingford, Berks. L 16

FOR SALE.—Five Strong Stocks of Bees in Bar-frame Hives, complete, 30s. each. Two Swarms in Skeps, 10s. each. Apply, Rev. E. DAVENPORT, Stourport. L 17

WANTED.—1 lb. Sections, well-filled and clean, and Extracted Honey. Address NYE & SONS, 1 Western Street, Brighton. L 23

WANTED.—Two 5 lb. lots of Driven Bees, healthy, Carniolans preferred, in Exchange for valuable small foreign Birds, kept in Aviary 12 months. Particulars from O. PUCK, 7 Orchard Street, Walthamstow. L 24

WILL be Sold by Auction, September 30th, at 11 a.m., unless disposed of by Private Contract, at Ferry Street Farm, Crayford, Kent. Sixteen excellent Stocks of Bees in mostly new Bar-framed Hives, with Abbott's Cylinder Extractor, and all Bee-farming Tackle. L 25

FOR SALE.—Several Strong Stocks in Frame Hives, fed up for winter. Price 20s. each. Address SHEP-PARD, Derby Road, Woodford, Essex. L 26

HALF-GALLON RAPID FEEDER.—Bees can empty twice daily, and cannot drown. Air-tight from outside; now extensively used; simplicity itself; best ever introduced. Price, 1s. 9d.; post free, 2s. Address WATSON, Warton, Carnforth, Lanes. L 27

FOR SALE.—Twelve Hives of Pure English Bees, 10s. each. Foul brood unknown. Removing. Address CREGOE, Tredeinick, Bodmin. L 28

FOR SALE.—Choice Young Queens. Black, fertile. By return post, 2s. each. Safe arrival guaranteed. Address A. J. CARTER, Newfields, Billingshurst, Sussex. L 29

FOR SALE.—Good Extracted Honey, in Neighbour's 1-lb. Honey Glasses, price 11s. per dozen; also a few splendid White Clover Sections, 5s. per half dozen. Address COOPERS BROS., Hadleigh, Suffolk. L 30

FOR SALE.—Having had considerable difficulty to obtain suitable Boxes for 1 lb. Sections, and bought larger quantities than required, I shall be pleased to sell at 4s. 6d. per gross, cash with order. Address MARTIN, 4 Woodland Place, Bath.

ENGLISH QUEENS, tested, 2s. 6d. each, post free. Address C. N. WHITS, Somersham, Hunts.

THE 'ENGLISH' HIVE.

Transferring Season now on.

THIS HIVE, it is the best in use, and once used will be always used. No more cutting quilts necessary, as the Bees can be fed from the side of the Hive. See description in B. B. J., August 6th, 1891, p. 351. Price for Floor-board, Body, and Zinc-covered Roof, 11/6 only. The English Wax Extractor, price 7/6.

For particulars apply to A. T. WILMOT, St. Albans. 3149

BALDWIN'S is the Oldest Establishment in the United Kingdom wholly devoted to Bees and manufacture of

Bee-keepers' supplies. His prices will compare most favourably with those of any other Maker, while for quality of material, suitability and workmanship, he has no rival.

'Why can he give better value for money than others?' Because he spends less in large 'puffing' advertisements, buys in the best markets for prompt cash, has no rent to pay, and personally conducts his own business.

For prices and full particulars of Goods see Baldwin's Bee-keepers' Instructor (and Illustrated Catalogue combined), which 'contains more practical and reliable hints than all the large, expensive books,' post free for 2d. stamps. Address S. J. BALDWIN, The Apiary, Bromley, Kent. N.B.—More than 500 Silver and Bronze Medals, First and other Prizes, and Testimonials innumerable.

THOMAS LANAWAY & SONS,
Bee Appliance Manufacturers

AND DEALERS,

26 STATION ROAD, REDHILL.

Catalogue post free on application. 2891

J. TREBBLE'S
BEE HIVES.

All Machine-made.

My 8/6 COTTAGE HIVE beat all comers.

Awarded Seven Prizes this year. Catalogue free on application to J. TREBBLE, Saw Mills, Romansleigh, South Molton.

British Bee Journal and Bee-keepers' Record.

OFFICE:

17 KING WILLIAM STREET, STRAND, LONDON, W.C.

PURE CANE SUGARS.

For the accommodation of Bee-keepers, guaranteed Pure Cane Sugar will be supplied in large or small quantities through this office at the under-mentioned rates:—

MOIST. Neat bags, 14-lbs. 28-lbs. 56-lbs. Cwts.
3. MUSCOVADO 2/7 5/2 10/- 19/6

CRYSTALLISED.

4. DEMERARA } Crystals 2/9 5/4 10/6 20/6
5. BARBADOS }
6. TRINIDAD }

REFINED CANE.

7. WHITE CRYSTALS (Small) 3/0 10 11/6 22/6
8, 9. (Medium and Large sizes, 1/- per Cwt. extra.)
10. LUMP (Cut Loaf) ... Boxes, 3/3 6/3 12/3 22/6
11. LUMP DUST 3/1 6/- 11/9 22/6
12. PRESERVING 3/- 6/- 11/9 22/6

FINE.

13. GRANULATED 3/3 6/3 12/3 22/6
14. CASTOR Coarse (15 Fine) 3/9 7/3 14/3 27/9
16. ICING... .. 4/3 8/3 15/9 31/-

All above guaranteed made from CANE SUGAR only, and free from BEET, CHEMICALS, etc., etc.

CARRIAGE PAID on Orders over 5/0 (or 28-lbs. Sugar) to London and Suburbs.

COUNTRY ORDERS, not less than 2-cwt. carriage paid at 1/0 per cwt. extra.

(Scotch and Irish orders, special arrangements.)

Cash to be sent with order, and purchasers will please observe that if samples are required or replies asked to inquiries, a stamped addressed envelope must be sent, as we cannot undertake cost of postage.

THE
British Bee Journal,
BEE-KEEPERS' RECORD AND ADVISER.

No. 483. Vol. XIX. N. S. 91.]

SEPTEMBER 24, 1891.

[Published Weekly.]

Editorial, Notices, &c.

**COUNTY COUNCILS AND TECHNICAL
EDUCATION IN BEE-KEEPING.**

An announcement which appears this week in our advertising columns, wherein the Lancashire and Cheshire B. K. Association invites applications from gentlemen qualified to act as lecturers on bee-keeping, marks another distinct step forward in the movement recently inaugurated. It has been intimated to the Association in question that the Technical Instruction Committee of the Lancashire County Council has, in response to the application of the L. & C. B. K. A., decided to recommend that a grant of 100*l.* be made by the Council in aid of technical instruction in bee-keeping within the county of Lancashire. If, as is hoped, an equally liberal response is made by the Cheshire County Council to the Association's application, the executive of the L. & C. B. K. A. will be in a position to deal with the matter in a way likely to yield very satisfactory results. So far as we have been informed, the Associations to which grants have been promised up to the present time are the Essex (50*l.*), Northants (25*l.*), Berks (50*l.*), and Lancashire and Cheshire (Lancashire Division), 100*l.* Several other Associations have sent in applications, which are probably receiving consideration in their respective counties, and others will no doubt follow. For the guidance, therefore, of committees intending to apply for a grant, we would draw attention to the terms on which the money will be voted, as some uncertainty exists on the point, and a rather vague notion appears to prevail as to the powers for dealing with funds bestowed on such Associations as are successful in their application.

In the first place, then, it must be borne in mind that the sums voted will not, and cannot, under the terms of the Act, be forthwith handed over to the executive com-

mittee of a Bee Association, to be expended or dealt with as that body may choose. The Association must first expend the money, and show that it has been well spent for the purpose intended. This done, the County Treasurer will recoup the Association for its outlay to an extent not exceeding the sum named in each case. Moreover, as we are given to understand, it will be quite irregular to employ the fund, or any part of it, for expert work done in the way of visiting members' apiaries, except such visits are made for public purposes. No doubt, as time passes and experience is gained, the work will develop itself in ways not thought of at present; but so far the interest seems to concentrate on the employment of public lecturers, who will be engaged in travelling from point to point, giving technical instruction in bee-keeping to audiences gathered together at convenient centres by the efforts of the Association employing them.

We shall be anxious to know something further of the scheme resolved on by the Berks Association as shadowed forth by our esteemed correspondent, Mr. Woodley, on page 381 of the *B.J.* for August 27th, because it appears to us open to question whether it is not exceeding its powers in proceeding as indicated. To 'send out experts to visit every bee-keeper in the county,' who will occupy their time in giving advice to individual bee-keepers according to the orthodox method at present followed, scarcely meets our view of what is meant by technical instruction in bee-keeping. However, this matter will no doubt be definitely decided on ere long, and we draw attention to it only for the purpose of enjoining careful attention to the subject, so that no mistakes be made which will endanger the chances of permanent assistance from the county fund. It will be remembered that some little time ago a suggested form of application to County Councils was drafted by the Committee of the B.B.K.A., and printed in the *B.J.* for May 21st last.

We do not know to what extent this form has been utilised by Associations applying for a grant, but we have been favoured with a copy of the form adopted by the Lancashire and Cheshire Association which appears to meet the case admirably. All the salient points of preceding forms have been utilised in it, and some very important ones added. It reads as follows:—

‘In making application for a grant towards the work of the Lancashire and Cheshire Bee-keepers’ Association, we beg to state that Bee Associations were first commenced in this country by the British (which still continues to be the central Society) in 1874. More than thirty county and district Associations, affiliated to the British, now exist, the Lancashire and Cheshire being founded in 1882. Its object is “the encouragement, improvement, and advancement of bee-culture in the counties of Lancashire and Cheshire, particularly as a means of bettering the condition of cottagers and the agricultural labouring classes, as well as the advocacy of humanity to that industrious labourer, the honey-bee.”

‘It carries out this object by means of issuing publications, lectures (during the summer at agricultural and horticultural shows, with practical manipulations of live bees, and in winter in village schoolrooms, &c.), expert’s work in visiting and advising bee-keepers, prizes for the best exhibits of honey, &c. And it is worthy of mention that, whereas a few years ago the Association had to apply for leave to lecture and manipulate at shows, the show authorities now ask the Association to visit them in such numbers that it is often impossible to comply—*e.g.*, the Association was asked this year to be represented at four different shows held on the same date. This proves the high estimation with which the work of the Association is regarded, and its success at the present time.

‘The reasons for supporting the work which Bee Associations in this country are doing are numerous and weighty.

‘1. Their value to the artisans living in the outskirts of towns, and to the cottager and labourer. Where competent knowledge of bee-keeping has been acquired, a comparatively small outlay of money and spare time afford in good seasons a pecuniary reward equal to the keeping of a pig, or sometimes even of a cow.

‘2. As a minor economy bee-keeping is as valuable an industry to the country at large as fruit-growing or poultry-raising. The value of honey as a nutritive food is almost equal to cheese, butter, or milk.

‘3. Bees are of the utmost importance in fertilising the blossoms of fruit-trees and in seed-growing. Fruit-growing is becoming more and more a staple industry in Lancashire and Cheshire.

‘4. Tons of honey and beeswax are annually imported into this country from abroad to the value of not less than 50,000*l.* This large sum

could be retained at home if the industry of bee-keeping were stimulated and more widely diffused.

‘5. Bee-keeping is recognised by the Education Department as a subject for teaching and examination in elementary schools.

‘6. The leading agricultural societies in Great Britain give bee-keeping a definite place in technical education in agriculture.

‘7. Apiculture has long been admitted among Continental nations as a subject of technical education.

‘Bee-keepers, as a class, are far from wealthy, and their Associations have, therefore, but limited means with which to carry on their work. This is the case with the Lancashire and Cheshire Association, which numbers upwards of 500 members. A grant in aid of its efforts would enable the Committee to maintain a competent educational lecturer and expert, who would devote his whole time to systematically travelling throughout the district, affording each eligible locality full opportunity of becoming acquainted with the theory and practice of bee-management, just as dairy schools in Lancashire and Cheshire are imparting instruction in improved methods of making cheese and butter.

‘A further and most important feature of such an expert’s work would be the giving full information, with a view of checking and finally exterminating that virulent but at present little-understood disease called “foul brood,” which, in its results amongst bees, is equivalent to pleuro-pneumonia among cattle. From lack of knowledge one infected hive is often the cause of wholesale loss throughout a whole district.

‘The Committee of the Lancashire and Cheshire Bee-keepers’ Association estimate that an annual sum of about 350*l.* is requisite to carry out their work successfully. Towards this they beg for a substantial grant from the County Council, which would be utilised as above stated in the county making the grant.’

Here follow the names of the president and the several vice-presidents of the Association, followed by that of the chairman of the executive committee.

It will be observed that special importance is given to the subject of foul brood; not without good and sufficient reason, for there is no one point in the whole science of bee-keeping in which technical instruction is so much needed as this. Once enable the bee-keeper to cope successfully with foul brood and many of the elements which go to make a successful bee-keeper will follow, because to the woful ignorance regarding this bee-pest may be attributed most of the failures now too prevalent.

In conclusion, we again advise that care—

ful attention be given to the manner in which 'grants in aid' are expended in order to keep well within the meaning of the Act, and save complications which are likely to arise if the money is inadvertently misapplied.

BRITISH BEE-KEEPERS' ASSOCIATION.

Committee meeting held at 105 Jermyn Street, on Wednesday, September 16th. Present: T. W. Cowan (in the chair), Rev. Dr. Bartrum, Hon. and Rev. H. Bligh, Rev. R. Errington, Captain Campbell, J. Garratt, W. H. Harris, W. Lees McClure, and the following *ex-officio* members, viz., J. M. Hooker, W. B. Carr, Dr. Rayner, and F. H. Meggy.

A letter was read from the Rev. F. T. Scott regretting his inability to be present. The Finance Committee reported that the whole of the accounts relating to the Bath and Doncaster Exhibitions were now complete. The Secretary was requested to furnish a comparative statement of the cost of these exhibitions with those held in previous years by the date of the next meeting.

A letter was read from the Rev. J. L. Seager in reference to the arrangements for holding an examination of candidates at the Bradford Exhibition. Resolved: That the same be referred to the Educational Committee.

The Chairman reported that the Organizing Secretary of the Educational Committee of the Surrey County Council desired information in reference to bee-keeping in the county. The Secretary was instructed to write to the Surrey Association, asking them to furnish the information required.

The Chairman and Secretary were empowered to make any necessary arrangements for assisting the British Dairy Farmers' Association in the honey department at the annual dairy show.

The following recommendations of the Northern Counties Sub-Committee were considered:—

(1) 'That no candidate be passed as an expert unless he be able to detect foul brood, and that those holding certificates be called upon to return them when the time for which they were issued expires, unless they are prepared to pass an examination on the subject of foul brood.' Referred to the Educational Committee for further consideration and report.

(2) 'That in asking the County Council for grants in aid, attention should be called to the fact that foul brood is to the bee-keeper what pleuro-pneumonia is to the farmer, and as such it should be compulsory to report it wherever it exists.' It was pointed out that all matters relating to the compulsory reporting of infectious diseases amongst cattle were now dealt with by the Minister of Agriculture, and not by the county authorities as formerly. After further discussion it was resolved that the Chairman, Mr. McClure, and Mr. W. Broughton Carr be appointed a special Sub-Committee to consider and report thereon.

LANCASHIRE AND CHESHIRE BEE-KEEPERS' ASSOCIATION.

ALDERLEY EDGE AND DISTRICT BRANCH.

The above Branch held its first annual show on the 5th of September, in connexion with Chelford Flower Show, in the beautiful park surrounding the residence of Colonel Dixon, Astle Hall.

The show of extracted honey was very good, both in quantity and quality; but the entries for sections were few, owing to the short season and to most of the bee-keepers in the district working for the former. The honey was staged on raised shelves lent by the British Bee-keepers' Association, which added greatly to its effect.

Mr. W. B. Webster, the well-known expert, acted as judge, and took charge of the manipulations in the bee-tent, which was surrounded by a large audience.

Mr. Webster had been making the expert's tour for the Lancashire and Cheshire Bee-keepers' Association in the district, and on the evening before the show a meeting of the members of the district was held in the Conservative Club, Alderley Edge, to meet him, when, by the request of the local Hon. Sec. (Mr. Schofield), Mr. Webster gave a lecture comprising the three following subjects:—'Requeening Small Apiaries,' 'Foul Brood,' and 'Preparing Bees for Winter,' all three of which were most ably dealt with by him.

In spite of your valued article on sending honey to shows in the *B. B. J.* and *Record*, I am sorry to say several exhibitors at the above show had not profited by it, and some of the honey of two of them was broken in transit. The box with wood divisions and corrugated paper is so simple and easily made, and such a comfort in packing up the honey at the end of the show.

LIST OF AWARDS.

Class 1. For the best and largest exhibit of honey from one apiary.—1st prize, Herbert Bradbury, Mobberley.

Class 2. For the best twelve sections.—1st, R. Waldy, Sutton-on-Derwent; 2nd, W. G. Groves, Alderley Edge.

Class 3. For the best twelve jars of extracted honey.—1st, E. Broughton, Wilmslow; 2nd, F. W. Dunsford, Frodsham; 3rd, Joseph Griffith, Frodsham; 4th, John Jennings, Warford.

Class 4. For the best six sections.—No entries.

Class 5. For the best six jars of extracted honey.—1st, E. Broughton; 2nd, Alfred Jennings; 3rd, Joseph Griffith.

BRIDGWATER FLOWER AND HONEY SHOW.

At the first show recently held under the auspices of the newly-formed Bridgwater Horticultural Society, a department was allotted to the exhibition of honey. A good display was made in the several classes, and the result must

have been gratifying to the Committee. Mr. Peirce, of North Petherton, was the largest exhibitor. Three observatory hives, stocked with bees, were exhibited in competition, and formed a great attraction to the visitors.

The Rev. C. G. Anderson, rector of Otterhampton, acted as judge in the bee department, and his awards gave general satisfaction.

The Rev. C. G. Anderson, at the luncheon held subsequently, responded to the toast of 'The Judges,' and in the course of his remarks stated that the portion which he had the honour of judging was remarkably good; the honey which he had judged that day was of first-rate quality.

LIST OF AWARDS.

Division G.—Honey.

For the best six 1-lb. sections.—1st prize, R. Addison, North Petherton; 2nd, W. Peirce, North Petherton; 3rd, Mr. Withycombe, Bridgwater.

For the best three jars extracted honey.—1st, W. Peirce; 2nd, Mr. Parker, Bridgwater.

For the best glass super of honey.—1st, W. Peirce; 2nd, Mr. Withycombe.

For the best straw super of honey.—1st, A. N. Other; 2nd, Mr. Tucker.

For the best observatory hive, with bees.—1st, Mr. Withycombe; 2nd, W. Peirce.

Special Prizes for Honey.

For the best collection of honey in any form.—1st (given by Mr. W. Thompson), W. Peirce.

For the best collection from one apiary.—1st (given by Mr. J. Withycombe), R. Addison.

HEREFORDSHIRE B.K.A.

The seventh annual honey fair in connexion with the Herefordshire Bee-keepers' Association was held in the Market Hall, Hereford, on Wednesday, September 9th. There were about twenty-four exhibitors, and the quality of the honey shown was certainly fully up to the average, both as regards that shown in sections and the extracted honey. The honey harvest is reported as an average one, having been very good in the earlier portion, but the bad weather in the latter part of the season having caused a slight falling off in the 'crop.' The honey exhibited was, considering this, very good, and a ready sale was experienced at from 10d. to 1s. per pound. The exhibits were judged by Mr. E. J. Burt, of Gloucester, and the general arrangements were superintended by Mr. Alfred Watkins, of Hereford, the local secretary of the Association. The following is the prize list:—

Best and neatest exhibit of honey, not exceeding 200 lbs.—1st, J. H. Wootton, Byford; 2nd, W. Tomkins, Burghill; 3rd, M. Meadham, Huntington.

Open class. Best six 1-lb. jars of extracted honey.—1st, T. Pritchard, Bucknell; 2nd, J. H. Wootton; 3rd, Miss Marillier, Much Dewchurch.

Novices' class. Best 6-lb. jars of extracted honey.—1st, Miss Wootton.

Open class. Best six 1-lb. or three 2-lb. sections of comb honey.—1st, T. Pritchard; 2nd, J. Wootton.

Novices' class. Best six 1-lb. or three 2-lb. sections of comb honey.—1st, Mrs. Blashill, Bridge Sollars; 2nd, Miss Stillingfleet, Holmer.

For the best single super, not being a sectional super.—1st, W. Smith, Thinghill; 2nd, W. Tomkins.

Best exhibit of honey in any shape, taken without killing the bees, and shown by a *bonafide* cottager.—1st, James Owens, Upperton; 2nd, Mrs. Trupp, King's Thorne.

WIGTOWNSHIRE APIARIAN ASSOCIATION.

The annual show was held in Queen's Hall, Stranraer, on Friday, September 4th. The show was a great success throughout, the entries by far exceeding those of any former year. The first and second prizes in the three-pound jar competition were carried off by Mr. J. D. McNally, now residing in County Down, Ireland. This class was the chief attraction. McNally carried off the palm with the same samples at Castle Douglas on the previous Thursday. The classes for sections, supers, and heather honey were, on account of the unfavourable season, not up to those of former years. A special prize for a well-filled and finished bell-glass of honey was awarded to Mrs. McDouall. Praise is due to the Hon. Secretary, the Rev. J. B. Robertson, Leswalt Manse, for the zeal and energy displayed in connexion with the annual show. The Judges were Mr. William Wilson, Dumfries, and Mr. R. McNally, Longforth, Glencue. The latter gentleman did not judge in those classes where his brother was an exhibitor, and his place was taken by Mr. John Muir, Castle Kennedy. The awards of the Judges gave general satisfaction. Mr. Ross, of the Stranraer Reformatory, exhibited a great variety of bee-appliances.

The following is the prize list:—

Best six 1-lb. sections.—1st prize, James Wither, Lochans; 2nd, Mrs. McDouall, Logan; 3rd, John D. McNally, Laurieston, co. Down.

Best six 1-lb. sections of heather honey.—No first prize awarded; 2nd and 3rd, John Galloway, Garvilland, Glencue.

Best three 1-lb. jars of extracted honey.—1st and 2nd, J. D. McNally; 3rd, Mrs. McDouall; 4th, John Craig, Logan.

Best three 1-lb. glass jars of extracted heather honey.—1st, 2nd, and 3rd, John Galloway.

Best six 1-lb. glass jars of granulated honey.—1st, John Craig; 2nd, James Fleming, Castle Kennedy; 3rd, William Agnew, Lochryan Hall.

Best super of clover honey under 8 lbs.—1st, James Milne, Castle Kennedy; 2nd, W. H. McDowall, Kirkcowan.

Best super of heather honey under 8 lbs.—W. H. McDowall.

Best sample of beeswax.—James Fleming.

Cottagers' Classes (confined to Wigtownshire).

Best super of honey.—1st, Wm. Gray, Pinwherry; 2nd, John Craig; 3rd, Wm. Carson, Glenluce.

Best six 1-lb. sections of honey.—1st, John Craig; 2nd, Wm. Muir, Kirkcowan; 3rd, Alex. Rodie, Logan Mill.

Best three 1-lb. glass jars of run or extracted honey.—1st (and timepiece presented by the Rev. A. D. Watson), Miss Bessie Derrick, Lochans; 2nd, Wm. Grieg, Mahaar; 3rd, Wm. Gray; 4th, Alex. Rodie.

Extra class.—Mrs. McDouall.

SHOW AT EDINBURGH.

An international flower show was held in Edinburgh on 9th, 10th, and 11th September, under the auspices of the Caledonian Horticultural Association. It was much the largest flower show ever held in Scotland, and one of the largest ever seen in Britain. Every part of the Waverley Market was filled with a magnificent display of flowers and fruit. It had been hoped that the society would have worked with the newly formed S. B. K. A. in organizing a honey display, but the arrangements had all been completed before the S. B. K. A. was formed, and it was impossible to alter them. There were, however, several liberal prizes given for honey, and the classes were mostly well filled. In opening the exhibition, Viscount Melville, himself a member of the S. B. K. A., referred to the presence of honey in the show, and said he hoped that at future shows this part would be better developed.

Unfortunately, the space assigned to honey was such that it was impossible to stage it so that it could be well seen. There were five entries for a display, all good. The appearance of the first-prize display was somewhat marred by some jars of very dark honey, but it consisted almost entirely of beautiful clover honey. In Mr. Roebuck's display there were several honey designs of great merit, but the display was put up in a corner where it was not well seen. The class for twenty sections of flower honey was a very strong one; the second-prize lot in this class were, except in the matter of get-up, the finest in the show. There was only one entry for heather honey, some badly finished sections of honey of a poor consistency: no prize was awarded to it. Heather honey is generally the most interesting feature at this show, and every one was sorry not to see any, but its absence was, in part, made up for by the very high quality of the flower honey shown. The judges were Mr. Chouler, Dalkeith Park, and Mr. Murray, Culgean. All of their awards met with general approval. The prize list is as follows:—

Best display of flower honey.—1st prize, James Learmont, Balmaghie, Castle Douglas; 2nd, S. Roebuck, Traqueer Cottages, Dumfries; 3rd, W. Birrell, Bridgend, Perth.

Finest 20 lbs. of flower honey in sections.—1st, James Learmont; 2nd, John McCreath, Dumfries; 3rd, S. Roebuck.

Finest super of flower honey, in wood or straw, not under 10 lbs.—1st, Peter Main, Avondale, Polmont; 2nd, Mrs. Chisholm, Traqueer Cottages, Dumfries; 3rd, W. Jardine, Dumfries.

Finest super of flower honey, any weight.—1st, J. McCreath; 2nd, S. Roebuck; 3rd, W. Jardin.

Finest wax not exceeding 10 lbs.—1st, Richard Cairns, Dalkeith Gardens; 2nd, W. Birrell; 3rd, Peter Robertson, Jedburgh.

An observatory hive, any pattern, stocked with bees and their queen.—1st, Richard Cairns, Dalkeith Gardens; 2nd, James Hawthorn, Moffat Cemetery.

Correspondence.

The Editors do not hold themselves responsible for the opinions expressed by correspondents. No notice will be taken of anonymous communications, and correspondents are requested to write on one side of the paper only, and give their real names and addresses, not necessarily for publication, but as a guarantee of good faith. Illustrations should be drawn on separate pieces of paper.

Communications relating to the literary department reports of Associations, Shows, Meetings, Echoes, Queries, Books for Review, &c., must be addressed only to "The Editors of the "British Bee Journal," 17 King William Street, Strand, London, W.C." All business communications relating to Advertisements, &c., must be addressed to Mr. J. HUCKLE, Kings Langley, Herts (see 1st page of Advertisements).

** * In order to facilitate reference, Correspondents, when speaking of any letter or query previously inserted, will oblige by mentioning the number of the letter, as well as the page on which it appears.*

NOTES BY THE WAY.

[780.] The week following my last notes was a grand one for the farmer, and all went merry as wedding bells; but the past week has been unsettled, and very little corn has been gathered into the garner. The apiary during the previous week was in harmony with the weather, and some foraging amongst the late flowers was secured, and in some favoured localities, where mustard is sown to plough in for the wheat crop, a considerable quantity of stores was gathered. Here we have only a sparse sprinkling of wild mustard (charlock) amongst the root crops, so that our bees could not net a large amount.

Our Berkshire Association has during the past week had four experts on tour, on the 'wheel,' among the bee-keepers, viz., Messrs. Fewtrell, Flood, A. D. Woodley, and Webster. These experts have been, as I intimated in a previous note, enumerating the bee-keepers in the county, calling on each one, and tabulating the number of his stocks, the output for the year, and other interesting data. No doubt their experiences have been unique when they have chanced to come across a real old-fashioned bee-keeper, and I am sorry to say there are very many who still follow the barbarous method of smothering their bees at the end of the season to secure the honey crop. The bar-frame hive has still to be introduced to the country bee-keeper in the remote villages and sequestered hamlets of our county. In and near the towns the bar-frame hive predominates; but get a few

miles out and the cottager is still in blissful ignorance of the same, and where you find one with some slight knowledge of it, others still look on the same as some 'new-fangled notion' which they do not understand, and which they do not feel inclined to adopt, remarking somewhat after this manner, 'Well, maister, what you says about 'em is all very well, but I do not see as they'll benefit the loikes o' I.' But must we relax our efforts because some old-time, stand-still old fogey sees things in that light? The thicker the jungle, the more we must wrestle with difficulties; the more dense the ignorance, the greater the need of light and knowledge to clear it away. Therefore we must forge right ahead, and if we cannot reform and reclaim the older members of bee-keepers, we must begin at the beginning with the growing intelligences, and teach the growing generation the better way of bee-keeping. And this brings me to the recent development of our County Council in the matter of 'Technical Education.' This development will enable us to make greater efforts as an Association to bring our craft to the notice of the public, and also call attention to the work we are doing in trying to teach a more profitable way of keeping bees, and prove conclusively that, though our industry is of a minor kind, yet it is one in which a great number can join without infringing on the rights or domain of his neighbour; also one from which a better return can be expected than any other of the minor industries.

Sale of Members' Produce.—This is a matter that should be kept in view by any society existing for the benefit of its members, and this branch of the Berks Association has been well kept to the front. I have always contended that the sale of the honey produced in the bar-frame hive (generally in sections) would prove the greatest inducement to the bee-keeper to adopt the modern hive, and also to become and continue a member of the Association. Every one who is conversant with village life must know that the cottager cannot dispose of his honey locally in the comb, and to break up the beautiful combs and run the honey into stone crocks or pots, and sell the same for sixpence per pound is not likely to commend itself to the new recruit to the modern system; therefore, any Association that provides a channel whereby the cottager can place his honey on the market without the trouble and expense of preparing it for the London market—a matter often beyond the capabilities of the village apiarian—I say that Association is filling a large measure of usefulness. —W. WOODLEY, *World's End, Newbury.*

CURING FOUL BROOD.

[781.] About six weeks since a neighbour of mine, a member of the Kent B. K. Council, drew my attention to a hive that had been neglected at Farningham, in which there were seven out of its ten frames with distinct evidence of foul brood. The usual filthy smell followed the opening of each diseased cell; but the stock was

not weak, nor was the extent of the mischief so bad as to discourage us from attempting a cure, spite of the risk to adjacent stocks.

The treatment was as follows:—First, we cut out many of the diseased cells, dropping in formic acid into the cavities; suspended a cotton cloth saturated with formic acid on a frame at the rear of the hive; wedged camphor cake at entrance, and distributed camphor in the hive on floor-board and between shoulders of frames; then covering up with impervious quilts.

A week later we cut out more diseased cells, and repeated above treatment.

At the end of another week I put on the floor of the hive the small piece of naphthaline which you were good enough to give me; but the weather at the time was unfavourable to an examination, and the hive was left for about three weeks. Yesterday, on a very careful inspection of every frame, not a trace of the disease was visible. There were unsealed grubs of that plump, pearly appearance one likes to see, and the sealed brood looked as well as it is possible to desire. The stock looked strong and active, and, so far as we can see, the disease has been vanquished, but this the winter will conclusively prove.

We shall now feed with syrup containing the prescribed dose of Naphthol Beta, and I hope when spring returns I may have the pleasure of sending you a further favourable report. During most of the time that the hive has been under treatment the weather has been unfavourable—wet, with low temperature.

I send you these particulars, thinking they may interest you and the readers of your *Journal*.—E. D. TILL, *Eynsford, Kent.*

BEE-HOUSES.

[782.] In your *Journal* of March 19th, 1891 (page 141, and No. 536), you inserted a letter of mine together with a drawing of a bee-house which I had used for some little time. I need not, I think, enter into particulars, but this bee-house holds two hives, and it gives me a better acquaintance with what takes place immediately outside the bee-hive entrances than most bee-keepers possess.

The entrances to the two hives in each bee-house, though practically quite separate from one another, are immediately under the eye of an observer; but by pulling out a perforated zinc slide the bees have simply to walk sixteen or eighteen inches to get into the opposite hive. It may be interesting to your readers if I give a short account of what took place on the 11th of August last, in joining the two hives.

In order to explain, I will call the hives Nos. 1 and 2. No. 2 was a weak hive, and consisted of one body-box, containing nine frames. No. 1 was stronger, and held two body-boxes and eighteen frames, one on the top of the other. I wished to join No. 1 to No. 2; this was done in the middle of the day when the bees were flying freely. The hive No. 2 was tem-

porarily moved from its place. A slide was put in so as to prevent the bees belonging to No. 1 hive from getting into their hive, and the lower half of No. 1 hive was put into the place of No. 2; a little syrup was sprinkled into it with a watering-can; No. 2 hive was placed on the top, and the upper half of No. 1 hive was placed above—the total containing three body-boxes with twenty-seven frames. In the meantime the No. 1 bees were coming home, and were crowding the entrance to No. 1 hive. The division between the two entrances was pulled out, and the No. 1 bees, finding their queen removed, and their own hive entrance shut, walked across to their own hive, sixteen or eighteen inches away. The No. 2 bees were also there, but they mixed without any fighting, and after some hours of excitement, as if neither lot of bees liked to go in, they finally, by evening, all went in. One of the reasons why I think they did not fight was that both lots of bees were full of honey, and another reason in my opinion is, that when bees walk to one another in that way, there is much less disposition to fight than if they fly to one another.

The No. 1 bees at first, for two or three days, came to their own old hive entrance and tried to get in. After that time they simply took a short cut across to their new entrance, but in gradually diminished numbers, and yesterday I counted only two per minute, while 100 or 200 were going direct. The No. 1 bees had invariably gone direct. Probably the great bulk of the bees alive and flying on August 11th, are now dead, and the young ones only remain. These would never use the, to them, old entrance. The number of bees using the old entrance has diminished very much in the last week. Another reason why I think the bees did not fight, was that, being so close to one another, and divided only by a perforated zinc slide, they got acquainted with smell of their neighbours.

In moving bees, and joining in the ordinary way, I think there must be a great many bees which lose their way, or get into other hives by mistake, and perhaps perish. I think with this arrangement, as long as the bees join without fighting, none are lost, and so far I have never seen fighting.

The weather here has been very fine and hot for the last few days, and bees on the heather will be doing well. My bees, though a few hundred yards from heather, never do much, but the ground is wet and the heather old.—McC., *Annan, September 24th.*

INCONSISTENT SHOWING.

[783.] The correspondence which has passed through your columns under the above heading contains a statement by Mr. Gay that he attributes the dark, mahogany colour of his honey to wild raspberries. Is he not mistaken in this, for I have always believed raspberries gave light, amber-coloured honey? I should be glad if you would give your views of this, and

also elicit information on the point from others. [Raspberry honey is light in colour.—EDS.]

As to honey from two apiaries almost adjoining being of such a different colour, I well remember an experienced bee-keeper in this county (for many years the largest bee-keeper) telling me he once noticed two hives standing together from which the bees flew in exactly opposite directions. When extracting, he found one hive contained almost *colourless* honey (the same as the bulk of his produce always is), and the other hive very *dark* honey.—EDWARD J. GIBBINS, *Neath, September 17th, 1891.*

TO NORFOLK BEE-KEEPERS.

[784.] Having read a book called *Modern Bee-keeping*, and seen your address, I beg to ask if you will kindly give me your advice? I have at the present time six stocks, all in the old-fashioned straw skeps. I know nothing about bee-management. There is a man close here who has usually taken the honey for me, but he usually kills the bees in taking it. I see by the book that should not be done. I once saw an answer to a querist in the *Weekly Times and Echo*, stating that a cottager could join the Bee-keepers' Association for 1s. per year, and get a visit from an expert once or twice during the season. Will you kindly tell me if such is the case? If so, I should like to join, as I am a woman in very humble circumstances, my husband, a farm labourer, earning 11s. or 12s. a week. Up to the present my bees have never paid me anything, with the exception of a few pounds of honey taken up the last two years and sold at 8d. per pound. I should be so thankful if I could become a bee-keeper so as to make a profit out of them, to help for rent and clothes. Do you think, sir, that could be done in my humble way? I see by the bee-book that bar-frame hives are the best, but they would be too expensive, unless I could make my bees pay for them. My husband wants me to have some of the hives 'put down,' that we might be able to sell a little honey; but I would not have them destroyed until I wrote and asked your advice how to do the best I can with my six skeps, four of which are this year's swarms and two last year's. How can I best manage them? I am dreadfully afraid of bees, but am willing to try to overcome that. Do you think I might try driving them from one skep to another, and so get the honey? If so, will you please tell me the best and safest way to act for one who is timid, and don't understand them. Also, is it too late to put bees in an empty skep and feed them with syrup, or must I leave them in the skep with the comb in? If the latter, how can I do it? What is the best way to get the food to the bees in my skeps? I am told the best way is to pour syrup on a piece of empty comb, and lay it in front of the hive entrance; is this so? A friend has just made me a nice wood stand for my skeps. It is 2 feet 6 inches long, with two shelves 29 inches wide and 23 inches apart, boarded up at ends

and open back and front, with wood roof. Which is the best quarter for it to face? My skeps now stand face to the south. May I move the skeps on to the new stand at once? They stand now in a corner of the garden, with a hedge north and south of them. Would it be best to stand the new bee-house close to the hedge, or leave it so that one could get at the back? I fear I shall be very troublesome with all I want to know; but, dear sir, any practical information you can give me that will help me will be most thankfully received; also if you will tell me if I can join the Association for the small amount named, or what it will cost me, and where to apply.

Trusting no offence at the trouble I am giving you, hoping to receive a reply, and that I may be able to derive a profit from my bees in future to help with our small incomes.—(Mrs.) E. SMITH.

[The writer of the above resides opposite the church, Runcton Holme, near Downham, Norfolk; and we trust the recital of her simple story will induce some reader residing in the neighbourhood to kindly give her a helping hand with her bees. A little personal help would be far more effective than any instructions we might write.—Eds.]

CURING FOUL BROOD.

[785.] Thanks are due to you for the many hints I and others in this place have had from your *Journal* for the cure of foul brood. I had six stocks in a bad state. I am glad to say all are cured but one, and that one only very slightly affected, the hive being crowded with bees and brood hatching daily. Here and there can be seen a cell capped, in which, upon opening it, is found that coffee-coloured mess. I use Naphthol Beta and naphthaline.—J. C., *Devon*, September 21st.

PREVENTING SWARMING.

[786.] I keep five stocks of bees and have no wish at all to increase the number. Of course, my trouble is to prevent swarming. I keep my bees in a bee-house sufficiently large to allow of easy manipulation at the back. The entrances are in front, and are approached through porches about a foot deep. I am thinking of enlarging my alighting-boards, and during the swarming season closing the entrances to the porches with the best excluder zinc. Would this be contrary to good and sound bee-management? Of course, the drones would not be able to fly; but I propose during the time the excluder zinc is on having it removed, say, for a couple of hours occasionally in the middle of the day, and the hives watched; I should hope by this to shut out a good many of the drones, which would be an advantage. My hives are at the far end of my garden, and at the end of an avenue of large elms half a mile long. If a swarm, therefore, does issue unobserved, the chances are it is never discovered.

My five hives produced me this year forty-five one-pound sections, and 129 pounds extracted

super honey—total, 174 pounds. This was principally gathered in June. July and August were bad bee-months here. I never extract from the body-boxes.—A. L. Y. M.

[For several reasons we should not advise the adoption of the plan proposed for the prevention of swarming. A better plan, we think, would be to remove the old queen just before putting on supers, and using the best 'self-hiving arrangement.' If the stock swarmed, and was safely hived by the self-hiver, return the swarm on the morning of the day following that on which it issued, and let the surplus queens fight it out among themselves.—Eds.]

FLOUR FOR UNITING.

[787.] I commenced bee-keeping a year ago last June, since which time I have learnt more from your paper than I thought could ever be known about bees. I am just putting right for winter ten stocks. Have successfully united several lots with flour. No fighting, like last year, when I knew nothing of it. The last two lots were a swarm, with, of course, old queen, and an old stock which this year had swarmed and cast, with young laying queen, and which I transferred from its old skep into bar-frames on July 30th last. I searched the frames of the swarm in vain to catch queen, and as all brood had hatched out, and there were no eggs (this was on September 12th), I thought it had possibly become queenless. I therefore smoked both lots, sprinkled with pea-flour both sides of all the frames, and placed them alternately all in one hive. The bees united without a single fight. The hive being an observatory, having a window, the ends of frames next the glass were visible, and I saw the united lot next day happy in their ten frames. This morning three workers rolled me out the enclosed queen. Will you kindly inform me whether it is the queen of the swarm, or the 1891 queen of the old skep? Please also describe its breed and characteristics. I want to become expert in judgment of queens, as far as is possible without scientific knowledge or the aid of the microscope.—H. C. JACQUES, *Burton-on-Trent*.

[Queen sent is a very fine young one of the ordinary black (or brown) variety.—Eds.]

INCONSISTENT SHOWING.

[788.] Referring to the correspondence on the above subject on the 7th of July, I extracted some honey for the Chichester show, taking first prize, and at the end of the month I extracted some more from the same hive, not so good colour or consistence. White clover was out all the month.—G. FAIRS, *Mundham, Chichester*.

'NOMINAL' ONE-POUND BOTTLES.

[789.] I think it is time that a protest should be made against the growing practice of using short-weight bottles. I refer to what are usually called 'nominal' one-pound bottles. Thus, a bottle of honey is sold to a consumer as a

'nominal' one-pound, and he naturally expects to receive about one pound of honey, whereas these bottles will not contain sixteen ounces, but only a little over fourteen ounces when full, as I have carefully tested; and from the fact that full-weight bottles can be bought from the same dealers who supply these short-weight bottles, it would appear to me that they are made for this very purpose. Apart from the principle, it gives to the users of them an unfair advantage over those who, like myself, give—SIXTEEN OUNCES, *Warrington, September 18th.*

EXPERTS' CERTIFICATES.

[790.] I remember seeing in *B.B.J.* some time ago an opinion expressed by some of your correspondents that the certificates given to experts were not so artistic as to add to their emblematic value. I think a larger fee would be willingly paid (if need be) for a more ornamental certificate, and no profession is so rich in emblems as ours, and as the aspirants have no mercenary motives in striving for it, I wish a more pleasurable production could be substituted, so that it might have a double value.—**THIRD-CLASS EXPERT.**

Queries and Replies.

[431.] *Difficulties of Autumn Feeding.*—I have been feeding my bees, and had only managed to give them one and a half pounds of syrup when robbing commenced, and one hive, which, I think, must have been queenless, has been cleared out, so I have stopped feeding. The robber-bees are my neighbour's, who don't care to feed. 1. If I put in frames of dry sugar now, would it do as well as syrup-feeding, and would white granulated sugar do for it? 2. I have ten frames of honey I want to give to two hives; what would be the latest time I could put them in the hives; would the end of November be too late, as I want to go away for a couple of months and would not be home much before that time? 3. I have two or three late swarms, so if dry sugar would do, it would save me a great deal of anxiety as to their feeding. What is the very latest time I can feed bees? I have got the entrances closed to one bee-space, and I spray carbolic acid about to try and keep the robbers away. Some of my hives have quite enough food to winter on with some candy. 4. Will it do harm to leave the surplus chamber on a hive with excluder zinc between for the winter?—**A PERPLEXED BEE-KEEPER, Alton.**

REPLY.—1. The bees cannot winter on dry sugar in frames, and in any case *granulated* dry sugar is useless for bee-food. We have known bees to winter well with a bag made of coarse cheese-cloth filled with about twelve to fourteen pounds of Porto Rico or of raw Demerara sugar laid over the frames like a cushion. It is

much better, however, to feed bees for winter on well-made syrup, and if the food is given in the evening in rapid feeders, it should be all stored away by the following morning. 2. The frames of honey may be given when packing up for winter, but if the latter operation is performed so late as end of November, care must be taken that the bees do not suffer from want in the meantime. 3. End of September is late enough, though it may be done in October if weather is mild. 4. No.

[432.] *Old Railway-carriage for a Bee-house—Examining Stocks in Autumn.*—1. Would an old railway-carriage be a suitable place to keep a number of stocks of bees in, with the windows arranged as Simmins recommends—viz., the glass down to about half-inch from the bottom, and a piece of perforated zinc, outside side, reaching up the glass about six or seven inches, and three-eighths of an inch distant? Every-where else would bee-proof except entrances. 2. Wishing to examine my stocks and see how they stand for the winter, I made an attempt about ten days ago, but before the hive had been open more than five or six minutes robbers began to be troublesome, so I closed up hive carefully and as quickly as possible (this was about 2 p.m.). But the bees continued very excited, and were fighting all the afternoon. Next morning there were, I should judge, about 1000 dead bees in front of hive. A few days afterwards I examined another hive with the same result; both were very strong stocks. We have a lot of heather a mile away, and mustard and charlock in full bloom (forty or fifty acres) within half-mile, and all my stocks (eight) have plenty of stores in hive.—**NOVICE, Salisbury.**

REPLY.—1. Yes. If the internal arrangements were properly attended to a railway-carriage would make a very good bee-house. 2. When trouble, such as you indicate, accompanies any attempt to examine stocks, the operation should either be deferred till later on, or performed in the early morning or in the evening, or else on such days as the bees are not flying. For reply to other queries see 'Notices to Correspondents.'

WEATHER REPORT.

BUCKNALL, LINCOLN. BM, 25.—*August, 1891.*

Max., 74° on 14th,	Rain:—3·19 inches.
Minimum, 32° on 29th.	Average, 5 years, 2·59 in.
Mean Max 66·2°	In 24 hrs. 5·4 on 17th.
" min 47·3°	Rain on 26 days.
" temp. . . . 55·1°	Frost, 1 day.
" of 5 years 56·6°	Range, 18·0°.

Remarks.—A damp, sunless month. My honey harvest has been a failure. Out of nine stocks those which have swarmed gave no return; two which did not swarm only gave about two stones each. Average for nine stocks, fourteen pounds per hive. Swarms manage with help to build combs, but got no stores. Only one honey week during season.—**J. BINT.**

Bee Shows to Come.

October 13th to 16th.—British B.K.A., in connexion with the Dairy Show at the Royal Agricultural Hall, London. All open classes. Entries closed. For schedules apply to Wm. C. Young, Sec., 191 Fleet Street, London.

Echoes from the Hives.

Kirkbride, Cumberland, September 16th.—The season here has been very moderate. My own crop is about 600 lbs., principally extracted honey; but, as a set-off, I had to feed three pounds' worth of sugar in spring, and have to feed two pounds' worth for wintering, as the autumn rains have spoiled the autumn flow of honey. Skeps in this district are far worse than I have ever seen them, while in the bad season of 1888 they averaged well.—J. STORMONTH.

Hopping Wood Farm, New Malden.—I am pleased to tell you that, in spite of the very unpropitious weather, I have taken a nice lot of very good honey, and do not think bees will require feeding for winter.—ALBERT T. HORLICK.

MR. EBENEZER McNALLY.

The following is extracted from the *Harrington Guardian*, and is part of a biographical sketch referring to Mr. E. McNally's career as a bee-keeper. Mr. McNally was born on the 22nd July, 1852, and has been a frequent correspondent to the *B. B. J.*

As a bee-keeper, his interest in the hobby began at Ardwell in 1870, and when in Canada in 1875 he had the good fortune to see several beautiful supers at the provincial show. The facilities of a large town are not great for bee-keeping, but on several occasions he has had hives stationed and doing well in most unlikely places. He was a committee member of the Caledonian Apiarian Association, and has won a considerable number of its silver medals. He founded the Rutherglen Apiarian Association. In 1887, when the Glasgow Exhibition was proposed, he asked the executive to insert classes for the national industry of bee-keeping. This point gained, however, none of the Scotch bee-keepers came forward, and eventually, at considerable expense, Mr. John D. McNally and himself placed a splendid collection of British and foreign honey, honey goods, wax, and bee appliances in the exhibition. On the opening day Sir Arch. Campbell, Bart., M.P., introduced Mr. Ebenezer McNally to the Prince and Princess of Wales, when he presented the Princess with a handsome case containing several samples of heather and clover honey. Their Royal Highnesses were greatly pleased with the present, and cordially thanked the donor. For collections of bee-flowers, and other kindred objects relating to bee-keeping, he has received

the highest honours at the Crystal Palace in connexion with the Co-operative Festival. He has been a frequent contributor to the *British Bee Journal* for many years. Last year he promoted the West Cumberland Bee-keepers' Association, which held its first exhibition in Harrington, and proved a highly interesting one; he was also on the committee of the proposed Cumberland Association. Several have become successful bee-keepers in this district, who ever found in him one who felt delighted in being able to render a little service

PUNIC BEES.

The Punic virgin queens which we received from England, were noticed on page 167. As there stated, one was dead when received. The other queen was safely introduced, but disappeared before laying—probably lost on her 'wedding trip.' Thus endeth the first experiment.

Dr. C. C. Miller writes to us that he also received two from Mr. John Hewitt, for experiment. Of these, one was lost on her marriage-flight, but the other is now laying. One out of four is a poor percentage.—*American Bee Journal.*

Notices to Correspondents and Inquirers.

Letters or queries asking for addresses of manufacturers or correspondents, or where appliances can be purchased, or replies giving such information, can only be inserted as advertisements. The space devoted to letters, queries, and replies, is meant for the general good of bee-keepers, and not for advertisements. We wish our Correspondents to bear in mind that, as it is necessary for us to go to press in advance of the date of issue, queries cannot always be replied to in the issue immediately following the receipt of their communication. All queries forwarded will be attended to, and those only of personal interest will be answered in this column.

LOUTH.—Of the two samples of sugar sent, we should prefer No. 2 for bee-food.

LINCOLNSHIRE NOVICE.—If your grocer guarantees the sugars sent to be pure cane, it becomes a question of reliability. We certainly think that No. 3 is a beet sugar. The dealer you name is quite trustworthy, but there is, we believe, some difficulty just now in procuring honey jars in quantity.

R. DE B. SAUNDERSON.—1. 'Winter passages' should be cut when packing bees up for winter. 2. With properly prepared food there should be no dysentery at this season.

WM. SCOTT (Hull).—We do not think the sugar sent is genuine Porto Rico. The lump dust will do for bee-food very well.

J. B. BROOKER (Tunbridge).—*Transferring bees to frame hive in autumn.*—If full sheets of foundation are given, and the populations of the two skeps are joined, they will build out the combs if fed liberally, and may make a good stock for next year.

EXCLUDER (Derby).—Next to earthenware or glass, tin is the best material for honey vessels, and does no harm to the honey by contact.

NOVICE (Salisbury).—Honey sent is good in quality, but hardly up to exhibition form, when so much high-class extracted is staged at shows, as has been the rule this year. Only granulated (or crystallised) sugar is suitable for bee-food in autumn. We should not like to guarantee the sample sent as pure cane.

D. W. MELHUISE (Clevedon).—*Feeding up transferred stock.*—If there was no food at all in the combs to which the bees were transferred, not less than twenty pounds of syrup will be required.

C. L. KELLEHER (Cork).—Except being a little uncleanly about hives, earwigs do no harm.

H. E. W. (Highbury).—*Honey granulating.*—The period at which honey granulates varies very much. Some kinds will remain liquid for several months; others become solid in a few days after removal from the combs. To keep it liquid as long as possible, extract when sealed over, jar it, and keep in a warm, dark place.

EAST DULWICH. —From your description of the frames we should say they contain from fourteen to sixteen pounds of food. Give another half-dozen pounds of syrup to make the stock quite safe for winter.

W. BARR (Ewell). You should use a white crystallised sugar, guaranteed by your grocer to be pure cane. The sample sent is not, in our opinion, what it professes to be.

NOTICE.

THE COMMITTEE of the LANCASHIRE AND CHESHIRE BEE-KEEPERS' ASSOCIATION require the Services of a Practical Bee-keeper (who will have to be specially approved by the Committee of the British Bee-keepers' Association), to deliver LECTURES in various districts of LANCASHIRE, to be paid out of the grant of £100 recommended for this purpose by the Technical Instruction Committee of the Lancashire County Council.

Applicants should state terms of remuneration required, and address

THE REV. J. F. BUCKLER,
Bidston Rectory, Birkenhead.

STEAM FACTORY for Bee Appliances.

ORDERS addressed J. ROSS, Stranraer, Wigtownshire, N.B., will be attended to.

THE 'ENGLISH' HIVE.

Transferring Season now on.

TRY THIS HIVE, it is the best in use, and once used will be always used. No more cutting Quilts necessary, as the Bees can be fed from the side of the Hive. See description in *B. B. J.*, August 6th, 1891, p. 351. Price for Floor-board, Body, and Zinc-covered Roof, 11/6 only. The English Wax Extractor, price 7/6.

For particulars apply to A. T. WILMOT, St. Albans.
3149

THIRTEENTH EDITION.

COOK'S MANUAL OF THE APIARY.

New and Enlarged Edition.

CONTAINING 220 ILLUSTRATIONS.

Published at 6s. Reduced to 5s., Post Free.

J. HUCKLE, *British Bee Journal Office*,
Kings Langley, Herts.

BEE SWAX:

Its Economical Uses and Conversion into Money.

By J. DENNLER,

AUTHOR OF 'HONEY AS FOOD,' 'HONEY AND ITS USES,' &c.

Translated from the German, and Edited by

THOS. W. COWAN, Editor of the 'BRITISH BEE JOURNAL.'

Illustrated, price 3½d., Post Free.

'BEE JOURNAL OFFICE,' KINGS LANGLEY, HERTS.

NAPHTHALINE

AND

NAPHTHOL BETA.

Both the above may now be had at the Office of 'THE BRITISH BEE JOURNAL' and 'BEE-KEEPERS' RECORD.'

17 KING WILLIAM STREET, STRAND, LONDON, W.C.
NAPHTHALINE in packets, 6d. post free.

Large packets, containing more than four times the quantity of the smaller ones, 1s. post free.

NAPHTHOL BETA, 1s. a packet, post free.

Instructions for use sent with each packet.

Special prices for quantities.

NOTICE.

NOW READY.

The 11th Edition of

THE BRITISH BEE-KEEPER'S GUIDE-BOOK,

By THOS. WM. COWAN, F.L.S., F.G.S., &c.

Revised and enlarged.

Almost entirely re-written. Much new matter and many fresh illustrations added.

Fcap. 8vo., price 1s. 6d.; or in cloth gilt, 2s. 6d.

Postage, 2d.

To be had of HOULSTON & SONS, Paternoster Sq.; all Hive Dealers, Secretaries of Bee-keepers' Associations, and of J. HUCKLE, *British Bee Journal Office*, Kings Langley, Herts.

Special Prepaid Advertisements.

Situations, Publications, Bee Plants, &c.—Twelve words and under, Sixpence; for every additional Three words, One Penny.

Trade Advertisements not inserted under this head.

WANTED.—1-lb. Sections of Honeycomb, first quality. Prompt Cash. Packages sent. Well-filled Bell Glasses, Frames and Caps purchased. Address Mr. HURST, Bexhill, Sussex. L 24

FOR SALE.—Five Strong Stocks of Bees in Bar-frame Hives, complete, 30s. each. Two Swarms in Skeps, 10s. each. Apply, Rev. E. DAVENPORT, Stourport. L 17

WANTED.—1 lb. Sections, well-filled and clean, and Extracted Honey. Address NTE & SONS, 1 Western Street, Brighton. L 23

WANTED.—Two 5 lb. lots of Driven Bees, healthy, Caruoliens preferred, in Exchange for valuable small foreign Birds, kept in Aviary 12 months. Particulars from O. PUCK, 7 Orchard Street, Walthamstow. L 24

WILL be Sold by Auction, September 30th, at 11 a.m., unless disposed of by Private Contract, at Perry Street Farm, Crayford, Kent. Sixteen excellent Stocks of Bees in mostly new Bar-framed Hives, with Abbott's Cylinder Extractor, and all Bee-farming Tackle. L 25

HALF-GALLON RAPID FEEDER.—Bees can empty twice daily, and cannot drown. Air-tight from outside; now extensively used; simplicity itself; best ever introduced. Price, 1s. 9d.; post free, 2s. Address WATSON, Warton, Carnforth, Lancs. L 27

FOR SALE.—Choice Young Queens. Black, fertile. By return post, 2s. each. Safe arrival guaranteed. Address A. J. CARTER, Newfields, Billingshurst, Sussex. L 29

FOR SALE.—Having had considerable difficulty to obtain suitable Boxes for 1 lb. Sections, and bought larger quantities than required, I shall be pleased to sell at 4s. 6d. per gross, cash with order. Address MARTIN, 4 Woodland Place, Path. L 30

WANTED.—Honey in bulk for Cash. Deposit System. Address THE MELTON SAUCE AND PICKLE COMPANY, LIMITED, Melton Mowbray. L 30

FOR SALE.—Clover Hoeny, 10s. per dozen Sections on rail. Also Blow's Wax Extractor and Boiler, 10s. Address H. LANDER, Wadebridge. L 31

FOR SALE.—200 Screw-capped 1-lb. Bottles. Finest quality 1891 Extracted Honey, 10s. per dozen on rail. Address ERNEST E. DAVIS, Great Bookham, Leatherhead. L 32

FOR SALE.—Fifteen Strong Stocks, guaranteed healthy, in well-made Standard Bar-frame Hives. Foul Brood unknown in district. 25s. each. Address R. TOD, Floore, Weedon. L 33

T. SMITH & Co., Cambridge Street, W., are open to purchase Honey Sections, 4½ x 4½ x 2, of best quality only. L 34

FOR SALE.—Several thousand Limnanthes. Best Spring flower for Bees. 200 Plants for 1s. Address G. EDLINGTON, Lynz Place, Brigg, Lincolnshire. L 35

FOR SALE.—Healthy Driven Bees, 1s. 3d. per lb. Packing box, 6d. Young Queens, 1s. 6d. each. Address E. GARNER, Broom, near Biggleswade, Beds. L 36

FOR SALE.—Five prime Stocks of Black Bees. Two in new Bar-frame Hives, three in Skeps. Strong, healthy, and in good condition for Winter. Free on rail, Reigate, Surrey. For particulars apply to C. T. OVERTON, The Apiaries, Crawley, Sussex. L 37

WANTED to Purchase or Hire, Slides illustrating Bee-keeping. Address FORDEN, Ashcott, Bridgwater. L 38

GUIDE TO SUCCESSFUL BEE-KEEPING, hints free 4½d. Address C. N. WHITE, Somersham, Hunts.

BALDWIN'S is the Oldest Establishment in the United Kingdom wholly devoted to Bees and manufacture of

Bee-keepers' supplies. His prices will compare most favorably with those of any other Maker, while for quality of material, suitability and workmanship, he has no rival.

'Why can he give better value for money than others?' Because he spends less in large 'puffing' advertisements, buys in the best markets for prompt cash, has no rent to pay, and personally conducts his own business.

For prices and full particulars of Goods see Baldwin's Bee-keepers' Instructor (and Illustrated Catalogue combined), which 'contains more practical and reliable hints than all the large, expensive books,' post free for 2d. stamps. Address S. J. BALDWIN, The Apiary, Bromley, Kent. N.B.—More than 500 Silver and Bronze Medals, First and other Prizes, and Testimonials innumerable.

THOMAS LANAWAY & SONS,
Bee Appliance Manufacturers
AND DEALERS,
26 STATION ROAD, REDHILL.
Catalogue post free on application. 2891

J. TREBBLE'S BEE HIVES.

All Machine-made.
My 8/6 COTTAGE HIVE beat all comers.
Awarded Seven Prizes this year. Catalogue free on application to J. TREBBLE, Saw Mills, Romans-leigh, South Molton.

British Bee Journal and Bee-keepers' Record.

OFFICE:
17 KING WILLIAM STREET, STRAND, LONDON, W.C.

PURE CANE SUGARS.

For the accommodation of Bee-keepers, guaranteed Pure Cane Sugar will be supplied in large or small quantities through this office at the under-mentioned rates:—

MOIST. Neat bags, 14-lbs. 2s-lbs. 56-lbs. Cwts.
3. MUSCOVADO 2/7 5/2 10/- 19/6

CRYSTALLISED.
4. DEMERARA }
5. BARBADOS } Crystals 2/9 5/4 10/6 20/6
6. TRINIDAD }

REFINED CANE.
7. WHITE CRYSTALS (Small) 3/0 5/10 11/6 22/6
8, 9. (Medium and Large sizes, 1/- per Cwt. extra.)
10. LUMP (Cut Loaf) ... Boxes, 3/3 6/3 12/3 23/6
11. LUMP DUST 3/ 6/- 11/3 22/9
12. PRESERVING 3/- 6/- 11/9 22/9

FINE.
13. GRANULATED 3/3 6/3 12/3 23/9
14. CASTOR Coarse (15 Fine) 3/9 7/3 14/3 27/9
16. ICING... .. 4/3 8/3 15/9 31/-

All above guaranteed in rade from CANE SUGAR only, and free from BEET, CHEMICALS, etc., etc.

CARRIAGE PAID on Orders over 5/0 (or 28-lbs. Sugar) to London and Suburbs.

COUNTRY ORDERS, not less than 2-cwt. carriage paid at 1/0 per cwt. extra.
(Scotch and Irish orders, special arrangements.)

Cash to be sent with order, and purchasers will please observe that if samples are required or replies asked to inquiries, a stamped addressed envelope must be sent, as we cannot undertake cost of postage.

THE
British Bee Journal,
BEE-KEEPERS' RECORD AND ADVISER.

No. 484. Vol. XIX. N. S. 92.]

OCTOBER 1, 1891.

[Published Weekly

Editorial, Notices, &c.

USEFUL HINTS.

WEATHER.—True to its character for the year '91, the autumn weather of the past fortnight has been erratic, like what has gone before. A week of warmth and sunshine raised the hopes of moor-men, and promised a profitable ending to a very moderate season in the north, when the tremendous storm of wind and rain which burst over Scotland and the northern counties of England changed the whole aspect of things, and put an end to the heather honey-gathering for the year. However, according to reports, in some parts a good week's work was done while the weather held out, and some surplus got, in addition to full winter stores. A fairly good time for winter preparation has followed, the weather being, on the whole, very favourable just now for feeding-up purposes and for general work in the apiary.

AUTUMN WORK.—So far as our own experiences go, and judging by correspondence received, bees have been very well behaved this autumn. No serious mischief by way of robbing has been reported, and if ordinary care is taken until feeding-time is ended and packing down completed, we may hope that in the apiary—as politicians say—'a continuance of peace will be ensured.' To attain this desirable end we must, however, 'be prepared for war.' Moreover, nothing must be done to precipitate hostilities, for a very small beginning may easily develop serious consequences if not nipped in the bud. Feeding bees in autumn may be provocative of any amount of lawlessness among stocks if done in a careless or haphazard fashion, but if well done need cause no upset at all. The bee-keeper should first see that he can feed *safely* from the attacks of outside bees—*i.e.*, that no possible access can be had to the food from

without. Next, that the feeding be done in business fashion; not by giving a pound at a time, but in large vessels, or feeders, holding, if possible, all the food needed at one or, at most, two fillings. The food should be given warm *at dusk*, some trouble being taken to see that the bees get at it without delay. This is best managed by smearing the passage-ways to the food with syrup, and sprinkling a little on the bees to start them feeding. If all is properly managed, before the feeder has been on many minutes the well-known loud buzzing will be heard, and a dozen or more pounds of syrup will be removed below before daylight next morning. If the bee-keeper will trouble to close the entrances of hives being fed before bees begin to stir in the morning, it is well to leave a six-inch entrance during the night, as the taking down of large quantities of food rapidly causes excitement, and makes free ventilation advantageous; but otherwise the entrance had best be reduced to an inch or less when giving the food overnight.

As each colony is fed up to its proper weight, the quilts are arranged, the stock warmly covered down, and the bees left entirely undisturbed till all feeding is done with, and the weather is sufficiently cool to allow of opening hives without the interference of flying bees from other stocks. No 'uniting' and no opening of hives, unless absolutely necessary, should be allowed if the least sign of disturbance is caused by such operations. Then, after all stocks are known to be safely provided with provision for the long winter months, advantage may be taken of a fine day in late autumn to look over the frames of comb, take note of each stock's condition, and finally arrange the hives for wintering.

It is mischievous to a degree to feed stocks intermittantly in autumn, to have 'all going at once,' giving a few ounces of syrup at a time, and be constantly disturbing the bees in doing it. Now that rapid feeders can be had so cheap, or when a

home-made one, holding eight pounds of syrup, can be made, according to a correspondent—whose communication we propose to print next week—for about sixpence, surely there is no need for pottering with small affairs quite unsuited for the purpose.

If, in spite of precautions, robbing becomes troublesome to weak stocks, the assailants may be sprayed with a not too strong solution of carbolic acid and warm water. If a fine spray-diffuser is used, the solution will do no harm to the bees, and it often succeeds in driving the robbers off.

Queens may be introduced up to the end of the month, but in all cases of re-queening a subsequent examination is necessary to make sure the alien queen is safe. Second swarms and swarmed stocks should also be looked over if there is any uncertainty as to their queens being safely mated and laying.

FOUL-BROOD REMEDIES.—Notwithstanding the very plain directions given in our issue of September 10th regarding the above, a correspondent writes suggesting that a more simple form of using Naphthol Beta be given, such as will be easily understood by cottagers and others, who would probably not require to make more than ten pounds of sugar into syrup. The writer says: ‘Don’t you think the cottager would have some difficulty in weighing one drachm of Naphthol Beta?’ To which we reply that if any such difficulty should arise it may be overcome either by asking the village chemist to help him in weighing out the quantity, or, failing that, to *measure it* for himself by covering a sixpence with the acid, once to every pound of sugar, as directed. Our querist then adds: ‘Another difficulty presents itself in mixing the proper quantity of alcohol. You say, “Pour just as much of this upon it as will dissolve it; then shake, and as soon as the Naphthol is dissolved, stop adding the spirit.” Now, may I ask how are they to know the quantity before it is dissolved?’ Our correspondent concludes by suggesting that we give a recipe for preparing N. Beta in the same form as that given for salicylic acid solution, so that it may be prepared and kept in a bottle for use as required.

In reply, it may be said that we have tried to do exactly what is asked—viz., to give instructions for preparing a solution which may be kept ready for use when required. If half an ounce of acid makes a sufficient quantity of the solution to medi-

cate seventy-two pounds of sugar, one-sixth of the whole will suffice for twelve pounds; so it is surely not beyond any cottager’s comprehension to apportion it.

Naphthaline, in the same way, cannot be guaranteed to dissolve in a given time, so we are unable to state, as requested, ‘how often it should be renewed,’ beyond saying that in winter two or three small pieces about the size of a nut will last for several weeks, and there is no ground for apprehension that hives will require to be examined for the purpose of seeing when it needs renewal; a very short experience will decide this. What we impress on readers is to use the preventive in the mild form suggested, whether foul brood exists in the neighbourhood or not. It can do no harm, and will, no doubt, be productive of much good.

BRITISH BEE-KEEPERS’ ASSOCIATION.

A special meeting of the Committee was held at 17 King William Street, Strand, on Wednesday, 23rd inst., to consider the report of the special Sub-Committee appointed at the previous Committee Meeting, to consider and report on the best means of calling the attention of the authorities to the fact that foul brood is to the bee-keeper what pleuro-pneumonia is to the farmer, and, as such, it should be compulsory to report it.

There were present—T. W. Cowan (in the chair), J. Garratt, W. B. Carr, J. M. Hooker, and R. A. Grimshaw.

Letters were read from the Treasurer, Hon. and Rev. H. Bligh, Rev. Dr. Bartrum, W. H. Harris, and W. Lees McClure, regretting their inability to be present.

It was resolved that maps of the several counties be forward to the Secretaries of the affiliated Associations with a request that they would indicate the several localities in which foul brood was known to exist in their districts, and that a pamphlet be supplied to them calculated to give assistance in applying for grants in aid towards teaching technical education in bee-keeping. It was further resolved that subsequently a Special Committee be appointed to bring under the notice of the Minister of Agriculture the desirability of including the number of hives and other information relative to bee-keeping in the annual agricultural returns.

‘GLEANINGS’ AND ITS NEW COVER.

According to our opinion, *Gleanings* had one of the neatest covers of any of the bee-papers; but, not satisfied with this, it has now been changed by Mr. Root, and we must admit that the beauty and lightness of the design is all that could be desired, and is a great improvement upon the old one.

HANDLING HIVES INSTEAD OF FRAMES.

Friend Root,—I was much delighted in reading *Gleanings* for May 1st, p. 388, where I found a letter from Mr. A. F. Brown, and your footnote to it. Yes, you and Mr. B. have undoubtedly hit the point exactly, and never, I think, was a word truer than yours: 'Sooner or later bee-keeping has got to resolve itself into the handling of hives more and frames less.' You say further: 'It may be truthfully said that old bee-keepers do not spend the time they once did over their bees; and we think it is equally true that, as our industry progresses, bee-keepers as a class to-day, or in the near future, will not spend the time over their bees they did a few years ago; in other words, they will get a thousand pounds of honey with less labour.'

Now, friend R., let me tell you why I rejoice over your words. First, those words came from one whose name is known to bee-keepers all over the world; and because you fully know, I believe, what you are speaking of as an authority in bee-matters. Second, because I have fought for that principle to which you give expression in those words nearly as long as I have kept bees in movable-comb hives. Descended from a family which was in the bee-business for generations, I kept bees at first just as did my forefathers in the old Luneburgian straw skeps; and, I may say, with no less success than they. Our crop from 60 to 80 colonies, spring count, which were increased, by swarming and driving, to 180 or 240 colonies, was, in the best seasons, from 3900 to 6000 pounds of honey, and from 50 to 80 pounds of wax—a yield that is to this day not uncommon among our old-fashioned bee-keepers in North Germany, especially in the province of Hanover; and, what is the main thing, they get it at less cost of labour and time than the bee-keepers do to-day with their movable-comb hives.

At the time I became well acquainted with Dzierzon's writings and with himself, I got some Dzierzon and Berlepsch hives, and kept bees in them by way of trial; but I found out something by this new method that did not satisfy me in contrast with the old one. In the course of several years I always got more honey and wax in the old-fashioned way with my old Luneburgian straw skeps than with my accurately constructed and skilfully handled Dzierzon and Berlepsch hives; and last, but not least, with undoubtedly less cost, labour, and time. What was the reason? Not taking into the account that the bees did not do as well in the winter, nor thrive early in the spring in this frame hive, experience soon convinced me that the principal point was, that I could handle my old skeps instead of individual frames, and get a thousand pounds of honey with less labour. Of course, my experience would have prompted me to have abandoned the movable-comb hive totally had I been blind enough to

misunderstand the great advantages of the latter. What was to be done under such circumstances not to fall out of the frying-pan into the fire? All things considered, I thought, How would it be if you combine the great advantages of the Luneburgian straw skep with the superiority of the movable-comb hive? This idea was strengthened by Dzierzon and Berlepsch. Both of them wrote at that time in their works as well as in their *Bienenzeitung* ('Bee Journal'), that, if it were possible to furnish the Luneburgian straw skeps with suitable frames, there would be no better hive than such a one, in regard to wintering bees, rapid increase in the population of colonies in the spring, and, not least, ease in manipulation; but the cylindrical shape and the arched top of the old hive would not permit this. All right, I thought; but why not alter the shape and enlarge the hive to a moderate movable-comb hive? The result of my endeavour was the construction of a hive of which you will find some pictures in *Dadant's Revised Langstroth*. It is this: The old Luneburgian skep with the arched top, only larger, and not in the shape of a cylinder; but by means of this it is furnished with sixteen movable fixed frames, nearly as large as the Langstroth frames. Although Dzierzon, Berlepsch, and other prominent bee-keepers in Germany acknowledge the great value of this hive, it is adopted, with few exceptions, only by such bee-keepers as have kept bees in the old straw skeps, and, therefore, they know by experience the great advantages in handling bees by turning the hive over and manipulating the *whole hive*. On the other hand, this hive has met more vehement opposition than all others. But this is easy to understand. He who has never handled bees in the Luneburgian straw skeps, especially in the rational way like the bee-keepers of North Germany, cannot have the slightest idea of the advantages bees may be handled with in such hives.

The greatest objection to this hive has been the inversion, or turning over, before one can manage the bees; but by doing it in the right way it is not a bit more troublesome than to take off a well-filled super from a Dadant hive. If you have those skeps standing on the ground (as is always the case in America), you do not have to lift the whole hive—only to turn it toward you. Let it first rest on the front edge, then on the front side, and at last on top.

Now, I don't intend to urge any of my brother bee-keepers in America to accept *this* movable straw hive—no, not in the least. Their honey market and other circumstances are different from those in Germany in more than one respect; and, besides that, I am fully aware that the hive used in America is the most suitable one for the wants of the American bee-keepers. But as there is nothing perfect in this world of trouble, and progress must take place everywhere, I am convinced that very decided progress will be put forward in that line which has been pointed out by you, friend

Root, and by Mr. Brown—*handling hives more instead of frames*. How this is to be done in the most suitable way in your country will, no doubt, be shown by American bee-keepers without any assistance from other countries. James Heddon has already taken a great step forward, and other steps of importance to further your idea are, I think, the accession of the fixed Hoffman frames and the movable bottom board.

After these preliminary words let me explain what you, friend Root, and Mr. Brown have advanced a most valuable idea in the bee-keeping world by advocating the handling of hives instead of frames. You will allow me to describe this by referring to the hive, as I lay great stress thereon. American bee-keepers do not think ill of my hive; but I wish to convince them that it is not the production of the writing-table, but the fruit of careful experience, and such a one as has helped me to raise a crop of honey not surpassed by any other bee-keeper in Germany, unless by one of my disciples.

The handling of the hive, and not touching of any of the frames, can be accomplished if the colonies are in a normal condition, as the colony will be if the bee-keeper did his duty at the close of the previous season, and the wintering was good. Of course, there will be exceptions to the rule, but of such I shall speak by-and-by. As for these colonies, the movable comb and handling of frames is of the greatest benefit. I handle hives—1. After the first cleansing flight in the spring. I do not have to remove any warming materials, quilts, nor to open a door, as is necessary with side-opening hives. I simply turn my hive over in the way before mentioned. This gives a most complete view of the interior of the hive, not limited by wide top bars and thick honey-combs, or one single comb, as is the case with German hives. I see how many spaces between the combs are filled with bees, and how large the colony is. No one will deny that an exact knowledge of this is of great importance every time. If the bees come up briskly from a compact cluster below, then I take it for granted the colony is not queenless. Should the bees not sit in a compact cluster, but more scattered between and on the combs, then the colony is most probably queenless. A few puffs from the smoker will drive the bees down. I now let the bright daylight in, and see whether there is brood in the comb or not; and then, should I not see what I wish to, I push aside two combs from those in the middle of the cluster and take them out of the hive to look after the queen or eggs. In the same way I find out how it is with the provisions, providing lifting the hive and weighing it in my hands has not told me what I wish to know. Finding all is right, as a good normal colony always will be, the whole task is done without handling any frames. In less than a minute the hive stands again in its old position—no replacing of a quilt or warming materials, nor a window; no loss of heat from the brood nest, no tearing up of the

nically glued cover to cause a draft of air from the entrance through the cluster of the bees to the top of the hive. If not prevented by loss of time, there is no disturbing the bees by handling frames. To let the bees alone until a time of mild weather would be judicious. The sooner I know the wants of a colony, the sooner I can help. I do not need more than three hours on the day following a cleansing flight to know the minute conditions of hundreds and more of my colonies, besides having swept with a brush the dead bodies and the cappings of the honey cells from the floor-board, saving more than four pounds of wax from a hundred colonies in this way. All colonies that need my further attention (and these are always a considerable part) get one, two, or three sticks on the front side, according as the brood chamber is to be contracted, queenlessness is suspected, or stores are supplied. In these colonies, as exceptions to the rule, I do not avoid handling the frames; on the contrary, in such cases, it is a benefit to help them by means of the movable combs.

I handle only the hives to know whether a colony is on the swarming-point, or fit to swarm artificially. No one will deny that it is of great importance to know this. I simply turn the hive over, give a few whiffs of smoke; and now, as the true working-place of the colony lies open before me, I see whether queen-cells are started, whether there are eggs in them or larvae, or on the point of being capped over, or have reached maturity.

All my hives have a space of from two to three inches beneath the small bottom bars of the frames, as such a space secures a good wintering, and shows me whether a colony is ripe for artificial swarming, or whether I have to extract honey. As soon as I see, by simply turning over, that the bees begin to start combs beneath the bottom bars, I know for certainty that the colony is ripe for artificial swarming, or that I have to take out some capped honey-frames and insert other full combs to be again filled with honey. You see, friend R., the chief point in most cases is to learn the true condition of the colonies without handling frames, covers, quilts, doors, &c.

To Control Comb-building Swarms.—Whether I have given only starters or full foundation, I must always strive to secure perfect combs. Without such combs the movable-comb hive is nonsense, and more objectionable than an old skep or box hive. All my thousands of combs in frames are perfect—not crooked in any way, nor do they show any drone cells where I did not allow them to be built. Therefore, I have no more drones in my hives than I wish. A drone-trap is for me a useless thing, and not to be seen in my apiary,

To avoid faulty combs one must have the easiest control of the comb-building swarms, and that is to be accomplished in the most complete way by turning the hive over, and then one has a view of the actual work-house of the bees. *Here* is performed comb-building,

and *there* is to be seen the busy life of the colony; here are hanging the wax-secreting and comb-building bees. A little smoke and one sees the new combs built on the starters, or the finishing of the foundation. In most cases I remove the beginnings of drone combs, and also regulate crooked combs by a so-called drone-knife—a hooked knife with a long handle. Of course, in some cases, the drone-knife will not do all that is to be done to secure perfect combs; but, then, one may handle one or two frames to do the rest. If I have before me a normal colony, or such a one as has worked according to my wishes, I need not handle a single frame. An inversion of the hive, a few puffs of smoke, a peep at the combs, an inversion of the hive to its normal position, and the work is done in less than a minute.

Now, friend Root, I could point out to you far more advantages in handling hives instead of handling frames, but it may be enough to show of what great importance your and Mr. Brown's suggestions are for the advancement of bee-keeping. As I have said before, I am of the opinion that American bee-keepers will themselves soon find out in what way this is to be carried out with their unsurpassed Langstroth hive, and I should be very glad to learn from them how they in future handle their hives instead of frames.—C. J. H. GRAVENHORST, *Wilsnack, Germany.*—*Bee-keepers' Review.*

Correspondence.

The Editors do not hold themselves responsible for the opinions expressed by correspondents. No notice will be taken of anonymous communications, and correspondents are requested to write on one side of the paper only, and give their real names and addresses, not necessarily for publication, but as a guarantee of good faith. Illustrations should be drawn on separate pieces of paper.

Communications relating to the literary department, reports of Associations, Shows, Meetings, Echoes, Queries, Books for Review, &c., must be addressed only to 'The Editors of the "British Bee Journal," 17 King William Street, Strand, London, W.C.' All business communications relating to Advertisements, &c., must be addressed to Mr. J. HUCKLE, Kings Langley, Herts (see 1st page of Advertisements.)

CURING FOUL BROOD.

[791.] Referring to the article (759, p. 393) in *B. B. J.* for September 3rd, it will no doubt be useful to the readers of your interesting *Journal* to hear the history of the stock of bees and its parent hive mentioned in the above-named article. In the first place, it may be well to mention that from the summer of 1885 to the autumn of 1888 I had been endeavouring to build up a small apiary both by allowing my bees to swarm and by driving bees for cottagers; but, as luck would have it, stock after stock became affected with the dreadful malady, foul brood. They may possibly have caught it by attempted robbings amongst themselves, but more probably by my own foolish manipulations. During these four years I was most successful in all manipulations, but on account of the disease could obtain but little honey.

Thus, in the autumn of 1888, by persuasion,

I allowed all my stocks but one to be destroyed. The one left was a fairly strong colony, with a young queen and plenty of stores for the winter. It turned out strong the following April, and appeared to be rapidly increasing early in May; but soon the disease spread sufficiently to prevent all increase, causing me great disgust at my ill-fortune. Suffice it to say that neighbouring bee-keepers strongly advised me to destroy them.

Many times I read the chapter upon 'Diseases' in Cowan's *Guide-book*, and in the end purchased a small pamphlet entitled, *Foul Brood: the Means of its Propagation and Method of its Cure*, by F. Cheshire. Forthwith, early in June, I commenced the phenolated treatment, but in a peculiar manner.

My first action was to make a swarm of the bees, and so supply them with comb foundation only, reasoning that comb foundation, a clean hive, and clothes, must, under such treatment, be a complete cure; but soon I was again disappointed, for honey was coming in so rapidly that I could in no way pour the medicated syrup into the cells, for they were practically all full, with here and there a cell containing dying or decomposing brood. Finding the bees at the end of July had become fairly strong, I felt sure that there was yet one chance of a perfect cure; therefore, as the *honey-season* was over, I again removed them to a clean hive and foundation, and this time supplied them with a fine young queen in place of the old one, and fed with full-strength phenolated syrup from a bottle over the feed-hole. About a fortnight after this I examined them, and to my delight found them in perfect health, with brood on three frames out of the five they occupied, though they had taken but little of the syrup. In order to get them to store some fifteen to twenty pounds of syrup, I was obliged to reduce the quantity of phenol used to about half. They wintered safely, and the following year, by June 1st, 1890, they covered nine frames. Soon four more were added, then a crate of sections, in which they refused to work, and instead swarmed on July 21st. The swarm being safely hived, I proceeded to examine all the brood combs, and cut out queen-cells; then, after replacing the crate of sections, returned the swarm. They then commenced work in the sections, and by the end of the summer had collected me from thirty to thirty-five pounds of honey, both in sections and the three extra bar-frames.

I left them to winter upon ten frames, with a good quantity of stores; but, unhappily, after the severe frost when the time for bees to fly came round, they discovered a vacated hive of a neighbour, whose bees had died of disease, &c., and appropriated the remaining stores to themselves, together with the fatal spores of disease. The disease spread so rapidly, before I was hardly aware of it, that in order to save infection I drove the whole of the bees into a straw skep, and after tying them up with a piece of cheese-cloth, hung them up in a outhouse.

In about twenty-four hours they would have been placed upon fresh foundation, and fed with syrup containing Naphthol Beta, but they had died, probably from suffocation, caused through the smallness of skep without upward ventilation.

Now, to go back to the stock from which the swarm was taken. It was placed upon a new stand some distance away, and in a few days I added to it a small swarm of bees (about two quarts) with a young queen. By this means, and with the help of phenolated syrup, the disease almost disappeared, so that the bees became crowded upon eight frames by the autumn, with plenty of stores.

Early in the following year I commenced to feed with phenolated syrup, thus causing the bees to increase rapidly. The honey season was very good, and they collected just about thirty pounds in sections. During this time they had no preventive of the disease in the hive other than one piece of camphor, consequently by the autumn many cells contained putrid larvae.

With this stock I intended to do as I had done with the other, but through press of business it was not touched till the following spring, 1891, when they had decreased so as to be unable to cover but little more than three frames. I commenced to feed about the middle of March with phenolated syrup, and by May 1st they still covered only four frames, but the combs were full of brood, principally hatching; thus from this time the colony increased most rapidly. By the end of July they had filled and sealed twenty-two sections, and also two bar-frames, which were placed behind queen-excluder. From the commencement of the honey season till this time, at intervals of eight or nine days, I blew small quantities of naphthaline in at the entrance, and to my surprise when examining the brood combs I found them almost perfect, but still the disease could be discovered in a very few of the cells. About this time, whilst driving bees for a cottager, I was sorry to find the disease in one of his hives. Having driven two lots, including the one diseased, I brought them home, and in order to make a very strong colony, united them to my slightly diseased stock, crowded them upon nine frames of foundation in a fresh hive, and commenced to feed with naphtholised syrup, keeping naphthaline upon the floor-board. They have taken in about twenty-two pounds of syrup, and upon examination I find them still crowded upon nine frames, with a large quantity of sealed stores over and around a good-sized brood nest, which appears to be quite perfect.

I shall examine this hive again before closing down for winter, and report upon its condition.

Bee-keepers will now comprehend that the disease has and can most certainly be cured by the afore-mentioned method. With regard to naphthaline, I feel confident that if perseveringly used it will cause the disease to disappear, but at the same time if old stored pollen remains in the hive, is it not natural that the disease may reappear, for spores are undoubtedly stored in with the pollen?—J. M. LORD.

NOTES BY THE WAY.

[792.] The weather during the past week has come in samples, mostly wet, retarding work in the apiary, though by seizing the opportunities as they occurred I have managed to look through a few hives, introduce a few young queens, and pack up some honey for the coming winter. This is in the home apiary; the out-apiary has still to be attended to, and some painting will have to be done to make the older hives taut for the storms of rain and snow. I do not remember, when giving the final examination to hives at the end of September, to have found so little breeding going on, though most hives have a good quantity of bees, and will go into winter quarters with every prospect of successful wintering. Possibly, with a higher temperature and brighter days, breeding on a small scale may be induced.

The query in your monthly, the *Record*, for October (p. 148), in my opinion answers itself by the appeal to the terms of the schedule in requiring twelve bottles; therefore, if one is broken, there are but eleven, and the unfortunate exhibitor must bear the loss and annoyance of disqualification. If the schedule had required an exhibit of from ten to twenty pounds of honey, not stating the number of vessels it should be shown in, the eleven pounds of honey contained in the eleven bottles would have been eligible to compete. I may say that I have always considered the terms in schedules giving a range of from twelve to twenty pounds in one class as rather ambiguous, and open to different interpretation by different minds. I think a schedule in the present condition of apiculture should be explicit in its terms, and should state the quantity in bottles or sections, giving the size it should be shown in. There are now standard sizes in bottles and sections, and the insistence of show committees on uniformity in sizes will familiarise the British public with the styles and sizes in which British honey is put up; then we shall be technically educating them in the selection of our native produce as opposed to the styles of the foreign stuff that is sold as honey by many grocers, &c. I can fully enter into the feelings of a 'Lancashire Bee-keeper' when he found he was disqualified by having a bottle broken in transit, as I myself fared worse than that at the late Castle Douglas show. In his case he had what satisfaction could be eked out of an accident. In my case I had nothing of the kind; I was like the man in the parable, I fell among thieves. Some one stole one of my bottles of honey, thereby disqualifying my exhibit. The Hon. Secretary, Samaritan-like, telegraphed the loss to me, but there was no time to replace or repair the loss. I trust the thief has an uneasy conscience; possibly it may leak out yet who he is.

I rather pity the writer of Query 628 in *Record*, who has to feed up his bees (as usual, he says), and to hear they fill two or three tiered Woodbury hives. That means twenty or thirty frames. This starts the thought, will these

enormous colonies come out stronger in the spring of '92 than colonies of medium size now? If not, where is the utility of feeding up these large lots? It seems there must be some mismanagement to produce such an army of consumers at the end of the honey harvest. Unless our friend lives in the heather district, his colonies should easily locate themselves on nine, or at most ten, frames by the middle of September, otherwise it means a heavy draught on the stores to keep this army of useless idlers till they die of old age.

Still referring to October *Record*, I notice that some of our friends take exception to Mr. Grimshaw's article (p. 126) on bar-frame hives and the position of frames. For myself, I have some few hives still in the apiary with frames at right angles, but the majority are parallel to the entrance—the style I prefer. After several years' experience with hives standing side by side on both principles, I cannot say positively that either style is *the best as a bee-nest*, though I do say the combination hive for all practical purposes is the hive for me, whether I work for comb or extracted honey. My roofs are made high enough to tier two crates, and I rarely have more on a hive at a time, and where two crates will stand I can place an extracting-box. This, with combs, can easily be removed, and another take its place, with the super-clearer under the full one; and as the covers of my combination hives are not fixed with hinges, but open on two projecting screws in front, I can, if required, use an eke between the body-box and cover. The combination hives give so many facilities not found in the rectangular hives that a little extra first cost is soon repaid by easy working of the various manipulations connected with modern bee-craft, and only those who keep a good number of hives in a small space can appreciate the manifold points in their favour.—W. WOODLEY, *World's End, Newbury.*

SUPER-CLEARERS.

[793.] A correspondent (773, p. 418, in *B. J.* for September 17th) gives his experience with super-clearers, and I think, in justice to the inventor of the cone clearer, I should give our experience with the two kinds, viz., the cone and board. On September 14th, 1891, we had three hives, standing side by side, about three feet apart, from which the surplus boxes had not been removed. Two cones each were fixed to the roofs of Nos. 1 and 2 hives. We began at No. 1, which had a doubling box of fourteen frames and two racks containing forty-eight sections, lifting off the two crates of sections together, slipping crown boards underneath, and removing quilts. No. 2 had two doubling boxes over brood nest, each with fourteen frames, but only one rack of twenty-seven sections, and was treated the same as No. 1. No. 3 had fourteen combs in doubling box, and one rack of fourteen sections, and the board clearer was slipped between crate of sections and box of combs, not disturbing the American cloth on top of sections,

but removing all other covering. In the evening of the same day, which had been dull, with a little rain, we proceeded to remove crates, beginning at No. 3, where at least 300 bees were found remaining in the one crate of sections. After clearing them out we opened No. 2, and found only three bees left. No. 1, with two racks holding forty-eight sections, had but one bee left in it.

On the following morning we began to clear the surplus chambers with frames of honey, proceeding as before, setting crown boards on top of excluders, and removing quilts from tops of frames. No. 3 had its board clearer slipped under the doubling box, as before. This day was also very dull, with some rain. In the evening we went to remove the doubling boxes from No. 3, and found at least half a gallon of bees in the box, so we were obliged to take out the combs one by one, and brush the bees from them in front of hive. Proceeding next to No. 2, there was not a dozen bees left in the two doubling boxes, and in No. 1 there were but four or five bees left. Everything about the apiary as quiet as could be, although the above three hives, as well as several others, had entrances twenty inches wide and from one to one and a half inch deep. These large entrances may be unwise now, but they have been no more than was needed in the honey season, and we shall close them up in a day or two when feeding up for winter, which we shall have to do largely in some cases, as there is very little food in some of the brood chambers. The honey from the above three hives is not extracted yet, but we think there will be about 300 pounds, including sections.

We hope to give you a short account of our season's work in the usual way later on. Some may say that my board clearer is not made right. If so, it may account for its failure; but I bought it from a firm of dealers who are credited with the latest improvements. Mr. Badcock would be doing a lot of good to beekeepers generally if he would give a full description of his board clearer, which only costs two-pence, as mine cost many times that sum. So far as our experience goes, we must speak well of the cone clearer. We never had a board clearer until this year, and although we have used it on other hives before the above-mentioned one with more or less success, still, it has never given us such good results as the cones. Foul brood is still bad round about us, but we manage to steer clear by using camphor, formic and carbolic acid freely.—A. E. W., *Aylesford, Kent.*

BEEES AND HOPS.

[794.] In reply to one of your Kent readers (773, p. 418), I have many times noticed bees working amongst the hops, though not this year, and have always considered that they visited them for the purpose of collecting honey-dew, probably caused by an insect (*Aphis humuli*) in the hop cones. Can this be a correct supposition.—J. MORETON LORD, *Northiam.*

BEE ASSOCIATION FOR SUSSEX.

[795.] Would you kindly allow me, through your columns, to ask my numerous bee-correspondents to notice my change of address? How is it that the county of Sussex has no Bee Association? I should be glad to hear from any who would be willing to become members (if no one else will take the matter up) with a view to forming one before another season. I believe a County Association did at one time exist, but the Committee were not enthusiastic enough to keep it going.—CECIL BRERETON, *Burton Rectory, Pulborough, Sussex.*

THE SEASON IN MID-CORNWALL.

[796.] When I started bee-keeping about ten years ago, I was told that Cornwall was the worst county in England for keeping bees; but, by comparing the reports published in the *Bee Journal* from time to time during the last ten years with my own takes, I am inclined to doubt it. The season of 1888 was with me a failure; I did not get a pound of honey. The season of 1889 gave me an average of 63 pounds per hive from six hives; the season of 1890 gave me an average of 25 pounds per hive; the season of 1891 has given me 525 pounds from seven hives, or an average of 75 pounds per hive—my best, 101 pounds each from two, one of them a stock of Carniolans, and my lowest, 55 pounds. I have only had four swarms in ten years. This year I have had none, not even from my Carniolans. Straw skeps have been very light this season, several bee-keepers having lost late swarms already through starvation. And now, Messrs. Editors, if you can give your readers the part of Mr. Webster's lecture dealing with the re-queening of small apiaries, it would benefit a large number of your readers, including—A CORNISH COTTAGE BEE-KEEPER.

Queries and Replies.

[433.] *Hiving Driven Bees.*—When putting some driven bees into a hive just lately I had some difficulty. I poured them on the top of the frames all right, but soon they began to cluster on a fruit-tree ten yards off, almost all leaving the hive, which, by-the-bye, had combs in all ready for them. I cut off the branch on which they clustered (it being an awkward place to get a skep under the bees), and shook them all into the hive; but again they went off, and settled on another still farther off, where I left them till evening. In the evening I shook them into a skep, and again placed them in the hive, which I now well sweetened. This time they stayed. 1. Can you explain the cause of this? 2. Would bees cluster without a queen? or is it likely that being queenless caused them

to leave the hive? I may say that I have done fairly well this year, having taken ninety pounds from two hives—fifty-three pounds from the one. I am now adding to my stocks. 3. Should I do better with Carniolan bees?—E. P. J., *Wolverhampton.*

REPLY.—1. It is always safer to have driven bees in the evening, and also to avoid 'pouring' the bees from the skep. They should be dislodged by a sudden jerk on to the frames, and a light cloth at once laid over them, or, better still, be thrown out in front of the frame hive, the latter being propped up in front to facilitate their entrance. 2. The bees, queen and all, took wing because they were not properly dealt with under the circumstances. 3. We think not.

[434.] *Foul Brood.*—I have a hive of bees on eight frames, which, I think, have foul brood. I enclose a piece of comb for your inspection. About twenty cells on each side of six combs are affected like what I send you. There are neither grubs nor eggs in the hive, but the frames are fairly well covered with bees. It was a swarm from a skep put in the frame hive on the 21st of June, and the old stock driven out of the skep three weeks afterwards, and united to the swarm, but they have not done much. I have begun to feed with syrup medicated with Naphthol Beta, according to directions, and have put three small pieces of naphthaline in the hive, which I had from you. Will you kindly tell me—1. Is it foul brood? 2. Will it be best to uncup or cut out the cells affected, or not? 3. About how often will the naphthaline want renewing, as I do not want to disturb them more than is necessary during the winter? 4. Will it be best to introduce fresh queen, as I think the present one is very old, or is it too late in the year? I have two more lots in bar-frame hives, and two lots in skeps close by, which have done well, and seem free from disease.—BEGINNER, *Sussex.*

REPLY.—1. Yes, though not in very bad form. 2. As so few cells in each comb are affected, it would not be very difficult to go over them, and, after uncapping, to insert a little powdered naphthaline in each; this will destroy the bacilli. 3. Look in a fortnight, and see if it has gone, and, when this is noted, renew. 4. No. Why do you say 'the queen is very old?' May she not be the young queen added with the bees driven from the parent hive after swarming?

[435.] *Removing Propolis—Bees attacking Horses, &c.*—1. What is the best way to wash off propolis from the hands, and from quilts, &c.? 2. I have read of bees making an attack on horses; will they do the same with cattle, &c.? 3. If bees attack a horse, which is the best way to manage them, and what is the very thing to do in such a case? 4. Do swallows destroy bees? 5. In tying over honey jars, I find the

parchment stiff and ugly to manage; is it necessary to damp it first?

REPLY:—1. Methylated spirit will dissolve propolis, when it may be washed off with warm water and soap. 2. In rare instances, and under peculiar circumstances, they have been known to attack various animals as they do men. 3. The difficulty at first would be less how to manage the bees than the horse, and 'the very thing to do in such a case' would necessarily depend on the case. Now, as the adage says, 'Circumstances alter cases,' and no rule can be laid down which could possibly adapt itself to all the surroundings of a mishap with bees; no more, therefore, can be said than that a horse, if attacked by escaping bees while harnessed to the cart in which they are being conveyed, should be released and removed to a distance with all speed. 4. Swallows practically do no harm to bees. 5. Yes.

[436.] *Balling Queens*.—1. I read that if a hive is over-manipulated, the queen will be balled. How often ought a hive to be looked at? 2. I have a valuable young queen in a hive which I don't want to swarm next season; if I put on supers and three frames of foundation in the brood chamber for them to work on will this stop swarming? 3. How many combs full of honey are required to feed a stock through the winter? 4. If swarms be rehived (as suggested in last week's *Bee Journal*) to the stock hive, won't they swarm again? 5. Which do you prefer, Ligurian or Carniolan bees? 6. Is it necessary to have cork or chaff cushions in winter packing, or will about four thicknesses of carpet be sufficient?—T. O. BENTLER, *Wellington*.

REPLY.—1. There is, no doubt, a tendency on the part of bees—foreign races especially—to 'ball' their queens in spring, and also in autumn, if they are too frequently meddled with, or 'over-manipulated.' The only rule, however, which can be given is to never open a hive unnecessarily, or without some specific reason for doing so; and the less often it is opened the better. 2. No certain method of preventing swarming is known. All plans proposed, including that referred to, only tend to lessen the chances of swarming. 3. Five standard frames 'full of honey' should contain between twenty and twenty-five pounds, and this would suffice. 4. What is the suggestion as to returning swarms to which you refer? 5. Of the two we prefer Carniolans, but the native bee is our favourite. 6. If kept close down the carpet will suffice.

Bee Shows to Come.

October 13th to 16th.—British B.K.A., in connexion with the Dairy Show at the Royal Agricultural Hall, London. All open classes. Entries closed. For schedules apply to Wm. C. Young, Sec., 191 Fleet Street, London.

HINTS.

The *American Apiculturist* says:—'Remove surplus honey from the hives as soon as well capped. This will preserve its snow-white colour. The longer it is left on the hive the darker it will be, as the bees find some way to discolour the capping.'—'When bees swarm out of season, it is generally caused by superseding the queen. If there is trouble with the queen the bees commence to construct cells, and, when capped, usually a swarm issues with the old queen. In some cases the young queen, as soon as she hatches, is allowed to destroy the old one, when no swarm will issue.'

PUNIC (?) BEES.

In the *Revista Apicola*, published in Minorca, we find the following about the so-called Punic bees:—

'An American journal publishes a notice of this variety of bees, calling them "the most marvellous bees in the world." So far as we are able to make out, this much-vaunted variety is none other than what we call the Minorcan bee. It probably comes to us from the north of Africa, hence its history.'

'LATER.—Since writing the above, we notice in the London *British Bee Journal* that a Yankee apiculturist offers for sale queens of the Punic variety (are we to see here an allusion to the proverbial faithlessness of the Carthaginians?) at five pounds sterling each!

'Another dealer of the same enterprising section of the Anglo-Saxon race, a certain Mr. Pratt—we must not omit his name, for surely he has a good chance of being immortalised—asks only the modest sum of eighty pesos—or 400 pesetas (16*l.*). This is practically giving them away!'

CLEANING UP EMPTY COMBS.

Having about a thousand empty combs from which the honey had been extracted, we were desirous of having them cleaned up quickly and put away into the comb closet for the winter, but the bees seemed to think there was no hurry, at any rate they were provokingly slow. The combs were hung in supers and put on top of the hives, and tiered up four and five high, but as a little honey was coming in, it being the latter part of September, the bees would collect the cleanings in the central combs of each super, leaving only the outer combs dry. Finally a large box was procured that would hold four or five dozen Langstroth frames in two tiers. This was set in the rear of a colony and connected with the hive by a tin tube an inch and a half in diameter, and about eight inches long. The box was hung full of combs and covered with a heavy cotton cloth, a board cover to keep out rain being propped up several inches above the cloth. The bees seem to think: 'Well, this is somebody else's storehouse we have got into, and we'll just take what we can get and carry it home.' At any rate, they cleaned up ex-

tractor combs and unfinished sections very rapidly.

The tin tubes are readily made from old fruit cans by unsoldering the joints and rolling the tin about a round stick. They should be a little over size, so that when compressed and put in the holes they will spring out and fit tightly.

We prefer the large box to a stack of supers, as it will hold sections either loose or in the racks, or cappings in shallow boxes, or anything from which we want honey cleaned off by the bees. Two or three of these 'clean-ups' make quick work of the usual fall job of putting away empty combs for the winter. The arrangement is due to the ingenuity of Mr. M. L. Williams.—*PELHAM & WILLIAMS, Maysville, Ky., July 15th, 1891.—Bee-keepers' Review.*

NATURAL HISTORY FROM THE CLASSICS.*

BEEs.

Although of bees, ye know full well,
The Roman poet sings,
It seems to me that Virgil's bees
Were most peculiar things.

Under a spreading olive-tree
His apiary did stand;
His bees—of course, Italian bees—
Each had a golden band.

Some few Cecropian bees—but still,
Whatever be their strain,
Such bees have ne'er been seen before,
Nor ever will again.

Before them flowed a trickling stream,
Whereat the bees did drink;
But frequently they tumbled in
When sipping at the brink.

They lived upon Narcissus' tears
(So he, at least, believes);
Their young they found, poor little dears!
Upon the tender leaves.

For six or seven years these bees
Did carry on their freaks;
But modern bees—'tis strange, but true—
Live six or seven weeks.

In winter-time their life extends,
At most, for half a year;
In summer-time, they work so hard,
That Orcus soon draws near.

Such warlike bees his used to be,
They quite enjoyed a fight;
While Virgil used to 'contemplate'
This elevating sight.

The bees, all eager for the fray,
Keep sharpening their stings,
Until the monarch led the way—
For Virgil's bees had kings.

* Written for the *British Bee Journal*.

And hotly did the battle rage,
Until the royal bee
The 'spolia opima' won,
And then went home to tea.

But in his hives both newts and moths
And lizards used to nap;
Poor man! he sadly needed, too,
A 'Demon' beetle-trap.

His cook once burnt some lobster sauce,
And, as you may suppose,
The smell of burning lobster sauce
Offended Virgil's nose.

But worse than that, it killed the bee,
And Virgil in his grief
Denounced both cook and lobster sauce,
'Thenceforth to live on beef.

He told the cook he didn't like
This lobster-burning plan;
To us he says, 'Don't burn red crabs,'
For 'lobsters' wouldn't scan.

So then he went, and from the herd
He fetched a mighty steer,
And hung it in the stable yard
(There was a wasps' nest near).

And very soon the wasps found out,
And came there by the score;
Hurrah! thought Virgil, this will help
To fill up Georgic IV.

It seemed to him that every day
The wasps came more and more;
And so he said 'that bees were bred
From putrid oxen's gore.'

But whether all he said was right
'Tis not polite to ask;
No doubt poetic licences
Have glorified his task.

Long live the Roman poet's works!
Long live the Georgics three!
Long live the Fourth! and last, not least,
Long live the honey-bee. H. E. W.

Notices to Correspondents and Inquirers.

Letters or queries asking for addresses of manufacturers or correspondents, or where appliances can be purchased, or replies giving such information, can only be inserted as advertisements. The space devoted to letters, queries, and replies, is meant for the general good of bee-keepers, and not for advertisements. We wish our Correspondents to bear in mind that, as it is necessary for us to go to press in advance of the date of issue, queries cannot always be replied to in the issue immediately following the receipt of their communication.

All queries forwarded will be attended to, and those only of personal interest will be answered in this column.

PHILIP J. ASH (Ruthin).—*Extracting Heather Honey.*—The ordinary cylinder extractor is quite useless for extracting heather honey. Some such press as the 'Raitt' is required.

J. PELLY (Wexford).—*Distance Bees will go to Heather.*—It is quite possible the bees travelled three miles if the heather was abundant at that distance.

T. JAMES.—The sample of honey sent is excellent in every respect.

W. FAULKNER (Leamington Spa).—The aroma of honey is peculiar, but, excepting for the minty flavour of 'lime' honey, we cannot detect any other characteristic.

J. QUARTERMAIN.—Of the varieties of heather No. 1 is *Erica cinerea*; 2, *Calluna vulgaris*; 3, *Erica tetralix*. Your robber-preventing entrance is ingenious.

WM. GUDGEON.—We doubt the sugar sent being pure cane. Will your grocer guarantee it? There is no need to use lump sugar; white crystals will do as well.

J. A. A. (Kesh).—*Renewing combs in brood nest.*—1. If sugar sent is guaranteed pure cane it will do very well. 2. Combs should be renewed as often as they become more or less foul and dirty from any cause. If well kept, they may answer well for four or five years, or even longer. 3. If combs want changing, the present is a good time to give combs of honey such as you name.

KERRY (Marlborough).—Write to the firm and make your complaint. If their reply is not satisfactory forward it to us. If the sugars sent are guaranteed pure cane, either will do for bee-feeding.

SOUTH DEVON should observe the rule.

FAR NORTH.—The honey sent is very fair in quality, but hardly up to exhibition form. It has an odour of peppermint—not quite its own, we think—which spoils it for show purposes. The pieces of naphthaline—of which we recommend that two be inserted in each hive for winter—should be about three-eighths or half an inch square. Your other suggestions are noted elsewhere.

J. C. (Middleborough).—Comb sent is badly affected with foul brood.

NOTICE.

THE COMMITTEE of the LANCASHIRE AND CHESHIRE BEE-KEEPERS' ASSOCIATION require the Services of a Practical Bee-keeper (who will have to be specially approved by the Committee of the British Bee-keepers' Association), to deliver LECTURES in various districts of LANCASHIRE, to be paid out of the grant of £100 recommended for this purpose by the Technical Instruction Committee of the Lancashire County Council.

Applicants should state terms of remuneration required, and address

THE REV. J. F. BUCKLER,
Bidston Rectory, Birkenhead.

THE 'ENGLISH' HIVE.

Transferring Season now on.

TRY THIS HIVE, it is the best in use, and once used will be always used. No more cutting Quilts necessary, as the Bees can be fed from the side of the Hive. See description in *B. B. J.*, August 6th, 1891, p. 351. Price for Floor-board, Body, and Zinc-covered Roof, 11/6 only. The English Wax Extractor, price 7/6.

For particulars apply to A. T. WILMOT, St. Albans.
3149

THIRTEENTH EDITION.

COOK'S MANUAL OF THE APIARY.

New and Enlarged Edition.

CONTAINING 220 ILLUSTRATIONS.

Published at 6s. Reduced to 5s., Post Free.

J. HUCKLE, *British Bee Journal Office*,
Kings Langley, Herts.

BEE SWAX:

Its Economical Uses and Conversion into Money.

By J. DENNLER,

AUTHOR OF 'HONEY AS FOOD,' 'HONEY AND ITS USES,' &c.

Translated from the German, and Edited by

THOS. W. COWAN, Editor of the 'BRITISH BEE JOURNAL.'

Illustrated, price 3jd., Post Free.

'BEE JOURNAL OFFICE,' KINGS LANGLEY, HERTS.

NAPHTHALINE

AND

NAPHTHOL BETA.

Both the above may now be had at the Office of 'THE BRITISH BEE JOURNAL' and 'BEE-KEEPERS' RECORD,'

17 KING WILLIAM STREET, STRAND, LONDON, W.C.

NAPHTHALINE in packets, 6d. post free.

Large packets, containing more than four times the quantity of the smaller ones, 1s. post free.

NAPHTHOL BETA, 1s. a packet, post free.

Instructions for use sent with each packet.

Special prices for quantities.

NOW READY.

21st Thousand.

THE BRITISH BEE-KEEPER'S GUIDE-BOOK.

By THOS. WM. COWAN, F.L.S., F.G.S., &c.

Revised and enlarged.

Almost entirely re-written. Much new matter and many fresh illustrations added.

Fcap. 8vo., price 1s. 6d.; or in cloth gilt, 2s. 6d.

Postage, 2d.

To be had of HOULSTON & SONS, Paternoster Sq.; all Hive Dealers, Secretaries of Bee-keepers' Associations, and of J. HUCKLE, *British Bee Journal Office*, Kings Langley, Herts.

Special Prepaid Advertisements.

Situations, Publications, Bee Plants, &c.—Twelve words and under, Sixpence; for every additional Three words, One Penny.

Trade Advertisements not inserted under this head.

WANTED.—1-lb. Sections of Honeycomb, first quality. Prompt Cash. Packages sent. Well-filled Bell Glasses, Frames and Caps purchased. Address Mr. HURST, Bexhill, Sussex. L 242

HALF-GALLON RAPID FEEDER.—Bees can empty twice daily, and cannot drown. Air-tight from outside; now extensively used; simplicity itself; best ever introduced. Price, 1s. 9d.; post free, 2s. Address WATSON, Warton, Carnforth, Lancs. L 27

FOR SALE.—Having had considerable difficulty to obtain suitable Boxes for 1 lb. Sections, and bought larger quantities than required, I shall be pleased to sell at 4s. 6d. per gross, cash with order. Address MARTIN, 4 Woodland Place, Eath. L 34

WANTED.—Honey in bulk for Cash. Deposit System. Address THE MELTON SAUCE AND PICKLE COMPANY, LIMITED, Melton Mowbray. L 30

FOR SALE.—Clover Hoeny, 10s. per dozen Sections on rail. Also Blow's Wax Extractor and Boiler, 10s. Address H. LANDER, Wadebridge. L 31

T. SMITH & Co., 17 Cambridge Street, W., are open to purchase Honey Sections, 4½ x 4½ x 2, of best quality only. L 34

FOR SALE.—Several thousand Limnanthes. Best Spring flower for Bees. 200 Plants for 1s. Address G. EDLINGTON, Lyng Place, Brigg, Lincolnshire. L 35

FOR SALE.—Healthy Driven Bees, 1s. 3d. per lb. Packing box, 6d. Young Queens, 1s. 6d. each. Address E. GARNER, Broom, near Biggleswade, Beds. L 36

FOR SALE.—Five prime Stocks of Black Bees. Two in new Bar-frame Hives, three in Skeps. Strong, healthy, and in good condition for Winter. Free on rail, Reigate, Surrey. For particulars apply to C. T. OVERTON, The Apiaries, Crawley, Sussex. L 37

SPECIAL NOTICE.—Cheap Crocus, 7s. and 8s. 6d. per 1000; per 100, 9d. and 1s. Order at once (scarce). Address W. WILLIS, Elm Dene, Leicester Road, Coventry. L 38

A FEW SKEPS of Pure English Bees for immediate disposal. No reasonable offer refused. Removing. Address REGOR FREDINICK, Bodmin. L 39

FOR SALE.—Healthy Driven Bees and Queens, as advertised last week. Address HOLDEN, Wimborne, Dorset. L 40

WANTED.—One Hundredweight of Sections, and Four Hundredweight of Extracted Honey. Sample and price to W. T. GARNETT, Bee-keeper, Sheffield. L 41

FOR SALE, in consequence of other engagements.—Twenty-five Stocks of English Bees in three-story Frame Hives, fully provisioned for Wintering, with three Sets of worked-out Combs, Frames of Excluder Zinc, Wood Feeders, &c., Can stand till Spring if desired. What offers for the whole, or any part? Apply to J. GREENSILL, Great Wryley, Walsall, Staffs. L 42

OFFERS WANTED for thirteen dozen of Honey in 1-lb. Sections, also four dozen in 1-lb. Glass Jars, good quality. Address S. FOKES, Briantspuddle, Puddletown, Dorset. L 43

FOR SALE.—Seven Stocks of Bees in Bar-frame Hives, 15s. each. Address GEORGE WEBB, North Nibley, near Dursley, Gloucestershire. L 44

I AM uniting Nuclei, and can send Fine 1891 Fertile Queens, per return post, 2s. 6d. each. Safe arrival guaranteed. Address CHAS. WHITING, Valley Apiary, Hundon, Clare, Suffolk. L 45

FOR SALE.—A Strong Stock of Bees in Bar-frame Hive, 18s. Also one in Skep, 10s. 6d. Carriage paid. Address H. NASBEY, Junr., Parson's Street, Banbury. L 46

GUIDE TO SUCCESSFUL BEE-KEEPING, post free 4½d. Address C. N. WHITE, Somersham, Hunts.

BALDWIN'S is the Oldest Establishment in the United Kingdom wholly devoted to Bees and manufacture of

Bee-keepers' supplies. His prices will compare most favourably with those of any other Maker, while for quality of material, suitability and workmanship, he has no rival.

'Why can he give better value for money than others?' Because he spends less in large 'puffing' advertisements, buys in the best markets for prompt cash, has no rent to pay, and personally conducts his own business.

For prices and full particulars of Goods see Baldwin's Bee-keepers' Instructor (and Illustrated Catalogue combined), which 'contains more practical and reliable hints than all the large, expensive books,' post free for 2d. stamps. Address S. J. BALDWIN, The Apiary, Bromley, Kent.

N.B.—More than 500 Silver and Bronze Medals, First and other Prizes, and Testimonials innumerable.

THOMAS LANAWAY & SONS,
Bee Appliance Manufacturers

AND DEALERS,

26 STATION ROAD, REDHILL.

Catalogue post free on application. 2891

STEAM FACTORY for
Bee Appliances.

ORDERS addressed J. ROSS, Stranraer, Wig-townshire, N.B., will be attended to.

British Bee Journal and Bee-keepers' Record.

OFFICE :

17 KING WILLIAM STREET, STRAND, LONDON, W.C.

PURE CANE SUGARS.

For the accommodation of Bee-keepers, guaranteed Pure Cane Sugar will be supplied in large or small quantities through this office at the under-mentioned rates:—

MOIST. Neat bags, 14-lbs. 28-lbs. 56-lbs. Cwts.
3. MUSCOVADO 2/7 5/2 10/- 19/6

CRYSTALLISED.

4. DEMERARA } Crystals 2/9 5/4 10/6 20/6
5. BARBADOS }
6. TRINIDAD }

REFINED CANE.

7. WHITE CRYSTALS (Small) 3/0 5/10 11/6 22/6
8, 9. (Medium and Large sizes, 1/- per Cwt. extra.)
10. LUMP (Cut Loaf) ... Boxes, 3/3 6/3 12/3 23/6
11. LUMP DUST 3/ 6/- 11/9 22/9
12. PRESERVING 3/- 6/- 11/9 22/9

FINE.

13. GRANULATED 3/3 6/3 12/3 23/9
14. CASTOR Coarse (15 Fine) 3/9 7/3 14/3 27/9
16. ICING... .. 4/3 8/3 15/9 31/-

All above guaranteed made from CANE SUGAR only, and free from BEET, CHEMICALS, etc., etc.

CARRIAGE PAID on Orders over 5/0 (or 28-lbs. Sugar) to London and Suburbs.

COUNTRY ORDERS, not less than 2-cwt. carriage paid at 1/0 per cwt. extra.

(Scotch and Irish orders, special arrangements.)

Cash to be sent with order, and purchasers will please observe that if samples are required or replies asked to inquiries, a stamped addressed envelope must be sent, as we cannot undertake cost of postage.

THE
British Bee Journal,
BEE-KEEPERS' RECORD AND ADVISER.

No. 485. Vol. XIX. N.S. 93.]

OCTOBER 8, 1891.

[Published Weekly.]

Editorial, Notices, &c.

HOME-MADE APPLIANCES.

It is, to us, always a sign of a man's aptness for bee-keeping, as well as an encouraging augury of his ultimate success in the pursuit, when he takes kindly to making at least the more simple of his appliances at home. But, except where there is a natural talent for joiner-work, and the amateur can use his tools with some degree of expertness, we do not advise that the bee-keeper should go in for home-made hives and the more important of his appliances at all. Accuracy of fit and good workmanship are of too much importance in bee-work to render it desirable that the use of rough home-made hives should be encouraged; besides, really well-made articles, to suit all tastes and purses, are now so easily obtainable that few are debarred from possessing a few good hives if they desire such. We contend that if the district in which bees are kept, combined with the necessary management requisite to make them profitable, is not such as to enable the bee-keeper to pay for the hives out of the earnings of the bees themselves, he is not warranted in incurring an expenditure himself which, in the ordinary course, cannot possibly be recovered.

Of course these remarks are only intended to apply to bee-keepers who engage in the pursuit with an eye to ultimate profit.

On the other hand, where there chances to be some natural aptitude for carpentry and the necessary nattiness which will ensure accurate workmanship, there is no reason why the bee-keeper possessing these qualifications should not make his own hives and make them well. What we would urge is that a good hive be selected as a pattern to work from, that *inside* measurements be most carefully followed, and that all frames be purchased instead

of using home-made ones. One capital amateur hive-maker we knew of kept a set of *gauge-sticks* for the width, length, and depth of his inside measurements, and would not pass a hive for use if there was more 'play' than about the thirty-second part of an inch. Again, what hives are so well kept as those of the bee-keeper whose own handiwork they are?—they have an interest for him which is entirely absent in a purchased article, and the thoughtful care for the hives usually extends to the bees domiciled in them. Therefore, we may say build your own hives if you are able to make them well; if not, do as we have suggested earlier on, let the bees earn the wherewithal to buy them.

But there is still another class of bee-keepers—in whose proceedings we take a very kindly interest—from whom letters received within the last few days have occasioned the writing of this article. We refer to those who, without having the time, or perhaps not possessing the skill, to make beehives, manage to construct in rough, homely fashion, very useful makeshift appliances of the lesser kind, which answer very well the purpose intended, and save many a shilling to the bee-keeper. One of these writes:—

'I am sending by this post a mustard-box, altered so as to form a feeder for either slow or rapid feeding. For slow feeding, I simply pierce one or more small holes in the middle of the bottom of the trough; if I find I have let it go too fast, I push a peg in one hole, and can so regulate it to a nicety. Of course, for slow feeding, the float is removed, and the bees are not allowed up. I also use them for dry sugar feeding or for odd bits of comb, &c. You will see the boxes require very little altering at all, if the right sort of box is obtained; it is what *penny tins* of Keen's mustard are packed in. Most grocers will sell them for 2d. The lid will furnish enough wood for the end and division, and the glass for lid costs about 3d., so that for about 6d. any one, whether skilled or not, can make a really efficient slow or rapid feeder. Paint them thoroughly inside with

melted wax before using, which prevents the wood absorbing syrup and fermenting. I started with three feeders two years ago, and last winter fed up fourteen stocks with them, all of which lived and came out strong in the spring. If you think a description of it will be useful to your readers, I shall feel thankful to have been of the smallest service to any of our craft, for feeding up must be a large item with many this autumn.—G. N. HOLE, *Patcham, Sussex.*

And sure enough, with the expenditure of a few minutes' labour, a float-feeder holding eight or ten pounds of syrup is constructed, which will serve every purpose. The mustard-box as purchased is $12 \times 8\frac{1}{2} \times 3$ inches. For re-filling, a slip of wood is fixed inside the box, about an inch from one end, flush with the top, but not quite close to the bottom, so that the food flows below. The float is made from the lid, rough slits being cut through the wood on which the bees feed. At the opposite end of box a passage-way for the bees is made by nailing two slips of wood, half an inch wide and same depth as box, on the outside. On these slips a strip of wood same size as end of box is fixed. The end of the box proper, or syrup trough, is then scooped out in its centre about half an inch deep, and the bees can thus pass into the trough. A sheet of glass held in position by slips of tin completes the whole.

If passage-way was provided below for the bees by nailing slips of wood round the bottom of box, so that removal of the quilts when feeding was not absolutely necessary, this feeder would be good enough for any one to whom a few shillings are of consequence.

Another correspondent, Mr. Edward Hancox, of Steeple Aston, Oxford, says:—

‘I have noticed in your valuable *Journal* several opinions and experiences on “super-clearers.” I have taken the liberty of forwarding one to you that I made in a very short time, and have used with the greatest success. I have never seen one sent out from an appliance maker, so cannot say if the one sent is on the same principle. One thing is certain, it can be easily made, and might be sold at a great profit for a shilling. If you think it worth it, I shall be pleased for you to describe it in the *B. J.*’

In this case a stout frame, $17 \times 14\frac{1}{2} \times 1\frac{1}{2}$, has a three-quarter inch platform nailed on its upper edge, in which was bored, with a one and one-eighth inch centre-bit, seven holes. In each of these holes is fixed a tin cone, which projects half an inch

through the platform. This rough home-made super-clearer will no doubt answer its purpose well.

While on this subject we are reminded of a query from ‘C. S.’ (Harringay, N.), who says:—

‘In “Useful Hints” in the *Bee Journal* for the 9th July, 1891, pages 305–6, reference is made to a form of “clearer” which is placed underneath the super, and the bees descend below and cannot again enter the super. I should like to know if a clearer of this type can be made at home without much trouble, and if so, I should be glad to have some particulars as to the construction of same. I am sure the information asked for would be useful to others who, like myself, are bee-keepers in a small way, who make their own hives, and who do not feel justified in incurring the expense of 3s. 6d. or 4s. for one obtained from an appliance dealer.’

To the above we can only say that if ‘C. S.’ will call at our office, 17 King William Street, Strand, we will be pleased to show him the article sent by Mr. Hancox.

Then, again, we have a correspondent declaring that he has made ‘all he wants in the way of super-clearers by investing threepence in a scrap of perforated zinc,’ from which he has made ten cone clearers, and they answer admirably.

It may be said that in encouraging and giving prominence to the use of home-made appliances we are, at all events, not tending to benefit or to improve the prospects of manufacturers of such things. Only a very narrow-minded observer, however, could take this view, for it is obvious that what will help to popularise bee-keeping and assist in arousing the interest of the many in the pursuit, will help to increase the number of bee-keepers whose time and occupation will not admit of their devoting themselves to any hobby in the way referred to. Many are deterred from making a start because of the number of appliances required in modern bee-keeping, and only good to all concerned will ensue if the cost of needful appliances can be reduced as we have indicated.

BRITISH BEE-KEEPERS' ASSOCIATION.

Candidates who have passed a third-class examination, and who purpose to compete for a second-class certificate at the forthcoming examination, which takes place on the 30th and 31st inst., are reminded that Saturday next, 10th inst., is the last day for giving notice of the same to the Secretaries of their Affiliated Association.

RIPENING HONEY.

On visiting a neighbouring bee-keeper a short time ago, I found he was putting his honey into cans for market just as it came from the extractor, and I learn that many bee-keepers in a small way follow the same plan.

The first clover honey from my yard this season was quite thin, although partly sealed before it was extracted. Nearly all extracted honey requires to be evaporated before it is put up for market. In 1883 we had honey sufficiently dense to be ready for market as soon as taken from the hive, but we have not had such honey since. I know much is said about leaving it in the hive until it is partly sealed over, but even then the unsealed honey in the lower part of the combs will probably be only freshly gathered.

Mr. R. McKnight, Owen Sound, Ontario, heats his honey in a large, double-walled tank, the space in the double bottom and walls being filled with water. By means of a faucet passing through both walls, he runs his honey into glass jars, and seals it while hot, the same as is done in preserving fruit. He assures us that honey so treated will remain liquid even when exposed to the severest cold.

All things considered, the best plan for most bee-keepers is to expose the honey to the outer air until it is reduced by evaporation to the proper density. We are obliged to take the atmosphere as we find it, so I shall leave out of the question the humidity of the atmosphere and its pressure, both important factors affecting the rapidity of evaporation, but they are beyond our control. The remaining factors which are within our control to a considerable extent are, first, the extent of surface of honey exposed, and, second, the frequency with which the air in contact with the surface of the honey is changed.

The rate of evaporation is in direct proportion to the extent of the surface exposed. The time required to evaporate 100 pounds of honey, having a surface of two square feet to a given density, is only half as long as is required for the same quantity when the surface is only one square foot, other things being equal.

As to the second factor, when a small quantity of honey is placed in a narrow, deep can, the evaporation will be almost *nil*, because the stratum of air in contact with the honey soon becomes saturated with watery vapour, and evaporation almost ceases, whereas, if the surface of the honey is as high, or nearly as high, as the edge of the can, the movements of the air over the honey are more free, a fresh body of air is constantly being brought in contact with the honey, and evaporation goes on rapidly. For the same reason the ground dries up more quickly after heavy rains, if they are followed by winds.

Applying these principles to the problem in hand, I made three shallow, tin-lined tanks, about three by six feet each, giving an exposed surface of about eighteen square feet for, say,

1000 pounds of honey in full. A frame covered with wire cloth keeps out insects, and a cover keeps out rain, but the latter is put on only at night, and when rain is threatening. Into these tanks the honey is emptied as fast as it is extracted, and it remains exposed to the air and sunshine, sometimes for weeks, before it is packed for market.

But, you ask, How do you know even then that it is ripe enough to be fit for packing? Most people dip the top of the little finger in the honey, stir it around a little, give it a lick, and then pronounce the honey ripe or otherwise as the case may be. This is a very uncertain test, because the apparent thickness or thinness of the honey is very much affected by its temperature. Every honey producer should provide himself with a thermometer and a hydrometer. The latter instrument consists of a stem of glass about as long and thick as a lead pencil, terminated with a bulb loaded with fine shot, so that when the instrument is placed in pure water at 60° it sinks until the upper end of the stem is just a little above the surface of the water, floating at 'nought' on the scale on the stem. The denser the liquid the higher the stem rises above its surface. This is Baume's hydrometer. I have purchased them at an instrument dealer's in Toronto for fifty or sixty cents. To use it, first ascertain that your honey is at a temperature of 60°. Place the instrument floating in the honey, and when it has settled, make a note of the figures on the scale at the surface of the honey.

In the first column below will be found the figures on the scale of the hydrometer, and in the second column the corresponding specific gravity of the honey. To save space I have given the table only from thirty to forty on the scale, this being all that is likely to be necessary for testing honey.

Figures on the Scale.	Corresponding Specific Gravity.
30.....	1.261
31.....	1.272
32.....	1.283
33.....	1.295
34.....	1.307
35.....	1.320
36.....	1.333
37.....	1.346
38.....	1.359
39.....	1.373
40.....	1.386

The authorities are not quite agreed as to which figures should be taken as the standard for ripe honey. Duncan is authority for 1.333, which is, in my opinion, the thinnest honey that should be offered for sale. Mr. Cowan, of the *B.B.J.*, says the specific gravity of sealed clover honey is 1.370, but I don't believe that sealed clover honey is always the same specific gravity. Mr. Cowan says the average is 1.350, and I think he is about right. In such honey the hydrometer would sink to between thirty-seven and thirty-eight on the scale.

There is one observation I have for a long time intended to make, but I have for one reason or another put it off. I intended to fill one of my tanks with freshly extracted honey, keeping account of the weight, and after a couple of weeks weigh it out again to see how many pounds I have lost by evaporation. I have for a long time been convinced that my neighbours sell their water mixed with honey at ten cents per pound, while I send mine off in vapour to make clouds.—S. CORNELL, in *'Bee-keepers' Guide.'*

THE CROSSING OF RACES.

It is known that race plays an important part in agriculture, both in plants and domesticated animals, whether it be horses, sheep, or the bovine race. Points aimed at may be hardness, size or weight, speed, quantity and quality of the wool, abundance of milk. Every observant bee-keeper has not failed to observe the great difference in the character of his hives. Some always populous being constantly active, are always the largest producers; others equally populous, appear very active, but generally only give a very small return. Hence the desire of the bee-keeper to have stocks equally active and good producers. How are we to proceed to arrive at this desirable end? We could without doubt arrive at developing our apiary by selection in breeding from our best stocks; but this demands long and assiduous attention, which, moreover, is not always followed by decided success. Crossing has been thought of as the most rapid means, and it has been the Italian bee that has been chosen for this purpose, in consequence of its beauty and activity. This race when pure does not yield sufficiently good results so long as the queens imported from Italy are still at the head of the colonies, but it becomes very much improved with queens born in the country. However, it is when this race has been crossed by the native race that it yields the finest results, and that it perfectly adapts itself to the climate. It is true one runs the chance of being stung more frequently, which will never be a serious inconvenience to the bee-keeper, for it is thanks to the stings of bees that he will be pretty sure that no citizen will come to take his honey without permission. More recently the Cyprian bee has been tried. This race is active, prolific like the Italians, defending its stores with energy against robbers, and even men. Unfortunately its character is often so diabolical that almost everywhere it has been given up.

The Carniolan race, hardy and very prolific, has seemed to suit our mountainous country better than any other, and it is well known how it is appreciated in Switzerland and in Central Europe. It is true it is given to swarming, but this fault soon becomes lessened, and it does not defend itself sufficiently against robbers. As the bees of this race are large and very mild tempered, I thought that crossed with the Italian they would yield a product of superior quality. This trial

has quite answered my expectations. The hives inhabited by these hybrids have been and are still by far the best in my apiary. They work regularly and assiduously. These bees are handsome, very hardy, and of a resolute character: they do not tolerate robbing, and are not too much inclined to swarm. As after some years they become intercrossed with the common bee of the country, it is necessary to begin again with hives of the pure races.—M. DESCOULAYES, in *'Revue Internationale.'*

DERBYSHIRE BEE-KEEPERS' ASSOCIATION EXHIBITION.

The tenth annual show of the Derbyshire Bee-keepers' Association was held in a large tent on the show-ground, near the Free Baths, on the 9th and 10th September. The weather, from a honey-producing point of view, has been most unfortunate this season, particularly at that period when the bee-keeper naturally hopes to reap an abundant harvest in return for the care and attention he has spent on his bees during the winter and spring. In spite of the adverse season, Mr. Atkins, the energetic secretary of the Derby Bee-keepers' Association, was enabled to stage a by no means unimportant display of good honey. The entries were about equal in number to those of the preceding year, and the exhibits were of exceptional merit. The judge was Mr. C. N. White, of Somersham, Huntingdonshire. The various exhibits of bees, both English and foreign, came in for a large share of attention, and the premier position for section honey was taken by Mr. T. W. Jones, of Etwall. This exhibitor also took the first prize for an artistic exhibit of comb honey, in sections. The second prize exhibit in the same class was a super, composed of wood and glass, belonging to Mr. Stone, of Cubley, weighing sixty and a half pounds nett, gathered by a stock of Carniolans. This exhibit would, in the opinion of the judge, have taken the silver medal of the D.B.K.A. had not such a capital lot of sections been shown in competition with the non-sectional honey. Run or extracted honey formed a large class, but the quality, except in one or two cases, was not nearly equal to that of previous years. For the success of the show the members are greatly indebted to Mr. Atkins, not only for the great interest he has taken in the spread of bee-culture, but also for the indefatigable manner in which he labours to ensure the interest and sympathy of non-members in the county. The following were the awards:—

Class 1. English bees.—1st prize, J. Clarke, Loscoe; 2nd, C. Clarke, Loscoe Grange.

Class 2. Best stock of foreign bees.—1st, C. Clarke; 2nd, C. Wootton, Draycott; 3rd, J. Stone, Little Cubley.

Class 3. For the best twelve sections of honey.—1st, T. W. Jones, Etwall.

Class 4. For the best exhibit of comb honey.—1st, T. W. Jones; 2nd, J. Stone; 3rd, T. E. Poxon, Lockington. The Derbyshire Medal in

this class was awarded to Mr. Jones, but he having obtained the British B.K.A. silver medal, the judges considered that the Derbyshire medal should be awarded to Mr. Stone, the next best exhibitor.

Class 5. For the best glass bottle or jar of run honey.—1st, Mr. Poxon; 2nd, W. T. Atkins, North Street, Derby; 3rd, J. B. Mart, Duffield; 4th, Mr. Poxon.

Class 6. For the best jar of run honey, not less than twelve pounds.—1st, J. B. Bridges, Harstoft; 2nd, S. Turton, Horsley Woodhouse; 3rd, R. Bridges, Harstoft; 4th, J. Pearman, Chaddesden.

Class 7. For selling honey classes.—1st, A. Cooper, Sunny Hill; 2nd, S. Turton; 3rd, W. T. Atkins; 4th, C. Wootton.

There were three wax selling classes, the first being for members paying a subscription of 5s. annually. In this class the result was:—1st, J. Stone, Cubley; 2nd, Mr. Poxon, Lockington.

The next class was for those members who are cottagers, and paying a subscription of 2s. 6d. per annum. In this class J. B. Bridges and R. Bridges were equal.

Class 11 (open to all England) was for the best frame hive, the prize being won by Mr. C. Redshaw, of South Wigston, who also won the prizes offered for the best hive, not to exceed 10s. 6d. in value, and for best section crate.

The only prize offered in Class 16, for specialties, was carried off by Mr. W. Griffin.

BEES AT THE WETHERBY AGRICULTURAL SOCIETY'S SHOW.

A show of honey and bee-appliances took place in connexion with the above, at which the Rev. J. W. Geldart, in proposing 'The Judges,' said that from what they knew of the Royal Agricultural Benefit Society at Kirk Deighton, in consequence of having had a harvest festival collection for it, they could testify that it appeared to be well managed, and thoroughly deserving of encouragement. He proceeded to say that it might not be known to many that he was by far the largest exhibitor of live stock at the show, his stock there present amounting to some thousands! It was true they were a small breed, but, on the other hand, they required no keep for three-quarters of the year, and even in such a season as this had given much profitable produce. In conclusion, he urged farmers, and especially cottagers, though they might have only a small garden, to add to their other sources of profit that of bee-keeping, on the humane and successful system advocated by the Bee-keeping Associations. He stated that Mr. W. Dixon, of Belmont House, Beckett Street, Leeds, was present as a representative of the Yorkshire Bee-keepers' Association, and would give an exhibition in the Society's tent, and supply any further information that might be needed then or afterwards.

Mr. Robson responded in suitable terms.

Mr. E. H. Coates, of Wetherby, judged the honey and bee-appliances, and made the following awards:—

List of Awards.

Special prizes offered by the Rev. J. W. Geldart, rector of Kirk Deighton:—

Ten pounds of honey, in 1-lb. or 2-lb. sections (produced within ten miles of Wetherby).—1st prize, Mrs. H. Dixon, Pannal; 2nd, Lady Hawke, Wighill Park.

Ten pounds of run honey in glass bottles (produced within ten miles of Wetherby).—1st, Lady Hawke; 2nd, R. Upton, Prospect Place, Tadcaster.

Cottage hive, on the bar-frame system (selling price not exceeding 10s. 6d.).—1st, T. Rothery, Prospect Place, Tadcaster; 2nd, W. Dixon, Leeds.

Collection of bee-furniture and appliances (exclusive of hive).—1st, W. Dixon.

Bee Shows to Come.

October 13th to 16th.—British B.K.A., in connexion with the Dairy Show at the Royal Agricultural Hall, London. All open classes. Entries closed. For schedules apply to Wm. C. Young, Sec., 191 Fleet Street, London.

Correspondence.

The Editors do not hold themselves responsible for the opinions expressed by correspondents. No notice will be taken of anonymous communications, and correspondents are requested to write on one side of the paper only, and give their real names and addresses, not necessarily for publication, but as a guarantee of good faith. Illustrations should be drawn on separate pieces of paper.

Communications relating to the literary department reports of Associations, Shows, Meetings, Echoes, Queries, Books for Review, &c., must be addressed only to 'The Editors of the "British Bee Journal," 17 King William Street, Strand, London, W.C.' All business communications relating to Advertisements, &c., must be addressed to Mr. J. HUCKLE, Kings Langley, Herts (see 1st page of Advertisements).

* * * In order to facilitate reference, Correspondents, when speaking of any letter or query previously inserted, will oblige by mentioning the number of the letter, as well as the page on which it appears.

NEW TWIN DOVETAIL HIVE.

[797.] Having seen this hive at the 'Royal' Show at Doncaster, I was interested in its novel construction. I think it has been a long-wanted hive. With the twin dovetail it appears it can be easily taken to pieces, and such portions as the surplus boxes stowed away in winter. It seems to have a still greater advantage, as it should make all joints perfectly air-tight, and I noticed that the roof was constructed in such a way as to make that part perfectly water-tight, and the timber could give and take with the weather, and therefore prevent the warping and cracking which so often happens in nailed hives. Speaking for myself, I have never had a hive-roof yet but what has leaked more or less, no matter how much painted. I would like to

know, Mr. Editor, what has become of this hive, for after looking over the *Bee Journal* each week and the prize lists at shows, I have not seen it once mentioned. Surely a silver medal at the 'Royal' should have taken first or second at all shows in the novelty classes. In the report of the show in the *Bee Journal* it was said to be 'the most ambitious exhibit in its class;' but I think Mr. Harbordt has not been so ambitious as a good many of our appliance dealers, or we would have seen more of it during the season. I would like to know where this hive is to be had, as I intend having some of them next season, and I find there is no such name as Harbordt advertised in your *Journal*. It would also be interesting to know the opinion of other bee-keepers who saw it at the 'Royal' Show.—A MID-CHESHIRE BEE-KEEPER, *Tarporley, September 21st.*

[The exhibitor of the hive referred to is obviously the best judge of the proper time to place it on the market, and when that time comes he will probably advertise it in the usual course.—Eds.]

NOTES FROM SOUTH DEVON.

[798.] What a sad and miserable summer we have had for our poor pets—rain, rain; if not rain, then wind, almost every day, with only one spell of real, bright, summer sunshine! I think from the reports that I read in your valuable *Journal* that we have been even worse off than our more northern friends. The yield of honey in this part of Devonshire and all round the grand heather country of Dartmoor must be small indeed. The poor farmers on the highlands have not saved either their hay or corn.

I hear from neighbours and find that in my own hives the bees are strong. Not having been able to work for so long there are no worn-out wings; in most cases the frames are well stocked with food, and little or no feeding is required; but, alas! the supers are a failure (we can't work run honey, there being so much heather about), the sections being in most cases only partially filled and badly sealed. There are, unfortunately, several cases of foul brood in the neighbourhood, but it is to be hoped with the new remedies that you have so prominently brought before the bee-keeper, we shall soon be able to eradicate this evil. I hope next autumn that I shall be able to give you a more satisfactory report from this, one of the most prolific honey-producing counties.

It is an old and a true saying that Devon, but more particularly Dartmoor, is 'a generation behind the rest of the world.' Bee-keeping in no way belies the truth of the saying. There are some few that use the bar-frame in and about the towns, but in the country the straw skep is to the fore, so much so that the 19th of September is set apart as the day on which they are 'burnt,' as they call it about here. As far as I am able to ascertain very few farmers and a less number of cottagers keep bees. If you suggest to them the desirability of doing so (of

course, in bar-frames), they say, 'I don't understand the likes of them things, and they cost so much,' &c. The Devonshire farmer is not a man easily persuaded or talked over.

I have not yet heard that the Devon County Council have granted any money for instruction in bee-keeping, nor do I know the name or existence of any Society in Devon to which it could be given. If there is such it does not make much noise abroad, as I have lived over twenty years in South Devon and have not seen, nor do I remember even hearing of, a honey show being held, at least in these parts. Truly, I have only been interested in bees about two years, and have not until that time looked for reports and shows; but most certainly had they been frequent and been brought forward prominently, I must have heard or seen something of them.—E. W. C., *Ashburton.*

SPECIAL QUERY.

DISQUALIFYING EXHIBITS.

[799.] A schedule calls for twelve bottles of honey from ten to twenty pounds in weight to be staged. Twelve bottles are sent by a party, per rail, to the show-ground; eleven only can be staged, the twelfth being smashed in transit. The honey is in the case with the broken bottle on arrival, and there is no doubt it is the same quality of honey as the other eleven bottles. Should the eleven bottles be allowed to compete? There seems to be a great diversity of opinion on the matter, and as no other method of settling the question occurs to me, I suggest that the subject should be put as a query in the *Bee Journal*, and request yourself and readers interested in the subject to reply.—A LANCASHIRE BEE-KEEPER.

[We shall be glad to receive the views of readers on the above. Personally we think that judges have no option but to adhere to the wording of the schedule, and if less than twelve bottles are staged the exhibit cannot compete. If it were otherwise, no end of difficulties would arise regarding breakages. It is easy to pack honey safely if care is taken, and exhibitors are bound to take the consequences of their own carelessness if breakages occur. Railway companies may be responsible for breakage; exhibition committees are not.—Eds.]

CASTLE DOUGLAS SHOW, 1891.

[800.] I beg to thank my numerous bee-keeping friends throughout the United Kingdom who have written me letters of congratulation at my success at the above show. While I am gratified at the friendly expressions contained in many of the letters I have received, I wish to say I have no desire or ambition to be 'dubbed' the champion of the world. I have only endeavoured to prove that the Irish nectar, so named by the ex-champion (Mr. Rae) last year, has held its own fully amongst fifty-one entries this year, and has won me the honour of being the first to have my name engraved on

the silver medal. This notice through the *B. B. J.* will, I trust, suffice as a reply to all who have written me on the above subject.—**JOHN D. McNALLY.**

DESTROYING A HORNETS' NEST.

[801.] A few weeks ago a friend and I destroyed a very strong hornets' nest in the following manner. We carefully cut away the boughs of the tree, and after the hornets were settled, enclosed it in a bag, and cut the bough away on which it was hanging. We then placed it in a bucket and poured boiling water on to it. In passing that way a week or two afterwards, judge of my surprise to find that they were building another nest. Evidently some of the insects had been on the wing, although we saw none, and it was then nearly dark. The second nest was about as large as an orange. I cut it off with my pocket-knife, and found that it contained brood in different stages. How had the queen escaped from the first nest? or, would they be drones hatched from the eggs of a fertile worker?—**FAR NORTH.**

[Colonies of hornets usually have several queens, which, of course, explains the case.—**Eds.**]

BEEES FOR SOUTH AFRICA.

[802.] Having taken a great interest in apiculture for many years, I am honoured with an office to supply my fellow bee-keepers with advice, &c., and have no difficulty in doing so for this district. But an outsider crops up occasionally, and in this case my querist is from Natal, South Africa.

Having had a little English tuition, he is very desirous of becoming a successful South African bee-keeper, and, being home here on a visit, would like to take back some civilised bees. Can you give me a few hints as to their transit? also whether there is a dealer in bee-keepers' appliances at Durban?

The gentleman I refer to informs me that at Natal he captured a runaway swarm in a straw skep, but the bees, after working busily for two days, all left the hive. Again, an old bee-nest was found in a hollow tree, and this tree had its upper part cut off, the lower portion, where the bees were, being afterwards fitted with flight-board, &c., and placed on a stand near the house. But these also left the tree, leaving behind brood and honey.

It appears there are people who keep bees out there, but from some unknown cause the bees will sometimes attack and severely sting anything that might cross their path.—**JAMES BROWN, Court Farm, Failand, Bristol.**

[The most that can be done is to take queens with a few bees in specially prepared travelling cages. Stocks of bees cannot be safely conveyed to South Africa unless packed by experienced hands, and sent in charge of some one who understands them.—**Eds.**]

BEE-KEEPING IN MIDDLESEX.

[803.] I have often been told that bees cannot be kept with profit in Middlesex, but I think the following result of my experience this year is far from discouraging, and possibly many of your readers can show even a better record. I have four hives only, viz., a Sandringham, an ordinary bar-framed hive, and two makeshifts composed of skeps with box on top. On July 1st, I had an immense swarm which I unfortunately lost.

No. 1, hive, 'Sandringham,' 21 1-lb. sections; 45 lbs. run=66 lbs.

No. 2, 'Makeshift,' 8 1-lb. sections; 23 lbs. run=31 lbs.

No. 3, 'Makeshift,' 64 lbs run=64 lbs.

No. 4, 'Bar-framed hive,' 49 1-lb. sections =49 lbs. Total, 210 lbs.—**THOMAS DELL, St. Bees, Roxboro' Road, Harrow, October 5th.**

POISONOUS HONEY PLANTS.

[804.] I have heard from a friend of mine on the River Congo that he cannot keep bees out there on account of there being a great many Euphorbia plants growing near his house, the honey derived from which is very poisonous. Are there any British plants the honey from which is poisonous to human beings? If so, how is it that it is not also poisonous to the bees themselves? My friend also says that the Congo bees are much smaller than our common English bee, some being no larger than about half the size of an ordinary house fly, and yet veritable bees, building honey-comb with very small cells.—**E. E. C., Reading.**

[Of British honey-producing plants, Yellow Jasmine and Rhododendron are both poisonous, but so many other honey-plants flower concurrently with the above that no harm is done.—**Eds.**]

HONEY IMPORTS.

The total value of honey imported into the United Kingdom during the month of September, 1891, was 1422l.—*From a return furnished by the Statistical Office, H.M. Customs.*

WEATHER REPORT.

WESTBOURNE, SUSSEX.—September, 1891.

Maximum .. 72° on 12th.	Rain:—1.34 in.
Minimum .. 39° on 28th.	Heaviest fall, .31 on
Min. on grass 30° on 30th.	21st.
Mean maximum 62°.	Rain on 15 days.
Mean minimum 49°.	Average, 1.80 in.
Mean temperature. .55.5°.	Sunshine, 165.85 hs.
	Brightest day, 12th,
	12.20.
	Sunless days, 2.

Remarks.—There has been some sun nearly every day, and the autumn flowers have yielded well. All hives strong, and well provided for the winter. There has been much robbing among the cottagers' bees.—**L. B. BIRKETT.**

Queries and Replies.

[437.] Being a reader of the *B. J.* and a beginner in bee-keeping on modern principles, I take the liberty of asking you the following questions. I have four bar hives, each containing eight frames, with about three inches of sealed honey-comb, the rest being empty except for some small patches of brood. 1. Should I contract the hive to seven frames and feed up, or would the bees live on them as they are? 2. One of them has drones flying; is this a sign of queenlessness, or is it common at this time of the year? 3. I also have a skep with drones flying; it is two years old, and swarmed this year. Do you think it is queenlessness, too? If so, will it be too late to re-queen them by the time I receive the *Journal* on October 10th?—AMATEUR, *Darnaway*.

REPLY.—1. The bees may be left on the eight frames. 2. Drones at this season are a sure sign of either queenlessness or a drone-breeder. 3. Stocks may be re-queened up to the end of the month.

[438.] *Clover Honey Granulating*.—In about how short a time would best clover honey in a tin containing twenty-nine pounds, and kept in a cool place, granulate? The honey was extracted from virgin comb only. My reason for asking the question is this: A chemist to whom I sold my honey kept a tin of the above description for over three weeks in a cool place (I believe in a cellar), and found it then granulated. He refuses to pay the balance of my account, and says the tin contained *old* honey, whereas I have not had an ounce of old honey in my possession this year. As it is a matter affecting my moral character I may be compelled to take it into court, and should be glad to have the answer in the *Bee Journal*, to produce if necessary.—T. J. AMBROSE, *Pershore*.

REPLY.—We cannot fix a date at which honey will granulate, as it varies in different seasons. There is, however, nothing at all unusual in honey granulating under the circumstances detailed above.

[439.] *Bees in Hive Roof*.—I have been a bee-keeper now for some years, on the old skep system, killing the bees to get their honey. However, last winter all my bees died, and I bought a swarm on the 3rd of June last, from which I have taken about twelve pounds of honey in straw supers. This autumn I have bought four stocks of bees, one of which is in a frame hive, but as the man from whom I bought them did not understand the arrangement of frame hives, he allowed the bees to get up into roof of the hive, and it is all stuck together, so that I cannot get the top off. There must a lot of honey in, as it weighs nearly a hundredweight. The bees have sealed up all the ventilating holes in the roof. My object in writing is to ask what I can do to remedy this

state of things without killing the bees? I have become a subscriber to the *B. J.*, and want to become a bee-keeper on the modern system. A word of advice as to what should be done with the other four stocks would be gratefully received. I think I could make some bar-frame hives, if I can get to see the inside of the one I have got for a pattern.—G. JORDAN, *Oxon*, October 1st.

REPLY.—It is not possible to do anything without the removal of the roof. You had better, therefore, make an attempt to prise it up by main force, and take the risk of some small breakage of the combs. It is not likely that any serious mishap will occur if the top bars are covered, as they probably are. It would be advisable to have the help of an experience bee-keeper, if convenient. If the skeps you refer to are heavy, say, thirty to thirty-five pounds gross, they will require nothing beyond protection from wet and cold until March next.

[440.] *Keeping Bees and Fowls in Orchards*.—Has any instance come under your notice of bees (pure natives) attacking fowls? My bees stand in a large orchard, perhaps fifty yards by forty, with any amount of bush-fruit, apple-trees, raspberries, &c. Do you think I might keep fowls without fencing my hives round to keep the fowls away from them? Of course, I would take precautions at such times as when honey was being taken, &c. I don't want to wire unless absolutely necessary.—LINCOLNSHIRE NOVICE.

REPLY.—We have only known of damage being done to fowls by bees when gross carelessness has been displayed by the bee-keeper. Under the circumstances named, and in careful hands, as we judge yours to be, there would be no risk.

[441.] *Uniting Stocks in Autumn*.—*Feeding-up*.—I started this year with one stock in a straw skep. On June 17th the bees swarmed, and were hived in a bar-frame hive; on July 11th a friend drove the bees out of the skep for me, and they were also put into a frame; so now I have two frame hives. About a month ago the swarm had ten frames full with honey and brood, and the driven lot had seven frames, but very little brood or honey; so I gave them one of the centre frames out of the stronger hive, in order to strengthen them. On looking lately, however, I found them rather badly off. The swarm has now nine frames, with about two or three inches of honey from the top bar downwards. The other hive has not got more than eight or nine pounds of honey. 1. Will it be best to unite the two lots, so as to make one strong lot? There would be enough bees to cover about twelve frames in the two lots. Of course, I would rather start next year with two lots instead of one, if it can be done, as I am wanting to increase the number of stocks. When I started this year I knew nothing about bees at

all, but with the help of the *B.B.J.*, which I have every week, I hope to get on better next year. 2. If the bees want feeding, how shall I proceed? Also, (3) when is the time to pack them for winter? During the last two or three days the bees have been fighting very much.—**ONE WHO WISHES TO SUCCEED, North Cray, Kent.**

REPLY.—1. Under the circumstances, we should advise you to winter both stocks as they now stand. So long as you know the young queen of the driven lot is mated and laying, there is no reason why the two lots should be united. 2. The top swarm, according to your account, should have at least twenty-five pounds of honey in the nine combs, and this will suffice. The other will want fully fifteen pounds of syrup, and it should be given at once. For instructions, read 'Useful Hints' in our last number. 3. Bees should be packed up for winter ere this, so no time must be lost.

[442.] *Using Naphthaline—Moving Bees.*—1. Do you advise the naphthaline, in cases of foul brood and suspected cases, to be continued through the winter? I mean, is it advisable to open the hive, say, once a month, to replace the naphthaline? 2. Will you also advise me the best way to pack a dozen hives for removal by road about fifteen miles, at or about Christmas? Would it be better to wait until spring? It is with respect to the ventilation that I am in doubt; of course, I know all about making everything tight and fast.—**Edw. H. Cox, Ashburton.**

REPLY.—1. Refer to 'Useful Hints' in last week's issue for reply to first query. 2. There should be little risk in removing bees at Christmas-time if the weather is frosty. If the entrance is opened full width, and perforated zinc is nailed over it, nothing more is required beyond making 'everything tight and fast.'

Echoes from the Hives.

Brondesbury, October 1st.—This has been the best year since 1885 for my Cockney bees, and the only year since 1886 that I have had any appreciable quantity of clover honey. The early part of the season was fairly good, but there was a splendid flow of clover and lime honey in July in spite of the increasing bricks and mortar. From one hive I have taken 108 sections and about ten pounds of other honey. In this hive I had twelve standard frames, with ten shallow frames below and three racks of sections above. In my other hive (I confine myself to two) I have had twenty-six frames (four with starters), and I have taken from it seventy pounds of extracted honey. I expect to get about twenty pounds more, as I have not yet reduced it for the winter. I have had no swarms, although my bees have some Carniolan blood.—**T. F. L.**

BEES AND FRUIT.

I have been keeping bees alongside of my fruit orchard for twelve years. I grow peaches, prunes, apples, almonds, pears, oranges, lemons, limes, and olives. All of my fruit commands tip-top prices when put on the market, and none of my customers have complained that the fruit was injured or hurt by my bees. I find that wasps, yellow-jackets, and birds will pick holes in most kinds of fruit, and the bees will follow them as soon as fermentation commences in the injured fruit, and very often where fruit is injured and over-ripe the bees utilise most of it, sometimes taking all but the pit and skin. But I am glad they can utilise it, for decayed and injured fruit ought not to be sold by anybody.

The honey produced by my bees is worth more gold coin than my fruit crop, and I believe in getting all one can out of any industry, and letting the best survive. So I say go in little bee, get what you can, and after awhile we will divide profits. I want both fruit and bees; they seem to fit in together so nicely. But many fruit-growers seem to think it the great mission of their lives to fight and quarrel with the busy bee, and they go to such lengths sometimes as to kill the bees.

We heard of a fruit-grower not many miles from Los Angeles who hired a man at two dollars a day and board to work a plank bee-trap during the summer, who boasted that his man could crush two bushels of bees in a day with his plank trap. Yet the Society to Prevent Cruelty to Animals never looked after the matter. Since then that man has had scale-bugs on his trees until life was a weariness to him, and we believe he has a few with him yet.

We find in our exchanges many articles touching the ability of the bees to puncture fruit: others, again, produce the testimony of official scientists, who declare that the bee cannot and does not injure sound fruit of any kind; that it is of great benefit to the orchardists by reason of its carrying pollen and distributing it among the bloom of fruit-trees at the proper season, fructifying what would, without their aid, prove barren and useless bloom.

The gardeners never complain of bees; in fact, most of them recognise the bee as a very useful friend. An exchange furnishes an exhaustive, unanswerable article on behalf of the bee that ought to settle the question beyond the realm of controversy.

In a recent issue of the *Hanford Sentinel*, G. W. Camp gives the following regarding the ever-recurring question, 'Do bees injure fruit?' Mr. Oliver Smith informed me that the bees carried off a tray of raisins per day from his vineyard. He did not say whether they brought the trays back or not, but two of his neighbours told me that they saw the road near his place covered with bees carrying off his raisins. The bees were walking on their hind legs, and each one had a raisin between its fore claws, and this is given as proof that they are enemies of the fruit-growers.

Should any one who says bees bite the raisins take the pains to examine a bee with a microscope while feeding, he will be surprised to learn that a bee has no biter, but has only a slender and a limber proboscis, that is as small as our finest needle, and through the hollow of this proboscis it can only take liquid food, and through it all the honey gathered has to pass. Will bees injure raisins? is the question. I say they will not. I know there are many who dispute this, and claim they have seen grapes eaten by them. Those who make this assertion are making a very common mistake, for if the skin of the grape is broken before the grape is dry, the juice of the grape begins to ferment as soon as it is exposed to the air. As soon as fermentation begins the bees begin to eat the fermenting juice, and keep at it only when and where there is fermentation.

Now, how can a grape be ruined after the skin is broken, and it has begun to sour and ferment? But, says Mr. Everybody, the bees bite a hole in the skin of the grape, and that makes it begin to decay. To this I would answer, please examine a bee with a microscope, when she is feeding, and you will never accuse her of biting anything again, for, as I said before, she has no biter.

You answer, if the bees do not bite a hole in the fruit, and do not work on grapes until the skin is broken, how is it that they eat nearly every grape on a tray? Certainly they do, because the grapes have been wet, and it does not take long for the skin of the grape to be wet to rot a hole in it. To prove this you never see bees working on grapes that have been kept dry after they were ripe, and only after heavy dews or rain do the bees work on grapes.

In drying other fruits—peaches, apricots, &c.—we never see bees working on them when drying, except they find a piece that is over-ripe and has begun to decay. As fermented grape juice makes only a dark syrup, it injures the sale of any honey it is mixed with, and when bees work on it the apiarist is damaged by it. I have kept bees in connexion with fruit-raising for the last ten years, and consider the work they do in fertilising the fruit-trees, when in bloom, to be worth nearly as much as the honey they gather, and I do not hesitate to say that if the bees were made to move from this vicinity, the loss to fruit-raisers would be far greater than all the fruit pests ever have been to this country.—C. N. WILSON.—*Rural Californian*.

HOW TO FIND A QUEEN.

When settled warm weather comes in the spring, it is necessary that each colony contain a prolific queen, for if the queen in any colony should be old and failing, that colony could not be brought up to a proper condition to work to the best advantage during the honey harvest. As the queen is mother of all the bees in the hive, she must be able to lay rapidly so as to increase the population of the hive, and if such an one is not in the hive, she should be superseded with a better queen.

It also often happens that the queen which the hive contained during the Fall dies in early spring, and in that case it is absolutely necessary that the bee-keeper knows it, else that colony will perish, for the bees which have been wintered over rapidly die off with the work which now devolves upon them, for old age is brought upon the bees sooner or later, according to the labour which they perform.

There is no way of knowing to a certainty what is going on inside, except by opening the hive and inspecting the frames. To know if there is a queen in the hive, look closely at the combs, and if no eggs or small larva are found in the bottom of the cells at a time when the bees begin to bring in pollen in the spring, you can reasonably expect that they are queenless; while if the eggs are few and scattered about in different cells without regularity, the queen is unprolific.

To be absolutely sure that a colony is queenless, take a frame of comb having eggs and little larva in it, and put it in the centre of the supposed queenless colony, leaving it for three days. If queenless, queen-cells will be formed over some of the little larva, while if no such cells are started, rest assured that the bees of this hive have something which they are respecting as a queen, and which must be found before a good one can be introduced.

To the accustomed eye of the practical apiarist, prolific queens are easily found, especially if the bees are of the Italian race; but a virgin queen is often hard to find by an expert. The best time to look for a queen is about ten o'clock on some bright, warm morning, when the most of the old bees are in the field after pollen and honey.

Open the hive carefully, taking out the frames slowly, and making sure that you do not hit them against the sides of the hive or anything else, so as to make the bees nervous, thereby setting them to running or stinging. When you have the first frame out, look it over carefully, and if you do not see the queen, set this frame and the next one in a box, or in some secure place where you can leave them out of the hive till you look the others over.

After these two are out, you have the hive so that you can see down into it quite well. On taking out another frame, glance down the side of the next one in the hive, when the queen will often be seen running around to the opposite or dark side of the comb, for young queens are shy. In thus running she shows the sides of her abdomen, to the eyes looking obliquely down, to a much better advantage than could be if the eyes were looking directly upon her back. If you do not see her, look on the opposite side of the comb you hold in your hands, looking obliquely as before, for she will be on one of these dark sides, if anywhere, on the comb. In this way keep on until she is found, or all the frames are taken from the hive. If unsuccessful, close the hive and try again in an hour or so, when success will attend your efforts.—G. M. DOOLITTLE.
—*Rural Home*.

Notices to Correspondents and Inquirers.

Letters or queries asking for addresses of manufacturers or correspondents, or where appliances can be purchased, or replies giving such information, can only be inserted as advertisements. The space devoted to letters, queries, and replies, is meant for the general good of bee-keepers, and not for advertisements. We wish our Correspondents to bear in mind that, as it is necessary for us to go to press in advance of the date of issue, queries cannot always be replied to in the issue immediately following the receipt of their communication.

All queries forwarded will be attended to, and those only of personal interest will be answered in this column.

J. HEDDITCH (Ilminster).—Combs are badly affected with foul brood. We should burn the combs and frames. The combs were no doubt foul-broody when the swarm took possession, and it shows how disastrous it is to leave such hives about where swarms have access to them. The bees will be worthless, so they may be destroyed with sulphur when the hive is being fumigated or disinfected.

M. E. (via Sheffield).—Comb sent is foul-broody, and should be burnt. It would be the height of folly to give such combs to healthy stocks.

SAMUEL (Devon).—*Patent Hives.*—You need have no fear of infringing any one's patent in making hives for your own use. You would be wise, however, to buy a good one to work from.

A. H. BEACH.—If the bees are short of food when put up for winter, a good-sized cake of soft candy will be very beneficial.

R. WILFORD (York).—When the honey-press named is made for sale (as it will be shortly), the maker's name will appear.

JOHN U. URSON (Riverside, Dover).—Comb sent contains no brood at all; nothing beyond wholesome, healthy pollen.

LLONGBORTH (Somerset).—We do not think you will run any risk so long as the slides are not made for sale, but only for your own use.

E. M. (Berks).—You may use naphthaline in the hives at all times as a preventive of infection. About a half-inch is usually allowed between the divisions in 'rapid feeders.'

T. G. (Staffs.).—Sugar sent is refined, and appears in every way suitable for feeding bees. We see no reason to doubt the guarantee given. Bees are a cross between Ligurians and Carniolans.

A SUBSCRIBER.—*Making Beeswax.*—We do not understand your question. There is no recipe for 'making beeswax,' but the method of extracting it from old combs has frequently appeared in our columns.

J. G. HARDY (Great Yeldham).—Sugar sent is pure cane.

A SHROPSHIRE BEE-KEEPER.—*Feeding up for Winter.*—Every day now lost reduces the chances of preparing stocks well for standing the winter. It is also much better to 'overdo' than 'underdo' it when feeding bees is the question.

NAPHTHALINE

AND

NAPHTHOL BETA.

Both the above may now be had at the Office of 'THE BRITISH BEE JOURNAL' and 'BEE-KEEPERS' RECORD,'

17 KING WILLIAM STREET, STRAND, LONDON, W.C.

NAPHTHALINE in packets, 6d. post free. Large packets, containing more than four times the quantity of the smaller ones, 1s. post free.

NAPHTHOL BETA, 1s. a packet, post free.

Instructions for use sent with each packet.

Special prices for quantities.

NEW EDITION NOW READY.

21st Thousand.

THE BRITISH BEE-KEEPER'S GUIDE-BOOK.

By THOS. WM. COWAN, F.L.S., F.G.S., &c.

Revised and enlarged.

Almost entirely re-written. Much new matter and many fresh illustrations added.

Fcap. 8vo., price 1s. 6d.; or in cloth gilt, 2s. 6d.

Postage, 2d.

To be had of HOULSTON & SONS, Paternoster Sq.; all Hive Dealers, Secretaries of Bee-keepers' Associations, and of J. HUCKLE, *British Bee Journal* Office, Kings Langley, Herts.

NOTICE.

THE COMMITTEE of the LANCASHIRE AND CHESHIRE BEE-KEEPERS' ASSOCIATION require the Services of a Practical Bee-keeper (who will have to be specially approved by the Committee of the British Bee-keepers' Association), to deliver LECTURES in various districts of LANCASHIRE, to be paid out of the grant of £100 recommended for this purpose by the Technical Instruction Committee of the Lancashire County Council.

Applicants should state terms of remuneration required, and address, not later than the 16th inst.,

THE REV. J. F. BUCKLER,

Bidston Rectory, Birkenhead.

Special Prepaid Advertisements.

Situations, Publications, Bee Plants, &c.—Twelve words and under, Sixpence; for every additional Three words, One Penny.

Trade Advertisements not inserted under this head.

WANTED.—1-lb. Sections of Honeycomb, first quality. Prompt Cash. Packages sent. Well-filled Bell Glasses, Frames and Caps purchased. Address Mr. HURST, Bexhill, Sussex. 242

FOR SALE.—Having had considerable difficulty to obtain suitable Boxes for 1 lb. Sections, and bought larger quantities than required, I shall be pleased to sell at 4s. 6d. per gross, cash with order. Address MARTIN, 4 Woodland Place, Bath.

T. SMITH & Co., 17 Cambridge Street, W., are open to purchase Honey Sections, 4½ x 4½ x 2, of best quality only. L 34

FOR SALE.—Healthy Driven Bees and Queens, as advertised last week. Address HOLDEN, Wimborne, Dorset. L 40

WANTED.—One Hundredweight of Sections, and Four Hundredweight of Extracted Honey. Sample and price to W. T. GARNETT, Bee-keeper, Sheffield. L 41

WANTED.—One or Two Hundredweight of Extracted English Honey. First quality; prompt Cash; Deposit System. Address R. CHAPMAN, Newton Kettering, Northamptonshire.

WILL EXCHANGE 15 to 20 Stocks of Bees for Useful Quiet Horse to run in Light Cart. Sixty Stocks to choose from. Address W. PRYOR, Breach Wood Green, Whitwell, Welwyn, Herts.

FOR SALE.—Six Hives of Bees with Honey. Apply 'APIS,' Mr. RUE, Wensum Street, Norwich.

BEE SMOKE!!—Use the P. C. C. Cartridges. Once used, always used. Sample, 1 Dozen free, 1s. Address THOMPSON & NORRIS, Manufacturing Co. Limited, 37 and 39 Britannia Row, Essex Road, London, N. L 4,

GUIDE TO SUCCESSFUL BEE-KEEPING, post free 4½d. Address C. N. WHITE, Somersham, Hunts.

HONEY BOTTLES.

Good Clear Glass, packed, and free on Rail.
 1-lb., 7s. 6d. per gross; ½-gross, 4s. 2-lb., 10s per gross; ½-gross, 5s. 6d.
 Several Abbott's Spring Travelling Crates, for 1 doz. Sections, 2s. each.
 Enamelled Metal Section Cases, glazed, 18s. gross.
 J. B. FLATMAN, 40 Pevensey Rd., Eastbourne. 3133

THIRTEENTH EDITION.

COOK'S MANUAL OF THE APIARY.

New and Enlarged Edition.

CONTAINING 220 ILLUSTRATIONS.

Published at 6s. Reduced to 5s., Post Free.

J. HUCKLE, *British Bee Journal Office,*
 Kings Langley, Herts.

BEE SWAX:

Its Economical Uses and Conversion into Money.

By J. DENNLER,

AUTHOR OF 'HONEY AS FOOD,' 'HONEY AND ITS USES,' &c.

Translated from the German, and Edited by

THOS. W. COWAN, Editor of the 'BRITISH BEE JOURNAL.'

Illustrated, price 3½d., Post Free.

'BEE JOURNAL OFFICE,' KINGS LANGLEY, HERTS.

BALDWIN'S is the Oldest Establishment in the United Kingdom wholly devoted to Bees and manufacture of

Bee-keepers' supplies. His prices will compare most favourably with those of any other Maker, while for quality of material, suitability and workmanship, he has no rival.

'Why can he give better value for money than others?' Because he spends less in large 'puffing' advertisements, buys in the best markets for prompt cash, has no rent to pay, and personally conducts his own business.

For prices and full particulars of Goods see Baldwin's Bee-keepers' Instructor (and Illustrated Catalogue combined), which 'contains more practical and reliable hints than all the large, expensive books,' post free for 2d. stamps. Address **S. J. BALDWIN The Apiary, Bromley, Kent.**

N.B.—More than 500 Silver and Bronze Medals, First and other Prizes, and Testimonials innumerable.

THE 'ENGLISH' HIVE.

Transferring Season now on.

TRY THIS HIVE, it is the best in use, and once used will be always used. No more cutting Quilts necessary, as the Bees can be fed from the side of the Hive. See description in *B. B. J.*, August 6th, 1891, p. 351. Price for Floor-board, Body, and Zinc-covered Roof, 11/6 only. The English Wax Extractor, price 7/6.

For particulars apply to A. T. WILMOT, St. Albans. 3149

British Bee Journal and Bee-keepers' Record.

OFFICE:

17 KING WILLIAM STREET, STRAND, LONDON, W.C.

PURE CANE SUGARS.

For the accommodation of Bee-keepers, guaranteed Pure Cane Sugar will be supplied in large or small quantities through this office at the under-mentioned rates:—

MOIST.	Neat bags, 14-lbs. 28-lbs. 56-lbs. Cwts.
3. MUSCOVADO	2/7 5/2 10/- 19/6
CRYSTALLISED.	
4. DEMERARA	} Crystals 2/9 5/4 10/6 20/6
5. BARRADOS	
6. TRINIDAD	

REFINED CANE.

7. WHITE CRYSTALS (Small)	3/0	5/10	11/6	22/6
8, 9. (Medium and Large sizes, 1/- per Cwt. extra.)				
10. LUMP (Cut Loaf) ... Boxes,	3/3	6/3	12/3	23/6
11. LUMP DUST	3/	6/-	11/9	22/9
12. PRESERVING	3/-	6/-	11/9	22/9
FINE.				
13. GRANULATED	3/3	6/3	12/3	23/9
14. CASTOR Coarse (15 Fine)	3/9	7/3	14/3	27/9
16. ICING... ..	4/3	8/3	15/9	31/-

All above guaranteed made from CANE SUGAR only, and free from BEET, CHEMICALS, etc., etc.

CARRIAGE PAID on Orders over 5/0 (or 28-lbs. Sugar) to London and Suburbs.

COUNTRY ORDERS, not less than 2-cwt. carriage paid at 1/0 per cwt. extra.

(Scotch and Irish orders, special arrangements.)

Cash to be sent with order, and purchasers will please observe that if samples are required or replies asked to inquiries, a stamped addressed envelope must be sent, as we cannot undertake cost of postage.

THE British Bee Journal,

BEE-KEEPERS' RECORD AND ADVISER.

No. 486. Vol. XIX. N. S. 94.]

OCTOBER 15, 1891.

[Published Weekly.]

Editorial, Notices, &c.

USEFUL HINTS.

WEATHER—Dilatory bee-keepers have been favoured with suitable weather in which to complete all feeding up, and the occasional warm days which intervened between the wind and wet of the last fortnight have assisted bees in sealing over the food given. We may therefore conclude that, in the south at least, stocks will go into winter quarters under very favourable conditions. Breeding has been fairly well maintained, and still continues to some extent where feeding is going on; consequently there will be a good proportion of autumn-bred bees to come out lusty and strong next spring, and we shall expect to hear of a very different opening to the season of 1892 compared with the dismal spring dwindling reported from many quarters in the early part of the present year. It would have been gratifying to record an equal share of good fortune throughout the whole of the kingdom, but there is reason to fear that northern bee-keepers will have had a harder experience, judging from the terribly bad weather reported in the daily press as prevailing in Scotland and the north of England for some time past. Bees in our own district are taking syrup down to-day as readily as if it were the month of August instead of the third week in October, but a very few days may bring about sharp frosts and a temperature so low as to impose serious difficulties on both bees and bee-keepers in storing away sufficient food for wintering on. In view of this it should need no urging on our part to induce prompt attention and the giving of food warm and in bulk, to ensure its being rapidly carried down and sealed over.

STORING AWAY STOCK COMBS.—Boxes of combs, wet with honey after extracting,

should be carefully dealt with to avoid upset in the apiary while being cleaned up by the bees. Nothing causes more excitement in a stock than giving a box of combs dripping with honey. We always let one colony do all the 'cleaning up,' preparing for it carefully in the daylight, so that no access can be had from without save by the hive entrance. A board, large enough to cover the frames in brood chamber, with a feed-hole corresponding with those in quilts, is laid on the latter, and on this board the boxes of combs are set *after dark*, all being carefully covered up without delay. If done before it is quite dark the bees will, in their excitement, take wing by scores, and many may be lost. After dark, however, though the flight-board be covered by bees running about, none will take wing. Next morning all will be quiet, and the boxes of combs quite clean and dry. They may then be raised off the board, a slip of glass dropped over the feed-hole, and the boxes replaced, the bees being got rid of during the day by means of the cone clearer. At night a second lot of boxes is given, and the operation repeated.

When stowing away for use next year, each set of combs is packed away in a separate parcel, a small piece of naphthaline being dropped into each to keep away moths, and as a disinfectant.

ROBBING THE BROOD NEST.—We use the word 'robbing' to express our view of a proceeding which cannot be too strongly condemned. Except in rare instances, it is neither wise nor economical to deprive bees of the contents of the outer combs in brood chambers should they happen to contain sealed honey. Of course, we refer only to cases where about ten standard frames constitute the brood chamber; beyond that number there can be no harm in removing the surplus, but the practice—now, happily, fast dying out—of extracting every particle of honey from brood chambers and feeding back syrup, has nothing to re

commend it, and readers will consult their own interests as bee-keepers by avoiding so suicidal a habit. Whatever honey is found in that part of the hive at the close of the season, leave it for the use of the bees themselves. No hives come out so strong in spring, according to our own experience, as those left with plenty of natural stores; hence, we have no good word for those who persist in robbing the brood nest in the autumn.

SPACE BELOW COMBS, VENTILATION, &c.—After the experience of last winter, some anxiety will, no doubt, be felt as to the best method of putting bees up for safely passing through their winter risks. Personally, we have no hesitation whatever in again recommending a continuance of impervious coverings above the frames, viz., a square of American cloth next the top bars, two or three felt quilts above this, and, over all, a thin board laid on the quilts and weighted down sufficiently to keep the latter warm and close. This arrangement, with the three-inch 'eke,' or some equivalent for it, under the body-box to raise the frames that distance above the floor-board, and a fairly wide entrance, will leave little to be desired, so far as the actual well-doing of the bees is concerned, until the month of March next. It goes without saying that good syrup properly prepared from cane sugar has been used in feeding up, and if all these matters have been attended to, the bee-keeper may comfort himself with the assurance that he has done his share of the safe-wintering process. Beyond this it only remains to see that bees are fairly strong in number when put up; if not, weak lots should be joined together. We don't care to see less than six or seven seams of bees wintered. Stocks with fewer than this should be strengthened up to that number if possible.

BRITISH BEE-KEEPERS' ASSOCIATION.

The *conversazione* and other meetings usually held in the month of October will take place on Wednesday, the 21st inst. County representatives will meet at 17 King William Street, Strand, at three o'clock. The General Committee will meet at 105 Jermyn Street at four o'clock. At five o'clock candidates for the appointment of public lecturer to the Lancashire and Cheshire Association will deliver lectures. Members of the Association are invited to hear these lectures. A *conversazione* will be held at six o'clock.

IRISH BEE-KEEPERS' ASSOCIATION.

The Committee met on the 6th inst. Present: Mr. Milner, in the chair, Mr. Read, Mr. O'Bryen, and the Hon. Sec. Mr. John Henderson was appointed District Hon. Sec. for Co. Carlow. The Hon. Sec. was empowered to purchase, at his discretion, naphthaline and Naphthol Beta for distribution amongst bee-keepers to prevent and remedy foul brood. It was resolved to enter into fresh negotiations for the sale of honey in Limerick.

QUEENS FROM FOUL-BROODY STOCKS.

Readers who are destroying foul-broody stocks of bees will confer a favour by sending on the queen and a few bees (alive) to this office, addressed to the Editors. As the queens are intended for microscopical examination, it is important that they reach us alive, and we will forward suitable cages for post if an intimation be sent.

WILFUL DESTRUCTION OF BEES.

A case of interest to bee-keepers was heard before Judge Prentice at the Bow County Court on Monday, the 5th October. Mr. W. J. Sheppard, of Derby Road, Woodford, Essex, sued Mr. Alfred Cottage, builder, of Chelmsford Road West, Woodford, for the value of two swarms of Ligurian bees, wilfully destroyed by him and his son on the 10th and 11th July last. Mr. E. D. Simmonds, of Messrs. Emmanuel & Simmonds, Finsbury Circus, E.C., appeared for the plaintiff, and Mr. Haynes defended.

Mr. Simmonds stated that his client was the honorary District Secretary of the Essex Bee-keepers' Association, and the case was of the greatest interest to every keeper of bees. Plaintiff's premises adjoined the defendant's, and it was held by Blackstone that if a swarm of bees escaped from the owner's premises he was legally justified in following the bees into other persons' premises with a view of recovering them.

Mr. Haynes objected that as the summons was for wilful damage, it was a case for another court; but his Honour decided to hear it.

Mrs. Sheppard, wife of the plaintiff, was then called, and deposed that on the 10th of last July she saw a swarm leave one of her husband's hives and go on to a tree in Mr. Cottage's paddock, a slip of ground at the bottom of the garden. Before the bees had all settled the defendant and his son came up and threw bricks at them. They then went away, and soon came back with a pan containing tar or something of the kind, which was lighted, and placed on the ground under the swarm. They then shook the bough the swarm was on with a clothes prop, and the bees dropped into the fire, and were burned. Another swarm issued the next day, when the son of the defendant treated it in a similar manner.

Mr. Haynes (for defendant): Have you had any complaints from the neighbours about your bees?—No.

Mr. Haynes: Don't you know that Mrs. Stubbings complained that your bees got into her wine?—I knew that Mrs. Stubbings had said our bees got into her elderberry wine that she had placed in her garden.

His Honour: I don't keep my wine in my garden (laughter); I should expect bees to get in it if I did.

Walter Debnam, of Chelmsford, expert to the Essex Bee-keepers' Association, was the next witness, and said that he got his living amongst bees, and had a good many years' experience of them. He had over 2000 hives belonging to the members of the Association to attend to. Witness said it was the custom all over Essex, and, indeed, throughout the Kingdom, when bees swarmed on to another person's premises, for the owner to go and take them.

His Honour: Who made that custom?

Witness: I don't know; but it always has been the custom.

Mr. Haynes: But we never refused their coming on our premises for the bees.

Mr. Debnam: It is the custom to allow the bees about half an hour to settle before asking leave to take them away. The defendant killed the complainant's bees before they properly settled.

His Honour suggested that the parties should try to settle the matter between them, and the defendant offered to pay 11. Is., and each side to pay their own costs, but the plaintiff would not agree to this.

Mr. Haynes said that for years plaintiff's bees had damaged his client's fruit-trees. Still he did not press for a counter claim.

His Honour: How could they damage his trees?

Ultimately his Honour said he would give judgment, with leave to the defendant to appeal, if a nominal amount for the damages was agreed to. The plaintiff consenting, an order was then made for the defendant to pay 5s. damages, with costs, as if the judgment had been for an amount between 5*l.* and 10*l.*

[In view of the importance to bee-keepers of the above case, it is very unfortunate that the judge did not give a definite opinion on the point at issue. It has always been held by authorities on the subject, that the law as laid down by Blackstone made it clear that a swarm of bees, if not lost sight of after leaving the hive, can be followed by their owner on to another person's premises in order to take possession or hive the swarm. The weak point in Mr. Sheppard's case appears to lie in the fact that application was not at once made for permission to hive the bees. If this had been done and leave refused, there would have been practically no defence to the case. As it is, however, the defendant will no doubt pause before committing so cruel and wanton an act as, according to the evidence, he was guilty of, for the costs in which he was mulcted will not fall short of six or seven pounds.—Eds.]

THE SUCCESSFUL PRODUCER.

I believe there is scarcely anything in which the beginner in bee-culture, as well as many of the old brimstone bee-keepers, lack knowledge as the time of the honey flow in their respective localities. I am frequently asked, after we have taken nearly our entire crop of honey, 'Do you think this is going to be a good honey season?' or a question something like the above.

Now this is a question of vital importance, if we wish to secure the best possible results from our bees. In our locality we may look for a honey-flow from about June 15th to July 15th, after which bees are inclined to rob until about September 1st, when we have some honey coming in until frost. Yet the season, the flora, and many other things may cause a variation in the time, or even an entire failure. It is therefore to the bee-keeper's interest to make a thorough study of this matter, so as to know when to put on sections and when to reduce the number on each hive, so as to have all, or nearly all, completed by the time the honey ceases to come in in sufficient quantity to enable the bees to build comb. It is of equal importance to know when to expect clear honey and honey of a darker colour, as we do not want the two kinds mixed if we can prevent it. If the hives are only partially filled with honey of a fair grade, and there are indications of honey of a poorer quality coming, I would advise extracting the surplus combs and removing all completed white sections, and not wait for the bees to fill the hives.

Some novice may ask, 'How am I to know when honey is coming in and when it is not?' In reply I would say, when your bees are working with all their energy, and there is plenty of clover or other flowers in bloom, examine your strongest colonies frequently, and as soon as you see the upper edge of the combs whitened with new wax you had better be prepared to give them room in a short time. Do not wait for them to fill the lower story, for in so doing they are crowding the queen to a small space, thus restricting the brood-rearing capacity of the hive, and consequently lessening the number of workers later on. If you can get the bees started storing surplus during fruit-bloom it will be all the better, when white clover begins to yield honey.

When honey ceases to come in plentifully you are very apt to know it by the bees flying around neighbouring hives looking for a crevice where they may possibly slip in and get a sup of stolen sweet, as well as being ready to pounce on you and sting without any provocation whatever. To the advanced bee-keeper this article might not be interesting, but to the beginner I would say, study closely your honey resources, learn when to prepare your bees for the harvest, and see if you will not be repaid for the time and thought given to the subject.—S. E. MILLER.
—*Missouri Bee-keeper.*

ESSEX BEE-KEEPERS' ASSOCIATION.

HONEY SHOW AT BRENTWOOD.

A very creditable little honey show—promoted mainly by the personal exertions of a few active members of the Essex B.K.A. residing in the district—was held in connexion with the Brentwood Horticultural Society's autumn exhibition, held on September 17th, in genuine autumn weather. The day was ushered in with genial sunshine, and though it grew rather dull and threatening, the rain held off; to this cause may be attributed in large measure the success of the show. Under the patronage of Lady Guise and most of the resident gentry, the show was held in the grounds of Middleton Hall, by the kind permission of Mr. J. Tasker.

The entries were fully up to the average of other years, and the quality was much better. In the honey there was a marked improvement, and the entries were better than in any other year. This was mainly due to the extraordinary exertions made by Mr. F. H. Brenes, of Warley Road. Altogether the large sum of 180*l.* was offered in prizes, besides many special prizes, a fair portion going to the honey classes, which were judged by Messrs. A. Tunbridge, H. Harris, and F. H. Brenes, whose awards are appended:—

PRIZE LIST.

Class for Cottagers Only.

Collection of honey, 12 to 20 lbs. (prizes given in this class by tradesmen of Brentwood).—1st prize, J. Winter, Kelvedon Hatch; 2nd, J. Payne, South Weald; 3rd, G. Cornish.

Open Classes.

Single 1-lb. section of comb honey.—1st and Essex B.K.A. certificate, R. R. Royds, Brizes Park, Kelvedon Common; 2nd, J. Payne; 3rd, J. Winter.

Twelve 1-lb. sections of comb honey.—1st, J. Winter; 2nd, J. Payne; 3rd, R. R. Royds.

Twelve 1-lb. bottles run honey.—1st, Mr. Oddy; 2nd, J. Winter; 3rd, R. R. Royds.

Six 1-lb. sections of comb honey.—1st, Miss Chalk, Hutton Park; 2nd, J. Winter; 3rd, G. Cornish.

Six 1-lb. bottles run honey.—1st, R. R. Royds; 2nd, J. Winter; 3rd, Mr. Oddy.

Altogether, the honey department was quite a success, and reflected much credit on those through whose active efforts it was brought about.

Bee Shows to Come.

October 13th to 16th.—British B.K.A., in connexion with the Dairy Show at the Royal Agricultural Hall, London. All open classes. Entries closed. Wm. C. Young, Sec., 191 Fleet Street, London.

November 11th.—Essex Autumn County Show of Honey, held at Corn Exchange, Chelmsford, in connexion with Chrysanthemum Show of Chelmsford Horticultural Society.

Correspondence.

The Editors do not hold themselves responsible for the opinions expressed by correspondents. No notice will be taken of anonymous communications, and correspondents are requested to write on one side of the paper only, and give their real names and addresses, not necessarily for publication, but as a guarantee of good faith. Illustrations should be drawn on separate pieces of paper.

Communications relating to the literary department reports of Associations, Shows, Meetings, Echoes, Queries, Books for Review, &c., must be addressed only to 'The Editors of the "British Bee Journal," 17 King William Street, Strand, London, W.C.' All business communications relating to Advertisements, &c., must be addressed to Mr. J. HUCKLE, Kings Langley, Herts (see 1st page of Advertisements).

** * In order to facilitate reference, Correspondents, when speaking of any letter or query previously inserted, will oblige by mentioning the number of the letter, as well as the page on which it appears.*

FINDING QUEENS.

THE CHAIN SIGN, A QUEEN-CATCHER AND HOLDER.

[805.] The ability to find queens readily, be the colonies large or small, can only be obtained by prolonged and judicious practice. Experts can, in the majority of cases, find queens readily, but it requires practice and experience, both of which take time to acquire.

The best time to find a queen easily is when bees are gathering rapidly, and therefore breeding actively. When searching for queens the hive should only be opened during mild, warm weather, in the middle of the day, or, if the weather is extremely warm, an opportunity should be chosen before or after the hottest part of the day. When there is the least signs of robbing or disturbance, queens should only be searched for towards the evening, when work has about ceased for the day.

If it is desirable to show the queen and the interior working of a colony to visitors, choose a nucleus stock, or a small colony not supered, in preference to a larger one, and always take advantage of the inspection to note the wants and minister to the requirements of the colony while showing it. Another thing I would urge is, not to open a hive frequently because its queen happens to be easily found.

When searching for the queen, examine only such combs as contain eggs and brood, and commence by fixing the eyes on the centre of the comb, and continue in constantly larger circles until every part of the surface has been examined; do that quietly and thoroughly a couple of times for each face of the comb. The eyesight will soon get trained to pass quickly from the centre or other part of the comb to the queen itself, when her form comes under observation, the eye soon becoming accustomed to the behaviour of the bees and other peculiarities observable in the immediate vicinity of the queen. Examine each comb thoroughly, the main object being to avoid the necessity of having to go over the combs twice.

Wear a smooth, light-coloured dress. Do not smoke the hive by the entrance before opening, unless it contains very irascible bees; in that

case give a few puffs once or twice at the entrance before opening, thereby causing the bees to gorge themselves, and become better-tempered in consequence. Do not let the colony, when uncovered, become disturbed by smoke, sharp motions, or rough handling.

When opening a twenty-frame hive, with frames at right angles to the entrance, stand at the back; first remove the coverings, then raise the quilt next to the frames, covering the right half of the hive; begin from the end, draw horizontally towards the centre, steadily, yet smartly, watching that the frames are not displaced in so doing. Let a moment elapse before removing the quilt on the left half from the centre to the left end, during which time, if the queen is timid or inclined to *run*, she will do so towards the left end of the hive. Should the bees simulate an attack, remain perfectly quiet, and avoid using any intimidant unless absolutely necessary. Remove one or two frames from the left end, first loosening them gently with the point of a screwdriver. Then observe how many of the frames next to those removed are only sparsely occupied with bees; loosen these, and move them close against the end of the hive, and as far as possible from those fully covered by bees.

The Chain Sign.—For the frames that now remain to be handled, loosen from the back end of the top bar only. Let the fore end form a sort of hinge, as it were, and on that pivot open the back end an inch or an inch and a quarter; then look down between the frames into the wedge-shaped opening so made, and so long as you do not observe the ‘chain sign’—that is, *one or more strings of bees joining the faces of the combs at a right angle*—draw all such frames against those at the end of the hive without lifting them, till you come to the first frame to be taken up. In a queenless hive, that has no means of rearing a queen, the ‘chain sign’ is totally absent, and the bees run restlessly in all directions on each comb examined. When a hive is opened, some of the bees are disturbed from their work, or put on the *qui vive*, fearing molestation, while others continue to discharge their special duties, maintaining thus a semi-normal condition, and it is on some of these latter bees that we have to depend for the presence of the ‘chain sign,’ because amongst those bees that form the heat-giving cluster, several desert their post, but a few retain it, and by their tenacity to duty indicate the presence and the limits of the brood nest. *The faces of the combs linked by the ‘chain sign’ therefore contain eggs and brood, or have the cells cleaned, varnished, and kept at an equable temperature by the cluster, ready for the presence and for the eggs of the queen.* These combs represent her domain, in which only it is necessary to look for her at all times when bad conditions are not present. The ‘chain sign’ in early spring indicates a normal colony, a fertile queen, and the presence of young bees. It enables one to ascertain quickly the size of the cluster and brood nest in the spring, when the hive

should be uncovered as short a time as possible, also to indicate the frame to be taken up from the side of the brood when a comb of eggs and brood is required for another colony. In the early part of the year, when all queens should have commenced to lay, the ‘chain sign’ indicates those colonies which are in a normal condition, so that those only where it is absent need be examined to ascertain whether they are queenless. There is also a sign which consists in an almost imperceptible fluttering of the wings by the bees on the comb, caused by the presence of the queen on that comb, but this sign has the fault of being continued for a short time after she has left. Nevertheless, such a frame should be well examined before being placed back in the hive. On the other hand, under the best of conditions, with a healthy queen actively occupied egg-laying, the bees on her comb are simply passive and quiet when the frame is held in the hand.

The Queen-catcher and Holder.—There are several reasons why a fertile queen should not be taken up with the fingers, and with a sprightly virgin queen in warm weather, if a ‘miss’ is made instead of a ‘hit’ in attempting to take her up, she will usually take to wing if you again miss her at the second attempt. It therefore becomes necessary to use a device that will at all times enable one to catch and hold the queen with absolute certainty without handling, or the least chance of injuring her. For several years past I have found the common ‘safety match-box’ to answer that purpose admirably. The great value of the empty match-box to the bee-keeper, however, is that a queen always walks inside immediately the opening is placed over her. In using, open the box about half an inch, hold it with the second finger and thumb, and place the forefinger on the end of the inner box ready for closing it; place the opening longways over the queen, keeping the end of the box that is inside the hand about an inch above the comb, so as not to hurt any of the bees, and close a moment after. When it is desired to locate the queen in a swarm, open the box an eighth of an inch after you have the queen in, push a short tinctack through the side to fasten the inner box, and put a pin or fine wire nail through the projecting part of the outer box at the other end, which serves to join the queen-holder inside the skep.—PETER BOIS, *Jersey, October 3rd, 1891.*

IN THE HUT.

‘If e'er dark autumn, with untimely storm,
The honey'd harvest of the year deform.’

EVANS.

[806.] Thanks are due by me to Mr. Walton, whom I should like to know well enough to call ‘Friend John,’ for ‘letting me off’ anent my weather prophecy at the early part of the season. Prophecies about the weather in our ficklest of fickle climates are, after all, but literary squibs, so it is quite fitting they should

be 'let off.' By the way, I take note of his statement (p. 386) that he has heard of some rather heavy takes of honey, and also found his hives crammed. I also observe that our Editor (*Record*, p. 121) says, 'Our southern readers have reason to be well satisfied with the season of 1891,' and that (*ibid.* p. 139) 'the reports will come as a surprise to not a few who were inclined to look on the honey season of 1891 as a failure.' In fact, they seem so agreeably disappointing that adverse reports are almost invited.

Well, 'Home from the Moors' is now our song. Last week we had the usual procession, and when the lorry had climbed its thousand feet (I mean, had been dragged up to 1000 feet above sea-level, not anything of a centipede or millepede nature) and joined my advanced guard, who had just finished corking up hives, and were engaged in an agreeable reversal of this process, to wit, uncorking bottles, we were agreeably surprised to find Mrs. X-Tractor and several little X-Tractors had come to share (or increase) the much dreaded troubles of the return at nightfall. However, all passed off well, and without the invariable rain of previous years.

Again (and this is now settled definitely once and for all in this district), shallow frames, filled with super foundation and used the summer season for clover extracting, and then taken up to the moors, are beautifully sealed over, filled with magnificent heather honey. Sections precisely similarly treated are filled, but remain unsealed. This sets me thinking that the continuous comb gives facilities for a continuous working seam of bees, whereas, in the matter of sections, such a continuous clustering is prevented by the wooden divisions of the one-pound sections. Anyhow, the fact is there proved up to the hilt, that you can bring down slabs of honey in shallow frames, as against any number of unfinished sections. True, the frames are 'shallow,' but they have a 'deep' significance to the bee-keeper.

Speaking of the moors reminds one of the Moors in Spain, and also in Morocco, whence hails that other ill-gotten, worse-named, and better nicknamed *black*, the puny bee of North Africa. Selected query: What kind of honey is gathered by this bee from its native 'moors'?

'Scotland! thy weather's like a modish wife;
Thy winds and rain for ever are at strife;
Like thee, the termagants their blustering try,
And when they can no longer scold, they cry.'

HILL.

This writer is evidently not a Scotch Hill, but a Hill who, being a dramatist, writer, and poet in full blast two centuries ago, must have been speaking of the weather of his day; *he* was not a prophet able to forecast, for my experience of bonnie Scotland tells me that the winds and rain of our day are worse on the English side of the border, except in some specially selected districts where 'it snaws when it doesn't rain.'

A few weeks ago I was up north just at the

time of the Flower Show held in the Waverley Market. Mr. Learmont, of Castle Douglas, showed some excellent samples of honey, but the exhibits, generally speaking, were of a decidedly mixed character—much of the extracted honey resembled dark treacle rather than pure honey; and however creditable home-made sections and frames may be when 'made out of one's ain heed,' they do not look well on the exhibition table.

Castle Douglas reminds me of a few characteristic lines (*B.B.J.*, p. 454) which all Scotch bee-keepers should read; truly they spur one on to keeneest emulation.

Will you let me tell such of your readers as use the alba-carbon light that the white substance they use is the naphthaline you recommend as a *preventive* of foul brood? It may save a poor bee-keeper a few pence. This substance may be crushed and exposed to the air, with great benefit, in any room or house in which are cases of infectious disease. Again, when finely crushed and applied *dry* with a small paint brush to the parts of plants infested with green fly (*Aphis*) it is a 'settler' for them (the green fly, not the plants); they drop off, shall we say, of their own accord? This pest holds on to the soft juicy growing parts by means of a parrot-like beak through which it sucks the sweet sap.

When I winter up my bees I intend to get an old box larger than a hive, knock one end and the lid off, put it over the hive and stuff the space in with straw. I am more than ever convinced that an equable temperature is a *sine qua non*, and this is best secured by a casing of non-conducting material. There is nothing warm in a covering itself, it merely arrests heat and won't pass it along to the outside; in fact, such a non-conductor declines to be an—X-TRACTOR.

A TALK ABOUT BEES, AND MY EXPERIENCE WITH THE 'FLOUR DODGE,' CONE CLEARERS, ETC.

[807.] The question is often asked, 'Does it pay to keep bees?' Doolittle asks, 'Does it pay to kiss your wife?' But with reference to bees, the question is replied to in a variety of ways. I suppose we all have what is called our 'stand-point,' or way of looking at things, as was the case with a man I knew, who never had anything but losses; in fact, he lived on losses, and at last, when he died and was buried, the *losses* he left behind amounted to 30,000!. When we hear the farmer complain of his *losses*, it is usually found that he means what he has lost through his crops not being so good as they might have been; and the question might be raised, Does farming pay? As I know something about farming I do about bee-keeping. I say there is nothing so safe as land if you put money and *brains* into it. The same may be said respecting our bees. Invest ever so much capital in hives, bees, &c., if there is no brain-work it will be a failure. Put just a few pounds into the business of bee-keeping, use your brains, and by reading good books on the sub-

ject acquire the knowledge which is the outcome of the brains of others, and success is as sure to follow as that the light will come in the morning. In this world we like to get all the pleasure and happiness we can. If we are a bit dull and inclined to lose interest in life, there is nothing in the world which will brighten a man up like the keeping of bees.

To lovers of everything that is beautiful and good, the bee is a never-ending source of wonder. What lessons we get, and what examples of hard work they give us. Hours and days with the bees pass like magic, and we seem to see goodness in everything. Surely, in respect to bee-keeping, we might with no irreverence say 'old things are past away, and all things have become new.' What a change from the sulphur pit! Light now shines, and 'Progress' is our motto, and the precious God-given bees shall have all the care and kindness that we can give them.

Regarding the pleasures of bee-keeping, take the 'flour dodge,' as it has been called. What a boon and a blessing to bee-keepers! With me it is always a success. I united two lots, one of which I had to bring over a brick wall. I went by our Editors' directions, and kept the two hives on the trot, gradually bringing them nearer to each other. When I had got them side by side, I opened the strongest, gave them a puff of smoke, then took a comb out, and dusted both sides, put it back, and did likewise to the other frames, replaced the quilt, then went to next and repeated the operation on the other hive. When I had finished, I removed quilt from first hive, packed frames to centre, then put the centre frames from the second hive at each end. When all was completed, I set the united hive in centre between where the two hives stood, and not a bee was killed. They are in line now, and to-day (October 7th) carrying in pollen.

My next word must be on cone super-clearers. I bored two holes in each gable of five hives, and placed a wire cone in each hole, and was very sanguine that the bees would take their own time in leaving the supers; but they came out as if they were swarming. Unfortunately, one of the hive roofs was replaced carelessly, and the bees found it out that they could get in. When I made the discovery hundreds of bees had got inside, and were having their own fun! Wherever there was a joint or a cone there was the busy bees 'improving the shining hour' with a vengeance! In a word, Messrs. Editors, it was getting pretty hot, and I was myself getting it rather warm, so when I cool down I'll tell you 'a tale' in my next, if you will allow me space.—T. H. C.

ARE THE QUEENS OF FOUL-BROODY STOCKS DISEASED?

[808.] I have always been under the impression that the foul-brood bacilli were to be, and have been, found in the reproductive organs, &c., of some queens taken from diseased stocks; but the following from a letter of Dr. Lortet's,

in the May number of the *Revue Internationale*, shows me that this is not his opinion:—

'During the latter months of the past year and this spring I have received from some of your courteous subscribers six queens taken from undoubted foul-broody hives. I have been able, on these females, to verify that which I have already stated before, viz., that the eggs are healthy; neither the ovaries or ovules contain bacilli. I believe, then, to be able to state once more that foul brood is not transmitted by inheritance, but only by direct contact with the infected animal, or by injecting nutritive substances containing foul-brood bacteria.—DR. LORTET.'

I think your opinion on the above, which is of so much importance in the treatment of foul brood, would be of interest to bee-keepers.—T. D. SCHOFIELD, *Alderley Edge*.

[The quotation our correspondent gives has not escaped our observation, but we have not thought it necessary to notice it, because we do not think it is conclusive that queens do not sometimes become diseased. It only shows that the six queens examined by Dr. Lortet were healthy. Although it is believed that queens may be diseased, it by no means follows that every queen is so. Hilbert found, out of twenty-five queens, only three diseased. He also found that such queens given to healthy stocks produced the disease in these stocks, and that it was very difficult and almost impossible to cure the disease while such queens were present. Just as every bee does not become diseased in a foul-broody hive, and as every human being does not contract cholera although exposed to its influence, so, we take it, there is immunity from the disease with some queens. Strictly speaking, we cannot say that every queen of a foul-broody hive is necessarily diseased, nor can we say that every queen is exempt from disease. The great hope of stamping out foul brood exists in the fact that it is not hereditary, and, in cases where foul brood is difficult to cure, the queen may reasonably be suspected to be diseased, and should be destroyed, as it is hopeless to effect a perfect cure while such a queen is present.—EDS.]

SPECIAL QUERY.

DISQUALIFYING EXHIBITS.

[809.] As you wish for the views of readers on the above (799, p. 454), I am pleased to give my opinion and experience. I have been an exhibitor at all our county honey shows since the Association was formed in 1883, and many local shows, and have acted as steward on several occasions. I have not had a single breakage of my own, but accidents will happen; therefore I say they ought to be treated as such, if it is a pure accident or the carelessness of those delivering it (not being the exhibitor himself). I don't remember a single breakage when delivered personally. Therefore, I don't think much difficulty would arise through allowing exhibits to compete which have met with an accident, if the broken jar is staged and proved to the satisfaction of steward or com-

mittee of show. I was once taking honey to a local show, and I also took twelve one-pound jars for a neighbour. When wiping one of his it came in two; it must have been cracked before, but they were properly packed. I bought a jam-jar, put the broken one in, and saw several members of show committee, and asked them to instruct the judge to judge it as a whole exhibit, knowing at the time if he did, and placed it as I should, it would put me down a step, which was the case, as the exhibit with broken jar was first, mine being third. I suppose the second exhibitor was satisfied, as I never heard any more about it. In my opinion, the best plan in cases like that of 'A Lancashire Bee-keeper' is for the judge to place them in order of merit with a reserve number, and leave it for those placed lower in prize list to object. I cannot believe that a bee-keeper who is a honey exhibitor will be so selfish as to disqualify an exhibit through a broken jar. One thing much worse than a broken jar is allowed to compete at some shows, *i.e.*, the 'nominal' pound, which is only a nice name for a public deceiver. I should be pleased to see the Weights and Measures Act applied to nominal pound jars; they are much worse than a pound weight which is a little short; that can be made good weight, but a jar cannot be over-filled. Committees who word their schedules to admit anything but the right size jars are helping to deceive those who trust they are buying sixteen ounces to the pound. The Staffordshire Bee-keepers' Committee take care that nominal pound jars have no place in their schedule.—JOHN R. CRITCHLOW, *Maer Farm, Newcastle, Staffordshire.*

FAIR EXHIBITS.

[810.] The query put before bee-keepers as to the fairness or otherwise of allowing eleven bottles of honey to compete with other exhibits of twelve bottles, where the schedule distinctly states that the honey shall be contained in twelve bottles, suggests thoughts which I have long had upon the whole question as to what is fair between man and man on the exhibition stand, and therefore ought to be upheld and sought for, against what is distinctly unfair or unjust, and consequently should be condemned and crushed out. A conversation, on an utterance by 'X-Tractor' confirms me in my opinions, and leads me to lay them before your readers in the hope that, some day, what is in the consensus of ideas wrong may be put right.

In the first place, it has struck me as being distinctly unfair to allow an invention to be exhibited by any one other than the inventor or maker in competition with articles staged by such inventor or exhibitor. At present any one (bee-keeper, appliance-maker, or not) may buy a hive, either privately or after having taken a prize at a show, and exhibit it all over the country, even against its own counterpart as exhibited by the inventor or maker. This gap

and loophole in the schedule also permits section crates, frames, smokers, extractors, and what not to be similarly purchased and shown, thus reflecting credit on the wrong people in the eyes of the general public, only the *cognoscenti* being able to correctly locate the real home of the invention or appliance. Of course the case is considerably altered where an inventor has permitted one or more manufacturers to make the goods. A invents a new super-clearer, and gives it to the public by describing it in your columns; B, C, and D make it, and exhibit it, quite fairly, I think, in competition. E, F, G, however, purchase of B, C, and D (either before or after shows does not matter), and stage it—most unfairly, in my opinion—against the exhibits of either A, B, C, or D. *Palmar qui meruit ferat*, or *Suum cuique*, should certainly be our most prominent watchword, whether as members of the B.B.K.A., as exhibitors, or judges, and I contend no one should be allowed to compete for any prize with any article unless that article be invented or made by themselves. The only exception to this rule would be articles in the collection class, which is a sort of epitome, or exhibition of what the whole science of bee-keeping can offer up to date, and in which it is notorious that the items are not the invention of the exhibitor.

It may be urged that such a restriction as I propose would have the effect of greatly reducing the number of exhibits. Well, suppose this be so, the air would be purer, and the competing articles would be engaged in a fair fight. But I do not think this would at all be the result (*i.e.*, a less number of competing exhibits), but quite the reverse. There would be some inducement for men to devise and for manufacturers to produce new goods, or to make improvements on old ones. I am much mistaken if there would not be an improved inflowing of genuine competitors; makers who do not now deem it worth while to spend brains or money on improved goods would then, at least, have a fair chance in the open field, and they have not that as things are at present.

The same arguments apply with regard to honey exhibits. A dozen bottles or sections may be purchased, either before or after a show, and shown over the whole country (excepting in classes where the schedule stipulates for the honey to be the produce of the exhibitor's own apiary), taking prizes here and there without any merit whatever having been deserved by the exhibitor, excepting, perhaps, the somewhat doubtful one of being able to practise judicious piracy, of ploughing with somebody else's oxen, of reaping where they had not sown. This could be stopped by the judge stamping with a small india-rubber stamp (T. W. C., W. B. C., J. L. S.) every section, or the label of every bottle on which he had adjudicated, and, in order that additional labour be not entailed on him, the local secretary or his deputy might do this work.

In the third place (and I know this will meet with opposition), I would not permit 'first-

prize' honey to be shown again in competition. It has had its reward on its adjudication, and should be done with except for sale, 'not for competition,' or for the honey-seller's shop window. A really A 1 exhibit keeps back good stuff, which the producer dare not exhibit; he having seen the former at its previous show, competition is checked, and the show of honey much lessened by the probability, nay, almost certainty, of the 'demon first' keeping on turning up. The local man, to use a slang phrase, 'has not a look in' even in his own district, nor, it may be, in his own county. I admit my third case is my weakest, but seeing they all strike me as drawing attention to palpable injustice, I lay them before you, asking that they be impartially considered, in the same spirit as conceived—in the interests of justice and fairness.—R. A. H. GRIMSHAW.

FOUL BROOD—THE SEASON IN SWITZERLAND.

[811.] With respect to foul brood, I should like to remind you that we have had several cures effected by simply pouring a few drops of essence of eucalyptus into the hive once a week. I also saw a hive this spring at Givrins which was foul-broody in 1890 cured in this way.

The season in Switzerland, with few exceptions, has been bad. Warnery, who had during the assembly at St. Prex on 18th May an apiary in splendid condition, has only obtained three and a half kilos. (seven pounds) per hive. He attributes this to the cold nights during the principal flowering. Descoullayes has not done any better, but here and there a few bee-keepers were more favoured. The station-master at Boudry (Neuchatel), a beginner, obtained sixty kilos. from two hives which he transferred this spring—quite incomprehensible.—ED. BERTRAND, *Nyon, October 7th, 1891.*

DRY FOOD FOR BEES.

[812.] Is it possible for bees to consume dry food? I say, No; and I shall, perhaps, be thought heterodox in venturing to say that dry foods containing sugar should never be given to bees. I base my opinion on the following:—A quart of water will dissolve, by boiling, about five pounds of sugar, and, on cooling, any sugar in excess will recrystallise; this is the strongest possible syrup obtainable. On the other hand, let sugar or candy be placed in a hive, the bees cannot take it until it becomes dissolved by the moisture from the hive cluster, when it becomes syrup, as in the former case, but of a weaker quality, and consequently more liable to produce dysentery, to say nothing of its probably being contaminated with the impurities of the hive. I suppose it would be an easy matter to test the above theory by experiment.

The *B. B. J.* says beet sugar is 'bad for bees.' I think many readers of the *Journal* might, like

myself—not that I have any doubt upon the subject—be glad to know why this is so, and in what other respects cane sugar triumphs over beet sugar, both from a household and a bee point of view.—A. T. WILMOT, *St. Albans.*

[According to the best recipe for making syrup we know of, the proportion of water to sugar for autumn food—viz., five pints water to ten pounds sugar—so nearly makes what our correspondent terms 'the strongest possible syrup' that it may, without discussion, be accepted as right; and as to the objection to soft candy—for by that, we suppose, is meant 'dry food'—it is so well known to practical bee-keepers that bees will thrive and build up in spring so rapidly and well with a good cake of well-made candy overhead, that it will take a deal of theory to convince them to the contrary. With reference to the relative good or bad properties of cane and beet sugar, we must refer readers to our remarks in *B. J.* for April 30th last.—EDS.]

WILDMAN ON BEES.

[813.] I have lately come into possession of a very old copy of a work on bees, entitled, 'A Treatise on the Management of Bees, Wherein is contained the Natural History of those Insects, with the various methods of cultivating them, both Ancient and Modern; and the improved treatment of them. To which are added The Natural History of Wasps and Hornets and the means of destroying them. Illustrated with Copperplates. By Thomas Wildman. The Second Edition. London: Printed for W. Strahan and T. Cadell, opposite Catherine Street, in the Strand. MDCCCLXX.' I don't know whether it has any particular value, but I have found it very interesting reading. There is no doubt but that its author understood and acted on many of the principles of modern bee-keeping, and was a thorough master of the practical part of the art, including driving, feeding, and the general management of bees. He was even then within measurable distance of the frame, for he puts bars across the tops of his hives—fixed, of course—but to me this seems to be the germ of the movable frame. He airs many fanciful theories, and his ideas of the natural history of the bee are, on some points, very hazy and even ridiculous; but it is easy to see that he had a thorough grasp of his subject, and fully understood what he was writing about. He freely quotes from the classical writers, especially Virgil and Pliny.

He opens with a sketch of what has been written on the subject from the earliest times down to his own contemporaries. He accepts the name 'king,' then in common use, but knew that the bee referred to was a female, and the mother of all the others. With regard to queen-cells, he could not discover their purpose, but supposed them to be the abode of the kings—a very good guess. He thinks the queen may lay 8000 or 10,000 eggs in a year; and, to account for the fact that two or three swarms may be thrown off in a season, each containing 10,000 or 12,000 bees, he imagines that the new queen

may produce some of the bees before they swarm. According to him the new queen leads the swarm. His description of the process of hatching is practically correct, according to our present knowledge. Pollen and propolis he couples under the name 'wax.'

That queenless stocks will accept a strange queen he knew well; and also that they will accept a queen-cell under the same conditions. The manner of mating of queens was totally unknown to him and puzzled him much. He accepts Mr. De Reaumur's calculation that a queen may lay 200 eggs a day in the most favourable seasons.

With regard to the duration of life he quotes Virgil and Pliny as though he accepted their seven or ten years as the age bees may attain. The following are his recommendations with regard to the situation of the apiary:—'It should face between south and west, in a place neither too hot nor too much exposed to the cold; it should be so situate as that the bees returning home from their labours may descend to their hives; it should be near the mansion-house on account of the conveniency of watching them.' He turns the hives to the west in spring that the bees may not be tempted out in the early morning of the colder months. They must not be under the drip of houses, trees, or hedges, and a running stream near is an advantage. The gardens in which they stand should be planted with suitable flowers, and the trees should be dwarf and bushy, to encourage the swarms to settle within easy reach. Of bee-plants he enumerates broom, mustard, clover, and heath, and thinks broom the best. Buckwheat is also mentioned and willows.

HONEY.—With regard to this he simply quotes other people's opinions: (1) That it is simply collected; (2) that it undergoes change in the stomach. He has a long extract from the Abbé Boissier de Sauvages about honey-dew. From this it seems that there were thought to be two kinds of honey-dew, one an exudation from the leaves of the plant, and the other the produce of an insect. It sounds rather startling to hear that, from this latter, bees collect the most delicate honey possible.

HIVES.—Our author recommends straw. His were seven inches high and ten inches wide, with upright sides, and held nearly a peck. In his upper round of straw he has a hoop of wood, to which he nails laths of wood, five in number, a quarter of an inch thick, and one and a quarter inches wide, to which the bees may attach their combs. He has a flat straw cover put on as follows: First a large sheet of clean paper, then daub it round with cowdung, then the cover, which is to be secured with twine.

Each hive should stand singly on wood, not stone, supported on a single post. Soot mixed with chaff is to be strewed round the hives to keep off vermin, and occasionally renewed. Weeds must be kept down.

BOXES.—These he explains very minutely with reference to the plates, but as these are missing it is rather hard to follow him.

His **FEEDER** he turns out of solid red cedar. One side is cut out to take a four-inch nozzle as entrance. The lid has a pane of glass in it. Width is nine inches.

SWARMING.—The signs are clustering on the outside, no work going on, and an uncommon silence. Time from ten to three, and from middle of May to end of June. His directions for hiving are practically the same as we follow now. If the bees show a disposition to return to the place where they settled he rubs the branches with rue, nettles, or elder leaves. The hive must be clean. Casts should be united.

ARTIFICIAL SWARMING.—The following are his directions for carrying out this operation:—'Turn the hive bottom up, give it some slight strokes on the sides so as to alarm the bees. They will immediately run to the extremities of their combs. If you look attentively to the middle of the hive you will there perceive the queen among the foremost. Seize her between the forefinger and thumb, and confine her in your hand till most part of the bees take wing; let her then go. The bees will soon join her and settle on some branch of a tree.' He cautions against doing this unless you have a queen in reserve.

In his time, by actual counting and weighing, it had been ascertained that between 4000 and 5000 bees weigh a pound.

He gives very detailed instructions how to manage bees in his hives, so that honey may be taken without destroying the bees. In fact, one of his strongest points on which he insists again and again is that there is no need to kill the bees.

The operation of driving might be taken *verbatim et literatim* from his book into any modern one, except that he was not acquainted with driving irons, but steadies the hive with his hand. Having driven his bees, he does not completely strip their old home, but only takes out the combs with honey and then returns the bees.

Mr. Wildman seems to have been a perfect marvel in handling bees, but he says he uses no other means than the fear of the bees and manipulation of the queen.

ENEMIES.—Among these he includes slugs, snails, parasitic insects, wood-lice, sparrows, house-lark, lizards, mice, and the wax-moth.

UNITING IN AUTUMN.—Drive both the stocks, shake the bees from one on to a cloth, take out the queen, and immediately place over them the hive containing the other stock to which you wish to unite them. When quiet, place over them the hive with honey which you wish them to occupy.

DISEASES.—A large part of his chapter on this subject is taken up with the ravages of the wax-moth. Candied honey comes in for a large share of the blame for winter losses.

Dysentery is thought to be brought on by the greediness of the bees on the first blossoms of spring, or by the bees having to feed on pure honey instead of honey and wax (pollen).

Rosemary and honey diluted with water is

spoken of as a remedy, and also covering the bees with (warm) ashes of the fig-tree.

FEEDING.—Take care in autumn that your bees have plenty of food. If any are short, give them combs by cutting out the empty ones and fixing in full ones, after having taken the precaution of smoking the bees well with the smoke of burning rags; or put honey under the combs with straws across it, and over them a paper pierced full of holes. Cover the hives to prevent robbing, and do the work in cloudy or rainy weather. Swarms are to be fed if bad weather follow their coming off. Stocks should have at least twenty pounds of honey to winter on.
(To be continued.)

Echoes from the Hives.

Eaglesfield, Ecclefechan, October 3rd, 1891.—I am very sorry I was from home when you so kindly made a call, and would have liked very much to have seen you. I hope I may have the pleasure of seeing you some other time when you come to the north again. With regard to my success, I may state I have had a splendid season; I got 160 lbs. from my six frame hives, and have sold it all, with the exception of some for my friends, at one shilling per pound. Mr. McConnell and myself are the only persons who have been successful in this locality. Most of our neighbours have done practically nothing, and they cannot understand the reason; but it is not far to seek—simply mismanagement. I am putting up six splendid bar-frame hives for winter, and mean to make an addition. I took first and second prizes in three local shows in sections, and two first for extracted.—W. NELSON.

Honey Cott, Weston, near Leamington, October 10th.—About a fortnight ago I paid a visit to Winchester, and saw some stocks of bees. I noticed they were about as well stored with honey as my own stocks. I went with my youngest son to visit Mr. Woodley, of 'World's End,' Newbury, where we had a fine bee-talk; stayed the night with him, sitting uptill middle of the night talking over bees and their management. Unfortunately we were prevented by rain the following afternoon from going to help him to drive some bees. From what friend Woodley said, I gather that he, as well as most of us bee-keepers, would like to have one of the old-fashioned good honey seasons again. We were most hospitably entertained by Mr. and Mrs. Woodley; my son and Mr. Woodley's amused themselves at draughts, while we talked bees. The time flew, and we were obliged to be off, and say good-bye, in hope to see them again some day. I have been driving a good few stocks of bees round the neighbourhood; from one gentleman's place I had nine lots, and many others in a radius of four or five miles, and have fed most of them up, and have now most stocks ready for winter, with the exception of a little extra covering on the quilts. I have fed driven

stocks up this year, most of them by feeding at the bottom, having a hole in the bottom board, and a perforated zinc tube, about two and a half inches diameter, going down into a tin dish. The bees only go down this tube, and can empty the tin, and about twice filling is enough to feed a lot right up for winter. I find they seal it up much better by being fed at bottom than they do with top feeders, however rapid they can get it. I did think of reducing stocks, but somehow or other I have made up stocks to about the usual number of between sixty and seventy.—
JOHN WALTON.

Notices to Correspondents and Inquirers.

- J. CLAPPERTON (Galashiels).—Without being absolutely certain, we are nearly sure the dead queen sent is the younger one.
- T. SOMERVILLE (Glasgow).—We do not know where Burns alludes to the bee as always returning to the hive from a westerly direction, but we incline to the belief that it will refer to some tradition. Nothing, to our knowledge, is known of such a tendency on the part of the bee.

NAPHTHALINE AND NAPHTHOL BETA.

Both the above may now be had at the Office of 'THE BRITISH BEE JOURNAL' and 'BEE-KEEPERS' RECORD,'

17 KING WILLIAM STREET, STRAND, LONDON, W.C.

NAPHTHALINE in packets, 6d. post free.
Large packets, containing more than four times the quantity of the smaller ones, 1s. post free.

NAPHTHOL BETA, 1s. a packet, post free.
Instructions for use sent with each packet.

Special prices for quantities.

BEE SWAX :

Its Economical Uses and Conversion into Money.
By J. DENNLER,
AUTHOR OF 'HONEY AS FOOD,' 'HONEY AND ITS USES,' &c.
Translated from the German, and Edited by
THOS. W. COWAN, Editor of the 'BRITISH BEE JOURNAL.'
Illustrated, price 3½d., Post Free.
'BEE JOURNAL OFFICE,' KINGS LANGLEY, HERTS.

THIRTEENTH EDITION.
COOK'S MANUAL OF THE APIARY.

New and Enlarged Edition.
CONTAINING 220 ILLUSTRATIONS.
Published at 6s. Reduced to 5s., Post Free.
J. HUCKLE, *British Bee Journal Office,*
Kings Langley, Herts.

Special Prepaid Advertisements.

*Situations, Publications, Bee Plants, &c.—Twelve words and under, Sixpence; for every additional Three words, One Penny.
Trade Advertisements not inserted under this head.*

WANTED.—1-lb. Sections of Honeycomb, first quality. Prompt Cash. Packages sent. Well-filled Bell Glasses, Frames and Caps purchased. Address Mr. HURST, 242 Bexhill, Sussex.

FOR SALE.—Having had considerable difficulty to obtain suitable Boxes for 1 lb. Sections, and bought larger quantities than required, I shall be pleased to sell at 4s. 6d. per gross, cash with order. Address MARTIN, 4 Woodland Place, Bath.

FOR SALE.—Healthy Driven Bees and Queens, as advertised last week. Address HOLDEN, Wimborne, Dorset. L 40

WANTED.—Set of Lantern Slides on Bee subjects. State number, subjects, and price to JNO. BROWN, Polyphant, near Launceston. L 49

FOR SALE.—Seven Stocks of Bees. Owner dead. Address THEOBALD'S STABLES, Waltham Cross, Herts. L 50

WALLFLOWERS.—Fifty Plants, 1s. free. Arabis, 1s. per dozen. Address NORMAN PARKIN, Blakenhall, Wolverhampton. L 51

BEE SMOKE!!—No. 1 P. O. Cartridges, 3s. 6d. per gross; half-gross, 2s. No. 2, ditto, 5s. per gross; half-gross, 2s. 9d. Orders over 20s. carriage paid. Address THOMPSON & NORRIS, Manufacturing Co. Limited, 37 and 39 Britannia Row, Essex Road, London, N. L 52

FOR SALE, in consequence of other engagements.—Twenty-five Stocks of English Bees in three-story Frame Hives, fully provisioned for Wintering, with three Sets of worked-out Combs, Frames of Excluder Zinc, Wood Feeders, &c. Can stand till Spring if desired. What offers for the whole, or any part? Apply to J. GREENSILL, Great Wyrley, Walsall, Staffs. L 53

FOR SALE.—Bees, English and Italians. Plenty of Stores. Apply T. HILL, Scotlands, Cannock Road, Wolverhampton. L 54

FOR SALE.—Four Stocks of healthy Bees, Bar-frame Hives, with this Season's Honey, 30s. per Stock, put on Rail. Address STUDIO, 57 Queen Street, Cardiff. L 55

GUIDE TO SUCCESSFUL BEE-KEEPING, post free 44d. Address C. N. WHITE, Somersham, Hunts.

NEW EDITION NOW READY.
21st Thousand.

THE BRITISH BEE-KEEPER'S GUIDE-BOOK.

By THOS. WM. COWAN, F.L.S., F.G.S., &c.
Revised and enlarged.

Almost entirely re-written. Much new matter and many fresh illustrations added.

Fcap. 8vo., price 1s. 6d.; or in cloth gilt, 2s. 6d.
Postage, 2d.

To be had of HOULSTON & SONS, Paternoster Sq.; all Hive Dealers, Secretaries of Bee-keepers' Associations, and of J. HUCKLE, *British Bee Journal* Office, Kings Langley, Herts.

WINTERING BEES. By THOMAS W. COWAN. The most complete work on the subject of Wintering published. Third Edition. Price 3d.

J. HUCKLE, Kings Langley, Herts.

BALDWIN'S is the Oldest Establishment in the United Kingdom wholly devoted to Bees and manufacture of

Bee-keepers' supplies. His prices will compare most favourably with those of any other Maker, while for quality of material, suitability and workmanship, he has no rival.

'Why can he give better value for money than others?' Because he spends less in large 'puffing' advertisements, buys in the best markets for prompt cash, has no rent to pay, and personally conducts his own business.

For prices and full particulars of Goods see Baldwin's Bee-keepers' Instructor (and Illustrated Catalogue combined), which 'contains more practical and reliable hints than all the large, expensive books,' post free for 2d. stamps. Address S. J. BALDWIN The Apiary, Bromley, Kent.

N.B.—More than 500 Silver and Bronze Medals, First and other Prizes, and Testimonials innumerable.

THE 'ENGLISH' HIVE.

Transferring Season now on.

TRY THIS HIVE, it is the best in use, and once used will be always used. No more cutting Quilts necessary, as the Bees can be fed from the side of the Hive. See description in *B. B. J.*, August 6th, 1891, p. 351. Price for Floor-board, Body, and Zinc-covered Roof, 11/6 only. The English Wax Extractor, price 7/6.

For particulars apply to A. T. WILMOR, St. Albans. 3149

British Bee Journal and Bee-keepers' Record.

OFFICE:

17 KING WILLIAM STREET, STRAND, LONDON, W.C.

PURE CANE SUGARS.

For the accommodation of Bee-keepers, guaranteed Pure Cane Sugar will be supplied in large or small quantities through this office at the under-mentioned rates:—

MOIST. (For Household Use.)

Neat bags, 14-lbs. 28-lbs. 56-lbs. Cwts.

3. MUSCOVADO 2/7 5/2 10/- 19/6

CRYSTALLISED.

4. DEMERARA } Crystals 2/9 5/4 10/6 20/6
5. BARBADOS }
6. TRINIDAD }

REFINED CANE.

7. WHITE CRYSTALS (Small) 3/0 5/10 11/6 22/6
8, 9. (Medium and Large sizes, 1/- per Cwt. extra.)
10. LUMP (Cut Loaf) ... Boxes, 3/3 6/3 12/3 23/6
11. LUMP DUST 3/ 6/- 11/9 22/9
12. PRESERVING 3/- 6/- 11/9 22/9

FINE. (For Household Use.)

13. GRANULATED 3/3 6/3 12/3 23/9
14. CASTOR Coarse (15 Fine) 3/9 7/3 14/3 27/9
16. ICING... .. 4/3 8/3 15/9 31/-

All above guaranteed made from CANE SUGAR only, and free from BEET, CHEMICALS, etc., etc.

CARRIAGE PAID on Orders over 5/0 (or 28-lbs. Sugar) to London and Suburbs.

COUNTRY ORDERS, not less than 2-cwt. carriage paid at 1/0 per cwt. extra.

(Scotch and Irish orders, special arrangements.)

CHEQUES payable to J. HUCKLE, Kings Langley.

Cash to be sent with order, and purchasers will please observe that if samples are required or replies asked to inquiries, a stamped addressed envelope must be sent, as we cannot undertake cost of postage.

THE
British Bee Journal,
BEE-KEEPERS' RECORD AND ADVISER.

No. 487. Vol. XIX. N.S. 95.]

OCTOBER 22, 1891.

[*Published Weekly.*]

Editorial, Notices, &c.

HONEY AT THE DAIRY SHOW.

The success attending the above show, as attested by the number of entries and the splendid quality of the exhibits staged has, we think, fully justified the Council of the Dairy Farmers' Association in once more establishing a department for honey as a special feature of their great annual show. If carried out in a liberal spirit, there are the best of reasons for believing that the popular autumn gathering at the Agricultural Hall may be made the occasion of one of the largest and most important honey shows of each succeeding season. Held, as it is, under the most favourable circumstances, at the time of the year when the bee-keepers' harvest is over, and honey of every class—heather included—and from every part of the kingdom is gathered in and available for showing, it affords an exceptionally favourable opportunity for bringing before an enormous section of the British public the excellence of our native product. Moreover, the surroundings are such as naturally lead themselves to make the exhibition a popular one in the eyes of bee-keepers themselves.

No place can be so suitable for the holding of what we should like to see become a national yearly honey show, as the metropolis of the kingdom—and what connexion so appropriate as that of the annual exhibition of the British Dairy Farmers' Association? 'A land flowing with milk and honey' was thousands of years ago synonymous with plenteousness and prosperity, so that even sentiment lends itself to the linking together of the two pursuits. Indeed, from whatever point the subject is considered, impartial observers will admit the force of our contention as to the appropriateness of the time and place for an annual display of bee-produce, such as we so earnestly desire to see realised. The distance from some of our best honey-producing centres to London may be considered a disadvantage by some, but cheap travelling minimises this drawback, and the many attractions hereabout help to repay the journey. Anyway, it is certain that an exhibition exclusively of bees and bee-produce, wherever held, lacks interest for the general public, while bee-keepers themselves do not exist in sufficient numbers at any one point to ensure success. This has been proved by former experiences in that line, and

so it becomes necessary to take advantage of popular gatherings where numerous and varied attractions suffice to bring about the desired result.

It reflects no discredit on a pursuit concerning which so little is known by outsiders as that of bee-keeping, to find that bee and honey shows, pure and simple, do not attract the public in large numbers; but wherever a good agricultural or horticultural show is held, the bee-department—if properly managed—is always one of the best patronised of any on the ground.

We say this much without being able to refer to the exhibition held last week as a case in point favourable to our view, the honey department being unfortunately placed in a corner so much out of the way as to be passed over unseen, except by those interested in seeking it out. Besides this drawback, it lacked the light so necessary to the advantageous display of honey in glass jars and in the comb. When it is stated that the staging had a brick wall for a background, those who know anything about bee-shows will understand the result. These are matters, however, which can be easily remedied another year, and will, no doubt, receive consideration in the proper quarter; but we cannot help saying that, had the honey at the Agricultural Hall been staged in a good light, where it could be seen on all sides, and arranged as those accustomed to such work could have arranged it, the display would have been enhanced in attractiveness tenfold.

Another point to which attention should be directed is the desirability for extending the number of classes, and a corresponding increase of prizes. In other words, it must be stated that to do bare justice to the exhibits in Class 63—for the best twelve jars of extracted honey—the class should have been divided into three classes, in order that the several distinct varieties of honey shown in this particular competition might be judged according to their respective merits. It seems absurd to practically disqualify bee-keepers located in some of the best honey-producing counties in the kingdom from successfully competing because they happen to be within reach of sources of supply other than exclusively white clover—and yet this is what it comes to in such a competition as that of last week.

That the judges had no alternative under the circumstances is obvious. Here were fifty-nine exhibitors, each staging twelve jars of honey—

in all, over seven hundred jars—and among this large number were, we suppose, winning exhibits from many shows held during the past season. In fact, among so many splendid samples it was no discredit to be, in sporting phrase, 'out of the running'—it could not be otherwise; and yet no fault could be found with many samples other than colour. With so many exhibits of high-class honey competing, and all other points, beauty of appearance included, being equal, light-coloured honeys carried the awards and a certain measure of what, on the face of it, looks like injustice, was in consequence, unavoidable. There is but one way out of the difficulty we refer to, and that is by allowing light-coloured and darker-coloured honeys to compete in separate classes, and by establishing classes for heather and for granulated honeys.

This would, of course, entail some extension of the prize list, and a corresponding increase in the amount given in prizes, but the additional outlay will be recouped by the increasing popularity of the show.

The judges, Messrs. J. M. Hooker and W. Broughton Carr, made the following awards:—

Class 63. Best twelve jars of extracted honey.—1st prize, H. W. Seymour, Henley-on-Thames; 2nd, Jas. Munro, Forfar, N.B.; 3rd, Wm. E. Little, Eastgate Row, Chester; 4th, Levi Inwood, Uffington. H.C.: W. Christie-Miller, Chelmsford; Matthew Whittle, Wantage; Rev. G. W. Bancks, Darenth; Thos. Badcock, Southfleet. Commended: A. Mayell, Bradwell-on-Sea, Essex.

Class 64. Best twelve one-pound sections.—1st., Wm. Woodley, Newbury; 2nd, The Cathedral Dairy Company, Exeter; 3rd, J. R. Truss, Ufford Heath; 4th, A. Hounsom, Chichester. H.C., Hon. and Rev. Henry Bligh, Hampton Hill. Commended: Spencer Hancock, Wytham Mill, near Oxford; Hy. Wood, Litchfield, Staffs.; W. P. Meadows, Syston, near Leicester; E. J. Oaten, Porthcurnow, Treen, Cornwall.

Class 65. Best twelve sections, any size.—1st, Geo. Neighbour & Sons; 2nd, The Cathedral Dairy Company; 3rd, James Munro; 4th, W. P. Meadows. Commended: Rev. G. W. Bancks.

Class 66. Best exhibit of honey in any form (not exceeding 1 cwt.)—1st, Wm. Woodley; 2nd, W. Debnam, Chelmsford; 3rd, The Cathedral Dairy Company. Commended: J. R. Truss, Stamford; H. Harvey, Hanwell, W.; Jabez Sopp, Crowmarsh, Wallingford; Chas. T. Overton, Lowfield Apiaries, Crawley.

That the honey department of the Dairy Show is likely to become popular with exhibitors, we need but to point to the fact that in the four classes seventy bee-keepers competed, in that for the 'best collection of honey in any form' producing fourteen most creditable exhibits. The prize collections were all handsome, that of Mr. Woodley, which took a well-deserved first, being both tastily arranged and an excellent sample of skill in honey production and 'get up.' It consisted almost wholly of sections, the wood of

which, while beautifully clean, was simply edged round with white paper, with a narrow edging round the glass of white lace paper, giving the well-finished sections a most tasteful appearance. No wonder the whole exhibit, as it stood, was readily sold. The second and third prize collections were also very good; indeed, the whole fourteen exhibits in this class were a credit to those who staged them.

Class 63, for 'the best twelve jars of extracted honey,' was, however, the feature of the show from a bee-man's point, no less than fifty-nine competitors, as already stated, staging one dozen jars each. We need add nothing more to what has already been said as to the quality of the exhibits in this class except to observe that it cost the judges a considerable amount of thought and trouble to arrive at a safe and just decision where there was so much general excellence and so many high-class exhibits competing. None, we are sure, will more heartily welcome the advent of a change such as we have suggested than the judges who were regretfully compelled to pass over exhibits well worthy of recognition.

The class for the best twelve one-pound sections was also an excellent one, comprising forty-one entries, the great majority of which reflected much credit on the several exhibitors both for 'get-up' and finish. Good sections were the rule, but a few of the exhibits were instructive in several ways. For instance, the one in which the sections were encased in bright red paper, with an 'Oxford border' of white tape across the front. Now, if there is one colour which harmonises exceptionally ill with white comb honey, that colour is red, and when the covering on the face of the glass allowed less than three inches of the centre of the comb to be visible, the effect may be imagined. Besides, by concealing the comb, it practically disqualified the exhibit, and caused not a little wonderment at the want of good taste displayed by the exhibitor.

As a contrast to this misguided effort at 'decoration' two other lots were staged minus covering or protection of any kind—just as taken from the hives, without any clearing or scraping away of propolis at all. These were far more discreditable as exhibits than the other. In Class 65, 'Best twelve sections, any size, not exceeding two pounds,' there were eleven entries, including some good samples of two-pound sections; but we cannot help considering this class to be a mistake, and that the prize money awarded to it might have been better applied in other directions; but we must not be hypercritical considering how capital a display was made in all the four classes. Taking it as a whole there was material for one of the best shows ever held, and if properly guided and managed by experienced hands—as we trust future exhibitions at the same place will be—there is no reason why the bee-department of the Dairy Show may not become a popular annual gathering of bee-keepers each succeeding autumn, tending to strengthen and consolidate the cause we have so much at heart.

CAREFUL HANDLING OF BEES.

If there is one point I would impress upon the mind of a novice in bee-culture more than another, it is to acquire the habit from the first of very careful handling.

While attending a National Bee Convention at Cincinnati, I was surprised and delighted with the good behaviour of Mr. Muth's bees. There were about forty colonies on the roof of his store, and there were about as many visitors as could be accommodated in the passage-way between the rows of hives. I do not remember that Mr. Muth used any smoke; I rather think he did not. He opened the hives, lifting out combs, and pointing out the queen to the visitors, who stood closely around. No one present had any protection, and though it was late in Fall, when no honey was being gathered, there was no stinging.

AMIALE BEES.

Bees came in and out of the store, and customers did not appear to notice them more than flies. If a bee touched the hair of one of Mr. Muth's sons, he very gently brushed it aside. I said to one of them, 'Do you ever kill any bees?' He said, 'Oh, no! if we did, father would go for us.'

After inspecting the apiary of Mr. Muth, a party of us took carriages, and were driven to Mount Healthy to visit the apiary of Mr. Hill. Here I noticed the same thing. While a party stood around an open hive, I kept at a respectful distance, and remarked to a daughter of our host, 'I never before saw any bees like yours here in Ohio.'

She replied, 'It is all in the handling. My brother used to help father, and the bees were very cross; but since I help him, they are not so any more. I work gently, and never jar them, or strike at them with quick motions, and they never get excited.' Hives manipulated without snap or jar are most desirable. Our first hives had the frames covered with a board that pried up with a snap, which caused the bees to immediately elevate their tails, and a tiny drop of poison was occasionally seen. When, in lieu of this board, duck or heavy muslin was used, it was a move in the right direction, for this could be peeled back without causing any disturbance at all.

SMASHING BEES.

This is another justifiable cause for war, as it releases the poison, and the scent of it angers them. When the clothing of a person has this scent, bees will attack it when near their hive.

In most apiaries of any size, there will often be a score or so of bees which appear to follow war as a business—never apparently going to the field for nectar, but watching the doors for some one to attack. The best way to manage such fighters is to dispatch them at once. A palm-leaf fan is a good weapon; knock them down and step on them. This is much better than to be annoyed by them for weeks.

BEES DURING A SCARCITY OF HONEY.

Hives should not be opened during a scarcity of honey, unless it is absolutely necessary. Robbers will come around, and then stinging will be the order. During such a time I have occasionally fed a colony a little for a day or two, and then opened them at a time of day when there was honey in the fields, or when few bees were flying.

To-day I discovered a hive which was queenless, and the moths had moved in. As I took out the moths I discovered a little honey, and the robbers did so at the same time. I let them eat it, as I usually do. If I had taken it away, they would have tried to enter adjoining hives, but let them carry it off and they are satisfied when it is gone. The hive is now desolate, and I shall use the combs in building up small colonies, by removing a comb of brood from strong colonies, giving it to the weak, and putting the empty comb in the place of the one removed from the strong one. If there are any grubs of the bee-moth in them, a strong colony will soon roll them out, to the delight of an old hen, which has the freedom of the apiary.—O. J.—Farmer.

Correspondence.

The Editors do not hold themselves responsible for the opinions expressed by correspondents. No notice will be taken of anonymous communications, and correspondents are requested to write on one side of the paper only, and give their real names and addresses, not necessarily for publication, but as a guarantee of good faith. Illustrations should be drawn on separate pieces of paper.

Communications relating to the literary department, reports of Associations, Shows, Meetings, Echoes, Queries, Books for Review, &c., must be addressed only to 'The Editors of the "British Bee Journal," 17 King William Street, Strand, London, W.C.' All business communications relating to Advertisements, &c., must be addressed to Mr. J. HUCKLE, Kings Langley, Herts (see 1st page of Advertisements.)

*. In order to facilitate reference, Correspondents, when speaking of any letter or query previously inserted, will oblige by mentioning the number of the letter, as well as the page on which it appeared.

NOTES BY THE WAY.

[814.] The weather has not improved yet. Tuesday last was one of the wettest days on record. The rest of the week stormy, finishing up with a continual downpour on Saturday. During next week we hope to get a change for the better, and enjoy the proverbial St. Luke's little summer, when we shall seize the opportunity of putting the finishing touches to the apiary before winter.

Flour as a Pacifier.—During the past fortnight I have used flour in several cases when uniting, and can fully endorse all that has been said in its favour as a pacifier of bees. I generally use scented syrup for uniting. This plan, if conducted with care, is usually successful, but not so reliable as flour sprinkled on both lots to be united. A dredger is the best sprinkler, but a good substitute can be made from an empty snuff-tin—cost, 1d.—from the grocers. Punch some holes in the lid, and the

distributor is ready for work. These tins also make a very good heater for the uncapping-knife, and with two of them—one in the extracting-room and the other on the hob ready to exchange places when the water gets too cold in the one in use—uncapping can be carried on continuously; or, with a small stove, one of the said tins will fill the bill.

Cheep Feeders.—Here again the snuff-tin comes in useful, and a square piece of wood, with a three or three and a half inch hole cut in it, will form a platform on which a tin of food can be inverted, of course first punching some small holes to give the bees access to the syrup. This, placed over the feed-hole of quilt, will make a rapid feeder for 1*l.*, and at the same time an effective one, as no outsiders can reach the syrup even if they get inside the roof, though I would caution the novice not to allow access to the syrup except to the bees inside the hive, and only to feed during the evening, and to carefully wrap up the feeder with some soft material to keep in the heat of the colony.

After the major produce of the apiary (*i.e.*, the honey) has been put on the market, the minor product should not be neglected or lost sight of, neither allowed to lie about as a harbour for moths, &c. I mean the wax. All old combs and odd pieces, with the scraps that have been scraped off the sections from time to time, should be rendered into wax either for sale or to be made into foundation for use another year; and where a large quantity has been accumulated, it is good policy to select the lighter-coloured combs and melt alone, leaving the old dark combs to melt afterwards. This leads on to the subject of old combs and their use in the apiary. The question is often asked, 'How long shall I use combs in the apiary?' I answer, 'Till they are clogged with pollen.' I remember Mr. W. B. Webster showing me some combs over twenty years old on which bees had been bred continuously, and which, to all appearance, were as useful as in their third or fourth year of existence. I myself have some in use now in a straw skep fourteen or fifteen years old, and some in frames ten to twelve years old, though, for practical work, I consider combs should be renewed every six or seven years, and oftener than that if they get clogged with pollen, on lines of policy, as bees will draw out a sheet of foundation into a beautiful comb much quicker than they will pare down and cut out patches of dried pollen, and then probably fill the space with drone-size comb, whereas, with the sheet of foundation, the comb is all the size cell we want.

Cocoa matting makes a capital cover for straw skeps where straw hackles cannot be obtained. One thickness of cocoa matting will keep off more rain than three or four old sacks, and soon dries after the rain is over. A piece of old carpet or canvas is placed on the hive, then over that the square of cocoa matting; then a piece of broken pan or an inverted milk-pan will secure the straw skeps from the rain.

Enemies of Bees.—The lateness of the harvest has kept some of the cottagers from taking up their bees till late this season, and when I have gone to drive the bees I found in several instances mice had made nests on the tops, amongst the old bags, &c., that cover the hives. These pests should be attended to and trapped, or loss of the stock will probably result before the winter is over.—W. WOODLEY, *World's End, Newbury.*

HOME-MADE APPLIANCES.

[815.] I was very pleased to read your remarks on the above subject on p. 449 of *B. J.*, for I think the matter has hardly received the attention it deserves. To my mind the contriving and making of one's own appliances is only second to the care of the bees themselves. I have often thought that more people of the humbler classes would be induced to keep bees could they be led to see the practicability of making their own hives, &c. The bee-tent at shows, with its lectures and exhibitions of driving, I don't think does the good that some imagine; the glowing accounts given tempt some to purchase a hive of some wonderful make, and, after a few vain trials at carrying out the lecturer's instructions, to give it up in either disgust or despair. In my own experience I have seen that those people who are the most interested in the making of their own appliances make the best and most lasting bee-keepers. I have heard the remark frequently from men of my own standing that they would give up bee-keeping only they like the job of making the hives and their belongings. On the other hand, people who have embarked in the pursuit with no knowledge or desire to make their own appliances soon seem to give it up and lose their interest in it.

The desire to make your own appliances leads one to study the best forms, and gives a greater interest to all we may see and hear concerning them. I well remember looking at a frame hive for the first time, and studying it, long before I thought of keeping bees either for pleasure or profit. My first idea was to improve the appearance of the garden and gratify my love of carpentry; and soon the love of both the bees and all belonging to them grew upon me, and I have no doubt mine is an experience common to many. I was in hope, when the 'papers for winter reading' were projected last winter, some would have dealt with the subject. I should be glad to see it taken up this winter, especially after so many amateur appliances have been contrived for swarm-catching, super-clearing, feeding, &c. I think we ought to keep a good class of work in view; we get plenty of directions from time to time how to make hives from soap-boxes, &c., for next to nothing, but I should like to see hives and their belongings a credit to their owner and pleasant to look upon. Suggestions of shapes of hives and roofs, and combinations of colour in painting would tend to make the pursuit attractive and interesting.

I can hardly agree with you about not making one's own frames. I find it very interesting, although, perhaps, not very remunerative. My chief ambition has been, and is, to make everything in connexion with my apiary—hives, frames, extractor, smoker—which I have succeeded in doing, only buying foundation and sections. In conclusion, I would ask, Why should there not be a class at shows, especially local ones, for exhibits the work of amateurs only? I don't know whether such a class has been tried, but I believe it would interest and benefit many people in the lowly position of—
THE VILLAGE BLACKSMITH.

HOME-MADE FEEDERS.

[816.] I was very pleased to see my home-made feeder so plainly described in the *B.B.J.*, and I think the pieces you suggest to give bee-way beneath box would be an improvement, but they are not really necessary. With your permission, I will describe the way I use the feeder:—I place the feeder flat on the quilt next to the frames, with its bee-way at back of the hive. I then double back the quilt far enough to allow the bees free access to feeder; on the small openings at the side caused by doubling the quilt back I lay anything that comes handy, wood or cardboard, or suchlike. For slow feeding I place the feeder flat over feed-hole in the quilt, making certain the holes in the bottom are directly above one of the spaces between frames, and the tiny stream trickles direct to the cluster, so that no disturbance of quilts is in any way necessary. I hope you will excuse me for troubling you with this, but I am afraid many readers would feel disgusted with me for suggesting a feeder rendering it necessary to disturb quilts and bees at each operation of feeding; for, as a matter of fact, I have never had one beneath the quilts, and the bees seldom seem aware of the operation. If you would explain this to your readers for me, I should feel obliged, as it is likely to convey quite a wrong idea.—GEO. WM. HOLE, *Patcham, Sussex.*

[The only thing needing explanation is the fact that our correspondent removes all extra coverings and places the feeder above the one quilt next the frames; and, as this is usually a piece of American cloth, or some other thin material, there would be no difficulty in doubling it back below the under surface of the feeder.—Eds.]

INCONSISTENT SHOWING.

[817.] Mr. Gay treats my desire for certain information (see 776, p. 419) with silence. It may be the silence of scornful innocence, or the silence of guilt—which? Since he himself withholds the desired information, is there any one else who can give it? If it should not be forthcoming, I, for one, will have no alternative but to come to the uncomfortable conclusion

that Mr. Gay has been guilty of not quite straightforward practices.

As to Mr. Sims, there was probably nothing to explain beyond what the queries themselves contained. The circumstances were unusual, but not, it appears, beyond the bounds of possibility.—J. MORGAN, *October 12th, 1891.*

THE DAIRY SHOW.

[818.] Now that the Dairy Show honey exhibits have passed and gone, I should like to invite the opinions of exhibitors in the honey classes as to the desirability of seeking a reduction in the entrance fees. Since competition is keen and prizes small, it is not much inducement for members of associations (especially cottagers) to go to the expense of sending honey. In my case the expense was as follows:—Entrance fee, 2s. 6d.; carriage two ways, 2s. 6d.; total 5s.—to say nothing of buying clear bottles for 'get up' in appearance, packing, box, &c.

Then, again, all exhibitors (except those whose fees amount to 20s.) have to pay to go into the show. Surely this ought not to be. I think all exhibitors should be provided with one free admission on any day for every 2s. 6d. paid.

I think 1s. for each entry is sufficient, and when fees amount to over 2s., give one free entrance to show. Lastly, Mr. Editor, I should like to see a class for candied honey if the show is held in October every year.—AN EXHIBITOR.

WILDMAN ON BEES.

(Concluded from p. 471.)

[819.] WINTERING.—A method of covering bees with dry earth, after making provision for ventilation, is described. Stone floors for hives are condemned, and even wooden ones for winter, and straw mats recommended. Hives are to be cleaned in spring, and particular care is to be taken when brood-rearing commences that the bees be not short of stores.

From an 'Appendix containing Extracts from *De Re Rustica*; or, *The Repository for Select Papers on Agriculture, Arts, and Manufactures*,' I take the following extracts:—

'I kept two hives shut up in a dark, cold outhouse from the middle of September to the middle of April, without ever letting them see the light. Upon their being set out in the warmer air, they recovered immediately, and showed an appearance of more strength than the hives did which had been kept out in the usual way. This appearance of strength continued during the summer, and they multiplied faster than I had ever observed them to do before.'

'Whensoever you come among them, being offended, it is better to be guarded against them. "Some drink a cup of good beer," says Mr. Worlidge, "and find that sufficient; others wash their hands and face therewith, which proves a good defence. . . . But the most secure way of all is to have a net knit with so small meshes that a bee

cannot pass through, and of fine thread or silk large enough to come over your hat and to lie down to the collar of your doublet."

'Let a hog eat some handfuls of malt, pease, or other corn, in a hive which is musty, and turn the hive so that the froth which the hog made in eating may go all about the hive; and then wipe the hive lightly with a linen cloth; and so will the bees like the hive better than a new one, being first rubbed with some sweet herbs.'

'Such was the year 1616, when not only many swarms did swarm as old stocks, but also old stocks, having betimes swarmed twice, about six weeks after began to swarm afresh, as in another year; and so, in effect, had two summers in one.'

'The greatest store of honey is drawn out of the black spot on the little picked leaves of the vetch, which grow on each side the two or three uppermost joints. These they ply continually. I never saw vetches, how far soever from hives, that for three months together, if the weather served, were not full of bees.'

'The greatest plenty of the purest nectar cometh from above, and the oak receiveth the same on his smooth and solid leaves; which, when the honeydew falls, shall have more upon them than on all the other plants. If conjecture might be admitted, I would judge the honeydew to be the quintessence of all the sweets of earth, drawn up into the lower region of the air by the continual heat of the sun, and there condensed by the cold of the night into this most sweet sovereign nectar, which doth then descend in dew or drizzling rain.'

These extracts are not from articles by our author, but by other writers.—S. INGHAM.

PREVENTION OF SWARMING— IMPORTANT TO ALL.

[820.] The number of complaints which the 'reports' published by you in October contain of much annoyance and reduced surplus, caused by swarming, warrant me in again urging upon your readers the advisability of trying some such method of prevention as those I have been advocating during the past season. No other systematic course of action has been proposed, although, as an alleviation of the evil, the advice of Messrs. Dadant & Son (*Record*, p. 152), to minimise drone-rearing, is worth bearing in mind for practice next year.

Although I am now, to my sorrow, absent from St. Beuno's College and its apiary for some years to come, I feel it incumbent on me to put some kind of finish to the articles I have written upon the subject of swarm-prevention by summarising our own experiences during the past season. Any generalisations from them, or from those of the last two years, must be hazardous until all sorts and conditions of weather have played their part in determining failure or success; the season of 1891, broken and irregular, as only an English summer can be, could not in any case furnish a standard of comparison. If our efforts during it were not successful in stopping swarms altogether, the failure was due, not to the system, but to our implicit

reliance upon the dictum of certain well-known scientific bee-keepers, who say that *five or six days after the removal of the laying queen, no grub will remain which the bees can transform into a queen.*

Relying upon the truth of this principle, we were not particular as to whether we 'cut out all queen-cells but one' seven and eight days, or five and six days, after removal of each laying queen. That seven days is the absolute limit I cannot yet assert, but certain it is that stocks operated upon on and after the seventh day did not swarm, while those similarly treated on and before the sixth did so. The swarms we returned whenever circumstances permitted, although at the risk of sacrificing, in each case, what was, naturally speaking, the better queen.

As regards surplus, it may be remembered I did not at all aver that an unswarmed stock would, or could be expected to, give as large a return as that of a stock and swarm taken together; so that we have reason to rejoice that our honey receipt for 1891 compares more than favourably with the best returns sent in to you so far from all parts of the country. That our spring weather, at least, was not better than elsewhere (the sea-side of a Welsh hill is not balmy at the best of times) is exemplified by the fact that we were a month later in removing queens this year than last; our take, however, was 608 lbs. from eight stocks, or an average of 76 lbs. per stock, as against 63 lbs. in Herts and 64 lbs. in Cheshire, the two highest of your reports.—S. J.

FOUL BROOD IN SCOTLAND.

[821.] Bee-keepers about here have been giving more attention to foul brood than they did some years ago, and a decided improvement in the condition of stocks is the result. I have seen only one case of virulent foul brood this season, and that was in a bee-tree. A friend asked me to take the honey for him. On getting to the tree I found that the entrance was seven or eight feet from the ground, and before ascending I distinctly felt the abominable smell being gently wafted from the entrance. Although knowing that there was some risk in carrying infection, I was curious to see the contents of these plague-stricken tree, so I cut away part of the tree to get at the combs. From their appearance I am of opinion that the disease had been there for some years, perhaps many years, as the combs were very old, and from inquiries made it would appear that the bees had several times died out during winter, and the tree been re-stocked at swarming-time. I destroyed both bees and combs, and plugged up the entrance, so that no more swarms could get in to such a dangerous habitation.

I have not the slightest doubt but that this tree has in former years been the cause of a great deal of trouble to neighbouring bee-keepers.—J. S., Stonehaven, N.B.

BEES IN COUNTY WEXFORD.

[822.] I wish to let you know how my bees got on this year, located as they are about the central part of county Wexford, Ireland, a late district for bees, as no honey is got until the middle of June.

I began the season with ten stocks in frame hives, and worked four of them on Simmins's non-swarmer system, which, I am sorry to say, proved with me a failure. Two of the hives I tried it on were the strongest I had, and two of them the weakest; the strong ones swarmed out to their hearts' content, and the weak ones neither swarmed nor filled sections. These four stocks filled about seventy sections and a few unfinished ones. I would like to know how this system worked with other bee-keepers. My other six stocks I worked in the ordinary way for section honey; they gave me 400 finished sections, and about 130 unfinished. I sold 470 first-class, and had seventy not fully finished for my own use, while I gave seventy unsealed ones back to the bees to clean out. This was not bad for a cold, wet season, my stocks averaging fifty sections each, without counting the unfinished ones.

The average for my three years' bee-keeping in frame hives was from forty to forty-five pounds per stock, while I have increased my stocks from ten to fifteen by swarming. I increased them one stock for every three swarms, and I have now still further increased to eighteen by driven bees. I joined three lots of driven bees in each hive, and fed them on honey from skeps, which I found cheaper than sugar, and a great deal better, too, as they took down all that was needed in about twelve days, and had it sealed over by the 1st September. I give the honey in a round tin feeder, with glass cover to keep robbers away. I had a swarm on the 5th July, which was about settling in a privet hedge. I stood close by to try and see the queen in the cluster, when I suppose she alighted on my arm, for in a shorter time than it takes to tell it, the whole swarm was hanging from my arm. A skep was brought which I placed on the ground, and gave a sharp jerk to my arm, when all ran into the hive.—J. D., Co. Wexford.

BEES IN CALIFORNIA.

[823.] A friend in Arlington, Riverside, California, sent me a copy of the *Weekly Chronicle*, from which I took the enclosed cutting. He wrote the word 'true' over the article, and I can depend upon him. Perhaps it may be of interest to yourself or readers of the *Journal* if you can find space for it. So far as I can gather, bees have done fairly well in this quarter, although we have had it somewhat wet and stormy for some time past.—JOHN PETERS, *Gourcock, N.B.*

'Who ever heard of a church being flooded with honey? The very idea sounds ridiculous, and in any other place than California would

excite only a smile of incredulity. The average tenderfoot would certainly class it with the "snipe-bagging" and other attempts to impose upon his verdancy, while an Eastern man would undoubtedly snort out something or other about "another California lie." We have all heard about places that "flowed with milk and honey," and metaphorical references to the "droppings of the sanctuary" are familiar, but it has remained for a swarm of bees to make literal facts of these familiar metaphors.

'It appears that a lot of vagrant bees, while in search of a suitable home, found an admirable location in the loft of an Episcopalian church in Tulare county. Here, having an abundance of space, they increased and multiplied, and at the same time laid in a large store of honey. Great white combs were attached to the rafters overhead, and were built downward, and added to until hundreds of pounds of sweetness were hidden away in the delicate white waxen cells.

'It was, indeed, a bee-paradise. The veiled marauder, armed with smoke and knife, could not trench upon the stores thus laid away. Here none of the four-footed, sweet-toothed enemies of the synonym of industry could take advantage of the defencelessness of the little insects. The admonition so often spoken from the pulpit beneath to lay up treasures above, where neither moth nor rust could corrupt, nor thieves break through and steal, was patiently heeded and faithfully carried out.

'One contingency, however, was not provided against, and, indeed, was not expected. The normal temperature in the contracted proportions of the loft was of a character admirably suited for the best advantage of the bees, and, had that temperature continued, this story would never have been written.

'It is almost unnecessary to remind the readers of the *Chronicle* that a week or two ago California was visited with something bearing a remarkable likeness to a sirocco. In a word, it was hot—deucedly hot. To be sure, it was impossible to locate the area of the heated wave. The *Milpitas Bladder* insisted that the weather there was delightful; but just over the county line the thermometer showed something like 115 degrees in the shade. The *White Bluff Corporal* casually remarked that over in Platoville it was hotter than Hades, but in its own immediate vicinage the cooling breezes from the bay made the temperature delightful. The *Los Diablos Hurled* jeeringly called attention to the alleged fact that the northern cabbage belt showed a temperature considerably higher than that of the southern potato section, and in the next breath patronisingly advised its northern friends to take their oranges in out of the frost. So it went from one end of the State to the other. No place could be found to acknowledge that it was as warm as any other place. By common consent the difficulty was finally settled by a combined attack upon San Francisco, where, if the press of the interior were to be believed, it was hotter than—well, hotter than Arizona.

'But down in the loft of the church, where

the bees were holding high carnival, the temperature rose and rose, until it reached the melting point. Wax gave way beneath the torrid heat, and now, down the rafters, along the scantlings, over the laths and down the joists, began to flow streams of liquid sweetness. They found crevices here and there, and soon altar, pulpit, chancel, furniture, prayer-books, and all the belongings of the interior of the sacred edifice were treated to such a deluge as the world had never seen. Efforts were made to stay the sticky tide, but these were only partially successful, and before anything could be done the interior of the church was a sight to behold, and damage had been done that required considerable expense and hard work to remedy.

'Bees develop many peculiarities on this coast which are unheard of elsewhere. While the eastern bee-keeper is hard pressed to devise means of sheltering and protecting his charges through the winter, in this State the bees frequently evince a distaste for any artificial protection whatever. Cases have been known where swarms have left comfortable hives and betaken themselves to a tree, where, clustering on the limbs, they have proceeded to build combs and gather honey as calmly as though provided with all the latest improvements in movable frame hives, comb foundation, &c.

'In many places, particularly in the southern part of the State, caves in the mountain-sides have been taken possession of and literally filled with the nectar gathered from the myriad honey-producing wild flowers. There is a remarkable instance of this sort of natural beehive in the Cajon Pass, north of the city of San Bernardino. In a precipitous bluff rising from the bed of the creek that flows through the canyon is an opening in the rock large enough for a man to walk through. Over this a rude door, made of wide-meshed wire netting, has been placed, so that while the ingress and egress of the bees is not hindered, the stores of honey cannot be molested except at the will of the person having the key of the door. The cave penetrates far into the hillside, and is literally alive with bees. Away at the back the combs hang from the rocks for several feet downward, and are literally black with age. Toward the front many fresh combs are seen, some already sealed over, and others being filled with honey. It is evident that there must be many swarms in the cave in order to have produced as much honey as is stored away within its rocky walls.

'The bees of California are ambitious workers, and when their hives are not kept clear of the surplus honey will put their stores in all sorts of places. The writer once had charge of a large apiary, and the season was so favourable that it was impossible to take the honey from the hives as rapidly as it was stored. In one case there were three hives standing on some scantling, with about a foot of space intervening. Having filled the vacant boxes, the bees next turned their attention to the outsides, and filled the space between the hives and also underneath them with a solid mass of honey. So closely

were the hives fastened that it actually required the use of a crowbar to pry them apart.

'Down at Temescal, San Bernardino county, near the famous San Jacinto tin mine, there is a veritable mine of honey. Actually and literally this is a fact. There is a large force of men employed at the tin mine, and they put in their idle time prospecting in the hills in the vicinity. One Sunday half a dozen of the miners applied to Colonel Robinson, the Superintendent, for the privilege of using some giant powder and a few tools. He asked them what they wanted to do, and they replied that they had found a honey mine, and proposed to tap it. Laughing, he gave his consent and an order on the store-keeper for the desired articles, and, with a supply of pails and tubs, the men set out on their expedition.

'They were gone all day, and along toward sundown a sorry-looking procession came over the hill and made its way to the employes' headquarters. They had tapped the mine, there could be no question about that. They were sticky with honey from head to foot. Hair and beard dripped with it, like unto the appearance of Aaron when he was anointed, even so that the oil ran all over him and down to his feet. Their clothes were liberally plastered with a mixture of honey and mud; there was honey everywhere. But the tubs and buckets were full of honey as well, for a rich lead had indeed been struck.

'But the miners had paid dearly for their trouble. Their faces were puffed up and swollen, eyes were almost closed, and there was not a square inch of exposed cuticle but showed the marks of contact with the torrid business end of the insects who had been robbed.

'The men, it appeared, had found a crevice in the rocks whence issued a constant stream of bees, and from this they judged that there must be a large quantity of honey in the recesses of the cliff. The opening used by the bees was too small to admit of the passage of a human being, and after carefully examining the place a tunnel was commenced a little way from the entrance, and after this had been run the right distance an upraise was put in, which by good luck struck the ledge of honey in its centre. After a hot contest with the bees several hundred pounds of comb honey were taken out, and the tunnel was then closed up. Several times since additional supplies of the sweet material have been taken from the cave, which is now regarded as a permanent feature of the property of the San Jacinto estate.'

Queries and Replies.

[443.] *Wintering a Small Swarm.*—I shall have in a few days a small swarm of Italian bees direct from Italy, by parcels post, weighing one kilo. Will you kindly tell me how to best keep them through the winter? I have plenty of 'W. B. C.' spare combs. If I have on these would one crate of nine frames be sufficient for

wintering, and how much liquid ought I to give them?—W. T. C., *Essex, October 15th.*

REPLY.—The safest course will be to give the bees sealed food in combs if you have such on hand; otherwise we would fill the combs with well-prepared warm syrup, by hanging them in a water-tight box and allowing the syrup to run in slowly, as suggested by Mr. Hooker. The syrup will expel the air from each cell as it enters, and when full the bees will make all dry and tidy, with a tithe of the labour it would cost them to take the syrup down. We must remind you that it is not a very easy task to prepare a *small swarm* for wintering safely, and care will be needed to ensure success.

[444.] May I ask your advice on the following? A fortnight ago I drove some bees, and transferred them to a bar-frame hive. On looking a few days later I found the queen all right, but on examining again a week later I could not find her. She has left a few eggs, and the bees are bringing up no less than seven queens. Will they be any good, or shall I have to re-queen?—F. CLARKE, *St. Leonards, October 12th.*

REPLY.—No doubt your first examination after transferring has unfortunately caused the mischief; but for that all would have gone on well. As it is, there is no course but to give another queen if the bees are to be saved.

[445.] *Section Boxes.*—As I make my own hives and all fittings, I am thinking of making some of the section boxes as illustrated in the *B.J.* for June 18th, page 276. 1. I would like to know if the timber on which the end of the frame rests is smaller to the side of the section box, or does it stand, as in double-walled hives, with an air-space between? as from the illustration it appears the box is level with the top of the frames on head. 2. Are slatted dividers better than plain ones?—J. D., *Wexford.*

REPLY.—The section box is double-walled on the sides whereon the ends of hanging frames rest, the space between being enclosed top and bottom. It would be far safer for you to purchase a pattern box to work from before making any number of them. 2. Slatted dividers are necessary for four bee-way sections.

[446.] *Feeding Up for Winter.*—1. I was unable to attend to my bees in September through absence, and on examining them now I find they have seven frames about one-third sealed over and about one-third more not sealed. Will this be sufficient to last them the winter? If not, is it too late to feed them now, and about how much ought I to give them? Also, will candy do as well as syrup? Should it be soft or hard? 2. Would it be possible to remove the bees into a shed for the winter? If so, would it be advisable? This being my first year in bee-keeping, I am very anxious to learn.—EDWARD DOUGLAS, *Underhill Road, S.E., October 14th.*

REPLY.—1. If your description of the contents of the seven frames is quite correct, there

should be about twenty pounds of food in them, and this would suffice till March next, when a cake of soft candy can be given. If there is less food than we suppose, the candy may be given now, and the bees warmly packed above it.

WEATHER REPORT.

BUCKNALL, LINCOLN. BM. 25.

September, 1891.

Max., 80° on 10th,
11th, and 13th. Rain:—1.42 inches.
Minimum, 32° on 2nd. Average, 5 years, 1.56 in.
Mean max . . . 67.8° In 24 hrs. '69 on 14th.
" min. . . . 45.3° Rain on 11 days.
" temp. . . 56.5° Several frosts.
" of 6 years 54.3° Range, 22.5°.

Remarks.—A warm month, giving the maximum day temperature 80°. The change came too late to be of any use to the bees. The bee-keeper got a good chance for feeding, which has been very necessary, as some fifteen stocks have died out in this neighbourhood.—J. BENT.

GLEANINGS.

In the *American Apiculturist* W. Norton describes a new method of providing bees with a passage-way over the combs. He uses two frames of combs, such as he uses for extracting, the frames being 12 $\frac{3}{4}$ inches long, 4 $\frac{1}{4}$ inches deep, and 1 $\frac{3}{8}$ inches thick, which gives combs 1 $\frac{1}{2}$ inches thick. These, emptied of their honey, are placed crosswise on the top of the brood frames, flatwise parallel to each other, about two inches apart. Then they are covered over with a cloth and packing. He thinks that combs placed in this way retain the heat, and keep the bees more comfortable, as he found them clustered close underneath these combs.

Dr. O. W. Beyer, according to the *Journal of the Royal Microscopical Society*, maintains that the stinging apparatus in *Formica* is a retrogressive modification of that possessed by *Apis*, *Vespa*, *Myrmica*, and other hymenoptera. He bases his argument on a solid foundation, for he traces the development of the apparatus through eighteen stages in *Apis mellifica*, through fifteen in *Vespa vulgaris*, through eleven in *Myrmica levinodis*, through eleven in *Formica rufa*. In all four the essential parts of the apparatus, their arrangement, and their relation to the surface of the body, and the succession of developmental stages, are the same. From among the interesting facts which Dr. Beyer brings forward to show that the apparatus in question is retrogressive, not progressive, we may cite the correlation between the poison gland and the sting. In *Apis* the sting is most complicated, the gland is simplest; in *Formica* the sting is reduced, the gland is very large; the other two genera, *Vespa* and *Myrmica*, are precisely intermediate. It seems most plausible that in the

ancestors of *Formica* the sting ceased, for some unknown reason, to be very effective; there was the more need for abundant poison, and the gland grew; the muscles of the sting degenerated, those of the poison reservoir and the duct increased in strength.

In the *Prairie Farmer* Mrs. L. Harrison says:—'The public are waking up to the importance of honey as a remedy for ills that flesh is heir to. A boy comes regularly to our honey-house, saying, "I want some more honey for father." He says that honey is the best medicine for his lungs that he has ever had. Honey is in demand for the baby's sore mouth, sister's throat, and mother's cough.'

Echoes from the Hives.

Morchard Bishop, North Devon, October 17th.
We have had a very moderate season here as elsewhere; excepting for about a fortnight in June and a week in July the weather was wretched. If it did not rain it blew, and, unfortunately, my bees get the full benefit (?) of the breeze. I have packed up my hives for winter now, except for putting in the candy, which I prefer to do later, as at present they would eat it up, and have helped such of my neighbours as are willing to be taught in wintering theirs. To-day (October 18th) I saw all my hives enjoyed a temporary lull in the storm and a snatch of sunshine, and were out airing and carrying in pollen in some quantities. By-the-by, I do not remember to have seen it mentioned anywhere that the bees will take old propolis and carry it home on their legs like pollen. I saw my bees scraping the propolis from a piece of excluder zinc I left near the hives in the early summer. Is oil of winter green (*Gaultheria*) the basis of the sting-preventers? It acts like a charm. I had one hive I was almost afraid to take the honey from, as I could not do anything to it without getting several stings; but the winter green seemed to soothe the savage beasts. As it is the source of salicylic acid, and contains ninety per cent. of methyl-salicylic acid, it should be at the same time a sting-preventer and antiseptic.—A NORTH DEVON BEE-KEEPER.

Epsom.—I was about to give particulars of my large honey yield, but since reading Brondesbury 'Echo' I find mine is but a barely medium yield for my two stocks. One hive gave me fifty-five pounds of extracted honey and six finished sections; another, fifty-three pounds extracted, and ten sections. I have a third hive, a swarm I bought this year, but have not taken any from this, as I like to leave plenty of natural stores, believing, as I do, that foul brood, of which I have read so much, may arise from impure sugar, causing dysentery, and then eventually developing into foul brood. I gave, after extracting, the bees the frames to clear up while I was away from home; on returning in about fourteen days, I found one stock had

cleaned the frames nicely, but the other had stored some more honey in them, and had built two queen-cells, about the size of a pea, in the doubling-box. Why did they do this, and store honey at the latter end of September? There were no eggs in cells, as, of course, the honey season is all over. I winter on fifteen frames, with, so far, good results, and I do not extract any from the body-box. My bees are very vicious; in fact, you don't dare watch them in summer time, so you may guess I have to do my manipulations as quiet as I possibly can, as one jar of the hive, and I am completely surrounded with bees, all on a business point of view.—A WORKING BEE.

Bee Shows to Come.

November 11th.—Essex Autumn County Show of Honey, held at Corn Exchange, Chelmsford, in connexion with Chrysanthemum Show of Chelmsford Horticultural Society.

MALTESE HONEY.

Malta honey is said to be noted for its purity and delicate flavour, which is attributed to the bees feeding on, or rather gathering from, the 'Sulla,' a species of clover extensively grown in the islands known as 'Malta.' It is estimated that to collect one pound of honey from clover 62,000 heads of clover must be deprived of nectar, and 3,750,000 visits must be made by the bees.—*English Mechanic*.

STUNG!

A vagrant bee came buzzing round,
And Chloe, frightened at the sound,
Cried, 'Mary, help! Go, Lizzie, fetch
A broom and kill the little wretch!'

Too late! despite the bustling maids,
The wanton imp at once invades
Poor Chloe's lips—the saucy thing!
And fixes there its ugly sting.

The culprit caught, the maids prepare
To kill the monster then and there;
When, trembling for its life, the bee
Makes this extenuating plea:—

'Forgive! O beauteous queen! forgive
My sad mistake; for, as I live,
Your mouth (I'm sorry, goodness knows),
I surely took it for a rose!'

'Poor insect!' Chloe sighed; 'I wov'
'Twere very hard to kill him now;
No harm the little fellow meant—
And, then, he seems so penitent;
Besides, the pain was very small—
I scarcely feel it now at all!'

JOHN G. SAXE.

RESIN CERATE, OR BASILICON OINTMENT.

Resin, five ounces; lard, eight ounces; bees-wax (yellow), two ounces. Melt together, strain through cotton or linen, and stir constantly until cool.

If the ingredients are clear, the straining can be omitted. As an application for burns, it is 'par excellence,' and has been used in our family for over thirty years. I cannot speak too highly of it as an application in all cases of inflamed sores or wounds, or inflamed eyelids. Spread thickly on a cloth, and apply to the part affected, renewing the application as often as necessary.

To show how valuable it is, I will relate two incidents. A few months ago a neighbour ran a nail into the palm of his hand so far as to raise the skin on the back of the hand. In a few hours the hand began to swell and be very painful, followed by rapid and painful swelling of the arm. All remedies were a failure until I made an application of this ointment, and renewed it in half an hour. In less than an hour all pain had ceased, and within twelve hours the swelling had entirely disappeared.

A few days since another neighbour was bitten on a sore on his hand by a fly while sitting at the table. The hand soon became painful and began to swell, the swelling extending to the arm. A physician was called in, who pronounced it blood-poisoning, but the treatment employed gave no relief.

Meeting him in the street with his arm in a sling, and learning what was the matter, I suggested a trial of the ointment, and gave him some. The next day he was at work, as though nothing had been the matter.

I have just received the following recipe—it is tip-top for a cough: Equal parts of unboiled linseed oil, Holland gin, and honey. Dose—two teaspoonfuls, repeated as may be needed. I would suggest that the foregoing recipes be inserted in the next edition of the *Honey Almanac*.—DR. A. B. MASON, *New Philadelphia, Ohio*.—*American Bee Journal*.

Notices to Correspondents and Inquirers.

Letters or queries asking for addresses of manufacturers or correspondents, or where appliances can be purchased, or replies giving such information, can only be inserted as advertisements. The space devoted to letters, queries, and replies, is meant for the general good of bee-keepers, and not for advertisements. We wish our Correspondents to bear in mind that, as it is necessary for us to go to press in advance of the date of issue, queries cannot always be replied to in the issue immediately following the receipt of their communication.

All queries forwarded will be attended to, and those only of personal interest will be answered in this column.

J. R. ROBERTS (Llanberis).—1. If you will send one of the bees by post, with the 'white substance' attached to it, we will endeavour to explain its presence and what it is, otherwise we cannot do so. 2. Neither can we, without some further particulars, say why the bees of the swarm 'are constantly fighting among themselves.'

AMBITIOUS (Salisbury).—1. For soft candy, see *B.J.*, January 29th, p. 51. 2. *British Bee-keeper's Guide-book*, 1s. 6d.

B. EXCLUDER (Greenwich).—1. Candy is laid on top of frames over feed-hole. The sample sent will, we fear, become very hard when the moisture in it has evaporated, though it may do for present use. Recipe for making soft candy for wintering is given in *B.J.* for January 29th of this year. 2. For covers apply to Mr. J. Huckle, Kings Langley. 3. One pound of candy will last a longer or shorter time, according to the rapidity with which the bees work on it and the nature of the candy itself.

MILFORD MAN.—The bees, after being fed up to the needful weight, should be wrapped up as warmly as possible to assist them in sealing the food over before very cold weather sets in.

CAUGHT IN THE STORM.—*Roofs blown off*.—It is fortunate no further harm resulted than wet quilts, as these may be easily dried and replaced. Examine a few of the combs to make sure the bees have not suffered from the night spent in the rain without covering.

J. WHITE (Toddington).—The packets of Naphthol Beta supplied at one shilling post free contain one ounce; shilling packets of naphthaline contain about thirteen ounces.

HAMISH (Banff).—Of the two sugars sent, the white (known as icing sugar), if guaranteed pure cane, is best for bees, but a cheaper refined cane sugar would do just as well.

J. SOWREY (Gloucester).—Reference to Mr. Hole's letter in this issue shows that he thinks our description of feeder quite clear. If you get a mustard-box and follow the details given, we think you can hardly go wrong.

EDWD. H. COX (Ashburton).—Heather honey, like any other, will liquefy and become clear if the vessel containing it is put into warm water for a time.

R. J. SANKEY (Surbiton).—If syrup crystallises, the probability is there has not been sufficient water used. Make it according to recipe given in *B.J.* for January 15th of this year.

A SUBSCRIBER (Somerset).—*Bees Mating*.—The bees sent are a cross between Ligurians and Carniolans. It is more likely that the queens of your hives will mate with the drones at a distance than with those of the adjoining stock.

BEE-KEEPING, its Excellence and Advantages. Price 3d. *British Bee Journal* Office, Kings Langley, Herts, and 17 King William Street, Strand, London, W.C.

JUDGING HONEY. By the Rev. J. L. SEAGER. Price 3d.

JOHN HUCKLE, Kings Langley, Herts.

Special Prepaid Advertisements.

Situations, Publications, Bee Plants, &c.—Twelve words and under, Sixpence; for every additional Three words, One Penny.

Trade Advertisements not inserted under this head.

FOR SALE.—Having had considerable difficulty to obtain suitable Boxes for 1 lb. Sections, and bought larger quantities than required, I shall be pleased to sell at 4s. 6d. per gross, cash with order. Address **MARTIN**, 4 Woodland Place, Bath.

WALLFLOWERS.—Fifty Plants, 1s. free. Arabis, 1s. per dozen. Address **NORMAN PARKIN**, Blakenhall, Wolverhampton. L 51

FOR SALE, in consequence of other engagements.—Twenty-five Stocks of English Bees in three-story Frame Hives, fully provisioned for Wintering, with three Sets of worked-out Combs, Frames of Excluder Zinc, Wood Feeders, &c. Can stand till Spring if desired. What offers for the whole, or any part? Apply to **J. GREENSILL**, Great Wyrley, Walsall, Staffs. L 53

WANTED.—1-lb. Sections, well filled, sealed, and clean. Also Extracted Honey, any quantity. Address **NYE & SONS**, 1 Western Street, Brighton. L 55

FOR SALE.—Five dozen 1-lb. Sections, and 40 lbs. of Extracted Honey. What offers? Also **B. B. J.** from July 11th, '89 to present issue. Address **F. REED**, Conghurst, Hawkhurst, Kent. L 56

BEEES FOR SALE.—English, Italians, and Carniolans. Plenty of Stores. Apply **THOS. HILL**, Scotlands, Cannock Road, Wolverhampton. L 71

WILL the Exhibitor who received the Red Enamel Tins with Twelve Lee's Patent Sections inside, from the Agricultural Show by mistake, communicate with **J. CHURCHYARD**, 35 Chevallier Street, Ipswich, Suffolk. L 72

WANTED.—First-class Smoker. State make and lowest price. Address **MR. CADNESS**, Ohadwell Heath.

WILL EXCHANGE a handsome Hornless Goat, in milk, for Bees in Bar-frame Hive, and Bees in Skep. Must be healthy and clear of all disease. Address **T. GARDNER**, Low Fell, Gateshead.

BEE SMOKE!!—An unsolicited Testimonial from **J. H. HOWARD**, Holme, Peterborough:—"I have used your P. C. Cartridges, and am certain Bee-keepers will thank you for bringing out such a handy form of Fuel for Bee Smokers." Address **THOMPSON & NORRIS**, Manufacturing Co. Limited, 37 and 39 Britannia Row, Essex Road, London, N. L 70

GUIDE TO SUCCESSFUL BEE-KEEPING, post free 4d. Address **C. N. WHITE**, Somersham, Hunts.

NEW EDITION NOW READY.

21st Thousand.

THE BRITISH BEE-KEEPER'S GUIDE-BOOK.

By **THOS. WM. COWAN**, F.L.S., F.G.S., &c.
Revised and enlarged.

Almost entirely re-written. Much new matter and many fresh illustrations added.

Fcap. 8vo., price 1s. 6d.; or in cloth gilt, 2s. 6d.
Postage, 2d.

To be had of **Houlston & Sons**, Paternoster Sq.; all Hive Dealers, Secretaries of Bee-keepers' Associations, and of **J. HUCKLE**, *British Bee Journal* Office, Kings Langley, Herts.

WINTERING BEES. By **THOMAS W. COWAN**. The most complete work on the subject of Wintering published. Third Edition. Price 3d.

J. HUCKLE, Kings Langley, Herts.

BALDWIN'S is the Oldest Establishment in the United Kingdom wholly devoted to Bees and manufacture of

Bee-keepers' supplies. His prices will compare most favourably with those of any other Maker, while for quality of material, suitability and workmanship, he has no rival. 'Why can he give better value for money than others?' Because he spends less in large 'puffing' advertisements, buys in the best markets for prompt cash, has no rent to pay, and personally conducts his own business.

For prices and full particulars of Goods see Baldwin's Bee-keepers' Instructor (and Illustrated Catalogue combined), which 'contains more practical and reliable hints than all the large, expensive books,' post free for 2d. stamps. Address **S. J. BALDWIN** *The Apiary, Bromley, Kent.* N.B.—More than 500 Silver and Bronze Medals, First and other Prizes, and Testimonials innumerable.

THE 'ENGLISH' HIVE.

Transferring Season now on.

TRY THIS HIVE, it is the best in use, and once used will be always used. No more cutting Quilts necessary, as the Bees can be fed from the side of the Hive. See description in *B. B. J.*, August 6th, 1891, p. 351. Price for Floor-board, Body, and Zinc-covered Roof, 11/6 only. The English Wax Extractor, price 7/6.

For particulars apply to **A. T. WILMOT**, St. Albans. 3149

British Bee Journal and Bee-keepers' Record.

OFFICE :

17 KING WILLIAM STREET, STRAND, LONDON, W.C.

PURE CANE SUGARS.

For the accommodation of Bee-keepers, guaranteed Pure Cane Sugar will be supplied in large or small quantities through this office at the under-mentioned rates:—

MOIST. (For Household Use.)

Neat bags, 14-lbs. 28-lbs. 56-lbs. Cwts.
3. MUSCOVADO 2/7 5/2 10/- 19/6

CRYSTALLISED.

4. DEMERARA } Crystals 2/9 5/4 10/6 20/6
5. BARBADOS }
6. TRINIDAD }

REFINED CANE.

7. WHITE CRYSTALS (Small) 3/0 5/10 11/6 22/6
8, 9. (Medium and Large sizes, 1/- per Cwt. extra.)
10. LUMP (Cut Loaf) ... Boxes, 3/3 6/3 12/3 23/6
11. LUMP DUST 3/ 6/- 11/9 22/9
12. PRESERVING 3/- 6/- 11/9 22/9

FINE. (For Household Use.)

13. GRANULATED 3/3 6/3 12/3 23/6
14. CASTOR Coarse (15 Fine) 3/9 7/3 14/3 27/9
16. IOING... .. 4/3 8/3 15/9 31/-

All above guaranteed made from CANE SUGAR only, and free from BEET, CHEMICALS, &c., etc.

CARRIAGE PAID on Orders over 5/0 (or 28-lbs. Sugar) to London and Suburbs.

COUNTRY ORDERS, not less than 2-cwt. carriage paid at 1/0 per cwt. extra.

(Scotch and Irish orders, special arrangements.)
CHEQUES payable to **J. HUCKLE**, Kings Langley.

Cash to be sent with order, and purchasers will please observe that if samples are required or replies asked to inquiries, a stamped addressed envelope must be sent, as we cannot undertake cost of postage.

THE
British Bee Journal,
BEE-KEEPERS' RECORD AND ADVISER.

No. 488. Vol. XIX. N. S. 96.]

OCTOBER 29, 1891.

[Published Weekly.]

Editorial, Notices, &c.

BRITISH BEE-KEEPERS' ASSOCIATION.

Committee meeting, held at 105 Jermyn Street, on Wednesday, October 21st. Present: Mr. T. W. Cowan (in the chair), Hon. and Rev. H. Bligh, Rev. Dr. Bartrum, J. Garratt, W. H. Harris, H. Jonas, W. Lees McClure, Rev. R. Errington, and the following *ex-officio* members, viz., J. W. Hooker, R. A. Grimshaw, W. B. Carr, and Dr. Rayner. Mr. A. T. Atkins (hon. secretary of the Derbyshire Association) was also present, being introduced by the Chairman.

The minutes of the last Committee meeting were read and confirmed. The Secretary reported the results of his inquiries in respect to the prevalence of foul brood in those districts embraced by the affiliated Associations. The Committee were generally of opinion that, with few exceptions, the information received was not quite so full as it might be possible to obtain. The Secretary was requested to communicate again with the Secretaries of the affiliated Associations, and to point out the importance of this information being forthcoming, inasmuch as it was required in the preparation of statistics to be brought before the notice of Mr. Chaplin, the Minister of Agriculture.

The report of the Educational Sub-Committee was presented, recommending that all those candidates whose certificates had expired be called upon to return them, unless they pass such an examination as the Committee may deem advisable on or before the 31st of March next. The Sub-Committee also further recommended certain alterations in the mode of conducting third-class examinations, tending to make them of a more practical character, and particularly requiring candidates to have a knowledge of the nature and treatment of foul brood. Resolved, that the report be received and considered at the next meeting. The Committee afterwards had before them the several candidates for the appointment of public lecturer to the Lancashire and Cheshire Bee-keepers' Association, who in turn delivered lectures lasting about twenty minutes each.

CONVERSAZIONE.

The last quarterly *conversazione* of the present year was held on Wednesday, October 21st, at six p.m., in the offices of the R. S. P. C. A.,

105 Jermyn Street, St. James's. Among the large audience present, which filled the spacious Board-room, were Mr. Cowan (chairman) and Miss Cowan, the Hon. and Rev. Henry Bligh, Messrs. Hooker, Campbell, Grimshaw, Carr, Glennie, Harris, Jonas, Garratt, Till, Fair, Soar, Atkins, Howard, Webster, Harbordt, Anstey, Horlick, and Shepherd.

The Chairman, in opening the proceedings, said there were no papers to be read, nor any special subjects prearranged for discussion. He therefore invited members to ask questions, or in any other way introduce subjects which might profitably be debated on.

Mr. Atkins (hon. secretary of the Derbyshire B. K. A.) suggested that forms should be provided by the B. B. K. A. to be used by the lecturers and experts on their tours of inspection through the counties, and afterwards to be given up to the Secretaries of County Associations. He thought it was very desirable, especially now when, through the action of County Councils, the science of bee-keeping was likely to be more popular than ever, that records and statistics should be kept showing the extent and relative progression of the industry in the counties; and it was better that the B. B. K. A. should draw up the form, so that the statistics would be of a uniform character.

Mr. Garratt considered the suggestion a very good one. In his own county of Kent they had adopted something similar, having kept a book in which were registered the condition of the different apiaries, the numbers of stocks of bees, &c., so that it was easy at any moment to refer thereto and compare the circumstances of different periods.

Mr. Harris thought there should be two different forms, one for the Experts and County Secretaries, and another to be used by lecturers for statistics that were to come up to the B. B. K. A. or be available, if required, for public purposes. Much of the information gained by experts would be quite unnecessary to preserve as permanent records. He agreed that the parent body should take the initiative in the matter.

Mr. Howard said that when he visited the county of Cambridge and the Isle of Ely he made notes of what he did, the condition in which he found the hives, and all concerning them. From these notes the County Secretary could learn all particulars of the inspections made.

The Chairman thought it important that statistics should be supplied to the B. B. K. A.

It was suggested that the matter might be referred to the Committee of the B. B. K. A., with a request that they would draw up the necessary form.

Mr. Carr asked whether it would not be necessary to take into account the new circumstances of the case, and first ascertain what were the requirements of the County Councils. He believed the statistics hitherto obtained would not be sufficient to meet the demands of County Councils.

Mr. Anstey thought it very desirable that the B. B. K. A. should have the information referred to, but he could not see how, under the system adopted by his own county, a satisfactory return could be obtained. Along with their annual report, forms were sent to members, to be used in case the visits of the expert were required. As a rule, not more than one-third of the members needed assistance; thus no statistics would be forthcoming concerning the remaining two-thirds.

Mr. Carr replied that, where lecturers were employed, they would be required by County Councils to make full returns.

The Chairman thought it would be best to refer the matter to the Committee. It might be possible to have one form divided into slips, one portion for the County Association, and another for the B. B. K. A.

Captain Campbell feared the effect of all this would be to saddle local secretaries with a lot of extra work; upon which the Chairman pointed out that the lecturers and experts would make the returns, and the secretaries merely post them on.

Mr. Grimshaw said it was absolutely necessary in any case that returns should be made now that the money of the ratepayers was to be expended. He moved that the matter be left to the Committee of the B. B. K. A. to deal with.

Mr. Carr seconded the resolution, which was carried unanimously.

Mr. Atkins referred to the difficulty experienced in securing the services as experts of persons who know enough of the subject.

The Chairman said that the Central Association had for ten years past granted certificates of proficiency, and now there were a certain number of experts so qualified in the country, whom the branches were at liberty to engage.

Mr. Harbordt said the difficulty in his counties (Lancashire and Cheshire) was not to find suitable men; the trouble was to pay them. It was very costly to work a large district where the apiaries of members were spread about, perhaps ten or twelve miles distant, and means of communication were not always easy.

Mr. Atkins asked a number of questions, which were satisfactorily replied to by the Chairman.

Mr. Garratt submitted that when the county lecturing commenced in earnest by means of the grants of the County Councils, it would be an appropriate thing for the B. B. K. A. to prepare a syllabus of the plan or system of instruction to be pursued by lecturers. There was no other body qualified to do that, and it seemed to him

necessary that there should be some authorised programme.

Major Fair supported Mr. Garratt's proposal with regard to the preparation of the syllabus. He also asked whether the abilities of the successful lecturers would be classified.

The Chairman replied that the Committee would simply carry out the request of the Lancashire and Cheshire Association. They had not been asked to make any classification. The Committee did not see any necessity to re-examine the candidates who had appeared that day, and would not do so unless desired by other counties.

Mr. Grimshaw, while quite in accord with that idea, asked whether such a step was not premature until County Councils had more generally indicated their requirements. In his own county (Yorks.) an endeavour was being made to place the funds in the hands of the Yorkshire College of Science, which, if successful, could result in apiculture being dealt with by the College professors.

Mr. Garratt thought that a greater reason why the B. B. K. A., as the greatest authority on the subject, should be ready with a syllabus.

Major Fair said that the paper would take the form of a suggested syllabus.

Mr. Till said that in the county of Kent they had already started agricultural laboratories. Three thousand pounds had been granted for south-eastern associations, and lectures were being delivered in all the villages round where he lived. Classes also met for mutual education. The authorities were very particular about returns, and every one was invited to send in papers for examination. An agent was also employed in the villages to work up the interest. The B. B. K. A. ought certainly to be ready with a syllabus, for they would assuredly be applied to by County Councils.

The Chairman said it would be difficult to draw up a general syllabus because the grants varied in different counties, and consequently there would be a correspondingly large or small number of lectures, which, of course, would prevent a uniform syllabus being adopted.

Mr. Carr and Mr. Garratt acknowledged the difficulty, but the latter pointed out that it might be met in the case of counties with small grants by dividing those counties into two or three districts, and visiting each one in succession, one year's grant being expended on each division in its turn.

Mr. Howard suggested the adoption of a syllabus with two stages—elementary and advanced.

Mr. Carr believed that none of the money grants would be allowed to be spent on ordinary expert work—*i.e.*, visiting the apiaries of members—but only on assisting technical education in bee-keeping.

After some further conversation it was unanimously agreed that the subject be referred to the Committee for consideration.

Mr. Howard then suggested that it would be worth while to take into account the age of

experts' certificates. There might be some experts with a many-years'-old first-class diploma who were not abreast of the times. Bee-keeping was a progressive science, and he thought certificates should be renewed every five years.

The Chairman said the matter had already engaged the attention of a sub-committee, and could come on for consideration before the General Committee at their next meeting. The report of the former recommended that experts should satisfy the Committee every five years that they were equal to the requirements of the period, and that six months' grace be given them to qualify themselves.

At the conclusion of the more formal portion of the proceedings a number of articles and objects interesting to bee-keepers were laid on the table for the inspection of those present, and for discussion thereon. Among them Mr. Cowan exhibited a tall glass cylinder, filled with alcohol, in which he had arranged a number of anatomical specimens of bees and larvae, the specimens being in a beautiful state of preservation and staged on an upright column of porcelain extending the full height of the cylinder. The Chairman also exhibited an Automatic Smoker, invented by M. Layens, a French bee-keeper, a most ingenious contrivance, which would automatically emit smoke for a considerable time. The mechanism was clockwork, and was fitted with a break, by which the quantity of smoke issuing could be regulated. It may be remembered that mention was made of this implement in the *B. J.* for July 16th, p. 317. It was made by M. Woiblet, of Neuchatel, and could be bought in Switzerland for about 11s. 6d.

Mr. Howard thought the invention an excellent one, and said it was a great advantage to have a continuous flow of smoke.

Mr. Cowan said a good example of the use of the smoker was recently seen at Stirling, where, in manipulating an observatory hive, the complicated machinery for moving the frames became dislocated, and the bees were at once troublesome, when, as soon as the automatic smoker was placed on the top of the hive, the operator resumed his work without further difficulty.

Mr. Carr then placed on the table a number of articles which had been forwarded to the Editors of the *Bee Journal* and *Record*, including the home-made rapid feeder constructed from an old mustard box, and several other feeders made by amateurs, followed by another home-made contrivance for clearing bees from super, made by a bee-keeper who had never seen anything of the kind. Both these articles were described in the *Bee Journal* for the 8th inst. (p. 450). Then there was the new and improved self-hiver made by Mr. Shephard, which met with a good deal of approval from both bee-keepers and the appliance-makers present. To these succeeded various cheap feeders, not the work of amateurs, beginning at one costing fourpence, followed by a very good one made at sixpence each or 5s. per dozen, and culminating

in a well-finished and excellent article, sent by Mr. C. Redshaw, who makes it at 1s. 6d. Mr. Carr also showed the new Hill smoker and some specimens of Mr. Holliday's new 'smoker-cartridges,' made from corrugated paper, with a wick down the centre of each.

A considerable amount of interesting discussion took place regarding the merits or otherwise of the various implements shown and their adaptability for the purpose intended.

The Chairman next showed a beautifully executed and very much enlarged model of a bee's head, which could be taken to pieces in sections, the interior and exterior being both accurately moulded. Another contribution of Mr. Cowan's was a novel apparatus, made by M. Paschoud, Geneva, for wiring foundation into frames, by using which the necessity of puncturing holes in the woodwork was avoided. A dress or blouse for use when manipulating bees was next shown by Mr. Harbordt. The garment, which only occupied a small space when not in use, was kept in a case in which were several little muslin bags containing naphthaline, the fumes of which permeated the blouse and acted as a permanent disinfectant or preventive of the spread of foul brood. Finally, Mr. Glennie exhibited a sample of Eucalyptus honey from Queensland, which was examined and tasted by many of the members present.

Mr. Till proposed and Mr. Hooker seconded a vote of thanks to the Chairman, which was briefly acknowledged, and the proceedings terminated, it being agreed on all hands that a pleasant and highly instructive evening had been spent.

ANOTHER BEE CASE.

A sitting of the Marlborough County Court was held on Tuesday, October 13th, 1891, before his Honour Judge Caillard and Mr. Registrar Merriman.

His Honour delivered judgment in the case of Charles Brooks v. Thomas MacArthur. In this case the plaintiff, who lives at Cadley, sought to recover 10s. from the defendant, a neighbour, for the loss of a swarm of bees which flew into his garden. According to the evidence given at the last court by the plaintiff's wife, an immense swarm of bees came out of her husband's hive, in their garden, and flew over some buildings into the defendant's garden. She followed the bees, and did not cease ringing to them. As soon as they began to pitch on a gooseberry-bush the defendant threw stones and a bucket at them, disturbing them. She was standing just outside the defendant's gate at the time. The defendant fastened up his gate and forbade her coming on to his ground. He began throwing at the bees again. Then—and this was important, his Honour said—they settled again on the same gooseberry-bush, after which Mrs. Brooks went indoors for some time, thereby losing sight of them for a considerable time. When she came out again they were gone. From

the evidence it appeared she lost sight of them for two hours before she came out. To show the law on the matter, his Honour read the following extract from *Blackstone's Commentaries*: 'Bees are *feræ nature*; but, when hived and reclaimed, a man may have a qualified property in them, by the law of nature, as well as by the civil law. And to the same purpose, not to say in the same words with the civil law, speaks Bracton: occupation—that is, hiving or including them—gives the property in bees; for, though a swarm lights upon my tree, I have no more property in them, till I have hived them, than I have in the birds which make their nest thereon: and therefore, if another hives them, he shall be their proprietor: but a swarm which fly from and out of my hive are mine so long as I can keep them in sight and have power to pursue them; and in these circumstances no one else is entitled to take them. But it has also been said that with us the only ownership in bees is *ratione folii*; and the charter of the forest, which allows every freeman to be entitled to the honey found within his own woods, affords great countenance to this doctrine, that a qualified property may be had in bees, in consideration of the property of the soil whereon they were found.' The Judge said he had not been able to find any other authority. Therefore the leading principle to be kept in view as regarded the plaintiff's right to have this swarm of bees was that he or his wife should not have lost sight of them. Although there was some ill-natured and un-neighbourly conduct on the part of the defendant, there was nothing to prevent the plaintiff's wife from steadily keeping the bees in sight after they again settled upon the gooseberry-bush. However, she went away for two hours, and lost sight of them. When she came back, the bees were gone. What became of them did not appear. Somebody else must have had the benefit of the swarm. He thought plaintiff was not entitled to recover. The order of the Court was that there be a non-suit, without costs.

FIRST AND SECOND-CLASS EXAMINATION FOR EXPERTS' CERTIFICATES.

We must draw the attention of candidates for the above to the fact that they will be expected to have a thorough knowledge of the nature and treatment of foul brood, and that in order to pass successfully the candidates will have to satisfy the examiners on this point by very fully answering the questions referring thereto.

PRIZES AT THE DAIRY SHOW.

We regret that the name of Major-General Lee, whose exhibit in Class G3, for best twelve jars of extracted honey, was highly commended, was inadvertently omitted from the prize list.

There is no doubt that a 'high commend' in such a severe competition as the one in question was equal to a good 'first' at most shows.

DEVELOPMENT IN THE HONEY-BEE.

By R. A. H. GRIMSHAW.

(Continued from p. 405.)

With regard to the distancing of combs by the bee, so much lauded in times past, we find them building out storage cells to almost any length, until stopped by the backs of bees working on opposing combs or by the opposite cell cappings. The so-called admirable order in which the bee builds its comb may be illustrated by the hanging of curtains from the ceiling of a room, broad curtains or narrow ones, *wherever there is space on the top* for an attachment. If men were weaving such curtains *in situ*, they would be compelled to leave space for themselves to work in; how unjust, therefore, it would be when no more could be got in the room, to attribute the intricate, orderly appearance to design and cleverness on the part of the workers! I am convinced it is so with the shape of the cell, with the hanging of the comb, and with its arrangement in the hive; much more than is fair and just is attributed to the cunning design of the worker—very much that it has not the shadow of a title to. We forget the Creator in the creature, and attribute to it reasoning power of a high order, instead of simply classing it as a mere instrument is classed in an orchestra—a mechanism by means of which a note may be produced in a grand harmonious whole, and through which the Great Superior Intelligence may make itself known even by man—the *magnum opus* of all, forsooth—the crowning work of creation! It is by investigation of even the meanest of the Master's works that man may get indications of his Maker.

It is by studying the true natural history of the bee, and trying to get at the real design in nature that we are able to direct its labours to our needs; we compel it to give us straight thin combs of pure wax, filled with nothing but pure honey, or we make it increase numerically at our wish by queen-introduction and feeding for brood-raising. An examination of the position of combs in skeps directs our minds towards finding the best way of hanging frames with regard to the entrance; and as, when left to themselves, bees do nothing invariably, we find combs arranged both ways—all ways—thus arises the still vexed question of the parallel *versus* the right-angle system. By narrowly observing the proceedings of bees during their wintering, we are able to form logical deductions as to their place of origin, their geographical home and starting-point; we are also able to assist their hibernation by surrounding them with such things as make for good health; pure (even if cold) air, by open hive doors; air of an equable temperature by hive walls, and other parts of thick non-heat-conducting material, and non-porous quilts, where free doorway ventilation is given, changing to thick or plentiful heat-retaining, moisture-conducting quilts where the bottom ventilation is restricted. We find the bee in winter abhors moisture and draughty hives, and we take steps to obviate these evils,

finding, as we do, that cold is only disagreeable when accompanied by an atmosphere laden with moisture, and that the evil of cool air is vastly augmented when it takes the form of a current absorbing the heat from every object it strikes upon hotter than itself, whether that object be the human body or the honey-bee vainly expending its food stores in the effort to keep up a normal healthy temperature. Again, by noticing the consistency and chemical composition of the bees' winter stores the bee-keeper is able to take more honey from his hives, and supply a suitable substitute for winter sustenance, varying the quantity of water in its artificial food with the approach of the breeding season; nor should we omit to mention the supply of artificial pollen in an unfavourable spring-time, in the shape of pea and other meal; nor the drinking fountain found in the beegarden in a dry season. We come in contact with the diseases of bees in studying their natural history, finding dysentery proceeding from honey badly kept, or never capped, in which acetous fermentation has been set up through contact with moist air, or else resulting from improper artificial food, or from distention of the bowel, the consequence of too long imprisonment in the hive. Or perhaps this distention may have resulted from great variations of temperature, or from much meddling having produced excitement and gorging on the part of the bee at a time when all surroundings should have been steady, calm, and quiet.

Leaving the bee on one side as a honey-gatherer, and dealing with her as a cross-fertilising agent only, we find the least obvious, but the most important of her work resulting. The unscientific farmer (a race rapidly becoming extinct, thank goodness) does not know, nor does he care, what insects visit his fields when they are in bloom, so long as they do not lay eggs, the caterpillars or larvæ from which will eat up what he requires as food for his cattle. If he be told that bees come to his fields, the first thought for which he finds words is that they steal the honey and reduce the nutritious value of the products, and, therefore, bee-keeping in his neighbourhood should be suppressed—leastways, he, of all men, should be the last to be invited to keep them. Yet this very man will think to his very utmost how best he may shoot, trap, and poison as many as possible of the birds about his land, which, if left to the adjusting balance of Nature, would rid the earth and air of the farmer's direst scourges, *i.e.*, myriads of insects, which (or whose progeny) prey upon the plants the farmer indirectly subsists on, leaving neither root, stem, leaf, nor blossom free from their ravages. A bird is shot, some grain is found in its crop, and it is forthwith condemned as graminivorous, and entered on the black list of 'the farmer's enemies;' but let one be shot in the spring and summer-time, when breeding is in progress, and insects in stomach or caterpillar in beak be considered; let the visits of the parent birds to the nest of young be counted, if only for a half-hour, and

a simple multiplication sum follow; then let the farmer test at home the voracity of a single caterpillar per day, and he would open his eyes at the *vastness* of the *insignificant*—perhaps, too, feeling some tinge of shame at the insignificance of the crowning work (!), the *genus homo*. If then, the scientific farmer has the immense power of vitally interfering with the yields from his fields by taking into account the injury done by minute pests, and fostering the means of keeping them within bounds, he has, also, thanks to entomologists and scientists (men who receive the scoffs and sneers of the ignorant or self-sufficient), and thanks to the associations of bee-keepers, placed within his reach the means of recognising in the somewhat insignificant insect, which has been the subject of this long series of papers, probably the truest friend he has amongst the wild things in the animal world, for the bee is as truly wild as is the swallow.

(To be continued.)

Correspondence.

The Editors do not hold themselves responsible for the opinions expressed by correspondents. No notice will be taken of anonymous communications, and correspondents are requested to write on one side of the paper only, and give their real names and addresses, not necessarily for publication, but as a guarantee of good faith. Illustrations should be drawn on separate pieces of paper.

Communications relating to the literary department reports of Associations, Shows, Meetings, Echoes, Queries, Books for Review, &c., must be addressed only to 'The Editors of the "British Bee Journal," 17 King William Street, Strand, London, W.C.' All business communications relating to Advertisements, &c., must be addressed to Mr. J. HUCKLE, Kings Langley, Herts (see 1st page of Advertisements).

* * * In order to facilitate reference, Correspondents, when speaking of any letter or query previously inserted, will oblige by mentioning the number of the letter, as well as the page on which it appears.

NOTES ON BEE-KEEPING.

[824.] I can fully endorse Mr. Woodley's remarks (792) respecting the long hive. It has been my favourite hive, as many of your readers know, for a number of years, and although I have tried many other kinds, I have yet to find its equal, to say nothing about its better. It is, as Mr. Woodley justly observes, 'only those who keep a good number of hives in a small space'—and, I would like to add, have limited time to manage them—'who can appreciate the manifold points in their favour.' The facilities of the long hive enabled me, during the past summer, to keep my bees hard at work while many people's bees were wasting valuable time in swarming. The result is that I can show better returns for the present year than any other bee-keeper in the county with whom I have had the pleasure of comparing notes. Then, again, during the present autumn, when I had a lot of extracted combs, which I wished the bees to cleanse before putting away for next season, I found the long hive exceedingly convenient. The said combs were placed at back of dummy towards evening, the dummy being raised about

one inch. During the night the combs were cleared of all honey, and taken out next day entirely free of bees, the latter having retired to the hive proper. If such combs are placed over the brood chamber, the bees will go up, it is true, and clean them; but they do not always trouble to take the honey down nor go down themselves, and when one attempts to drive them down they stick their heads in the empty cells, especially if the weather is chilly, and thus resist all the smoke and carbolic acid that can be applied.

The 'extra first cost' of the hive to which Mr. Woodley refers was with me by no means an important item. During the slack time of the year (from an appliance-dealer's point of view) I went to one of our leading hive-makers, and purchased fifty hives, to be sent to me in the flat in small quantities as and when required. It was a big job to make up these fifty hives and took a good deal of time, as it all had to be done before and after the ordinary day's work. It was very nice to possess such a large number of hives, all made of the very best material, and being cut out by machinery, every part perfectly interchangeable; but the best part of it was this, I was able to sell twenty-five at the dealer's retail price, and thereby get *my* twenty-five for nothing, as it were. I have had them in use seven years, and they are practically as good as when first set up. I make it a rule to paint them every year.

Mr. Wilmot (812) has set himself a tremendous task if he is going to convince bee-keepers that properly made candy is unsuitable for bee-food. For several weeks last spring my bees lived almost entirely on candy, during which time the hive was never opened beyond raising the quilt sufficiently to enable me to slip under a fresh supply of candy as often as required—about once a fortnight. When the hives were opened, late in April, the bees were in a flourishing condition, brood in many cases in every comb right up to the top bar, a state of things which I have never been able to produce by syrup-feeding; no, not with the 'best possible syrup obtainable,' given in the best and most approved manner.

I am glad to say that my stocks are in splendid condition for winter. Not a drop of syrup has been necessary. All combs not covered with bees have been removed. But when cold weather sets in in real earnest the bees will doubtless cluster in about half or two-thirds the space they now occupy. A cake of candy will then be placed right over the cluster, so as to guard against starvation during severe weather. Last winter I lost several valuable stocks, with beautiful sealed honey in the very combs on which they were clustered, and within a very short distance of the cluster, but a distance which the bees could not or would not travel. Non-keepers sometimes speak of bees as wise little creatures; bee-keepers are sometimes inclined to call them by other names. The weather here continues mild, but very wet, and at the present time we are visited with a tremendous

flood. There is a point not more than ten minutes' walk from my apiary where one can stand and view at least 600 acres of 'sea on land.' To-night, Saturday, there is a dense fog, the first of many with which the Ouse Valley will no doubt be visited during the next three months.—A. SHARP, *Huntingdon, October 24th.*

NOTES FROM NORTH DEVON.

[825.] I can quite agree with your correspondent 'E. W. C.' (No. 798), in the *B. B. J.* of October 8th, both as to the obstinacy of the Devonshire farmer and labourer, and also on the weather, which has been wretched. From four frame hives and two skeps I have had about 120 pounds run honey and fifty pounds sections, my best sections being from one of the old-fashioned dome-topped skeps built up with clay. I have been working hard to persuade our bee-keepers in the neighbourhood to go in for frame hives, but even when offering to procure the 'boxes' at a reduced cost (on condition of working rationally therewith), I cannot persuade the folks that it will not take up too much time. I am sorry to say there are a few cases of foul brood in the neighbourhood, I myself being a sufferer in a stock bought in the spring—now, I hope, cured. We are a little more fortunate about shows than 'E. W. C.,' as we have generally a fair show of honey, &c., at Eggesford, and honey shows, such as they are, at all the little flower shows. The Devonshire B.K.A. existed till three years ago, and then lapsed for want of a better working committee. I for one should be glad to see it started again; in fact, if no one else is moving in the matter, I should be glad to hear through your paper of any one willing to help me in re-starting the Association.

I see Mr. 'Useful Hints' advises packing up bees with dummies on to as few frames as they will conveniently cover; but in the results of M. Bonnier's experiments, published May 7th last in the *B. B. J.*, it is stated that empty combs hung outside the cluster retain heat as well as a dummy. Why, therefore, reduce number of frames? I am trying a couple of hives on ten frames this winter, the last two frames at back being without honey. I hope next spring to communicate results.—A NORTH DEVON BEE-KEEPER.

DRY FOOD FOR BEES.

[826.] In your footnote to my letter (812), you miss my point, and in saying that 'it will take a deal of theory to convince them to the contrary,' *i.e.*, that bees will winter well on candy, attempt to prove the wrong conclusion. Possibly I brought this upon myself, when I said 'bees should never be fed on dry food.' In this I certainly went too far; in fact, I am myself in one case feeding on candy this winter. What I had in my mind was that, if syrup could be given to bees with safety, it would be better for both bees and bee-keepers; in fact, I wished

to elucidate a few practical remarks where so much is theory.

The point I wished to put before your readers was—seeing that bees do winter well on candy, and in severe winters certainly perish on unsealed food, why should this be so, as, presumably, the bees must reduce the candy to syrup before they can consume it? I account for it in this way, that the bees do not take to the candy until all the food in the cells is exhausted, and then only get such quantities as are needed for immediate use; whereas, when syrup is given to bees in October, it is both too late and too early—too late, inasmuch that it can rarely be sealed over, and too early, because they are then able to store it up in the cells, where it collects moisture, causing it to ferment and give forth an obnoxious vapour, which is generally destructive to them.

Now, if syrup were given to them, say, after Christmas, I do not think they would store more in the cells than they required for immediate use; nor would they run short through dryness of the hive, as I fear must frequently be the case with candy.—A. T. WILMOT, *St. Albans*.

[We fear that in the concluding sentence of the above communication, our correspondent lays down a proposition as little likely to meet with the favour of practical bee-keepers as that to which we took objection in his former note. Experience goes to prove that, for reasons *many and weighty*, it is most unwise to feed bees in winter-time by leaving an inverted bottle of syrup above the cluster, and if our correspondent proposes to prove the contrary, we may at least express the hope that he will try the experiment on his own bees, and report results, before advising readers to adopt methods which have been tried and have failed.—EDS.]

BEES AND FRUIT-GROWING.

[827.] In order to fulfil my promise made to you last spring, I will now proceed to give an account of the influence of my apiary on fruit-growing.

I am very pleased to say that I have had an abundant crop of every kind of fruit this year, and have made a fair price of all of it—we have just finished the damson-gathering. The bees had the first taste of the sweets of the fruit crop, and this gave me the means to carry on operations for another season. Though the summer has been so exceptional, I never experienced a better for fruit—the result of which is, that I have purchased five acres of land, which I hope to plant with fruit-trees, and have enlarged my apiary, in order that I may take ten stocks of bees to my newly purchased ground when planted, for I am more fully convinced than ever that bees and fruit-culture ought to go hand in hand. It makes me smile when I read of some of the correspondents of the *B.B.J.* talking about ‘bees eating fruit.’ I certainly have seen bees on pears, but it was after the fruit had been attacked by wasps.

Now, sir, you know that some people are fond

of finding fault with and destroying anything that comes in their way. I am not, for I have had my orchard about ten years, and during that time have shot but one bird, and that act I afterwards regretted, more especially when I found his gizzard was full of insects. Poor little chap! he was doing me good, and that is how I rewarded him; and so of birds and mankind in general. Some grumble because the bees eat a few plums or pears, which perhaps would never have grown had they (the bees) not fertilised the blossom. I do not wish your readers to imagine I am a saint, and dislike sport. I certainly like sport, more especially when the ‘furry’ quadrupeds become too numerous, and I feel that I should like a rabbit-pie, which my good queen of the domicile says would be a ‘nice change.’ To return to the bees. I have had about two hundredweight of honey this year from my apiary of twenty stocks. The cold, wet weather which prevailed while the ‘honey-flow’ was on prevented a larger haul, but still I am satisfied that we shall be all right, and when we get a fine summer, I hope to send you a glowing account.

I went in for extracting this year on the shallow-frame principle, and am very pleased with the results. I am making from 8d. to 1s. per pound of the honey, and have had a pretty fair trade. (I find that my honey is granulating. Does honey deteriorate by so doing, and what measures, if any, can be taken to prevent granulation?)

We, like the rest of the country, have experienced very heavy gales of wind this week; but judge of my surprise, on going out on Wednesday morning last, to find that a shed containing nine skeps of bees had been blown over during the night, and that not one of the hives was damaged, though some were on their sides, some this, some that way; in fact, all ways but the right one. But not a bee was lost, for the simple reasons that the bees had well propolised their homes to the floor-board, and I always put mortar round the bottom of the straw skeps. I smiled, and said that bees do not believe in ‘jerry-building.’ Well, I got one of my men to give me a helping hand, and we soon put things to right; then I had a look round the orchard to see what further mischief the gale had done, and I was not long in finding that about twenty bushels of damsons had fallen down, and they consequently being unfit for market, I said to ‘mother,’ ‘We must turn these into damson wine,’ which was no sooner said than done, and now we are brewing about ninety gallons of damson wine—good stuff, too. Two glasses of it and a pipe of ‘baccy’ will make one talk about his friends. I hope I shall not shock your readers, but I am neither a Lawsonite nor an inebriate, but one who believes in having good things when one works hard for them, and if any of the bee fraternity should come this way and give me a call, I will make them very welcome, and give them a glass of the aforementioned damson wine.

After this long digression, I will conclude by

remarking that I have fed up all my stocks with pure *cane* sugar, which I think will prevent them from suffering with dysentery. I hope to be able to report to you of this treatment next spring.—R. BROWN, *Somersham, Hunts.*

DRONES AND QUEEN IN HIVE AT END OF OCTOBER.

[828.] On the 15th August I started two strong stocks of bees filling combs from rapid feeders in readiness for driven bees; one hive, holding twenty frames, was so strong that the bees covered most of the combs, but I could see no brood or eggs. About the second week in September I found plenty of sealed brood, both drone and worker; as most of the combs were filled and sealed when I examined the hive early in October, I took away twelve frames. I could not see the queen, the brood was all hatched, and the hive contained scores of drones; not discovering either eggs or unsealed brood, I concluded the stock was queenless.

As the sun was shining brightly to-day (October 24th), I opened the hive and examined the stock, with the intention of putting in another queen, when, to my surprise, there were as many drones as I should expect find in any one of my hives in June, and the queen marching about the comb quite bright and lively. This stock was very weak in spring, but pulled up very rapidly, and gathered a fair amount of honey for the short season.

Drones and queen in the same hive at this time of the year is a new experience to me. Have you, or your readers, met with a similar case?—L. WREN, *Lowestoft.*

[We should account for the above by supposing that the feeding had restarted the queen brood-rearing in the neighbourhood of drone-cells, and that the continuous income had postponed the destruction of the drones after the normal time.—Eds.]

THE HARVEST IN WEST MIDDLESEX.

[829.] In support of your correspondent, Thomas Dell (803, p. 455), I beg to send you statement of my results for this season. Locality, West Middlesex. Type of hive, Abbott's Combination. No. 1, purchased in 1890, 52 pounds; No. 2, artificial swarm, 1890, 70 pounds; No. 3, natural swarm of 28th May, 1891, from No. 2 hive, 77 pounds; No. 4, natural swarm of 11th June, 1891, from No. 1 hive, 45 pounds. Total, 244 pounds. All in sections.—J. S., *October 9th, 1891.*

LATE MATING OF QUEENS.

[830.] I thought the following might interest readers of the *B. B. J.*:—When among my bees on Thursday, the 8th October, I noticed two or three drones going into one hive, and just as I said to myself, 'Ah! you are queenless!' a fine queen settled on the alighting-board, and went in.

The hive had been to the moors, where they had probably lost their queen, and although so

late in the season, had managed to raise another. Whether she is fertilised or not remains to be seen. Will you kindly let me know the latest date you have known queens fertilised, and if October 8th is very unusually late?—ARTHUR J. H. WOOD, *Bellwood, Ripon.*

[The date named is later than we have ever heard of queens being fecundated. We shall be much interested in the future of the case referred to.—Eds.]

PREVENTING GRANULATION OF HONEY.

[831.] A good deal of trouble is caused at this season of the year to bee-keepers who happen to have a fair amount of extracted honey on hand for which sale has not yet been found, by reason of the honey granulating. I have overcome the trouble this year by keeping the honey-vat beside the kitchen fire, and I can draw clear liquid honey whenever I require to do so.—J. TOPHAM.

NOTES ON ROBBING.

Last year I established an apiary of a few hives at three-quarters of an hour's distance from my residence, and after the honey harvest only visited them occasionally, at long intervals. I therefore adopted somewhat the economical and simple plan recommended by M. de Layens. I will not tell you about all the bitter disappointments my out-apiary caused me, but I must tell you that two of my hives—crossed Carniolans and Cyprians, with strong populations—were robbed towards the end of August, and robbed so effectually that at the end of fifteen days there remained absolutely nothing but empty and damaged frames of comb. The district where these hives were situated was infested by an immense number of wasps, whose nest I discovered a few metres away from my bees, and I believe they were not strangers to the robbing.

At home I have always succeeded in preventing robbing, because my bees are under observation, and I attribute my defeat to the fact of my visits not being frequent enough. The simplified method of M. de Layens leaves the risk of opening the doors for robbing.

During the present time, when robbing takes place so easily, I wish to tell my method of stopping it, more especially the latent proclivity, which is perhaps not so rare as is generally supposed. I observed two cases last year in my apiary, and again another case this season. These were fine colonies, from which I could reasonably expect a good return, and which at the height of the honey-gathering had not one cell sealed, notwithstanding the apparent activity of the bees. One of these hives had an old queen, which I replaced by an Italian queen. From the time the new queen was introduced I found constant fighting at the entrance of the hive—fighting that I could not at first understand, and which caused me some anxiety as to

the security of the new queen. However, at the end of a few days the colony resumed the normal habits of a hive in good order. Light then dawned upon me, and I began to understand why the super had not been filled. Thanks to this queen, the difficulty was overcome, and I was perfectly satisfied with my harvest. In consequence of the good result obtained by this operation, I applied it also to the second colony being robbed. The success was the same, and again this year my plan has triumphed.

It is hardly necessary to give the explanation of this phenomenon. All bee-keepers know that every queen has her own individual odour, and will understand that in changing the queen the hive acquires an odour different to the old robbers, which results in their being detected and driven out.—J. KELLER, *Professor, Neuchâtel, Switzerland.*—*Revue Internationale.*

REVIEW OF FRENCH AND BELGIAN BEE-PAPERS.

By J. DENNLER.

1. *L'Apiculteur*. Thirty-fifth year (established by H. Hamet), No. 6.—Sabouret describes and praises a new honey-plant, *Forsythia viridissima* (Oleaceæ), from Japan. It is a hardy deciduous shrub, attaining the height of ten feet. This shrub is covered in March, before any leaves appear, with rows of drooping flowers of a brilliant yellow, which are almost as assiduously visited by the bees as the flowers of *Cornus mas*. The time of flowering of this last is much shorter than that of the former. The leaves of *Forsythia*, when rubbed, are scented, and of a dark green. It is easily propagated by cuttings.—In No. 7, Abbé Voinot discusses the question of a French national standard frame, and for this purpose recommends a frame thirty-three centimetres (thirteen inches) square.—In No. 8, C. Froissard complains that the honey trade in France can hardly be called flourishing. He says that it is impossible to expect it to recover from its impoverished condition with a so-called protective duty just voted by the Chamber of Deputies (fifteen francs per 100 kilos, maximum excise duty, and a minimum of ten francs). He thinks that the manufacture of wine and *eau-de-vie* from honey is destined to have a considerable influence on apiculture, and invites his countrymen to utilise their honey in this manner.—No. 10. 'Monument erected by subscription to the memory of H. Hamet.' On the 3rd September at nine o'clock in the morning, the members of the administrative council of the Société Centrale d'Apiculture et Insectologie, as well as several delegates of apicultural societies from the departments, assembled at the cemetery of Montparnasse to inaugurate the monument erected to the memory of H. Hamet, the founder of the Société Centrale and of the *Apiculteur*. M. de

Hérédia, the president of the Society, made a suitable speech.

Apicultural Congress.—On 2nd September, 1891, the tenth Apicultural Congress was held in Paris, presided over by M. de Hérédia, and attended by Messrs. Abbé Boyer, Vignole, and De Layens; Vice-Presidents Abbé Voinot and Lefèbvre. The Secretary, M. Derosne, read the proposed statutes for the federation of the French Bee-keepers' Societies. These statutes contained eighteen rules, which were adopted by the Congress as proposed. Every affiliated society will pay, in accordance with Rule X., an annual subscription of ten francs. The object of the federation is to group the different Bee-keepers' Associations of France, and thus to enable them to concentrate their forces to defend their mutual interests, also to obtain from governing bodies the support and liberty necessary for this branch of agriculture. The federation to continue so long as at least three societies are affiliated. The committee appointed by the Congress to consider the question of a national standard frame for France, makes the following report:—

1. The committee is of opinion that any person in a honey district, as opposed to a queen-rearing district, who adopts a frame twelve decimetres square, is likely to succeed.
2. The committee think the frames may be of three forms:—(a) The square form, of 35 cm. by 35 cm., or the Congress type; (b) the high form, 40 cm. by 30 cm., or the Layens type; (c) the shallow form, 30 cm. by 40 cm., or the Dadant type.
3. The inside width of the hive should exceed by 3 cm. the inside width of frames. These recommendations were adopted by the Congress at its meeting on the 3rd of September.

2. *Le Rucher*. Illustrated Journal of the Société d'Apiculture de la Région du Nord. Eighth year. Editor, A. Leroy. No. 10.—There are in France 1,649,099 hives of bees. In an article on the use of honey, by M. Ensbrunner, we find the following recipes:—Honey boiled with ants is a remedy for ulcers of the eyes. A poultice, made of honey, flour, and onions, is good for sty in the eyes. Honey dissolved with wax and oil is good for wounds and ulcers (fistula). Honey dissolved in turpentine and oil of laurel cures chaps. Honey and water, taken during an epidemic, prevents contagion.

3. *L'Auriltaire*. Third year. Editor, J. B. Leriche. No. 7.—Bees as carriers of dispatches. M. A. Teynac, a bee-keeper of La Gironde, has just made, for the first time, experiments with bees as carriers of dispatches. It is hardly necessary to state that they can only be used at distances of not more than three or four kilometres, and also that the weather must be fine, and sufficiently warm not to chill the little insects. This singular telegraphist fastens to the thorax of the bees which he receives from his correspondent small pieces of paper, rectangular in form, 6 mm. long and 2 mm. to 2½ mm. wide, one end of which is split in two, which forms two feet, which can be glued between the wings. Thus furnished the bees are allowed to fly, and are received by the

correspondent at his apiary. This is rather a boastful discovery.

4. *Bulletin de la Société d'Apiculture de la Somme*. Seventeenth year. Vol. IV. No. 88. Editor, G. Gamain. A communication from Madame Madarés gives some curious details of bee-keeping in China. The Chinese are not so backward in bee-keeping as one would suppose. They hang their hive (generally they only have one) to the roof of their house. This hive is a bamboo cylinder, closed at both ends with earth. When they want to take honey they smoke their hive the same as is done in Europe. They then open it, and take out several combs of honey, and then close it. But, like real savages, they are very fond of the small white worms which we in France call larvæ, and which are found in the cells. They feast with delight on these. If they are stung, they crush some of these larvæ and apply them to the part, and this simple remedy prevents the swelling which is frequently so painful.

5. *Le Bulletin Apicole*. Journal of the Société l'Apiculture du Bassin de la Meuse. Second year. Editor, A. Wathelet. No. 8.—If the bee-keeper wishes to have his honey granulated without having to wait six or seven weeks, he can after a week churn it the same as is done with cream to obtain butter. Honey treated in this way granulates with a very fine grain. We have just tried this process on honey that had been extracted eight days, and in fifteen minutes the honey, in a one-pound bottle, passed from the thin liquid state to a thick syrup. Sometimes honey granulates in coarse grains, which makes purchasers think that it is adulterated. It can be melted in a water bath and then exposed to cold, when it will granulate very fine.

6. *Le Bulletin Horticole, Agricole et Apicole*. Ninth year. Editor, T. Belot. No. 12.—Queen rearing: To obtain choice queens certain conditions have to be combined. The larvæ must come from a hive whose queen is prolific, and whose workers are active and of a mild temperament. The rearing must take place in a strong colony, having many young bees, which are better suited to produce brood food than the older ones.—No. 13. Advice to those who are behind-hand: Strong colonies, at the time of the honey harvest, with their combs make the fortune of the bee-keeper, whereas if they are too late in becoming strong they can only consume what they are able to gather before the winter.

7. *La Cire des Abeilles*. By A. & P. Buisine. Published by Gauthiers Villars, 55, Quai des Grands-Augustins, Paris. Price, 4 francs.—This is an important work, which describes, amongst other things, the analysis of beeswax and the different ways of bleaching it; also the analysis of mineral and vegetable wax.

8. *Bee Manuals submitted for Competition*.—The Paris Congress has decided to submit for competition two manuals of bee-keeping, one elementary and another treating of bee-keeping more completely.

9. *La Culture rationnelle des Abeilles*. Bulletin de la Société d'Apiculture du Département du Tarn. No. 8. Editor, Délevey.—Bees in Mexico: Fifty years ago bees were not known in the huastecas in Mexico (huasteca signifies the land of flowers); to-day there is not a village, an estate, a hamlet, or a house that has not got its hives. The Indians do not cultivate bees for the honey, but for the wax, which is bleached and sold in cakes at 75 francs to 90 francs the 11½ kilos. It is scarcely twenty years ago since the huastacan bee-keepers threw away the honey. Now they sell it for 1 peso (5 francs) the box of 5 gallons, or 20 litres. This honey is exported by Tampico. A well-cared-for apiary will produce 1 arroba (25 pounds) of wax per box, and each box gives two, three, or four swarms a year.

Anti-formic Elixir.—A chemist in Albi, M. Cambonlives, pharmacist of the first class, has just discovered an elixir which renders quite harmless the stings of bees, hornets, and of all other *apidae*. Thanks to this elixir, swelling which is consequent on the stinging of bees is no longer to be feared.

Queries and Replies.

[447.] *Winter Passages*.—1. What is the use of cutting winter passages, if, as I generally find is the case, the bees very soon block them up again? 2. If all the stocks are strong, is there no fear whatever of robbing?—A SUBSCRIBER, *Somerset*.

REPLY.—1. The best form of winter passage is by giving the space above the frames, and bees cannot block them up. 2. Strong stocks are rarely 'robbed.'

Bee Shows to Come.

November 11th.—Essex Autumn County Show of Honey, held at Corn Exchange, Chelmsford, in connexion with Chrysanthemum Show of Chelmsford Horticultural Society.

Echoes from the Hives.

Bridgham, Harling, Norfolk, October 23rd.—Nine old stocks and three swarms, making twelve bar-frame hives. No doubling. Thirteen frames and one case of sections to each hive. A little feeding in May. None required this autumn. The bees came out nineteen times in all, of which all, except the above three swarms, were replaced. No queen-cells destroyed, and no queens killed intentionally. The yield of honey was almost all between the middle of June and the middle of July. Total, 263 completed sections, and 552 pounds extracted—*i.e.*, assuming the sections to average one pound, the total take would be 815 pounds. I think white clover must have been the chief constituent.—WILFRID BLUNT.

SHAKESPEARE AND BEES.

In his plays Shakespeare frequently alludes to bees and honey. Some of these we have selected for mention.

In *The Tempest*, Act V., Scene I, the delicate Ariel expresses his enjoyment by saying:—

‘Where the bee sucks, there suck I.’

In *A Midsummer Night's Dream*, Bottom the Weaver gives orders to his new attendants in the following words:—

‘Monsieur Cobweb; good monsieur, get your weapons in your hand, and kill me a red-hipped humble-bee on the top of a thistle; and, good monsieur, bring me the honey-bag.’—Act IV., Scene I.

Drones are also mentioned. Shylock, in speaking of his servant Launcelot, after describing him as a ‘huge feeder,’ adds:—

‘Drones hive not with me.’

Shakespeare knew that a hive contains a queen, workers, and drones, for he says:—

‘Like stinging bees in hottest summer's day,
Led by their master to the flower'd fields.’

Titus Andronicus, Act V., Scene I.

True, he calls the queen ‘Master,’ but this is still used in some places, and in some parts of Sussex the queen is still called the ‘master-bee.’

‘Drones hive not with me’ has already been alluded to, and the workers are described in the following lines:—

‘So work the honey bees;

Creatures, that, by a rule of nature, teach
The act of order to a peopled kingdom.
They have a king, and officers of sorts:
Where some, like magistrates, correct at home;
Others, like merchants, venture trade abroad;
Others, like soldiers, armed in their stings,
Make boot upon the summer's velvet buds;
Which pillage they with merry march bring
home

To the tent-royal of their emperor:
Who, busied in his majesty, surveys
The singing masons building roofs of gold;
The civil citizens kneading up the honey;
The poor mechanic porters crowding in
Their heavy burdens at his narrow gate;
The sad-ey'd justice, with his surly hum,
Delivering o'er to executors pale
The lazy yawning drone.’

Henry V., Act I., Scene II.

In the *Second Part of Henry VI.* the following passage occurs:—

‘How quickly nature falls into revolt
When gold becomes her object.
For this, the foolish over-careful fathers
Have broke their sleep with thought, their
brains with care,
When, like the bees, tolling from every flower,
The virtuous sweets,
Our thighs are pack'd with wax, our mouths
with honey:

We bring it to the hive; and, like the bees,
Are murdered for our pains.’ Act IV., Scene 4.

In another part of the same play this murder is described, and in it we recognise the old method of the brimstone pit. When the English troops are being repulsed by Joan of Arc, Talbot says:—

‘So bees with smoke, and doves with noisome
stench,

Are from their hives and houses driven away.’

Act I., Scene 5.

(To be continued.)

Notices to Correspondents and Inquirers.

Letters or queries asking for addresses of manufacturers or correspondents, or where appliances can be purchased, or replies giving such information, can only be inserted as advertisements. The space devoted to letters, queries, and replies, is meant for the general good of bee-keepers, and not for advertisements. We wish our Correspondents to bear in mind that, as it is necessary for us to go to press in advance of the date of issue, queries cannot always be replied to in the issue immediately following the receipt of their communication.

All queries forwarded will be attended to, and those only of personal interest will be answered in this column.

THOS. HOLLIDAY (Congleton).—So far from naphthaline being injurious to plants, we are told that if powdered and dusted on the leaves (dry) of plants infected with green-fly, it will kill the latter, while doing no harm to the plants.

T. NIXON (Acton Bridge).—*Winter Passages.*—To examine the ovaries of queens and test their sterility or otherwise, perfectly fresh specimens must be sent. The one to hand is of the common black variety, and probably a young queen, but as to her being a virgin we cannot say. Winter passages over or through combs are not ‘absolutely necessary,’ but they are supposed to be advantageous by good authorities. On the other hand, we have safely wintered hundreds of colonies without passages of any kind.

J. D. (Wexford).—We think the sample sent is beet-sugar.

C. E. S.—Some Associations keep extractors for the use of members. Apply to the Secretary of your Association.

BUSY BEE (Sunderland).—Sugar, as sample sent, is not suitable for bee-food at this season. Only refined, crystallised cane sugar should be used.

J. S. W.—We can only account for both queens being killed on the principle that ‘bees do nothing invariably,’ as it certainly is most unusual for such an occurrence to take place. Both were adult queens, but we cannot give their ages; neither can we say if of a ‘pure black strain,’ as they were so covered with flour as to be like millers.

HEWITT BOSTOCK (Epsom).—*Removing Bees from a Hive Roof.*—Under the circumstances, the aid of a person who has some knowledge of bees should be called in, if such a one is to be had.

Special Prepaid Advertisements.

Situations, Publications, Bee Plants, &c.—Twelve words and under, Sixpence; for every additional Three words, One Penny.

Trade Advertisements not inserted under this head.

FOR SALE.—Having had considerable difficulty to obtain suitable Boxes for 1 lb. Sections, and bought larger quantities than required, I shall be pleased to sell at 4s. 6d. per gross, cash with order. Address **MARTIN**, 4 Woodland Place, Bath.

WALLFLOWERS.—Fifty Plants, 1s. free. Arabis, 1s. per dozen. Address **NORMAN PARKIN**, Blakenhall, Wolverhampton. L 51

WANTED.—1-lb. Sections, well filled, sealed, and clean. Also Extracted Honey, any quantity. Address **NYE & SONS**, 1 Western Street, Brighton. L 55

FOR SALE.—150 lbs. of Clover Honey in 40-lb. Jars. Deposit System. Address **H. COOPE**, Polapit Tamar, Launceston. L 73

BEE SMOKE!—No. 1 P. C. Cartridges, 3s. 6d. per gross; half-gross, 2s. No. 2 ditto, 5s. per gross; half-gross, 2s. 9d. If fitted up with Cotton Wicks add 6d. per gross extra. Samples free 4d. stamps. Orders over 20s. Carriage paid. Address **THOMPSON & NORRIS**, Manufacturing Co. Limited, 37 and 39 Britannia Row, Essex Road, London, N. L 74

FOR SALE.—Seven Bar-frame Hives and two Skeps (single or otherwise), well stocked with healthy Bees. What offers? Address **74 Lowe Street**, Wolverhampton. L 75

NEW EDITION NOW READY.

21st Thousand.

THE BRITISH BEE-KEEPER'S GUIDE-BOOK.

By **THOS. WM. COWAN**, F.L.S., F.G.S., &c.

Revised and enlarged.

Almost entirely re-written. Much new matter and many fresh illustrations added.

Fcap. 8vo., price 1s. 6d.; or in cloth gilt, 2s. 6d. Postage, 2d.

To be had of **HOULSTON & SONS**, Paternoster Sq.; all Hive Dealers, Secretaries of Bee-keepers' Associations, and of **J. HUCKLE**, *British Bee Journal* Office, Kings Langley, Herts.

BRITISH BEE-KEEPERS'

PRACTICAL NOTE-BOOK.

With Rules for the General Management of Movable Comb Hives.

By **THOS. W. COWAN**, F.G.S., &c.,

Editor *British Bee Journal*.

Consists of a Series of Tables by means of which the Bee-keeper can keep a record of all his Observations and Operations. A Pocket-companion indispensable to the practical Bee-keeper.

Price 1s., postage 1d.

Bee Journal Office, Kings Langley, Herts; and 17 King William Street, Strand, W.C.

WINTERING BEES. By **THOMAS W. COWAN**. The most complete work on the subject of Wintering published. Third Edition. Price 3d.

J. HUCKLE, Kings Langley, Herts.

BALDWIN'S is the Oldest Establishment in the United Kingdom wholly devoted to Bees and manufacture of

Bee-keepers' supplies. His prices will compare most favourably with those of any other Maker, while for quality of material, suitability and workmanship, he has no rival.

'Why can he give better value for money than others?' Because he spends less in large 'puffing' advertisements, buys in the best markets for prompt cash, has no rent to pay, and personally conducts his own business.

For prices and full particulars of Goods see Baldwin's Bee-keepers' Instructor (and Illustrated Catalogue combined), which 'contains more practical and reliable hints than all the large, expensive books,' post free for 2d. stamps. Address **S. J. BALDWIN** The Apiary, Bromley, Kent.

N.B.—More than 500 Silver and Bronze Medals, First and other Prizes, and Testimonials innumerable.

THE 'ENGLISH' HIVE.

Transferring Season now on.

TRY THIS HIVE, it is the best in use, and once used will be always used. No more cutting Quilts necessary, as the Bees can be fed from the side of the Hive. See description in *B. B. J.*, August 6th, 1891, p. 351. Price for Floor-board, Body, and Zinc-covered Roof, 11/6 only. The English Wax Extractor, price 7/6.

For particulars apply to **A. T. WILMOT**, St. Albans. 3149

British Bee Journal and Bee-keepers' Record.

OFFICE:

17 KING WILLIAM STREET, STRAND, LONDON, W.C

PURE CANE SUGARS.

For the accommodation of Bee-keepers, guaranteed Pure Cane Sugar will be supplied in large or small quantities through this office at the under-mentioned rates:—

MOIST. (For Household Use.)

Neat bags, 14-lbs. 28-lbs. 56-lbs. Cwts.

3. MUSCOVADO 2/7 5/2 10/- 19/6

CRYSTALLISED.

4. DEMERARA } Crystals 2/9 5/4 10/6 20/6
5. BARBADOS }
6. TRINIDAD }

REFINED CANE.

7. WHITE CRYSTALS (Small) 3/0 5/10 11/6 22/6
8, 9. (Medium and Large sizes, 1/- per Cwt. extra.)
10. LUMP (Cut Loaf) ... Boxes, 3/3 6/3 12/3 23/6
11. LUMP DUST 3/ 6/- 11/9 22/9
12. PRESERVING 3/- 6/- 11/9 22/9

FINE. (For Household Use.)

13. GRANULATED ... 3/3 6/3 12/3 23/9
14. CASTOR Coarse (15 Fine) 3/9 7/3 14/3 27/9
16. ICING.. 4/3 8/3 15/9 31/-

All above guaranteed made from CANE SUGAR only, and free from BEET, CHEMICALS, etc., etc.

CARRIAGE PAID on Orders over 5/0 (or 28-lbs. Sugar) to London and Suburbs.

COUNTRY ORDERS, not less than 2-cwt. carriage paid at 1/0 per cwt. extra.

(Scotch and Irish orders, special arrangements.)

CHEQUES payable to **J. HUCKLE**, Kings Langley.

Cash to be sent with order, and purchasers will please observe that if samples are required or replies asked to inquiries, a stamped addressed envelope must be sent, as we cannot undertake cost of postage.

THE
British Bee Journal,
BEE-KEEPERS' RECORD AND ADVISER.

No. 489. Vol. XIX. N. S. 97.]

NOVEMBER 5, 1891.

[*Published Weekly.*]

Editorial, Notices, &c.

USEFUL HINTS.

WEATHER.—After the usual equinoctial gales and the rain, of which there appeared to be no end, there would seem to be a little fine weather before us in which to do the necessary straightening up so much needed about an apiary in the autumn-time. The bee-keeper may, however, feel inclined to thank goodness that the year is drawing to a close, and that for some months to come the weather will cease to trouble him by way of spoiling his honey-flow. It is a most comforting thing to feel oneself entirely independent of the weather; to be, as the Welshman said, when extolling the qualities of his flannel, 'always dry and warm, though ever so wet and cold.' And much of this comfort accrues to the bee-keeper whose many colonies are so well cared for as to bid defiance to storms and torrential rains, such as we have gone through within the last few weeks. Mishaps will, no doubt, have occurred. Hive roofs, we know, have been carried away long distances by the wind, and bee-houses have been overturned; but not much damage is reported, for readers generally have learned to make all safe in time. For securing hives in exposed situations we still find nothing to excel the stake driven in the ground on one side of the hive-stand, and a couple of bricks attached to a strong cord swung from this stake across the hive roof.

FOUL BROOD.—As queries still continue to reach us on this subject, it may be at once said that, beyond inserting a few pieces of naphthaline between the outer combs and the hive-side, nothing can now be done until the spring by way of treating foul-broody stocks. The very encouraging amount of success which the use of remedies written of in these pages has met with, gives reason to hope that the evil has received a considerable check in its onward course.

Next May, however, will be the month of trial, and we hope that careful measures will then be taken to give a fair trial to the advice given for curing it.

PRESERVING STORE COMBS.—Among the indoor jobs to which attention should be now given is the safe storing away of ready-built combs for next year's use. As we wrote some time ago in our monthly:—The number of bee-keepers who are giving less attention to section-production than formerly, from a growing conviction that better financial results can be attained by working for extracted honey, is so rapidly on the increase that it may be useful for such as have a good stock of combs by them to make some special provision for the safe keeping of these combs until wanted for use next season. It is no exaggeration to say that thousands of bee-keepers to-day—who a year or two ago did not know what a 'shallow frame' was—are now as fully aware of the value of a reserve store of these combs as are the wise ones who adopted them long ago, and as it is of the utmost importance to keep all combs intended for honey-storing free from the depredations of the moth larvæ as well as from dust, spiders and vermin of any kind. On next page is a sketch of the contrivance we use for the purpose. Store combs may be, and are, kept in cupboards, in overhead racks fixed in store-rooms, and in workshops, as well as in the shallow boxes themselves, each box being wrapped in paper—the last was the plan we followed in former years, but none so safely protects the combs, or keeps them so clean and fresh, as the contrivance here shown. The cost of materials is very trifling, and any one possessing a saw and hammer may make it from the sketch without difficulty.

The 'body-box' is 9 inches deep, 14½ inches from front to back, and 32 inches long, inside measure. So that, if needed, standard-size combs may be stored therein. A ½-inch board is quite strong enough for the sides and bottom of the box. The up-

rights at each corner are 33 inches long, 2 inches wide, and $\frac{1}{2}$ -inch thick, nailed on to the outside of body-box. Four light rails—slaters' laths answer well for these—front and back, form the runners on which the frames hang; they are nailed on the inside of uprights with their top edges six inches apart, the upper rails only being continuous. This rack when complete is very light and will comfortably hold 100 frames.

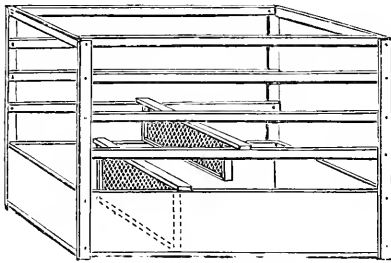
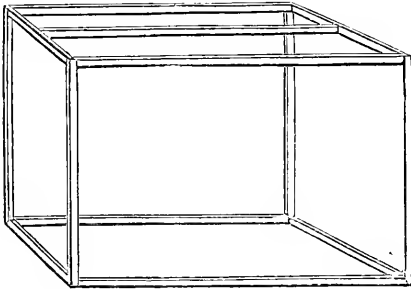

Rack for Store Combs.

The top sketch represents the frame of cover, and is made of very light laths, the uprights being 34 inches long, and the internal dimensions of just sufficient length and width to slip easily over the 'rack' when the latter is full of frames of comb. When nailed up, this frame has a covering of cheap calico stretched tightly and tacked on to the top and four sides. Over this calico covering is pasted several thicknesses of strong paper, and the whole is then complete. The cover fits down over all quite close to the ground, and we find that no moths or spiders ever attempt to enter at the bottom edges. If the presence of moth eggs among the combs be suspected when they are hung in the rack, a few pieces of naphthaline may be placed in the body-box, so that the fumes will permeate the whole of the combs and prevent mischief; but if the frames of comb when removed from the hive are at once placed in the rack, moths will not be likely to trouble them.

LATE FEEDING.—If, in spite of repeated urging to 'feed up,' bees are found short of stores so late as this, it is useless endeavouring to induce them to take down syrup in sufficient quantity. There are three courses open:—(1) Giving combs of sealed food from other stocks able to spare them; (2) soft candy in good-sized cakes, renewed as often as required; and (3) the old-fashioned 'dodge' of filling a coarse canvas bag with a dozen pounds of raw sugar, and setting it over the frames in the form of a 'sugar quilt.' It need hardly be said the last-named plan comes last in the order of merit, but we have known bees to winter safely when treated so.

FOUL BROOD.

Early last June we had a specimen of foul brood sent to us from a correspondent in Kent which differed in some respects from ordinary foul brood. Upon examining it under the microscope, the ordinary *Bacillus alvei* of foul brood was not found, but another one, quite distinct, was seen. We at once inoculated two tubes of nutrient gelatine and agar-agar, and the growth in these was quite different to the usual appearance of the ordinary bacillus. Whether this is a pathogenic species or not we have not had the opportunity of testing. It may, however, be interesting to our readers if we reproduce an article by M. Canestrini which we have just found in the *Atti della Società Veneto-Trentina di Scienze Naturali*, published in Padua, and which throws some light on a new bacillus discovered by M. Canestrini, although no definite conclusions from the experiments can be arrived at:—

'ON A NEW BACILLUS FOUND IN BEEHIVES.

'On the 10th of March last Signor Luigi Martini, director of the Bacteriological Institute of Osino, in the Marche (Central Italy), wrote me as follows:—

"Here in the Marche, where bee-farming has made sensible progress, almost all the hives have been recently attacked by the plague of foul brood. Many hives have been destroyed, many infected, and few enjoy immunity from the disease. A friend of mine had an apiary of forty hives, and they have been all destroyed by this plague."

'Being anxious to be better acquainted with this disease, I requested Signor Martini to send me a piece of infected comb in a hermetically sealed case, to which request he replied with a promptness for which I am most grateful to him.

'I thought that I had found myself face to face with a typical case of foul brood, which, from a bacteriological point of view, has been already described by Cheshire and Cheyne, Crookshank and Eisenberg; but my researches,

made in conjunction with Dr. Giacomo Catterina, did not lead me to identify the *Bacillus alvei*.

'In the cells of the piece of comb sent to me from Osino I found the brood reduced to a black and pulpy mass, which, however, did not emit any characteristic odour. With this mass I made, in the usual way, cultures in nutrient gelatine, agar-agar, blood serum, and on potatoes, and I was able to separate in a pure culture a distinctly characteristic bacillus.

'It is from 4 to 6 μ in length and about 2 μ in breadth. When it is isolated it is of greater length than when several elements are united in a chain. Its two extremities are rounded, and never attenuated or clavate. It is mobile, but exhibits slow and oscillatory movements. In the mass it may be called a squat-shaped bacillus, somewhat similar to that of splenic fever *Bacillus anthracis*, and still more like *Bacillus megaterium*. It is spore-forming and chromogenic, as I shall explain more fully somewhat further on. It is easily stained with all aniline colours by the usual methods, and also by the method of Gram. It is developed slowly in the four culture media mentioned above at a temperature of about 17° Cent., but with more rapidity at a temperature of 37° Cent. It liquefies gelatine and blood serum, and in the latter it becomes surrounded by a sheath. It is not pathogenic in the case of white mice, guinea-pigs, or crickets, but it germinates freely in the brood of bees and in the bees themselves.

'To render this diagnosis clear, I will give the following fuller particulars.

'In nutrient gelatine this is liquefied, and during growth of the bacillus it forms a simple funnel with a blunt and whitish apex. After a few days the funnel is surrounded by a liquid film of a rather pale pink colour.

'In nutrient agar-agar it grows on the surface, forming a whitish film, and produces spores in abundance. The spores are 3 μ in length and 1.5 μ in breadth, and of an oval shape; they become coloured, for example, with fuchsin, if submitted to a high temperature, or by passing the cover-glass eighteen or twenty times through a flame. Very interesting is its behaviour in blood serum, in which it becomes surrounded by a most unmistakable sheath: several rods—as many as fifteen or twenty—may be collected in one sheath; but it usually happens that for every rod there are corresponding notches in the sheath. Moreover, in some cases the sheath is converted into a uniform sac containing many bacilli. At times there are to be seen sheaths perfectly white, or not containing any bacilli. In the same medium, moreover, a whitish film forms on the surface, and after two days it commences to liquefy it. I found it sheathed even in dead bees. In some cases the sheaths were very long, and contained as many as fifty rods.

'On potatoes it is developed promptly, so that after twenty-four hours there may be seen on them a stain of the colour of red wine.

'Cultivated in milk, it makes it muddy, and white flakes are formed, also a farinaceous deposit.

'If with the material taken from blood serum we make a preparation and mount it in Canada balsam, we observe that the bacilli within the sheath approach its walls, and sometimes arrange themselves diagonally.

'This bacillus, forming spores, resists a high temperature. A culture, after having been exposed for four and a half hours to a temperature of 65° Cent. will still produce new colonies in twenty-four hours. It resists successfully a four per cent. solution of boracic acid, but it does not resist that of corrosive sublimate of one-half per thousand.

'Subcutaneous injection of a white mouse and of a guinea-pig gave negative results, for no pathological phenomena, general or local, were observed. A similar result was obtained after smearing the backs of crickets with a pure culture, forcing it into their mouths, and inoculating them with the point of a steel needle, a circumstance which, after all, does not cause any surprise, as we know from the researches of Balbiani that the cricket enjoys particular immunity from the action of bacilli.

'It is useful to observe that in this species the bacilli arrange themselves in a chain, one in front of the other, and that the spores in the preparations taken from cultures in agar-agar form irregular masses.

'I believe the bacillus described above to be different from the *Bacillus alvei* of Cheshire and Cheyne, for the latter comports itself differently in nutrient gelatine, and produces upon potatoes a yellow spot; is arranged, both itself and its spores, in a different manner when grown in agar-agar; does not form a sheath in blood serum, and is pathogenic in mice and guinea-pigs. It differs similarly from *Bacillus megaterium*, which it somewhat resembles in shape; for *Bacillus megaterium* forms a yellowish spot on potatoes, does not produce the above-mentioned pink colour in nutrient gelatine, and does not form a sheath.

'In order to ascertain its action upon the brood of bees, I obtained at Santa Maria di Cervarese, in Padovano, a piece of comb containing brood, which I infected with the pure culture taken from the dead brood, which came from Osino, by pouring small quantities of it into the cells which contained the brood. Within four hours the latter were dead, some of them being literally covered with black spots, whilst others were reduced to a pulpy mass. From this last-mentioned I re-established in the different culture media pure cultivations of the bacillus described above.

'I cannot, however, deny that the brood may have died from simple cold, as I kept it in my laboratory outside the hive.

'On a subsequent occasion I brought from the country about 300 bees and some pieces of comb with brood, and I infected one of the pieces of comb. After forty-eight hours the bees were all dead, although I had supplied them with honey. Both in the bees and in the dead brood I found the bacillus. But on a still later occasion I infected in the open country an

entire beehive with a culture two months old, and the beehive did not suffer. From this I am inclined to believe that this bacillus is not pathogenic. On the other hand, I cannot absolutely deny the contrary, for this culture was old, and might have lost its virulence.—G. CANESTRINI.

AVERAGE HONEY YIELDS.

An article in a recent number of *Gleanings* gives some interesting particulars concerning what is called a 'Model Californian Apiary.' The article is illustrated by an admirable view—reproduced from a photograph—of the famous Sespe apiary of Mr. J. F. McIntyre, and it will give us much pleasure to print the whole article, pictures and all, in an early issue if the blocks can be obtained, in order to show readers what a big American apiary is like, and how small the largest of ours is by comparison.

What we chiefly desire to call attention to just now, however, is a table which accompanies the article, giving the average honey returns from the apiary in question for the past sixteen years. It reads as follows:—

Years.	Inches of Rain.	No. of Colonies.	General Average.
1876	21½	150	200 pounds.
1877	4½	300	No honey; half bees dying.
1878	20½	150	275 pounds.
1879	12½	300	No honey; half bees dying.
1880	22½	200	175 pounds.
1881	13½	400	20 pounds.
1882	11½	120	15 pounds.
1883	11½	150	40 pounds.
1884	4½	160	100 pounds.
1885	8½	200	No honey; half bees dying.
1886	28½	240	175 pounds.
1887	16½	330	10 pounds.
1888	20	400	50 pounds.
1889	24½	420	36 pounds.
1890	39½	430	60 pounds.
1891	19½	450	21 pounds.

These returns will afford food for some curious reflections to those who are interesting themselves in the question of what amount of honey may be reckoned as a fair average yield per hive for a series of years.

Taking the twelve years, from 1876 to 1887, it will be seen that in California the seasons of 1876, '78, '80, and '86 yielded 175 pounds and over per colony, while in one year more than 41,000 pounds of honey were taken from 150 stocks of bees—an average of 275 pounds per stock! Returns like these may well cause the British bee-keeper to sigh for such magnificent pastures as the mountains of California afford. And yet, curiously enough—judging by the report before us—it would appear that two years are there required to make one good season, seeing that plenty appears to be followed by famine in quite regular order, more often than otherwise accompanied by the loss of half the bees. Why this should be we cannot say, unless it is that the heavy work of harvesting and preparing for market so many tons of honey causes some amount of carelessness for the well-doing of the little 'gatherers' themselves. To see the line 'No

honey: half bees dying,' so frequently recurring, suggests to the mind of the British bee-keeper that a more correct way of putting it would be, 'Bees left short of winter stores; one half died, remainder weak.' This reading would account for failure the following year; and, though it reflects some discredit on the system of management followed, in no other way can we account for the facts as stated. At the same time it must be admitted that away in the far-off canyons of California, feeding up stocks of bees for winter on syrup prepared from sugar, as is done in this country, would be a costly and troublesome job, involving, perhaps, more labour than could be given to it. With our limited knowledge of the subject, we therefore can but wonder why the bees are deprived so closely of their stores as to suffer so heavy a mortality afterwards. The point which does strike us, and very forcibly too, is the bearing such facts as are stated in the table above have on the question of overstocking; for it will be seen that in those years giving the best results, the number of colonies on hand only once went beyond 200—in the two best seasons of all only 150 stocks were worked—while, during the five years in which the apiary numbered 400 stocks and upwards, the average never exceeded sixty pounds, and twice dropped down as low as twenty and twenty-one pounds per hive.

When it is borne in mind that the apiary from which these returns were made is situated in a valley with mountains on either hand, covered for miles with a pasturage such as we can hardly realise, it is difficult to imagine that such a place could be overstocked. And yet it would seem that, even in such a bee-paradise, as is here indicated, too many stocks may be congregated in a given space to do well.

The bearing the rainfall also has upon the quantity of honey stored is curious when viewed in the light of the British bee-keepers' experience, for it seems that a wet season means a good honey harvest, and *vice versa*.

After all, however, it must not be forgotten how different are the climatic conditions under which bee-keeping is carried on in California, and what seem to us bad results caused by defective system of management may be very clearly accounted for by those who are acquainted with all the surroundings.

Be this as it may, readers will find a good deal to ponder over in the statistics to which we have referred, and will, perhaps, also be able to judge how impossible it is to reply to the question so often asked, 'What is the average return of honey per hive in this country?'

GLEANINGS.

In *L'Apiculture* we find that at the Agricultural Congress in Paris the question was asked if bees really built their cells in the darkness of the hive by the aid of their antennæ. The conclusion arrived at after the discussion was that the evidence furnished by entomologists

was incomplete, and that the eyes of bees may be so constructed as to enable them to see in comparative obscurity, and that besides the tactile organs can supplement those of sight.

In the *Revue Internationale* H. Spuhler introduces queens by placing a queen in a small cylinder made of comb foundation, and placing it in the hive several hours after the removal of the old queen. The cylinder is closed at both ends, which are pierced with small holes, and is smeared over with honey before it is placed in the hive.

The *Canadian Bee Journal* says, 'When cold weather sets in bees should be clustered compactly, otherwise it has a very injurious effect on them at the beginning of the winter season. Bees that are disturbed late in the season will not be clustered so tightly, therefore every effort should be made tending to keep them quiet at the approach of cold weather. Queenless colonies should be doubled up with others.'

BEE-KEEPING EXTRAORDINARY.

No doubt it will be a surprise to many to hear that our present system of bee-keeping is to be revolutionised by a more simple and effective management, by which thousands can embark in the business who are now debarred from the fascinating pursuit, and instead of decreasing the number of stocks kept by each individual, they may be increased by the hundred. The price of comb and extracted honey may be reduced, and yet give larger profits to the bee-keeper. Comb honey may be produced at the price of extracted honey. This system of bee-keeping is supposed to enable the school teacher and those in offices to attend to their bees before and after their daily duties are performed. In short, to enable any person, who chooses to do so, to have his bees scattered all over the country in different apiaries, and in different localities—one person being able to attend to 400 or 500 colonies of bees in from five to ten apiaries without any swarming. The system is supposed to enable the bee-keeper to manage with about half the ordinary expense. In other words, it is to reduce the cost of supplies, such as hives, &c., one-half—to take as much honey from fifty colonies as can be taken by any other means from 100—to take as much comb honey per colony as is now taken of extracted honey. The system does away with three-fourths of the comb foundation used in the brood chamber, and only starters are necessary.

Mr. Alpaugh—a most thoroughly practical, and one of our best bee-keepers, who manages about 400 colonies—has practised it this entire season, and while we are perfectly willing to take Mr. Alpaugh's statements and facts, knowing him, as we do, no doubt some will question the possibility of such results. We believe Mr. Alpaugh has not decided just when he will bring it before the public. We think he intends to charge \$5.00 for a full printed

description, with the understanding that it is to be kept secret as far as possible for a certain length of time, until he is recouped for his expenditure in connexion with the invention.

Now, we do not hesitate to say that it will pay any one to give \$5.00 for a full description, with the distinct understanding that if it is not what he recommends, he will refund the money. It is a system which would enable us to do away with swarming entirely, to scatter our yards promiscuously through the country, in order to take advantage of the best bee-locations—to only visit them occasionally, and to leave no one in charge of the yard, it being quite unnecessary to do so. The system will also enable ladies to keep and manage large apiaries, without the least difficulty.—*Canadian Bee Journal*.

[We print the above without comment, beyond the expression of a feeling of wonder that experienced bee-keepers can be found ready to part with their dollars under the impression that anything so wonderful in the art of bee-keeping has, until now, remained undiscovered.—Eds.]

Correspondence.

The Editors do not hold themselves responsible for the opinions expressed by correspondents. No notice will be taken of anonymous communications, and correspondents are requested to write on one side of the paper only, and give their real names and addresses, not necessarily for publication, but as a guarantee of good faith. Illustrations should be drawn on separate pieces of paper.

Communications relating to the literary department, reports of Associations, Shows, Meetings, Echoes, Queries, Books for Review, &c., must be addressed only to 'The Editors of the "British Bee Journal," 17 King William Street, Strand, London, W.C.' All business communications relating to Advertisements, &c., must be addressed to Mr. J. HUCKLE, Kings Langley, Herts (see 1st page of Advertisements.)

**.* In order to facilitate reference, Correspondents, when speaking of any letter or query previously inserted, will oblige by mentioning the number of the letter, as well as the page on which it appears.*

BEE-LAW.

[832.] In the *British Bee Journal* of October 29th is contained the report of a case in the Marlborough County Court, and as I cannot agree with the decision of the learned Judge, I hope you will allow me to make a few remarks on the subject.

By English law animals are divided into two classes, viz., (1) Domestic, and (2) Wild (*feræ naturæ*).

1. A domestic animal (*e.g.*, a horse or a sheep) is the absolute property of its owner, and it remains his property although it strays away or is lost. The rule is the same in the case of inanimate articles, such as a hat or a watch.

2. Wild animals, namely, those that are not domestic, stand on a different footing, and only remain the property of their owner so long as they are under his control. Pigeons, stags, and trained hawks belong to this second class, to which bees also belong.

Pigeons flying at a distance from home, but which are accustomed to return, and a trained

hawk that is pursuing its quarry in the presence of its owner, still remain the property of their owner, being to some extent under his control. A stag that is being chased is regarded in the same light, and a swarm of bees which flies from my hive still remains my property so long as I can keep them in sight and have power to pursue them.

Let us now consider what are the legal remedies of the owner if his rights are interfered with:—

If I lend my horse (domestic animal) to a man, or if it strays into his field and he refuses to return it, in either case I can sue him and compel him to return the horse or pay me its value; but if my horse, in straying into his field, has done any damage, I cannot require it to be given up to me until I have made amends for the damage. And so, if my hat is blown into a man's garden, or my sovereign rolls into his doorway, I can compel him to return it or pay me the value.

Before the old forms of action were abolished by the Judicature Acts, an action of 'detinue' would have been the appropriate remedy in these cases, and in it I could have recovered my horse, &c., or its value, and also damages for any loss I had sustained through its wrongful detention. By adopting another form of action, called 'trover and conversion,' I could have sued the man for damages for converting the horse, &c., to his own use, as the law presumes, from his refusal to return it, that he has converted it to his own use.

Upon the above remarks I believe there can be no difference of opinion; but let us go a step further, and suppose that my swarm alights in a man's garden, and that I have kept it in sight from the time it left my hive, so that it still remains my property. Now, if he refuses to return it—*i.e.*, if he will neither let me take it nor give it to me himself—the same principles would apply, and I should be entitled to sue him for the value of the swarm and for any other damage I might sustain by its wrongful detention.

My right of action, it will be observed, arises on the refusal to let me have the swarm, and there is no need for me to watch it any longer, nor would my right of action be defeated if the swarm subsequently flew away. And so, if I sue a man for wrongfully detaining my watch, it would be no defence for him to say that he subsequently lost it.

Let us now suppose that my swarm crosses another man's land without alighting, and he will not allow me to follow it. In this case I fear I should have no right of action, for it is nowhere laid down that a man has the right to follow his bees over the land of another, and certainly there is no such right in the case of a runaway horse.

But suppose I follow a swarm (or a horse) on to a man's land without asking his leave, or in spite of his prohibition. In that case he could sue me for trespass; but, if I did no injury, he would only recover nominal damages, and he

might be ordered to pay my costs if the judge considered the action wholly unreasonable and vexatious.—T. F. L., *Brondesbury, October 31st, 1891.*

BEE ASSOCIATIONS AND COUNTY COUNCIL GRANTS.

[833.] I enclose you Mr. Turner's note of inquiry to me and copy of my reply, under the impression that if the information is wanted in one county, it will be acceptable in many others; and in the hope that if you publish this, it may save me from the necessity of personal explanation to others.—F. H. MEGGEX, *Hon. Sec., Essex B.K.A., Chelmsford, October 26th, 1891.*

DEAR SIR,—I should be glad if you can give me particulars of how you propose spending the grant from the C.C., as we have secured 50l., but we want to know what other Associations are doing; also as to what you pay your lecturer, and kind of outfit. By doing so you will greatly oblige, yours truly,—E. F. TURNER, *Hon. Sec. Oxon. B.K.A.*

*Essex Bee-keepers' Association,
Chelmsford, October 26th, 1891.*

DEAR SIR,—Our grant is made in this way—30l. for winter lectures, 20l. for bee-tent demonstrations. Formal intimation did not reach us until too late to do outdoor work with any advantage. We therefore determined to arrange for as many winter lectures as we could afford between now and March next, and, as far as funds granted would allow, send the bee-tent next summer to follow each lecture.

1. With a map of the county before us, we chose the centres we thought most suitable for lecturing in, bearing in mind—(a) That our work must be seen of men—*i.e.*, County Councillors; (b) that centres chosen should be evenly distributed over the county; (c) that rural districts should be considered as well as towns; (d) that the bee-tent could only follow with advantage where there was a good summer gathering, such as a horticultural or cottage-garden show in the town, village, or neighbourhood.

2. We chose twelve centres, intending to supplement the grant by charging 6d. for reserved seats where this seemed practicable.

3. By grouping one or two districts, we reduced the number of summer demonstrations required, and for the rest, where we could not afford to send tent, decided to send the expert to give a demonstration in some friendly apiary, to which neighbours would be invited. This latter will very probably be a valuable means of reaching villagers, if, as I anticipate, it may develop into moving a hive or two on to the village green, and getting at the labourers, like the Salvation Army gets at its converts, by really going to them.

4. We issued a circular, copy of which is enclosed, to send to the clergyman or a prominent inhabitant of each district we intended to visit, unless, of course, we had an officer of the Association resident there. If first correspondent fails, some one else is addressed, until we get a reply.

That is, I think, all I can tell you with regard to the organization. Now as to cost. We are fortunate in having an able lecturer attached to our Association, who, for this season at any rate, is willing to accept engagements in Essex for one and

a half guineas and travelling expenses. He also finds lanterns and all paraphernalia for a nominal charge for the use of the same, if we cannot get a grant for apparatus, or the use of apparatus, from the Technical Education Fund. His usual fee for lecturing outside the county is 3*l.* 3*s.* to 6*l.* 6*s.*, regulated by distance from London. Our expert will accompany the lecturer to operate the lantern and act as referee on practical bee-keeping, for 7*s.* 6*d.* and travelling expenses for each lecture. Both lecturer and operator calculate on getting entertained for the night when out too far to return home; but they take the risk of this. Our estimate for twelve lectures is attached, though it will probably not be much guide under differing circumstances. The outfit required for lecturer is:—Lantern, lamp, sheet, &c., all packed together in box, constructed so as to be easily movable. In fact, the lecturer must take *all* he requires, have it in such a form that it can be easily put up and packed away again, and be prepared to do everything for himself. Trusting these particulars may be of service to you,—I am, yours truly, (signed) F. H. MEGGY, Hon. Sec. Essex B.K.A.

Estimated expense of twelve lectures.—Rooms, gas, and firing, 5*l.* 5*s.*; travelling expenses—lecturer, 5*l.* 11*s.* 6*d.*; operator, 2*l.* 18*s.* 6*d.*; lecturer's fees and hotel expenses, 18*l.* 18*s.*; operator's fees and hotel expenses, 5*l.* 5*s.*; printing and distributing 3000 bills, 3*l.*; contingencies, 2*l.* 2*s.* Total, 43*l.* Deduct estimated receipts for admissions, 6*l.* Estimated cost, 37*l.*

NOTES BY THE WAY.

[834.] A change in the weather has come at last, and we in West Berks are enjoying a spell of fine weather, too late to be termed 'St. Luke's summer,' yet very acceptable all the same after the late wet season we have passed through. Still, even in the wettest season, we, here on the hills, feel no after-effect of the heavy rainfall. We are not driven to 'take to the boats' as in some parts, and our hives, though they may be sodden with rain, are still standing in the accustomed spots, though some are, or rather were, like the leaning tower of Pisa.

The fine days have given us a chance of airing and drying where necessary the wraps and quilts that cover the colonies, also of putting the finishing stroke to the packing up for winter. Clear all weeds that are under and around the hives, and see especially that all hives stand firm, so that the winds do not rock them, as the effect on bees of a rocking hive is the opposite to the babe in the cradle. Feeding up for the winter should be completed ere this; but if any of our fraternity has procrastinated, I would advise a large cake of soft candy in preference to syrup-feeding at this late period in the year. This, if properly made, will be used up by the bees before the stores in the combs; why I do not know, unless they like it better, or possibly they are suspicious, and may expect it to be taken away, so clear it up to prevent the bee-keeper clearing it off as he did the sections of honey earlier in the season.

Weak colonies should be united. This can be done even now, using flour as a pacifier. There

is only one objection I have to the use of flour, and that is, that it appears a good medium for the larva of our enemy, the wax-moth. Earlier in the season this can be remedied by clearing it out of the hive after the bees have settled down a few days; but it will be risky to do so now, as the less the bees are disturbed—provided they have sufficient stores—the better for the bees. I have never been a frequent manipulator even when I had only a few hives. Some bee-keepers are constantly overhauling their stocks to satisfy their own, or visitors', or friends' curiosity. This is a bad habit to get into, and tends to prevent that steady growth of a colony of bees so requisite for securing a crop of honey from the stock.

With strong colonies I never overhaul or dismantle a hive, except at spring and fall, and rarely reduce my frames for winter quarters below nine. Of course, for re-queening, or in case of swarming, attention must be given as required; but I would caution young hands or novices in bee-keeping to 'let well alone' if it is honey they want by keeping bees.—W. WOODLEY, *World's End, Newbury.*

MEMS. BY A CHESHIRE BEE-KEEPER.

[835.] *Sulphuric Acid in Wax Refining.*—I have used this successfully, and find it improves the appearance of wax made from old combs. My plan is to add two drachms of the acid to one quart of water, adding the acid drop by drop if the water is hot; then boiling the wax in this solution for about a quarter of an hour, stirring all the time, taking care that it does not boil over. To prevent this, have a jug of cold water handy to add a little occasionally. I use an oil stove for the job, which I find much more convenient than the kitchen fire, and it causes less friction with the cook!

Dovetailing Hives.—I quite agree with one of your correspondents that it is a pity to let this drop. I often wonder why some of our hive-dealers do not advertise hives in the flat in crates of five and ten at a less cost than for a single hive. I like the decimal numbers for dealing in anything. A good hive with an outer case, such as I saw win the first prize at Birkenhead this year, made so that all parts dovetailed together, something after the style of tea-chests, and offered at the lowest possible price in crates of five and ten, complete, with three boxes of shallow frames or crates of sections, should sell well. I would suggest that the body-box and tiering-boxes be made strong enough, so that, with the addition of a smaller floor-board and light roof, they could be taken to the moors if wished without the outside cases. If it is not worth our hive manufacturers' while to put machinery down for this dovetailing, they might get the hives made in America, as the sections and frames are now made.

Glazing Sections.—It would be interesting if Mr. Woodley would give a full description of his plan of glazing, which you commend in your report of the Dairy Show. I believe he did

once before, and, if I remember right, gave a good deal of the credit to Mrs. Woodley. Unfortunately, all bee-keepers are not blessed with such a useful helpmate. A woman's neat fingers are certainly most suitable for this kind of work about an apiary. An article on comb honey-production from the pen of Mr. Woodley would be real gold.

Home-made Appliances.—'A Village Blacksmith' has my sympathy in wishing to see more on this subject in the *B. B. J.* Like him, I am very fond of making my own hives, &c., though I don't make my own frames, and don't intend to. I think most men who have the slightest taste for carpentry would make very serviceable outside cases for hives when they could at first buy the body-boxes. — A CHESHIRE BEE-KEEPER.

INCONSISTENT SHOWING.

[836.] Your correspondent (817, p. 477) does not appear to be satisfied with my explanation (769, p. 407), at which I am not surprised, as he has kept up a a running fire of hostility at my doings since August 18th 1887, when, though an expert, I could not drive bees (in the bee-tent) or judge honey at the show in a way to please this same gentleman, my friend then styling himself 'Welsh Novice.'

Again, in the *B. J.* for August 8th, 1889, under the signature 'East Glamorgan,' the work in the bee-tent was discredited and written down as misleading the public by making them believe that bees could be handled with impunity without the operator being stung, which, in his opinion, was 'immoral.' Then the writer lets out the secret by expressing the opinion that, 'in face of the inevitable fall in the price of honey, which another good season or two will bring about, it is truly injudicious to increase our numbers by artificial means;' and as I devote nearly the whole of my time to the spread of modern bee-keeping in Glamorganshire, and making as many bee-keepers as I can, I must not expect better treatment at his hands. To any unprejudiced mind, my explanation *re* 'Inconsistent Showing,' of September 10th (769), would have been satisfactory, but as my veracity has been called in question, I beg to say that, if Mr. Morgan or any other interested person wishes further evidence, I am prepared to meet them at Pontypridd or Cross Inn Station, and take them to the garden where the bees are placed, where any question may be put to the person in charge. Moreover, as to what was done at the time: some of the same honey still remains with the bees, and can be taken out and compared with that of my exhibit which I have by me.—W. GAY, *Berterdy, Pontypridd.*

EXPERTS' CERTIFICATES.

[837.] In report of the B. B. K. A. meeting I note one of the audience suggested that first-class experts' certificates should be renewed

every five years. Referring to my diploma, signed by Messrs. Cowan, Raynor, and Bligh, I find I was appointed first-class expert in 1882, no mention being made on my certificate of any five, ten, or fifteen years' limit.

Bee-keeping is certainly a progressive science, but looking somewhat higher to the noble science of medicine (ever advancing), what would physicians of old standing say if they were informed that their diplomas, if not renewed every five years, would be confiscated?

A fair plan would be to grant special first-class certificates for 'lecturing experts.'

The B. B. K. A. certainly can promulgate new rules for the guidance of future candidates, who will know exactly what is expected of them; but it would be in the highest degree unfair to rescind honours earned by and granted to old candidates.—EXPERT.

Queries and Replies.

[448.] *Amount of Food for Winter.*—As I have had very little experience in bee-keeping, I write to ask for your criticism of my past management, and your kind advice for the future, that I may know where to rectify mistakes, and that others may take warning. I began the year 1891 with five stocks of bees—two in frame hives, two straw skeps, and one box hive. From these I had four swarms. Two of these, from the skeps, I put into one frame hive, using pea-flour in uniting, and one from the box hive I put into another frame hive by itself. The fourth swarm came from a frame hive, into which I had put three weak lots last autumn. They settled on the top branch of an espalier apple-tree, and instead of shaking them into a skep, as usual, I placed it over them, in the hope that they would ascend into it, and most of them did so; but, before all were comfortably within, they again took their departure and, ascending high in the air, were soon lost to view. In September I united the bees of two skeps in a frame hive, and also transferred the bees in the box hive into another frame hive. Into each of these I put five frames of honey and brood and two frames with comb foundation; besides this I have given them a little over twenty pounds of syrup and honey, and packed them down with three flour-cakes each. Now, Messrs. Editors, I should be glad to know—1. If I could have done better, and how? 2. Whether you consider this will be enough food to last them till the spring? 3. I made syrup from another fifteen pounds of sugar, but the bees ceased to take it down. I have since boiled it for six or seven hours, and made flour-cake of it. Will this be equally good for the bees? 4. The bees have built the combs together in two hives. How, and when, can this be rectified? My harvest has been fifty one-pound sections of comb honey, fifty-seven pounds of run honey, and a well-filled bell-glass.—INQUIRER, *Launceston, October 22nd.*

REPLY.—1. Without entering into the rather wide question of whether it would have been possible to do better, we may say you have done fairly well. 2. You do not make it quite clear whether the two transferred stocks have had twenty pounds of syrup each or between them; nor is the size or weight of the flour-cakes given. We cannot, therefore, arrive at a correct estimate of what provision each stock has in store. Twenty to twenty-five pounds of syrup per stock is enough to winter on; less than that will suffice if candy is given in addition; but *flour-cake* is not suitable for winter food. 3. We fear you don't quite understand the making of *soft candy*, which is the right kind for bee-food, nor can we imagine what kind of candy would result from boiling syrup 'six or seven hours.' If a sample was sent, we might be able to judge of its suitability, not otherwise. 4. By cutting them asunder, straightening the combs in the frames, and tying them in temporarily, to be fixed and made firm by the bees themselves.

[449.] *Uniting Bees*.—1. I have several surplus stocks (swarms of this past season) which I want to unite to some weak stock hives; what is the best way to do so, and the surest method of preventing the bees fighting when united? I have up to this frequently lost a great part of those united from this cause, though I have sprinkled each lot with scented syrup. 2. Is it necessary to move these surplus stocks by degrees each day, or is there any method you could suggest to prevent loss of bees by taking them at once, and uniting to the hives for which they are intended—as, being some distance apart, moving a yard or so a day would take a considerable time? 3. Is there any danger in not caging the queen in stock hive before uniting bees to it? 4. Which is the best method for introducing a new queen? Do you consider the direct introduction (Simmins's method) a safe one? 5. Is there anything injurious to bees in leaving them combs containing parts of unsealed honey during the winter?—H. B., *Galway, October 26th.*

REPLY.—1. Much depends on the way the operation of uniting is performed. If all the bees can be got off the combs, and are shaken well up together in a skep, sprinkling a little flour over them when mixing, there should be no fighting. 2. It is not quite indispensable to move them close together at this season, but it is better to do so if convenient. 3. Of course, there is some risk, but not much. 4. Simmins's plan is as good as any. 5. It is not well to winter bees on combs of unsealed food.

[450.] *Foul Brood*.—I had a stock which has just died from foul brood. Also another suffering badly from this pest, but in this the bees are in good numbers and working hard. They have taken down about twenty pounds of syrup. Would you advise me to transfer this stock to another hive with only foundation now? If so, kindly say how I should treat them?—D. O'FLAHERTY, *Co. Clare, Ireland.*

REPLY.—If the syrup given the diseased bees was medicated there may be some reasonable hope of a cure, provided naphthaline is used as a disinfectant in addition. If no remedy has been used in the food, nothing can be done until next spring, when, if the bees survive in sufficient numbers, they may be put on full sheets of foundation in a clean hive, and fed up with medicated food. Any hives which have contained diseased bees must, of course, be thoroughly disinfected before being again used.

[451.] *Disinfecting Combs*.—I have quite a number of extracting combs that have never been bred in and that contain no pollen, but that may or may not have been used over diseased stocks, and, as I have no wish to destroy them, as I look upon them as the most valuable part of my bee-furniture, will you please tell me—1. If they could possibly contain any of the germs of disease—and, if so, can these germs be destroyed without damage to the combs by spraying with carbolic acid or fumigating? I would rather melt them down than run any risk, but should be most sorry to have to do so. 2. Dr. Miller recommends letting frost get to them to destroy wax-moth. Do you know if frost would destroy germs of foul brood? If so, how many degrees?—L. H. W.

REPLY.—1. Combs used in diseased stocks may readily contain the germs of foul brood, but if thoroughly fumigated with the fumes of burning sulphur, they may safely be used again. 2. Frost will not destroy the spores which generate the bacillus known as foul brood.

[452.] *Stocks Queenless*.—I am a beginner in bee-keeping. I bought two good large stocks the end of May. From these there were many swarms, three of which were hived. In making up for the winter, both of the old hives were found to be without queens, and the stocks reduced. We added a swarm with a queen to the one stock; the other remains queenless. 1. What is the reason of the old stocks being without queens? 2. Should a queen be introduced now.—NELLIE WOODFORD, *Bath.*

REPLY.—1. The young queens have been lost in some way when on their mating trip. Swarmed hives should always be examined a few weeks after swarming to make sure the young queens are laying. 2. If a queen can be had, and the bees are not too much reduced in numbers, it is not too late to introduce her. The safest method of introducing queens at this season is that known as 'Simmins's' method of direct introduction.

Bee Shows to Come.

November 11th.—Essex Autumn County Show of Honey, held at Corn Exchange, Chelmsford, in connexion with Chrysanthemum Show of Chelmsford Horticultural Society.

WEATHER REPORT.

WESTBOURNE, SUSSEX.

October, 1891.

Max.62° on 9th.	Rain:—7·18 inches.
Min.30° on 31st.	Harvest fall, '98 on 6th.
Min. on grass, 27° on 31st.	Rain on 21 days.
Mean max. 54°	Average, 3·79 in.
„ min.42·5°	Sunshine, 122·65 hours.
„ temp.48·5°	Brightest day, 2nd, 8·90 hours.
	Sunless days, 7.

Remarks.—The wettest month in the last eleven years. South-westerly gales from the 5th to the 22nd, and then north-easterly to the 28th. There has been a great lack of autumn flowers, and bees have already made terrible inroads upon their winter stores. I should advise all who shut up their bees for the winter last month to have one more look at them to make sure.—L. B. BIRKETT.

CROWDING THE BROOD NEST.

For several years past we have had very cold springs, and it has been my custom to contract the brood chambers down to five or six combs, with division boards, and remove the extra combs to the honey-house. Then when the season advanced—grew warmer—and the colonies became strong enough to cover and rear brood in more than the five or six combs, the combs which had been removed were brought out, and one or two at a time, inserted in the hives again.

In giving a colony another comb at this season, I put it at the side of the brood, not in the centre. If it is put in the centre, it does not hasten brood-rearing very much, if any, but tends to scatter the brood, and if it turns cold some of the outside brood may chill.

During the last eight or ten years there have been four or five times when the combs were returned to the hives fast enough, generally by neglect. What was the consequence? Well, it was this. The five or six combs were found thoroughly crowded with brood and bees, little ridges of new comb started here and there, and in a large number of hives queen-cells were under way.

It is seldom that I desire any swarms at all. I prefer to run the colonies straight through the season, in full force. Now, when these colonies were found with queen-cells started for swarming, the division boards were moved further away, and four or five more combs put in at once.

Did they preserve the cells and cast a swarm, after the addition of combs and the enlargement of the brood chamber? They did not. Not one colony in seventy-five swarmed. In less than three days all these queen-cells were emptied of their contents.

What became of the eggs and larvæ that the queen-cells contained? I believe the bees re-

moved them. I never believed that these colonies had the 'swarming fever.' Still, in all probability they would have swarmed if allowed to remain in their contracted condition.

At other times cells were far enough along to be capped when the original brood combs were distributed amongst three times their number of empty combs and foundation, and they swarmed just the same. Even if the cells were cut out, they started more and swarmed.

'A stitch in time saves nine,' runs the old adage, and it is no more applicable anywhere than in the prevention of swarming. The way to apply it is to destroy the cells as soon as started, instead of destroying them after they are finished. It would be still more advantageous to prevent eggs ever being placed in the cups.

If there is empty comb, either for the storage of honey or the rearing of brood, close to the brood nest all the time, not one colony in fifty swarms.—C. L. DAYTON, in '*Am. Bee Journal*.'

HONEY BEVERAGES.

The earliest manufactured kind of intoxicating liquid was probably mead. From honey a fermented beverage is made, which is largely used throughout the Soudan. Mead is said to have been the principal beverage of the Britons before the use of malt liquors among them, and long after the introduction of the latter beverages mead was a favourite drink. Under the name of metheglin it was frequently alluded to by old writers. Mead formed the ancient, and for centuries the favourite, beverage of the northern nations. It is still called by the Germans honey wine. Mead is frequently mentioned by Ossian. Dryden has a couplet:—

'T'allay the strength and hardness of the wine,
Let with old Bacchus new Metheglin join.'

Queen Elizabeth was so fond of mead as to have had it made for her every year.

Mead formed the nectar of the Scandinavian nations, and was celebrated by their bards; it was the drink which they expected to quaff in heaven out of the skulls of their enemies, and was, as might be expected, liberally patronised on earth. The Scandinavian mead is flavoured with primrose blossoms. In Spain mead is known as *aloja*.

The Africans use several honey drinks, hives being common. In Madagascar they make a honey wine, a composition of three parts of water to one of honey, which they boil together and skim after it is reduced to three-fourths. They afterwards put it to ferment in large pots of black earth. This wine has a pleasant tartish taste, but is too luscious. In Abyssinia, according to Bruce, they use five or six quarts of water to one quart of honey. These they mix together in a jar, throw in a handful of parched barley meal and some chips of bitter bark, which in two or three days takes off the cloying taste of the honey, and makes the beverage wholesome and palatable.

Braggon, or bragget, was a sort of metheglin. Hydromel is honey and water submitted to fermentation. Oxymel is a mixture of honey and vinegar. Here is a more modern recipe than Queen Elizabeth's for mead: 8 ounces each of sarsaparilla, liquorice root, ginger, and cassia bark; 2 ounces of cloves and 3 ounces of coriander, suitably cut and bruised, are boiled for fifteen minutes in 8 gallons of water, allowed to cool and settle, and then strained through flannel. To this is added in the fountain $1\frac{1}{2}$ gallons syrup, $\frac{1}{2}$ gallon honey, 4 ounces each of tincture of ginger and solution of citric acid, and afterwards sufficient water to make 10 gallons, when it is charged with carbonic acid gas.

Honey Wine is made of the juice of the best grapes, well ripened, and kept twenty days before pressing, to which five parts of the finest honey should be added, and all well stirred in a wooden vessel. Cover with a linen cloth, and allow to ferment for forty days, the scum being occasionally removed. It is then put in a light cask, and so kept till the ensuing spring, when it is bottled.

The Jews in Morocco are very fond of Mahaya, a weak, colourless spirit, flavoured with aniseed, which they prepare from water in which honey-combs have been boiled. The distillation of this spirit is conducted in the rudest manner. Dr. Leared, in his work, *Morocco and the Moors*, states having witnessed the process. The condenser consists of an old gun-barrel, while the water into which the lower end was plunged, in order to cause condensation, was allowed to become too hot for the hand to bear.

Honey-Currant Wine.—To 3 quarts of juice add 3 pounds of honey and water to make 1 gallon. Let it ferment four or five weeks with open bung, and keep the barrel always full, in a warm place, then drain and put into another barrel in the cellar. It makes a most delicious drink.

Honey Nojéau.—Four ounces of bitter almonds 2 ounces of sweet almonds, 2 pounds of loaf sugar, 3 lemons, 2 quarts of gin, 2 large spoonfuls of clarified honey, and 1 pint of milk. Blanch and pound the almonds, and mix them with the sugar, which should be rolled. Boil the milk, and, when cold, add all the ingredients together, and let them stand ten days, shaking them every day. Filter the mixture through blotting-paper, bottle off for use, and seal the corks down.

Cheap Harvest Drink.—To those engaged in harvesting and other occupations tending to create thirst, the following preparation may be recommended, which makes a very palatable and healthful drink in hot weather: Take 12 gallons of water, 20 pounds of honey, and 6 eggs, using the whites only. Let these boil one hour, then add cinnamon, ginger, cloves, mace, and a little rosemary. When cold, add one spoonful of yeast from the brewer; stir it well, and in twenty-four hours it will be good for use.—P. L. SIMMONDS, F.L.S.—*W. M. Trade Review*.

SHAKESPEARE ON BEES.

(Continued from p. 495.)

Wax is brought forward as a material for sealing in the following passage:—

'Is not this a lamentable thing, that of the skin of an innocent lamb should be made parchment? That parchment, being scribbled o'er, should undo a man? Some say, the bee stings: but I say, 'tis the bee's-wax: for I did but seal once to a thing, and I was never mine own man since.'

Second Part of Henry VI., Act IV., Scene 2.

'Leave, gentle wax; and, manners, blame us not:

To know our enemies' minds, we'd rip their hearts;

Their papers, is more lawful.'

King Lear, Act IV., Scene 6.

And again:—

'Good wax, thy leave,—bless'd be

Yon bees, that make these locks of counsel
Lovers

And men in dangerous bonds pray not alike

Though forfeiters you cast in prison yet,

You clasp young Cupid's tables.'

Cymbeline, Act III, Scene 2.

It was at one time thought that pollen was wax, and Shakespeare adopted this idea:—

'Our thighs are pack'd with wax.'

Honey is of frequent occurrence, and King Henry V. at Agincourt is made to say:—

'There is some soul of goodness in things evil,

Would men observingly distil it out:

Thus may we gather honey from the weed.'

Act IV., Scene 1.

(To be continued.)

Notices to Correspondents and Inquirers.

Letters or queries asking for addresses of manufacturers or correspondents, or where appliances can be purchased, or replies giving such information, can only be inserted as advertisements. The space devoted to letters, queries, and replies, is meant for the general good of bee-keepers, and not for advertisements. We wish our Correspondents to bear in mind that, as it is necessary for us to go to press in advance of the date of issue, queries cannot always be replied to in the issue immediately following the receipt of their communication. All queries forwarded will be attended to, and those only of personal interest will be answered in this column.

E. A. DOUGLAS.—Recipe for making candy appears in *B. J.* for January 29th. Give it in one large cake.

D. PRATT.—*Foreign Honey*.—The sample sent is certainly honey, but neither its flavour nor aroma will commend it to British consumers. It is a strong, rank-flavoured honey, and, to our taste, is quite unfit for table use.

W. B. CHAMBERS (Durham).—Bee sent is not a queen at all—simply a mutilated worker.

H. B. (Winchester).—Give a five-pound cake of soft candy in addition to the syrup. If made carefully from recipe it should not go wrong.

Special Prepaid Advertisements.

Situations, Publications, Bee Plants, &c.—Twelve words and under, Sixpence; for every additional Three words, One Penny.

Trade Advertisements not inserted under this head.

WALLFLOWERS.—Fifty Plants, 1s. free. Arabis, 1s. per dozen. Address **NORMAN PARKIN**, Blakenhall, Wolverhampton. L 51

WANTED.—1 lb. Sections, well filled, sealed, and clean. Also Extracted Honey, any quantity. Address **NYE & SONS**, 1 Western Street, Brighton. L 55

BEE SMOKE!—No. 1 P. 'C. Cartridges, 3s. 6d. per gross; half-gross, 2s. No. 2 ditto, 5s. per gross; half-gross, 2s. 9d. If fitted up with Cotton Wicks add 6d. per gross extra. Samples free 4d. stamps. Orders over 20s. Carriage paid. Address **THOMPSON & NORRIS**, Manufacturing Co. Limited, 37 and 39 Britannia Row, Essex Road, London, N. L 74

FOR SALE.—Seven Bar-frame Hives and two Skeps (single or otherwise), well stocked with healthy Bees. What offers? Address **74 Lowe Street, Wolverhampton.** L 75

FOR SALE.—Bar-frame Hive of Bees, with plenty of food for Winter, 20s. Also Heather Honey, 8d. per lb. Address **Miss AULSEBROOK**, Rivington, Chorley. L 76

LIMNANTHES DOUGLASSII.—Bees delight to work it all weathers. Abundant bloomers. 125 Plants 1s. 3d., carriage paid. Cash with order. Address **J. BENNETT**, 175 Spon Street, Coventry. L 77

WILL Exchange Violin (15s.) What offers? Address **C. BIRD**, Ashdon, S. Walden, Essex. L 78

WANTED.—Extracted Honey (Granulated) in bulk. Address **W. RUSHTON**, Bee Farm, Bedford.

THE 'GARSTANG' HONEY PRESS.

(As published in British Bee Journal for Sept. 10.)

Inside Plates either Wood or Iron.

Prices on application. 3282

Address **ROBERT BARTON**, Garstang, Lancashire.

NEW EDITION NOW READY.

21st Thousand.

THE BRITISH BEE-KEEPER'S GUIDE-BOOK.

By **THOS. WM. COWAN**, F.L.S., F.G.S., &c.

Revised and enlarged.

Almost entirely re-written. Much new matter and many fresh illustrations added.

Fcap. 8vo., price 1s. 6d.; or in cloth gilt, 2s. 6d. Postage, 2d.

To be had of **HOULSTON & SONS**, Paternoster Sq.; all Hive Dealers, Secretaries of Bee-keepers' Associations, and of **J. HUCKLE**, *British Bee Journal* Office, Kings Langley, Herts.

BRITISH BEE-KEEPERS' PRACTICAL NOTE-BOOK.

With Rules for the General Management of Movable Comb Hives.

By **THOS. W. COWAN**, F.G.S., &c., Editor *British Bee Journal*.

Consists of a Series of Tables by means of which the Bee-keeper can keep a record of all his Observations and Operations. A Pocket-companion indispensable to the practical Bee-keeper.

Price 1s., postage 1d.

Bee Journal Office, Kings Langley, Herts; and 17 King William Street, Strand, W.C.

BALDWIN'S is the Oldest Establishment in the United Kingdom wholly devoted to Bees and manufacture of

Bee-keepers' supplies. His prices will compare most favourably with those of any other Maker, while for quality of material, suitability and workmanship, he has no rival.

'Why can he give better value for money than others?' Because he spends less in large 'puffing' advertisements, buys in the best markets for prompt cash, has no rent to pay, and personally conducts his own business.

For prices and full particulars of Goods see Baldwin's Bee-keepers' Instructor (and Illustrated Catalogue combined), which 'contains more practical and reliable hints than all the large, expensive books,' post free for 2d. stamps. Address **S. J. BALDWIN The Apiary, Bromley, Kent.**

N.B.—More than 500 Silver and Bronze Medals, First and other Prizes, and Testimonials innumerable.

THE 'ENGLISH' HIVE.

Transferring Season now on.

TRY THIS HIVE, it is the best in use, and once used will be always used. No more cutting Quilts necessary, as the Bees can be fed from the side of the Hive. See description in *B. B. J.*, August 6th, 1891, p. 351. Price for Floor-board, Body, and Zinc-covered Roof, 11/6 only. The English Wax Extractor, price 7/6.

For particulars apply to **A. T. WILMOT**, St. Albans. 3149

British Bee Journal and Bee-keepers' Record.

OFFICE:

17 KING WILLIAM STREET, STRAND, LONDON, W.C

PURE CANE SUGARS.

For the accommodation of Bee-keepers, guaranteed Pure Cane Sugar will be supplied in large or small quantities through this office at the under-mentioned rates:—

MOIST. (For Household Use.)

Neat bags, 14-lbs. 2s. 10/-, 56-lbs. Cwts.

3. MUSCOVADO 2/7 5/2 10/- 19/6

CRYSTALLISED.

4. DEMERARA } Crystals 2/9 5/4 10/6 20/6
5. BARBADOS }
6. TRINIDAD }

REFINED CANE.

7. WHITE CRYSTALS (Small) 3/0 5/10 11/6 22/6
8, 9. (Medium and Large sizes, 1/- per Cwt. extra.)
10. LUMP (Cut Loaf) ... Boxes, 3/3 6/3 12/3 23/6
11. LUMP DUST 3/ 6/- 11/9 22/9
12. PRESERVING 3/- 6/- 11/9 22/9

FINE. (For Household Use.)

13. GRANULATED ... 3/3 6/3 12/3 23/9
14. CASTOR Coarse (15 Fine) 3/9 7/3 14/3 27/9
15. ICING... .. 4/3 8/3 15/9 31/-

All above guaranteed made from CANE SUGAR only, and free from BEET, CHEMICALS, etc., etc.

CARRIAGE PAID on Orders over 5/0 (or 2s. 10/- Sugar) to London and Suburbs.

COUNTRY ORDERS, not less than 2-cwt. carriage paid at 1/0 per cwt. extra.

(Scotch and Irish orders, special arrangements.)

CHEQUES payable to **J. HUCKLE**, Kings Langley.

Cash to be sent with order, and purchasers will please observe that if samples are required or replies asked to inquiries, a stamped addressed envelope must be sent, as we cannot undertake cost of postage.

THE
British Bee Journal,
BEE-KEEPERS' RECORD AND ADVISER.

No. 490. Vol. XIX. N. S. 93.]

NOVEMBER 12, 1891.

[Published Weekly.]

Editorial, Notices, &c.

ABOUT BEES.

Solomon knew the flavour of good honey. He said, 'My son, eat thou honey, because it is good;' 'pleasant words are as an honeycomb, sweet to the soul.' He likened the knowledge of wisdom to the sweetness of honey. There is much in the Bible which speaks of an early appreciation of this luxury. Artificial dainties were then not so sought after as this natural one given by God. Men knew how to prize a land 'flowing with milk and honey;' they asked for nothing better. We read that the ancient Egyptians had floating apiaries upon the waters of the Nile, as is practised still. With all their old pyramids and sphinxes, they did not neglect the wisdom of keeping bees. It would be well for us if we still relied more on these pure products of nature, instead of taxing our invention to concoct novel and unwholesome dishes. Mr. Burroughs, the author of *Locusts and Wild Honey*, seems to envy John the Baptist his wilderness fare; and not without reason, if the honey was good. A legend tells us that Homer was nursed by a priestess, from whose breast he drew distilled honey, which accounts for the beauty of his style. Pindar, also, as he lay a helpless babe, was visited by a swarm of bees, which left a drop of honey on his lip. Both these poets, therefore, had reason for their mellifluousness. The heroes and demi-gods of Greece all had a taste for the honeys of Hymettus, Ida, and Hybla; and Virgil, in later days, takes the whole of his fourth Georgic to tell us how to manage bees, showing what importance he placed on the subject.

That bee-culture was one of the earliest arts is sufficiently proved by the fact that Aristæus, son of Apollo and Cyrene, who was born in the Libyan deserts, and reared by the Seasons, is handed down to us by mythology as the first that taught their management. A man's bees once shared a place with his flocks in his domestic economy; yet now to keep hives is rather the exception than the rule. 'But honey is honey the world over,' says Mr. Burroughs, 'and the bee is the bee still.' The promised Canaan 'flowed with milk and honey,' and from this sweet substance we derive the name of that season in our lives which ought to be so indescribably happy. Yet, occasionally, even honey is flavourless or distasteful—alas, that this should be paralleled in life! There is a rhododendron

in Trebizond whereof if a man eat the honey he becomes mad.

But we are now about to deal with the antiquities or curiosities of honey culture. There are many superstitions connected with bees, which, as fragments of British folk-lore, are worthy of attention. For example, there is that very prevalent idea which links the bees with the 'household gods' of a family, and supposes them to take a lively interest in their owner's fortunes and welfare. In many parts of the country it is supposed that unless the bees are informed of the death of any member of the family to which they belong they will desert their hives, or perhaps die. A writer in *Notes and Queries* (Vol. V.) observes, speaking of this superstition in Essex, 'A lady tells me that, calling upon some poor people who lived at Hyde Green, near Ingatstone, she inquired after the bees. The old woman of the house replied, "They have all gone away since the death of poor Dick; for we forgot to knock at the hives and tell them he was dead." In some places it is even usual to give the bees a piece of the funeral cake, and to drape the hive in mourning.

Another writer, noting these superstitions in Devonshire, says:—'I once knew an apprentice boy sent back from the funeral *cortège* by the nurse to tell the bees of the death, as it had been forgotten. They usually put some honey and wine for them before the hives on that day.' In Buckinghamshire it was formerly common, and may occasionally be practised now, to go round to all the hives in the garden after a death and tap three times, repeating, 'Little brownie, little brownie, your master's dead,' the omission of which would have caused the flight of the swarm. It seems that a similar practice is observed in Lithuania. It is supposed that in reality the bees know of the events without being told, but that, from a species of pride almost human, they insist on being formally acquainted, or they will desert the hives in a 'tiff.' We are informed by a writer that, noticing the empty hives when he called to visit at a house, he asked the cause, and was told that the bees had deserted through not having been informed of their master's death. A little delicacy of feeling on the part of the bees might, we think, induce them to overlook the probably unintentional slight, and to make allowance for the grief and distraction of the family; but they are inflexible. No wise bee-keeper would dare to omit this little piece of etiquette.

In Derbyshire, Lincolnshire, Sussex, and other counties, there is an idea that for a swarm of bees to settle on a dead trunk of tree is a sure sign of approaching death in a family. We are told of one death which was probably really caused by this occurrence. A swarm of bees had made the selection of a dead stake for a settling-place a fortnight before the confinement of a respectable cottage-wife. Both the husband and herself regarded this as a warning, and were prepared for the event, which not unnaturally followed, for, of course, the poor woman, in her weakened condition, was not strong enough to withstand the influence of such a superstition. The wild bee also shares in some of these superstitions. In Northamptonshire it was supposed a certain omen of death for a humble-bee to enter a cottage. There may possibly be some connexion between these beliefs and the fact that in ancient times honey was a symbol of death.

Alfred Gatty, speaking of the custom of inviting bees to funerals, tells us that at Bradford, in the parish of Ecclesfield, the practice, according to the testimony of a respectable person, had been observed for hundreds of years. When the death happened, the friend who was deputed to carry invitations to the neighbours for the funeral, also called at the hives and gave the same invitation in the same words. If this were omitted, the bees were supposed to take it so much to heart as to die. Some bee-owners, the Rev. J. G. Wood tells us, think it wise also to acquaint the bees of the death of distant relatives. Some suppose, also, that the bees take as much interest in weddings as in funerals, and take it sadly amiss if their hives be not decorated with wedding favours. These superstitions are not merely local, but are found in all parts of the country and on the Continent. It is impossible to ignore or despise them; they are a veritable feature in our folk-lore. Among other ideas connected with bees, it is supposed to be unlucky to sell them. This difficulty is avoided by the practice of barter, or sometimes under the feint of giving presents. To sell the insects outright would be a terrible omen, but to give a bushel of corn, a little pig, or some other equivalent in exchange, escapes the danger. There is also an idea that bees will never thrive in the possession of a quarrelsome family, and that stolen bees are never successful, but will pine and die.

A rather curious story is told concerning a swarm of bees, connected with an old house called *The Mote*, at Ightham, in Kent. A settlement of these insects had long been established in quarters under the flooring of an ancient chapel belonging to the mansion. On the death of one of the proprietors, during the present century, these all disappeared, going on the very day of decease. But when the next occupant arrived the bees arrived also, and again settled themselves in their old quarters. Unluckily the winter following was very severe, and the cold caused them all to perish. It would seem, however, that their spirits had survived, and had

taken possession of other bees, for on the first sunny day of the succeeding spring a fine swarm of bees was observed to sweep up the glades towards the house, never halting for a moment till they reached the old chapel, when they at once flew to the entrance-hole, and took possession. Here they settled, as though in an old and familiar home.—*Yorks. Post.*

BEEES AS FERTILISERS.

Darwin's memorable researches and generalisations in relation to the fertilisation and cross-fertilisation of plants, through the agency of insects, are not the least of his many valuable scientific discoveries, nor yet are they least in their bearings on economic questions. His classic investigations settled the question of the great value of insects in securing full fruitage to many of our most valuable fruits and vegetables. Since Darwin many scientists have, by crucial tests and experiments, abundantly confirmed his conclusions. Our more intelligent practical men have also made significant observations. They note a scarcity of insect visits to the blossoms of the first crop of red clover, and also its failure to bear seed. The alsike clover is freely visited in early June by the honey-bee, and bears a full crop of seed. In New Zealand, the red clover failed to seed at all seasons, and there was a conspicuous absence of insects upon the blossoms, both early and late. This led to the importation of bumble-bees from England to the earth's very limit, and now the New Zealand farmer produces clover seed. Gardeners keep bees to-day that their vegetables may fruit and seed more liberally. Even the producers of flower-seeds in our cities keep bees in their greenhouses, as they find this the easiest and cheapest method to secure that more perfect fertilisation upon which their profits depend. Secretary Farnsworth, of the Ohio Horticultural Society, could account for a very meagre crop of fruit a few years since in his vicinity, after a profusion of bloom, only through lack of pollinisation. The bees had nearly all died off the previous winter. I have often noted the fact that, if we have rain and cold all during the fruit-bloom, as we did in the spring of 1890, even trees that bloom fully are almost sure to bear as sparingly.

Darwin's researches considered insects as a whole, and it is true that all insects that visit flowers, either for nectar or pollen, do valuable service in this work of pollinisation. Thus many of the hymenoptera, diptera, and coleoptera, and not a few lepidoptera, are our ever-ready helpers as pollenisers. Yet early in the season, in our northern latitudes, most insects are scarce. The severe winters so thin their numbers that we find barely one, whereas we will find hundreds in late summer and early autumn. In late summer the bumble-bees and paper-making wasps number scores to each colony, while in spring only the one fertile female will be found. This is less conspicuously

true of solitary insects, like most of our native bees and wasps; yet even these swarm in late summer, where they were solitary or scattering in the early spring. The honey-bees are a notable exception to this rule. They live over winter, so that even in early spring we may find ten or fifteen thousand in a single colony, in lieu of one solitary female, as seen in the nest of *bombus* or *vespa*. By actual count in time of fruit-bloom in May, I have found the bees twenty to one of all other insects upon the flowers; and on cool days, which are very common at this early season, I have known hundreds of bees on the fruit-blossoms, while I could not find a single other insect. Thus we see that the honey-bees are exceedingly important in the economy of vegetable growth and fruitage, especially of all such plants as blossom early in the season. We have all noticed how much more common our flowers are in autumn than in spring-time. In spring we hunt for the claytonia, the trillium, and the erythronium. In autumn we gather the asters and golden-rods by the armful, and they look up at us from every marsh, fence-corner, and common. In May *our* flowers demand a search, while in California the fields of January and February are one sea of blossoms. The mild Californian winters do not kill the insects. There a profusion of marriage-priests, and a profusion of seed *will* greet the coming spring-time. Thus our climate acts upon the insects, and the insects upon the flowers, and we understand why our peculiar flora was developed. Yet, notwithstanding the admirable demonstrations of the great master, Darwin, and the observations and practice of a few of our intelligent practical men, yet the great mass of our farmers are either ignorant or indifferent as to this matter, and so to the important practical considerations which wait upon it. This is very evident, as appears from the fact that many legislators, the past winter, when called upon to protect the bees, urged that fruit-growers had interests as well as the bee-men, not seeming to know that one of the greatest of these interests rested with the very bees for which protection was asked.

Now that we understand the significance of the law of adaptation in reference to the progressive development of species, we easily understand why our introduced fruits that blossom early would find a lack of the 'marriage-priests,' and why it would be a matter of necessity to introduce the honey-bee, which, like the fruits, are not indigenous to our country, just as the bumble-bee must go with the red clover if the latter is to succeed at once in far-off New Zealand.

It is true that we have native apples, cherries, plums, &c.; but these, like the early insects, were scattering, not massed in large orchards, and very likely the fruitage of these, before the introduction of the honey-bee, may have been scant and meagre.

Now that spraying our fruit-trees with the arsenites early in the spring is known to be so

profitable, and is coming, and will continue to come, more generally into use, and as such spraying is fatal to the bees if performed during the time of bloom, and not only fatal to the imago, but to the brood to which it is fed in the hive, it becomes a question of momentous importance that *all* should know that bees are valuable to the fruit-grower and the apiarist alike, and that the pomologist who poisons the bees is surely killing the goose that laid the golden egg. That bees are easily poisoned by applying spray to trees that bear nectar-secreting blossoms at the time of bloom can be easily demonstrated by any one in a very short period of time. It has been demonstrated in a frightfully expensive manner in several apiaries in various parts of the country. Several bee-keepers, whose all was invested in bees, have lost all this property, all because some fruit-growing neighbour either thoughtlessly or ignorantly sprayed his fruit-trees while in bloom; and this in the face of the fact that, for the best results, even in the direction sought, the spraying should be deferred until the blossoms fall. I have demonstrated this fact, where the results were entirely in sight. I have shut bees in a cage, and given them sweetened water containing London purple in the proportion of one pound to 200 gallons of water, and in twenty-four hours the bees were all dead; while other bees, in precisely similar cages, and fed on precisely the same food, with the poison omitted, lived for many days.

We thus see that it becomes very important that pomologist and bee-keeper alike know the danger, and also know the loss to both parties in case caution is not observed to avoid the danger and probable loss. It is also important that, by definite experimentation, we may learn just how important the bees are in the pollination of plants. To determine this point, I tried many experiments last spring. I counted the blossoms on each of two branches, or plants, of apple, cherry, pear, strawberry, raspberry, and clover. One of these, in case of each fruit or each experiment, was surrounded by cheese-cloth just before the blossoms opened, and kept covered till the blossoms fell off. The apple, pear, and cherry were covered May 4th, and uncovered May 25th and May 19th. The number of blossoms considered varied from 32, the smallest number, to 300, the largest. The trees were examined June 11th, to see what number of the fruit had set. The percentage of blossoms which developed on the covered trees was a little over two, while almost 20 per cent. of the uncovered blossoms had developed. Of the pears, not one of the covered developed, while 5 per cent. of the uncovered developed fruit. Of the cherries, 3 per cent. only of the covered developed, while 40 per cent. of the uncovered blossoms set their fruit. The strawberries were covered May 18th, and uncovered June 16th. The number of blossoms in each experiment varied from 60 in the least to 212 in the greatest. In these cases, a box covered with cheese-cloth surrounded the plants. The plants

were examined June 22nd. Eleven per cent. of the covered blossoms, and 17 per cent. of the uncovered had developed. To show the details, in one case 60 blossoms were considered, nine of which in the covered lot, and 27 in the uncovered, had developed; that is, three times as many flowers had set in the uncovered as in the covered. In another case of 212 blossoms, the fruit numbered 80 and 104. In a case of 123 blossoms, the number of fruit was 20 and 36.

These experiments agree with similar ones of former years, in seeming to show that strawberries are less affected than other fruit by the exclusion of insect visits. The raspberry canes were covered with cheese-cloth May 30th, and uncovered July 6th. In every case but one the canes seemed to have been injured by the covers, and so the results were not considered. In the exceptional case, 184 blossoms were considered; 93 blossoms developed on the covered canes, and 160 on the uncovered. In every case the fruit on the covered twigs was inferior. It might be thought that the simple presence of the covers was prejudicial; though this could not be a very important matter, as blossoms covered after the bees had freely visited them set well, and showed no injury. Thus we see that, in all our fruits—strawberries the least—the free visits of insects during the period of blooming is absolutely essential to a full or even a fair crop. In many cases the covered blossoms all failed to develop. We also see that, where fruitage does occur, there seems a lack, as the fruit lacks vigour. The free and ample *cross-fertilisation* seems to be requisite, not only for a crop, but for a perfect development and maximum vigour.

Our experiments with clovers were tried with both the white and alsike. While the uncovered heads were full of seeds, the covered ones were entirely seedless. This fully explains the common experience of farmers with these plants.

Having the law of the necessity of insects to accomplish this function so well demonstrated, it might be asked, 'Why do we have *any* fruit in case the blossoms are covered?' This seeming exception may be no exception. Indeed, this may come from the fact that *all* insects are not excluded. Very small insects, like the thrips and various of the jassidæ, which we know are often attracted to flowers, either by the pollen or nectar, would be concealed about the plants, and, from their small size, might gain access, even after the covers were adjusted. These would be sufficient to secure partial fertilisation, and very likely are the cause of the meagre crop which, in a few cases, we secured, even on the covered twigs.

In case of strawberries, our experiments this year, like some previously tried, seemed to show that the presence of insects, though important to a maximum production, are not so necessary as in case of nearly all other fruit. But we must remember that the strawberry plants are not wholly enclosed. A cloth-covered box rests on the ground about the plant. This gives a fine chance for insects that burrow in the earth, and for insects that have pupated in like position,

to come up during the three or four weeks of the experiment, and pollenate the blossoms. This, though a possible and (shall I say?) a probable explanation, may not be the real one; but we can still affirm, in case of the strawberry, that the free visits of insects serve surely to much enlarge the production of fruits.

Thus we see that our horticulturists and farmers, alike with the apiarist, are dependent for the best prosperity on the presence and well-being of the bees. They should realise this fact, and should demand that our legislators not only become informed, but act accordingly.—PROFESSOR A. J. COOK, in '*Gleanings*.'

DEATH OF A BEE-KEEPER.

Readers will share our deep regret on hearing of the death of Mr. Charles Caffyn Pilfold, at Horsham, Sussex, on October 26th, 1891, aged seventy-five years. While at Valentia Island, for many years, Mr. Pilfold was a constant contributor to our columns, and while residing at Horsham, for some months past, he contributed a most interesting paper on Bee-keeping in Valentia Island, which appeared in our issue for April 30th (p. 210), as well as a descriptive article on Valentia, in the *Bee Journal* for May 21st.

KENT BEE-KEEPERS' ASSOCIATION.

A Council meeting of this Association was held on Friday, the 30th ult., at the Horticultural College, Swanley. Business of a routine character having been disposed of, the attention of the meeting was given to a proposal to create a new branch or centre of the Association at the College, with a view to uniting the bee-keepers of the district. The conditions of the proposal that the members of the Association should have the privilege of inspecting the model apiary and obtaining practical information thereat was regarded as of so great a value that it was unanimously agreed to organize the branch as quickly as possible. Subsequent to the Council a conference of friends interested in the proposal was held, and it was agreed that a public meeting should be called at an early date to enrol members and arrange a plan of working. It may be stated that the College is the recipient of a large contribution of money from the County Council, to be devoted to technical education in horticulture and kindred subjects, amongst which bee-keeping finds a place. By means of this a great impetus is given to the work of the institution, which bids fair to become a most valuable centre for promoting the interests of fruit-growers, and other rural industries.

HONEY IMPORTS.

The total value of honey imported into the United Kingdom during the month of October, 1891, was 811l.—*From a return furnished by the Statistical Office, H.M. Customs.*

WEATHER REPORT.

BUCKNALL, LINCOLN. BM 25.

October, 1891.

Maximum, 63° on 1st Rain :—3·83 inches.
 and 3rd. Average, 5 years, 2·29 in.
 Min., 26° on 30th. In 24 hrs. '65 on 6th.
 Mean max. 56·5° Rain on 22 days.
 „ min. 39·6° Several frosts.
 „ temp. 48·0° Range, 16·9
 „ of 6 years 46·8

Remarks.—The month has been remarkable for its warm nights, and frequent changes from rain to bright summer weather.—J. BINT.

'BEE PAPERS FOR WINTER READING'
 AND 'OUR PROMINENT BEE-KEEPERS.'

The series of articles on both the above subjects, the publication of which has been suspended during the summer months, will shortly be resumed.

Correspondence.

The Editors do not hold themselves responsible for the opinions expressed by correspondents. No notice will be taken of anonymous communications, and correspondents are requested to write on one side of the paper only, and give their real names and addresses, not necessarily for publication, but as a guarantee of good faith. Illustrations should be drawn on separate pieces of paper.

Communications relating to the literary department reports of Associations, Shows, Meetings, Echoes, Queries, Books for Review, &c., must be addressed only to 'The Editors of the "British Bee Journal," 17 King William Street, Strand, London, W.C.' All business communications relating to Advertisements, &c., must be addressed to Mr. J. HUCKLE, Kings Langley, Herts (see 1st page of Advertisements).

* * * In order to facilitate reference, Correspondents, when speaking of any letter or query previously inserted, will oblige by mentioning the number of the letter, as well as the page on which it appears.

BEEES AND THE PRODUCTION OF
 HEAT.

[838.] The fact that bees use as nearly as possible a minimum of wax in the construction of their cells has been adduced as an example of the application of evolution. Darwin suggests, in his *Origin of Species*, that the great expenditure of labour and valuable time in the production of wax is the chief factor in lessening the quantity used. The Bishop of Carlisle, in the *Nineteenth Century* for October last year, expressed his doubts concerning the validity of this view. I should like to suggest other advantages gained by such economy of wax. During the winter the bees cluster as closely as possible for warmth. Everything that keeps them in loose order causes individuals to consume and digest additional food in order to produce heat, and thus to wear themselves out more rapidly than they otherwise would do. In the cluster on the empty combs what is not wax consists of bees; thus, the less wax there is the greater is the number of bees that can

pack themselves into a given space, and the less are the energies of the bees impaired by the digestion of food. Skilled bee-keepers tacitly recognise this by advising that the distance between adjacent combs should be increased during the autumn and early winter. When spring approaches the bee-keeper diminishes the distance between the combs to a minimum. This he does in order that the bees may cover as much comb surface as possible, and so keep the maximum number of larvæ and eggs at the necessary high temperature. Here, again, the expenditure of useless wax would diminish the number of larvæ to be covered by a given number of bees. I should like to hear the opinion of experts as to the value of these advantages compared with the saving of time effected at the swarming season. It is not necessary in this letter to explain how, by the principle of evolution, these advantages would gradually alter the habits and shape of the bee in so far as they are connected with comb-building. It is rather my object to suggest that the gain is very considerable.—J. C. ILES, *Uttoxeter, November 5th.*

AVERAGE HONEY YIELDS.

[839.] It would be interesting, in connexion with the Californian record you gave last week, if some of our leading bee-keepers would send you the figures of their average harvest per hive for a number of years. Then, by a comparison of these, some idea might be formed of what is an average yield in England.

I append my own results for the last seven years, which, though very humble by the side of American figures, may, I hope, be the first instalment of some useful information.

	Average per Hive.	Rainfall.
	Pounds.	Inches.
1885	42	29·68
1886	28	31·62
1887	34	23·44
1888	4	29·83
1889	66	27·53
1890	14	24·13
1891	60	27·79

(up to end of Oct.)

Average per hive for the whole time, thirty-five pounds.—L. B. BIRKETT, *Sussex.*

[Records like the above will, no doubt, be very interesting, but a return of the number of colonies would add very materially to the usefulness.—Eds.]

OVERSTOCKING BEE-DISTRICTS.

[840.] I have read with much interest your article on average honey yields in this issue, and think all bee-keepers are indebted to you for a table which, if it does not solve the oft-asked question of how many stocks a district can profitably support, may help us to form some idea on the subject, as from the table given it

seems very plain that if such a district as that in which the 'Sespe' apiary is situated, abounding in rich pasture, will not support 400 stocks, how can we expect some of our English districts, where bees have to hunt diligently to find honey at all, to support large apiaries?—though I do not think any one in England would congregate 400 or 500 hives in one spot with any idea of profit. A little calculation will, perhaps, make the matter clearer. Taking a radius of two miles all round an apiary gives a working area for the bees of 12·56 square miles. If this apiary contains 100 hives, each hive with a population of 40,000 gathering bees ('Rather a strong lot,' I think I hear some of our readers say—still they do have strong lots in America, of bees as well as other things), each bee will only have an area of 9·67 square yards to work on. Not a very large domain that! If 450 hives were kept, this gathering-ground for each little worker is reduced to 2·15 square yards.

If districts are stocked at this rate, no wonder that the morals of the bees suffer, and they take to evil ways and rob, and when we consider and think of the acres of land round our apiaries here that are unproductive of *any* honey it is easy to see that it is not so difficult to overstock a district as it looks at first sight. Here, within a radius of a quarter of a mile, there are a thirty hives, not all of the strength I have indicated; within a mile in a southerly direction is the town with its smoke, so all honey-gathering has to be done north, east, and west, and as the land is largely used for root crops, and there are nearly a dozen more hives within the two-mile radius, I should say we were quite sufficiently stocked, and next year, if spared, I shall endeavour to distribute my hives, taking one here and another there, putting them in some quiet corner of a clover field, and see if I can help them to get honey better than those hives that are further from their pasturage. It may entail a little more work for their owner, but I think it will be trouble well repaid. What think you, Mr. Editor?—F. J. CRIBB, *Morton, Gainsborough, November 6th, 1891.*

[Much will depend upon circumstances.—EDS.]

DRY FOOD FOR BEES.

[841.] In your footnote to my letter (826) you say—1. 'Our correspondent lays down a proposition as little likely to meet with the favour of practical bee-keepers as that to which we took objection in his former note.' 2. 'Experience goes to prove that, for reasons *many and weighty*, it is most unwise to feed bees in winter-time by leaving an inverted bottle of syrup above the cluster.' 3. 'If our correspondent proposes to prove the contrary, we may at least express the hope that he will try the experiment on his own bees, and report the results, before advising readers to adopt methods which have been tried and failed.'

I will take No. 3 first. I am not aware that I have in either of my letters advised feeding

bees in winter either with syrup or candy; my letters were intended for the consideration of the many bee-keepers who do feed in winter. What I do advise is that bees should not be robbed of their stores in the body of the hive, and that all late swarms, &c., not having sufficient stores by the middle of September, should be fed up with strong syrup, all feeding being finished before the end of the month, the hive being then packed with quilts, &c., to prevent the warm air escaping from the cluster; and, if possible, a free air-space round the hive, with plenty of ventilation below, and the bees left in this condition till the crocuses are out in the spring, when the bees may be fed with stimulating syrup, not by cutting a hole in the quilt and placing an inverted bottle of syrup over, but placing the bottle at the side of the cluster, as in the 'English' hive. So much for what I advise. As to feeding my own bees in winter-time, as you suggest, *after* Christmas was what I said; and, if my bees required it, I should not have the slightest hesitation in doing so. I once knew of a bee-keeper at Ealing, who told me he averaged from forty to sixty pounds of section honey per hive, who attributed his success to the fact of his feeding his bees with syrup immediately after Christmas; besides which skeppists always have fed their bees with syrup in winter, and if it is injurious, I can't help thinking they would have found it out long before this. For my own part I am quite convinced that what, in this case, kills the bees is the dampness arising from unsealed cells of liquid food obtained by them in the late autumn.

As regards No. 2, I fully agree with this remark. Whenever I see an inverted bottle or feeder left over from the autumn, I suspect the bees to be dead, and I am not often wrong.

As to No. 1, I think your surmise correct. I have noticed, through the *Journal* especially, that, fortunately for appliance-makers, bee-keepers are very prone to follow new departures, but loath to believe in ancient customs. I suffered from the same complaint myself, and am not sure I am quite cured of it yet.—A. T. WILMOT, *St. Albans.*

[Had the above communication been received in the first instance, no caution would have been necessary.—EDS.]

HOME-MADE APPLIANCES.

[842.] Referring to your editorial on 'Home-made Appliances' (No. 485), I certainly think this should form a feature of the *B.B.J.* I am not a bee-keeper, but I am going to be, and it may be interesting to know that this determination has been brought about simply by perusing a series of articles running through *Work* (a penny weekly paper published by Cassell & Co.) on 'Hive and Appliance-making.' My interest in the subject having been awakened, I became

a subscriber to the *B.B.J.*, and have purchased a fair amount of literature on the subject, and now fancy I know a little at any rate of the theoretical, if not the practical, part of the subject, which latter part I hope to acquire later on. I am fond of wood-working, and a regular stickler for having things about right, so intend to make most of the requisite appliances, and if I can't turn out neater and better-finished articles than some I have seen exhibited, I'll eat 'em, Mr. Editor. I cannot yet decide which is the better form of hive, the long hive or the square hive arranged for tiering. Can you refer me to any back number where the subject is ventilated; also as to relative advantages of the 'standard' or 'shallow' frame for extracting?

Just a word on exhibition matters. I certainly think that if twelve jars of honey are dispatched to a show, and one gets accidentally smashed, the remaining eleven should be judged as a whole exhibit. I would strictly debar any honey being shown unless it was produced in the exhibitor's apiary; but I cannot follow Mr. Grimshaw, who would prohibit first-prize honey from being again exhibited. I look forward every week for my *Journal*, and hope by its help to swell the ranks of British bee-keepers, and to be able a year hence to render a good account of my first season.—NOVICE, *South Norwood*.

[The merits of various types or forms of hives are so constantly being ventilated in our columns that we cannot well refer you to special numbers for information. Besides, a beginner who has not yet kept bees would find some difficulty in arriving at a correct conclusion from his reading. Try a hive of each type, and select the one you like best after using. The shallow-frame, however, is generally approved for surplus storing.—Eds.]

VASELINE FOR STOPPING ROBBING.

[843.] You will, no doubt, remember that on p. 467 I promised to give some further account of an upset among my bees in consequence of an attack by robbers through the careless replacing of a hive roof. The robber-bees got into the super in hundreds, and, after the roof had been set right, they crowded about every joint and crevice of the neighbouring hives as well as the one in question. So I got my smoker in play, and as the bees were smoked off I painted the joints with vaseline. To my great relief I found this stopped the robbing, for not a bee would come within an inch of where the vaseline was. To make doubly sure, I also painted around the entrances, being careful, of course, to keep it off the alighting-board. By this time the prisoners in the hive roof were trying to escape by the cones, as I had stopped the entrances to the latter while applying the vaseline; so, before I released them I painted round the base of each cone the same way, and this effectually stopped the attack in that quarter, for in less than an hour all were working as usual. Not a bee was killed, not a sting inflicted, and peace was restored.

Another 'dodge' I have found effectual is this: On the morning of the day on which you are going to take honey, put a couple of pieces of naphthaline at the ends of frames, next the sides, and it will stop any stranger bees from entering the hive by the usual entrance.

I am so much indebted to what has appeared in your pages for my little knowledge about bees that I shall be glad if any reader is, in return, assisted in his trouble by what I have written above.—T. H. C.

BEE-KEEPING IN SOUTH AUSTRALIA.

[844.] The following extract from a recent letter, written at Mount Barker, South Australia, by Alfred Wright, a minister of the Society of Friends in England, may be of interest to the readers of the *B. B. J.*:—

'F. Coleman has an apiary here of 160 hives of bees, many of which are Ligurians. The wooden hives are made in New Zealand, and cost about 10s. each. They have two compartments, a top and a bottom one, the bees breeding below, while they store the honey in the top one. The apiarists here manufacture the foundation for the comb themselves, and I was shown the process the other day.' (Here follows a description of the process, which it is needless to give.) 'The honey is chiefly gathered from the gum-trees, and, as these flower only alternate years, they have a good season and a poor one. The season lasts two months, and when the weather is hot the quantity of honey gathered in one day is enormous, for the flowers are so full of it that it may be shaken out. Our friend had one hive from which he took 450 pounds in one season, which said hive, when weighed two days in succession, had increased in weight eleven pounds in the twenty-four hours. The frames are taken out twice a week in the busiest part of the season, put into an extractor, emptied of their contents, and the comb returned to the hive to be refilled, and this goes on through the summer. The honey thus obtained is very pure and good, and fetches, on an average, in London, 3d. per pound. It is sent to England in tins containing fifty-six pounds each. One season recently our friend obtained twenty tons from 200 hives, which, at 28l. per ton, was not such a bad result. At any rate, it seems better than farming here. I understand that since eucalyptus oil has been thought so much of as a medicine, honey made from the gum-tree is supposed to have some special virtue in cases of sore throat, &c., and is being largely used for that purpose. A chemist in London is a large customer for our friend's honey for this object.'

The writer is on a religious mission to the Friends in Australia, and is well known in Yorkshire, his native county.—W. B., *Lowestoft*, November 3rd, 1891.

HOME-MADE RAPID FEEDERS.

[845.] I make my own feeders, and have two kinds at work. A description of the following one, which is the cheapest and simplest of the two, may be of some little value to your readers. If so, please insert it. The feeder consists of a

box, $\frac{1}{2}$ -inch board, $9\frac{1}{2}$ inches square, and 6 inches deep inside, covered with a square of glass. In the bottom, near one side, is a hole about 2 inches in diameter, with a slide, 3 inches wide, to cover it underneath. A four-pound golden syrup tin, such as used by Messrs. Lyles, is pierced round the top by a bradawl, and stands in a tin saucer, $\frac{1}{2}$ inch deep. The feed-hole is cut $1\frac{1}{2}$ inch wide, long enough to expose three or four frames through the several thicknesses of covering, and the box is placed thereon. Nearly fill the tin, replace its cover, put the saucer on the top, hold both firmly, and quickly invert. Then stand it inside the box, and put on the glass to cover it. Now withdraw the slide sufficiently from the hole, and the bees will very soon enter and cluster on the edge of the saucer. Cover all up warmly.

It is claimed to be cheap, safe, clean, and more readily manipulated than the bottle, which is discarded, and can either be used for syrup or candy feeding, with the advantage of the owner being able to see the bees, and easily ascertaining the consumption of food with a minimum loss of heat. To remove, push the slide in when box is empty of bees, or nearly so; take off the glass, and give a fresh supply when needed, and the box can remain in position without injury for any length of time. If it be desired to give a larger quantity of syrup than the four-pound tin, it can be easily done by making the box to suit.—*J. Q., Tenby.*

CLEANING OUT SHALLOW FRAMES.

[846.] The following is a very simple solution of what has been a difficulty to me, and may also have been one to others. It may not be anything new, but I have never seen it mentioned before. When leaving shallow frames with a certain amount of honey in them, to be fed down, I often find the bees are inclined to cluster on the frames and remain there. By lifting the shallow-frame crate, and putting a quilt with a feeding hole in it, between the body-box and the crate, the bees at once feed down all there is in the crate. Of course I have a quilt on the top of the crate as well, to keep the bees from getting into the roof.—*O., Bury St. Edmunds.*

LATE DRONES.

[847.] In answer to your correspondent (828, p. 492), I once (many years ago) had a straw skep (before frame hives had become general) that had live drones in it all winter. I could not discover the cause, and naturally thought the stock was queenless: but such was not the case, as it was one of the earliest to swarm the following year: but, strange to relate, however, early in May (during a spell of cold weather) the bees turned many of the drones out.

Where foul brood is in the neighbourhood, I beg to suggest that, as naphthaline evaporates rather quickly, it could be blown in at the entrance with a piece of elder occasionally during

winter, without the necessity arising for any disturbance of the bees.—*ALPHA, Stamford.*

NOTES FROM MY DIARY.

[848.] Thinking that possibly the following may be of interest and use to some of your readers, I venture to give you a few extracts from my diary since my start as a bee-keeper.

April 25th, 1890.—Bought one hive and bees for 30s.

April 26th.—Began stimulative feeding, two holes.

June 7th.—Super put on. Twelve frames in body-box.

June 23rd.—Bees entered super.

July 20th.—Completed sections.

August 7th.—Super removed. Total honey return, thirteen sections, and fourteen and a half pounds of run honey.

August 10th.—Began feeding up, two holes.

September 16th.—Drove two stocks of bees from skeps for cottagers, and united in a new frame hive. Started feeding, all holes.

October 6th.—Finished feeding. Estimated food in hives as follows:—No. 1 (old), sealed, 16 pounds; unsealed, 10 pounds; total, 26 pounds. No. 2 (new), sealed, $12\frac{1}{2}$ pounds; unsealed, $7\frac{1}{2}$ pounds; total, 20 pounds. Bought skep, bees, and stand from a neighbour; weight of skep, bees, and comb, twenty pounds.

October 15th.—Packed up for winter.

December 4th.—Gave one cake of soft candy to each stock.

January 25th, 1891.—Bees took cleansing flight, after being confined for eight weeks of hard frost.

February 1st.—One pound of candy given to Nos. 1 and 2.

February 15th.—First spring examination. No. 1 stock, bees on five frames, brood in three frames; plenty of stores on all the frames. No. 2 hive, bees on four and a half frames, brood on two frames; stores, plenty.

April 1st.—Started to feed skep with syrup. Second examination of stocks. No. 1, bees on five frames; little brood; stores, plenty; contracted hive to six frames. No. 2, bees on three and a half frames; contracted to five frames; a little brood.

April 12th.—Started to feed frame hives.

April 25th.—Third examination of stocks. No. 1, bees on six frames (strong); great deal of brood on four frames; added two frames. No. 2, very weak; bees on two frames; little brood; skep seems very weak.

May 1st.—Commenced to strengthen No. 2 hive by taking one frame of brood from No. 1 hive, and exchanging it for one without brood from No. 2, repeating this every five or six days. Very wet weather up to the present. Sycamores just coming into bloom.

June 3rd.—Drones flying from No. 1 hive.

June 11th.—Supers put on.

June 18th.—Bees enter No. 1 hive super.

June 20th.—Bees enter No. 2 hive super.

July 2nd.—Bees enter bell-glass on skep.

July 3rd.—Bees in No. 1 hive swarmed. Hived in skep, but about an hour afterwards they came out again and were lost.

July 6th.—Cut out queen-cells in No. 2 hive, and put extra sectional super on.

July 10th.—No. 2 swarmed. Returned bees. Mr. K. gave me a swarm which had taken possession of an empty hive in his apiary in place of the one I had lost on the 3rd. Put these in No. 3 hive on eleven frames, with queen-excluder behind eighth frame.

July 12th.—No. 1 hive threw a cast; returned. Took completed sections from No. 2.

July 13th.—Skep swarmed. Hived in No. 4 on eight frames.

July 19th.—Limes just coming into blossom.

July 25th.—Skep threw off a cast; hived, but it returned to the old stock after about an hour.

August 9th.—Supers taken off.

August 16th.—Finished extracting.

August 20th.—Started feeding (all holes). Note on the season: Very well to end of May; fair to middle of June; good up to July 22nd; wet afterward, and all the time the limes were in bloom.

September 3rd.—Total honey return:—

No. 1,	25 sections,	11½ run,	total,	36½ lbs.
" 2	0	" 37	" "	37 "
" 3	4	" 12½	" "	16½ "
" 4	0	" 1	" "	1 "
Skep	0	" 0	" "	0 "

91 lbs.

October 9th.—Introduced queen to No. 1 hive, which was queenless.

October 12th.—Finished feeding. Food in hives as follows:—

	Frames of Bees.	Sealed.	Unsealed.	Total.
No. 1	6½	7
" 2	3½	10
" 3	5	20
" 4	6½	8
				3 lbs. of candy.

Skep, strong: plenty of stores.

October 18th.—Packed for winter. Profit for 1890, 11. 13s. 6d.; ditto for 1891, 3l. 17s. 8d.—J. G., *Shifnal, Salop.*

[Many readers will no doubt be curious to know how the 'profits' are arrived at, as it is not quite apparent on the surface.—Eds.]

Queries and Replies.

[453.] *Mead Making and Wax Extracting.*—I have about thirty pounds weight of drained virgin comb. (1) Will you oblige by giving recipe for making mead, and (2) for extracting wax? I have only known of the *B.B.J.* since January of this year, and have not seen any recipe in it since.—H. MASTERS.

REPLY.—1. Recipes for mead-making have

often appeared in our pages. Here is an old one:—'*Strong Mead.*—Take a quart of honey to three of water, and lett them boyle an houre. In the meantime, when it's begun to boyle, take ye white of an egg and beat it very well with a pint more of water, and put it in; then scum it very well; this will help to make it clear; then if it be not very clear, put it through a clean flannin into a clean cask and clay it up very close, letting it stand half a year. Then bottle it, and let it stand half a year before you use it.' (The claying-up was the plastering of stiff clay round the bung, to ensure the perfect exclusion of air.) 2. The best implement to use is the Gerster wax-extractor, which may be had from any appliance dealer; or the combs may be set in a sieve over a vessel containing water, and placed in a warm oven till the wax falls through into the water beneath, the cake of wax being removed when cold.

[454.] *Fuel for Smoker.*—At the *conversazione* of the B.B.K.A. a new smoker (Hill's) was exhibited. I should be glad if you can say whether this pattern will obviate the generation of the objectionable black fluid, so generally complained of in the Bingham and other smokers, for no smoker can be considered perfect having this serious fault. I do not recollect that this question was asked at the meeting, and it only occurred to me afterwards.—J. H. NEW, *Watford.*

REPLY.—As wood is the fuel recommended for use in the 'Hill' smoker, the fault you complain of is practically overcome.

GLEANINGS.

'SMACKING.'—I witnessed a curious business at a flower show, where the judges were busy with the honey. They were sticking their pocket pencils in rapid succession into the honey jars, and swallowing the samples thus abstracted, while they gazed dreamily towards the ceiling. As they swallowed the nectar, they smacked their lips with a crackling sense of gastric enjoyment. A bystander asked one of the judges 'what all the smacking meant.' 'The smacking, sir,' said the judge, as he shot a glance of pity at the ignoramus, 'is meant to drive the flavour into the palate!'

The result of the honey competition at Castle Douglas show is, that Mr. McNally, of Ireland, who challenged creation last year, and was beaten by Dalbeattie, has triumphed over the Scot and the Saxon. Galloway, with the nectar of Borgue, takes a back seat, and the galling thing is that she was even beaten by Dumfriesshire for second place! There is nothing left for the Galloway bee-keepers now but—to abuse the judges.

One thing is very evident—Borgue, as 'Borgue,' is nowhere. There were many lots

of Borgue honey shown, but none of it got into the prize list. The fact that an Annan competitor was second for extracted honey reminds me of a skipper coasting between Annan and Liverpool, who used to buy up every ounce of honey he could get near Annan, and sell it in Liverpool at a big price for the 'finest Borgue honey.' His customers were deceived in nothing but its source of origin, for they got much better honey than Borgue could produce.—*Dumfries Courier*.

TIPPLING BEES AS BURGLARS — WHAT NEXT?—It appears that the monarchies of bees, well governed as they seem to be, are afflicted, nevertheless, by organized criminal classes—sneak-thieves and highway robbers. Some of these robber-bees go in strong bands to pillage, and are able to storm and sack a hive. After the slaughter they carry all the provisions home. Some colonies of bees never work; they live entirely by robbery and murder. There are also thieves who creep unperceived into strange hives to steal honey. If successful, they return afterwards with hordes of burglar bees, break open the honey-safes, and carry away the contents. But the most curious fact is that these bees can be artificially produced, according to Buchner, by feeding the larvæ upon honey mixed with brandy. In the words of the naturalist himself, 'Just as man does, the bees become victims of their love of this beverage, which exercises the same pernicious influence upon them as upon us; they become excited, drunk, and cease to work. When hunger comes upon them they fall, like man, from one vice to another, and finally give themselves up without scruple to robbery, pillage, and violence.'—*Tit Bits*.

ARE WE DRIFTING FROM OUR MOORINGS?

I have read with interest what has been said during the present summer about hives and their manipulation, as against the manipulation of frames, as has been the custom of the past; and, unless I am greatly mistaken, there is *not* in this idea all the pecuniary benefit to the bee-keeper that a superficial view of the matter would lead to expect. The idea embodies in all of its bearings, unless I am blind in this matter, two things which would be an expensive luxury to the one who adopts this idea of 'handling hives instead of frames;' and these two things are, first, a radical change in most of the hives now in use; and, second, the placing of a greater number of colonies in the field, both of which are against us—the latter for all time, and the former for the near future.

This changing of hives and fixtures to the extent to which it has been carried in the past has been somewhat against us, and the outlook for the future shows no sign of improvement. The changing of hives and fixtures in an apiary that numbers fifty means quite an expense—an

expense that will take many *good* years of production to pay, over and above what might have been secured with the old fixtures, even should the new prove better than the old.

Not long ago a 'new' hive came out, the claim for which was that it would cheapen honey production; for surely the producer must produce his crop at a less expense than he was now doing if he was to be enabled to keep his head above water in these times of low prices. Have we seen these great things accomplished? Let friend Gravenhorst answer: 'I found out something by this new method that did not satisfy me in contrast with the old one. In the course of several years I always got more honey and wax in the old-fashioned way.' While friend G. was not speaking of this particular hive as 'the new method,' yet he but voices what many others have found out.

To illustrate more fully just what I mean I will let the reader into a little bit of my past history, together with that of another, whose name I will not mention. When I first began keeping bees it was with the express understanding that, after the first outlay (\$35) on them, not another cent should be paid out unless they brought it in, and that I would not pay out for new fixtures a cent of what they brought in unless I could see that some pecuniary benefit was coming back in the near future to more than balance what I would pay out, and that I would use up, as far as might be, all of the old, without throwing away that which had cost me cash.

This understanding has been carried out all of these years; and to-day, instead of having only \$500 as my worldly possessions, as I had in the spring of 1869, and living in a tenant house, with my small apiary on somebody's possessions besides my own, I have a comfortable home, consisting of thirty acres of land and the necessary buildings; have enough laid aside to carry me and mine through life, unless something extraordinary should happen to us, besides being enabled of late years to do something to advance the Master's interests in the world, and that which tends to uplift humanity; all having come from the bees over and above what I have paid out for them, and I still use the same old Gallup hive with which I started, and see no reason for desiring a change.

In 1869, the 'another' before spoken of counted his worldly possessions far above mine, produced much more honey each year than I did, as a rule obtained better prices, but laid out each year all or more than what the bees produced in 'something new,' throwing away that of the past which did not suit, and purchasing new again; till a short time ago found him borrowing money that he might still purchase something new in the 'bee-line,' while there were waggon-loads of stuff, representing thousands of dollars, to be found strewn about the premises, that had accumulated by this great desire to keep 'abreast of the times,' and 'secure the greatest amount of income with the least capital and labour.'

Now, do not understand me as 'butting' against improvements, for no one rejoices more over real improvements than I do; but if I am to rejoice, the thing offered must be an improvement when viewed from all of its many sides. Talk about handling hives instead of frames! The old hives, as given us by Father Langstroth, with a movable bottom-board and no portico, can be handled just as you please after the bees have been in it (on this plan) one year; and yet how many of the bee-periodicals of to-day are recommending it as *the hive*?

To be of real value, unless a radical change is necessary, it is better to tell us how to secure the same results with what we now have rather than advise something new to secure these same results. The 'stone that keeps rolling gathers no moss.'—G. M. DOOLITTLE, in '*Gleanings*.'

SHAKESPEARE ON BEES.

(Continued from p. 507.)

When Romeo is awaiting the arrival of Juliet, Friar Laurence, in his cell, endeavours to solace him in the following words:—

'These violent delights have violent ends;'
adding:—

'The sweetest honey
Is loathsome in his own deliciousness,
And in the taste confounds the appetite;
Therefore, love moderately.'

Act II., Scene 6.

In *Henry VIII.* Norfolk says, in speaking of Cardinal Wolsey:—

'The King hath found
Matter against him that for ever mars
The honey of his language.'

Act III., Scene 2.

In *Hamlet* we find Ophelia deploring her condition after the remark 'To a nunnery go' in these words:—

'And I, of ladies most deject and wretched,
That suck'd the honey of his music vows.'

Act III., Scene 1.

The same word is also employed by Romeo:—

'Oh, my love! my wife!
'Death that hath suck'd the honey of thy
breath,
Hath had no power yet upon thy beauty.'

Act V., Scene 3.

When we bear in mind the regularity of combs and the close arrangement of the cells, the words of Prospero, in his reply to Caliban, will be better understood:—

'Thou shalt be pinch'd
As thick as honey-combs, each pinch more
stinging
Than bees that made them.'

Tempest, Act I., Scene 2.

The sting is above alluded to, and also occurs in the following:—

'Full merrily the humble-bee doth sing,
Till he hath lost his honey and his sting:

And being once subdued in armed tail,
Sweet honey and sweet notes together fail.'
Troilus and Cressida, Act V., Scene 11.

This passage would lead us to infer that Shakespeare knew that bees could not withdraw their stings from the wound.

In *Julius Cæsar* we find the following dialogue:—

'Cas. The posture of your blows are yet unknown;

But for your words, they rob the Ilybla bees,
And leave them honeyless.

Ant. Not stingless too.

Bru. Oh, yes, and soundless too:

For you have stol'n their buzzing, Antony,
And, very wisely, threat before you sting.'

Act V., Scene 1.

The loss of the queen is thus described:—

'The commons, like a hive of angry bees,
That want their leader, scatter up and down.'
Second Part of Henry VI., Act III., Scene 2.

He did not seem to know the use of drones, for he says:—

'Drones suck not eagles' blood, but rob bee-hives.'

Second Part of Henry VI., Act IV., Scene 1.

(To be continued.)

Notices to Correspondents and Inquirers.

Letters or queries asking for addresses of manufacturers or correspondents, or where appliances can be purchased, or replies giving such information, can only be inserted as advertisements. The space devoted to letters, queries, and replies, is meant for the general good of bee-keepers, and not for advertisements. We wish our Correspondents to bear in mind that, as it is necessary for us to go to press in advance of the date of issue, queries cannot always be replied to in the issue immediately following the receipt of their communication.

All queries forwarded will be attended to, and those only of personal interest will be answered in this column.

R. W. (Watford)—*Flour Candy in Winter*.—We think the sugar sent is pure cane. Candy is altogether too hard; besides, pea-flour should never be used in making soft candy for winter food. It is only good for spring use when breeding is being fostered.

A. J. BROWN (Wotton-under-Edge).—Your note dated 3rd inst. could, of course, only reach us on the 4th, too late to be of any service.

SWINDON.—*Late Syrup Feeding*.—It is now past the time for syrup feeding. Soft candy is the proper food to give at this season.

J. McAUSTEN (Renton, N.B.).—We know of no bee-keeper in this country who uses the Gravenhorst hive. Thanks for cutting sent, but it would serve no useful purpose to publish the good qualities of artificial honey.

G. E. BOLTON (Saltaire).—1. *Moving Bees*.—Defer the removal till we have had a spell of cold weather during which the bees have not flown. 2. Syrup-feeding should cease before now. If food is short, give soft candy above the top bars.

Special Prepaid Advertisements.

Situations, Publications, Bee Plants, &c.—Twelve words and under, Sixpence; for every additional Three words, One Penny.

Trade Advertisements not inserted under this head.

WALLFLOWERS.— Fifty Plants, 1s. free. Arabis, 1s. per dozen. Address **NORMAN PARKIN**, Blakenhall, Wolverhampton. L 51

BEE SMOKE!!—No. 1 P. C. Cartridges, 3s. 6d. per gross; half-gross, 2s. No. 2 ditto, 5s. per gross; half-gross, 2s. 9d. If fitted up with Cotton Wicks add 6d. per gross extra. Samples free 4d. stamps. Orders over 20s. Carriage paid. Address **THOMPSON & NORRIS**, Manufacturing Co. Limited, 37 and 39 Britannia Row, Essex Road, London, N. L 74

LIMNANTHES DOUGLASSII.—Bees delight to work it all weathers. Abundant bloomers. 125 Plants 1s. 3d., carriage paid. Cash with order. Address **J. BENNETT**, 178 Spon Street, Coventry. L 77

WANTED.—Extracted Honey (Granulated) in bulk. Address **W. RUSHTON**, Bee Farm, Bedford.

SEMI-GOLDEN ARABIS.—Splendid Bee-plant, and beautiful for Bordering Flower Beds or Rockery. Twenty-four Cuttings, 1s. free. Cuttings root readily. Address **Rev. R. SMYTH**, Castlepollard, Westmeath. L 73

WANTED.—Wholesale Price Lists of Bee Appliances. Address **LEVI BEVAN**, Govilon, Abergavenny, Mon. L 80

HONEY WANTED.—Bulk. State lowest price. Address **W. GRIFFIN**, 251 Oxford Road, Reading. L 81

THE 'GARSTANG' HONEY PRESS.

(As published in British Bee Journal for Sept. 10.)

Inside Plates either Wood or Iron. Prices on application. 3282 Address **ROBERT BARTON**, Garstang, Lancashire.

NEW EDITION NOW READY.

21st Thousand.

THE BRITISH BEE-KEEPER'S GUIDE-BOOK.

By **THOS. WM. COWAN**, F.L.S., F.G.S., &c.

Revised and enlarged.

Almost entirely re-written. Much new matter and many fresh illustrations added.

Fcap. 8vo., price 1s. 6d.; or in cloth gilt, 2s. 6d. Postage, 2d.

To be had of **HOULSTON & SONS**, Paternoster Sq.; all Hive Dealers, Secretaries of Bee-keepers' Associations, and of **J. HUCKLE**, *British Bee Journal* Office, Kings Langley, Herts.

BRITISH BEE-KEEPERS' PRACTICAL NOTE-BOOK.

With Rules for the General Management of Movable Comb Hives.

By **THOS. W. COWAN**, F.G.S., &c., Editor *British Bee Journal*.

Consists of a Series of Tables by means of which the Bee-keeper can keep a record of all his Observations and Operations. A Pocket-companion indispensable to the practical Bee-keeper.

Price 1s., postage 1d.

Bee Journal Office, Kings Langley, Herts; and 17 King William Street, Strand, W.C.

BALDWIN'S is the Oldest Establishment in the United Kingdom wholly devoted to Bees and manufacture of

Bee-keepers' supplies. His prices will compare most favourably with those of any other Maker, while for quality of material, suitability and workmanship, he has no rival.

'Why can he give better value for money than others?' Because he spends less in large 'puffing' advertisements, buys in the best markets for prompt cash, has no rent to pay, and personally conducts his own business.

For prices and full particulars of Goods see Baldwin's Bee-keepers' Instructor (and Illustrated Catalogue combined), which contains more practical and reliable hints than all the large, expensive books; post free for 2d. stamps. Address **S. J. BALDWIN** The Apiary, Bromley, Kent.

N.B.—More than 500 Silver and Bronze Medals, First and other Prizes, and Testimonials innumerable.

THE 'ENGLISH' HIVE.

Transferring Season now on.

TRY THIS HIVE, it is the best in use, and once used will be always used. No more cutting Quilts necessary, as the Bees can be fed from the side of the Hive. See description in *B. B. J.*, August 6th, 1891, p. 351. Price for Floor-board, Body, and Zinc-covered Roof, 11/6 only. The English Wax Extractor, price 7/6.

For particulars apply to **A. T. WILMOT**, St. Albans. 3149

British Bee Journal and Bee-keepers' Record.

OFFICE:

17 KING WILLIAM STREET, STRAND, LONDON, W.C

PURE CANE SUGARS.

For the accommodation of Bee-keepers, guaranteed Pure Cane Sugar will be supplied in large or small quantities through this office at the under-mentioned rates:—

MOIST. (For Household Use.)

Neat bags, 14-lbs. 28-lbs. 56-lbs. Cwts.

3. MUSCOVADO 2/7 5/2 10/- 19/6

CRYSTALLISED.

4. DEMERARA } Crystals 2/9 5/4 10/6 20/3
5. BARBADOS }
6. TRINIDAD }

REFINED CANE.

7. WHITE CRYSTALS (Small) 3/0 5/10 11/6 22/3
8, 9. (Medium and Large sizes, 1/- per Cwt. extra.)
10. LUMP (Cut Loaf) ... Boxes, 3/3 6/3 12/3 23/6
11. LUMP DUST 3/ 6/- 11/9 22/9
12. PRESERVING 3/- 6/- 11/9 22/9

FINE. (For Household Use.)

13. GRANULATED 3/3 6/3 12/3 23/9
14. CASTOR Coarse (15 Fine) 3/9 7/3 14/3 27/9
15. ICING.. 4/3 8/3 15/9 31/-

All above guaranteed made from CANE SUGAR only, and free from BEET, CHEMICALS, etc., etc.

CARRIAGE PAID on Orders over 5/0 (or 28-lbs. Sugar) to London and Suburbs.

COUNTRY ORDERS, not less than 2-cwt. carriage paid at 1/0 per cwt. extra.

(Scotch and Irish orders, special arrangements.)

CHEQUES payable to **J. HUCKLE**, Kings Langley.

Cash to be sent with order, and purchasers will please observe that if samples are required or replies asked to inquiries, a stamped addressed envelope must be sent, as we cannot undertake cost of postage.

THE

British Bee Journal,

BEE-KEEPERS' RECORD AND ADVISER.

No. 491. Vol. XIX. N. S. 99.]

NOVEMBER 19, 1891.

[Published Weekly.

Editorial, Notices, &c.

FOUL-BROOD LEGISLATION.

It will have been observed by those who read the report of the proceedings at the meeting of the Committee of the British Bee-keepers' Association, which appeared in our issue of October 29th, that the Secretary was instructed to point out to secretaries of affiliated Associations the importance of acquiring statistics relative to the prevalence of foul brood in their respective counties. The object of these inquiries was to obtain information for the purpose of bringing certain facts before the Minister of Agriculture, and in this connexion an endeavour is also to be made to induce Mr. Chaplin to consider the advisability of including bee-keeping in the usual agricultural returns obtained through government channels.

After all we have written on the subject of foul brood, together with the very exceptional and exclusive sources of information open to us, it will be readily seen that we, at least, can both understand and appreciate the gravity of the situation as well as the necessity which exists for promptly dealing with it. We are pleased to record the fact that correspondents write freely of their foul-brood troubles to this office—very much as patients confide in their doctors—who might hesitate to do so were it not known that confidential communications are respected. But it proves that there is need for an effort, such as is above referred to, when reports are received from secretaries of Associations conveying the assurance that foul brood is practically unknown in counties, while we have in our possession reliable information to the contrary.

That there exists a somewhat general disinclination among bee-keepers to spread the news of an outbreak of disease in their apiaries cannot be denied, and we, as Editors, shall continue to regard as private

and confidential all information sent to us on the subject, unless otherwise desired. We may, however, none the less urgently advise members of County Associations to consider the importance of supplying such information as is asked for, in order that judicious and effective measures may be taken for eradicating the pest. Not a small portion of the difficulty in 'getting at' cases of foul brood no doubt arises from the apathy—or worse—of bee-keepers who belong to no Association, and who rather discountenance than otherwise any effort to encourage the spread of bee-keeping in their midst, because of a rather selfish objection to 'bringing down prices,' &c. But there is also another class of whom—without attributing any intentionally unworthy motive—it may be said they constitute a serious stumbling-block in the way of progress. We refer to those who, while electing to hold aloof from taking any share in the public work of advancing the cause of bee-keeping, do not hesitate to criticise, in a by no means friendly spirit, the efforts and actions of those who have no personal object to serve, and who give both time and means for the sole purpose of benefiting bee-keeping and bee-keepers.

These remarks are made mainly in consequence of a communication just received from a correspondent, headed 'Observations by an Outsider,' which reads as follows:—

'I have been a keeper of bees for some years, and although I take much interest in the art of bee-keeping, it has been of a private character, nevertheless I have not been unmindful or indifferent to what has been going on in the bee-keeping world generally. It appears to me that the authorities on matters connected with bee-keeping in London (*i.e.*, the British Bee-keepers' Association) are by degrees acquiring an exaggerated estimate of their own importance, and are endeavouring to arrogate to themselves powers stronger than the moral influence they have hitherto made use of with so much success. It may be that I am drawing false inferences, but, if so, I am at a loss to understand why foul-brood statistics are to be brought to the notice

of the Minister of Agriculture, except some very decisive steps for its extirpation are contemplated, and there is other collateral evidence in support of that conclusion.

‘Conceding the foul-brood disease to be widespread and of a contagious and destructive character, it were well to stamp it out, but it appears to me certain that excess of zeal in the exercise of repressive measures will be a blow to British bee-keeping. It may be assumed that most bee-keepers in Britain keep bees more for the pleasure of the thing than with a view to big returns in a commercial sense, and if this be true it is hardly likely they will continue to keep bees under the conditions to be imposed on them. Making reports, official inspection, summary notice to destroy and disinfect, would be well enough supposing British bee-keeping sufficiently flourishing to stand the strain; but I fear it will not, for many would prefer to be without bees if they felt they were liable at any time to outside interference, official or otherwise. Cottagers and agricultural labourers—those it is assumed bee-keeping will mostly benefit—are the very people to view measures of this kind unfavourably. It is not easy to induce or, I might say, coax them to adopt modern methods of bee-keeping as the case now stands; much more difficult will it be if you require them to make reports and submit every now and again to an upset in their apiaries caused by an inquisitorial inspector armed with extraordinary powers.

‘May I ask is this foul-brood disease so wide spread as to require so much thought and attention? I do not for a moment doubt the truthfulness of the reports that appear in the *B. B. J.*, but during the last thirteen years I have not seen a single case, though I have handled a great many hives in that time. This suggests another question: Would this ignorance on my part disqualify me supposing I were to sit for examination under the new conditions for obtaining expert certificates? An answer to this question may be of more interest to others than to myself, for I fail to see any real value in the certificates. My bees would profit nothing, and as to advising other bee-keepers, I am always ready to do what I can for friends and neighbours when they ask it, but should they elect the certificated man that is of no consequence to me.

‘As far as my observations go in the neighbourhood where I live bee-keeping is not so much in vogue as it was a few years ago. Bad seasons may have something to do with this decline, but I imagine people are not all born bee-keepers, and soon tire of their bees. Perhaps, however, the County Council’s lecturers will “boom” it again, but I fail to see how a small expenditure in lecturing will teach a whole county the art of bee-keeping.—Yours faithfully, A. D.’

Our correspondent having freely given expression to his views, we offer no apology for saying a word on the other side. In

the first place, then, our friend ‘A. D.’ may take it from us that he is certainly ‘drawing false inferences,’ to use his own expression, when imputing to the B. B. K. A. any other motive than a desire to help on and foster the successful cultivation of bees in this country. Moreover, we venture to say that if gentlemen disposed to write thus would relinquish their ‘private capacity’ as critics and join the ranks of the workers, their assistance would be welcomed and their suggestions carefully considered. Meanwhile, we are justified in asking that those who choose to occupy the position of ‘Outsiders’ should not, without substantial cause (or upon imperfect knowledge of the facts), do anything tending to depreciate the efforts of those who labour from the *inside* of the organization. ‘A. D.’ asks ‘why foul-brood statistics are to be brought to the notice of the Minister of Agriculture?’ Surely it is patent to any one that definite action on the part of the authorities will never be taken unless it is proved by statistics that good and sufficient grounds exist for such action.

That ‘some very decisive steps for the extirpation of foul brood are contemplated’ our correspondent may rest assured; and he betrays a woeful unconsciousness of what is going on around him in supposing that there is not abundant evidence of the pressing need for something being done, and at once. Why, we happen to know that in his own county there are districts—only a year or two ago noted for the quantity and high quality of the honey produced therein—where bee-keeping is almost given up because of its being next to impossible to keep stocks free from foul brood! Moreover, the difficulty is supposed to arise mainly because of the immunity from outside interference enjoyed by persons who refuse to destroy stocks known to be diseased. Surely this is ‘collateral evidence’ sufficiently strong ‘in support of our conclusion.’

Again, we entirely refuse to believe that ‘the exercise of repressive measures will be a blow to British bee-keeping.’ It may—and we earnestly trust it will—be a blow to that sort of bee-keeping which is productive of little beyond disappointment and failure; but to the class of bee-men whose numbers we are desirous of increasing it will tend to bring a sense of relief and security hitherto lacking. We fail to see why loss or damage should be inflicted upon a whole neighbourhood because a careless, or negligent, or

malicious individual refuses to destroy a hive which is a standing source of infection to all the bees kept in the locality.

Does any sane man imagine that contagious diseases among animals could be kept under control if it were not for the Act of Parliament which enforces certain regulations in dealing with infected stock? And the argument applies with double force to bee-keeping, seeing that *our* stock is entirely beyond control, in so far as preventing bees from robbing foul-broody colonies located near. Besides, what hardship can there be in the visit of a competent person to an apiary suspected of being infected? It will surprise us if the interference is not welcomed when it comes from an authoritative and reliable source.

Our correspondent closes his communication with a query, and a gratuitous and rather unkindly 'fling' at the value of experts' certificates. To the first we reply by assuring him that the extent to which the disease has spread is in no way exaggerated. His second question and the remarks immediately preceding it suggest to us the not unfair inference that an examination on the subject of foul brood would be of considerable advantage to him—as a bee-keeper, of course; for we are perforce driven to the conclusion that one who has during the last thirteen years handled a great many hives without seeing a 'single case' in the county from which A. D. hails, may unfortunately possess so limited an experience of the disease as to be unable to tell when he sees it. If this be so it may account for the 'observation' as to bee-keeping being less in vogue in his neighbourhood than it was a few years ago; and certainly whatever value may be attached to the advice he is good enough to offer to such bee-keepers as seek his assistance, our correspondent cannot, even on his own showing, claim to be able to render much help in cases of foul-brood trouble.

To put the matter as forcibly as we can, it may be said that a person claiming to be an expert, or one who is known to generously render help to those who are in difficulties with their bees, who does not make himself acquainted with the nature and characteristics of foul brood and its means of possible cure, stands in the position a veterinary surgeon in an agricultural district would be in if he confessed himself entirely ignorant of pleuro-pneumonia in cattle!

EDITORIAL AMENITIES.

We have received the following communication from Mr. Henry Alley, editor of the *American Apiculturist*, and it is so admirable as a specimen of Editorial courtesy that we print it *verb. et lit.*, and leave our readers to form their own estimate of the writer:—

'T. W. Cowan,—I am just in receipt of the *B. B. J.* of Sept. 16. On page 419 I find a mean, dirty insinuation relating to myself. You know that the man who penned the words is stating what is absolutely untrue, you know that I am not doing and have not sold such queens as Lowmaster states . . . and you had no business to publish such a damaging statement from an irresponsible party. I presume I cannot get redress by law, could I do so would attempt it at once. I will certainly get information on this point before I let the matter drop.

'Until you apologise in *B. B. J.* for such a contemptible, unfrindly thrust, you may discontinue mailing your paper to me.

'I shall republish the item in the *Api.* for Nov., and give my opinion of the Ed. of the *B. B. J.* in unmeasured terms. . . . The cause of your hostility to the Punic bees will be ventilated in the *Api.* at no distant day. We understand the meaning of the stand the *B. B. J.* has taken in this matter.

'I do not see why you let Lowmaster vent his spleen in your columns. I never saw anything of the kind in your paper before. I hope it got there though some blunder or oversight by some one beside the Editor, as I entertain a much better opinion of T. W. Cowan. I shall await your reply and apology with more than usual interest.—H. ALLEY, *Wenham, Mass., Sept. 23, 1891.*'

[We omit two passages (indicated by dots) of a scurrilous, grossly libellous, and insulting character, which are quite unfit for publication in our columns. Our columns are open to any correction of statements appearing in them, and although we do not hold ourselves responsible for the opinions expressed by our correspondents, we use our best endeavours to prevent anything of a misleading character finding admission. Mr. Lowmaster's letter was sent to us for publication, and we did not notice anything that was inconsistent in it. Of course, Mr. Alley, like any one else, is entitled to correct any error, but his style of writing, though it may be acceptable to readers of his paper, is not quite the style readers of the *British Bee Journal* are used to. Mr. Alley says, 'You know that I am not doing and have not sold such queens as Lowmaster states.' We knew nothing of the sort, or we should have mentioned it in our footnote. For some time we have not cared to look at the *Apiculturist*, because it seemed to us nothing more than an advertising circular, and our attention was called to it by the allusion to the August number in the *Review*. Now, we will just see whether Mr. Lowmaster had any grounds for saying what he did, and for this purpose we will quote Mr. Alley's own words, taken from his own paper, the *Apiculturist*. In that paper, until 1889, Mr. Alley maintained that pure Carniolans should show no yellow. So far he was consistent,

for pure Carniolans do not show any yellow, and every one who knows anything about Carniolans, knows perfectly well that any trace of yellow at once shows impurity. Our acquaintance with Carniolans dates from 1875. We have kept a good many pure stocks ourselves, and have seen and handled many hundreds, but have never seen pure Carniolans with any sign of yellow about them.

Now, what are Mr. Alley's own words respecting Carniolans? In the *Apiculturist* for 1888, page 189, Mr. Alley says: 'Some ten years ago I imported several queens of this race, and I am quite sure that they were the only pure Carniolan queens that ever came into the United States.'—'Several parties who speak in high terms of the race, and claim to have pure bees, do not know them, and in my opinion not one of those who have them for sale ever saw a pure Carniolan bee. If they do have them, they must stretch the truth wonderfully when speaking of their good qualities. I want to inform those parties that pure Carniolan bees show no yellow bands. The colour of true bees of that race is whitish, or more like in colour to new cast iron.' [The italics in this paragraph, as in all the others quoted, are Mr. Alley's own.—Eds.]

Apiculturist for 1889, page 114: 'The colony is a large one, and not a bee in the lot shows a yellow band. They are as true types of the race of Carniolan bees as ever came to this country.' 'The colour of the worker-bees is a beautiful iron-gray.' Page 158: 'Pure Carniolans should show no decided yellow.'

Such extracts could be easily multiplied, but they will be sufficient to show Mr. Alley's views with regard to pure Carniolans. At the same time that Mr. Alley was rearing Carniolan bees, he was also rearing Italians, and in the *Apiculturist* for 1888, page 116, he announces his wonderful 'winter strain of pure Italian bees,' from which he is going to rear 2000 young queens during the coming season.

In *Apiculturist* for 1889, page 81, he describes a wonderful colony of Italians, and says: 'The bees of this hive are at work an hour earlier and work an hour later than any others in the apiary.' 'I shall rear 2000 queens from the business queen here described.' On page 150 is another description of the perfect colony, from which 2000 queens are to be bred.

In the April supplement for 1890 this colony is again alluded to, and the queen is here valued at 100 dollars, and 300 queens are to be raised from her. It is stated that 'every good point that bees should possess is combined in this one colony. There is not a bad or undesirable feature about them.' On page 57 we find he says: 'We also have in the apiary several splendid colonies of Carniolan bees. The others are Italians.'

In April, 1891, we find this advertisement, 'We now value this queen at two hundred dollars.'

Now for the connexion between these two:—*Apiculturist*, 1888, page 69: 'It is our intention to make many experiments in crossing some of the different races of bees the present season. Several Carniolan queens will be fertilised by Italian drones.'

1889, page 101: 'Having imported several fine Carniolan queens, I shall, after June 10, be prepared to supply young Carniolan queens in their highest state of purity; also Carniolan queens mated to the finest stock of pure Italian drones in America.'

Page 104: 'It seems to me that a cross of Carniolans with pure Italians would make the best strain we can get. I shall try it the present season. I think all bee-keepers are too particular about purity in any race of bees.'

Now, we find that after he has been experimenting and crossing them, at page 137 he throws out a first hint of there being a tinge of Italian blood in Carniolans. He says, 'In my opinion all Carniolan queens are more or less "tinged" with Italian blood. This fact should not scare the purchaser of these bees. I consider them all the better for the slight cross with the Italians.'

It will be seen that bee-keepers were gradually being educated in this matter. The climax is reached in 1890, and the secret is let out on page 112. We will give it in Mr. Alley's own words, under the title of 'A New Strain of Bees that was developed in the Bay State Apiary.' 'Last fall, when cleaning up our nuclei for the season, we found in one out queen-apiary (the one used for Carniolan queens) a muddy-yellow Carniolan queen. She had not been fertilised, and could not be by Carniolan drones, as we had none, nor did we have but a few Italian drones. It was late in the season (October 10) to expect a queen to be fertilised, yet I did not despair. We had about fifty fine drones in our 100 dollar colony. One day when the drones were flying out, about fifty were caught and placed in a nucleus colony, which was made all ready to move to the Carniolan apiary on the first day the weather was suitable for drones and queens to mate. After a few days' waiting, the weather cleared up warm about noon one day, and we took the drones and went to the out-apiary as quickly as our horse was able to take us there. When we got there the queen was on the wing. The drones were at once released, and in a moment's time all were in the air. In less than ten minutes the queen returned, bearing unmistakable indications of having been fertilised. In less than an hour from the time we started from home we returned with the queen. She was introduced to a weak colony, yet she managed to go through the winter all right, though there was less than a pint of bees in the spring. This queen proves to be very prolific, the workers extra good honey gatherers, and handsomer marked yellow-banded bees cannot be found. We shall at once commence to rear queens from her eggs, and have all of them fertilised by drones reared from our 100 dollar queen.'

Proceeding onward, on page 117 we find the first mention of 'yellow-banded Carniolan bees.'

On page 181 he says, 'It has been found impossible to rear pure or typical Carniolan bees in this country.'

This is after he has been experimenting and producing a new strain by crossing Carniolan queens with Italian drones.

On page 131 he says, 'There will be about 300 queens from our hundred-dollar queen. The balance will be from our yellow Carniolan, and imported mothers. The colour of the young imported queens is not as yellow as our home-bred queens; nevertheless, as the imported strain are fertilised by our beautiful drones, they will give perfect satisfaction.'

On page 146 he says, 'You have all heard considerable about the "coming bee." Well, if the yellow Carniolan bees do not fill the bill as the coming bee, then it will be a waste of time and

money to even try to produce the coming bee, or a strain that will be better than those we have now.' 'We expect to send out in the season of 1891 about 2000 of the finest yellow Carniolan queens that can be reared. Out of all the queens of this strain we have reared this year, two have been selected for breeding queens for the season of 1891. One will be used to rear queens from; the other for drones. On Sept. 6 we had a batch of twenty-five queens hatched from our best golden Carniolan queen.'—'They were all large, and as yellow as gold.'

In 1891, page 62, he says, 'We shall import light Carniolan queens to breed from this season.'

On page 79 he says, 'We wish it understood that our golden Carniolan queens are pure. They are not a mixture of Italian and dark Carniolan blood. All our young queens will be bred from our pure golden Carniolan queen, and fertilised by drones reared from another.'

Now, here is a distinct statement that his golden Carniolans are pure. We have shown how the yellow Carniolan strain was originated by mixing Carniolan and Italian blood, and if our readers will compare the dates, they will not be long in coming to a conclusion that Mr. Alley's golden Carniolans cannot be pure. No one in Europe, at any rate, has ever seen or heard of pure Carniolans being yellow, and to suppose that in so short a time pure Carniolans can be turned into pure golden Carniolans is a pill too large for us to swallow. Until Mr. Alley can show us that his own quotations and statements of how he produced these golden Carniolans are incorrect, we are bound to say that we do not see that what Mr. Lowmaster has stated is 'absolutely untrue.' If Mr. Alley can show us that we are wrong, we shall be quite prepared to apologise.

Mr. Alley's insulting remarks we can only treat with the silent contempt they deserve, as we shall also do with another grossly insulting letter which we have received from Mr. Alley since the above letter has been in type. We are sorry for Mr. Alley, as a man who can allow his temper to have the mastery over him in this way is greatly to be pitied. We are open to argument, but abuse is not argument.

Quos Deus vult perdere, prius dementat.

We must apologise to our readers for going so fully into this matter, and without entering into the merits or otherwise of the bees referred to we thought they would be interested to know how new strains of bees bred for sale may be originated.—Eds.]

HOW TO MAKE BEE-KEEPING PAY.

I have received the following query:—'I am a book-keeper (aged twenty-five), at a moderate salary, and as my health is not very good, and I have a house and an acre of land outside the town limits, I have decided to go into bee-keeping. How shall I make bee-keeping pay?' The way to make bee-keeping pay is to do the business upright, and to do it right you must have an understanding of it; and, to the understanding, you must add practice and experience. And that is not all. There are other things requisite. You must be adapted to the business—must have an aptness for it, and take pleasure in following it. And, as a rule, he or she who has a love for the pursuit, has an

aptness for it. You must also have firmness, a steady nerve, and good judgment. You must also have some fertility of resource, so that you need not be running in every little emergency to the book or the teacher for assistance and advice, but be able to work your own way out of little difficulties and perplexities. Some people, in any business or circumstances, get 'all at sea' just as soon as they find themselves in some novel or unexpected position. If some rule or direction they have learned will not apply to it and help them out of the emergency, they cannot get out. Others will promptly devise a plan or course to suit the case. You also need a good location, in order to make bee-keeping pay. Abundant and varied forage is a fruitful factor of pecuniary success in bee-keeping.

With all these conditions present, you are bound to succeed, and make bee-culture pay. But wait! I am just a little too fast. One important consideration has been overlooked, and I charge this young man seeking advice not to forget it. He says he is twenty-five. He also says he has a house standing on the acre. Now that house, no doubt, will hold two people, and possibly more, after a while. And every house in the land ought to be properly filled. And every good citizen, who has become of the full age of twenty-five years, ought to do his part in filling them, especially at the present juncture, when we Canadians are showing up so discouragingly in the census figures. Now this young bachelor may, by this time, no doubt, partly guess what I mean.

In order to succeed properly in the bee-business, and make it pay handsomely, he must take a wife into that house with him. Then, on the principle that 'Providence helps those who help themselves,' Providence will surely smile on him. The man who is fortunate enough to have a good woman smile on him will straightway realise in the good wife a good Providence; and with plenty of bees in the yard, and honey in the larder, there can be a perpetual 'honey-moon' literally as well as sentimentally. So mote it be! There is, however, a prosaic, as well as poetic, side to this business—I mean, the bee-business. There is shadow as well as sunshine, and we are, of course, all anxious to increase the latter and minimise the former. How to do this is the question; and to go into particulars and tell the querist in detail how to make bee-keeping pay, would take a volume or two, and hence is impracticable here. I may, however, give him a few general hints.

If wholly inexperienced, start with not more than five colonies, that is, if there is other remunerative work in conjunction; if not, say twenty colonies at most. Start with a good movable-frame hive, which can be worked for either comb or extracted honey, and produce both kinds, as your local market will require both kinds, and, moreover, you can never be an all-round bee-keeper without producing both comb and extracted honey. Use the perforated zinc, or 'queen-excluder' to confine the queen to

her own quarters, the brood chamber, and you will thereby save yourself much trouble, and produce a better quality of both comb and extracted honey than you could otherwise do. Keep your colonies strong, and put none but such into winter quarters. Give them plenty of winter stores, or rather, leave plenty with them which is much better than taking it from them, and giving it back again. No matter what anybody may say against *clipping* in the bee journals or out of them, keep your queens clipped, and thereby avoid much work and worry. Keep your yard and hives clean, and free from dead brood, which sometimes leads to, if not causes, foul brood. Do not allow drone comb to accumulate in your brood chambers, so that you may be led into the practice of decapitating the drones, which is a bad practice. To avoid this, use full sheets of foundation in your brood frames, but the less foundation you use in your sections the better. Take good care of your honey from the time you remove it from the hives till you market it, especially the comb honey, which should be kept constantly in a warm, dry place.

Do all this and be saved, or do it not and be lost, financially.—ALLAN PRINGLE, in 'Canadian Bee Journal.'

Correspondence.

The Editors do not hold themselves responsible for the opinions expressed by correspondents. No notice will be taken of anonymous communications, and correspondents are requested to write on one side of the paper only, and give their real names and addresses, not necessarily for publication, but as a guarantee of good faith. Illustrations should be drawn on separate pieces of paper. We do not undertake to return rejected communications.

Communications relating to the literary department, reports of Associations, Shows, Meetings, Echoes, Queries, Books for Review, &c., must be addressed only to 'The Editors of the "British Bee Journal," 17 King William Street, Strand, London, W.C.' All business communications relating to Advertisements, &c., must be addressed to Mr. J. HUCKLE, Kings Langley, Herts (see 1st page of Advertisements.)

*** In order to facilitate reference, Correspondents, when speaking of any letter or query previously inserted, will oblige by mentioning the number of the letter, as well as the page on which it appears.*

BEE ASSOCIATIONS AND COUNTY COUNCIL GRANTS.

[849.] In the hope of assisting honorary secretaries and others who take an interest in Bee-keepers' Associations, I should like to add my quota to the information contained in Mr. F. H. Meggy's letter (833, p. 502) in your issue of the 5th November, by giving some details of what is being done in Lancashire and Cheshire to use the grant of 100*l.* already confirmed by the Council of the former and 50*l.* recommended by the Committee of the latter.

It will be in the knowledge of most of your readers that some time usually elapses between a recommendation being made by a Committee and the confirmation thereof by the Council. This was the case with Lancashire, but with the view of saving time, so soon as we heard of the recommendation of the Education Com-

mittee of the Council, and not having an Examining Committee in our own Association, we applied to the British Bee-keepers' Association to recommend a lecturer, at the same time drawing their attention to the final paragraph of our memorial to the County Council, which reads thus:—'A further and most important feature of such an expert's work would be the giving full information, with a view of checking and finally exterminating that virulent, but at present little understood, disease called "foul brood," which, in its results among bees, is equivalent to pleuro-pneumonia among cattle. From lack of knowledge one infected hive is often the cause of wholesale loss throughout a whole district.' The result of this application was that we advertised for a lecturer, as all who are interested in your *Journal* will know; but I might mention that these advertisements, with what concerned them, are given in your issues of the September 24th and for October 1st, 8th, and 15th.

Taking into account the considerable sums of money that have been and are likely to be voted by County Councils and other authorities for technical education in bee-keeping, and bearing in mind that the Essex lecturer looks for a fee of from three to six guineas if he goes outside his own county, and also that an expert to act as referee on practical bee-keeping has to accompany him, it was, to say the least, disappointing that only four candidates put in an appearance before the Educational Committee of the British B.K.A., the result being that only two could be fully recommended as lecturers having a proper regard to the infectious nature of 'foul brood.'

The Committee of the Lancashire and Cheshire Association on this recommendation have therefore appointed Mr. P. Harbordt, and he will at once commence his duties.

In addition to the 150*l.*, we are likely to have further sums at our disposal, for local authorities who are desirous of having lectures delivered in their neighbourhoods are already offering to meet us with grants if they can obtain the services of our lecturer.

Up to this point both county authorities agree with our action, and request that we will draw the attention of County Councillors by circular to the fact that we are ready for applications for the lecturer's services. Copies of these circulars will be sent to our local hon. secretaries. We then proposed that our local hon. secretaries should arrange for suitable rooms for lectures, &c., and to fix dates, with all other details; but, having reference to this arrangement, one county says 'Yes,' while the other says 'No; we will arrange for rooms and the dates.' From this point I take it each Association will have to act so as to meet the wishes of the authorities giving the grant. We are meeting the views of our respective county authorities by issuing different instructions regarding the proposed lectures to our local hon. secretaries (copies of these various circulars I hope to send you in the course of a few days).

Parties have offered their services to us as lecturers; but, on being told that the Committee of the L. & C. B. K. A. have unanimously agreed that all lecturers to be paid out of the County Council grant must be approved by the Committee of the British Bee-keepers' Association, displayed some objection to face this ordeal, and consequently they have withdrawn their applications.

I am glad to say the authorities in both counties are agreed that we should only deliver lectures this year, and *form no classes* for technical instruction. Our aim this year will, therefore, be to stir up and create an interest in the art of bee-keeping, especially among artisans and labourers living in suitable districts. The fact of classes not being recommended this year I trust will give time to the Committee of the B. B. K. A. to decide whether they will, another season, avail themselves of the general rules (or some modification of them) issued by the Society of Arts, John Street, Adelphi, W.C., for their proposed examinations in shorthand, &c., in March, 1892. I know the cry of our dear old friend, Dr. Bartrum, will be, 'Where are the funds to come from?' My reply would be that we must get an addition to our list of subscribers, and fees must be charged, as in the programme of the Society of Arts, to all candidates offering themselves for examination. But the question arises, Where are the examiners to be found? If the Committee of the B. B. K. A. do not find an answer to this question, they, to my mind, will cease to exist as a ruling medium for the industry of bee-keeping, and one or other of the technical educational societies—either through one of their own bodies, or by means of the Agricultural or Horticultural Associations—will take the subject up, reaping all the benefit of the experience *bought* by the members of the B. B. K. A. during the past seventeen years.

With membership since 1882, and active work on behalf of the L. & C. B. K. A. since 1884, we are not prepared to hand over our experience to any other authority than the one put forward in our memorial, viz., the B. B. K. A., and if they are not strong enough to support us, we must come to some arrangement with a provincial authority to organize a thorough examination of candidates wishing to act as lecturers or experts throughout our district.—
WM. LEES M'CLURE, *Hon. Treas. L. & C. B. K. A., The Lathams, Prescott, November 14th, 1891.*

BEE ASSOCIATIONS AND COUNTY COUNCIL GRANTS.

[850.] I regret that I was unable to make comment upon Mr. Meggy's communication, which appeared in the *Journal* of the 5th inst., in time for the issue of the succeeding week. I am a little surprised that no discussion has arisen from any other quarter, as it strikes me most forcibly that such a plan of earning the

Council's grant is deficient in those features which such a responsible body would demand as a *sine qua non*, and which, if neglected or left out, must result in the refusal of the Council to confirm the grant.

Now, what I believe to be necessary is a fuller appreciation of the opportunity which unexpected circumstances have suddenly placed certain of the County Associations in; and this can only be properly realised by taking a broad view of the situation. For each Association to work upon its own ideas, without regard to the general advantage of bee-keeping throughout the country, would display a want of unity of action and tendency to weakness subversive of the confidence which the public should feel in the representatives of the bee-keeping movement. That this danger does exist is shown by the variety of the methods proposed for earning the grant in the several favoured counties. Far be it from me to describe any of these as wrong; but I would go so far as to say that each would probably be benefited by blending together the most suitable parts of each other's, and correcting or strengthening those where further consideration might show the need of it. I think a practical step was taken when the members present at the last *conversazione* of the B. B. K. A. agreed to call upon the Committee to prepare a syllabus for a course of lectures suitable for general teaching throughout the country. But this is *only a step*. The time is now quite ripe for setting out a complete plan of procedure, and the affiliated Associations should be recommended to adopt it. In anticipation of the meeting of the Committee on Wednesday next, I venture to suggest that its consideration should be given, not only to the preparation of the syllabus, but also to the best mode of applying the funds placed at the disposal of the respective Associations. From what I learn of the procedure in the county of Kent, a strict supervision will be observed by the County Council over all the classes that are formed, and precise reports demanded as to the number forming the same, and the manner in which they are attended. Subsequent to the course an examination will be held, and, presumably, certificates awarded. Hence it will be seen that, as far as practicable, technical instruction in bee-keeping will have to be imparted under similar conditions.

With regard to the application of the funds, I should propose that one or two districts only should be chosen; that the course of lectures should be spread over five or six evenings, once a week or once a fortnight, as the case might be—taking, for example, Maidstone as a centre, and half-a-dozen surrounding villages as one area; and Sevenoaks, with a similar number of villages, for another. By this means the expenditure of the fund will be concentrated, and practical benefit ensured; whereas, by any other course, a great risk would be incurred of frittering away the money and failure in attaining practical results.—JESSE GARRATT, *Hon. Secretary, Kent Bee-keepers' Association, Meopham, Nov. 14th.*

NOTES BY THE WAY.

[851.] The Anglo-Saxon designation of November as the *Wint Monat*, or wind month, still holds good, and the bee-keeper who dwells in, or has his apiary located in, some sheltered nook may well be thankful that he has been protected from the hurricane of the past week, and that his hives have not been blown over and his bees and combs drenched and soaked by the pitiless rains, as I hear has been the case in some apiaries in exposed positions. A word for our new recruits, as the craft is evidently on the increase by the constant accession of new bee-keepers. I think that standard recipes for making bee-food could be given as the seasons occur, and the time comes round for its use in the apiary. To old hands who have the back numbers of *B. B. J.* or *Record* to refer to the matter is trivial and of no moment; but to the new hand the knowledge that at the proper time he will find full instructions how to make his syrup for autumn feeding, also how to make his bee-candy to tide over the winter months; then, in the early spring, how to make his flour-cake for gentle stimulation, and later on his syrup best adapted to build up his stocks ready for the honey harvest, would be a boon. I don't complain, but in the interest of novices in the craft I consider something of the above system would be far preferable to the often—I was going to write constant—references to previous numbers of our *Journal* for the information asked. It might be given among 'Useful Hints' in *B. B. J.* and in *Record* in 'Work for the Month.'

Dovetailed hives, as recommended by our 'Cheshire friend' (835, p. 503), seems to be the leading style in America just at present, and I have no doubt from the encomiums passed on them in American bee-papers that they fully answer the purpose of a cheap hive, easily put together by the novice in carpentry, and if the joints are well painted before nailing together the joints should stand a good number of years before the weather gets in to rot them.

Referring to 'bee-law' in this part of the country, as far as I can glean from all the older bee-keepers, it has been the recognised custom, that if a man's bees swarmed on or into his neighbour's garden or field, he had the right to follow his swarm of bees whithersoever they went provided he rang them with key and shovel and could keep them in view. 'T. F. L.' (832, p. 501) puts the matter very plainly and lucidly, and in my opinion more equitably than the judge at Marlborough. Our brethren in America have a strong society for the protection of the interests of its members and have during the past few years sustained and carried several very important cases referring to bees and bee-keeping through the higher courts thereby establishing precedents. Here, however, when a case crops up it is generally sufficient to post up contentious parties with printed copies of previous cases, and the matter drops.

We require in the present advanced state of apiculture some definite law on the subject of

securing truant swarms. If a man invests his money in sheep, and the wind blows the fold down, or the sheep jump over the fences, or break them down, and stray on another's land, the owner would be justified in going on the land after the sheep, though, of course, any damage the sheep had done while on the land must be paid for by the owner of the sheep. Why, then, should a man who invests his money in bees be debarred the same privilege as the shepherd? Surely, if each purchased an article the articles belong to the respective purchasers, and each has an equal right? The question is how can we, as bee-keepers, get a 'ruling' on the subject?

I will remember the request of 'Mid-Cheshire,' *re* sections, glazing, and comb-honey production.—W. WOODLEY, *World's End, Newbury.*

[No doubt our correspondent, Mr. Woodley, is unaware that the dovetailed hive referred to on p. 503 is in no way akin to those made in America. The latter are not 'dovetailed,' but simply jointed in exactly the same way as a one-piece section.—Eds.]

GRANULATED HONEY—AVERAGE YIELDS.

[852.] I am glad to see the question of candied honey at shows coming to the front. I have never been able to understand why it should be overlooked. During the last ten years I have had a somewhat extensive experience in retailing honey, and only upon one occasion have I ever been asked for liquid honey, in which case the honey was required for a particular purpose, which necessitated it being liquid. But I am frequently asked for honey that is 'set,' and that is the kind I nearly always sell. The only time that I sell liquid honey is quite at the commencement of the season, before it has had time to granulate. I do nothing to prevent granulation, but rather encourage it, and do all I can to impress upon the minds of my customers the fact that granulation is one of the best tests of the purity of honey, and that as a rule the better the quality the sooner it will candy, and I would advise Mr. Brown (827, p. 491) to do likewise. It is the nature of honey to granulate, and it does so without deteriorating. Uniformity is a great thing in selling honey. If you start liquefying honey, then you must liquefy the whole, otherwise some of your customers will get clear honey, others granulated, and they will soon have an idea, and rightly so too, that you do something to keep the honey clear or to cause it to candy, and any tampering with honey will be sure to be looked upon with suspicion. We have been told over and over again that adulterated honey will not set, but will remain liquid for an indefinite period. If that be true, then I maintain that granulated honey, which is not only pure but a home product, should occupy a premier position—that is, that it should be regarded as something superior to liquid honey, and prizes at honey shows should therefore by no means be confined to clear honey, by which

means the public is induced to look upon liquid honey, which may be highly adulterated, as the right and proper thing, and to regard candied honey with disfavour. When visiting a honey show some two or three years ago, the judge pointed out to me a splendid exhibit of clover honey, and declared that its only fault was this, it had become cloudy, that is it had commenced to granulate, and for that reason had to take a third place. No doubt there are many such instances as this, and no fault of the judge either. The matter is of vital importance to British beekeepers, and it is to be hoped that formulators of prize schedules will in future make provision for candied as well as liquid honey.

Thanks, Mr. Birkett, for your average honey yield (839, p. 513). It would, as our Editors observe, add very materially to the usefulness of a return of the number of colonies kept were stated. It would also become more instructive if the method adopted in averaging yields were given. Supposing, for instance, you have ten hives of bees, and that from five of those hives you get 100 pounds of honey, while the other five give nothing, would you call that an average of twenty pounds per hive, thus counting only the hives which helped to produce the surplus; or would you call it ten pounds per hive, thus counting the whole of the hives kept? Supposing again you have ten hives of bees, and that five of those hives swarm, making a total of fifteen hives, but that the whole of your surplus is taken from the five hives that have not swarmed—in averaging your yield would you count five, ten, or fifteen hives?—A. SHARP, *Huntingdon*.

[1. We would remind our correspondent that classes for granulated honey are now included in schedules of most of our important shows. Besides, however desirable it may be to make it known that pure honey will granulate, we must be just as careful not to foster the idea that clear liquid honey implies impurity. Neither do we consider it correct to say that 'the better the quality, the sooner it will candy.' As a matter of fact, no honey we know of granulates so rapidly as that from the mustard-fields of Lincolnshire, yet the quality of that particular kind is not held in much esteem. But there are many reasons why high-class honey is preferred in its liquid condition; it is far more convenient for use at table, to say nothing of the loss of the fine flavours and delicate aroma, which is so wanting when honey becomes solid. Therefore we consider it a very wise precaution, while emphasizing the fact that pure honey will granulate, to take special care to explain that heating the vessel containing it will re-liquefy it, and so make it more useable. 2. An average yield per hive for the season, to be correct, should be calculated on the full number of stocks in hand when season begins. Thus, if a man owns ten hives of bees, his average yield is distributed over that number as a whole. In the same way if he gets 200 pounds of honey and five swarms from the ten stocks, the quantity of honey must not be credited to fifteen hives, nor to any less number than ten. The average obviously is twenty pounds per hive; and five swarms to the good in addition.—Eps.]

BEE NOTES.

[853.] Being confined to the house with a bad cold, I have been looking over the *B.B.J.* I see Mr. F. J. Cribb (840, p. 513) is thinking of distributing his hives here and there. It strikes me, he will have more trouble than the extra honey he is likely to get will repay him. I have three stocks, a mile and a half away, and thought I was going to do as I liked with them; however, when the summer came, and honey began to come in, the bees began to swarm, and the old lady who was to manage them for me unfortunately got an attack of influenza just at that time. Of course I was sent for, just when I had the least time to spare. Certainly the bees may gather more honey by Mr. Cribb's plan, but in my opinion there would be too much trouble attached to it. Rather curious that a bee-keeper at Ealing (referred to in 841, p. 514) should attribute his success in getting forty to sixty sections of comb honey to 'feeding the bees with syrup immediately after Christmas!' As regards skeppists feeding in winter, that isn't in it, as they mostly get a twig of elder, and, by scooping out the pith, make a trough, and just push it in at the entrance, and as the most syrup they could give at one time would be one or two tablespoonsful, that would not make much difference either way.

I hope our friend 'Novice' (842, p. 514), after having kept bees for a season, will be as enthusiastic as he appears to be now. He does not say if he has yet had the chance of being among bees or of handling them. However, I hope he will pardon me for suggesting that he should prepare himself for the 'practical' part, and not give up when he comes to be saluted by the bees from a *business point*. He may reckon to have some little experience in that line before he renders a good account of his first season.

Rather a curious thing, isn't it, that although I am usually so fond of honey, while I have been suffering from this cold I don't seem to like it a bit?—JOHN WALTON, *Honey Cott, Weston, Leamington*.

Queries and Replies.

[455.] *Drone-breeding Queen*.—Will you kindly allow me a small space in your valuable paper for the following, respecting a young queen of this year? I have five stocks of bees, two of which are in skeps, the other three in frame hives. I purposed having three young queens in the frame hives for next year; but, in consequence of the disastrous weather at the end of summer and beginning of autumn, two of them failed to get mated, and I left them to their own devices, anticipating all was going on well. To my astonishment, when I came to pack down for winter, I found two of the stocks in frame hives containing drones. I immediately concluded they were queenless, and called the attention of our Hon. Secretary (who holds a second-class certificate as expert) to

the fact. On our examining one stock, we discovered young drones struggling for their lives to leave worker cells, and then concluded there was a drone-breeding queen in this hive. I therefore procured two young queens, notwithstanding the late date. When I came to look for the supposed-to-be drone-breeder, I could not see a single drone, but a thorough good stock of bees, covering seven or eight frames. However, I removed the queen, and am sending her to you for examination. You will see she has part of her left wing and one of her right legs *minus*. This may have probably been done on her mating flight, or from birth. It was the beginning of October when we discovered the young drones hatching, and I have just recently introduced the strange queen. I took the one queen away and introduced the other direct, and the bees seemed to accept her at once. I've no doubt it was a haphazard kind of way to proceed, but as it was so late in the season, and also an experiment, I thought I would try it; and, so far, it appears to have been a success. Perhaps, after a careful examination of the queen sent, you will be able to say whether she has been mated or not.—**GEORGE PARKER, Wotton-under-Edge.**

REPLY.—The poor mutilated queen arrived in such pitiable condition—plastered all over with the honey put in box as food, and nearly dead—that we charitably destroyed her. No *post mortem* was needed to see that she had been so injured that it was impossible for her to become fertilised. There was no malformation—one leg and one-half of the double wing being torn off, and we fear you will have to credit yourself with the damage through some carelessness in manipulating, as the mischief could not possibly have happened on her mating trip.

ESSEX B.K. ASSOCIATION.

AUTUMN SHOW.

The E.B.K.A. held a very capital exhibition of honey at the Corn Exchange, Chelmsford, on the 11th inst. in connexion with the chrysanthemum show of the Essex Horticultural Society. Though the honey classes were confined to members of the E.B.K.A. only, the quantity and quality of the produce staged was exceedingly creditable to the members and to the County as a honey district. The exhibits were nicely staged, and looked very well indeed. It was a matter for regret that the boisterous weather in the earlier part of the day prevented a large attendance of visitors while the storm lasted. As, however, the exhibition was continued to the evening, a cessation of the wind and rain made it possible to venture out with comfort, consequently the attendance later on was very much more satisfactory.

The judge, Mr. W. Broughton Carr, made the following awards:—

Honey.—Open Classes.

Single Section.—1st, W. Debenham, Chelmsford; 2nd, R. R. Royd, Kelvedon Hatch.

20 lbs. Comb Honey.—1st, W. Debnam; 2nd, W. Christie-Miller, Broomfield; 3rd, A. Mayell, Bradwell-on-Sea.

20 lbs. Extracted Honey.—1st, W. Christie-Miller; 2nd, W. Debnam; 3rd, A. Mayell; h.c., Mrs. Cobb, Great Waltham.

Twelve 1-lb. sections Comb Honey.—1st and British Bee-keepers' Association silver medal, W. Debnam; 2nd, W. Christie-Miller; 3rd, G. H. Aubrey, Springfield.

Twelve 1-lb. jars Extracted Honey.—1st and British Bee-keepers' Association bronze medal, W. Christie-Miller; 2nd, A. Mayell; 3rd, W. T. Cadness, Chadwell Heath; h.c., W. Debnam; C. M. Collins, Tillingham; and A. Barnard, Chelmsford.

Twelve 1-lb. jars Granulated Honey.—1st and British Bee-keepers' Association certificate, F. H. Brenes, Brentwood; 2nd, Mrs. Thomas Jackson, Tillingham; 3rd, Lewis Belsham, Heybridge; h. c., W. Christie-Miller, W. Debnam, and J. Winter, Kelvedon Hatch; commended, A. Mayell.

Super Comb Honey.—Mrs. Cobb and W. Christie-Miller, equal first.

Beeswax.—1st, W. Debnam; 2nd, W. Christie-Miller; 3rd, R. Dutton, Terling End; commended, A. Mayell and J. C. Chillingworth, Bradwell-on-Sea.

Amateurs' Classes.

Collection of 12 lbs. to 20 lbs. Comb and Run.—1st, W. Christie-Miller; 2nd, Mrs. Thomas Jackson.

Six 1-lb. Sections.—1st, C. R. Finch, Great Baddow; 2nd, W. Christie-Miller; 3rd, F. H. Brenes; commended, A. Barnard.

Six 1-lb. jars Extracted Honey.—1st, W. Christie-Miller; 2nd, C. R. Finch; 3rd, R. R. Royds; h.c., Mrs. Cobb and R. Dutton.

Cottagers' Classes.

Single Section, Comb Honey.—1st, John Winter; 2nd, C. M. Collins.

12 lbs. to 20 lbs. Comb and Run.—1st, C. M. Collins; 2nd, A. Mayell; 3rd, G. Gibson, Burnham-on-Crouch.

Six 1-lb. Sections Comb Honey.—1st, C. M. Collins; 2nd, John Winter; 3rd, A. Mayell.

Six 1-lb. jars Run Honey.—1st, John Winter; 2nd, L. J. Camping, Southminster; 3rd, A. Mayell; h.c., C. M. Collins.

Beeswax.—1st, John Winter; 2nd, A. Mayell; 3rd, C. M. Collins.

BEE-CULTURE IN SOUTHERN CALIFORNIA.

Southern California presents a condition of apiculture and a class of apiarists generally, as well as a system of non-systematic management, or rather unmanagement, which the press, though on the alert to report promptly all new discoveries, freaks, &c., connected with our business, have sadly neglected, and I am sure there are many of our Eastern and Northern friends

who have no idea of how honey-production is carried on in this picturesque land of semi-tropical beauty and apicultural negligence, where the invigorating breeze from the broad Pacific wafts the melodious hum of the busy bee o'er the floral-clad hills as they course their way in countless millions in search of nectar, and return laden with their precious burden to the dilapidated home of the honey-bee and wax-moth, where both seem to revel in the 'glorious climate,' and each strives for supremacy.

It would seem that all the requirements necessary for the establishment of ideal apicultural enterprises and their successful operation are combined in Southern California, yet I am informed that the deplorable state of affairs prevalent in this section exists throughout the southern part of the State, but can speak personally only of those which I have seen—some ten or twelve apiaries embracing, perhaps, 2000 colonies of bees, with which I have been brought in contact by the genial courtesy of fellow bee-men, and the business duties of one dependent upon the product of the bee for a livelihood.

If there is one feature which would impress an apiarist from the Eastern States, or Canada, more than another, on visiting Southern California, it would be the entire disregard for order, exactness, or system which characterises the honey-producers. The study of the honey-bee, its habits, requirements, and improvements which so deeply interest the apiarists of the East, as they strive to fathom the unknown depths of Nature's mysterious sea, and seek to lift our profession to a higher plane among the great industries of the world, is unknown in this portion of California.

The combined satisfaction, pride and interest which a modern apiarist feels as he scans the straight rows of neatly painted hives, with their accurate bee-spaces, perfect combs, and general uniformity of appearance, with a perfect knowledge of each colony's history, and each queen's record from the very day of her advent—all her traits, desirable or otherwise—and all of the interesting study and fascination of modern apiculture, as known and practised by advanced apiarists of to-day, which renders our avocation fairly remunerative, yet rivalling chemistry in point of interest, is superseded in this section, at least, by an avaricious tumult, much to their detriment financially.

The California bee-man, masked and protected from the Cyprian venom by veil and gloves, with sleeves attached, and an extra shirt or two, generally, and pants tied down to his shoes—not forgetting to put a wisp of alfalfa in the hole in his hat—armed with smoker and 'pry' (which is a sort of young crowbar), marches upon the weather-beaten and dilapidated habitations of the unfortunate bees, warped out of shape by the powerful rays of the sun, over which are placed a coarse ragged sack, or sacks, beneath a small lumber pile which serves as a roof through which the water pours in miniature cataracts in the rainy season, and runs out of the entrance,

if by chance that end happens to be the lower; if not, it usually finds ample room for 'exit at the rear,' as it courses its way down through the last year's unfinished sections, and through the brood chamber, seeking its level.

But the masked man, with the burglar's 'kit?' See! he advances slowly, but with resolute step and contracted brow, expressive of a strong determination to expose its most interior workings to the light of heaven. Nearer, yet nearer, and the awful scene is obscured in a dense cloud of smoke, but he still persists in his premeditated and merciless onslaught, smoking the bunch of bees behind the hive (?), which arrest the direct rays of the sun which would strike the combs, then the little clusters underneath, guarding the cracks and holes from intrusion by robbers, lizards, mice, &c., and the several other little bunches and clusters which serve as a 'chink' in the wall, he unpiles the lumber, thus temporarily destroying the peaceful habitation of many moth millers, and the numerous promising and fat worms are rendered homeless and destitute for ever.

As the propalo—sackcloth—is torn from the frames of various widths and sizes, and the alarmed inmates fly into the air, he places the pry in position and prises the end of the hive off a little to relieve the friction of the end-bars of the longer frames, and not infrequently succeeds in extracting a frame, which he scans carefully, replaces it, puts on the rags and lumber, upon which he places a stone and two handfuls of earth (which I learned denoted 'laying work') and, reminded by the case in hand, proceeds to examine the several others bearing the stone and two piles of sand, which he had placed there two or three weeks previously when he had 'no time to monkey with them,' to see if they still have a laying worker.

(To be continued.)

Notices to Correspondents and Inquirers.

Letters or queries asking for addresses of manufacturers or correspondents, or where appliances can be purchased, or replies giving such information, can only be inserted as advertisements. The space devoted to letters, queries, and replies, is meant for the general good of bee-keepers, and not for advertisements. We wish our Correspondents to bear in mind that, as it is necessary for us to go to press in advance of the date of issue, queries cannot always be replied to in the issue immediately following the receipt of their communication. All queries forwarded will be attended to, and those only of personal interest will be answered in this column.

S. T. P. (Nottingham).—*Candy Feeding*.—A cake of soft candy may be laid over the feed-hole in enamel-cloth quilt without disturbing the latter, provided the candy is covered with a box-lid, or some such thing, to keep in the bees. The amount of food you name (fourteen pounds) will no doubt suffice till March next, but it is best to err on the safe side.

R. CHAPMAN (Newton).—We cannot say why the honey became 'sticky and stringy' when warmed; if you can send a sample we may be able to account for it.

Special Prepaid Advertisements.

Situations, Publications, Bee Plants, &c.—Twelve words and under, Sixpence; for every additional Three words, One Penny.

Trade Advertisements not inserted under this head.

WALLFLOWERS.—Fifty Plants, 1s. free. Arabis, 1s. per dozen. Address **NORMAN PARKIN**, Blakenhall, Wolverhampton. L 51

WANTED.—Extracted Honey (Granulated) in bulk. Address **W. RUSHTON**, Bee Farm, Bedford. L 51

HONEY WANTED.—Bulk. State lowest price. Address **W. GRIFFIN**, 251 Oxford Road, Reading. L 51

FOR SALE.—Two strong Stocks of Hybrid Ligurians (one crossed Carniolan) in Frame Hives, 25s. each. Neighbour's Cylinder Extractor, 12s. 6d. Address **SHEPARD**, Derby Road, Woodford. L 82

BEES FOR SALE.—A Bargain.—Ten strong Stocks in Bar-frame Hives, Standard and Baldwin. Choice from 30 lots. For particulars apply to **C. HARRIS**, The Vine, Welwyn, Herts. L 83

FOR SALE.—White Clover Honey, 10d. per lb., or offers. Four pounds of Wax. What offers? Address **APIARIST**, Fairspeir, Ascott, Oxford. L 84

FOR SALE.—Fifteen Stocks of Black Bees in Bar-frame Hives. Fed up for Winter. No Honey taken from brood-nest. £1 each, or £11 for the lot. Address **R. STOKEKNOLL**, Bishopstoke. L 85

FOR SALE.—Sixty Sections of Comb Honey, and 40 lbs. of Extracted. Good quality. Price £3 5s. Deposit System. Address **W. CHOLCROFT**, Hare Street, Buntingford, Herts.

BEE-KEEPING, its Excellence and Advantages. Price 3d. *British Bee Journal* Office, Kings Langley, Herts, and 17 King William Street, Strand, London, W.C.

NEW EDITION NOW READY.

21st Thousand.

THE BRITISH BEE-KEEPER'S GUIDE-BOOK.

By **THOS. WM. COWAN**, F.L.S., F.G.S., &c.

Revised and enlarged.

Almost entirely re-written. Much new matter and many fresh illustrations added.

Fcap. 8vo., price 1s. 6d.; or in cloth gilt, 2s. 6d. Postage, 2d.

To be had of **HOULSTON & SONS**, Paternoster Sq.; all Hive Dealers, Secretaries of Bee-keepers' Associations, and of **J. HUCKLE**, *British Bee Journal* Office, Kings Langley, Herts.

BRITISH BEE-KEEPERS' PRACTICAL NOTE-BOOK.

With Rules for the General Management of Movable Comb Hives.

By **THOS. W. COWAN**, F.G.S., &c., Editor *British Bee Journal*.

Consists of a Series of Tables by means of which the Bee-keeper can keep a record of all his Observations and Operations. A Pocket-companion indispensable to the practical Bee-keeper.

Price 1s., postage 1d.

Bee Journal Office, Kings Langley, Herts; and 17 King William Street, Strand, W.C.

BALDWIN'S is the Oldest Establishment in the United Kingdom wholly devoted to Bees and manufacture of

Bee-keepers' supplies. His prices will compare most favourably with those of any other Maker, while for quality of material, suitability and workmanship, he has no rival.

'Why can he give better value for money than others?' Because he spends less in large 'puffing' advertisements, buys in the best markets for prompt cash, has no rent to pay, and personally conducts his own business.

For prices and full particulars of Goods see Baldwin's Bee-keepers' Instructor (and Illustrated Catalogue combined), which 'contains more practical and reliable hints than all the large, expensive books,' post free for 2d. stamps. Address **S. J. BALDWIN**, The Apiary, Bromley, Kent.

N.B.—More than 500 Silver and Bronze Medals, First and other Prizes, and Testimonials innumerable.

THE 'GARSTANG' HONEY PRESS.

(As published in *British Bee Journal* for Sept. 10.)

Inside Plates either Wood or Iron.

Prices on application. 3282

Address **ROBERT BARTON**, Garstang, Lancashire.

WINTERING BEES. By **THOMAS W. COWAN**.

The most complete work on the subject of Wintering published. Third Edition. Price 3d.

J. HUCKLE, Kings Langley, Herts.

British Bee Journal and Bee-keepers' Record.

OFFICE:

17 KING WILLIAM STREET, STRAND, LONDON, W.C.

PURE CANE SUGARS.

For the accommodation of Bee-keepers, guaranteed Pure Cane Sugar will be supplied in large or small quantities through this office at the under-mentioned rates:—

		MOIST. (For Household Use.)			
		Neat bags, 14-lbs.	28-lbs.	56-lbs.	Cwts.
3.	MUSCOVADO	2/7	5/2	10/- 19/6
		CRYSTALLISED.			
4.	DEMERARA	}	Crystals 2/9	5/4	10/6 20/6
5.	BARBADOS				
6.	TRINIDAD				
		REFINED CANE.			
7.	WHITE CRYSTALS (Small)	3/0	5/10	11/6	22/6
8, 9.	(Medium and Large sizes, 1/- per Cwt. extra.)				
10.	LUMP (Cut Loaf) ... Boxes,	3/3	6/3	12/3	23/6
11.	LUMP DUST	3/	6/-	11/9	22/9
12.	PRESERVING	3/-	6/-	11/9	22/9

		FINE. (For Household Use.)			
13.	GRANULATED	3/3	6/3	12/3	23/9
14.	CASTOR Coarse (15 Fine)	3/9	7/3	14/3	27/9
16.	ICING... ..	4/3	8/3	15/9	31/-

All above guaranteed made from CANE SUGAR only, and free from BEER, CHEMICALS, etc., etc.

CARRIAGE PAID on Orders over 5/0 (or 28-lbs. Sugar) to London and Suburbs.

COUNTRY ORDERS, not less than 2-cwt. carriage paid at 1/0 per cwt. extra.

(Scotch and Irish orders, special arrangements.)

CHEQUES payable to **J. HUCKLE**, Kings Langley.

Cash to be sent with order, and purchasers will please observe that if samples are required or replies asked to inquiries, a stamped addressed envelope must be sent, as we cannot undertake cost of postage.

THE British Bee Journal,

BEE-KEEPERS' RECORD AND ADVISER.

No. 492. Vol. XIX N. S. 100.] NOVEMBER 26, 1891.

[Published Weekly.]

Editorial, Notices, &c.

AN APOLOGY.

We have been requested to insert the following apology from the Editor of the *Journal of Horticulture*, which appears in the issue of that journal for Nov. 19th inst., p. 442:—

'We have received notice that the article which appeared on page 211 of the *Journal of Horticulture* for September 3rd, 1891, under the heading of "Punic Bees, and Those who Know Nothing About Them," and signed "A Hallamshire Bee-keeper," charges the editors of the *British Bee Journal* and *Record*, Messrs. Cowan and Carr, while purporting, in answer to an inquiry, to give all the information in their power about the so-called Punic bees, that they deliberately suppressed facts within their knowledge, and thus gave a false account of matters of interest to the readers of their journals. That the article also insinuates that Messrs. Cowan and Carr have some personal and unworthy motive for concealing facts which it is plainly stated they must have known.

'There was no mention of Punic bees in the *Record* of June, 1890, nor has there been any allusion to them either editorially or by any of its correspondents. There is also no statement in the *Record* for June, 1890, that Mr. Carr had a Punic stock in his possession, and he has never written anything about Punic bees.

'It is suggested that the appearance of the article in question might be due to an oversight, and not to any intention to injure any one. That is certainly the case, for it is far from our desire to make reflections on the reputation of those for whom we have never entertained feelings other than those of true respect, and we now desire to express our regret that the article referred to appeared, and to withdraw all the charges and insinuations therein contained.'

BRITISH BEE-KEEPERS' ASSOCIATION.

Committee meeting held at 105 Jermyn Street, on Wednesday the 18th inst. Present: T. W. Cowan (in the chair), Hon. and Rev. H. Bligh, J. Garratt, W. H. Harris, H. Jonas, and Messrs. W. B. Carr, J. M. Hooker, and R. A. Grimshaw, *ex-officio*. Letters were read from Mr. McClure, Rev. Dr. Bartrum, and the Treasurer, regretting their inability to be present. The minutes of the last Committee meeting having been read and confirmed, the Secretary reported that he had received a letter from Messrs. Newton & Co., Opticians, of Fleet Street, stating that they had in course of preparation various sets of lantern slides for the use of lecturers in giving technical instruction in agricultural subjects, and were desirous of including a set of such slides for illustrating bee-keeping. Resolved: That every possible assistance be given to Messrs. Newton & Co., and that the Chairman do confer with them in regard thereto. On the recommendation of the Educational Committee it was resolved to make third-class examinations of a more practical character, special attention being devoted to the nature and treatment of foul brood. It was further resolved that, in future, candidates for first and second-class certificates be required to display a fuller knowledge of the structure and anatomy of bees.

A special sub-committee, consisting of the Chairman, Mr. McClure, Mr. Garratt, Mr. Carr, and Mr. Grimshaw, was appointed to consider and prepare a syllabus of instruction for the use of lecturers engaged in giving technical instruction in bee-keeping under the various County Councils.

Mr. Grimshaw gave notice that at the next meeting he would move a resolution in reference to the practice of exhibiting, and the awarding of prizes to, goods which had been purchased and not manufactured by the exhibitor.

THE WORLD'S FAIR OF 1893.

The Atlantic Transport Company, operating a line of steamers between London and New York, has agreed to carry exhibits from London to either New York, Philadelphia, or Baltimore free of charge, except the actual expenses of loading and unloading. This generous proposition makes it possible for European exhibitors to have their displays brought to the American seaboard practically free of charge.—*American Bee Journal*.

MAKING BEE-CANDY.

In compliance with the expressed desire of several correspondents, we reprint the following recipe for making soft bee-candy for winter use :—

1. Use preferably a brass jelly or preserve pan, otherwise an enamelled iron or plain iron one. 2. Put in ten pounds of white granulated sugar at 2*d.* or 2½*d.* per pound, two pints imperial of cold water, and half a teaspoonful of cream of tartar. 3. Set on or hang over a brisk fire, and stir gently now and then till the sugar is all melted. This should require about fifteen minutes. 4. Almost immediately afterwards the whole will reach the boiling point, at first throwing up a deal of froth. The fire may be moderated or the pan withdrawn a little at this stage, when the foamy boil will settle down to a clear crackling one. This boiling should only occupy about ten minutes. 5. Now try a drop let fall on a cold surface, withdrawing the pan from the fire in the meantime. If the drop at once begins to set, so that in a few seconds it will draw out as a thread when touched with the finger, the mass is cooked enough. If not, boil a few seconds longer and try again. 6. Remove the pan from the fire, and set it in a trough of cold water. It may be left there for a few minutes while the moulds (flat or soup plates will do) are being set ready, each with a thin sheet of paper rather larger than the mould laid in. Returning to the pan, commence and continue to stir briskly until the mass begins first to get dim in colour from incipient granulation and then to thicken to the consistency of thin porridge. Then pour into the moulds, warming any remainder slightly to get it to leave the pan. This cooling and stirring process should take about fifteen minutes more. 7. Thus in about thirty-two minutes we finish the whole process, with the result that we have twelve pounds of candy from ten pounds of sugar. The cakes should set within an hour so as to be safely turned out of the moulds. When quite cold they should still be soft enough to be easily scratched into with the finger-nail, and to melt in the mouth with a soft grain. 8. Invert them over the cluster of bees with the paper left on, and cover up warmly. This may be done while they are still somewhat warm.

To the directions under No. 6 we would add the hint to 'work' the candy with the hands while cooling, in order to give it a 'buttery' consistency.

FOUL BROOD AND EUCALYPTUS.

The *Revue Internationale*, which has just appeared, contains a good deal of information about foul brood and the various remedies at present in use. Well-authenticated cases of cures with Naphthol Beta, naphthaline, and other remedies are cited. We have frequently alluded to the cure by means of Eucalyptus. This is not a new remedy, and mention of it appears in the *British Bee-keeper's Guide-book* ;

but there is an article in the *Revue* by M. Auberson which we think sufficiently interesting to translate for the benefit of our readers. M. Auberson has had considerable practical experience, and at one time had charge of a foul-broody apiary belonging to M. Bertrand, at Allerayes, while he was at the same time managing his own higher up on the mountains. So careful were the precautions taken by M. Auberson that he did not carry the infection from the one apiary to the other, while he effectually eradicated the disease from the foul-broody apiary. The following is the article alluded to :—

'Every bee-keeper who looks after a certain number of foul-broody hives will not fail to notice a great difference in the effect produced by the remedy employed, whether it be eucalyptus or any other. In some the effect follows the remedy quickly, and an immediate amelioration is soon followed by a complete cure. In others, on the contrary, the effect is slow in showing itself, and sometimes more than a year passes by without its resulting in a complete cure. A correspondent in the *Revue*, if I recollect rightly, calls the first mild foul brood, and the second malignant foul brood.

'I do not know if there are two sorts of foul brood; what I do know, having verified it frequently, is that in the same apiary and at the same time there are diseased colonies easy of cure, and others much more difficult.

'It is evident that if the bee-keeper wishes to succeed, he must treat differently the first from the second. The treatment must not be the same if the disease is of long standing or in its earliest stages; the remedy must be proportioned to the gravity of the evil. When there are only a few diseased cells, without any rotting, I simply pour some drops of the essence without counting them (it is better to place too much than too little) along the back wall of hive, in order to kill as few bees as possible. Sometimes, in response to the fear of the moment, I take the division-boards and pour a few drops of the essence on the inside surface, which I afterwards spread carefully with my hand.

'Every eight days I renew the dose of a few drops of the essence, and six weeks later, sometimes sooner, the colony is cured.

'If the hive is badly affected, and if there is already rotten brood, such a treatment is next to useless. In such a case I take a clean hive and floor-board, and impregnate with eucalyptus the interior of the hive, the floor-board, the division-boards, and then transfer all—combs, brood, and bees. I leave the foul-broody colonies their rotten combs, as this is the only handy means of disinfecting them. It is even a pleasure to see the gradual utilising of the combs. Three weeks later, during which time I have twice poured eucalyptus on the floor-board, I examine the new brood; if it exists in compact, healthy patches, all goes well. I simply again pour a few drops of the essence on the floor-board until the cure is complete.

'If the fresh brood still discloses some foul-

broody spots, I do not hesitate to kill the queen and to replace her by another taken from a healthy colony, and two frames with bees and furnished with healthy brood. Every fifteen days I spread the essence on the floor-board until the cure is completed. Every time that I have abstained from destroying the queens of refractory foul-broody hives, I have ended by having worthless queenless colonies. The combs only were of use for natural swarms.

'It is waste of time and money to undertake the cure of a weak foul-broody colony. It must be first strengthened by the addition of bees and healthy brood. The foul-broody hive found cured on 19th May continues healthy and strong. To make sure, I have three times during the summer poured in a few drops of the essence. In this hive I discovered the disease at the end of June, 1890, left in it all the comb, and treated it with the essence until it was prepared for winter. I do not touch foul-broody hives any more than I do healthy ones in the winter; but I never fail, when I prepare for wintering, the last thing, to pour a few drops of eucalyptus on the floor-board, and along the back wall of the hive of all diseased stocks, or those recently cured.

'Generally, in spring, two or three times I pour a few drops of eucalyptus into the hives that have had foul brood, although they appear cured. This is as a precaution. If I have to feed a foul-broody hive, I never fail to put the essence in the syrup.

'The colony of my neighbour, T., is still diseased. He did not wish to change the queen as I advised him to do, on the pretext that the queen would be replaced naturally.—C. AUBERSON, *St. Cergues, October 27th, 1891.*

BERKSHIRE BEE-KEEPERS' ASSOCIATION.

REPORT OF THE BERKS B. K. A. ON EXPERT WORK UNDER THE TECHNICAL EDUCATION GRANT.

GENTLEMEN,—Herewith is presented for your consideration a summary of the work carried out in the county of Berks by the experts appointed under the Technical Education Grant given by the County Council to encourage and forward bee-keeping in Berks.

The Central division, embracing the districts of Arborfield, Bradfield, Burghfield, Pangbourne, Reading, Sonning, Theale, Twyford, and Wargrave, were visited by Mr. T. Flood, who called on 226 bee-keepers, and whose return is 866 stocks, 459 of which are in bar-frame hives, the produce of which is 8350 pounds of honey during this year, 1891. The highest result is that of 300 pounds from four bar-frame hives belonging to Mr. Webster, Orts Road, Reading, making an average of 75 pounds per stock; as well as almost creditable and encouraging return of 125 pounds from two hives owned by Mrs. H. M. Wallis, Southern Hill, Reading.

As regards lectures, your expert thinks they

would be of little use in country villages, but that practical demonstration in the management of the bar-frame hive would be of great value to cottage bee-keepers.

The Eastern division, including Ascot, Binfield, Maidenhead, Sunningdale, Winkfield, Windsor, and Wokingham, was worked by Mr. W. B. Webster (first-class expert British B. K. A.), who visited 114 bee-keepers, and, from 544 stocks, gives a honey-yield of 6260 pounds, the highest return being that of 600 pounds from eight hives belonging to Mr. Head, of Winkfield. Foul brood seems prevalent in the Ascot district, but has been properly treated, and bee-keeping on the modern humane system seems understood in this part of the county, 335 out of the total number of stocks given being in frame hives, so that, on the whole, bees seem well cared for.

The expert considers that a lecturing tour among the country villages should be carried out, and would be well attended.

The Northern division, embracing the districts near Abingdon, Aldermaston, Faringdon, Hagbourne, Kingston, Wallingford, and Wantage, were visited by Mr. H. Fewtrell (first-class expert British B. K. A.), who called on 161 bee-keepers, and found 841 stocks, of which only 288 are bar-frame hives, the honey return from which was 11,023 pounds, giving the low average of thirteen pounds per stock. The improved system of bee-keeping seems very little understood here, and a third of those visited retain the barbarous custom of destroying their bees every autumn, one bee-keeper near Morton having destroyed thirty-five stocks out of forty to gain a little over 200 pounds of honey.

Against this we have Mr. Whittle, a member of the Berks Association at Lockinge, who from twelve stocks took 978 pounds of honey, 120 pounds of which came from one bar-frame hive alone. The expert has come to the conclusion that lectures in these districts would be of no permanent use, but that a visit with the bee-tent, and demonstrations with cottagers' own bees, accompanied by simple instructions, would be beneficial, seeing that large quantities of honey appear to have been wasted for want of knowledge on the part of bee-keepers as to the method of supering and increasing their stocks.

The Southern division, embracing the districts of Aldermaston, Farnborough, Hampstead Norris, Hungerford, East and West Ilsley, Kintbury, Lambourne, and Newbury, were visited by Mr. A. D. Woodley, who called on 227 bee-keepers, and whose return is 1174 stocks, including 505 bar-frame hives, and the total yield of honey from which is 10,861 pound; the highest average being that of 50 pounds per bar-frame hive, taken by the Rev. G. H. Rust, rector of Chaddleworth, near Farnborough. The modern system of bee-keeping seems well understood by many in this part of the county; but the expert desires to draw your attention to the fact that, except near the towns or where the Association is fully in work, bee-keeping has retrograded rather than advanced. As regards lectures, the expert does

not advocate them, except in large towns, where enthusiasm may be aroused; but recommends work of an itinerant nature, with the beentent to be thrown open at cottagers' flower shows.

On the whole, the reports in regard to the healthy condition of bees throughout Berkshire are better than the last wet season might lead us to expect. Foul brood has been treated successfully in two cases occurring in the central division; and although this disease prevailed pretty generally in the eastern division early in the year, it has been taken in hand, and stocks either destroyed or cured. In the southern division two apiaries are affected, and their owners have been warned as to the desirability of stamping it out. Your Committee is informed that, owing to this expert tour among bee-keepers generally, valuable assistance will be given to the British Bee-keepers' Association in their efforts to lay before the Minister of Agriculture statistics with a view to suppressing this disease.

Looking at the information given above, we have some valuable facts whereon to base future work. You will notice that in every case where the highest honey return is made, the bar-frame hive is in use. Then, again, near towns where personal contact with those versed in true bee-keeping is possible, we have a great profit and a better average result both in honey and bees, showing the value of practical rather than theoretical methods of spreading a sound knowledge of bee-keeping. Whether a few simple rules taking the place of the Board School arithmetical test-card would be advisable, and the visit of a travelling bee-van as your Committee suggested would benefit this industry, it is for you to decide.

But that great ignorance and cruelty with regard to bee-keeping still hold sway in our villages is certain, and if the welfare of a profitable home trade were not at stake, one could but experience intense humour at the following incidents occurring to those experts who carried out this work. An aged cottager, already referred to, the possessor of forty stocks of bees, who burnt thirty-five of his skeps to gain the grand result of 200 pounds of pollen-mixed honey, yet considered himself quite the greatest authority on bee-keeping matters generally. Another bee-keeper would 'have nought to do with new-fangled ways'—modern bee-keeping was too cruel for him—he put his bees out of misery when their work was done by means of the sulphur pit, while the enlightened bee-keepers prolonged the poor bees' lives for another year's work! Here we have no believer in the doctrine of the survival of the fittest. In some cases, where large weights of honey are known to have been taken, the owners have declared, 'Never was such a bad season; bees weren't woth the keeping;' but, being the possessors of a dozen flourishing-looking stocks, we are hard of belief, and think, like the miser of old, their master thinks, 'Twas bad luck to count what one had gained.' And now, gentlemen, I leave

it for you to consider the objects to which the remainder of the grant shall be placed.

It was ultimately decided to use the balance in hand in providing lectures, illustrated with slides, for some of the country villages desirous of the same, and the names of which had been submitted to the Committee.

The following tabulated form will show at a glance the satisfactory result that the sum of 1064*l.* 11*s.* 8*d.* is retained in the county; a lower estimate than the actual sum, as in many cases it was impossible to gain the exact return of honey taken, but it may safely be taken at 25 per cent. higher than the figures appended.

Division.	Bee-keepers	Stocks.	Bar-frame hives	Honey.
Central	226	866	459	8,350
Eastern	114	544	335	6,260
Northern	161	841	288	11,028
Southern	227	1,165	505	10,861
	728	3,416	1,587	36,499

R. E. CARR-SMITH, *Hon. Assist. Sec., B.B.K.A.*

SOCIAL GATHERING OF BEE-KEEPERS.

The Sixth Annual Dinner of the Wotton-under-Edge Bee-keepers' Association was held on Wednesday evening, November 11th, at the 'Star' Inn. The society has the interest and the encouraging presidency of the Countess of Ducie. V. R. Perkins, Esq., is chairman of the executive. W. Heath, Esq., presided, and was supported by Rev. — Upstone, and Messrs. Lewis, Vigor, Penly, &c. Altogether forty bee-keepers assembled, and a most enjoyable evening was spent. The room was appropriately decorated for the occasion with diagrams of the physiology and anatomy of the honey-bee; the motto, 'May we all thrive like bees in their hive,' occupying a conspicuous place at the head of the table. After dinner the usual loyal toasts were honoured. 'The clergy and ministers of all denominations' was afterwards given, to which the Rev. — Upstone responded. The Chairman then called on the Secretary to read the annual report. In complying the Secretary said the past season had been a fairly good one—better than 1890, a few swarms being reported by the 10th of May, but they were not general until the beginning of June. Bad weather unfortunately predominated, and if the bees had adopted the 'eight hours' day,' it would have been a poor look-out for their owners, because of the few days on which they could work. Ever since the formation of the Association monthly meetings had been held. In August last their fourth exhibition took place in connexion with the flower show, and was the most successful yet held. The Rev. Mr. Davenport, who acted as judge, was highly pleased with the display. Twelve and a half hundredweight of honey

was staged, ten hundredweight of which was gathered in the neighbourhood. The silver medal for the best twenty-four one-pound sections of honey was taken by Mr. C. W. Workman, of The Ridge. The Society now numbers thirty-four members. The Secretary further impressed the pecuniary benefit resulting from modern bee-keeping by stating that the Rev. Canon Procter, a clergyman seventy-five years of age, has sent this year from Ireland to a firm in London 1000 one-pound sections of honey, and about five hundredweight of extracted honey. The value of honey imported into the United Kingdom had increased from 23,609*l.* in 1888 to 41,321*l.* in 1890. Mr. Perkins referred to the valuable help rendered by those experts in bee-keeping who understood what to do and how to do it. Were it not for them they would often be in a sorry plight. In this connexion he mentioned the names of Messrs. Brown, Hulance, and Griffin, the second and third-class experts. On the health of Mr. Perkins being given, that gentleman said Mr. Workman's success refuted the idea that bees could not be worked with profit on the hills as well as in the vales, for from the highest point on the Cotswolds good returns had been secured. Mr. Roach said he would be pleased to offer two hives for competition or otherwise; the offer was gladly accepted. The proceedings closed with a vote of thanks to the Chairman.

BEE-CULTURE IN SOUTHERN CALIFORNIA.

(Concluded from p. 531.)

I will here state for the benefit of those not familiar with the record system in vogue in Southern California, that one stone means 'wants attention'; two stones, 'wants attention badly'; three stones, 'wants attention *very badly*,' and so on, the more rocks the more it needs attention. One stone and one handful of sand (or mud, according to the weather) signifies 'queenless,' and if a hive gets a stone and one pile of earth early in the season, it is likely to remain there all summer, for bee-men in this section 'have no time to fool,' but when the condition of the colony demands it, the one stone and one sand pile are superseded by two each.

I also have the honour of presenting to the world another feature in honey production, which has heretofore never been made public, relating to comb honey, and which I have named the 'expansion method.' I do not know how long it has been in use, nor how extensively it is practised. However, be that as it may, I have noticed an apiary of more than a hundred colonies, this season, being managed in this way, but owing, perhaps, to a partial failure of the honey crop of California, the result was not what it might have been.

The *modus operandi* was as follows:—Being in need of combs to 'upper story' some hives run for extracted honey, the supers were removed from the comb-honey hives, and two or

three combs of honey taken out, and frames with foundation starters put in their stead, and the sections replaced upon the hives.

I wish to caution beginners against attempting this plan. It is intended only for the advanced class of apiarists, and only such should attempt having combs for 'upper storying' built below partly finished sections during a slow flow.

An apiary of 160 colonies was given into my charge after the swarming season had opened and honey was flowing, out of which thirty were queenless, of twelve of which laying workers had possession, and the remainder of the apiary corresponded beautifully with these thirty colonies—all being in hives which I consider an embodiment of all the ills that ever afflicted a beehive.

Notwithstanding the opinion of many apiarists that 'it matters but little what kind of a hive we use,' I consider the question of hives, to one starting in the honey-producing business, of vital importance; and my advice to beginners, after nine years' experience, with perhaps hundreds of hives, in various climates, from the Georgian Bay to the Carribean Sea, and from the Atlantic to the Pacific, would be: Do not invest in hives until you have learned *positively* what the requirements are, and then adhere strictly to that which fulfils these requirements. In beehives, as with everything else, there is a *right* kind (different styles that are *right*), but there are many styles that are opposite, or *wrong*, and a hive that is wrong robs the business of all pleasure or satisfaction.

But this letter was not intended to discuss hives, and for lack of space I will defer further remarks until a future time, but in conclusion, would ask why is this slipshod, semi-barbarous condition of affairs tolerated by so many Californian producers, many of whom are Eastern men that would not endure such crude, awkward, wasteful sights for a single day in the East, yet here they smile and apologise by saying, 'Oh, that is California style.'

I saw no better specimens of old-fashioned, Simon-pure 'bee-hungling' among the negroes of the West Indies than I have seen in Southern California, by men who own hundreds, and some thousands of colonies, in movable-frame hives.—H. E. HILL, in 'American Bee Journal.'

THE LAST OF CYPRIAN BEES.

Only eleven years are past since Jones and Benton left America in search of the Eastern bees, and imported hundreds of the yellow beauties into Europe and America; and now I should say it is next to impossible to have one single pure Cyprian. Isn't this a curious fact? Many parties have been writing to me to have Cyprian queens; but up to last fall Mr. Benton had the choice; and, as I am no queen-breeder, I almost always directed to him. Although Cyprus can be reached from Jaffa in twenty-four hours, I never thought it would pay to go

there myself; but I wanted a little bit of fresh sea-air. The trip to Cyprus and back was supposed to take four days. Up coast the steamer passes Cæsarea Palestina, mentioned in Acts, where St. Paul was tried before King Herod and Felix, and where he appealed unto Cæsar. Only ruins of bygone beauty mark the place, and a Bosnian colony of Mohammedan emigrants are now building up into a new Cæsarea.

After six hours by sea, the steamer anchors in the Bay of Acre, at the foot of Mount Carmel, where a German settlement is flourishing in all but bee-keeping. Some have clay cylinder hives, others box hives, and some Dathe, Dzierzon, and other German hives. They average very little honey, owing to want of pasture in the immediate vicinity of the town of Haifa, and the want of knowledge. Mount Carmel itself is beautifully covered with melliferous plants, as sage, thymes, and others. In one of the Russian-Jewish refugee colonies on Mount Carmel one of my scholars is putting up an apiary, after the Langstroth system—our hive—and seems to have done tolerably well.

Going up the coast, we passed Tyre and Sidon by night, and morning found us at the foot of Mount Lebanon. Two days were lost at anchorage at Beyrouth. A gale would not allow the steamer to discharge the goods; and when, on the morning of the third day, we arrived at Larnaca, in Cyprus, the steamer was gone, and I was told that, before a fortnight was over, I could not go back again. What a dull hope, to be walking about a small town, with the prospect of enjoying its crumbled walls and base Cypriotes for a fortnight, while the bees in Palestine are in vain awaiting me to take them to pastures new! I then concluded not to leave home again, at least not in May, across the sea, when work is pressing. How often did I hear about this 'abode of the gods!' but the Turks have done their part in destroying nature and art. It is not now to be envied. The position is good; the climate, like all Mediterranean countries, is haunted with fever in the lowlands; but, besides, this, locusts have been roaming over the land, and destroying what little green the numerous goats left, which themselves have been gnawing the young growth, preventing, in connexion with the Turkish misrule, the restoration to its former charms. The British Government is trying to restore the island; but it certainly will be long before the inhabitants will awake from their drowsy nap. And right here friends Jones and Benton first brought American ideas and bar-frame hive: and the only thing I found here was two two-frame nuclei in the house of Mr. Derwishian, a graduate of Benton's school. The day before I arrived, another of Benton's scholars had gathered every movable hive and steered into Egypt to improve the Egyptians, as I understood; but not having seen him I was sorry to find I had come here to go back again without taking even a Cyprian queen with me.

The two two-frame nuclei at Mr. Derwishian's were as cross as cross can be. Smokers and

veils of enormous size availed nothing. I never saw such a bad lot, even in Palestine, except when the camels had upset quite a number of hives, and they were pitching at us in fury. Mr. D. attributed this behaviour to Mr. S. G.'s rough handling the day before, or three days before. Mr. D. insisted on working them without smoke, which was just the right thing to keep us at a distance, and I could not enjoy the pleasure of seeing the queen. Since I came back the queens have mated, and I received one here which is developing nicely, with very nervous bees. Mr. D. has sold all his bees to Mr. L., who started with them to Egypt, and he himself will leave the island, thus leaving nobody to care for Cyprian queens or bar-frame hives.—P. H. BALDENSPERGER, in 'Gleanings.'

Correspondence.

The Editors do not hold themselves responsible for the opinions expressed by correspondents. No notice will be taken of anonymous communications, and correspondents are requested to write on one side of the paper only, and give their real names and addresses, not necessarily for publication, but as a guarantee of good faith. Illustrations should be drawn on separate pieces of paper.

Communications relating to the literary department reports of Associations, Shows, Meetings, Echoes, Queries, Books for Review, &c., must be addressed only to 'The Editors of the "British Bee Journal," 17 King William Street, Strand, London, W.C.' All business communications relating to Advertisements, &c., must be addressed to Mr. J. HUCKLE, Kings Langley, Herts (see 1st page of Advertisements).

** * * In order to facilitate reference, Correspondents, when speaking of any letter or query previously inserted, will oblige by mentioning the number of the letter, as well as the page on which it appears.*

IN THE HUT.

'Perhaps the dust may make it once more dry.'

(Old Epigram, slightly altered.)

[854.] Generally, at this time of year, I have to complain of the *moisture* (this is putting it in a mild form) finding its way into the hut, but I managed to find a cure for it, quite by accident. A large tin feeder on a shelf was regularly full of water, although I could not discover the ingress of even a drop through the roof, well felted and tarred as it is. Decision:—There let it be, and empty oft. Now, alas! there is a plague of dust, that inevitable accompaniment of the iron horse that uses the place as a winter stable, for sad changes have come over the spirit of the place.

Gone are the huttites from the teetotal hut (I would that, as regards its capacity for taking in water, it had been a total abstainer, instead of a sort of locomotive engine-tender). Gone, too, are the luxurious Turkey mats that once covered its seats, now occupied by section crates in many tiers, lachrymously in keeping with the hut's present chief characteristic. Why, the very combs of heather weep if left for many hours in such a home of dismal damp! Rusted and neglected is the lamp that used to glow a tender welcome of such asphyxiating fumes of carbonic acid gas as on one occasion nearly lost your columns 'X-Tractor.' Do not, unkind

cynic, say 'that were a consummation devoutly to be wished,' or I should rejoice—

'Thy praise or dispraise is to me alike;
One doth not stroke me, nor the other strike.'

You must bear with me as I ramble on in my own way, not *in* the hut, if of it, but by my ain fireside. Extractor and smoker combined (a hint, appliance-makers—begin on combinations!), taking in along with my smoke-cloud a curious compound of dewdrops (for my bronchitis) by one John Long (or Long John), a Scotchman, who is reported to gather the same from Ben Nevis. For my own part I am of opinion Ben could dispense with many more of such drops than he does. I found his neighbourhood wet enough twenty years ago—there were many more drops than were dew; in fact, these were often falling due—fell due on the fells, so to speak.

It's not a far cry to Loch Awe from Ben Nevis, but it is from him to gingerbread (or 'Parkin,' as it is called here). Parkin made of oatmeal, treacle and honey half parts instead of all treacle, is a distinct improvement, especially when made with heather honey, as tasted by me at a friend's house the other night.

I wonder what it is makes bees set up a joyful roar in the darkness without any apparent rhyme or reason, settling down to absolute quiet in just as mysterious a manner. Then one bee again buzzes, and the chorus gradually swells up into a curious *crescendo, decrescendo*. Rooks in a field, ducks on a pond, and many gregarious animals (not excepting man) seem to like to get up an occasional chorus. Perhaps this is the very first step in language growth, *i.e.*, imitation. We know the bee is a great imitator. Take a hole in a quilt, for example, no sooner is one bee out than a procession is got up; look, again, at the instant imitation of a swarm running into a hive, and of bees in fanning.

A friend of mine, an old bee-keeper, not a young enthusiast (or we should pass on with the usual self-complacent smile), told me that the very best of his stocks this year, the one which worked hardest and gave him most honey, was one he made pets of by taking a single teaspoonful of syrup and putting it on the flight-board. He would sit and watch it all taken in, and said they quite expected the usual evening treat. Of course, pets are out of the question—it is a pure case of stimulation by slow feeling.

It is a great pleasure to a man to make a tour of his outbuildings in the evening, and think how comfortably prepared for the night are all the so-called dumb animals in his charge, and it must be equally gratifying to the bee-keeper to contemplate his hives at this time of the year, and think how well they are provided with stores, tucked in with warm quilts, stopped off with well-painted and weather-proof hive covers, the whole well anchored down with cord and brick, or some other device. It is no small pleasure to scratch one's own back when the comfort of others has been seen to. One John Horner was an adept at this business in his

youth, only it was his own comfort that prompted his self-gratulation.

As years roll on we get still stronger in our opinions, firmer in our convictions. One of these is that the let-alone principle, as far as regards the brood nest, is much the best, of course with exceptions, such as looking through for queen-cells before returning a swarm, or the spring inspection for brood. I am convinced that more mischief has resulted from excessive manipulation than from all the other evils the bee-keeper is heir to put together. There would be a falling off in the consumption of remedies for foul brood if there were a falling off in the frequency of looking for the queen and spreading brood.

To-night there is to be a mixing of honey and acid for bronchitis, and also a tasting of mead. A certain welcome mead-tasting is always a grateful, pleasant reminiscence in the memory of—X-TRACTOR.

SOME FOUL-BROOD NOTES.

[855.] I have, lying before me, a piece of comb, which, before I destroyed its symmetry, consisted of a patch of about twelve square inches of sealed brood, very badly affected with *Bacillus alvei*, as the sequel will show.

One by one I uncapped the cells and found there were—(1) 103 small larvæ, looking like English drops of dirty brown jelly, and showing, when touched, a decided ropiness in consistence; (2) about fifty other larvæ larger and further advanced toward pupa-hood, but all unmistakably foul-broody; (3) over a hundred fine, healthy, pearly white larvæ of various ages; (4) a few perfect bees ready to cut their way out.

Now, will you please say, was it right to cut out this and two similarly sealed patches, and so destroy at least 300 healthy bees? If not, what was the best course to pursue? I, perhaps, ought to state that the stock whence the combs were cut had been well 'fed up' with syrup, medicated with Naphthol Beta.

In going through my self-imposed task (for task it was, and a very disagreeable task, too, *phew!*), I was very much struck with the fact that the diseased cells occurred either in groups or in lines, so that an isolated case was quite exceptional. Necessarily the cells of healthy brood exhibited a like contiguity. Surely this has a meaning, and, if so, what is it? Does it throw any light on the method the contagion is conveyed and spread? Clearly, in the case under consideration, the disease was not in the egg, and as clearly, too, it was not 'in the air,' or, in other words, the germs were not wafted to their destination, or they would not have been so partial in their distribution. Contagion through contact with legs and antennæ of nurse-bees fails to account for the peculiarity, so that food, and food alone, must have been the vehicle of infection.

But, it may be asked, how comes it that the poisonous stuff was omitted in the case of healthy groups? In reply, it may be observed, that if a

nurse-bee, capable of imparting disease, be supposed to feed the grubs of a group in her immediate vicinity without wandering about at random, the peculiarity is accounted for. Of course, this argues that infected bees must be few and far between; but that, they may very well be, when it is borne in mind how very few larvæ when once attacked attain full growth. What think you, Messrs. Editors?

Again, as I plodded on, I found that concavity and convexity of caps gave no certain intimation of what was beneath them, for brood, healthy and the reverse, was found under both kinds in about equal quantities; the only reliable symptoms that there was 'death in the pot' were the punctures made by the bees themselves.

This is a matter for serious consideration, for I have no doubt that many a patch of foul brood has eluded detection through neglect of more careful examination than cursory inspection can give.

Looking around, I have come to the conclusion that the noisome pest has come to stay, and that the best thing bee-keepers can do is (a) to give up all idea of ever being free from it, and (b) to adopt some method of producing healthy brood in larger numbers than unhealthy. This may be done, I think, by keeping the bees *constantly* supplied with medicated soft candy from February to June. What think you, Messrs. Editors?—E. B., *Northants, November 16th.*

[Foul brood, like other infectious diseases, is uncertain in its attack, and it may as well be asked why one person is stricken down with typhoid while others of the same household escape, as try to account for a portion of the brood hatching out in good health, while that in adjoining cells dies; besides, it is not at all certain but that much of the brood which looked 'pearly white' might yet have perished before reaching the pupa stage, and, therefore, to base a theory on such indications as have been observed in this case would not be reliable. Few persons have seen more specimens of foul-broody combs than ourselves, and we have not noticed anything in the direction pointed out by our correspondent.—Eds.]

GRANULATED HONEY—AVERAGE YIELDS.

[856.] In your footnote to my letter on the above you do not appear to exactly understand me in reference to candied honey. The statement I made reads thus, '*As a rule* the better the quality the sooner it will granulate,' showing thereby that I was fully alive to the fact that there are exceptions to that rule; but what I had in mind at the time was more particularly one kind of honey.

If you take two lots of, say, clover honey extracted at the same time, and placed in one and the same position, and find that one lot granulates while the other remains liquid, I think you will agree with me that the lot which granulates is the ripest, and, therefore, the best quality of the two. I quite agree with your remark that we should take special care to explain to our customers the way in which granulated

honey can be liquefied. That is what I always do, and which I intended to have mentioned in my letter, but omitted to do so. I question, however, whether any of my customers ever take the trouble to do it. The hundreds of pounds of candied honey that I have sold during the last fifteen years, and the frequency with which I am asked for honey that is set, proves that granulated honey is highly appreciated, and that there is no need, in my case at all events, to go to the trouble of liquefying it.

While thanking you for your reply to my question *re* average yield of honey per hive, I may add that I was more anxious to ascertain what *is* done than what *should be* done. Personally, I reckon the number of hives that I possess in spring, and if I purchase a swarm and treat the same in such a manner that it gives a surplus, that also is counted in as a stock. But I am by no means prepared to assert that my method is a correct one. The question of 'average yield' is to my mind a somewhat vague one, in other words, there appears to be no universal system of arriving at the average yield of honey per hive. You say that the correct thing to do is to calculate on the full number of stock in hand when season begins. Quite so; I fully agree with this. But then, sir, the important question arises, When does the season begin? Unless a bee-keeper's year differs from all other years, it commences just where it finishes—that is to say, where one year ends another one begins. That being the case, November is obviously the first month in the bee-keeper's calendar. Now supposing I at the present time have thirty stocks of bees, and that during the winter and spring I lose ten stocks, reducing my number to twenty, with which I commence the *honey season*, and from which I get ten swarms and 300 pounds of honey, at the end of the season (October), I might say I have got an average yield of fifteen pounds of honey per hive, and ten swarms to the good in addition. I might also say I have finished the year with exactly the same number of stocks that I commenced with, and have got an average yield of ten pounds of honey per hive. Both statements from a certain point of view would be correct. It is equally true that from another point of view each statement would be incorrect.—A. SHARP, *Huntingdon.*

P.S.—Since my remarks on candy feeding, which appeared in the *Journal* a month ago, I have been asked by a number of bee-keepers what kind of candy I use. I make my candy according to the recipe given by the late Mr. Raitt. Will you, for the benefit of those who have not the back numbers of the *Journal*, kindly reprint the said recipe?—A. S.

[If average yields are calculated on the simple lines laid down in our footnote on p. 529, there should be no vagueness about the matter, unless we confuse the word 'season' with *year* as our correspondent does. Of course, the new year begins when the old one has ended, but the *bee-season* can hardly be said to begin on the 1st of January.—Eds.]

MORE OBSERVATIONS BY AN OUT-SIDER.

[857]. I am indebted to you for having put my previous letter *in extenso* before your readers, and gratified by the free comments you make on it; and although I do not feel disposed to 'relinquish my private capacity as a critic,' I shall endeavour, as far as I can, to avoid more hostility to the 'labourers inside of the organization' than is necessary for argumentative purposes.

You are of opinion that my query relative to foul brood and experts' certificates is a 'gratuitous and rather unkindly fling' at the value of the latter. Such was not intended; but if my observations admit of that interpretation, I may, with equal justice, complain of the manner in which you discount my knowledge of the art of bee-keeping by hanging a tale on to my unreserved confession of ignorance in one particular; but as you introduce me to your readers as 'our friend,' I will not impute to you the slightest want of generosity towards me—quite the reverse.

You accentuate the importance of 'decisive steps for the extirpation of foul brood' being taken, and the necessity 'that a person claiming to be an expert' should 'make himself acquainted with the nature and characteristics' of that disease. To this I make no demur; but unfortunately for the realisation of that ideal, the majority of British bee-keepers have not had a collegiate education in apiculture, and they can hardly be expected to know more than experience has taught them in their own apiaries, supplemented by information obtained by perusing apian literature; and in connexion with this matter Mr. McClure's letter, (849, p. 526) has led me into a train of thought which, considering the importance of the subject, I respectfully ask your co-operation in laying before your readers.

It seems that the L. & C. B.K.A., in taking upon themselves the work of giving technical instruction in bee-keeping in Lancashire, did, in point of fact, pledge itself to engage a lecturer able to deal with 'that virulent, but at present little understood, disease called foul-brood.' The recommendation of suitable lecturers was left to the Educational Committee of the B.B.K.A., and, on the Committee's recommendation, Mr. Harbordt was appointed. I am hardly likely to be in error in assuming that this gentleman is the person of that name who deals in goods for bee-keepers' use, and whose place of business is in Liverpool. Mr. Harbordt publishes a trade catalogue, a copy of which now lies before me, and which was handed to me in his establishment about the middle of July last, either by himself or his representative, for I do not happen to know him myself. In the 'foul-brood section' of the catalogue to which I refer the following prefatory remarks are made respecting remedies he is prepared to supply for the treatment of the disease:—'The following chemicals are recommended for the treatment of this

scourge; but, as I have so far been free from the disease in my own apiary, and as I carefully avoid—for obvious reasons—coming into contact with infected stocks, I cannot speak from experience on this subject.' I am not able to reconcile Mr. Harbordt's own statement with the result of his examination by the Committee, except on either one or other of two hypotheses: Mr. Harbordt's knowledge of the foul-brood malady is purely theoretical, or else he has made himself practically acquainted with it, in all its bearings, in a surprisingly short space of time. The weight of evidence is with the former, for his statement implies a reluctance on his part to investigate the disease for fear of importing it into his own stocks, and this reluctance is quite justifiable, his own private interests in view. If Mr. H. can elucidate the matter without compromising himself, he should certainly do so, and in any case the B.B.K.A. should clearly define what they mean by a 'thorough knowledge of foul brood' on the part of a candidate endeavouring to obtain an expert's certificate.

Now, supposing my bees were visited by the disease—which I hope will not happen—I should not be long in detecting something amiss, and if the symptoms corresponded with the descriptions of foul brood in the text-books, I should immediately take the matter in hand *myself*, and administer one or other of the prescribed remedies, and in doing so I should be acting in accordance with a very common practice among stock-masters, of doctoring their own animals without calling in the aid of the veterinary surgeon, and in the case of bees I have not seen any published statement that bee-keepers are not able, if so minded, to do well enough without the professional aid of a certificated expert; at any rate, if I found such to be the case, I would give up the pursuit to those gentlemen who manage their bees by deputy.

My want of information as to the existence of the disease in this county is not surprising when, as you state, Secretaries of Associations, who are supposed to be 'in the know,' fail to report it where you know it to exist; and I take comfort in my 'woeful unconsciousness of what is going on around me' from the fact that there are 'insiders' in precisely the same predicament.

I fear that this letter may be thought wearisome by reason of its length; I therefore reserve what else I have to say for a future occasion. In the meantime allow me to subscribe myself—ALFRED DONBAND, *Whitby Heath, Chester, November 20th, 1891.*

[The gist of the above communication, we take it, has reference to the appointment of the lecturer to the L. & C.B.K.A., and we are sorry that our correspondent again indulges in what we must continue to call an 'unkindly fling'—this time at the gentleman who has been appointed to that important and honourable position. There is no need for our entering into the various arguments adduced in support of the particular position our correspondent elects to occupy in bee-matters; we

content ourselves by again remarking that criticising the actions of those who are—according to their lights—working for the cause will not help it on much. For the rest, it may be observed that the Committee of the B.B.K.A., after hearing the several candidates who appeared before them, felt themselves justified in approving of—indeed, they were not asked to ‘recommend’—the gentleman referred to, as possessing a ‘full knowledge of the nature and characteristics of foul brood and of the means of curing it.’ More was not asked for, and to have made it a *sine qua non* that the candidate should have personal experience of it in his own apiary would be absurd. The same observations will apply in the examination for experts’ certificates.—EDS.]

THE LAW OF BEES.

[858.] Here is a matter connected with the advancement of bee-culture which I should be glad if you would take up. In the case *Sheppard v. Cottage*, of which particulars are given in *B.J.* of October 15th, p. 462, the judge would, I feel satisfied, have given a definite decision at once in favour of the complainant, and have thus made a precedent which would have established the right of any bee-keeper to follow his swarms, if evidence of the old law had been produced. Would it not be well to endeavour to ascertain whether the old law is extant, and, if it is, publish the necessary references in *B.B.J.* for the benefit of bee-keepers in general?—F. H. MEGGY, *Chelmsford*.

[We shall at all times be glad to publish anything usefully bearing on the point referred to by our correspondent; indeed, since the case mentioned was decided full particulars were printed on p. 487 of *Bee Journal* for October 29th of ‘Another Bee Case,’ in which the well-known dictum in Blackstone’s *Commentaries* was fully quoted by his Honour Judge Caillard in giving judgment. We may say, however, that if any of our readers, possessing legal knowledge, can add anything to what has already appeared tending to make the law of the case clear, we shall be very pleased to make it public for the benefit of the bee-keeping fraternity in general.—EDS.]

NOMINAL ONE-POUND BOTTLES.

[859.] I am glad your correspondent (789, p. 432) has struck the key-note against the very bad practice of putting up and offering for sale honey in short-weight bottles, called ‘nominal’ one-pound. Truly they are *nominal*—which means in name only—and the public are becoming aware of the swindle practised upon them, for this year I have been repeatedly asked, ‘How much does this bottle contain?’ which soon brings forth my reply, ‘Sixteen ounces;’ but such questions, if truthfully answered and with nominal one-pound bottles, often mean a reduction of twopence per bottle. I find there is a lot of trickery in this ‘nominal’ business, for dealers offer them as pound bottles as long as they can, and when this dodge is found out they offer them at so much per bottle. To my mind, the principle of this nominal one-pound is

dishonest all through, and, if not checked, will have a bad effect upon the sale of British honey.

The writer of the special query (809, p. 467) must have been quite aware of this when he drew attention to nominal pound bottles on the Exhibition tables. The opinion of our editors and also that of some of your numerous correspondents upon this question would be valuable.—BEE JUST, *Frodsham, Cheshire*.

[Without entering into the question of the honesty of selling as pound jars of honey vessels containing less than that quantity, we must draw our correspondent’s attention to the fact that in show schedules, at least, the word ‘nominal’ is used in order to get over the difficulty of jars, sections, &c., being staged which are either under or over sixteen ounces, and so provide against possible disputes among competitors regarding exactness in weight. Besides, if manufacturers turn out jars which hold full sixteen ounces of honey, they will hold a greater weight of other products for which they are intended of less density than honey, and *vice versa*. In this way many of what are called one-pound jars will hold eighteen or nineteen ounces of good honey; so the argument cuts both ways. It would seem as if the custom of selling honey at so much per jar is a fair way of meeting the difficulty, because in places where a full pound jar is expected for about tenpence or a shilling—and the retailer’s profit is deducted, besides the cost of the jar itself—the producer has a very low price indeed per pound left for his honey, when the labour of jarring, labelling, &c., is considered.—EDS.]

BEES IN NORTH WEXFORD—HIVES IN THE FLAT.

[860.] Our season here has been a bad one, owing, I suppose, chiefly to the wet. Not much honey was got in this district in consequence. I had two frame hives and two skeps; the latter each swarmed twice. I took thirty-nine sections from the frame hives, but the skeps gave no surplus, and if can manage to pull them through till next year I will have them in frame hives.

I quite agree with your correspondent (835, p. 503) as to sending out hives in the flat. To get hives over here from England is expensive, and I should think that half-carriage could be saved by it. Cottagers around here nearly all use skeps, and if you ask them why, the answer is ‘for cheapness;’ so anything that will cheapen frame hives will bring them more into use.—JOHN BALL, *Co. Wexford*.

HONEY AVERAGES.

[861.] In my communication (839) I scarcely thought it worth while to insert the number of hives, because I am a bee-keeper in so small a way that I only wished to induce others to give us their experience—not to put forward my own results as an example. However, the number of hives was as follows:—1885, four; 1886, four; 1887, six; 1888, seven (only three had any honey); 1889, seven; 1890, seven; 1891, seven. I have always taken, for the average

the number of hives at the beginning of the honey season. I have had very few swarms, most of which I have given away, and those I kept were not counted the first year. Of course, in striking an average I have counted all hives except swarms, though it was only in 1888 that any failed entirely. My plan is also to put down the *nett* weight of the honey; *e.g.*, I do not reckon a section a pound without weighing it, and subtracting the weight of the wood. As I said before, I do not think my limited experience is worth this letter, and I only send it in response to your own footnote and the remarks of Mr. Sharp (852).—L. B. BIRKETT.

FOUL-BROOD LEGISLATION.

[862.] I for one should very much like to see some law made dealing with this matter, as I have a neighbour who chooses to be mean enough to keep a foul-broody hive in sight of my own since July, and in August one of my own stocks caught the infection. Of course, I at once destroyed my diseased hive, and have tried to show my neighbour the risk to myself and others in refusing to destroy the foul-broody hive; but he says, 'They are no good to me, but I don't see why I should destroy them to please other people.' Can you do anything to help us bee-keepers to get rid of this trouble, the reality of which I can vouch for?—G. FAIRS, *Munham, Chichester*.

[The above is, no doubt, a very hard case, and we shall preserve the particulars of it for future use; but, until the compulsory powers now being asked for are granted, any one who is so selfishly unmindful of inflicting injury on his neighbours as the individual referred to can do so with more or less impunity. If persuasion has no effect, ask what price he will *sell* the diseased hive for (that you may burn it) and let us know.—EDS.]

Queries and Replies.

[456.] *Sending Bees by Post*.—I enclose two bees:—*a*, I bought from a dealer as a cross between Ligurian and Carniolan; *b*, as a pure Ligurian. To my eyes they seem the same. Is there any difference? and, if so, kindly explain so that I may be able to distinguish them in future.—A. STUBBS, *Somerset*.

REPLY.—If the bees looked 'the same' to one who saw them intact, they look still more alike to us, seeing that both were smashed out of all shape in post. Bees should always be sent in boxes.

[457.] *Foul Brood*.—I send a piece of comb which I took out of a hive belonging to a clergyman who has just come into our neighbourhood. He sent for me to put the bees right for winter, and I thought they were in a bad state. There are three stocks, all weak—about four seams of bees each. All appear to be diseased, the combs being like the piece sent. I did not

disturb the bees more than necessary, and though I told the owner I thought them diseased, he thought I was wrong, and so I send to you to ask is it foul brood or not, and what would be the best course to take? I have twenty-three colonies packed away for winter in splendid condition, for I believe I have got rid of the disease among my own bees, so it makes me rather uneasy, my apiary being only about 300 yards from this gentleman's. I will write again and let you know about my own. I have used naphthaline, and fed up with syrup medicated with Naphthol Beta.—J. H. P., *Wakefield*.

REPLY.—There is no doubt about the comb sent being affected with foul brood.

THE SWARM THAT DESERTED ITS HIVE.

That beautiful swarm,
It has all gone,—
What a pity!

Drones, bees, and queen,
Nothing to be seen,—
What a pity!

No cheerful hum to greet
When you are on your beat,—
What a pity!

The hive out there to rot,
Perhaps to be forgot,—
What a pity!

Perhaps one summer day
In May, before the hay,
Another song we'll sing,
Without this doleful ring,
And not a pity.

A. C. J. P.

Notices to Correspondents and Inquirers.

Letters or queries asking for addresses of manufacturers or correspondents, or where appliances can be purchased, or replies giving such information, can only be inserted as advertisements. The space devoted to letters, queries, and replies, is meant for the general good of bee-keepers, and not for advertisements. We wish our Correspondents to bear in mind that, as it is necessary for us to go to press in advance of the date of issue, queries cannot always be replied to in the issue immediately following the receipt of their communication.

All queries forwarded will be attended to, and those only of personal interest will be answered in this column.

T. A. F.—We think that No. 1 is pure cane, and would use it for bee-food in preference to No. 2.

H. WITT (Berks).—Bee sent is only a worker.

BUSY BEE (Sunderland).—*Sugar for Bee-food*.—*Long Hives*.—1. No sugar, except pure cane, is, in our opinion, suitable for bee-food. 2. A hive holding thirty frames in one story is altogether too large. A queen would be very unlikely to occupy more than a portion of the hive at any one time.

Special Prepaid Advertisements

Situations, Publications, Bee Plants, &c.—Twelve words and under, Sixpence: for every additional Three words, One Penny.

Trade Advertisements not inserted under this head.

WALLFLOWERS.—Fifty Plants, 1s. free. Arabis, 1s. per dozen. Address **NORMAN PARKIN**, Blakenhall, Wolverhampton. L 51

WANTED.—Extracted Honey (Granulated) in bulk. Address **W. RUSHTON**, Bee Farm, Bedford. L 51

HONEY WANTED.—Bulk. State lowest price. Address **W. GRIFFIN**, 251 Oxford Road, Reading. L 81

FOR SALE.—Fifteen Stocks of Black Bees in Par-frame Hives. Fed up for Winter. No Honey taken from brood-nest. £1 each, or £11 for the lot. Address **R., Stokeknoll, Bishopstoke.** L 85

FOR SALE.—Sixty Sections of Comb Honey, and 40 lbs. of Extracted. Good quality. Price £3 5s. Deposit System. Address **W. CHOLDROFT**, Hare Street, Buntingford, Herts.

FOR SALE.—Beautiful Clover Honey, packed in 10-lb. Tins, 1s. per lb., carriage paid. Address **THOMAS CHARLES**, Caerswall, Much Marcle, Gloucester. L 86

CROCUS for EARLY POLLEN.

A FEW Thousand Fine Sound BULBS, to Clear, at 5s. per 1000. Address

P. HARBORDT,

50 GREAT CHARLOTTE ST., LIVERPOOL.

EXTRACTED HONEY WANTED.—One or Two Cwt. of Good Quality. Sample and lowest Cash price to **W. DRINKALL**, Market Street, Lancaster. 3305

NEW EDITION NOW READY.

21st Thousand.

THE BRITISH BEE-KEEPER'S GUIDE-BOOK.

By **THOS. WM. COWAN, F.L.S., F.G.S., &c.**

Revised and enlarged.

Almost entirely re-written. Much new matter and many fresh illustrations added.

Fcap. 8vo., price 1s. 6d.; or in cloth gilt, 2s. 6d. Postage, 2d.

To be had of **HOULSTON & SONS**, Paternoster Sq.; all Hive Dealers, Secretaries of Bee-keepers' Associations, and of **J. HUCKLE**, *British Bee Journal* Office, Kings Langley, Herts.

BRITISH BEE-KEEPERS' PRACTICAL NOTE-BOOK.

With Rules for the General Management of Movable Comb Hives.

By **THOS. W. COWAN, F.G.S., &c.**, Editor *British Bee Journal*.

Consists of a Series of Tables by means of which the Bee-keeper can keep a record of all his Observations and Operations. A Pocket-companion indispensable to the practical Bee-keeper.

Price 1s., postage 1d.

Bee Journal Office, Kings Langley, Herts; and 17 King William Street, Strand, W.C.

BALDWIN'S is the Oldest Establishment in the United Kingdom wholly devoted to Bees and manufacture of

Bee-keepers' supplies. His prices will compare most favourably with those of any other Maker, while for quality of material, suitability and workmanship, he has no rival.

'Why can he give better value for money than others?' Because he spends less in large 'puffing' advertisements, buys in the best markets for prompt cash, has no rent to pay, and personally conducts his own business.

For prices and full particulars of Goods see Baldwin's Bee-keepers' Instructor (and Illustrated Catalogue combined), which 'contains more practical and reliable hints than all the large, expensive books,' post free for 2d. stamps. Address **S. J. BALDWIN The Apiary, Bromley, Kent.**

N.B.—More than 500 Silver and Bronze Medals, First and other Prizes, and Testimonials innumerable.

THE 'GARSTANG' HONEY PRESS.

(As published in *British Bee Journal* for Sept. 10.)

Inside Plates either Wood or Iron.

Prices on application. 3282

Address **ROBERT BARTON**, Garstang, Lancashire.

WINTERING BEES. By **THOMAS W. COWAN.**

The most complete work on the subject of Wintering published. Third Edition. Price 3d.

J. HUCKLE, Kings Langley, Herts.

British Bee Journal and Bee-keepers' Record.

OFFICE:

17 KING WILLIAM STREET, STRAND, LONDON, W.C

PURE CANE SUGARS.

For the accommodation of Bee-keepers, guaranteed Pure Cane Sugar will be supplied in large or small quantities through this office at the under-mentioned rates:—

MOIST. (For Household Use.)

Neat bags, 14-lbs. 28-lbs. 56-lbs. Cwts.
3. MUSCOVADO 2/7 5/2 10/- 19/6

CRYSTALLISED.

4. DEMERARA } Crystals 2/9 5/4 10/6 20/6
5. BARBADOS }
6. TRINIDAD }

REFINED CANE.

7. WHITE CRYSTALS (Small) 3/0 5/10 11/6 22/6
8, 9. (Medium and Large sizes, 1/- per Cwt. extra.)
10. LUMP (Cut Loaf) ... Boxes, 3/3 6/3 12/3 23/6
11. LUMP DUST 3/ 6/- 11/9 22/9
12. PRESERVING 3/- 6/- 11/9 22/9

FINE. (For Household Use.)

13. GRANULATED 3/3 6/3 12/3 23/9
14. CASTOR Coarse (15 Fine) 3/9 7/3 14/3 27/9
16. ICING.. 4/3 8/3 15/9 31/-

All above guaranteed made from CANE SUGAR only, and free from BEET, CHEMICALS, etc., etc.

CARRIAGE PAID on Orders over 5/0 (or 28-lbs. Sugar) to London and Suburbs.

COUNTRY ORDERS, not less than 2-cwt. carriage paid at 1/0 per cwt. extra.

(Scotch and Irish orders, special arrangements.)

CHEQUES payable to **J. HUCKLE**, Kings Langley.

Cash to be sent with order, and purchasers will please observe that if samples are required or replies asked to inquiries, a stamped addressed envelope must be sent, as we cannot undertake cost of postage.

British Bee Journal,

BEE-KEEPERS' RECORD AND ADVISER.

No. 493. Vol. XIX. N. S. 101.]

DECEMBER 3, 1891.

[Published Weekly.

Editorial, Notices, &c.

USEFUL HINTS.

COMPLETING WINTER PACKING.—Now that the weather has ceased from troubling the provident bee-keeper, and his bees—well cared for in snug, sound hives—are at rest, a word of advice may be offered to those who, from whatever cause, lag behind in putting the finishing touch to the year's work. We would remind them that stocks which are not likely to be of any use in the coming year—*i.e.*, weak lots which have made no headway in the past season, stocks known to be queenless, or which have old and worn-out or otherwise worthless queens—should be dealt with at once, and not allowed to swell the number of winter losses. They are practically lost now as stocks, and so, if the bees are healthy and sufficiently numerous to be worth preserving—not otherwise—they should, after removal of the worthless queens, be joined to second swarms wanting bees. If not worth saving, it will be a charity to end their existence by slipping the lid of a tin canister, with a bit of sulphur in it, on the floor-board, light the sulphur and close the hive entrance. The hive should then be cleaned out, and all old or suspicious combs melted down for wax. Talking of melting combs reminds us that the present is a good time to make a general clearing up of all old combs, cappings, and scraps of wax on hand. If left about they harbour moths and other vermin, besides causing mischief in various ways. Solid cakes of wax, large or small, take no harm by keeping, and can be cleaned or clarified when a sufficient weight has accumulated.

STANDARD RECIPES.—Our correspondent, Mr. Woodley (on page 528), suggests that certain recipes for making bee-food, &c., should be reprinted in our pages as each recurring season, when they are required for use, comes round. By the way, we may here take occasion to correct a typographical

error which appears in the recipe for making soft candy, reprinted by request on page 534 last week. The time given therein for boiling should be *two* minutes, not *ten*. The advisability, however, of reprinting recipes is open to question, except where the occasion especially calls for it. Syrup-making, for instance, is needed in spring, as well as in autumn; besides, beginners make the inquiry only just when the want occurs, and so to meet the individual cases we must refer to back numbers in order to avoid tedious repetitions. It is intended to issue the 'Bee Papers for Winter Reading'—which will shortly be resumed—in cheap pamphlet form, and in these all manner of recipes may be preserved for reference.

NAPHTHALINE AND ASTHMA.—The uses of naphthaline are multiplying. On another page a correspondent affirms that he has been relieved from asthmatic trouble of long standing by inhaling the fumes of naphthaline before sleeping, and now the *English Mechanic* says: 'The fumes of naphthaline are stated to be a cure for whooping cough by Dr. Chevernac, of Aix, who discovered its powers accidentally. He places about three-quarters of an ounce in a metal dish and applies heat. The naphthaline soon melts, and fills the room with fumes that are not unpleasant. It must not, however, be forgotten that it is inflammable, though not dangerously so.'

RE-QUEENING FOR STOPPING ROBBERING.—The method propounded by Professor Keller, which appears on page 492 of our issue for October 29th, may not have met with quite the amount of attention it deserves, for it is well worth noting as a 'useful hint.' If persistent robbing—which has reached the stage when the bees attacked give up the defence of their hive as a bad job, and offer no resistance to the marauding strangers—can be cured by re-queening, many will be glad to know it. Theoretically the plan is perfectly feasible, because we know that promiscuous intermingling of bees causes them to lose, in a measure, their

distinctive odour, and consequently lessens their animosity to stranger bees. We also know how much the particular odour of the queen has to do with the exclusiveness jealousy with which a flourishing stock of bees regard the intrusion of strangers, and so readers will do well to note down M. Keller's plan for future use if the need for it should occur.

NOTES FOR WINTER MANAGEMENT.—Having had a 'snap' of frost, we may any day expect a fall of snow, and a little management is required to keep bees indoors while the latter remains on the ground. Some bee-keepers adopt the bad plan of confining the bees by simply covering entrances with perforated zinc until snow has melted. We say 'bad plan' because if the bees, attracted to the hive entrance by the warmth of the sun, once become excited by their efforts to get out, very serious consequences—sometimes ending in the suffocation of the stock—may ensue. Therefore, viewing the question first *practically*, we know that the bees *will* fly forth when snow is on the ground if the warm sun shines in at the hive entrance; and we know also, to our cost, that to do so often means destruction to them. Secondly, if we desire to go further and inquire of ourselves *why* bees are so blind to their own safety as to do this foolish thing, we must assume, theoretically of course, that light, especially when accompanied by warmth, will always rouse bees to activity, while darkness apparently keeps them quiet. Hence it follows that sun and snow combined, tending as they do to increase the warmth and the light, lure the bees out to their destruction. And so, combining theory with practical knowledge, the remedy which naturally suggests itself is to take the readiest means of screening entrances from the light, while neither confining the bees nor raising the temperature of the hive. In this way may be applied the advantages of technical education in bee-keeping. We do not desire to see our bee-keepers doing certain things because their fathers before them did so, but to have them possessed of a sound knowledge of guiding principles; to know why particular operations must be performed, and what results to expect from their performance, and thereby to combine theoretical with practical knowledge.

When the full benefits of technical education are disseminated among our bee-keepers, and they are by its means made fully con-

versant with the principles of cause and effect—or, to put it more simply, when they are taught the 'why and wherefore' of visible results—they will have supped of the very essence of technical instruction, and we shall have climbed another hill-top on the road to successful bee-keeping.

IIUMBUG IN THE QUEEN TRADE.

We have given our readers an insight into the way queens are produced for the market, and in Mr. Alley's own words have shown how he produced a new strain of bees, which he calls Golden Carniolans; and, although it is well known that pure Carniolans have no yellow about them, Mr. Alley maintains that yellow is the proper colour of Carniolans, although at one time he was just as vehement in protesting that pure Carniolans showed no signs of yellow. There is another man, also a queen-breeder, by the name of E. L. Pratt, who also, for a certain time, stated the same thing, and we intend to give a few quotations of his from the *Apiculturist*, which will show to what extent humbug in queen-raising can be carried. We do not know what business connexion there is between Messrs. Alley and Pratt, but this we do know, that when Alley has said one thing, Pratt has said the same, and when the former altered his views Pratt did so too. In fact, the one just echoes what the other says.

On page 104, *Apiculturist* for 1889, Mr. Pratt says: 'We wish to call attention to our superior strain of Carniolan bees.' 'They have no equal. They generally manage to gather honey when other bees are starving. This last poor season we had a large quantity of the finest honey ever produced about here, which sold readily for thirty and thirty-five cents per pound alongside of ordinary honey at inferior prices.'

At page 166, alluding to Mr. Alley's 'colony of perfect bees,' headed by his one-hundred-dollar queen, he says:—'They are the best Italians we have ever seen. We want to say right here and now, that we have a Carniolan colony as remarkably fine. Neither of these colonies could be bought for one hundred dollars spot cash each.' In 1890 Mr. Pratt commenced conducting the Queen-breeders' Department of the *Apiculturist*, and on page 7 he says:—'What a wonderful hardy race of bees the Carniolans are. Just think of shipping them by mail in November and December as far north as New Hampshire and New York!'

On page 25 we find:—'The Carniolans are not stingless, but they are pretty near non-stinging when pure.'

On page 65 we find the important statement:—'I wish to emphasise most emphatically that *pure Carniolan bees should show no yellow bands.*' (Italics are Mr. Pratt's.)

On page 66, 'This race of bees will be a wonder when fully developed.'

On page 101 he says:—'The markings of pure Carniolan bees are very distinct; there

should not be a speck of decided yellow on them.'

On page 133 we find:—'Carniolan bees are fast gaining favour.' 'Pure Carniolans should show *no* yellow.' (Italics Mr. Pratt's.) 'As soon as we are able to breed them true, the yellow will disappear entirely, and this characteristic will stick out more boldly.' Here is a hint that he has not been breeding them true.

If the dates are compared with those in our remarks about Mr. Alley, it will be seen that this is just about the same time that Mr. Pratt was producing his new strain, and preparing bee-keepers for yellow Carniolans.

On page 134 he speaks of the wonders Carniolans have done in producing honey, although cold and wet all the time, and they never offered to swarm.

On page 158 we find an advertisement in which is the first mention of 'Golden Carniolan Queens;' also 'Pure Non-stinging Carniolan Queens and Bees.' This, it will be noted, is after Alley had produced his new strain in the way we have described.

On page 161, describing a visit to the Bay State Apiary, he alludes to Alley's new strain, which he calls 'The Yellow Carniolan.' He further says, 'Mr. Alley believes that yellow is the colour of pure Carniolans. I do not.' But to prepare his readers for the summersault he is about to take, he says, 'Yet I do not understand why they answer so quickly to the 'yellow call,' when the greatest of care in breeding will not keep them from showing a spot or two of that colour. Next year will be a yellow Carniolan year at both the Bay State yard and the Pratt Bee Farm.'

We now come to 1891, and we find the queen-breeders' department dropped, and Mr. Pratt writing under the title of 'Chips and Shavings.' Here on page 4 he says, 'I know where there is a remote yard of Carniolan bees that have run to pure bright yellow unmolested.' He has very soon turned round and followed Mr. Alley. He also says, 'Depend upon it that yellow Carniolans are going to lead in popularity another season. I have believed all along the Carnies would lead some time.'

How about consistency here? On page 16, advertising 'golden or yellow Carniolans,' he says: 'The "coming bee" is here. If you want bees possessing all the desirable points, send an order at once for one or more young queens of this wonderful new strain of bees. We cannot say too much in their praise. They are beautiful, gentle, the best honey-gatherers, and winter as well as the best Carniolans.'

Lastly, on page 38 he says, 'Yellow Carniolans are *very* gentle, the queens extremely large and prolific. They have a different shade of yellow, and the markings are not like the Italians.'

Now, these are some of Mr. Pratt's own words, and, we think, will, when taken in conjunction with the utterances of Mr. Alley, show that these two have been and are working together in the queen business, and are playing into each other's hands. They denounce other queen-

breeders in the *Apiculturist* in unmeasured terms such as Mr. Alley is thorough master of. We suppose now the Golden Carniolan business is about played out, so they are turning their attention to other strains, which are going to beat all former ones.

Tempus omnia revelat. By-the-bye, we may just mention that in 1889 Mr. Pratt started the *Queen Breeder's Journal*, but this had a very short existence. We sent, through Mr. Root, a subscription of fifty cents for one year, but only received the first six numbers for the year's subscription.

HUBER'S LETTERS.

In the description of our 'Rambles in Savoy' we alluded to some unpublished letters of F. Huber in the possession of Count Mouxy de Loche (*B. B. J.*, page 172). These letters were kindly placed in our hands, and several bee-keepers have had the opportunity of seeing them. They have since been published in a supplement of the *Revue Internationale* for April last, and we have much pleasure in now giving a translation of them, as we feel sure they will interest some of our readers.

FIRST LETTER.

I am taking the opportunity, Sir, of the approaching departure of our dear Count de Flumet to express to you my sincere gratitude. My son* will probably be prevented from leaving home at this moment by his various occupations; in them he finds the recreation which he needed, and which our excellent friend wished him to find in your society. You, Sir, agreed to this proposal in a most obliging manner. We shall dearly remember it, and as soon as the Ants afford my young naturalist a little leisure, he will visit you and ask you to continue your kindness towards him.

Mr. Falquet, a relation of ours, read us your letter, and I very soon devoured the interesting memoir that accompanied it. Your observation is as curious as it is new. My secretary had sometimes spoken to me about certain bees found in the month of May having on their heads filaments ending in little knobs of various colours. But we saw nothing more, and, so as not to make a too-hazardous conjecture, we did

* The son here alluded to is Pierre Huber, who assisted his father in preparing the second edition of his work, *Nouvelles Observations*. He was born in Geneva in 1777, was a scientific man, and wrote several memoirs. His book, *Recherches sur les Mœurs des Fourmis indigènes*, is frequently referred to as a standard work, and was translated into English in 1820 by J. R. Johnson, M.D., F.R.S., under the title of *The Natural History of Ants*. He also wrote several memoirs on natural history subjects, and 'Observations on Several Species of Bees' in Vol. VI. of the *Transactions of the Linnean Society of London*.

not make one at all; it was reserved for you, Sir, to explain this phenomenon.

If the bees found wax already formed on parts of some flowers, it might very well happen that they might know how to collect and utilise it. They make very good use of the wax from old combs which are put within their reach. I once saw some which capped their new and white cells with black wax which they had taken from the old combs. As the result of drought, they were suddenly deprived of honey; the secretion of the wax stopped entirely, and they were obliged to use that from old combs. Had I not come to their assistance, not being able to leave their brood uncovered, they would have been obliged to make cappings with wax from their own combs, and thus destroy their own work. They could not have gone on with their comb except when the temperature of the season was favourable enough to enable them to gather more honey, and therefore make more wax, and the fate of the swarm would have been endangered.

By giving our swarms honey in time, and as soon as it is apparent that their work is suspended by the inclemency of the weather, they are placed in a condition which enables them to continue making their combs and to produce as much wax as if the season had been more favourable; but, as it is at the expense of honey that the bees make the wax, the same quantity will not do both to construct the cells and to fill those which are used for storage. Those made with the honey supplied to them will be ready to receive that which the flowers will furnish them; and, as they will have enough cells at this time, they will not need to construct any more, and all the new honey can be stored for winter use.

But what would happen if the drought or bad weather lasted too long, and if there are no summer or autumn flowers for the bees, as it frequently happens in our cantons, and as I saw it the case in 1793 and 1803? The answer is easy: all that year's swarms would perish and a great number of the parent hives would share the same fate, unless you undertook to feed them until the beginning of another season. I doubt if any of our peasants would take that trouble, or make the necessary expenditure.

The two months of harvest are worth more to the bees of the High Alps, and generally for all those that live in the north, their real native country, than are our three seasons in the open country, and which only afford such very scanty and often interrupted harvests.

In my opinion, in order to make the most of these insects, and not to risk losing this precious race, we must either take our bees to pasture-ground, as our fathers did, when the surrounding country had nothing more to furnish them with, or place within their reach honey as well as the pollen, which is necessary for their little ones, by cultivating plants from which they can gather these two at the right time. Choosing the first days of June for sowing buckwheat, this is in flower in July—that is to say, when

the first vegetation of the fields is exhausted, or even when they are parched up. This African plant resists heat and drought better than others.

Several times I have seen my bees gather large harvests from self-sown buckwheat, and which flowered at the end of July or the beginning of August. If I had possessed a little ground of my own, I should repeat the experiment for the benefit of the bees. Could not you, Sir, do it on a larger scale? I would much like that it should succeed in your hands. Please give me your ideas about it. I should put a high value on the communications you would be good enough to favour me with.

The economic part of the science of bee-keeping is the one that I have studied the least, and, as I am very much interested in it, you will oblige me very much by giving me a few details on that subject.—I have the honour to remain, Sir, your very humble and obedient servant. HUBER.—*Au Bouchet, near Geneva, May 14th, 1804.*

(To be continued.)

DEVELOPMENT IN THE HONEY-BEE.

BY R. A. H. GRIMSHAW.

(Concluded from p. 489.)

When men like Darwin, and women like Miss Ormerod, give the results of a life's labour in the effort to point out to the agriculturist his friends and foes in the animal kingdom, it behoves us to force into prominence, with all possible vigour, the benefits which accrue to him through the fostering and spread of the science of apiculture, that branch of natural history upon which we, as bee-keepers, have made ourselves specialists. To the gardener and fruit-grower, to the villager and the nobleman, the benefits conferred by the honey-bee are, proportionally, as obvious as to the farmer and cattle-breeder. With turnips, sprouts, cabbages, rape, beans, peas, &c., it has been shown that finer and larger seeds, with the resulting finer and larger plants, have been produced by plants which have been visited by bees, whilst, in many cases, absolute sterility has followed an absence of insect aid in cross-fertilisation. Darwin found seventeen plants of the common bean only yielded, when covered up, forty beans, whilst seventeen such plants, alongside and unprotected, yielded 135 beans; these latter plants were, therefore, between three and four times more fertile than the protected ones. Cross-fertilised cabbage plants produced seeds, the plants from which flowered earlier than those from uncrossed seeds, they were five per cent. taller, and the capsules from the latter were not so rich in seed. Crossed scarlet-runner plants also flowered first, and were four per cent. taller. The common pea, when crossed, produced plants from one to three feet taller than the parent plants. The common beet plants were three per cent. taller; crossed cabbage plants were three times as heavy as those

from uncrossed seed. All round, height, weight, and fertility of crossed common cabbage were five times those from uncrossed seeds; common pea as one hundred to seventy-five.

When we come to the Alsike or Dutch, the red or the crimson clover, the difference between the seed results of crossed plants, or of plants visited by bees (the hive or the humble bee) is so startling that only a careful reading of Darwin's own experiments can give an adequate idea of the importance of the bee to the agriculturist who raises green fodder for the feeding of his cattle, and looks to his fields for a rich supply of dry winter food, rich in flesh-forming compounds, drawn from the earth and air, and stored in the seed through the agency of a comparatively insignificant insect. I cannot resist the temptation of repeating the results of one of the great master's experiments on Alsike clover:—

Twenty protected heads yielded *one* aborted seed, whilst twenty heads, *seen to be visited by bees*, yielded 2290 seeds. Again, one hundred heads of red clover did not yield a single seed when protected, whilst the same number of plants, visited by bees, gave 2720 seeds. Crimson clover, insect-visited, gave five to six times as much seed as non-visited plants.

If we examine, with a small hand-magnifying glass, the flowers of our fruit-trees, the apple, pear, strawberry, raspberry, currant, gooseberry, cherry, plum, peach, apricot, and, amongst wild fruits, the blackberry and bilberry, we shall find that the pollen contained in the anthers is not ready for use in cross-fertilisation in all flowers at the same time, because very few of the flowers are of exactly the same age. There is a steady sequence of opening flowers during the whole time of suitable weather, during the blooming season of a particular plant, until as many of the flowers have got fertilised as the plant can well sustain and feed the fruit of. When the drain of the fattening seeds on the nutrient resources of the plant becomes excessive there is no more to spare for pollen production—this pollen being rich in phosphorous and sulphur compounds, which are being used up in the seed storehouses. There are, no doubt, other and more intricate causes for the cessation of blossoming, but the one I have given is probably the most general. We often notice quite a number of withered blooms on fruit plants which have never had the benefits of insect visitation, through lateness of blooming or through wet weather prevailing at the time of ripe pollen, but I think this is the result of a failure or stoppage in the supply of nectar, the saccharine matter of which has been requisitioned by the swelling seeds of flowers crossed in the earlier part of the season. No sugar nor sulphur and phosphorus to spare, little nectar and starved pollen follows, with the expected result, no fruit, no seed.

It must have struck most people who have seen a very floriferous bramble-bush at the end of autumn, that if the seeds could possibly have been fertilised the plant could not have borne

the weight of its fruit, to say nothing of the strain on its vital resources. The same thing strikes one after a good blooming season in the orchard. When trees and insects have been in the best accord, giving and taking toll of each other to perfection, we know that if winds do not blow off the fruit held on by the weakest stems, the larvæ of insects (those magnificent Nature's pruners) at work on superfluous fruit, until, becoming too numerous, they are checked by bird-life, the tree would break down with the weight of the clustering fruit long before it was ripe.

Altogether, the study of the chain which links together plants, flowers, and insects (and especially, as far as we are concerned, the honey-bee), is so full of interest and wonder that it will always lead the student into a field of enchanting research, which will amply repay him for the time spent in its investigation. The study, too, of the development of the honey-bee, from a solitary to a social individual—from a so-called imperfect insect in the remote past, which, as simple male or female, is only able to gather food from day to day and reproduce its kind, to the highly specialised worker, drone, and queen, as we find them to-day, not one of which can do both (*i.e.*, gather food and breed young)—is one that will probably fascinate many minds long after the writer of these lines has passed out of sight along the road we are all travelling. Meantime, it would be a pleasant thought to him if anything he has said in this long and, to the reader, wearisome series of papers, should have fostered or forwarded in any one a keener love for the pursuit of truth as it may be found in the book of Nature, a book always open to him who will seek it in her pages.—R. A. H. GRIMSHAW.

[In noting the conclusion of the above papers, we are sure that readers along with ourselves have received both pleasure and profit from the perusal of Mr. Grimshaw's interesting articles.—EDS.]

BRISTOL DISTRICT BEE-KEEPERS' ASSOCIATION.

A meeting of the Management Committee was held on November 26th at the Committee Rooms, 11 High Street, Bristol, when it was decided to hold the annual meeting in the month of January next, on a day to be hereafter fixed, and in connexion therewith a subscription dinner will be provided for the members and their friends.

The Secretary (Mr. James Brown) reported a large increase of members, much credit being due to the Expert (Mr. J. Martin), who has done valuable service amongst bee-keepers this autumn, although it has been a somewhat trying one.

After a long discussion, it was resolved that there should be two shows of honey, &c., next season, one to be held in the county of Gloucester and the other in Somerset.

Correspondence.

The Editors do not hold themselves responsible for the opinions expressed by correspondents. No notice will be taken of anonymous communications, and correspondents are requested to write on one side of the paper only, and give their real names and addresses, not necessarily for publication, but as a guarantee of good faith. Illustrations should be drawn on separate pieces of paper. We do not undertake to return rejected communications.

Communications relating to the literary department, reports of Associations, Shows, Meetings, Echoes, Queries, Books for Review, &c., must be addressed only to 'The Editors of the "British Bee Journal," 17 King William Street, Strand, London, W.C.' All business communications relating to Advertisements, &c., must be addressed to Mr. J. HUCKLE, Kings Langley, Herts (see 1st page of Advertisements.)

* * * In order to facilitate reference, Correspondents, when speaking of any letter or query previously inserted, will oblige by mentioning the number of the letter, as well as the page on which it appears.

DISINFECTING HIVES—SPORES OF FOUL BROOD IN COMB FOUNDATION.

[863.] I observe that on several occasions in the current volume of the *British Bee Journal* the editors have recommended that hives be fumigated by means of burning sulphur to destroy the spores of *Bacillus alvei*. Sulphurous acid has for a long time occupied a very high place among disinfectants; but the elaborate experiments of Koch and Wolffhengel in Germany, and of Sternberg and others in the United States, prove that it is of no value as a disinfectant of spore-containing material.

In *Mittheilungen aus dem Kaiserlichen Gesundheitsamte*, Vol. I., pp. 188-232, Dr. G. Wolffhengel has an article on the value of sulphurous acid gas as a disinfecting agent; and in the same volume, pp. 234-282, Dr. R. Koch gives the results of his experiments, made to determine its exact value as a germicide. In the Report of the Committee on Disinfectants of the American Public Health Association, for 1885, there is a paper by Dr. J. H. Raymond on 'Experiments with Sulphurous Acid Gas,' and another on 'Sulphur Dioxide,' by Dr. George M. Sternberg, who says: 'My experiments show most conclusively that it does destroy the specific infecting power of vaccine virus dried upon ivory points, when present in the air of a disinfecting chamber, in the proportion of one volume per cent. ;' but, after giving an account of his own experiments and of a number of those made by Dr. Koch, Dr. Sternberg writes: 'In view of the experimental data here recorded it is evident that the use of sulphur dioxide for the disinfection of spore-containing material must be abandoned. This is the conclusion of Wolffhengel on the basis of Koch's biological tests and his own experiments. He is, therefore, inclined to abandon entirely the use of this agent for disinfecting purposes.'

It appears that the germs of smallpox, diphtheria, cholera, scarlet fever, puerperal fever, and yellow fever do not form spores; therefore, Dr. Sternberg still recommends sulphurous acid for destroying the infection of these diseases.

From the foregoing I think it will be admitted that bee-keepers cannot depend upon the fumes

of sulphur to disinfect their hives. Dipping them in a solution of corrosive sublimate, 1 : 500, is sure death to all spores, but the hives must be rinsed afterwards, or the bees may get some of the poison.

May I be permitted to direct attention to another matter? On p. 407 of the present volume of the *British Bee Journal* the editors say: 'If wax is kept at a temperature of 212° for four minutes, it is stated the microbes are destroyed.' This is true as regards moist heat—that is, heat applied when the spores are soaked with water, as is a seed when it is in a condition to germinate; but Koch and Wolffhengel have shown that the same spores which are killed by a temperature of 212° for four minutes when soaked and in a moist condition, require a temperature of 284° for three hours to destroy their vitality when in a dry state.

I have been contending in the columns of the *American Bee Journal* that spores in wax melted in boiling water are dry spores, because, on account of being coated with melted wax, they are incapable of absorbing water. I believe that sheets of foundation often contain millions of live spores of foul brood; but, while they remain encased in the wax, and are thus prevented from absorbing moisture, they are harmless. I think it probable, however, that when the bees are drawing out foundation into comb, or when they are cutting down or rebuilding cells, or in some of the manipulations to which the wax is subjected, spores may occasionally become exposed to heat and moisture, and thus be the means of starting foul brood. The question is a difficult one to prove experimentally. If some of the readers of the *British Bee Journal* can find a way to test the vitality of spores in foundation, and thus settle the question beyond dispute, we shall all feel under obligations.

I notice that in the item referred to above, the editors say, also, that wax is kept at 212° for twenty-four hours in making foundation; probably basing their remarks on the statement of Mr. Newman, editor of the *American Bee Journal*, to that effect. Mr. Newman gives Mr. Dadant as his authority; but, on reference, it turns out that what Mr. Dadant says is that 'to get rid of impurities wax should be kept liquid twenty-four hours.' Mr. Newman's attention has been called to his error, but, up to the present, he has not corrected it.—S. CORNELL, *Lindsay, Ont., Canada*.

[It is very evident that the more we know of the subject the more difficult we find it to destroy the vitality of spores. The bee-keeper's hope, therefore, in contending with the disease, is to continue the use of disinfectants in order to destroy or neutralise fresh crops of bacilli. Better to prevent them from coming into existence than to destroy them afterwards. 'Prevention is better than cure.' Most scientists are agreed that bacilli can be destroyed much more easily than spores. We cannot recommend the use of corrosive sublimate in an apiary, owing to its dangerously poisonous nature, for we must bear in mind that every bee-keeper has not received the scientific training which would enable him

to exercise due care in manipulations with dangerous compounds, and were corrosive sublimate to be used, it would not fail to get into the hands of some careless individual, probably with disastrous results. Valuable as it is in the hands of the trained scientist, some eminent men consider that the value of mercuric chloride as an antiseptic is much overrated. It is possible, if wax were merely melted on the surface of the water, for the spores to remain dry, but we doubt very much if they have the coating of wax our esteemed correspondent imagines—this because the water is boiling, and the act of ebullition causes the water to pass through every portion of the wax. In fact, if any one will observe wax boiling in water, it will be seen that wax and water are constantly changing places. Then we think it probable that the spores are subjected to the moist heat necessary for their destruction. We apprehend that if the spores are in foundation, they would be encased in wax, and would then be harmless. We have never had a case of foul brood brought to our notice that could be traced to using foundation. We do not see that it would be impossible to test the matter, as a bacteriologist ought to be able to separate the spores from foundation, and if they are still alive he should have no difficulty in cultivating them. There are solvents of wax that have no effect on the vitality of spores. We thank Mr. Cornell for the correction as to time of boiling, although practically the error is unimportant, for if four minutes' boiling kills the microbes, several hours can do no more. We hope that Mr. Cornell's surmise of sheets of foundation containing millions of live spores will not prove to be correct, and we hope that the matter will be tested. In the meantime our friends will do well to use the remedies now on trial, and which have so far given every promise of success. We allude to Naphthiol Beta and naphthaline, which will destroy the crops of bacilli as they appear.—Eds.]

BEE ASSOCIATIONS AND COUNTY COUNCIL GRANTS.

[864.] As one much interested in the future of bee-keeping in this country, may I be allowed to contribute a little to the correspondence now taking place in your columns on the best ways of utilising the County Council grants for technical instruction in bee-keeping? In my opinion, there is only one way, and that is by a properly organized system of classes, and the best time to hold these would be in the summer months, when practical demonstrations would be possible, which would make them more interesting and attractive. A popular lecture may create an interest, and make the objects of Bee Associations known, but it does not give the instruction needed. The want of a proper course of instruction has been the cause of many taking up bee-keeping and soon giving it up in disgust, perhaps attracted to it by a lecture or an exhibition of bee-driving. I think it is generally admitted that the Bee Associations, with their bee-tents, &c., have not reached the class they were formed to benefit and instruct; but, I think, with a properly organized system of sound teaching this class will be reached,

and we shall have more practical bee-keepers amongst the labourers and artisans than hitherto, especially if we get the young folk to attend these classes.

On the system of lectures, an Association sends a lecturer, with his magic lantern, &c., at considerable expense to a place, and he delivers his lecture to an interested audience, some of whom, on the strength of what they have heard, start bee-keeping, and, if they do not soon give it up, pay very dear for their experience. Bee-keeping will never be a large industry, so what we want is to get hold of those who have a taste for it, and give them a course of the best possible instruction.

As there is no time to organize classes this winter, if they are to be carried out on a uniform system throughout the country, where the County Councils will permit it, the money may as well be spent, as is to be done in Lancashire and Cheshire, by delivering lectures.

I quite agree with Mr. Garratt (850, p. 527) that unity of action in the matter is absolutely necessary, and that a syllabus should be prepared by the parent Association to make the teaching uniform throughout; and I hope to see a good scheme emanate from this source, and that the funds will be forthcoming when required.

Now, with regard to the teachers. This appears to be a matter of some difficulty, if we are to judge by the number of candidates for the post of lecturer to the Lancashire and Cheshire B. K. A.; but I don't think it will be so difficult to find suitable men capable of teaching sound bee-keeping, guided by a syllabus. A brilliant lecturer is not needed, and there must be in every county a few men who are really good practical bee-keepers, competent and willing to do this; if there are not, it speaks badly for English bee-keepers and the certificates granted in the past by the B. B. K. A.

I would suggest that examinations be held next spring at different centres for candidates for the post of teachers, and a special certificate be given for this by the B. B. K. A., so as to get as many competent teachers in one county as possible. Let it be made known at once what will be expected from candidates. I should think in every county it would be possible to obtain the permission to hold these classes at some one's apiary in the district the class was held in.—T. D. S., *Alderley Edge, November 25th, 1891.*

TECHNICAL EDUCATION IN BEE-KEEPING.

[865.] Mr. Donbavand's letter (857, p. 541) in your issue of November 26th calls for some reply from me, for, rightly or otherwise, I consider myself to some extent responsible for the 'grants in aid' that have been granted or recommended to be given by the County Councils of Lancashire and Cheshire. So far as I am aware Mr. Donbavand is not a member of the Lancashire and Cheshire B. K. A.; therefore cannot

know from any reliable source what the Committee have taken upon themselves. Had he, before rushing to your columns, been good enough to have written to or seen the Committee, he could have been satisfied that his charge against Mr. Harbordt is entirely unfounded.

I enclose a copy of the catalogue referred to by Mr. Donbavand. This was an old one, printed early in 1890; and Mr. Harbordt assures me he has had no catalogues printed since. Reference to page 14 of the catalogue, on foul brood, will convince any one *up to date* in bee-keeping that the catalogue must be an old one, for there is no mention in it of either Naphthaline or Naphthol Beta.

I shall be glad if Mr. Donbavand can see his way to help us in his district; but I am free to admit that we should not have so large an Association as we have if we had not, from time to time, to meet parties of a kindred nature to his.—W. LEES MCCLURE, *The Lathams, Prescot, November 28th, 1891.*

LECTURERS AND THEIR CRITICS.

[866.] When I was appointed lecturer to the Lancashire and Cheshire Bee-keepers' Association, after undergoing a somewhat severe test, I naturally felt proud and elated at my success, but I did not suppose that that appointment had raised me from my modest private position to the high distinction of a public character. Now, however, that I have been actually attacked in the public press, my good fortune has been brought more fully home to me, and I feel all the prouder and more elated in consequence. But, like others who have gone before me, I perceive that utterances made when occupying a position of greater freedom and less responsibility may require a little explanation upon assuming the sweets of office. Happily, in the present case the explanation to be given is not a very difficult one, but it unfortunately entails the divulgence of a little trade secret. Here it is: Dealing in bee-appliances is not a highly remunerative pursuit—in fact, I have found the profits so modest that to print every year a new catalogue would, in my case, not only have taken the proverbial gilt off the ginger-bread, but it would have taken the ginger-bread itself. Consequently the price list with which your correspondent (857, p. 541) was supplied in July last was then about celebrating its second birthday, and if some two thousand of these lists had not been recently accidentally destroyed by fire, Mr. Donbavand might actually have been scandalised by being supplied with an old copy—including the objectionable passage—next July, and possibly the July after that. However, it is an ill wind that blows nobody any good, and your correspondent will have to thank the fire for being supplied with a brand-new catalogue when next he patronises my establishment, as I hope he will do soon again and again.

There is another matter, also, to which I

would draw your readers' attention. In spite of the paragraph in my old catalogue disclaiming all knowledge of foul brood, customers have at times been ill-advised enough to actually bring parcels containing foul-broody combs into the shop for my examination; and now that I am no longer able to hide my light under a bushel, I am afraid such cases might become of more frequent occurrence. Partly to avoid this danger, I am described in all my official documents relating to my lectures as of Birkdale. May I ask all who may at any time wish to consult me on foul brood to address their communications to my private address, not to Liverpool?—P. HARBORDT, *Eastbourne Road, Birkdale, near Southport.*

NOTES BY THE WAY.

[867.] *Hives Dove-tailed or Toothed.*—Allow me to say I quite understood the American style of so-called dove-tailing the ends of boards so that the ends fit into each other and form a strong corner joint to a box, &c.; and, with our friend 'A Cheshire Bee-keeper,' consider that our hive manufacturers, if it would not pay them to put down machinery for their productions, should get the hives in the flat from America. Thus, if you get American-made dove-tail work it must be of the common square-toothed kind, and probably this would prove as durable in hives that are exposed to the inclemency of the weather, provided the joints are well saturated with paint when they are first nailed together, as the more expensive and better work of an English carpenter.

I am glad to see our Berks Report of experts' tour in last week's *B. B. J.* I was prevented by stress of work from attending the committee meeting, therefore knew nothing of the context of report till I saw it in print. This tour has been criticised somewhat, and the question has been asked, Is this the way your County Council interded their grant to be spent—or, in other words, is the manner in which you propose to spend it advancing technical education? To such inquiries I commend our report. Our experts called on and located by name and address 728 bee-keepers in the county, and as the tour was made at the end of the summer and beginning of autumn I take it that the aggregate number (3416) of stocks gives a pretty conclusive idea of the number of hives which may be classed as winter stock. The results of their labours are eminently satisfactory as forming a foundation on which we can rely in the future when the actual technical classes are formed, and as time goes on and the requirements of our districts are better understood we shall be able to map out the best honey-producing districts in the county, and thereby localise our efforts to teach practical bee-keeping in the best districts. This technical education is at present hardly emerged from the embryo state in country districts, and for some time will be merely on trial. No doubt, among the resident committee who will be nominated to

act in conjunction with our County Councillors in carrying out this new scheme, some bee-keepers will be chosen. This will help to give our Association a standing with the Council, and also to allow of some practical development of classes in conjunction with classes in other subjects which will be established shortly.

The subject of lecturing in country villages, and using the lantern to illustrate the lecture, is a fair way of arousing interest, but I fear the result would be evanescent. I think a more practical plan, and one far more likely to bear practical results—and where is the teacher now who does not work for results?—would be to call a meeting of bee-keepers in a central large village by giving a few days' notice by placard or bill, and also in the immediate hamlets, asking the attendance of bee-keepers especially, and others who may be interested in technical education. Then, instead of a set lecture, have a free-and-easy *conversazione*, with a few practical appliances—not in the new state you receive them from the manufacturer, but such as are in everyday use in your apiary: frames with combs built by the bees when left to their own sweet will, also frames of comb built with full sheets of foundation, also sections in the flat, folded, waxed, started, filled with combs; then a few in different stages of completion, some in which the bees have just started filling the cells with honey, others filled and commenced sealing; also a perfect section as taken from the hive. Then show your super-clearer and section crate in position. Initiate your bee-keeping audience in the art of preparing honey—after it is gathered—for the market. Show different styles of cases in which sections of honey are sold, or, better still, teach the lady bee-keepers how to glaze their sections *à la* Woodleigh, simply for the reason that it is the *cheapest* style, if not the neatest, in which sections of honey can be prepared for market. Then give a practical exposition how to pack the produce of the apiary so that it may withstand the 'jars' when delegated to the tender mercies of railway porters for transit to the dealer; and last, but not least, show an extractor and how to work it. Then, if time permits, give a short *resumé* on the life-history of the busy bee, and form your classes for another demonstration, either in the same building or in the outlying hamlets of the village. This plan, or something similar, would arouse interest in the subject we have at heart, would spread a practical (shall I add technical?) knowledge of the subject far beyond the illustrated-by-lantern-slide lectures of the past. Then another spring or early summer the local apiary can be utilised by the 'teacher,' and practical demonstrations can be given in handling bees; after which the matter must rest till another autumn.—W. WOODLEY. *World's End, Newbury.*

[We only desired in our footnote to emphasise the fact that the hive referred to on page 453 is nothing akin to the American one, but that it has special features and merits of its own of an altogether different kind.—EDS.]

NAPHTHALINE AND ASTHMA.

[868.] Can you kindly inform me if the fumes of naphthaline are injurious to human beings? I have long suffered from asthma at night-time; but since placing a box of naphthaline near my bed, and taking a smell of same before sleeping, I have not had a single attack. I, however, have had a very sore throat for the last few days. Do you think it is the fault of the naphthaline?

If naphthaline (fumes) will cure asthma, it will be a most invaluable boon to persons troubled with that complaint.—B. *Woburn.*

[So far from being harmful, the fumes of naphthaline are very beneficial to human beings, and the product itself is known as one of the best disinfectants. We are not prepared to say how far asthmatical persons are benefited by inhaling the fumes, but we can personally vouch for the fact that no harm to the throat will follow. Were it otherwise, we should have a very sore throat indeed.—EDS.]

NOT A BAD RESULT.

[869.] We have miserable weather here at present; indeed, the summer has only been a moderate one. However, I must not complain, for from fifteen hives I have cleared above 20%. —J. F., *Longheaton.*

NOMINAL ONE-POUND BOTTLES.

[870.] It gave me much pleasure to read 'Bee Just's' remarks in last week's issue (859, p. 542) respecting 'Nominal one-pound bottles,' in reference to which you were good enough to insert a letter of mine some time ago. The subject is one which to my mind should be well ventilated, for I feel sure it is quite impossible for any of your readers who give sixteen ounces to the pound instead of fourteen not to feel strongly on this matter. Let a thing be sold for what it is and not for what it is not; the bottles to which I refer are made specially for honey, and not also for other products, and in reference to your remark that 'the argument cuts both ways,' I cannot agree therewith. Is it in human nature to give more than sixteen ounces to the pound? I think not. If these bottles when properly filled with good honey would hold even close on a pound there would not be so much cause for complaint, but they are made so that they will only contain about fourteen ounces, and I have it said to me this season; 'We cannot get more for the full weights than for these.' This bears on the face of it its own meaning.

I am not complaining against the various jars (tie-over, &c.) which from their variety in size contain from twelve to twenty ounces, and can only be sold per jar, but against 'short-weight screw-cap honey bottles.' And I trust some other correspondents will take up this matter in your valuable *Journal*, from which, allow me to take this opportunity of saying, I have derived great benefit.—SIXTEEN OUNCES, *Frodsham.*

MY AVERAGE YIELD.

[871.] I once more send to you my humble efforts and results *re* bees. Spring count, thirteen hives (bar-frame), honey yield 377 pounds, section and extracted; average twenty-nine pounds, with three swarms and one cast. Not a very creditable amount, but I think this time you must blame the weather, not me. Stores sufficient excepting two lots, which I had to feed up. With driven lots I now count thirty-three hives to winter, and hope for better success next year for all.

Referring to home-made appliances, I am pleased to say I make everything, excepting smoker and extractor. I am afraid I am one the manufacturers would not vote a testimonial to! During this week, on sunny days, most of my bees are carrying pollen. The rain through October and November has shortened the amount of honey from the ivy, which, as a rule, is considerable in this locality.

I take the opportunity of wishing you a prosperous new year, although rather premature you may think.—DRONEY, *Paignton, Devon.*

BEE-KEEPING IN LINCOLNSHIRE.

[872.] In response to an invitation from the Committee of the Lincolnshire Bee-keepers' Association, I undertook a tour, for the second time, among the bee-keepers of my native county.

Spalding District.—Acting under the instructions of the Hon. Secretary (Mr. Godson), I left Somersham by the first train on Monday, August 31st, and proceeded to Spalding, where I was met by Mr. Hufton, the district secretary, and Mr. Pocklington, a local member, who drove us to his residence, a few miles out of the town. In Mr. Pocklington's apiary I found the first case of foul brood, though in a mild form.

After lunch we were driven to Whaplode, and though we saw the apiary, we missed a chat with a well-known and successful bee-keeper (Mrs. Brown). The winter of 1888 thinned Mrs. Brown's apiary—so much so that only ten stocks out of sixty survived.

On returning to Spalding, we called upon Mr. Handcock, Silver Street, who possesses a small, though compact and successful, apiary. Four hives had, for the season, done remarkably well; two gave over 100 saleable sections, which found ready purchasers at 1s. each, besides extracted honey, the yield of the latter being one and a half hundredweight, so that the average per hive was sixty-seven pounds.

I next called upon G. Barrell, Esq., C.A., with whom I had a most interesting conversation, and I learned that he was one of the first bee-keepers in England who, with the late Mr. Woodbury, started the new system, and was also one of the first to experience foul brood, about which he wrote to the *Journal of Horticulture* at the time. Mr. Barrell's expe-

rience with Ligurians is most extensive, he having introduced four or five queens a year for a considerable time; but no foul brood has been seen in his apiary for the last twenty-five years.

Boston District.—On September 1st, I left Spalding for Boston, calling on my way at Algarkirk Hall, to inspect the apiary belonging to Mrs. Sparrow. I found the yield of honey nil, but took up a very heavy swarm in a straw skep and united the bees to the next stock.

On arriving in Boston I called upon the District Secretary (Dr. Small), who informed me that the bulk of subscribers to the Association in his district were not bee-keepers, and therefore did not require my services.

Mr. Blades again kindly assisted me with a list of bee-keepers upon whom I called. The season here has been, on the whole, better than last. Mr. Jackson, the veteran of the district, who has been a bee-keeper over fifty years, had been fairly successful, and his neighbour, Mr. Dolby, had averaged forty pounds per hive. No difficulty is experienced here in disposing of the surplus at remunerative prices.

Horncastle District.—The members of the Association at Horncastle I visited in company with Mr. T. W. Smith, the district secretary. No one had any particular success to record, but stocks were in good condition, and promise well for future success. Mr. Bint met me at Horncastle and took me on to Bucknall, where we arrived in time to do a little driving, and I was also able to examine Mr. Bint for an expert's certificate. Mr. Bint's average yield for the season from twenty-three stocks was 10 pounds; last year it was over 50 pounds, one hive giving 90 pounds.

Dr. Bolton, of Bardney, with Mr. Bint's assistance and the advantage of extensive crops grown for seed, had done well, one hive, the 'Paragon,' having given 100 pounds. Sections in this neighbourhood, and also at Horncastle, of home manufacture, holding about four pounds, appear to be much in favour, as they find a ready sale.

As an encouragement to cottagers and skepists generally, I may here mention that Mrs. Crow, a bee-keeper who lives a little more than a stone's throw from Mr. Bint at Bucknall, started the season two years ago with three skeps, and finished, after taking up swarms and supers, with four strong stocks and thirteen stones of honey. One swarm, weighing eight pounds—more probably, at least two, as this is abnormal for the size of skep in use—filled an old dash churn (combs 18 x 12 inches) and a box, equal to ten standard frames. What a glorious district with a sunny June and July!

Caistor District.—Leaving Mr. Bint, I next proceeded to Caistor, where I spent two days with the District Secretary, Mr. Ainger, who is working energetically, evidently in order to make his district one of the best in the county. In company with Mr. Taylor, the Association Auditor, I visited the apiary of Mr. Ford, who is a

beginner in bee-keeping, and a very savage lot of bees we encountered. On our way back we called at Mr. Taylor's apiary, and found, before we had proceeded far, a very bad case of foul brood. The colony was quickly closed, and the rest of the apiary left undisturbed. A day or two after I left Caistor, Mr. Taylor took the best means of stamping out the disease by destroying the stock, and I should strongly advise all bee-keepers to lose no time in thus stamping out any bad cases they may be unfortunate enough to find in their apiaries. Since the Brigg Show, Mr. Ainger has got twelve members and two Vice-Presidents of the Association, F. A. Dorrington, Esq., J.P., and Maunsell Richardson, Esq. In order to get as much benefit as possible from my visit, Mr. Ainger called a meeting of bee-keepers at the 'Red Lion' Hotel on September 4th. In reply to an invitation from Mr. Ainger, Mr. Richardson said: 'I will gladly help your Association, and if my becoming one of the Vice-Presidents will assist your useful endeavours, and encourage bee-keepers to make the most of their bees, I shall be pleased. I attended a lecture at Brigg Show on the subject of manipulating bees, and was much surprised and interested. I will subscribe £1. towards your funds.'

What a help to secretaries such gentlemen are. Would that there were more whose sympathies were enlisted in every district!

(To be continued.)

Queries and Replies.

[458.] *Winter Treatment of Foul-broody Hives.*
—1. As my hives appear to be infected with foul brood, would you advise me to at once overhaul them, and remove all combs containing foul brood, or cut out the lower part of the comb when there is honey above? 2. Although I believe all my hives have sufficient honey to last over the winter, would you advise me to give each a cake of medicated candy? 3. How long should the supply of naphthaline be kept up? I should think till late next spring, to disinfect the brood then hatched. 4. Will it be wise at this time of the year (November) to wash or damp the floor and sides of the hives with a solution of naphthaline, and what strength should the solution be? 5. Will washing empty boxes and frames render them fit to use without danger, and will it do to spray all empty combs from which honey has been extracted with a solution of naphthaline?—P. J., *Redruth.*

REPLY.—1. If such of the combs as are not covered by bees are removed, we should leave the rest till early spring. 2. Yes; it could do no harm, and possibly may be very beneficial. 3. Keep it renewed until all trace of the disease has gone. 4. Naphthaline is not used in solution at all. If disinfecting liquid is required Naphthol Beta must be used. 5. Better disinfect with burning sulphur fumes.

TAKING CARE OF THE BEESWAX.

A great many times I have been into beeyards and found a piece of broken comb here, and a small strip of foundation there, and an old box hive full of comb in another place. I would say, 'Why don't you melt up this old comb into wax?' 'Oh, there is not enough to pay! How much would I get from these old pieces?' 'Well, you might get two pounds or more.' 'Well, I don't care much for it.' Now let me tell you, friends, this is right where we lay the foundation of our failure. We do not care much for it.

A piece of comb, however small, saved every day, will give you quite an amount of wax by the end of the season. Now, this is the way we do it at the White Mountain apiary: We procure a box and place it in the most convenient position, and give instructions to everybody who handles any honey, comb, or wax, to throw every particle of waste, however small, into the box. Once a month, or oftener if need be, we put the old comb, &c., into a barrel, and when we have a sufficient quantity we melt it up. To do this, we take a large kettle, holding perhaps fifty gallons, and fill it about half full of water; then build a good fire under the kettle, and let the water come to a boil, then throw in the old comb, and let it be perhaps half an hour; then skim off the top of the water, getting all the wax possible. Strain this through cheese-cloth into tubs. Then put a little more water in the kettle, and keep a good fire until the contents are boiling well; skim off the top again, and strain this into another tub. The old stuff in the kettle is then thoroughly squeezed either in cheese-cloth or through rollers. Thus, you see, you have your wax in three grades. The first that is taken off is usually good enough, but the last will need to be put into the kettle again with clean water, and carefully strained through your cloth.

I think more wax is obtained by this method than by a solar wax-extractor.

Saving the old crumbs is not much trouble, and it brings in a good many dollars.

It's the small things that count.—A. D. ELLINGWOOD in '*Missouri Bee-keeper.*'

Notices to Correspondents and Inquirers.

Letters or queries asking for addresses of manufacturers or correspondents, or where appliances can be purchased, or replies giving such information, can only be inserted as advertisements. The space devoted to letters, queries, and replies, is meant for the general good of bee-keepers, and not for advertisements.

R. CHAPMAN.—We cannot account for the peculiar effect the application of heat in the way described had on the honey; but the sample sent is very good and genuine honey.

A. H. PEACH.—Bell-glasses may be worked on frame hives if a thin board or adapter, large enough to cover all the frames, is laid on the top bars; a couple of slots must be cut, to admit the bees to the glass.

Special Prepaid Advertisements.

Situations, Publications, Bee Plants, &c.—Twelve words and under, Sixpence; for every additional Three words, One Penny.

Trade Advertisements not inserted under this head.

WALLFLOWERS.—Fifty Plants, 1s. free. Arabis, 1s. per dozen. Address NORMAN PARKIN, Blakenhall, Wolverhampton. L 51

FOR SALE.—Fifteen Stocks of Black Bees in Paraffin Hives. Fed up for Winter. No Honey taken from brood-nest. £1 each, or £11 for the lot. Address R., Stokeknoll, Bishopstoke. L 55

FOR SALE.—Sixty Sections of Comb Honey, and 40 lbs. of Extracted. Good quality. Price £3 5s. Deposit System. Address W. CHOLDCROFT, Hare Street, Buntingford, Herts.

WHAT OFFER for three 14-lb. Tins of Good Honey? Address R. W. EAGLETON, Parson's Grove, near Wisbeach. L 57

HONEY EXTRACTOR and Feeders Wanted, Cheap; or Exchange for Poultry. Address ROSSITER, Pilton, Somerset. L 58

LANTERN SLIDES.—MR. WATKINS will be able to supply a few Sets from his Negatives to Lecturers on Bee-keeping. All Photographs from Nature and Photomicrographs. Early application advisable. List free. Address ALFRED WATKINS, Hereford.

WANTED, a PUPIL or GENTLEMAN PARTNER for BEE-FARMING in Austria. Address FÜRNERANZ, Meran, South Tirol. 3327

THE DEPOSIT SYSTEM.

British Bee Journal and Bee-keepers' Record.

OFFICE: KINGS LANGLEY, HERTS; AND

17 KING WILLIAM STREET, STRAND, LONDON, W.C.

The following are the Rules under which we are prepared to receive Sums of Money on Deposit from persons buying and selling goods.

In order to save trouble it is requested that the Rules be carefully read over by persons using the Deposit System of trading.

DEPOSITING.

1. **Method.**—When strangers are dealing together, the purchase-money of the articles is deposited at our office. We acknowledge receipt of the deposit to both parties, and hold the money until we are satisfied that the purchase is concluded. If a sale be effected, we remit to the seller the amount deposited, less a charge of 6d. and the expenses of Post Office Orders and postage, &c. Cash will be forwarded by cheque, Post Office Order, or by Postal Order as preferred. If a sale or exchange be not completed, we return the amount deposited, after making the same deduction. By this means buyers and sellers are secured from fraud.

2. **Deposits.**—Postal Orders (drawn on General Post Office) and Cheques must be made payable to John Huckle, and crossed 'Bucks and Oxon Bank.' The numbers of the Postal Orders should be kept by the sender. We cannot be responsible for any losses that may occur in transit.

3. **Honey on Approval.**—All honey will be sold by sample, which must be sent direct to buyer.

4. **Bee-appliances.**—In ordering, the time allowed for completing the order to be stated to us when sending cash. If maker accepts, we hold cash till transaction is satisfactorily completed, when the amount will be remitted subject to conditions as in Clause 1.

5. **Bees and Queens.**—These will be dealt with entirely by the parties concerned, so far as price, &c., goes, and when the purchase is satisfactorily completed cash will be remitted as per Clause 1.

6. **Goods in Transit.**—These are at the seller's risk, i.e., any damage to or loss of an article on its journey is borne by the vendor; but a rejected article must be properly packed and returned by the same means as was used in sending it.

7. **Carriage.**—The carriage of all goods, except such as are sent by post, is payable by the buyer, unless otherwise agreed. If any article sent on approval be returned, each party to the transaction must pay carriage one way.

BALDWIN'S is the Oldest Establishment in the United Kingdom wholly devoted to Bees and manufacture of

Bee-keepers' supplies. His prices will compare most favourably with those of any other Maker, while for quality of material, suitability and workmanship, he has no rival.

'Why can he give better value for money than others?' Because he spends less in large 'puffing' advertisements, buys in the best markets for prompt cash, has no rent to pay, and personally conducts his own business.

For prices and full particulars of Goods see Baldwin's Bee-keepers' Instructor (and Illustrated Catalogue combined), which 'contains more practical and reliable hints than all the large, expensive books,' post free for 2d. stamps. Address **S. J. BALDWIN, The Apiary, Bromley, Kent.**

N.B.—More than 500 Silver and Bronze Medals, First and other Prizes, and Testimonials innumerable.

CROCUS for EARLY POLLEN.

A FEW Thousand Fine Sound BULBS, to Clear, at 5s. per 1000. Address

P. HARBORDT,

50 GREAT CHARLOTTE ST., LIVERPOOL.

EXTRACTED HONEY WANTED.—One or Two Cwt. of Good Quality. Sample and lowest Cash price to W. DRINKALL, Market Street, Lancaster. 3305

British Bee Journal and Bee-keepers' Record.

OFFICE:

17 KING WILLIAM STREET, STRAND, LONDON, W.C

PURE CANE SUGARS.

For the accommodation of Bee-keepers, guaranteed Pure Cane Sugar will be supplied in large or small quantities through this office at the under-mentioned rates:—

MOIST. (For Household Use.)

	Neat bags, 14-lbs.	28-lbs.	56-lbs.	Cwts.
3. MUSCOVADO	2/7	5/2	10/- 19/6

CRYSTALLISED.

4. DEMERARA	} Crystals	2/9	5/4	10/6	20/6
5. BARBADOS					
6. TRINIDAD					

REFINED CANE.

7. WHITE CRYSTALS (Small)	3/0	5/10	11/6	23/6
8, 9. (Medium and Large sizes, 1/- per Cwt. extra.)				
10. LUMP (Cut Loaf) ... Boxes,	3/3	6/3	12/3	23/6
11. LUMP DUST	3/	6/-	11/9 22/9
12. PRESERVING	3/-	6/-	11/9 22/9

FINE. (For Household Use.)

13. GRANULATED	3/3	6/3	12/3	23/9
14. CASTOR Coarse (15 Fine)	3/9	7/3	14/3	27/9	
16. ICING..	4/3	8/3	15/9	31/-

All above guaranteed made from CANE SUGAR only, and free from BEET, CHEMICALS, etc., etc.

CARRIAGE PAID on Orders over 5/0 (or 28-lbs. Sugar) to London and Suburbs.

COUNTRY ORDERS, not less than 2-cwt. carriage paid at 1/0 per cwt. extra.

(Scotch and Irish orders, special arrangements.)

CHEQUES payable to J. HUCKLE, Kings Langley.

Cash to be sent with order, and purchasers will please observe that if samples are required or replies asked to inquiries, a stamped addressed envelope must be sent, as we cannot undertake cost of postage.

THE
British Bee Journal,
BEE-KEEPERS' RECORD AND ADVISER.

No. 494. Vol. XIX. N. S. 102.]

DECEMBER 10, 1891.

[Published Weekly.]

Editorial, Notices, &c.

OUR PROMINENT BEE-KEEPERS.

No. 34.—J. DENNLER.

We have much pleasure in resuming the sketches of our prominent bee-keepers, and we begin with that of one who is not only a prominent bee-keeper on the continent of Europe, but is also well known to the readers of this *Journal* by his frequent contributions to it.

J. Dennler was born on the 1st of April, 1844, at the schoolhouse of Enzheim, in Alsace. His father was the schoolmaster, and it was at this school that M. Dennler passed his earlier years. Later, when his father retired, M. Dennler in 1878 was appointed schoolmaster to succeed him, and he is still at the same place, superintending the instruction of the children of Enzheim.

M. Dennler commenced bee-keeping when he was only ten years old.

On the 26th of May, 1854, a schoolfellow of his made him a present of a swarm, and his father rather encouraged the son by building an apiary, and he became interested in bee-keeping himself. Four years later, in 1858, the father and son had already thirty-one hives in straw skeps, such as are used in that country. But the honey harvest was always very poor, so that from 1854 to 1867, during fourteen years, they only obtained a surplus of 180 pounds in all. The largest quantity in one year was fifty-five pounds and this was

in 1867. In 1860 they only got fifty pounds from twenty-six hives, but in the five consecutive years, 1860 to 1865, they did not get a single pound of honey, although they always had from fifteen to twenty hives. Such an experience would have disgusted many a would-be bee-keeper, but M. Dennler was made of better stuff, and his energy and perseverance have enabled

him to become not only a master of the situation but of the science also. It is perfectly true that the neighbourhood surrounding M. Dennler's residence is not an Eldorado for the bee-keeper, as we can ourselves testify, having visited him at Enzheim—but it is not the worst place that could be chosen for bee-keeping.

Enzheim is situated in a waste plain, ten kilometres west of Strasburg and about the same distance from the Vosges mountains. Here are a few fruit-trees in spring, rape in April and May, a considerable quantity of *Trifolium incarnatum*, artificial pasturages, a second cut of red clover—and these

are the principal sources of honey supply.

During the last fifteen years M. Dennler has taken his bees regularly to the heather in the Vosges mountains.

The first important work that M. Dennler commenced to study was *Les Abeilles*, by Frarière, but it was not until 1868 that a new era in bee-keeping began to dawn in Alsace. M. Bastiau, pastor of Wissenbourg, introduced bee-keeping with movable combs. M. Dennler was one of the first to adopt the new



J. DENNLER.

method and to become a disciple of M. Bastian, and to propagate these methods. On the 1st of October, 1863, the Alsace and Lorraine Bee-keepers' Society was formed in an alcove of M. Bastian's garden. There were eight present who became the founders. This Society is now a most flourishing one and consists of 4000 members, M. Bastian being still the President.

On May 20th, 1869, a meeting of bee-keepers took place in M. Denner's garden, and he was then elected the Chairman of the Strasburg section. During this year M. Denner visited the congress of German and Austrian bee-keepers at Nuremberg, where, for the first time, he met Dr. Dzierzon and several other eminent bee-keepers, amongst whom were MM. Schmied, Hruschka (the inventor of the extractor), Vogel, and Hamet, all names well known to readers of the *B. B. J.* It was also in this year that he first commenced writing articles on bee-keeping in the *Apiculteur* of Paris and the *Journal des Fermes et Chateaux*, edited by Pelletan.

The war of 1870 interrupted the progress of apiculture, which had been so well commenced in Alsace; but in 1872 the dormant energies of bee-keepers were again aroused, and another good start was made.

In 1873 M. Bastian started the journal called the *Elsass-Lothringischer Bienen-Züchter*, and made M. Denner editor, giving him as a colleague M. Zwilling, and appointing these two gentlemen as lecturers in Alsace and Lorraine. Both French and German are spoken in Alsace and Lorraine; therefore it is necessary for the lecturers to know both languages, and it is for this reason that the journal is printed partly in French and partly in German.

From this time scarcely a year has passed without M. Denner's visiting some exhibition, and he has generally been successful in securing prizes, so that he has a fine collection of medals and diplomas. He thus has successively visited Germany, Austria, France, England, and Switzerland. He considers that he has been specially favoured by being able to study the various methods in the apiaries of the leading bee-masters of Europe:—In Germany, with Dr. Dzierzon at Karlsmarkt, Schmied at Eichstadt, Huber at Niederschopfheim, &c.; in Switzerland, with M. Bertrand at Nyon, and J. Jeker at Olten; in France, with the Abbé Collin in Nancy, Hamet in Paris; and in England, at our apiary in Horsham, and Mr. Abbott's at Southall. M. Denner always speaks with particular gratification about his visit to England, as it was at our country residence in Horsham that he met some of the leading bee-keepers in England, as well as Mr. Gravenhorst, of Germany, and Mr. Newman, of Chicago. It was also there that he, Mr. Gravenhorst, and Mr. Newman were each presented with a silver medal of the British Bee-keepers' Association as a souvenir of their visit to this country. When we look at the photograph of the group of bee-keepers there assembled, it makes us feel quite sad to think that five of those present are no longer with us.

M. Denner has had very great experience, and, after having tried *all* the different races of bees known to this day, he has gone back to the common native bee, and is convinced that, as far as regards energy and mildness of temperament, it deserves preference of all others. The principle which he adopts is summed up in a few words. It is, *to have only young vigorous queens of one year old, or, at the most, two years. These produce strong colonies, which only can give good results, and are able to winter under the best conditions.* With such queens the hives must be very roomy, and capable of enlargement according to requirements.

M. Denner has at present 30 hives. The 25 hives wintered in 1889-90 gave him 15 swarms and 1275 pounds of honey, and 20 pounds of wax, obtained from old combs melted down, and which he converts into comb foundation. He keeps a good stock of spare combs, of which he has from 500 to 600. He sells his honey at 75 marks the 100 pounds, or retail at one mark a pound.

As a writer, M. Denner is well known to our readers, and his reviews of Continental bee-papers, which appear in the *B. B. J.* from time to time, are read, we are sure, with much interest.

M. Denner has also written a number of pamphlets. *Le Miel et son usage* is in its fifth edition, and the German one on *Der Honig als Nahrung* is in the fifteenth edition. *Das Bienenwachs und seine Verwertung* we have translated into English under the title of *Bees-wax; its Economical Uses and Conversion into Money*. It is a pamphlet well worthy of study by any one interested in wax. *Die Wachsmotten* is another useful pamphlet on the wax-moth.

M. Denner is in the prime of life, and we hope he may long continue in health to work for the advancement of bee-keeping.

NEW USES OF PERFORATED ZINC QUEEN-EXCLUDING BOARDS.

ADDRESS BY F. H. CYRENIUS.

In presenting this subject for your consideration it is principally with a view of your careful criticism more than to lay down rules for you to follow. For excluding the queen from the boxes is of no account to me, which was, if I am correct, its first cause of invention.

Having already described its use for finding or separating the queen from the colony, by shaking the bees upon a sheet between two hives, or arranged in a hollow box for the purpose of allowing the workers to pass through, leaving the queen behind, is a satisfactory way for finding shy queens.

To arrange for non-swarming extracting: just before swarming, divide the bees and brood, just as you would to make a swarm—placing one-half the bees and brood in a new chamber, filling the vacancies in both hives with empty comb or foundation, and place one above the other, with

a sheet of zinc between. The queen must remain in the lower hive. This operation will prevent all swarming if done at the proper time, until the lower hive is again filled with brood.

We have taken nothing away from them, they have room for eggs below and honey above in the empty combs or foundation, and, as the brood hatches in the upper chamber, they will have more room for honey. At time of extracting again, take about one-half of brood from the brood nest, place in chamber, and change from the chamber of the brood nest the empty combs.

This principle of drawing part of the brood from the brood nest, and replacing it with empty comb or foundation at proper intervals, with me entirely prevents swarming, and by placing the removed brood in the upper chamber, keeps the colony very strong and in good working order. In a heavy flow of honey, add an extra chamber, if necessary.

I heartily recommend Mr. Doolittle's plan of rearing queens in the upper chamber, and, to this end, place the chamber with the entrance opposite to the lower entrance, and nearly all the queens hatched will be fertilised, and begin laying in the brood chamber, at which time it may be placed on a new stand, and you have a fine swarm with a young laying queen. Repeat the operation again if more increase is desired.

Cannot this principle be carried out for box honey, viz.: Draw part of the brood from the brood nest, fill out with comb or foundation as before, put on boxes, place the brood on top of boxes, or at the side of the old hive, and occasionally shake them in old hive, or allow them to enter, as they hatch and are old enough, through a bee-escape, carrying out the same principle of removing brood from brood nest to prevent swarming, and returning the hatching bees to keep up the full strength of colony.

The above methods are for out-apiaries. I can only speak for the extractor-method with experience, which is perfectly satisfactory to me.

My next progressive step, with the aid of zinc, is to assist in queen-rearing.

How annoying to find one queen, just hatched out with a swarm, or all other cells torn down!

I made a number of zinc cages, the object of which was to allow the bees to pass out and in, to give the enclosed cell all necessary care, and to have the queens hatched all caged.

A cell of any age may be placed in the cage, upon wire arranged for the purpose, and by dividing a L. frame into three sections, by two strips horizontally nailed into the frame, we can place six cages upon each section, making eighteen in each frame. So you see a great many queens can be reared in one hive at a time, and you may get them as desired.

Last season was my first experience with them, and the result was very satisfactory. Any cells I wished to preserve were placed in cages, and as they were hatched I could select or reject them, which is an advantage I did not appreciate until I used the cage.

My next plan was to make a section honey-box with movable tin slides and zinc bottom,

with a fly-hole out of section case, and by the use of one 'box' we can rear queens and have them fertilised, and begin to lay, caged in a single 'honey-box.'

Next came to my mind the idea of a zinc division-board, thinking that it would be more effective for many purposes than solid wood. For fertilising queens we have only to insert the zinc board between the outside comb, provided with cell or virgin queen with entrance provided, and we soon have a laying queen. Thus we can, with a few hives, arranged in this way, secure the fertilisation of a large number of queens in a short space of time, without interfering with the full hive any more than to rear a queen in an upper chamber.

Two or more queens may be kept in one hive by the use of zinc division-boards. The boards may be made of very thin lumber with narrow strips of zinc, to save expense.

In the foregoing I have avoided as much as possible entering into any discussion of management, only as it came in contact with the new uses of perforated zinc.—*American Bee-keeper.*

HUNTS BEE-KEEPERS' ASSOCIATION.

A meeting of the Hunts Bee-keepers' Association was held on the 21st ult. at the 'Fountain' Hotel. Mr. J. Linton presided, and there were also present the Rev. C. G. Hill (hon. secretary), Messrs. A. W. Marshall, C. N. White, J. H. Howard, E. Allen, W. H. Woods, Z. Hobbs, and Mrs. Allpress. The prizes won at the St. Ives Show were distributed to the winners, Messrs. W. H. Woods, E. Allen, R. W. Allpress, A. Sharp, C. N. White, Z. Hobbs, and Mrs. Allpress. The Hon. Secretary suggested that Mr. Woods having gained so many prizes this time, they would not look to him gaining medals at future shows. Mr. White observed that it would be advisable to have a rule to the effect that no member should take the medal two years in succession. A discussion ensued on this point, in which the Rev. Hon. Secretary, Messrs. Woods, White, Marshall, and others took part, as to the desirability of members being eligible to compete for the B. B. K. A. silver medal in successive years; but, after opinions for and against had been expressed, the matter was allowed to stand over without any definite action being taken.

The Hon. Secretary then suggested that they should endeavour to get bee-keeping taken up as a technical subject by the Hunts County Council. He felt it both desirable and useful that the County Council should take up the subject, and have lectures in the different parishes throughout the county, so far as they could arrange for them. Mr. Woods said he believed that in other counties the County Associations were receiving grants from the County Councils, and the Bee-keeping Associations were doing the work.

Mr. Howard remarked that in Lancashire and Cheshire the County Councils had entrusted the L. & C. B. K. A. with a sum of 150*l.* to spend

on lessons in bee-keeping, and the Association, thinking no better authority could be had than that of the Educational Committee of the British B.K.A., have, on the recommendation of that body, already appointed their lecturer or teacher. In the event of a grant being made by the Hunts County Council, he thought the wiser course would be to leave the matter in the hands of those who actually knew what was required, and they could not do better than entrust the expenditure of their money to the Hunts Bee-keepers' Association. After some further discussion it was decided that the Hon. Secretary write to the County Council, asking that part of the money devoted to technical education should be expended on lectures on bee-keeping in the county.

HONEY IMPORTS.

The total value of honey imported into the United Kingdom during the month of November, 1891, was 1150*l.*—From a return furnished by the Statistical Office, H.M. Customs.

Correspondence.

The Editors do not hold themselves responsible for the opinions expressed by correspondents. No notice will be taken of anonymous communications, and correspondents are requested to write on one side of the paper only, and give their real names and addresses, not necessarily for publication, but as a guarantee of good faith. Illustrations should be drawn on separate pieces of paper. We do not undertake to return rejected communications.

Communications relating to the literary department, reports of Associations, Shows, Meetings, Echoes, Queries, Books for Review, &c., must be addressed only to 'The Editors of the "British Bee Journal," 17 King William Street, Strand, London, W.C.' All business communications relating to Advertisements, &c., must be addressed to Mr. J. HUCKLE, Kings Langley, Herts (see 1st page of Advertisements.)

** * * In order to facilitate reference, Correspondents, when speaking of any letter or query previously inserted, will oblige by mentioning the number of the letter, as well as the page on which it appears.*

NOTES BY THE WAY.

[873.] The thanks of bee-keepers should be extended to the 'Atlantic Transport Company' for their generous offer to carry exhibits free of charge from England to America for the World's Fair. Now, brethren of the craft, shall we make an exhibit at the 'Fair' or not? If so, shall it be a collective exhibit on a grand scale, worthy of our craft, or merely left to individual enterprise to send a small, insignificant parcel, that will look like a pigmy among giants? Give your opinions and thoughts on the subject during the coming months, so that preparation may be made in good time, and if the idea gets a good foothold with British bee-keepers, we shall be able to select some of the best honey of 1892 to represent our industry at the great World's Fair in the spring of 1893.

The reports of our Berkshire experts start many thoughts on the subject of bee-keeping. We can say with Galileo, 'Still it moves.' The proportion of bar-frame hives is encouraging to those who, during the last ten years, have per-

sistently, in season and out of season, advocated their adoption, not only on lines of humane treatment of the busy bee, but also on lines of utility; and I fear no contradiction when I affirm that where bee-keeping has been conducted intelligently, there has been more than double the profit on bee-keeping under the modern system than under the old system of straw hives, be they never so carefully supered and extended during the honey harvest. In the bar-frame hive we have an expansive hive, suitable alike to the years of poor honey harvests, when it is contractible to the colony's and season's wants, and capable of extension to the requirements of the mighty band of workers, 40,000 to 50,000 strong, in the good season. In the poor season, by careful attention, a surplus may be secured—or, if not a surplus, some honey may be secured—and the colony, for a small outlay of a few shillings, may be fed up for the winter, and experience has taught us that bees do well if fed up early in the season with syrup made from good, genuine cane sugar. Then, in a good season, we have every advantage that bee-keeping offers all concentrated in the bar-frame hive:—First, complete control of the brood nest, which, by judicious care, we can fill to overflowing with bees just in the nick of time to secure the early honey-flow, whether it be from fruit, sycamore, or turnip blossom in May, or from white clover in June. Second, the expansiveness of the hive. If you desire to see the possibilities and extent to which modern hives can be supered, go to the 'Bee Department' of the next great agricultural show in your neighbourhood, and you will see hives with supers piled up story on story, capable of holding at least one hundred weight of honey—not a bad harvest from one hive in a good season. In actual work in the apiary one rarely uses all these supers on a hive at one time. In my own apiary, which is run on purely commercial lines, I rarely use more than two crates on at one time, sometimes, in extreme cases, three; but the extent to which the hive of to-day can be extended to suit the wants of the colony, and the time and convenience of the modern apiarist, is wonderful compared to the hide-bound old skep in which our fathers kept bees. Third, the bar-frame hive is the best home of the honey-bee from a utilitarian point of view. In the skep its brood nest was cramped and cabined; thus, the queen, or mother, was debarred from the full exercise of her ovipositing powers, with the consequence of a diminished colony early in the season, when the busy bees' services are required most for the fertilisation of the fruit-blossoms and other early-flowering plants and trees. The interior could not be inspected and its contents discovered by the bee-keeper; he could only judge of its stores by weight and age if an old stock hive. Allowance in the weight must be made for pollen-clogged combs, &c.: but with the movable-frame hive the bee-keeper has every part of the hive under his view: he can decide to a nicety how much food the hive contains, the condition of the combs,

which shall be discarded and which retained, the size of and condition of the colony, and any other item of knowledge required for the well-doing of the colony. The Moreton (not Morton) bee-keeper, who is represented as destroying thirty-five stocks of bees in straw hives to obtain 200 pounds of honey, may well envy Mr. Whittle, of Lockinge, who secured the same amount from two frame hives, and has his bees still on hand, ready to beat record another year. Facts such as these speak more loudly than long, windy paragraphs, and call loudly for education on a subject of importance such as bee-keeping. The best methods of reaching the old-style bee-keepers must be decided on by progressive members of our fraternity, and then if facts illustrated by *l. s. d.* will not arouse them to a better system, we shall have to endeavour to reach and teach our growing lads and lasses the elementary lessons of bee-keeping, as I am convinced there is no subject of technical educational knowledge that will better the condition of our rural population so much as bee-keeping; and if we can double the number of bee-keepers in our villages, or even quadruple the number, I have no fear of over-stocking the country with honey. Why, our present output of honey is but a very small quantity per head when equally divided amongst the thirty odd millions who exist in the United Kingdom, while the last few years' imports have proved that honey is becoming more and more of a staple article of food than formerly, no doubt owing in a great measure to the constant teachings of the various bee-keeping associations throughout the length and breadth of the land by their honey shows, by pamphlets and by 'periodicals' connected with the pursuit, and occasional articles in the newspapers. Therefore, I say, let our motto for 1892 be *en avant!*

Bell-glasses.—I notice a correspondent inquires how to work bell-glasses. Kindly allow me to add to your instructions that, in practice, I always found it best to attach a board of suitable thickness. Thus, for a ten-pound bell, a quarter-inch board; for a twenty to thirty-pound bell-glass, use a half-inch; and for one from fifty to one hundred pounds, an inch board is suitable. Stand your glass on the board, and then mark the size with pencil; now cut the board, leaving, as the old carpenter said, your witness of size, *i. e.*, the pencil-mark. Now cut a hole in centre of board to allow access to the super, and after waxing the crown of your bell-glass with starters, attach the board and glass with strips of paper glued around the edges of glass and board. An excluder can be laid on frames or crown of skeps if desired, or the whole aperture can be left open to the bees. Bell-glasses require wrapping up nice and warm; an old blanket makes a good wrap.—W. WOODLEY, *World's End, Newbury.*

AN EXPERIENCE OF UNITING.

[874.] I commenced the season with five stocks. From these I took about 125 pounds of

flower honey, after which I took them to the moors (eleven miles), and they did pretty well there in the short spell of hot weather in September, but during the first twelve days I lost my best hive from hunger. I had it doubled for extracting; gave it a set of empty frames for the heather, not troubling to examine the combs in lower chamber to see that they had stores. From this neglect, and bad weather following, they were lost. This is another lesson to me: there is never a season but we learn something in bee-experience. Well, I took about thirty pounds of heather honey, and left them abundance for the winter; so I had an average of thirty-one pounds per hive. All the hives swarmed, but I only formed one new stock, returning or joining all the others. I must here record a complete failure of the 'flour dodge.' In joining a second swarm to a first, both from one hive, I dusted the bees in the hive I was going to join to, removing every frame, and dusted both sides of the comb; and I also took the queen from them, as I wished the young one to preside. I then put some sections on the hive, and quilted down. By this time the swarm had settled in a skep. I dusted and re-dusted them, shaking the bees well up in the skep; then threw them on a board in front to run in. Well, they made straight for the entrance, but the war-cry was sounded, and a more determined pitched battle never was fought. The dead and wounded were scattered all around—nothing would stop the carnage; but through all this confusion the young queen had managed to enter the hive, and was saved. For the rest, instead of being stronger, the stock was weaker. I managed to change all the queens in the swarming process, and, considering the weather we have had, am well satisfied with the season's work. Ever since the end of August the bees have been bad to manage, very savage, addicted to robbing, and, in fact, as full of mischief as bees can be. I have other little experiences to relate, which may be told in another letter.—A COTTAGE BEE-KEEPER, *Harrogate.*

[It is more than probable that removal of the queen has caused the mischief. The time occupied in 'putting on sections,' &c., may have enabled the bees to recover from their 'dusting,' and become excited over the loss of the queen; this might very possibly render them in unfit condition for uniting safely. Under the circumstances, it would have been better to have reduced both lots of bees to the condition of swarms, treating both alike, and throwing them out in front of the hive to run in together. It should be understood that in uniting bees, using flour as a pacifier, 'dusting' should be as nearly simultaneous as possible with both lots.—EDS.]

A REPLY.

[875.] Your footnote to my last letter (857, p. 541) I took to be a gentle hint to me to 'stop talking.' I should have been content to have allowed the matter of experts' certificates to drop had not Mr. Harbordt and his champion, Mr. McClure, tackled me. The drift of my

remarks has been misunderstood, partly, as I think, by your repetition of the charge of 'unkindly flinging—this time at a gentleman who has been appointed to an important and honourable position.' I beg, therefore, for space in your excellent *Journal* to reply.

It would certainly be 'absurd' to hold Mr. Harbordt responsible for his appointment. The Committees that approved—it appears I was in error in saying 'recommended,' but Mr. McClure so expressed it—and appointed Mr. H. are the responsible parties, and surely there could be no great harm in inquiring how a gentleman, who declined to commit himself to any expression of opinion as to the efficacy of remedies for 'foul brood' to his own private customers, could do so in public, especially as this was made the test of fitness for the office, at least so far as advice on 'foul-brood' treatment and remedies are connected. Mr. Harbordt's explanation is ample and sufficient; but Mr. McClure will have to allow me to say, that the absence of the new cures from the catalogue I quoted from is not necessarily a 'convincing' proof that it is of ancient date.

Mr. McClure is quite correct in stating that I am not a member of his Association, and, for that reason, I could not well ask his Committee for information. It is a public question, and I prefer to treat it as such. So far from being scandalised by the paragraph I quoted from Mr. H.'s capital *multum-in-parvo* catalogue, I admire such a frank statement, and, indeed, the catalogue, as a whole, evidences great care in compilation: sound advice, and suitable observation on all the various points in bee-keeping are given; and, if I can escape a charge of obsequious flattery of Mr. H., I will go so far as to say his hives are very ingeniously devised, and well suited for the uses for which he recommends them. These are facts that speak volumes as to his suitability for the honourable position he now fills.

The fault—or rather the point where I disagree with the Committee of the L. & C. B. K. A.—is the making of that 'at present little understood disease called "foul brood"' the touchstone whereon to try the qualifications of candidates for the office of Technical Instructor in Lancashire. So little is apparently known of this bee-malady, even by the best-informed among us, that there is nothing else for us to do but approach the subject in an inquiring spirit. The time to lay down inelastic rules as to its treatment has not arrived, and I maintain that any experienced bee-keeper might very well be trusted to handle the matter in a masterly manner should he be confronted with the pest, even if it be the first time for him to meet it.

There is a touch of sarcasm in the concluding paragraph of Mr. McClure's letter. He asks my assistance. I always say a good word on behalf of the bees when I have an opportunity, but I am afraid my ways and those of his Committee will not assimilate. A world calm as a mill-pond is a philosophical ideal not

easily realised, and I am glad to hear that the success of the L. & C. B. K. A. is, in a measure, due to its meeting from time to time with kindred natures to mine. It is the restless spirits that salt the earth.—ALFRED DON-BAVAND, *Whitby Heath, Chester, December 5th, 1891.*

CURIOUS BEE-DECORATIONS.

[876.] Huber's letter of 14th May, 1804, published in your last issue, raises an interesting question. 'What was the explanation of the phenomenon of the "coloured knobs on the bees' heads?" It would seem to be connected with a matter that has often perplexed me.

In 1609, Charles Butler, of Magdalen College, Oxford, published *The Feminine Monarchie or the Historie of Bees*. I now quote from the second edition, dated 1623:—"Besides their Sovereign, the bees have also subordinate Governours and Leaders, not unfitly resembling Captaines and Coronels of Souldiors. For difference from the rest they beare for their crest a tuft or tossell, in some coloured yellow, in some murrey' (viz., dark red or mulberry) 'in manner of a plume; whereof some turne downwards like an Ostrich-feather, others stand up like a Hearne-top' (Heron's crest), 'and of bothe sorts some are greater and some lesse, as if there were degrees of those dignities among them. In all other respects they are like to the vulgar. . . . In lesse than a quarter of an houre you may see three or foure of them come forth from a good stall; but chiefly in Gemini' (latter part of May), 'before their continuall labour have worn these ornaments.'

Again, Samuel Purchas, Master of Arts, and Pastor of Sutton, in Essex, in his book, *A Theatre of Politicall Flying-Insects* (London, 1657), notes the same fact in almost the same words as Butler, but not quoting from him. He continues:—"Mr. Butler supposeth them subordinate Governours and leaders, as Captains and Colonels. They are seldom seen but in May and a little after: that they have any authority or command over the rest, or special place about the Queen Bee I believe not. This I am sure, I never saw any one of them attend her in her short progresses. Their working, I conceive, wears off this ornament.'

Now, the brains of ancient bee-keepers teemed with wild and wonderful imagining. But by the beginning of the seventeenth century special attention seems to have been turned to bee-keeping; and of that art, as of the kindred art of gardening, our forefathers took to thinking and writing for themselves. Moreover, Butler was a learned and sensible writer, as also was Purchas. The profession alone of the latter entitles his words to respect. The latter part of his book in question consists of shrewd and moral exhortation to his readers, which show a considerable knowledge of bee-life.

Hence, even allowing for exaggerations in dealing with a hobby, we must believe that these gentlemen saw, or thought they saw, peculiari-

ties in the appearance of their bees of which in these days we hear nothing. Huber's letter, however, gives some hope of an explanation. Any light, editorial or other, thrown on the subject will be welcome to—A SOUTH DEVON ENTHUSIAST.

[The phenomenon mentioned by Huber, and also by the other writers quoted, no doubt referred to the pollinia of orchids. In spring-time, when the *Orchis mascula* is in bloom, bees are occasionally seen bearing on their heads, just between the antennæ, what look like small knobbed horns, as in the cut (Fig. 1). These horns when magnified present an appearance like Fig. 2, and are in



Fig. 1.

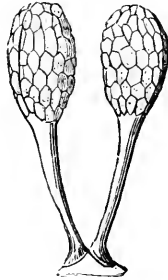

Fig. 2.

reality the pollinia of the flower which in a very marvellous manner the bee carries off on its head to effect the process of cross-fertilisation. Full and interesting particulars of the way in which this is accomplished appear in our issue for May 28th last. Eds.]

SKEP BEE-KEEPING.

[877.] A farmer, in course of conversation, told me he had some bees he wanted taking, and I arranged to drive them for him at his farm, near Harrogate. Several persons had been asked to witness the operation, and while waiting their arrival I examined the farm apiary. There were seven or eight skeps and one frame hive, all on one stand, formed by a plank not wide enough for the hives. Some had coverings, others none; some had the feed-hole on top of the skeps, stopped with rags, through which the bees had eaten their way; yet in this wretched state some of them had wintered well and swarmed, while two or three were a good weight.

I was asked to begin on the frame hive, and take it first; but, on trying to remove the roof, found it stuck fast and immovable. I next tried the floor-board, but it was nailed to the hive-body, so we could make no entrance that way. I gave the bees a dose of puff-ball, carried them away to a distance, and laid the hive on its side, using a lump of wood for a battering-ram. I knocked off the top, and found combs hanging from the top of the roof; some came out whole, others broke off half-way. I will not pretend to describe the job I had, but I cleared the hive of bees and honey—and it was full, every inch of it. I vowed that night that, if ever I tackled

another bar hive of that description, it would have to be my own.

We next proceeded to operate on the skeps, some of which were heavy; but, in spite of my remonstrance, the farmer would have me drive a swarm which was so light as to be not worth taking. However, it was only a ten minutes' job, and I got a grand hive full of bees, while my friend had for his share about two or three pounds of honey. But, after all, this is the kind of bee-keeping that pays—it costs nothing!

Another instance of skep management and I will conclude. A cottager in Harrogate had spent two evenings in trying to drive the bees from a skep, but failed. He then sent for me, but I could not go for three days, and, on reaching the place, I found a small shed, with one stock of bees inside working, and one hive standing on an old box outside covered up, the crevices being carefully stopped to keep the bees in (or out). I turned it up, and found about a basinful of bees, which might, or might not, belong to it. The hive was a large one, full of comb, in which was not more than half a pound of honey; yet the owner and his son declared it was as much as one man could lift when they removed it from the shed three days before; of course, it had been robbed.

Don't take these as an average sample of Harrogate bee-keepers. We have a B. K. S. at Knaresborough, and a few thorough good bee-keepers.—A COTTAGE BEE-KEEPER.

BEEES FOR SOUTH AFRICA.

[878.] Mr. J. Brown, of Court Farm, Failand, near Bristol, thanks his many correpondents for their great kindness and advice respecting an inquiry as to the best method of 'packing bees for export,' and begs to state that he is going to prepare one of his queens, with about one hundred workers, for sending out to South Africa, arrangements being made to keep them in the cool chamber of the steamer while on board. In due course he proposes to report in *B. J.* how this plan succeeds.

BEE-KEEPING IN LINCOLNSHIRE.

(Concluded from p. 555.)

[879.] September 4th was spent with Mr. Ainger in visiting the apiaries of local bee-keepers—Messrs. Winter, Briggs, and Ainger. In the afternoon we walked to Nettleton and Holton, and returned in time for the meeting of bee-keepers referred to. The chair was taken by Gerard Young, Esq., of Claxby House, one of the Vice-Presidents and a good company got together.

On Saturday morning I left early, and called upon Mr. Young, and I found, again, though bee-keepers were complaining in the neighbourhood of the badness of the season, that Mr. Young had been fairly successful. Mr. Young goes in for extracting, and his average all round was sixty-five pounds.

Gainsborough District.—I next proceeded to Gainsborough, where I was met by the District Secretary, Mr. Cribb. We first called on Mr. Bettison and examined his apiary, consisting of ten stocks, which were being rapidly prepared for winter. We then went through Morton, Sowerby, and Corringham, but found only moderate results, though bee-keeping was being carried on in an intelligent manner. Mr. Cribb is just the enthusiast a district secretary should be, and his apiary, though small, is admirably managed. He commenced bee-keeping in 1888, and has since done well with his bees. The district is evidently a good one, and well looked after.

Brigg District.—Bee-keeping here does not appear to be very successful, although the district, according to Mr. Edlington, is not to be beaten for white clover. With Mr. Edlington I proceeded to Wrawby, to call upon Mr. Taylor, whose apiary, consisting of ten bar-frame hives and three skeps, is a model for neatness, management, and general success. The yield has been between 400 and 500 pounds. We next proceeded through Bigby, and thence took train for Goxhill, calling on a practical bee-keeper in each place in the persons of Mr. Robinson and Mr. Catley. This ended my first two days' round.

Louth District.—On September 11th I visited Louth in company with Mr. H. O. Smith, but the only apiaries of which anything satisfactory can be reported are those owned by Messrs. Gillot and Moody, whose stocks were neatly kept and well cared for. We examined some of the twenty-seven stocks constituting Mr. Smith's well-managed apiary, but owing to illness just at the busy time of the year his surplus was only moderate. The district must be a good one, as in 1887 one hive in this apiary gave 215 pounds, eighty of which were in sections. Want of time, unfortunately, prevented me from seeing Mr. Godson's apiary, as I understand that the Hon. Secretary of the L. B. K. A. is one of the most practical bee-keepers in the neighbourhood, and one who makes his own hives.

In the *Wragby District* Mr. Banks has his work 'cut out,' as bee-keepers are few and far between, and in many instances the old-fashioned system prevails. His own apiary is successful, as is that of Mr. N. Duckering, of East Barkwith.

Spilsby District.—Mr. S. G. Spence took me round the neighbourhood. At Halton I found two old bee-keepers, Messrs. Baker and Heath, who were among the first members of L. B. K. A., and the first in the district to take the *B. B. Journal*.

Wainfleet District.—From Spilsby I went to Wainfleet, where I once more enjoyed the hospitality of Mr. and Mrs. Martin. Early next morning Mr. Martin placed a horse and trap at our disposal, and, along with Mr. G. Booth Walker, I started on a tour round the district. Captain Hurrell, whose apiary was badly treated by the hurricane in the spring, was first called upon; then we saw Messrs. Gray (Burgh),

J. W. Kemp (Firsby), R. W. Dunkley (Eastville), and Pidd (New Leake), who, though a beginner, was doing well. He had taken 117 pounds from his seven stocks, and had erected a capital manipulating-house. We also called upon Mr. Mason (Leake), Mr. Vinter, and Mr. A. Abraham, the latter having done well by taking from two stocks 140 pounds of honey, and two swarms in addition. We were commissioned by Mr. and Mrs. Martin to invite the bee-keepers visited to tea and a bee-chat. The meeting took place on the evening of September 15th, and was well attended. After tea the party adjourned to, and well filled, the study, and there spent some hours in a pleasant bee-chat. Such meetings might, with advantage, be held in other parts of the country.

Stamford District.—My next stop was at Stamford, where I was under the direction of Mr. Baxter, who, though a beginner, had taken 123 pounds of honey, and had eight grand stocks. Mr. Reedman and Mr. Broughton, though in small way as bee-keepers, have stocks in good condition. Mr. Fancourt, also a beginner, drove us to his apiary, where great progress has been made in a short time.

My last stay was for an hour or two at *Bourne*. Here Mr. Garner, of Dyke, drove me to his apiary of six stocks, all in well-made and neatly kept home-made hives. Mr. Garner thinks no trouble too great for his bees, and he therefore makes all his appliances except sections. A wooden octagonal extractor, most accurately made, and many other contrivances, scattered round the workshop, gave evidence of much thought and labour. Before starting for home I examined two stocks belonging to Mr. Hill (Bourne) and found them in first-class condition, and well protected in comfortably packed and nicely painted hives.

I close my report with sincere thanks to Mr. Godson and to the bee-keepers generally for the kind manner in which I have been treated, and trust the assistance and advice given may prove not only beneficial to bee-keepers, but of some value in making bee-keeping on modern principles more interesting, whether pursued as a hobby or with a view to pecuniary advantage.—C. N. WHITE.

Queries and Replies.

[459.] *Moist Sugar for Wintering on.*—1. Is moist sugar, wrapped up in muslin and put on the top of the cluster of bees, good for winter feeding? 2. Ought naphthaline to be kept in hive all winter, when stocks are healthy? 3. Will bees stop in hives which rats have got into?—A MIDDLESEX BEE-KEEPER.

REPLY.—1. We don't go so far as to say the plan you inquire about is good for wintering, but it often answers very well. 2. Yes. 3. Whether the bees would stop in hives which 'rats have got into' would depend on whether the rats were allowed to stay there or

not, and we need hardly say this last contingency will depend entirely on the bee-keeper allowing the intruding rodents comfortable quarters or otherwise. *He* should vote for the 'otherwise.'

[460.] *Getting Bees into Sections.*—I have just bought three stocks of bees, some in frame hives, and being 'rather keen,' have quickly made three first-class wooden hives for next season; but being informed yesterday by a friend that last season he could not get his bees to enter the sections, 'with the exception of one bee,' this is somewhat disappointing, and I therefore wish you would kindly inform me 'how to get the bees into the sections,' otherwise I must stick to the straw hives.—**BUMBLE.**

REPLY.—The fact of having 'quickly made three first-class hives' suggests the inference that you had read up the subject, though lacking practical experience of bee-management. In view of this, it is not easy to see why your friend's failure should be so 'disappointing' as to cause a surrender of the frame-hive principle, as indicated. Surely it is sufficient to know that those who understand the management of frame hives *can* get bees into sections, or give a very good reason for failure? This being so, we trust our correspondent will place some reliance on what others have done with frame hives, and for the information asked we may refer him to our issue of June 18th last, where full instructions 'how to get bees into sections' appear.

[461.] *Bees near Town.*—I am residing in one of a terrace of houses overlooking Wandsworth Common. The houses are higher than any in the immediate neighbourhood, and the attic at the back looks clear away over the chimneys of the streets at the back. Now, would it be advisable to keep one hive of bees at the said attic window (the place at the back is very thickly populated), or would you keep them a mile away, where I have convenience? Do you think it possible that they could be any nuisance here?—**J. C. EAST.**

REPLY.—If it is merely a question of the bees becoming a nuisance to neighbours, we should say the height from the ground at which it is proposed to keep them, coupled with the situation in which the house stands, would entirely remove that difficulty. On the other hand, removal a mile further out into the country would increase the bees' foraging-ground, and correspondingly improve their chances of doing well.

[462.] *Wintering Bees in Outhouses.*—1. I have plenty of outhouse room to accommodate my bee-boxes. Will it not be better to keep them there than in the open during the winter? If dryness and warmth are essential, it seems to me that bees would be much better in a house than outside while they are dormant in the

winter months. 2. If I decide to give candy before spring, how am I to get the cakes properly on the bars without some of the bees getting out? So far as I know as yet, this is an impossibility, at least, judging from my little experience. 3. Would it be quite safe to bring boxes of bees from a distance by rail or otherwise during winter? 4. I prize your *Journal* very much since I began to keep bees and to take it in. Could you not try to stir up the Belfast Association a little? There was a good flower show here a fortnight ago, and three dozen sections of honey, with a few small bottles of extracted, as the only exhibit in the bee-line, and nothing else all the year!—(REV.) GEO. T. REA, *Holywood, Belfast, December 2nd, 1891.*

REPLY.—1. The plan of moving bees into outhouses during severe weather leads to trouble and difficulties eventuating in mischief of many kinds. It has been tried and failed. By far the best plan is to protect the hives on their summer stands, and leave them there. 2. Any trouble in the way indicated may be overcome by placing the candy over the feed-hole in quilt, and covering with a shallow box, to keep in the bees when the candy is consumed. 3. Yes, presuming that care is used. 4. Thanks for your appreciation. Would not the personal efforts of a few earnest bee-keepers on the spot do more in the direction you indicate than anything we could do?

WEATHER REPORTS.

WESTBOURNE.

November, 1891.

Rainfall	4.00 in.	Sunshine	51.25 hrs
Heaviest fall	1.03 „	Brightest	
	(on 10th)	day (3rd)	6.85 „
Rain fell on	17 days.	Sunless days,	11.
Average	3.48 in.		
Max. temp. 52° on 2nd.		Mean max.	46.8°
Min. temp. 27° on 26th.		Mean min.	34.7°
Min. on grass, 20° on 23rd.		Mean temp.	40.8°
Frosty nights, 14.			L. B. BIRKETT.

BUCKNALL, LINCOLN. BM. 25.

November, 1891.

Maximum	55° on 18th.	Minimum on	
Minimum	21° on 7th.	grass, 17° on 7th.	
Mean max.	46.3°	Rain:—2.92 in.	
„ min.	33.1°	Aver. 5 yrs. 2.00 in.	
„ temp.	40.1°	In 24 hrs. .37 in. on	
„ of 6 years	40.8°	10th.	
		Rainy days, 22.	

A dull, foggy month, of average temperature. Bees flying nearly every day; some pollen gathered from wild mustard or charlock.

J. BENT.

Echoes from the Hives.

Garstang, December 3rd.—Season here has been only moderate, my own four hives giving about 160 pounds surplus, about equal parts clover and heather, without the necessity of feeding up for winter.—ROBT. BARTON.

Honey Cott, Weston, Leamington, December 2nd, 3rd, 4th, and 5th.—Thermometer varying from 46° to 52°, and the sun shining warm, the bees have taken advantage to come out in the middle of the day and clear themselves in great force. Even sometimes soon after daylight they were on the move, and I must say I was glad to see them. Even if we get some frost, it possibly may not last so long. I like to see them get a flight every fortnight or three weeks. Of course, if the weather is too severe, it cannot be expected. This mild weather I think it easier to get rid of colds, although mine has not left me yet. Hope 'X-Tractor' has tasted mead, honey, &c., and got cured of his bronchitis.—JOHN WALTON.

THINGS I HAVE NOTED.

1. I have noted that 'old fogysm' in bee-keeping is not yet dead. When we take into consideration the opportunities enjoyed for obtaining information upon the most approved methods of bee-keeping, and the abundant evidence furnished of the remuneration to be obtained in this way above that received according to the old style, one would think that no one could now be found who would advocate and practice the old system. Yet such is not the case. Occasionally in travelling through the country, you come to a farmstead that is ornamented with a few old 'gums,' or hollow logs in which bees are kept in the most primitive fashion, and if you enter into conversation with the owner, you soon discover that he is a man incapable of being taught. He already knows too much, and so it is a waste of wind to try and convince him of the advantages of modern methods over that which he pursues. The large yields of honey obtained by some bee-keepers he takes no stock in, they are either stretchers or frauds unworthy of the credence of any sensible man.

2. That a great many people think they can keep bees without any knowledge of them. They admit the necessity of knowing something about every other department of farming, but imagine they can keep a few bees without any knowledge of their habits, or the best methods of management. The inevitable result is that their bees die the first season: whereas, if they had been at a little trouble in acquiring the information necessary, they might have met with encouraging success, and saved the loss which their ignorance and inexperience have entailed.

3. That a great many people who keep bees do not receive any bee journal. Through a

false economy they try to get along without the slight expense which this would incur, and the result is that they lose in the course of the season far more than a good bee journal would cost. In my own experience I have often obtained from one article information far more valuable, and that led to a financial gain far in excess of the cost of a bee paper. During the eleven years I have kept bees, I have been a constant reader of bee journals, and attribute any little success I have had, very largely to the information obtained from this source.

4. That bee-keeping is too precarious to depend upon entirely for a livelihood. It furnishes a good addenda to some other occupation, but to rely upon it entirely for a maintenance would be to find ourselves some seasons in the position of vagrants, without any visible means of support.

5. That the number of families who do not use honey as a diet is still very large. They get a little occasionally to cure a cold, or because they have a visitor that they have discovered is fond of honey. But as an article of daily food it is seldom thought of and enjoyed. And so it is only very occasionally offered to one, either in private houses or hotels. Now, when we consider its cheapness and healthfulness, that it costs a great deal less than butter and preserved fruits, and will go a great deal farther, it is surprising that it is not in more general use.

6. That bees winter as well upon sugar syrup as they do upon honey. I settled this question satisfactorily to myself the first season I kept bees. One of my neighbours was going to 'brimstone' some second and third swarms so as to get the honey, or 'take them up' as it was called, and I obtained permission to drum out the bees and put them into one of my hives. I put four into one, giving them empty frames and about thirty pounds of syrup, and they came out in spring better than those that had honey stores. Since then I have frequently fed syrup for wintering on, and found it answer as well as the best honey. Now that sugar has become so cheap, it will pay those that have the time to devote to it, to extract pretty closely at the end of the honey season and feed syrup, but let them be sure to use the best sugar, to give it in sufficient quantities, and to clean out the combs that are to be used for extracting in the spring, so none be left to mix with the honey.

7. That bees consume more honey in a mild winter than in a cold, steady one. I know that the opposite opinion is very generally held and stated in bee journals and at conventions. But my experience leads me to believe that in cold, steady winters, bees hibernate or 'lie in a quiescent state,' as friend Clarke would say, and do not consume much stores; whereas, when the weather is changeable and frequently mild enough for them to obtain a flight, they consume much more food. Last winter was comparatively mild, there being frequent thaws, and so, though I gave my bees some five pounds more per colony than I usually do, when I ex-

amined them in March I found that three had died from starvation and others would speedily have followed had they not been fed.

8. That bees winter better on few combs than on many. Some of these colonies which only had five combs to winter on last year, came out much stronger than those that had twice that number, so one of the secrets of successful wintering is to crowd the food and bees into as small a space as possible.

9. That spring protection pays. Last spring was a very trying one on bees that had been wintered in the bee-house or cellar, as it continued so long cold, and the fruit-bloom was so late in opening out. A great many, therefore, suffered severely from spring dwindling. I tried the experiment of putting those I took from the cellar into outside cases or clamps, and packing them with chaff. The result was that they all survived, and became so strong that I could not keep them from swarming.

10. That it pays much better to raise extracted honey than comb. It seems impossible to prevent colonies devoted to comb honey from swarming. When you get them started to work nicely upon the section, they take the swarming fever and nearly all the workers leave the hive, and by the time their place is supplied, the season may be nearly over, and you are left with a large number of sections partially filled. What pays best in my estimation is to go in for extracted honey. Give lots of room so as to prevent swarming, and extract about once a week during the honey-flow. I use the large Jones hive, and tier them up two or three deep, and this last season I must have received as much as 150 pounds from the strongest colonies; whereas some of those for comb honey did not fill one case of sections.—REV. J. CARSWELL, in *'Canadian B. J.'*

WAX SECRETION.

I have been trying to find out just when bees secrete wax, and some other matters. That the reader may perfectly understand me, and what I have to say on the subject, I want you to read several articles in back numbers of *Gleanings*. First, one by Professor Cook, 1891, p. 212. There you will see that he thinks wax is not secreted unless it is wanted to build combs. Now, this is just what I think about wax secretion: That wax is not secreted unless it is needed to build combs. But how is wax secretion brought about? Can the bees secrete wax any time it is wanted for comb-building? I believe they can, and will try to prove it further on.

Now turn to April 15th *Gleanings*, p. 318. Here we have another article from Professor Cook on this same subject, followed by my ideas in the same line. You see, I take the ground that, in order to secrete wax, the bee fills her sac full of honey, and then remains quiet, and wax secretion goes on as a consequence, just the same as a pig fills his sac with corn, and then remains quiet and secretes fat.

Now turn to May 1st number, p. 359, to Pro-

fessor Cook's 'Nubbins.' He says he thinks 'France' makes a good suggestion regarding wax secretion, and says he shall try some experiments to prove or disprove my theory. I hope he has done so, and that others have also, as I don't want to stand alone in this matter.

Now we will turn to p. 421, May 15th number, 'Fragments,' by Bro. Doolittle. You see, he agrees that wax secretion is brought about by the bees holding their honey; but he says that the old bees returning from the field give their loads of honey to the young bees, and that these young bees hold these loads of honey till they are sufficiently evaporated to be deposited in the cells; hence it comes about that it is the young bees very largely that secrete wax. Hold on, Bro. Doolittle. Let me ask whether the bees in your one-comb observatory hive were building comb at that time? If not, what did those young bees do with the wax secreted while holding those loads of honey? Do the bees evaporate their honey by holding it in their sacs? I think not, unless they have no other place to put it. If evaporation of honey was brought about in that way, then wax secretion would be going on all the time, whether the bees wanted it or not. I have seen bees take honey from one another in that way; but how do you know that it was *young* bees that received the honey? I cannot tell a young bee from an old one, unless in case of a very young one just hatched, young enough to be white.

Now let us look at the next fragment by Mr. D., about old bees secreting wax. Read this carefully; and then, if you have also read all the other articles mentioned, you will be ready for my experiment, which I will now proceed to give you. (*To be continued.*)

Notices to Correspondents and Inquirers.

Letters or queries asking for addresses of manufacturers or correspondents, or where appliances can be purchased, or replies giving such information, can only be inserted as advertisements. The space devoted to letters, queries, and replies, is meant for the general good of bee-keepers, and not for advertisements. We wish our Correspondents to bear in mind that, as it is necessary for us to go to press in advance of the date of issue, queries cannot always be replied to in the issue immediately following the receipt of their communication.

C. WEISS (Germany).—The best foundation machines are made by J. Vandervoost, of Laceyville, Pennsylvania, U.S.A., and the Dadants use them exclusively in making their foundation. As you are not able to write in English, address them in German; or, if you prefer it, send on your letter to us, and we will translate and forward it.

SUBSCRIBER (Somerset).—Bees marked 'A' may be taken as a very fair sample of pure Ligurians. 'B' are, as stated, Ligurian-Carniolan hybrids.

W. GUDGEON (St. Albans).—*Super Foundation for Shallow Frames.*—Sugar sent in, in our opinion, not pure cane. If combs are intended for extracting, thin super foundation is not suitable. If for consumption in the comb, thin foundation is best.

Special Prepaid Advertisements.

Situations, Publications, Bee Plants, &c.—Twelve words and under, Sixpence; for every additional Three words, One Penny.

Trade Advertisements not inserted under this head.

WANTED—About 60 lbs. of good Run Honey. Address Mr. W. CHITTY, Middle Class School, Pewsey.

LANTERN SLIDES.—Mr. WATKINS will be able to supply a few Sets from his Negatives to Lecturers on Bee-keeping. All Photographs from Nature and Photomicrographs. Early application advisable. List free. Address ALFRED WATKINS, Hereford.

WANTED, a PUPIL or GENTLEMAN PARTNER for BEE-FARMING in Austria. Address FÜRNERKRAZ, Meran, South Tirol. 3327

WINTERING BEES. By THOMAS W. COWAN. The most complete work on the subject of Wintering published. Third Edition. Price 3d.

J. HUCKLE, Kings Langley, Herts.

THE DEPOSIT SYSTEM.

British Bee Journal and Bee-keepers' Record.

OFFICE: KINGS LANGLEY, HERTS; AND

17 KING WILLIAM STREET, STRAND, LONDON, W.C.

The following are the Rules under which we are prepared to receive Sums of Money on Deposit from persons buying and selling goods.

In order to save trouble it is requested that the Rules be carefully read over by persons using the Deposit System of trading.

DEPOSITING.

1. **Method.**—When strangers are dealing together, the purchase-money of the articles is deposited at our office. We acknowledge receipt of the deposit to both parties, and hold the money until we are satisfied that the purchase is concluded. If a sale be effected, we remit to the seller the amount deposited, less a charge of 6d. and the expenses of Post Office Orders and postage, &c. Cash will be forwarded by cheque, Post Office Order, or by Postal Order as preferred. If a sale or exchange be not completed, we return the amount deposited, after making the same deduction. By this means buyers and sellers are secured from fraud.

2. **Deposits.**—Postal Orders (drawn on General Post Office) and Cheques must be made payable to John Huckle, and crossed 'Bucks and Oxon Bank.' The numbers of the Postal Orders should be kept by the sender. We cannot be responsible for any losses that may occur in transit.

3. **Honey on Approval.**—All honey will be sold by sample, which must be sent direct to buyer.

4. **Bee-appliances.**—In ordering, the time allowed for completing the order to be stated to us when sending cash. If maker accepts, we hold cash till transaction is satisfactorily completed, when the amount will be remitted subject to conditions as in Clause 1.

5. **Bees and Queens.**—These will be dealt with entirely by the parties concerned, so far as price, &c., goes, and when the purchase is satisfactorily completed cash will be remitted as per Clause 1.

6. **Goods in Transit.**—These are at the seller's risk, i.e., any damage to or loss of an article on its journey is borne by the vendor; but a rejected article must be properly packed and returned by the same means as was used in sending it.

7. **Carriage.**—The carriage of all goods, except such as are sent by post, is payable by the buyer, unless otherwise agreed. If any article sent on approval be returned, each party to the transaction must pay carriage one way.

BALDWIN'S

is the Oldest Establishment in the United Kingdom wholly devoted to Bees and manufacture of

Bee-keepers' supplies. His prices will compare most favourably with those of any other Maker, while for quality of material, suitability and workmanship, he has no rival.

'Why can he give better value for money than others?' Because he spends less in large 'puffing' advertisements, buys in the best markets for prompt cash, has no rent to pay, and personally conducts his own business.

For prices and full particulars of Goods see Baldwin's Bee-keepers' Instructor (and Illustrated Catalogue combined), which 'contains more practical and reliable hints than all the large, expensive books,' post free for 2d. stamps. Address S. J. BALDWIN, the Apiary, Bromley, Kent.

N.B.—More than 500 Silver and Bronze Medals, First and other Prizes, and Testimonials innumerable.

CROCUS for EARLY POLLEN.

A FEW Thousand Fine Sound BULBS, to Clear, at 5s. per 1000. Address

P. HARBORDT,
50 GREAT CHARLOTTE ST., LIVERPOOL.

EXTRACTED HONEY WANTED.

— One or Two Cwt. of Good Quality. Sample and lowest Cash price to W. DRINKALL, Market Street, Lancaster. 3305

British Bee Journal and Bee-keepers' Record.

OFFICE :

17 KING WILLIAM STREET, STRAND, LONDON, W.C

PURE CANE SUGARS.

For the accommodation of Bee-keepers, guaranteed Pure Cane Sugar will be supplied in large or small quantities through this office at the under-mentioned rates:—

MOIST. (For Household Use.)

	Neat bags, 14-lbs.	28-lbs.	56-lbs.	Cwts.
3. MUSCOVADO	2/7	5/2	10/- 19/6

CRYSTALLISED.

4. DEMERARA	} Crystals	2/9	5/4	10/6	20/6
5. BARBADOS					
6. TRINIDAD					

REFINED CANE.

7. WHITE CRYSTALS (Small)	3/0	5/10	11/6	22/6
8, 9. (Medium and Large sizes, 1/- per Cwt. extra.)				
10. LUMP (Cut Loaf) ... Boxes,	3/3	6/3	12/3	22/6
11. LUMP DUST	3/	6/-	11/9	22/9
12. PRESERVING	3/-	6/-	11/9	22/9

FINE. (For Household Use.)

13. GRANULATED	3/3	6/3	12/3	23/9
14. CASTOR Coarse (15 Fine)	3/9	7/3	4/3	27/9
16. ICING..	4/3	8/3	15/9	31/-

All above guaranteed made from CANE SUGAR only, and free from BEET, CHEMICALS, etc., etc.

CARRIAGE PAID on Orders over 5/0 (or 28-lbs. Sugar) to London and Suburbs.

COUNTRY ORDERS, not less than 2-cwt. carriage paid at 1/0 per cwt. extra.

(Scotch and Irish orders, special arrangements.)

CHEQUES payable to J. HUCKLE, Kings Langley.

Cash to be sent with order, and purchasers will please observe that if samples are required or replies asked to inquiries, a stamped addressed envelope must be sent, as we cannot undertake cost of postage.

THE British Bee Journal,

BEE-KEEPERS' RECORD AND ADVISER.

No. 495. Vol. XIX. N. S. 103.]

DECEMBER 17, 1891.

[Published Weekly.]

Editorial, Notices, &c.

USEFUL HINTS.

WEATHER.—The fearful weather experienced during the past few days compels us to again give some attention to the subject, much as we may have wished to omit the familiar 'Weather' heading for a time. Storms and rains, which may be more correctly described as 'hurricanes and floods,' cannot have spent their force on exposed apiaries without inflicting more or less damage. Hives in some parts will no doubt have been overturned by the force of the gales, roofs and coverings carried off to a distance, and unfortunate bees will meanwhile have suffered more or less damage according to the amount of exposure endured.

REPAIRING DAMAGE FROM STORMS.—In cases where mishaps of a not too serious nature have happened, a little prompt attention will generally set all right again, whereas a few hours' neglect might very easily result in the death of stocks. After storms and suspected damage—especially such as may have occurred in the night-time—an early inspection should at once be made. Roofless stocks which have been exposed to heavy rain, and are apparently dead, may be restored by carefully lifting bees and combs into a dry hive and carrying them indoors into a warm room for a few hours. Heavy combs of honey which have been broken out of frames through accidents, are best kept aside until warm weather comes and the bees are sufficiently active to repair damage by re-fixing combs, when the latter are tied into frames in the usual way. For the rest it is only needful to bear in mind that a good warming up and a little warm food often

render bees found in a comatose state as lively, active, and well as ever in a surprisingly short time. The 'warming up' may be effected by covering the frames with dry quilts and setting over all a warm brick.

CANDY MAKING.—A correspondent draws attention to the recipe for making candy printed on page 534, and says:—

'Do you recommend cane sugar for making soft candy? By the description of the boiling of sugar in recipe for making candy in *Bee Journal*, November 26th (page 534) I should think beet sugar is used, as it boils exactly as described, and is done in the time stated, whereas cane sugar does not throw any froth up, and takes much more boiling to get it into condition described.'

It did not occur to us to mention it at the time, but the recipe referred to is a reprint of one written some years ago by the late Wm. Raitt, and it is more than probable that he used beet sugar. We therefore subjoin the following from the last edition of the *Bee-keeper's Guide-book*:

'*Soft Candy.*—To six pounds of white lump cane sugar add one pint of water and a teaspoonful of cream of tartar. Put this into a brass or enamelled iron pan, and stir to dissolve the sugar, which must be all melted before it begins to boil. When it boils, cease stirring, and continue to boil until it is of the proper consistence. To test when it is done, dip your finger into cold water, then into the boiling sugar, and back again into the water; if properly done, you will be able to knead it into a soft ball. Or, if you are afraid of burning your finger, drop a little on a plate, and if it sets tolerably hard on cooling, and is just soft and sticky, it is done enough. If, however, it is very sticky and soft, it must be boiled a little longer. When it is ready, take it off the fire, set it to cool, and, when lukewarm, stir it with a stick and work it against the sides of the pan until it turns white and begins to set. Place paper into saucers, and pour the candy out into these. In half an hour it will be hard and ready for use. If it is not boiled enough, it will be soft and sticky in warm weather, if too much, it will be too hard. If burned, no amount of boiling will make it set hard. Burnt sugar is injurious to bees if fed in cold weather.'

'Flour Candy.—Proceed in the same way as for making soft candy, and, as soon as it is taken off the fire, stir into it one and a half pounds of wheat flour, or one pound of pea flour, and when it is setting pour out into saucers.'

In the above, cane sugar is used, and if the directions given are carefully followed, an excellent soft candy will result.

SPACE BELOW FRAMES.—We are pleased to see our pet notion of space below combs in winter is also a strong point with one of the most practical American editors. Mr. W. Z. Hutchinson, editor of the *Bee-keepers' Review*, says—

'There is one point that ought not to be neglected in preparing the bees for winter, whether indoors or out, and that is the leaving a space below the combs. When wintered out of doors, there ought to be a rim two inches high placed under each hive. This allows the dead bees to drop away from the combs to a place where they will dry up, instead of moulding between the combs. Then, if there is an entrance above the rim, there will be no possibility of the entrance becoming clogged. This space under the combs seems to be a wonderful aid in bringing the bees through in fine condition.'

But, besides avoiding the risk of entrances becoming clogged, it is quite certain that the free circulation of air below the cluster of bees contributes to their well-doing in winter-time. In confirmation of this theory, what bee-keeper of experience has failed to notice how well second swarms, which have only half filled their hives with combs, will winter, and how healthy and vigorous they will be in spring? We thoroughly advise the adoption of ekes below combs in winter where the construction of hives will admit of it.

TUNISIAN BEES.

At the November meeting of the Entomological Society, Mr. W. F. Kirby exhibited a series of a dark-coloured form of *Apis* reared by Mr. J. Hewitt from bees stated to be imported from Tunis. We have had an opportunity of seeing these bees, and so far as we can judge from dried specimens they are no others than the ordinary Tunisian bees, which we have already described as being similar to those from Algeria and Morocco, and not a new species at all. Mr. Kirby stated that Mr. Hewitt proposed to call them 'Punic' bees, and that he stated they were different from the ordinary Tunisian bees. We fail to see any difference, and there will be some

difficulty in persuading entomologists to adopt a new name for well-known bees. We were also told that these bees would not sting, which made us smile, more especially as we remembered what Mr. Benton had said about them. Here are his own words when he wrote from Tunis on March 20th, 1885: 'They are also active, energetic workers. But, unlike Cyprians and Syrians, they are liable at times to fly at one and sting him when he approaches the apiary, and yet does not molest the hives.'

There is a great deal we could say about Tunisian bees; about the 'Kassartyr' apiary, of forty hives; about a French gentleman (whose name, for obvious reasons, we at present withhold), whose apiary is not quite on the borders of the Sahara desert, who exports Tunisian bees to England, and upon whom (if not in Paris), amongst other bee-keepers we intend to call when we go to Tunis for the purpose of ascertaining why Tunisian bees, which are of the same race as those of Algeria and Morocco—and, we may add, of the Balearic Islands too—sometimes show yellow, which the bees of the last three places do not. Of course, we have our own theory on this matter, but we wish to verify it on the spot by personal observation. We hope, also, before long, to be able to show specimens of these bees from all the above places at a meeting of the Entomological Society, and also of the Linnean Society. We were much amused when Mr. Kirby told us that the importer wished these bees classified as *Apis niger*. As they are already classified as *Apis mellifica*, it is not likely that the name will be changed for Tunisian bees, which are only a variety of this species.

HUBER'S LETTERS.

SECOND LETTER.

I am very sorry, my dear Sir, to have been so long in answering the kind letter that you did me the honour of addressing to me. I received it on the eve of my departure for Switzerland.* M. de Flumet, whom I saw at this time, and who was also starting for Chambéry, promised me to see you on his way, and to thank you on my behalf and that of my son, until I was able to do so personally.

The young naturalist, in whom you are good enough to take such an interest, feels your kind-

* At the time M. Huber wrote Geneva had for several years been considered as belonging to France.

ness very much, and begs you to continue it to him. Some day he will go to find instruction and pleasure in the old castle, where the art he loves is cultivated with much success, and where your advice and your example can be of so much service to him.

I hoped, on my return, to have seen our dear Count, and to have had news of you from him, but he left for Switzerland just as I arrived, and I only had his complimentary messages. Therefore, allow me, Sir, to renew our correspondence, which I know how to appreciate, and which had been unavoidably interrupted.

I have made an observation this year, which, though it is new to me, would, perhaps, not be so to you. I will give a detailed account of it to our Philosophical and Natural History Society when I read the history of my discoveries on the nature, origin, and uses of propolis (*la propolis*). I still give this word the feminine gender, although I know that our professors in Paris instruct differently; but I am a rebellious child, and, moreover, it is quite sufficient for me to speak as well, or no better, than Maraldi, Réaumur, and Bonnet.

When I was at Lausanne I frequently made excursions to the neighbouring country houses. One of my friends had some straw hives. He told me one day that every evening small bats were to be seen hovering around his apiary, that they even entered his hives, and that his gardener had seen them coming out of them. M. d'A. also told me that he was going to brimstone some of his hives. You understand that I did not believe about the bats, nor respecting their attacks on the hives, and that I did all I could to prevent my friend from destroying the bees by fire, but it was useless.

On September 16th, in the dusk of the evening, several of the so-called bats were seen flying about the hives. Three swarms were killed by exposing them to the fumes of burning brimstone. But this time punishment closely followed the crime, for no honey, or scarcely any, was found in any of the combs of the three hives. I saw the wax that they had taken out: it was soft, sticky, and sweet. It therefore appeared that they had contained honey. The bees had in reality collected much during the previous month. It was then certain that the honey had disappeared during the last few days.

The combs of the three brimstoned hives were not at all damaged or separated the one from the other, as must have been the case if the bats had forcibly entered the hives, and I was quite convinced that it was not they who had caused this devastation.

In order to know to what to attribute the real cause, on the 17th I sent my servant to this apiary between six and seven in the evening. I told him to keep a good watch, and to bring me, alive or dead, some of the creatures that he should see flying round the hives, and trying to get in. I did not wait long; at the end of half an hour he brought me two moths known by the name of 'Death's-head moth.' My friend's gardener caught them, damaging them with a

blow from a pruning-knife, just as they were trying to enter the hives. The farmer of another property came to tell my servant, while he was keeping watch, that, at the same time, a number of those moths were hovering about his apiary, and I found that this was the case with all who kept bees for many leagues round. Here, then, is another enemy of our bees, and it is a very formidable one, because it can consume in a very short time all the honey that the bees have stored for their winter use, for I learnt that all who had seen these moths about their apiaries, and who did not oppose their invasions in time, had hardly any honey in their hives. I advised them to feed them during the winter, either with honey or with sugar syrup—a spoonful of syrup or honey is sufficient for an ordinary hive for twenty-four hours.

If nature has given the bees such a formidable enemy, it has also taught them how to defend themselves against its attacks. M. d'A. thought that success could be achieved by making the openings, which serve as entrances for the bees, narrower. He put tin rakes arranged so as to form arches before three hives, and, as he had no more at hand, he did not put any before the entrances of the other hives.

On the 18th I went to examine them. I found everybody out, admiring the intelligence which the bees had shown. The bees of those hives which we had not barred had themselves walled up and narrowed their entrances. The day before this wall was not there. The danger had therefore awakened their instinct in this respect. It is a pity that it did not do so sooner. However, if the bees made their doors so narrow that the death's-head moth could never get into their hives, this moth would die of hunger, and the object of nature would never be fulfilled, for it is evident that it is destined to find its nourishment in beehives. It is quite necessary for all the world to live, and in order that the equilibrium may be maintained, it is necessary that the hawks do not consume all the pigeons; and if they are their natural prey, sufficient know how to escape their enemy, so that the species is preserved. The barricade of the bees is then only a stratagem of war, which cannot always succeed, but it is sufficient that it does sometimes. But how does this moth escape the bee's stings? * I have only an idea about this, and you will certainly guess it; we shall (D.V.) put it to the proof next year.

Perhaps in their native land, where they still live in forests where man has not interfered with them, the bees would do beforehand what they now do too late. Perhaps, also, it would have been too much for a fly's brain to exact any measure of precaution. Perhaps it was necessary, in order that the idea of narrowing their entrances should be aroused or excited in their brain, that the actual presence of the enemy itself should determine them to do so.

I had already seen natural doors which had

* See also what is said about the death's-head moth in the interesting article by Mr. C. P. Cory on p. 268 *British Bee Journal* for this year.—Eds.

also been made in the hour of danger. But, however much I admired their industry and infinite wisdom, I did not dare to come to any conclusion from two isolated observations; it was necessary to repeat them, as I did this year, to take them collectively, and then to admire one more feature in the industry of these astonishing insects. Because, in all the apiaries which I inspected, or had inspected latterly, there were always some hives in which the doors had been recently walled up as a protection against the death's-head moth.

When you write to me, Sir, do me the favour of telling me if you have observed anything similar this year. I would also ask you, to keep our communications about bees private, until we can both find it convenient to make them known to the public.—I remain, Sir, your obedient servant, HUBER.—*Au Bouchet, near Geneva, October 14th, 1891.*

(To be continued.)

OUR LIBRARY TABLE.

Since we last made our review of books, quite a large number of bee-books and pamphlets have accumulated on our table. Some pamphlets are merely trade advertisements and call for no special notice, and some of the books are hardly worth the paper they are printed upon, and yet we every year have this crop of bee-literature, a little wheat and very many weeds. The weeds we will leave out, and notice the rest.

Governo dell'Apiario, o Calendario dell'Apicoltore Mobilista. Di Ed. Bertrand, Teramo. Published by V. de Michetti. (3 lire 50 cents.)—This is an Italian translation of that well-known book by M. Bertrand, the *Conduite du Rucher*, and, in addition to the illustrations contained in that book, there are some new ones, especially in relation to Italian bee-keeping. The book is got up with the same care that all M. Bertrand's books are; but the printers have not done their best with the process blocks. This book must prove useful to bee-keepers in Italy, many of whom still use the German hives with small frames.

La Ruche Dadant Modifiée. By Ed. Bertrand. Nyon: at the Bureau of the *Revue Internationale*. (60 centimes.)—This is a large octavo pamphlet of thirty-two pages, giving a description of the Dadant hive as modified by M. Bertrand. Full instruction will be found for constructing this hive, and the admirable illustrations, many of which are prepared expressly for this book, cannot fail to assist the bee-keeper who tries to make such hives. The smallest detail is not omitted, even to the tools used in making the hive. This is a fellow-pamphlet to the one on the Layen's hive which appeared as a supplement to the *Revue Internationale* at the end of last season. It is a pity that the Paris Congress did not adopt the frame here recommended instead of fixing on a new one, to which they have given the name of Dadant. It is rather confusing to have three Dadant frames.

Das Recht an Bienen zugleich ein Beitrag zur allgemeinen Lehre von Recht an Tieren. By Dr. jur. Karl Bälz. Published by W. Kohlhammer, Stuttgart. (2 marks.)—This is a very useful book, which contains all the laws about bees in Germany, and in Chapter XIII. we find the laws enacted in other countries; but England does not seem to be included. There are five chapters devoted to the Roman law on the subject, from which all the other laws seem to be more or less derived.

Die Wachsmotten. By A. von Rauschenfels. Published by Apistische Verlagsanstalt, Wytkon-Zurich. (40 cents.)—This contains a description of the life-history of the wax-moth, the damage it causes in hives, and the methods to be employed to guard against its ravages. M. de Rauschenfels is the editor of the *Apicoltore*, and has written this pamphlet in a very pleasant style. It is also illustrated. On page 32 is described a parasite of the larva of the wax-moth, which Professor Camillo Rondani has called *Eupelasmus Dalm cereaeus n.*

Die Honigbiene: ihre Naturgeschichte, Anatomie, und Physiologie. Von Thomas William Cowan; übersetzt von C. J. H. Gravenhorst. Published by Schwetschke & Sons, Brunswick. (2 marks 50 pf.)—This is a translation into German by M. Gravenhorst of *The Honey Bee*, and is the first work of its kind published in the German language. The translation is as well done as it could be by such a master of the science as M. Gravenhorst, and we are pleased that it was undertaken by so able a veteran. The publishers have also spared no pains or expense to turn it out well.

Praktischeskote Ptschelovodstvo. By T. W. Cowan. Translated into Russian, with notes, by P. N. Kouleshoff. Published in Moscow by Koushkeroff & Co. (40 kopeks.)—This is a new edition (the third) of the *British Bee-keeper's Guide-book*, which contains many notes by the translator suiting it to apiculture in Russia. There are also illustrations added of winter repositories for bees and wintering in clumps.

Bienenzucht und Bienenkenntnis der Griechen und Römer im Altertum nach Columella, bearbeitet von Becker. Published at Nördlingen by C. H. Beck. (80 pfennige.)—Columella's *De re Rustica* is a classical work, but is not to be found at the booksellers, and, in order to bring the knowledge of bee-keeping of the period before the notice of bee-keepers, M. Becker has translated portions of this work with editorial explanations. A.D. 50 was the time that Columella wrote his work, and gave the knowledge of bee-keeping at that time of the Greeks and Romans. This little book is of the greatest interest to all who wish to know the state of bee-keeping of that day, and, in perusing it, one is astonished to find how much was known by the ancients about bees.

Annual Reports of the Bee-keepers' and the Poultry Associations for the Province of Ontario for 1890. Printed by order of the Legislative Assembly. Published by Warwick & Sons, Toronto.—This is a full report of the proceed-

ings of the Ontario Bee-keepers' Association, and contains, amongst other papers, full particulars of what is being done to exterminate foul brood. There are also interesting papers on Honey-producing Plants, Honey-dew, The Best Honey and Where Obtainable, Ripening Honey, Canadian Bee-journalism, Management of Out-apirians, &c.

Ein Kleiner Beitrag zur Förderung der Bienenzucht. Von C. Weygandt. Published by Schwetschke & Sons, Brunswick. (2 marks.)—This is the third of a series by this well-known advocate of warming hives in winter. In this book the various criticisms on the system are answered, and the question thoroughly argued out. It is well illustrated, and there are some capital sections, showing the way in which the fresh air, either warm or cold, can be supplied according to the requirements of the colonies. We must say that Pastor Weygandt argues the matter out in a very clear and forcible manner, and it remains to be seen how the system will work out in actual practice.

Correspondence.

The Editors do not hold themselves responsible for the opinions expressed by correspondents. No notice will be taken of anonymous communications, and correspondents are requested to write on one side of the paper only, and give their real names and addresses, not necessarily for publication, but as a guarantee of good faith. Illustrations should be drawn on separate pieces of paper. We do not undertake to return rejected communications.

Communications relating to the literary department reports of Associations, Shows, Meetings, Echoes, Queries, Books for Review, &c., must be addressed only to "The Editors of the "British Bee Journal," 17 King William Street, Strand, London, W.C." All business communications relating to Advertisements, &c., must be addressed to Mr. J. HUCKLE, Kings Langley, Herts (see 1st page of Advertisements).

** In order to facilitate reference, Correspondents, when speaking of any letter or query previously inserted, will oblige by mentioning the number of the letter, as well as the page on which it appears.*

SIZE OF QUEEN-EXCLUDERS FOR SURPLUS CHAMBERS.

[880.] The last lines of the *B. B. J.* of December 23rd, page 555, read, ' . . . may be worked on frame hives, if a thin board or adaptor large enough to cover the frames is laid on the top bars; a couple of slots must be cut to admit the bees to the ' I leave out the 'bell-glasses.'

Here our editors supply an answer to the question, 'How large is it necessary to have queen-excluders?' I am not quite satisfied with the lines quoted, and want to know what 'a couple of slots' means? I want to show that a waste of whole squares over the frames is not required, and a very little is sufficient for all purposes, viz., as above stated, 'a couple of slots' and the main part of 'the frames covered by a thin board.'

Queen-excluder over the whole of the frames must cause draught from the entrance, through the brood nest, where the heat, most wanted and required, then escapes upwards. It is un-

reasonable to suppose that bees, returning home, ascend through the brood nest, in its already crowded state (always the middle frames), to get into the supers above it.

What sized sheet of queen-excluder zinc is required for the bees to pass through? I have long ago felt quite sure the above-stated answer was right and quite sufficient. All my forty hives were so managed and arranged on this principle last summer. I shall continue to do so again. Straw skeps, with a section box on the top, have the bung or cork removed, which space is more than half filled up with comb in it. Messrs. Neighbour's former double straw skeps, I find, had three holes in the crown board of the lower skep the size of a common cork, say three-quarters of an inch each. These are all-sufficient.

I will argue another way. How many bees can and do pass up and down through them at the same time? No, I won't count; I prefer measurement. Leaving the brood nest and all it contains to itself and out of the question, how do these communications with the upper stories correspond with the entrances of the hives from the outside? These are much less, but large enough to admit all going in and out continually.

So far the skeps; I now pass on to the frame hive. Then entrances to all my hives are four inches by half an inch all through the hottest months; large enough for the body-box, a second one like it above, and a shallow frame box or a section crate for the latter instead. I know some keep their entrances full width, say fourteen inches by half an inch. Anyhow, the larger one cannot pass more home-coming and outgoing bees than the opening permits. Let me 'double' this for the sake of argument, keeping this double in mind for abundance of queen-excluder zinc on the top of the frames. I say, to place the excluder all over the frames is too much: it would be enough to make it correspond with the entrances, and I put it front and back upon the frames, because bees homeward bound for the store-rooms of the upper regions of the hive travel up and down the front and back walls of the hive, to avoid and not to disturb the nursery, the nurses, and her majesty's private apartments.

Some portion of the 'slots' (the 'couple of slots' referred to in the beginning?) are lost to the bees by being on the top of the wood of the frame's top bars, and these I set off for the double allowed for the larger entrances; and if the excluder slots corresponded with the same space at the entrances, that should be both sufficient and abundant.

All my body-boxes have the 'thin board' referred to in the beginning 'large enough to cover the frames' all the year round, both summer and winter, with this exception, the space for the queen-excluders, of which two are used, running across all the frames, back and front. Each is two inches wide, formed of ordinary excluder zinc. They are put on in June, removed in autumn, and a thin strip of wood takes their place for the nine following months—the whole

thin board—and for the queen-excluder strip the thin wood remains a well-fastened-down roof over the frames, with the winter packing over all. When additional boxes are added, the queen-excluder is placed in position almost without the bees noticing the very slight disturbance. Very seldom do I pull my body hives to pieces, but leave them alone as much as possible. When a casual insight is needful, two strips of wood are temporarily screwed down across the whole of the winter packing to hold the frames, the thin boards covering them and all in position, and, like a straw skep, the whole hive is turned bottom up. Some could scarcely do this with their double-walled hives, almost double size. It is easy work with mine, all of half-inch single walls. They stand three stories high, upon shelves, in a bee-house. The weight in spring is not very considerable. Without tearing down all the beautiful sealed work, so skilfully glued to exclude all light and air, I turn them bodily up, and form my idea from looking among the frames from below, or rather from the bottom. The bees are scarcely disturbed by this. Is anything wrong, doubtful, or more insight a necessity, then, and then only, if needful to overhaul from the top, frame after frame is pulled to pieces, but only in the extremest cases. It prevents feeding from the top certainly, and I feed from below in the two-and-a-half-inches deep ekes. This is accelerated by the warmth of the four rows of hot-water pipes in the bee-house to warm its temperature, to keep out frost, and assist in spring when breeding is in full swing. I have lately put the third bee-house up. They are all alike, six hives on each shelf, three stories high, with pipes for hot water below, on greenhouse and gardener's principles; but the workmen did not relish sixty hives of bees on mild days. The hives were all removed on November 21st into my dark cellar under the house, where, during last winter's severest frost, the temperature never varied between 40° and 45°, and it was pitch dark. There, undisturbed by sound or light, they shall remain, with good ventilation and no dampness, until the end of February at least, perhaps March, if a severe winter; but, when returned to their former places on the bee-house shelves, and after a first good cleansing flight, the warming-up process will begin again until May's warm nights and days make it unnecessary.—J. G. K., *Grove House, Southborough, Tunbridge Wells.*

NOTES BY THE WAY.

[881.] The weather in this district has nothing of the usual kind that old associations mingle with the thoughts of Christmas, which will soon be with us; it partakes more of the equinoctial season. To-day the wind is blowing great guns, and the rain pours down in such torrents that the distant fields look like a veritable sea—though we have the consolation that, as soon as the storm is over, we shall see

the fields as before—free from stagnant water. There has been for some time past a short supply of water in the wells, but now I hear the springs are rising in the wells at the rate of six inches per day, so that we expect to have our fords and burns running again that have been dry for some ten years. The autumn, though rough and wet, has continued very mild, and the busy bees have even quite lately found pollen from some source, probably from flowers and shrubs that do not in ordinary seasons blossom till the new year.

The continued rains play sad havoc with hives that are not rainproof, making the interior anything but a fit habitation for bees; and where such is the case—and I fear it is often so—the wraps and cushions should be changed for dry ones, and attention given to the roofs to prevent a recurrence of the same state, or a loss of stock will inevitably follow if we get a spell of severe frosty weather with the cushions and wraps reeking with moisture.

The stock of honey on hand requires attention, and if any of the sections of comb honey show signs of 'weeping,' *i.e.*, have drops of thin watery honey exuding through the capping of the cells, or streams of thin honey running down the face of the sections from the top row of cells, which are not often sealed over, this shows at once that the place in which it is stored is too damp, and that means must be taken to remedy the matter by fires—stove or lamp, or, failing these, the honey should be removed to a dry, warm place. With extracted honey so much care is not required. If it is in tin cylinders or cans, so that the lids or covers fit securely, and it is stored in a room dry enough to prevent the vessels from rusting, that is all that is needed; but where honey is stored in earthenware pots or in glass bottles, more care will be required to keep it from frost, or the crocks or bottles may burst—not explode, but crack.

Super-clearers.—Another point in favour of these has cropped up in my own experience, and I doubt not in the near future we shall look on them as an indispensable appliance in the apiary. The point I would mention came by practice during the late summer. After I extracted the honey from my unfinished sections, I simply removed the piece of zinc that covers the centre hole of the clearer—I am speaking now of the 'Food clearer'—and placed the board over the quilt, and opened the feed-hole in quilt, and then placed my crates of extracted sections on the boards. This method gives the bees free access to all parts of the supers to be cleared out, and as the supers are cut off from the colony below, except by the one central hole of clearer, the bees make quick work of the clearing up, and leave the combs afterwards, even in moderately warm weather, quite free from bees. This I consider a decided gain to the busy man, and as the crates of combs are only on the hive a few hours, there is no chance for wax-moths to deposit eggs in the combs.

Self-hivers are still being discussed in the American bee-papers. Mr. Dibbern seems to

have used the self-hivers on some 200 hives during the past season, and he remarks that though they are not all he could wish, yet he considers them useful as a labour-saving appliance, and also a protection from absconding swarms. Mr. Dibbern has improved on the Alley hiver, which was placed on the hive front with communication with another hive, to receive the swarm on the side of the parent hive. Mr. Dibbern's hiver is constructed to allow the queen and drones to run up into the empty hive placed on the top of the parent hive. This he considers an advance, as all bee-keepers know how natural it is for bees to run up when trying to escape from anything that confines them. The swarms hived by these automatic devices are generally small, as the bulk of the bees return to the parent hive. This is an advantage unless where increase of stock is wanted, as the work in the supers is carried on without a break.—W. WOODLEY, *World's End, Newbury.*

BEEES IN SOUTH AFRICA.

[882.] I see by the *B.B.J.* that the foul-brood question is still troubling the bee-keepers in England. We are having a gay time here with our bees at the present time, it being easily seen by the many honey-hawkers about how plentiful have been the rains, and plenty of fine rains means plenty of flowers. Swarms are coming in now very sharp, and not before they were wanted, for owing to the last drought we had, and also through the *baboons* in the country destroying and robbing every hive they came across, bees were becoming very scarce. However, things have changed now, and all is coming right again so far as bees go. I find the tin sections answer very well for Africa, as they are not brittle like the wooden ones; but they are very expensive. They are fitted with wooden tops for the bees to attach the comb in building. Farmers are now going in more for bee-keeping. In Capetown there is a firm (Messrs. Attridge Brothers) who are quite experts with bees. They are doing their best to introduce bee-keeping in their district. We hope soon to hear more of their success and progress; but they are 500 miles from us. In the Transvaal bee-keeping is making slow but sure progress; in the Free States there are several bee-keepers doing fairly well; in the Humansdorp district, owing to a severe drought some time ago, bee-keepers are only now beginning to look up again, as the bees are coming on now very well. If any of your bee-keepers would like a swarm of South African bees, I will send a few on with pleasure.

I have made a new style of hive as follows: Just below the alighting-board underneath I have a box with strip of ventilator for light and air. Inside of the hive there is a hole, which leads into this box, with a slide to close or open. When taking the honey I close the entrance of the hive and drive the bees in the box below,

which they all fly to when they see the light. When the lower box is filled with bees I close the slide, and shut them in so they do not fly about, troubling and stinging me, and no bees are destroyed. I have found it to answer very well.

Have you any large pictures or prints of bees, showing the bees with their habits, hives, &c. ? If you have any, I would like some. You could send them to Dreyfus & Co. (the address in London) for enclosure to me. I hope British bee-keepers will be more lucky with their bees next honey season. Wishing you success.—JOHAN STERLEY, *Port Elizabeth, South Africa, November 11th, 1891.*

[We know of nothing beyond the diagrams published by the B.B.K.A. which could assist our correspondent. Particulars of these have appeared in our advertisement columns.—EDS.]

NOMINAL ONE-POUND BOTTLES.

[883.] I should like to say a word on this question. 'Bee Just' says 'the principle is dishonest all through,' and I should be inclined to have the same opinion if it were not for the fact that the bottles in question are *not* sold for one-pound. I have always understood those bottles were made with the idea that the weight of honey deducted should pay the additional price of screw-cap bottles, and that in this way the buyer still gets value for his money. As the specific gravity of honey varies, it would be necessary, to be quite correct, to weigh honey into every bottle, as I had an instance last week in bottling twenty pounds of honey in one-pound tie-over bottles. I filled the bottles, and found I had only sufficient to fill eighteen and a half bottles. This verifies the Editors' footnote to No. 859.—A. G. P.

FRAME HIVES VERSUS SKEPS.

[884.] The letter of Mr. W. Woodley (873, p. 560) in last week's *Journal* emboldens me to send you a few mems. and queries which for some time have been rankling in my brain.

1. For permanent work I use only bar-frame hives, but cannot say much about 'perfect control' over the doings of the bees, as, though I have metal ends on frames, and use a spirit-level when fixing stands, I always find the combs joined together, so that I cannot take a frame out without causing serious damage.

2. A little while ago I was talking with an old hand at bee-keeping in this neighbourhood, and comparing notes. I said that from my two hives I had got twenty pounds of honey. Says he, 'I have *bet* you; I got eighty pounds!' Seeing me rather chagrined, he added, 'but I burn my bees.' Now doubtless the bee-world 'moves still,' but if it is to continue its motion in these parts, I must beat this man next year; how, then, shall I do it? Three bar-hive stocks

in fair condition, no extractor, and no bee-master handy to give advice! Please, therefore, let me know when to commence stimulating food, when to super, and if super should be put on any swarms that may issue.

3. My oldest stock—strong and healthy, so far as I can judge—has never swarmed for two seasons, unless it has done so in the middle of the night, for I have watched it narrowly: can you account for this?

4. This has been an exceptionally good year in this district for white clover, yet I could count on my fingers the number of bees I found working amongst it (and I examined several acres) during the month of July. I did not choose rainy days for my walks abroad, but days when my bees were busy. Can it be that they were so fastidious as to go at least three miles to an upland pasture rather than cull the nectar close at their door because it was lowland?—Moss, near Doncaster.

[The four queries enumerated above cover so much ground, it fully replied to, that we must advise our correspondent to read a fairly good book on bee-keeping, and acquire so much of the knowledge of frame-hive management as is absolutely necessary for obtaining a fair amount of success. The facts detailed in the report of the Berks B. K. A., quoted by Mr. Woodley, abundantly prove that frame hives, properly managed, yield far better results than skeps; but—and this is the *crux* of the question—to acquire the art of managing bees in frame hives requires some amount of book study, beyond the few words of advice on particular points which our limited space enables us to give to readers; and any one who hopes to achieve success in bee-keeping on modern principles *must*, as we have already said, read up some work specially written upon the subject.—Eds.]

Queries and Replies.

[463.] *Leaving on Surplus Chambers—Width of Entrance during Winter.*—1. I have three hives some miles from home, and not having a convenient place to store supers, &c., have left them on the hives, *i.e.*, two with worked-out shallow frames and one with sections. The two with frames in super have excluders on, the sections have not. There is a fair amount of stores and bees in the hives, but no honey in supers, and they are well supplied with quilts (over supers). Would the bees winter well under these conditions?—and, 2. How wide would you advise entrances to be?—A. G. P., *Notts.*

REPLY.—1. So long as there is no honey in the surplus chambers no harm will arise beyond the inevitable loss of heat to the cluster of bees below. We have, however, not seldom wintered bees under exactly similar conditions to those named, and had excellent results. 2. Much depends on circumstances, *i.e.*, the form of hive used; method of wintering; exposed or sheltered situation, &c. Our own hives have outer cases, and they are located in a rather exposed position as regards cold winds, consequently entrances to the outside are only

left open about three-quarters of an inch wide during the winter months. But it must not be forgotten that the combs of each stock are raised three inches above the floor-board; also that the entrance to the hive itself—from the space between it and the outer case—is fourteen inches wide. Hives without outer cases, and where no space below combs is allowed in winter, should have entrances left at least six inches wide, except in the face of cold, biting winds.

[464.] *Transferring Bees to Frame Hives.*—I have a stock of bees in straw skep, and wish to transfer them to a bar-frame hive. Can I do this early next spring, and, if so, what would be the earliest month?—HAROLD G. COYNE, *Ilford.*

REPLY.—Bees and combs may be transferred to frame hives in spring so soon as the weather is warm enough for honey-gathering to have begun. We think, however, that a far more satisfactory result would be attained by nursing the bees in skep carefully in spring to obtain an early swarm, either naturally or by making an artificial one, and, by furnishing the frame hive with foundation, secure new, straight, workable combs and a prosperous stock.

[465.] *Candy-making—Cleaning up Shallow Frames.*—1. Is the enclosed sugar from Queensland suitable for bee-food? I forward a sample of soft candy made from it. It took twenty-two minutes to boil, and five more to reach the thready stage. It seemed to set all right at the time (two days ago), but has since become soft inside, like the sample sent. It has been kept on a shelf, at a temperature of about 78° Fahr. 2. Is it the fault of the sugar, or the making, that causes it to become soft? I followed the directions given in the *B. B. J.* some time ago. 3. I have a number of frames (extracted) which the bees refused to clean. Will it be better to keep them in a warm or cool place, to prevent fermentation? 4. Is the *Bee-keeper's Record and Adviser* the same paper, or included in the *B. B. J.*?—H. C. HAWKER, *Longparish, Micheldever.*

REPLY.—1. Bee-candy should be made from refined cane sugar. Sample sent, though cane, is unrefined. 2. The candy sent has every appearance of being insufficiently boiled; indeed, it is hardly adhesive enough to hold together. We should boil it again for a few minutes. 3. If the frames are kept in a dry, warm place, no fermentation will take place. They have been given to the bees too late in the season; hence their refusal to clean them up. 4. No; the papers are distinct and separate, the former being published monthly, the latter weekly.

[466.] *Preserving Old Combs for Melting.*—What can I do to save old combs from being attacked by wax-moth until I have enough of them for melting down?—EXMOR.

REPLY.—Crush them into a close, compact mass, as hard as you can make them.

WAX SECRETION.

(Continued from page 567.)

On the 10th day of June I hived a good fair-sized swarm of bees to experiment on, and prove, as far as possible, how old bees will live, and also whether they ever get so old that they don't secrete wax. I gave them nine full Langstroth frames of combs. I took them out of my comb-room, where they had been kept since last fall, so there was no brood in them. I also gave them nine L. frames with one-inch foundation starters above the combs, and eight L. frames with one-inch foundation starters below the combs. The bees were working very strong at that time on honey-dew. June 19th, the upper set of frames were full of combs, and they were building nicely in the lower set. At this time I extracted all of their honey, but did not weigh it. July 1st, I extracted forty pounds of honey. The whole three sets of combs were full of honey and brood. It was then twenty-one days since the swarm was hived. Then I took away *all of their brood*, and there was not a bee hatched at this time. In place of the brood combs taken out, I put in empty frames with inch starters of foundation. July 11th, I took out one comb of honey, five pounds, and sold it to a neighbour who wanted some comb honey very much, and gave the bees one more frame with foundation starter. July 20th, I took all their combs away, and gave them six full combs of honey. Mind, the combs contained no brood—positively nothing but honey. Why did I take all of their combs away on the 20th? For the reason that every comb in the three sets contained brood, more or less, so I had to take them all to get all of the brood. At this time our basswood honey-flow was over. I now, July 20th, reduced their space to two stories—upper story six combs of honey with two empty frames with foundation starters, and eight frames below with foundation starters; and now that the honey harvest was over I gave them two three-pound feeders full of honey, so they can have plenty of honey for wax secretion.

July 25th, according to Mr. Doolittle, all the bees should be dead; but, instead, they are alive, a fair working colony, and are building combs rapidly—have eggs in one of the new combs, and eggs in one of the honey-combs, whence they have removed the honey. August 3rd, I reduced their space to eight L. frames, and took away all of their brood again. This makes three times that they have been robbed of their young ones. It looks too mean, when a queen has worked so hard to build up a family, to rob her in that way. Of course, the brood is given to other colonies, so there is no loss.

Now, August 3rd, the hive contains four combs of honey, four empty frames with inch foundation starters. The empty frames are put between the honey-combs.

August 15th, I looked at the bees, and fed them. Since the 3rd they have built comb in all of the four empty frames. One of them is a

fourth full of comb; the other three are half full, and have brood in two of them. Some of the brood is capped over. The bees are at work every day when others work. They gather pollen, and appear to carry loads of honey; but it may be water. It is now twenty-one days since they should all be dead, according to Mr. D.'s standard; but, instead, there is a fair colony for a one-story hive, and they are building combs yet. I am afraid that I shall be compelled to take their brood again.

August 24th, I examined the bees, and found enough alive to warrant further experimenting. I took away four combs that contained brood. Three of the brood combs were built since August 3rd. One of these was built half-way down; the other two new combs were each two-thirds of a full comb. I now reduced this space to five L. frames. One of the frames was empty, with a one-inch starter. I put the empty frame in the middle, between the other four combs. August 28th I put in another empty frame with a one-inch starter of foundation. September 10th, I looked at the bees again. They are a fair working colony yet. The frame put in August 24th is two-thirds full of comb, and the empty frame put in August 28th is half built, and both new combs are nearly filled with brood as far as they are built. They have now been working steadily for three months, secreting wax and building combs ninety days—just double Mr. Doolittle's time—and I am not sure but they would pass the winter if allowed to hatch the crop of brood that is now coming on. They don't dwindle away very fast. What kind of bees are they? Very near pure Carniolans, from a queen that I bought of John Andrews, Pattens Mills, N.Y. I don't know whether the kind of bees has made any difference; but it is the kind of stock that I have in my home yard. But one thing I do know—my home yard has stored double the amount of surplus honey of any other yard we have.

Now, what have I proved by this experiment? Just nothing, positively. Here it is ninety days since this swarm was hived. There are quite a lot of bees there yet, building combs and raising brood. But are the bees that are there now a part of those that were hived there the 10th of June? If they are, they are ninety days old at least. I do know that there has not been a bee hatched in the swarm since they were hived; but I do not know but that young bees from other hives near them may have joined them in sufficient numbers to keep up the stock to its present working condition.

Now, if I have not proved anything, I have learned how to prove the point that I was driving at; and if I live until another year I will try it again. I propose to hive a swarm as early as I can get a good one, and then place it twenty rods at least from any other bees, so as to be sure that no other bees would join them; then take their brood away often enough, so they cannot get recruits, and then see how long they will live. I hope others will try some experiments of this kind.

If any one has any suggestions to make I should be glad to get them. Prove all things yourself.—E. FRANCE in 'Gleanings.'

BACILLUS DEPILIS—WHAT CAUSES IT?

From my observations in three States—Indiana, Texas, and California—I am convinced that writers have confounded two distinct and radically different diseases under the name of 'nameless disease.' *Bacillus depilis* is a very appropriate name for the one wherein the bees afflicted become hairless, shiny black, and tremulous before death, which, so far as I know, was first described by A. I. Root under the nomenclature of 'nameless' disease. Brother Doolittle, the disease you encountered is not *Bacillus depilis*, but a much graver malady, and the ants had nothing to do with it only when they dug up the germs of the disease where you had buried it; and changing queens is utterly useless as a remedial measure.

This disease often plays havoc in the spring, especially where brood-rearing is progressing rapidly in cold or chilly weather, and in hives without sufficient protection. In an apiary so situated, let the microbe (or bacillus, if you prefer) find a lodgment with a hive crowded close together, if you want to see bees die and the apiarist get the blues.

The disease which friend D. encountered, and which I have met in Indiana, Texas, and badly in California, is, in my judgment—

1. Of bacillic origin.
2. Contagious.
3. Does not attack the young bees before they emerge from the cell.
4. Rarely, if ever, attacks bees after they have been in the fields for a week or ten days.
5. Primarily attacks the nurse-bees in the second week after hatching, and is communicated by them to the young field-bees, to younger nurse-bees, to the drones, and, lastly, to the queen, in the order above mentioned. The queen and drones generally escape the malady, and the old field-bees always escape. When the queen dies the bees will rear another, sometimes two or three, from the eggs or larvæ in the hive. The symptoms are:—

1. Lassitude.
2. Enfeebled power of motion.
3. Inability or unwillingness to sting.*
4. Paralysis—first, hind legs; second, of wings and abdominal muscles; third, of the second pair of legs, death being simultaneous with the complete paralysis of forelegs and antennæ. Paralysis of the muscles used to work the sting is, I think, the reason they cannot be made to sting. Dissection shows the alimentary canal to be loaded with thick but not dry feculent matter, revealing that either paralysis or con-

* I have never been able to induce a bee so afflicted to attempt to sting by pinching, rolling between my thumb and finger, or taking a few in my hand and gently squeezing them.

stipation had occurred at the outset of the disease.

A bee afflicted as above described rarely lives for two days, frequently dying in a few hours. I have seen them fall by the wayside after getting a load in the field. Others would reach the alighting-board with their pollen-baskets full, and be unable to enter, and thus die, as it were, on the doorstep. The odour emanating from bees dead with this disease is almost identical with that from the dissecting-room of a medical college. Bees with this malady do not become bald or hairless, nor have the trembling motion. This disease never attacks queenless or broodless colonies. Next, in order of escape, are those with very little brood, and therefore, few bees under twenty days old.

In my apiary of 130 colonies last spring, 125 had the disease, five were queenless, and so escaped; two other queenless stocks to which I had given brood escaped until the young bees were about ten days old. Stocks that were preparing to swarm lost fully two-thirds of their bees in two or three weeks. It was interesting to watch these colonies two or three weeks after the appearance of the malady, and see that three-fourths of the field-bees were old, grey, and bald-headed fellows.

The malady lasted for about two months from its first appearance until it was of no appreciable consequence, although it was over three months before it took its final leave. I lost only two colonies, but it effectually prevented swarming. It is the best non-swarming device of any, but do not try it if you can help yourself.

I have no doubt but that the real cause is of microbic origin, assisted by cold and damp, especially damp, chilling winds; therefore give good protection, especially in the spring. The malady showed itself in my apiary this spring in two days after a cold north-west wind that kept the bees at home for most of two days; but it had made its appearance in Mr. Cheadle's apiary, only about a mile distant, some time before, but also after a cold, chilly wind. I think the bacillus was present; and when the cold winds came the bees, in trying to protect the brood, gorged themselves with honey and pollen to increase the heat, and did not gather in a compact cluster as broodless stock would do, and so were chilled and enfeebled, and thus furnished a fruitful field for the propagation of the bacteria. That it is not caused by cold alone is proven by its not appearing every spring after cold spells, when the bees are in like condition as to brood. That they have consumed much pollen is demonstrated by the composition of the contents of their intestinal tube.

When you see a few bees moving sluggishly over the alighting-board, or lying as if they were sunning themselves, and, when disturbed, move their hind legs with difficulty, take a few of them between your fingers and thumb, and, if they will not attempt to sting, be sure you have a colony that is afflicted with a very grave

malady. Bees thus afflicted do not curl up like those that have been stung, although a bee that has received the barbed javelin of his enemy never tries to sting, but uses his strength to get away from the swarm to die.

I fancy the disease above spoken of is produced in the bees by a cause somewhat similar to that which produces 'la Grippe' in the 'human insect,' and would therefore suggest *Apis la grippe* as a name, although *Apis paralyticus* would be more appropriate.

Perhaps spirits of turpentine, rubbed up with sugar, one part to ten, or mixed with honey, one part to thirty or forty, will be found of value; but remember that any remedy for a disease that often eventuates in recovery may be over-estimated. Remember, too, that a bee that is once afflicted with this malady never recovers, although the colony generally survives it.—E. S. ARWINE, in 'Gleanings.'

SUPERSEDING THE OLD QUEEN.

HAVING QUEENS FERTILISED IN FULL COLONIES WITH A LAYING QUEEN.

I notice Dr. Miller says that he 'tried superseding quite a number last year by having a young queen hatch out in a cell-protector. They hatch out all right, and would be found peacefully traversing the combs: but before it was time for them to lay, every last one disappeared. If I had removed the old queen, I have no doubt all would have been lovely.'

This item is of special interest to me, being right in my line of experiment involving my plan of having queens fertilised in full colonies having a laying queen.

It is not necessary to remove the old queen—simply divide the brood chamber into two parts with excluder zinc; and instead of putting in one zinc division-board, put in two, about half an inch apart, or, what is better still, put the zinc division-boards far enough apart to allow a comb between them, and then fix a strip of zinc before the old queen's half, and the young queen will be fertilised, and lay as certainly as if she were in a separate or nucleus hive. I have tried more than a hundred in just the way Dr. Miller describes; and so long as the young queen was admitted on the combs where there were eggs, nearly all were missing. Probably they thought they were not needed, and flew out of the hives and never returned. I do not know that I ever had *one* become fertilised when eggs were present; and it is my belief that, if the old queen should travel across one of the combs, it would have the same effect.

The reason I think it is the young queen's fault is this: I make the queen-nursery with Benton cages, by suspending them between the combs by a ravelling of wire cloth attached to a match that rests across the top of the adjacent frames. The cells are thus arranged in the cages to hatch; then, when the young queens need food, it is provided by the bees. Before the cells are put in, a quarter-inch hole is bored through the wood into the cage, and a piece of

zinc with one perforation in it is tacked on, so when it is turned it may or may not admit bees into the cage and exclude the queen. I often keep a dozen to twenty young queens in this way until I have use for them, and it is often they are kept until they are too old to become fertilised; and while I used to lose a great many by the old method where bees were not admitted, I have never known a single one to die treated in this way, and I have kept them from July to November, and a laying queen outside the cages.

If we divide a colony into halves by a solid division-board, queen-cells will be built in the queenless half. If a division of excluder zinc is used, the effect is almost the same. They may build queen-cells or they may not. If they don't, put in the solid board; and when the cells are started, take out the solid board, and put the zinc in its place, and the cells will go on just the same. This raising the second queen in the same colony is a grand key to success. It succeeds where any sort of introduction fails. But the queens must be kept more than a sheet of excluder zinc apart, so I place the old queen on a four-frame restrictor in one side of the hive, put in one zinc division-board, and slide the entrance-blocks along, and the young queen has the privilege of flying from the hive and returning safely to her own apartment, and the bees go on storing honey as usual.—C. W. DAYTON, in 'Gleanings.'

Notices to Correspondents and Inquirers.

Letters or queries asking for addresses of manufacturers or correspondents, or where appliances can be purchased, or replies giving such information, can only be inserted as advertisements. The space devoted to letters, queries, and replies, is meant for the general good of bee-keepers, and not for advertisements. We wish our Correspondents to bear in mind that, as it is necessary for us to go to press in advance of the date of issue, queries cannot always be replied to in the issue immediately following the receipt of their communication.

All queries forwarded will be attended to, and those only of personal interest will be answered in this column.

** Complaints reach us from time to time of persons not being able to procure the 'Bee Journal' from their local bookseller. No such difficulty need arise. Local booksellers experiencing such a difficulty should instruct their London agent to apply to Messrs. Kent & Co., Paternoster Row, E. C.

A SUBSCRIBER (Rhyl).—Candy Feeding.—

Receipt for candy-making appears on p. 569.

For method of feeding see reply last week to 462, p. 565.

AN ANXIOUS BEE-KEEPER (West Cheshire).—

You will do more harm than good by disturbing the bees during the winter months. Take as much trouble as you please in preparing them well for it in good time, but once 'winter-packed,' they should be left severely alone till March next.

J. MENTON.—The 'Bee Journal' at Railway

Bookstalls.—There need be no difficulty in procuring the *Bee Journal* at railway bookstalls. Messrs. W. H. Smith & Co. take many hundreds of copies of it weekly for their customers.

** Communications from J. Traynor, 'Amateur Expert,' and 'X-Tractor' will appear next week.

Special Prepaid Advertisements.

Situations, Publications, Bee Plants, &c.—Twelve words and under, Sixpence; for every additional Three words, One Penny.

Trade Advertisements not inserted under this head.

WANTED.—About 60 lbs. of good Run Honey. Address Mr. W. CHITTY, Middle Class School, Pewsey.

FOR SALE.—50 lbs. of Granulated Honey in One-pound Tie-over Jars. Put on rail for 35s. Address A. WREN, Five Ashes, Mayfield, Surrey. L 90

A WATER SPANIEL, 6 months' old, well bred. Will Sell or Exchange for Bee-hives and Appliances. Address WM. JAS. ANDERSON, Ards, Caledon, Ireland. L 91

LANTERN SLIDES.—MR. WATKINS will be able to supply a few Sets from his Negatives to Lecturers on Bee-keeping. All Photographs from Nature and Photomicrographs. Early application advisable. List free. Address ALFRED WATKINS, Hereford.

WINTERING BEES. By THOMAS W. COWAN. The most complete work on the subject of Wintering published. Third Edition. Price 3d.

J. HUCKLE, Kings Langley, Herts.

THE DEPOSIT SYSTEM.

British Bee Journal and Bee-keepers' Record.

OFFICE: KINGS LANGLEY, HERTS; AND

17 KING WILLIAM STREET, STRAND, LONDON, W.C.

The following are the Rules under which we are prepared to receive Sums of Money on Deposit from persons buying and selling goods.

In order to save trouble it is requested that the Rules be carefully read over by persons using the Deposit System of trading.

DEPOSITING.

1. Method.—When strangers are dealing together, the purchase-money of the articles is deposited at our office. We acknowledge receipt of the deposit to both parties, and hold the money until we are satisfied that the purchase is concluded. If a sale be effected, we remit to the seller the amount deposited, less a charge of 6d. and the expenses of Post Office Orders and postage, &c. Cash will be forwarded by cheque, Post Office Order, or by Postal Order as preferred. If a sale or exchange be not completed, we return the amount deposited, after making the same deduction. By this means buyers and sellers are secured from fraud.

2. Deposits.—Postal Orders (drawn on General Post Office) and Cheques must be made payable to John Huckle, and crossed 'Bucks and Oxon Bank.' The numbers of the Postal Orders should be kept by the sender. We cannot be responsible for any losses that may occur in transit.

3. Honey on Approval.—All honey will be sold by sample, which must be sent direct to buyer.

4. Bee-appliances.—In ordering, the time allowed for completing the order to be stated to us when sending cash. If maker accepts, we hold cash till transaction is satisfactorily completed, when the amount will be remitted subject to conditions as in Clause 1.

5. Bees and Queens.—These will be dealt with entirely by the parties concerned, so far as price, &c., goes, and when the purchase is satisfactorily completed cash will be remitted as per Clause 1.

6. Goods in Transit.—These are at the seller's risk, i.e., any damage to or loss of an article on its journey is borne by the vendor; but a rejected article must be properly packed and returned by the same means as was used in sending it.

7. Carriage.—The carriage of all goods, except such as are sent by post, is payable by the buyer, unless otherwise agreed. If any article sent on approval be returned, each party to the transaction must pay carriage one way.

BALDWIN'S is the Oldest Establishment in the United Kingdom wholly devoted to Bees and manufacture of

Bee-keepers' supplies. His prices will compare most favourably with those of any other Maker, while for quality of material, suitability and workmanship, he has no rival.

'Why can he give better value for money than others?' Because he spends less in large 'puffing' advertisements, buys in the best markets for prompt cash, has no rent to pay, and personally conducts his own business.

For prices and full particulars of Goods see Baldwin's Bee-keepers' Instructor (and Illustrated Catalogue combined), which 'contains more practical and reliable hints than all the large, expensive books,' post free for 2d. stamps. Address S. J. BALDWIN, The Apiary, Bromley, Kent. N.B.—More than 500 Silver and Bronze Medals, First and other Prizes, and Testimonials innumerable.

CROCUS for EARLY POLLEN.

A FEW Thousand Fine Sound BULBS, to Clear, at 5s. per 1000. Address

P. HARBORDT,

50 GREAT CHARLOTTE ST., LIVERPOOL.

WANTED, a PUPIL or GENTLEMAN PARTNER for BEE-FARMING in Austria. Address FÜRNERANZ, Meran, South Tirol. 3327

British Bee Journal and Bee-keepers' Record.

OFFICE :

17 KING WILLIAM STREET, STRAND, LONDON, W.C.

PURE CANE SUGARS.

For the accommodation of Bee-keepers, guaranteed Pure Cane Sugar will be supplied in large or small quantities through this office at the under-mentioned rates:—

MOIST. (For Household Use.)

	Neat bags, 14-lbs.	25-lbs.	56-lbs.	Cwts.
3. MUSCOVADO	2/7	5/2	10/- 19/6

CRYSTALLISED.

4. DEMERARA	} Crystals	2/3	5/4	10/6	20/6
5. BARBADOS					
6. TRINIDAD					

REFINED CANE.

7. WHITE CRYSTALS (Small)	3/0	5/10	11/6	22/6
8, 9. (Medium and Large sizes, 1/- per Cwt. extra.)				
10. LUMP (Cut Loaf) ... Boxes,	3/3	6/3	12/3	23/6
11. LUMP DUST	3/	6/-	11/9	22/9
12. PRESERVING	3/-	6/-	11/9	22/9

FINE. (For Household Use.)

13. GRANULATED ...	3/3	6/3	12/3	23/9
14. CASTOR Coarse (15 Fine)	3/9	7/3	4/3	27/9
16. ICING... ..	4/3	8/3	15/9	31/-

All above guaranteed made from CANE SUGAR only, and free from BEET, CHEMICALS, etc., etc.

CARRIAGE PAID on Orders over 5/0 (or 25-lbs. Sugar) to London and Suburbs.

COUNTRY ORDERS, not less than 2-cwt. carriage paid at 1/0 per cwt. extra.

(Scotch and Irish orders, special arrangements.)

CHEQUES payable to J. HUCKLE, Kings Langley.

Cash to be sent with order, and purchasers will please observe that if samples are required or replies asked to inquiries, a stamped addressed envelope must be sent, as we cannot undertake cost of postage.

THE
British Bee Journal,
BEE-KEEPERS' RECORD AND ADVISER.

No. 496. Vol. XIX. N. S. 104.]

DECEMBER 24, 1891.

[Published Weekly.]

Editorial, Notices, &c.

SEASONABLE.

We avail ourselves of the fact that our present number will be in the hands of most of its readers on the morning of the 25th to wish them, in the good old-fashioned words, 'A Merry Christmas,' and trust that it may be a time of peace and good-will in every household where the *British Bee Journal* is read.

BRITISH BEE-KEEPERS' ASSOCIATION.

Subsequent to a meeting of sub-committee held at 17 King William Street, at which there were present the Rev. Dr. Bartrum, Messrs. T. W. Cowan, Jesse Garratt, R. A. H. Grimshaw, and W. B. Carr, the monthly meeting of the Committee was held at 105 Jermyn Street. Present: Mr. T. W. Cowan (in the chair), the Hon. and Rev. H. Bligh, Messrs. Jesse Garrett, and W. H. Harris, together with the Rev. W. B. Burkitt, Messrs. Carr, Grimshaw, Hooker, and Meggy, *et-officio*. Letters were read from Mr. McClure, Captain Campbell, and others, explaining their inability to be present. The Secretary, Mr. Huckle, was also unable to attend, his absence being, to the regret of all present, caused by illness.

The minutes of the last Committee meeting having been read and passed, the sub-committee appointed to deal with the question of a syllabus for the use of lecturers reported having met and considered several forms of a proposed syllabus. A final decision regarding them was, however, postponed till another meeting could be held. After some discussion it was decided that, when the sub-committee had finished their work, copies of the suggested syllabus should be sent to each member of the General Committee, to be considered at a future meeting.

The attention of the Committee was drawn to an alleged irregularity with regard to examinations for experts' certificates, as reported in the *B.J.* of December 3rd, and the Secretary was instructed to write to the gentleman concerned requesting an explanation of the matter for consideration at the next meeting. Referring to Messrs. Newton & Co.'s new series of lantern slides for the use of lecturers, reported at the last meeting, the Chairman explained that he had, as requested, conferred with Messrs.

Newton, and these gentlemen expressed their desire to prepare such slides as might be recommended by the Committee, both with regard to the number of slides required and the selection of subjects for representation. He (the Chairman) had promised to render them further assistance in the matter, and the slides will be got ready as soon as possible, and in accordance with any syllabus that may be suggested by the Committee.

A letter on the subject of slides from Mr. Watkins was also read, and the consideration of it adjourned till next meeting. Several other matters, chiefly of business details, were then discussed, and the meeting terminated in the usual manner.

SAD ACCIDENT TO A WELL-KNOWN
BEE-KEEPER.

We have received from Lord St. Vincent, President of the Notts B. K. A., the particulars given below. The first account sent by his Lordship stated that Mr. Pugh had died from the effects of his injuries the same night, but, though the report was apparently well founded, it happily proved incorrect. Just before going to press we learn from Lord St. Vincent that Mr. Pugh still lives, and we are sure that all will rejoice to know of even this small consolation.

The following is the letter referred to:—

'It is with feelings of the deepest regret that I write to inform you of a very sad accident which happened to Mr. Arthur G. Pugh, who, while following his usual employment, on the 16th inst., seems to have stepped out of the way of one train into the front of another. The train passed over both legs, and severely injured his head. He was conveyed by the same train to Leeds, and taken to the infirmary, where, from later advices, I learn that, though very severely injured, he still lives and is progressing as favourably as can be expected.

'Mr. Pugh, who for a long time has been Hon. Secretary of the Notts Bee-keepers' Association, will be sadly missed by all Notts bee-keepers, who have always found him most kind, courteous, considerate, and helpful in every difficulty. The harder the work that he had to perform, the more cheerful he seemed to be. The Association has lost its right hand, at least for a long time, and all members of it a friend whom they will find it hard, if not impossible, to replace.—I am, &c.,
ST. VINCENT, *President Notts Bee-keepers' Association, December 19th, 1891.*

AN EXPLANATION.

Our readers will have seen an apology on page 533 of the *B. B. J.* which was inserted at the request of the Editor of the *Journal of Horticulture*, with reference to a libellous article which appeared on page 211 of that *Journal*. We regret that through an unintentional oversight on our part, an error has crept into that apology, and it is with pleasure that we withdraw any imputations or insinuations that may be conveyed in this particular paragraph. We were surprised that, without our having an opportunity given us of correcting the mistake, the following appeared on page 485 of the *Journal of Horticulture*:—

'AN EXPLANATION.

'It has come to our knowledge that the publication of a statement which appeared on page 442 in our issue of November 19th was inserted under a misapprehension, and that the information supplied to us that "there was no mention of the Punic bees in the *Record* of June, 1890, nor has there been any allusion to them, either editorially or by any of its correspondents," is not in accordance with facts. Here are the facts:—

'On page 74 of the *Bee-keepers' Record* for June, 1890, a question is asked by Guillaume, Wigtownshire, N.B., "What kind of bee is the Punic?" to which the editorial reply is, "According to 'A Hallamshire Bee-keeper' the Punic bee comes from North Africa. It is dark in colour, and from our limited experience of it is a good worker and a prolific sort."

'It will be seen that "Punic bees" are twice mentioned there, and that a reply is given founded on "experience." Yet in the *British Bee Journal* for August 27th, 1891, on page 381, the same Editors, in reply to "Inquirer," say, "We know nothing about the so-called Punic bees, and can give no information as to their value."

'We were induced to publish the statement last week in reliance on the accuracy of the matter furnished, and with a desire to be just to the conductors of our contemporaries; but we must also be just to our correspondent, "A Hallamshire Bee-keeper," who has placed in our hands evidence which justifies us in making this explanation; and, we would add, our long experience has led us to regard him as an accurate correspondent.'

As soon as our attention was drawn to this we forwarded to the Editor of the *Journal of Horticulture* the following explanation, requesting its insertion in his journal. Further comment on our part is unnecessary:—

AN EXPLANATION.

To the Editor of the '*Journal of Horticulture*.'

I have had the *Journal of Horticulture* sent me, and my notice has been directed to an editorial explanation on page 485.

In your zeal to do justice to your correspondent you certainly appear to embrace the opportunity of being unjust to your contemporaries. When I wrote to you on the 19th September last 'I can find no allusion made in the *Record* about Punic bees, either editorially or by any of its contributors,' I did so in perfect good faith, but I frankly

admit that I was led into the error by an unintentional oversight on my part. To have admitted that Punic bees had been once alluded to editorially in the *Record* would not have altered the nature of the libel, as there was no question about this paragraph, but about a reference by your correspondent to an article in which there was no mention of Punic bees at all. Any unprejudiced person can see that the editorial allusion you quote has nothing whatever to do with personal experience, as it is couched in general terms, just as the same term 'our limited experience' is daily used in a legitimate way in ordinary language in connexion with things the writers have had no experience about, but about which they are writing from the reports of others. Such language is in daily use in all our papers, and it would be a stretch of the imagination to attribute personal experience to the writers.

The context will also show that it is more the expression of the limited experience of 'A Hallamshire Bee-keeper,' who had just been given as the authority, as he was the only one who had said anything about Punic bees, and this in the concurrent number of the *British Bee Journal*. This reply given by Mr. Carr could not have been from personal experience, as he had never seen a Punic stock, and knew nothing about such bees; in fact, although Mr. Carr was anxious to do Mr. Hewitt full justice, so little value did he attach to these bees that there is no reference to them in the index, hence the reason for my overlooking the paragraph referred to. Mr. Carr seemed perfectly oblivious about this paragraph, and I am not surprised at it. The first description of Punic bees was given by Mr. Hewitt in *B. B. J.*, on page 271, 1890. He again refers to them on page 511, and on page 512 Mr. J. Luck asks for results respecting Punic bees from those who have tried them. There was not a single response to this appeal from any one who had tried them except Mr. Hewitt himself. He had already had full justice done him, and we naturally wanted to hear about the experience of some one else besides Mr. Hewitt. No one will be surprised that after such a complete failure of reports, Mr. Carr should have dismissed the matter from his mind as being of no importance.

Now, Sir, I think I have just cause for complaint. When I placed all the papers before you (including the *Record* of June containing the passage now referred to), you promised to have the matter investigated, and in your letter to me of the 23rd of September you stated, in reply to my letter of the 19th of September: 'When Mr. Wright returns to the office I will authorise him to see to the matter.' Mr. Wright was to have returned about the 2nd of October, and, not hearing from you, I wrote on the 22nd of October, and from your reply on the 23rd of October I gathered that you had not made the investigation which you had promised to make, although a month had elapsed. Had you made this investigation probably the error, which I am sorry was made, would have been detected and avoided.

You refer to this mention of Punic bees and take the opportunity of saying: 'In the *British Bee Journal* for August 27th, 1891, page 381, the same Editors, in reply to "Inquirer," say, "We know nothing about the so-called Punic bees, and can give no information as to their value."' You, Mr. Editor, are perfectly well aware that this is

not true, and that the reply to 'Inquirer' was written by me alone, and that I was speaking of my own experience and not of Mr. Carr's. You will see by the *British Bee Journal* that I am responsible for the conduct of this paper, while Mr. Carr conducts the *Record*, so that there was no inconsistency in my reply of not knowing anything about so-called Punic bees, and you must disconnect Mr. Carr, the writer of the reply in the *Record*, from my reply in the *British Bee Journal* altogether. But, after all, one of the main points at issue was the statement in the article by Mr. Hewitt in the *Journal of Horticulture* on the 3rd of September, in which he says: 'They do not say that the Punic stock in Mr. Carr's apiary in the spring of 1890 was the "best and strongest" he had' (see *Record* for June, 1890). On reference to the article from which the quotation is made by Mr. Hewitt, it will be seen that there is no mention whatever about Punic bees or to a Punic stock in Mr. Carr's apiary. The article refers to quite another matter altogether, namely, to virgin queens sent out to test a wintering theory of the writer's. I have simply to emphasise what I have already said, that I know nothing about so-called Punic bees, although I know North African bees very well, more especially those of Algeria, Morocco, and Tunis. Some of these days I shall have plenty to say about the bees of this last place, also about the apiary belonging to a French gentleman (whose name, for obvious reasons, I withhold), and who exports Tunisian bees, and whose apiary I intend visiting during my rambles in Africa, whither I contemplate going for the purpose of finding out why the bees of Tunis are not pure, like those of the same varieties in Algiers, and why they sometimes show yellow bands.

Your correspondent's accuracy is certainly very much shaken when we remember what he has said about Syrian and Cyprian bees, and we all know how they have turned out. Also, for instance, what he says on page 316 of the *Journal of Horticulture* about these (Punic) bees, 'that their natural months for rest is our summer, which is their winter.' I should think you, Mr. Editor, at any rate, would know that the seasons in North Africa, as in all places north of the equator, are at the same period of the year as ours, yet you endorse this as accurate.—T. W. COWAN, Ed. *British Bee Journal*.—7th Dec. 1891.

By arrangement with Dr. Hogg, the above explanation will be printed in the *Journal of Horticulture*.

SHALLOW FRAMES FOR EXTRACTED HONEY.

As promised, I will attempt a short article on the advantages of using a super or half-story (in other words, a case containing drawn combs half the depth of those used in the brood chamber) for the production of No. 1 extracted honey, and as an adjunct or assistant in securing a first-class crop of comb honey, such as no one need be ashamed to place on any market.

I know there are objections to a practical apiarist having different sizes and styles of hives and combs in his apiary; still, experience teaches me, at least, that the advantages outnumber the

disadvantages, especially if the outside dimensions of the hives and supers are alike.

First, I would ask, why object to a half-story containing combs such as described, any more than the use of supers containing sections for comb honey, so long as the complete tiering-up of all is not interfered with? Second, why should bees be allowed to cling to the brood chamber in the fore part of the season, depositing honey therein, only to crowd out the space which should be occupied by the queen? Simply because there is not sufficient inducement to entice them to deposit it above.

Now, we all know the giving of a full story in most localities at the time when more room is needed is rather more space than is necessary, and consumes too much of the heat required in the brood chamber, unless the hives are chaff-packed; and, again, the giving of a super containing sections, especially if they are not nearly all drawn out the previous season, does not always succeed in gaining the desired end. There is, however, no trouble if a half-story of drawn combs is first given, as such can compose a part of the brood chamber proper sufficiently long to secure the point sought for. The market requiring choice grades of honey is yearly becoming more marked; particularly is this the case in regard to variety and quality: therefore I venture the opinion that, while honey may always be honey in the proper sense of that word, still all kinds of this article are not alike to a consumer any more than all kinds of butter, or, in fact, any delicacy usually found for sale, and no one knows this better than bee-keepers generally. Now, in order to secure the different varieties by themselves, as nearly as possible, no other system offers better facilities than the half-story system. There are localities and hives where it is not only advisable, but necessary, to extract from brood combs in order to secure the honey of poor quality and flavour from being deposited in sections (a place, by the way, in which the very finest honey only should be stored) or placed in combs of full depth, when added above the brood chamber, thus completely destroying the appearance and flavour of a large quantity of what ought to have been a first-class article of clover honey; and while my own locality does not differ materially from the one quoted, still my mode of procedure is somewhat different, not, however, that it is by any means new, but because I am not an advocate of extracting from combs containing brood, especially unsealed larvæ, as I believe brood in brood combs and honey in store combs is the proper place for both; in other words, the queen in one apartment, and the honey in another, at all times, except, of course, during winter. And right here I trust you will pardon the digression when I state that incalculable damage is done yearly from such work, independent of the risk of encouraging, if not propagating, the great curse of our pursuit—viz., foul brood.

But to resume. The method adopted by myself is as follows: About the first of June, or a little earlier in some instances, as soon as the

queen requires more room (I use the eight-frame Langstroth and New Heddon hives), the hive is opened, and the face of every capped cell of honey is bruised by simply drawing a knife flatwise across the comb, first driving the bees away with smoke, or, if necessary, shaking them from the combs altogether, when a half-story of drawn combs, as described, is placed over the brood chamber, and the cover to the hive replaced for two or three days, when it is again opened, and a queen-excluding honey-board placed between the two, as egg-depositing in supers is not encouraged, although the presence of a few eggs will do no harm at this juncture, providing the bees are not allowed to build queen-cells, and a young queen reared and destroy the one below. It is, of course, presumed, when the excluder is inserted, that the old queen is in the lower portion of the hive. Reversible frames are said to accomplish this end, if the reversing is done at the proper time, without the necessity of bruising the face of the comb: but not having had an extended experience with such I can give no decided opinion, although I do not see why such a course would not work. This, however, I do know: the dividing of the Heddon hive—viz., placing the top half below, and the bottom part below, will effect the same purpose.

There will now be no difficulty in securing the honey in its proper place, after it has been carried upstairs, from this time henceforth. You will please observe there is no difference up to this point, whether or not one is working for comb or extracted honey, as that can be determined afterward, as the strength of the colony and strain or race of the bees are factors that must or ought to be considered, especially in producing the former article.

We will suppose extracted honey is desired. If so, all that is required is to raise up the first half-story or super containing the dark honey stored from the brood chamber, and any that may have accumulated before the flow from clover has commenced, and add a second, which will, of course, now be filled with clover, while a third or fourth may contain basswood or thistle, as the case may be, and yet all can be thoroughly ripened on the hive, as it should be, for many reasons too numerous to mention here.

If, however, for want of sufficient combs you prefer extracting the different kinds before thoroughly ripened on the hives, it is an easy matter to place one of the several bee-escape boards (preferably the Porter spring contrivance, which, by the way, is only beginning to be half appreciated as it ought to be) under each top story, and free the supers from bees in a few hours. They can now be extracted and again returned to the hives. This way of managing, to one who has never before tried the escape system, will, I fancy, become permanent with them, as the pleasure of removing shallow supers containing nothing but honey has only to be tried once to be appreciated.

In the event of your being a producer of comb

honey, all that is necessary is to tier up as for the extracted article. With this advantage, only one case of sections need be given any colony, unless considered advisable to do so, and this not given until the honey is coming in rapidly, and the bees ready and willing to fill and seal them in short order, and thus present you with an article as white as snow, instead of travel-stained, propolised sections, sufficient to disgust any one from purchasing, even at a low figure. Again, I find I can get more and better comb honey, with fewer unfilled sections, than by any other process: in fact, it is not at all desirable to carry over any partly drawn sections from the previous year, as, in my own experience, they are not filled and sealed any sooner than a new case of sections containing full sheets of thin foundation, when added under a half-story as described.

The only valid excuse against using these half-stories is the expense and the time consumed in handling the double number of frames. As to the first reason, I am free to admit the cost is a trifle greater: still, if protected by outside cases until clover commences to bloom, the material comprising them not be any thicker than three-eighths of an inch stuff. As to the second reason, I find it easier and more expeditious to uncap and extract two sets of half-depth frames than one of the full size, as one sweep of the knife cleans the face of every comb in an instant; and if your frames are wired, as they ought to be, even in half-stories, notwithstanding what others may say to the contrary, and your extractor is capable of taking a full set of eight frames, or four of the large ones, as with myself, no time need be uselessly sacrificed.

Now, friends, try them. There is, however, no necessity of going into the experiment in a wholesale manner; a few at first, and more afterward if you need them, will be a wise plan to follow. I know they are gaining ground yearly, and this fact alone should be a guarantee that they are not a useless appendage in the apiary: and, as I am about concluding, let me add: At all times have plenty of store or surplus combs, no matter of what style or depth, as they are good capital at any time, especially in a poor season like the past, as bees stored in such and did well, while those in sections or on frames of foundation did little or nothing. —F. A. GEMMILL, in 'Cleanings.'

WHICH HIVE SWARMS COME FROM.

Sometimes it is important to know the colony from which a swarm has issued unseen. This is Dzierzon's method:—After it has been hived and removed to its new stand, let a cupful of bees be taken from it and thrown into the air, near the apiary, after having sprinkled them with flour; they will soon return to the parent colony, and may easily be recognised by their standing at the entrance framing, like ventilating bees. —*American Bee Journal*.

Correspondence.

The Editors do not hold themselves responsible for the opinions expressed by correspondents. No notice will be taken of anonymous communications, and correspondents are requested to write on one side of the paper only, and give their real names and addresses, not necessarily for publication, but as a guarantee of good faith. Illustrations should be drawn on separate pieces of paper. We do not undertake to return rejected communications.

Communications relating to the literary department, reports of Associations, Shows, Meetings, Echoes, Queries, Books for Review, &c., must be addressed only to 'The Editors of the "British Bee Journal," 17 King William Street, Strand, London, W.C.' All business communications relating to Advertisements, &c., must be addressed to Mr. J. HUCKLE, Kings Langley, Herts (see 1st page of Advertisements.)

* * * In order to facilitate reference, Correspondents, when speaking of any letter or query previously inserted, will oblige by mentioning the number of the letter, as well as the page on which it appears.

THE FUTURE OF BEE-KEEPING.

[885.] I arise to play the—for me—new rôle of a 'croaker.' It is distasteful, but it is necessary. I have a large faith in my country and in its future, and that embraces even bee-keeping. For years we have fought 'Socialism' and blinded our eyes to the need for technical instruction; but at last we are all turned Socialists and have gone in for technical instruction with a vengeance! It has been my boast—my very loud and cheerful boast—that we possessed sufficient public spirit to do voluntarily what in many countries has been done by State aid. To-day my boast is hushed in the silence of doubt, and a doubt bordering on despair. I confess I see dangers in the near future, the greater because Demos is god, and Demos is just, when once he gets hold of his facts, and he will soon get hold of his facts about technical instruction.

I see the gross and arrant folly of manual instruction being taught the schoolmasters in a fortnight, and they, on the strength of this instruction, allowed to teach it with a skilled artisan to assist: of University Extension lecturers sent to talk to 'Hodge' on garden, allotment, and fruit culture, accompanied by a trained gardener to answer questions, the fee paid to the former being 2l. 2s., and to the latter 5s. or 7s. 6d.; of 'health' lectures by people who did it voluntarily, but who now sneer at less than two guineas, 'because it is public money,' as if that were an excuse for political immorality! And last, and what concerns us most, of a lecturer on bee-keeping at from 3l. 3s. to 6l. 6s., and an expert to accompany him as a referee on practical bee-keeping at 7s. 6d.!

The money comes easy, it is true, and it seems as if it is being helped to go easy; but I venture to predict that it will not last. Public opinion will be outraged, and retribution will come, swift and sure. What I ask is, that bee-keepers do not hasten the day. Although I am out of the run of the B.B.K.A., my love for the craft has not abated me yet, nor my true estimate of its worth as a minor rural industry. I trust I may be able during the coming year to assist it

in my adopted county by the help of public money: but if I do it will be with a decided effort to give the public some equivalent for the money I may be able to induce them to spend.—AMATEUR EXPERT.

IN THE HUT.

'This pair in matrimony
Go most unequal snacks;
He gets all the honey,
And she gets all the whacks.'

HOOD.

[886.] There is no appositeness in this quotation, I make haste to say: I have merely dragged it into the hut so that it is taken care of, and I also fear that if Mrs. X-Tractor saw it in the *B. B. J.* without this disclaimer, I should be not only a D-Tractor, but have to be a Re-Tractor.

In these days of apianian novelties, *i.e.*, new bees, where is now the 'Minorcan,' first sent to England five years ago by Mr. Andren, and again in July, 1888? Mr. C. N. Abbott, of Southall (the *doyen* of bee-keepers), successfully introduced this queen, and yourself, Mr. Editor, on November 6th, 1888, examined her progeny, making the remark that 'they were very black, and dreadful stingers; given, besides, to blocking up the entrance, so that only one bee could pass at a time.' In March, 1889, Mr. Andren advertised Minorcan queens for sale in this country. Can any one give us any further information about them after that given by Mr. Howes, in November, 1889, who says, 'The workers are very black, very nervous, and vicious; they swarm much, and stick everything up with propolis,' and so on? I will remember Mr. Abbott and myself looking through his stock of Minorcans. When we came to the comb, on which was the queen, she immediately took flight, whereupon the veteran at once deftly caught her *on the wing*, and returned her to the hive.

I have heard of a new hive cover, and intend to try it. It is the tarpaulin cover used by commercial travellers over the hampers containing their patterns, and is just a nice size to pop over the whole hive—that is if one end, or the lower part of the end, be cut out of the cover, so as to leave a clear way to the hive entrance. Second-hand, they can be had very cheaply. Winter's snows and frosts will be thus almost defied in case of either thaw or rain, and the heat inside the hive will be kept in.

Bees are flying nearly every day during the present open, mild weather, with an outdoor temperature of 52°, pointing to increased consumption of stores intended to last all winter. Unless I am much mistaken, candy will be much *en evidence* some time about March, just at the time when people are tempted to go in for syrup feeding, obtaining a race of young bees with the accompanying drain on stores and lots of excitement, just in time for spring frosts. Then the anxious bee-keeper must look through his hives pretty often, just to give chilled brood a

chance of showing itself. If many bee-keepers were 'locked out' of their gardens, being only allowed in, say, once a month, and only during the first and last quarters of the year, the bees would get on better.

There was some talk recently anent the desirability of changing the name of 'foul brood' to one more explicit and plain. 'Rotting grub' and 'putrid maggot' are somewhat disgusting, and don't get us any 'forrhander.' Here is an opportunity for the ingenious to perpetrate a 'macaronic solecism.' A native of Stratford-on-Avon once said—

'What's in a name? that which we call a rose
By any other name would smell as sweet;'

and what we call foul brood by any other name would stink as bad.

As this is just the time to get in one's winter supply of bronchitis, let me give your readers a remedy I heard of last night:—Half a pint cod-liver oil; six lemons (without peel) sliced; half a pound of honey; half a pound of raw sugar. The whole put together and left on the oven top, in a basin, all night. Teaspoonful doses two or three times a day and on retiring. The sugar draws the acid juice of the lemons, and the whole leaves a clear liquid, which is quite palatable. The objectionable flavour of the oil is removed by the slight heat and the chemical admixture of the ingredients, so that, if all be true I hear of it, one might afterwards say—

'He on honey-dew hath fed,
And drunk the milk of Paradise.'

In a botanical work I came across *Lecheguana* honey—a dangerous kind of honey supposed to be furnished by *Paullinia Australis* and *Serjania lethalis*. The active principle of the first-named is similar to that of tea and coffee, and it is yielded twice as plentifully as either of these. It is used as a nerve-stimulant and restorative by the natives where it is found. *Serjania* (allied to *Paullinia*) is said 'to possess narcotic, poisonous qualities, and to be the plant from which the wasp called *Lecheguana de mel vermellio* in Brazil collects its poisonous honey. M. St. Hilaire has recorded the exceedingly violent effect of this honey upon his own person. In most cases it produces a sort of drunkenness or delirium only to be removed by emetics, but it sometimes occasions death. The plant forms one of the fish poisons called *Timbos* by the Brazilians.' Probing the point still further, I find the insect is *Polistes Lecheguana*, 'whose combs contain an excellent honey, resembling in consistency that of our own domestic species, but possessing at times the singular quality of rendering those who eat it furious or void of reason.' I mention this only to show how

'Within the rind of this small flower
Poison hath residence and medicine power,'

and that, when mixed with the nectar from other flowers, poisons become medicinal. All this results from Mr. Walton's kind wish about X-Tractor's' bronchitis.

In this month's *Revue* appears a sparkling tale about bees, which I would translate if I could do justice to it. Will Mr. Cowan kindly give it us? As literally as possible, please, or the effervescence flies.

I observe your 'Useful Hints' in this week's *Weekly Freeman*. This month, at least, I am true to my pseudonym as—X-TRACTOR.

[The Minorcan bees, in common with many others, have come and gone, and we now hear very little about them. The Minorcans alluded to by our esteemed correspondent, respecting which we wrote on November 7th, 1888, were not those of Mr. Abbott, but in far-away Switzerland, where we were at the time. These bees were in the apiary of M. Ed. Bertrand, and on page 573 of *B.B.J.* for 1888 will be found our description of them, and the manner in which they built barricades in front of their entrances. These bees were not very amiable when we saw them, but they became so vicious and aggressive that they had to be destroyed. Not only was it impossible for any one to come within several yards of the hive without being attacked, but they also attacked those who went past on the highway, although they were separated from this by a very high wall. An account of their behaviour was given on page 148 of *Revue Internationale* for 1889. Mr. F. C. Andreu, who sent these bees here, says, on page 616, *B.B.J.* for 1888, 'But, with my present experience, I should now say that our bees are *not* gentle—nothing like the Carniolans, for instance,' although he also says colonies differ in their temperament, and we all know that young bees are less inclined to sting than older ones. They are also enormous propolisers, and we find Mr. Andreu saying, in the same article, 'as to the propolis, such is the quantity they manage to stick together here that it at times hinders manipulations to a considerable extent.' From the fact that we have heard no more about these bees, we conclude that the experience of others coincides with our own. We have, however, for some time thought there was a great resemblance between Minorcan bees and those of northern Africa, even supposing they are not of the same race. But we regard them as of the same race for several reasons. Their family likeness is most striking, their habits are similar, and their propensity to use an immense amount of propolis makes them differ greatly from other races.

We are not the only ones who have observed this likeness, for the editor of the *Revista Apicola* has also written about it. We gave a translation of an article from the *Revista* on page 445 of *B.B.J.*, in which the editor says, respecting so-called Punic bees, 'So far as we are able to make out, this much-vaunted variety is none other than what we call the Minorcan bee. It probably comes to us from the north of Africa, hence its history.' This article was reprinted in the *American Bee Journal*, page 535, and, by an error, was credited to the *Revista*, instead of the *B.B.J.*, from which it was taken. On page 660 of the *A.B.J.*, Mr. Hewitt tries to discredit the writer of this article, and says, 'On page 535 is an extract from the *Revista Apicola*, stating that the Punic or Minorcan (or, more correctly, Balearic) bees are one and the same. The editor and writer of that paragraph, F. C. Andreu, has several times written to the *B.B.J.* (viz., in 1886, pages 169 and

282; and in 1887, pages 564.)' And then, alluding to some mistakes made by Mr. Andreu in his novitiate days, when he was a learner from the *B.B.J.*, he goes on to say: 'It is true that Mr. Andreu corrects himself in that number on page 580 (*B.B.J.* for 1888), but it is hardly fair to quote as "good authority" a writer who can make so many mistakes in the matter.' There was plenty of time for any sensible bee-keeper to become expert from 1886 to 1891; but the funny thing about it is that Mr. F. C. Andreu, whom Mr. Hewitt asserts to be the editor of the *Revista Apicola*, is nothing of the sort! The editor is quite another person; and, on looking on the first page of the paper it is to be seen that it is edited by Francisco F. Andreu, who is most probably also the writer of that article, and who, instead of not being 'good authority,' has shown by the manner in which he conducts his paper that he thoroughly understands his subject, and can be considered as a good authority on the bees of his land. Now, we believe the writer is quite right, for since 1888 we have had greater experience of Minorcan bees, as well as of African bees, and we can state that the Minorcan bees are as black as the blackest African bees from Algeria, Morocco, and Tunis, and blacker than some of the impure bees from the last place. We think, from this resemblance, there can be little doubt that they all had the same origin, and our belief is strengthened by the Minorcan bees being called *Moriscas* by the natives, thus denoting their African origin. It is further strengthened when we remember that the Carthaginians, who, besides having 300 towns—a dependent territory covering half the space between the lesser and the greater Syrtis (now the Gulfs of Cabes and Sidra)—had foreign dependencies in the Balearic Isles, besides those in Sicily, Sardinia, and Spain. Moreover, it is well known that it is supposed, when the Mediterranean was a series of large lakes, the Balearic Isles formed part of the mainland of Africa, and that they became detached at a later period than other parts of Europe. The insect fauna, also, is nearer allied to that of Africa than Europe, and there are many insects there that are only found in Africa. Whether the Carthaginians brought the bees to Minorca or found them there we are not prepared to say; at any rate, the evidence is very strong in favour of their being of the same origin as North African bees, and we cannot regard them as being of a different race. It would be interesting if Mr. Abbott, Mr. Blow, and other gentlemen who had these bees would tell us what became of them? As a warning to our readers we shall next week give a translation of the article we have referred to above.—Ebs.]

WINTERING BEES IN OUTHUSES.

[887.] In the *Bee Journal* of December 10th (p. 565) I was much struck with the manner in which a query (462) was replied to *re* wintering bees in outhouses. If theory goes for anything, then I should certainly say take your bees into a properly constructed outhouse for the winter, as I have done myself. As we all know, an ounce of practice is worth a pound of theory, and that if wintering bees on these methods has been known to fail in the hands of practical men, then why should each bee-keeper put himself to extra expense and trouble for no-

thing—otherwise, what would be the good of Associations for the promotion of knowledge? But, coming back to the house question, it is very hard to say what a properly constructed house means, but I will give you my ideas, and, in fact, particulars of what I have done so far.

In the autumn I took off all the surplus honey, leaving about thirty pounds in the body of each hive, and covering up for winter; but, owing to the continual downpour of rain which followed, I thought they would be certainly drier and warmer in a house; so I had a house built of one-inch boarding, eight feet by fourteen feet, and stood the hives inside, with the entrance of each hive close to, and facing, the side of the house, through which I bored two one-inch holes for bees to come out, and attached a small flight-board against the outside of the house, in case they may require a fly before the hives are taken out and distributed over the garden. Coming again to the inside, each hive is covered up to prevent the bees flying or robbing without first going into the open.

Having gone to this expense, I would be glad to know a few of the difficulties and the extent of mischief done, so that I might guard against unforeseen misfortune with my bees this winter.—JAMES BROWN, *Hon. Secretary Bristol District B.K.A.*

[In replying to Query No. 462, we only had in mind the simple question put to us—viz., the wisdom or otherwise of temporarily moving bees from their ordinary stands into warmer and drier quarters for the winter months. There was no intention named of transferring the hives into a bee-house and allowing for free flight, as is proposed above. But we cannot approve of Mr. Brown's plan any more than the one first named. When a bee flies abroad, instinct leads it back to the old stand on its return. Move that stand away for a few yards, and the bee is lost; and if this truism be lost sight of, mischief will ensue. Hence it has been found by far the best to accede to the advice we gave on p. 565.—Ebs.]

HOW TO BEGIN BEE-KEEPING.

[888.] I am a constant reader of your paper—at least, I have done so for the last seven or eight weeks—in the hope of gaining some information as to how I can start bee-keeping. I am fifteen years of age, and have to attend school. Be so good and let me know in your next issue how I should commence bee-keeping. So far I have had no experience at all. I have never even seen a bar-frame hive; but I obtained some sketches, and I could make a hive in our carpentering school. Money is an object to me. My parents' garden is about fifty feet long, thirty wide, and we keep a large quantity of fowls. I have little brothers and sisters, and we have neighbours left and right. I mention all this, as some one told me that bee-keeping in a private garden may be a nuisance to others and dangerous to the children and poultry. Is that so? I again beg of you to give me as much information as you possibly can. Our

gardener has a large piece of land, and I dare say I could obtain a small space to put up my hive there in case a private garden with fruit-trees and vegetables growing is not suitable. Do you think I am too young to begin bee-keeping; if so, would you advise me to wait till I am older? There are two bee-keepers in Jersey, and I dare say I could get an introduction to go and see their hives. Would it be right on my part to seek an introduction to see their hives, management, &c.? Thanking you in advance,—E. J. BARTON, *Jersey*.

[Our young friend's letter does him much credit; there is *business* in every line of it, and he should make a good bee-keeper. He has given us what Americans would call a rather 'large order'—more than we could well fill for him in the pages of the *B. J.*; but if he will invest sixpence in the little book called *Modern Bee-keeping*, most of the information required will be found therein. We may, however, say he is not too young to begin, and, unless we mistake, the bee-keepers referred to will willingly give him some useful information as to the prospects of success, because the amount of bee-pasturage in the district has, of course, much to do with his chance of doing well. It is rather doubtful if the bees can be safely kept at the home garden; the space is small, and with 'a large quantity of fowls' and 'little brothers and sisters,' the gardener's land seems to be the more suitable. But the advice of the neighbouring bee-keepers would be useful on this point, and we advise an interview with them as a first step before starting.—EDS.]

A FEW MEMS. FROM RECENT READINGS IN THE *B. B. J.*

[889.] I have thought that if our friend, the Expert, in the case recorded in the *B. B. J.*, October 15th (p. 462), had been a little clearer, and more definite upon the law of evidence on bees, the judge would have been instructed in the matter, and, perhaps, have given a different decision. It appears that the law upon bees is not so well understood as it should be, and as bee-keepers and bee-keeping have increased to such an extent this last twenty years, I would suggest that the explanation given by your correspondent, 'T. F. L.,' in *B. B. J.*, November 5th (p. 501), be added as an appendix to the future revisions of the *Bee-keepers' Guide-book* (of course, by his permission, with any additions), and as we generally look up to an expert for any and every kind of information in connexion with the craft, should not the law on bee-keeping become one of the subjects for examination by intending candidates for experts' certificates?

The present year, from various reports, appears to be a fair one for bee-keepers, and to those who are engaged in teaching and advocating bee-keeping. Many reliable records of results for the present year might be noted, which would be useful to them in their work; but they should be careful in selecting only those from experienced persons, and who can be relied upon

or referred to. Let them be true in words and figures.

Personally, I should esteem it a great kindness if our friend 'X-Tractor' would be good enough to favour me, and, perhaps, others (through your *Journal* or privately), with his recipe for bronchitis. It is a new experience to me, coming upon me in June last; I have not been able to get entirely clear of it yet.

I should like to express my gratitude to another of your correspondents, Mr. R. A. H. Grimshaw, for his most interesting papers on the 'Development of the Honey Bee;' they have given me some useful instruction and interesting reading.—J. BROWN, *Polyphant, Launceston, December 15th, 1891.*

MY HONEY REPORT.

NORTH SOMERSETSHIRE.

[890.] The bee-keeper's harvest lasted only a few weeks here this season, and was much later than usual. It was a rare occurrence to hear of a swarm in May, the thermometer not rising much above 42°; in fact, the average temperature for the last week in May was only 39.4°. July seemed to be the best month, when honey came in freely, with the thermometer ranging from 50° to 85°, the hottest days being Wednesday and Thursday, July 22nd and 23rd, 1891, when it reached 85°, and in the night dropped to 53°.

As to the average yield from my own apiary, I cannot accurately detail it, for during the summer a great deal of honey is consumed by ourselves, and not taken into account. Making a rough guess at it, I should think about thirty pounds from each hive would not be over the mark. My neighbour took from one hive something like 120 one-pound sections, so you must not judge my report as being below the average. Hoping to give you more information after the general meeting of the District Association.—JAMES BROWN, *Court Farm, Failand.*

Queries and Replies.

[467.] *Shallow Frames*.—1. What are the dimensions of a shallow frame? 2. How are they generally placed, hanging or in crates, same as sections? 3. If hanging, what is the space between bottom bar of shallow frame and top bar of brood frames? 4. What sort of shoulders are generally used with shallow frames? I never had an opportunity of seeing these or any other appliances at an exhibition, or any other place, and have no way out of the difficulty except to apply to the *B. B. J.* By answering the above queries you will much oblige, as I am intending to go in for producing extracted honey to some extent next season.—F. H. K., *Co. Kilkenny.*

REPLY.—1. Fourteen inches by five and a half inches. 2. The only difference between a

shallow-frame box and an ordinary body-box for standard frames is, that the former is six inches deep while the latter is nine inches. 3. The frames hang, and are worked precisely as standard frames in ordinary brood chambers. 4. Of course any sort of distance guides may be adopted, but 'W. B. C.' ends are generally used.

[468.] *Utilising Surplus Syrup.*—Could you let me know, through the pages of your admirable *Journal*, the best way of disposing of or utilising syrup left over from the autumn food for bees? Can it be boiled down to the cake form, and used as bee-candy?—H. F. W., *Blackheath*.

REPLY.—We could not vouch for its making good soft candy unless very carefully boiled, according to the directions for making; besides, it would require its proper proportion of cream of tartar adding—*i.e.*, a teaspoonful to six pounds of sugar. We should be disposed to keep it for use as syrup in spring, when it would merely require setting on the fire till it came to a boil before using.

LECTURE ON BEES AND BEE-KEEPING.

At the Hazel Grove Literary Society, Stockport, on Tuesday, the 8th inst., a lecture on 'Bees and Bee-keeping' was given by Mr. J. Bell, of Davenport, near Stockport. The chair was occupied by Mr. R. Clayton. In introducing the subject, the lecturer said he would treat his subject under three headings—first, the natural history and anatomy of the honey-bee; second, modern bee-keeping as a recreation and for profit; third, honey, its medicinal qualities and as food. In speaking of the natural history of the bee, the lecturer said that the bee had no bones, and that its body was covered all over with short hairs, which serve as a protection and for clothing. The eyes of the drone are very large, the worker's eyes are smaller, and the queen's still smaller. The parts of the bee employed in sucking up the honey, and also the breathing apparatus, were fully explained and illustrated by diagrams. The lecturer next described and illustrated the legs, the wings, the sting, and poison-sac, the food of the young bees, and the fertilising and reproductive organs of the male and female. Having described all the various parts, he referred to many incidents in the natural history of the bee, and then proceeded to discuss modern bee-keeping as a recreation and for profit. The bar-frame system was fully explained, and its superiority to the skeps formerly used was pointed out. The method of raising honey in sections, the means adopted to control swarming, and the advantage of procuring a good, strong stock of bees, was fully dealt with. The medicinal qualities of honey and its uses were briefly referred to. The lecture, which occupied two hours, was illustrated by numerous diagrams. The lecturer also exhibited several

frames and honey-combs in explanation of the various parts referred to in the discourse. At the conclusion of the lecture a short discussion followed, and, on the motion of Mr. Sharpe, B.A., seconded by Mr. S. Fernley, a hearty vote of thanks was accorded to the lecturer. A similar compliment to the Chairman brought the meeting to a close.

REVIEW OF GERMAN AND AUSTRIAN BEE JOURNALS.

By J. DENNLER.

1. *Bienenwirtschaftliches Centralblatt*. Editor, Lehzen, Hanover.—Advice to Exhibitors of Honey: M. Lehzen proposes that every exhibitor should be required to show honey both in the liquid state and granulated. In this way the work of the judges would be facilitated.—An Enemy of the Wax-moth: De Rauschenfels describes an insect which Professor Camillo Rondani calls *Eupelmus Dalm. cereanus n.*, whose larva is a parasite of the larva of the wax-moth. This scientist found fifty small larvæ of *Eupelmus* in a dead wax-moth larva. The average honey yield in Hanover is valued at 10 marks 89 pfennige per hive. The native countries of the yellow races of bees, according to the Rev. Father Schachinger, who describes them from personal observations in his travels in the East, are Italy, Egypt, Cyprus, Syria, Rhodes, and the south of Asia Minor, which, however, does not exclude them from being cultivated and acclimatised in other neighbouring countries.

2. *Deutsche Illustrierte Bienenzeitung*. Editor, C. J. H. Gravenhorst.—In the April number is published the biography, with portrait, of the well-known American bee-keeper, Charles Dabant. Born in France on the 22nd May, 1817, in a village in Champagne, Charles Dabant settled in America in 1863, where he goes in for apiculture on a large scale. In 1873 he imported Italian bees; in 1875 he took from his five apiaries 36,000 pounds of honey. His comb-foundation factory is the most important of any in the world. In 1889 he turned out 80,000 pounds; and in 1890, 90,000 pounds of comb foundation. C. Dabant is a well-known and appreciated author, and is reckoned amongst the leading bee-keepers of the day.—An Enemy of the Bee-louse: Al. Alfonsus, jun., of Vienna, describes the book-mite, *Chelifer caucroïdes*, a small insect in the form of a scorpion, with a flattened body, having two strong mandibles. This is often found in hives, and is an enemy of all small insects and their larvæ, which it sucks. It especially hunts up the larvæ of the bee-louse.

3. *Die Bienenzeitung*. Forty-seventh year Editor, W. Vogel.—Apicultural Museum: At a meeting of the delegates of the Bee-keepers' Societies of Franconia, it was unanimously decided to establish an apicultural museum, and the directors of the Zoological Institute of the University of Erlangen were good enough to offer gratuitously the rooms necessary for this.

4. *Münchener Bienenzeitung*. Editor, Dr

Stautner.—Equalising Hives in Apiary: Dr. Stautner justly condemns the practice of equalising hives in the spring, which consists of strengthening weak hives to the detriment of strong ones. It is the opposite practice that should obtain: that is, the strong ones should be further strengthened by having the combs and bees given to them taken from the weak ones. These should only be kept if they have a young, fertile queen, that has to be preserved. It is only the strong hives that are capable of yielding good results.

5. *Deutscher Bienenfreund*. Editor, L. Krancher.—Bees in Palestine: F. Fey speaks of the good qualities of the bees in Palestine. They are not only handsome, but also good workers, as few others are. They never hang out, as is usual with the German and Italian bees. Bee-keeping is very much in vogue amongst the Arabs. In every village there are a number of apiaries, with hundreds of hives. The culture is most primitive; to such an extent that the production of wax exceeds that of honey. F. Fey, amongst other things, mentions a bee-keeper of his acquaintance who, last year, obtained more than five hundredweight of wax.—Good Remedy against Bee-stings: Impregnate a piece of sugar with the poison from three bees, and make the person stung swallow it.

6. *Schlesische Bienenzeitung*. Editor, G. Seeliger. Fourteenth year.—Cyclopean Bee: A bee-keeper, M. Ditrich, describes a cyclopean bee, which he had received from one of his neighbours. This bee only had one eye in the centre of its forehead. Another bee-keeper had, in 1837, a hive, in which he found a great number of cyclopean bees amongst the young bees leaving this hive for the first time. They fell to the ground, and could only rise to a height of fifty centimetres. Not one could return to the hive. The number of these unfortunate bees was often a hundred in a day. At last he changed the queen of this hive, and the cyclopean bees disappeared. [There is a description of cyclopean bees on p. 166 of Cowan's *The Honey Bee*.—Eds. B. B. J.]

7. *Leipziger Bienenzeitung*. Editor, Liedloff.—Heating Hives: The heating of hives has been very deceptive. Many hives, instead of becoming more populated than those not heated, were partly decimated in the spring, and attacked with dysentery.—The Poppy as a Pollen-yielding Plant: A. Lenk warmly recommends the cultivation of the poppy in places where pollen is scarce. Three or four workers are nearly always found in the poppy flowers. Hives must be ventilated in winter, as this is the best means of preventing the combs from getting mildewed, and guarding the bees against attacks of disease.

8. *Bienenpflege*. Editor, Baelz. Thirteenth year.—Use of Bees in the Fertilisation of Plants: A bee-keeper last spring, during the season of flowering, covered several branches of a cherry-tree with muslin, so that neither the circulation of air nor light was excluded. The muslin, on the other hand, prevented the bees from getting

at the flowers of these branches. The result was, that fifteen days after flowering, three-fourths of the flowers had dropped, whereas those branches that were not covered, and whose flowers were continually visited by bees, were crowded with fruit. On the 4th of July, the branches that had been covered with muslin had not a single cherry. A similar result was obtained on a dwarf pear-tree, part of which was also covered with muslin.

9. *Elsass-Lothringische Bienen-Züchter*. Editors, Dennler and Zwilling.—Method of Detecting Adulteration in Comb Foundation: A small piece of comb foundation is melted in a vessel. In another vessel, a piece of soda, the size of a nut, is dissolved in two spoonfuls of hot water. The two are then mixed, and if the comb foundation is of pure beeswax, the liquid is completely saponified, and forms a whitish mass. If, on the other hand, the comb foundation contains ceresine, this floats on the surface as an oily mass.—Legislation: The following petition to the government has been addressed by the Rhenish-Prussian Society of Apiculture: May it please the government of the German Empire to enact a law prescribing, 1st, that by the name of honey nothing should be sold that is not honey from bees; 2nd, that all products imitating honey can only be sold when their composition and origin are indicated on the labels.—Honey exports into Hanover in 1890:

From Havana	value	1,150,000	marks.
„ Mexico	„	1,100,000	„
„ Peru and Chili	.. „	„	682,000	„
„ California	„	10,000	„
„ Australasia	„	20,000	„
„ St. Dominique	.. „	„	860,000	„

The Ant-Lion: In the animal kingdom there is only one friend of the bee, this is the ant-lion, a small insect that destroys ants around the hives.

10. *Oesterreichisch-Ungarische Bienenzeitung*. Editor, Schachinger.—Apiculture in Palestine: The brothers Baldensperger, natives of Alsace, and established in Palestine, have taken 15,000 kilos. of honey from 340 hives. The youngest of the brothers, Willy Baldensperger, lost his life lately in bathing in the sea near Jaffa.

11. *Bienenwater*. Editor, Müller.—The Lubeck Exhibition had 567 exhibitors, amongst which 163 exhibited honey. The honey from Alsace, exhibited by J. Dennler, of Enzheim, and another shown by a bee-keeper in the north of Germany, obtained the first prizes.

12. *Rheinisch-Westphälische Bienenzeitung*. Editor, Koch.—Creoline*: A bee-keeper re-

* M. Dennler will excuse us for pointing out that creoline is not a new remedy. Creoline is the French name for phenyle, and a description of our experiments and doses to be given are found in our *Guide-book*, also in the *Revue Internationale* for 1889, page 138, and *Conduite du Rucher*, by G. Bertrand, page 89. There must also be an error in one bottle curing a thousand hives, as it does not accord with our experience. Soluble phenyle is sold by chemists in 6d. and 1s. bottles, and 3s. 6d. quart tins.—Eds.

commends a new remedy for foul brood. This is creoline, an extract of tar, which it resembles in taste, colour, and smell. It is sold by chemists at sixty pence a bottle, the contents of which would be sufficient to cure a thousand infected colonies.

HOW TO FIND A QUEEN.

When settled warm weather comes in the spring, it is necessary that each colony contain a prolific queen, for if the queen in any colony should be old and failing, that colony could not be brought up to a proper condition to work to the best advantage during the honey harvest. As the queen is mother of all the bees in the hive she must be able to lay rapidly, so as to increase the population of the hive, and if such an one is not in the hive, she should be superseded with a better queen.

It also often happens that the queen which the hive contained during the Fall dies in early spring, and in that case it is absolutely necessary that the bee-keeper knows it, else that colony will perish, for the bees which have been wintered over rapidly die off with the work which now devolves upon them, for old age is brought upon the bees sooner or later, according to the labour which they perform.

There is no way of knowing to a certainty what is going on inside, except by opening the hive and inspecting the frames. To know if there is a queen in the hive, look closely at the combs, and if no eggs or small larva are found in the bottom of the cells at a time when the bees begin to bring in pollen in the spring, you can reasonably expect that they are queenless; while if the eggs are few and scattered about in different cells without regularity, the queen is unprolific.

To be absolutely sure that a colony is queenless, take a frame of comb having eggs and little larva in it, and put it in the centre of the supposed queenless colony, leaving it for three days. If queenless, queen-cells will be formed over some of the little larva, while if no such cells are started, rest assured that the bees of this hive have something which they are respecting as a queen, and which must be found before a good one can be introduced.

To the accustomed eye of the practical apiarist, prolific queens are easily found, especially if the bees are of the Italian race; but a virgin queen is often hard to find by an expert. The best time to look for a queen is about ten o'clock on some bright, warm morning, when the most of the old bees are in the field after pollen and honey.

Open the hive carefully, taking out the frames slowly, and making sure that you do not hit them against the sides of the hive or anything else, so as to make the bees nervous, thereby setting them to running or stinging. When you have the first frame out, look it over carefully, and if you do not see the queen, set this frame and the next one in a box, or in some secure place where you can leave them out of the hive till you look the others over.

After these two are out, you have the hive so that you can see down into it quite well. On taking out another frame, glance down the side of the next one in the hive, when the queen will often be seen running around to the opposite or dark side of the comb, for young queens are shy. In thus running she shows the sides of her abdomen, to the eyes looking obliquely down, to a much better advantage than could be if the eyes were looking directly upon her back. If you do not see her, look on the opposite side of the comb you hold in your hands, looking obliquely as before, for she will be on one of these dark sides, if anywhere, on the comb. In this way keep on until she is found, or all the frames are taken from the hive. If unsuccessful, close the hive and try again in an hour or so, when success will attend your efforts.—G. M. DOOLITTLE.
—*Rural Home.*

Notices to Correspondents and Inquirers.

Letters or queries asking for addresses of manufacturers or correspondents, or where appliances can be purchased, or replies giving such information, can only be inserted as advertisements. The space devoted to letters, queries, and replies, is meant for the general good of bee-keepers, and not for advertisements. We wish our Correspondents to bear in mind that, as it is necessary for us to go to press in advance of the date of issue, queries cannot always be replied to in the issue immediately following the receipt of their communication.
* * * Complaints reach us from time to time of persons not being able to procure the 'Bee Journal' from their local bookseller. No such difficulty need arise. Local booksellers experiencing such a difficulty should instruct their London agent to apply to Messrs. Kent & Co., Paternoster Row, E.C.

JOSHUA F.—*Winter Feeding.*—We cannot agree with you that it is good to continue feeding bees all winter, and it would only tend to mislead were we to print your letter. You will also find it to the ultimate advantage of your own bees if they are well fed-up in autumn, and left alone till the following March.

THOMPSON PARKER.—See our footnote to 'How to Begin Bee-keeping,' on p. 587.

A SCOTCHMAN.—*Heather Honey-press.*—We have just had a letter from the maker of the press referred to, wherein we are informed of the dispatch of a sample press for our inspection. We shall probably report on it next week.

AN ANXIOUS BEE-MAN.—*Bees in Hard Frost.*
—There is no use in giving yourself trouble in the way indicated. If the bees are well packed, well fed, and in dry hives, the severest frost will not harm them. 'Leave them alone' is the best advice we can give you.

J. PARTON.—*Bees Dying.*—It is difficult to account for 'an unusual number of bees dying just now.' Some few dead bees may occasionally be found when entrances are examined, but where they die as described we should suspect either that no food was in reach of the cluster, or else that the bees are so few in number as to be unable to maintain the necessary heat to support life. In any case, an examination should be made to try and find out the cause of death.

Special Prepaid Advertisements

Situations, Publications, Bee Plants, &c.—Twelve words and under, Sixpence; for every additional Three words, One Penny.

Trade Advertisements not inserted under this head.

WANTED.—About 60 lbs. of good Run Honey. Address Mr. W. CHITTY, Middle Class School, Pewsey.

FOR SALE.—50 lbs. of Granulated Honey in One-pound Tin-over Jars. Put on rail for 35s. Address A. WREN, Five Ashes, Mayfield, Surrey. L 90

A WATER SPANIEL, 6 months' old, well bred. Will Sell or Exchange for Bee-hives and Appliances. Address WM. JAS. ANDERSON, Ards, Caledon, Ireland. L 91

RESPECTABLE PERSON wants Employment with Bee-keeper. Abstainer. Address T. CHARLTON, Grange Villa, Chester-le-Street, Co. Durham. L 92

LANTERN SLIDES.—Mr. WATKINS will be able to supply a few Sets from his Negatives to Lecturers on Bee-keeping. All Photographs from Nature and Photomicrographs. Early application advisable. List free. Address ALFRED WATKINS, Hereford.

STEAM FACTORY for Bee Appliances.

ORDERS addressed J. ROSS, Stranraer, Wig-townshire, N.B., will be attended to.

British Bee Journal and Bee-keepers' Record.

OFFICE :

17 KING WILLIAM STREET, STRAND, LONDON, W.C.

PURE CANE SUGARS.

For the accommodation of Bee-keepers, guaranteed Pure Cane Sugar will be supplied in large or small quantities through this office at the under-mentioned rates:—

MOIST. (For Household Use.)

Neat bags, 14-lbs. 28-lbs. 56-lbs. Cwts.

3. MUSCOVADO 2/7 5/2 10/- 19/6

CRYSTALLISED.

4. DEMERARA } Crystals 2/9 5/4 10/6 20/6
5. BARBADOS }
6. TRINIDAD }

REFINED CANE.

7. WHITE CRYSTALS (Small) 3/0 5/10 11/6 22/6

8, 9. (Medium and Large sizes, 1/- per Cwt. extra.)

10. LUMP (Cut Loaf) ... Boxes, 3/3 6/3 12/3 23/6

11. LUMP DUST 3/ 6/- 11/9 22/9

12. PRESERVING 3/- 6/- 11/9 22/9

FINE. (For Household Use.)

13. GRANULATED 3/3 6/3 12/3 23/9

14. CASTOR Coarse (15 Fine) 3/9 7/3 4/3 27/9

16. ICING.. 4/3 8/3 15/9 31/-

All above guaranteed made from CANE SUGAR only, and free from BEET, CHEMICALS, &c., etc.

CARRIAGE PAID ON Orders over 5/0 (or 28-lbs. Sugar) to London and Suburbs.

COUNTRY ORDERS, not less than 2-cwt. carriage paid at 1/0 per cwt. extra.

(Scotch and Irish orders, special arrangements.)

CHEQUES payable to J. HUCKLE, Kings Langley.

Cash to be sent with order, and purchasers will please observe that if samples are required or replies asked to inquiries, a stamped addressed envelope must be sent, as we cannot undertake cost of postage.

BALDWIN'S is the Oldest Establishment in the United Kingdom wholly devoted to Bees and manufacture of

Bee-keepers' supplies. His prices will compare most favourably with those of any other Maker, while for quality of material, suitability and workmanship, he has no rival.

'Why can he give better value for money than others?' Because he spends less in large 'puffing' advertisements, buys in the best markets for prompt cash, has no rent to pay, and personally conducts his own business.

For prices and full particulars of Goods see Baldwin's Bee-keepers' Instructor (and Illustrated Catalogue combined), which 'contains more practical and reliable hints than all the large, expensive books,' post free for 2d. stamps. Address S. J. BALDWIN, The Apiary, Bromley, Kent.

N.B.—More than 500 Silver and Bronze Medals, First and other Prizes, and Testimonials innumerable.

CROCUS for EARLY POLLEN.

A FEW Thousand Fine Sound BULBS, to Clear, at 5s. per 1000. Address

P. HARBORDT,

50 GREAT CHARLOTTE ST., LIVERPOOL.

WANTED, a PUPIL or GENTLEMAN PARTNER for BEE-FARMING in Austria. Address FÜRKNRANZ, Meran, South Tirol. 3327

THE DEPOSIT SYSTEM.

British Bee Journal and Bee-keepers' Record.

OFFICE : KINGS LANGLEY, HERTS; AND

17 KING WILLIAM STREET, STRAND, LONDON, W.C.

The following are the Rules under which we are prepared to receive Sums of Money on Deposit from persons buying and selling goods.

In order to save trouble it is requested that the Rules be carefully read over by persons using the Deposit System of trading.

DEPOSITING.

1. Method.—When strangers are dealing together, the purchase-money of the articles is deposited at our office. We acknowledge receipt of the deposit to both parties, and hold the money until we are satisfied that the purchase is concluded. If a sale be effected, we remit to the seller the amount deposited, less a charge of 6d. and the expenses of Post Office Orders and postage, &c. Cash will be forwarded by cheque, Post Office Order, or by Postal Order as preferred. If a sale or exchange be not completed, we return the amount deposited, after making the same deduction. By this means buyers and sellers are secured from fraud.

2. Deposits.—Postal Orders (drawn on General Post Office) and Cheques must be made payable to John Huckle, and crossed 'Bucks and Oxon Bank.' The numbers of the Postal Orders should be kept by the sender. We cannot be responsible for any losses that may occur in transit.

3. Honey on Approval.—All honey will be sold by sample, which must be sent direct to buyer.

4. Bee-appliances.—In ordering, the time allowed for completing the order to be stated to us when sending cash. If maker accepts, we hold cash till transaction is satisfactorily completed, when the amount will be remitted subject to conditions as in Clause 1.

5. Bees and Queens.—These will be dealt with entirely by the parties concerned, so far as price, &c., goes, and when the purchase is satisfactorily completed cash will be remitted as per Clause 1.

6. Goods in Transit.—These are at the seller's risk, i.e., any damage to or loss of an article on its journey is borne by the vendor; but a rejected article must be properly packed and returned by the same means as was used in sending it.

7. Carriage.—The carriage of all goods, except such as are sent by post, is payable by the buyer, unless otherwise agreed. If any article sent on approval be returned, each party to the transaction must pay carriage one way.

THE
British Bee Journal,
BEE-KEEPERS' RECORD AND ADVISER.

No. 497. Vol. XIX. N.S. 105.]

DECEMBER 31, 1891.

[Published Weekly.]

Editorial, Notices, &c.

END OF OUR NINETEENTH
VOLUME.

With this number we close the nineteenth yearly volume, full of satisfaction with what has been done in the year just ended, and more confident than ever that the bee-keeping industry has a bright future before it.

The mission with which the *British Bee Journal* was started in 1873 was that of aiding 'those enlightened members of the community who cultivate bees, and to induce others to engage in the charming pursuit, feeling assured that there is no other source of profit or amusement which affords such pleasant occupation, or yields so large a return for the capital invested, when rightly understood and practised.' How far we have fulfilled that mission our readers must judge. The words quoted are as true to-day as when written for our first number nearly twenty years ago. Indeed, they are confirmed with singular appositeness on page 595 of this issue, wherein a typical modern bee-keeper, Mr. Wm. Woodley, gives his views of bee-keeping from a commercial standpoint. That some have failed to make it a success may be conceded, but how much of failure may not be traced to causes easily understood when a proper knowledge of the subject has been acquired?

Substantial progress in this direction is being made year by year, and it is with infinite gratification that we are enabled to include in the past year's work done the most important forward movement yet made. Of course, we refer to the assistance now being given from the public funds in aid of technical education in bee-keeping. We may now hope that the proper cultivation of bees will ere long have a full and fair chance, and there is every ground for confidence in the ultimate result.

As the recognised organ of the bee-keepers of this country, we shall gladly take our

share of the work; and it is not too much to suppose that we shall be consulted by readers as the work of education proceeds, and that we hope to assist in removing the difficulties which must inevitably beset the path of those to whose disinterested labours so much of the success of the movement is due. Differences of opinion will no doubt arise among men equally well-intentioned, but we must not pull in opposite directions, or we shall get no 'forrader.' There are many who mean well, even if they 'don't know,' and in view of the necessity for combined action, we would ask to be allowed to add a seasonable word of advice at a time when all of us are resolving on 'mending our ways' for the coming year. It is this: Let us remember that bee-keeping is on its trial; a new era is open to the pursuit; but those who have the guiding of the ship must steer her clear of the quicksands of 'diverse opinions.' We must pull together, resolved to work on the principle of give and take; and when it has been proved by actual experience how the work may best be done so as to achieve the greatest good to the greatest number, the chaff will soon be sifted from the wheat, and we shall have skilled bee-keepers among our farmers and our farm-labourers, as well as among those who only aim at making their bees a profitable hobby.

In no wise can it be said that the outlook for the bee-keeping industry is other than most hopeful; the progress of our *Journal* in the year now ended is the best evidence we can have of this. We therefore start cheerily on our twentieth yearly journey, hoping to receive the same generous assistance in our task as has been rendered in years gone by, and assuring our contributors that their help is appreciated, for we do not fail to see how dull would be the pages of the *B.J.* were it not for the aid from outside. With the best of all good wishes for the health and happiness of contributors and readers, we therefore bid good-bye to the Old Year and welcome the New.

BAD-TEMPERED BEES.

In our editorial note last week on page 586 we alluded to Minorcan bees, and to the aggressiveness of a particular colony that we had seen at Nyon, in Switzerland. We have translated M. Bertrand's own description of them in the *Revue Internationale* for the benefit of our readers, and we hope that the sound advice given by this eminent bee-keeper will be useful to many of our friends, and serve as a warning to them, too. Here is the article:—

A WARNING: A VICIOUS COLONY NEAR A ROAD.

For the first time, during fourteen years that we have had hives placed a few metres from a high wall at the side of a road, has a person been stung on this road. It was in June; the road-labourer was mowing the grass of the slope, when he was suddenly attacked by a large number of bees. Fortunately, he hastened to cover his head with an armful of grass, and to go away. We heard of it from some children that were passing, and assisted the poor man to get rid of the stings that stuck in large numbers in his head. He did not think of complaining, and was only induced with great difficulty to accept a jar of honey for his wife.

But it was necessary to find out the cause as soon as possible. The delinquents belonged to a colony received the previous year from a southern country, and which we had hoped to be able to keep until the autumn, notwithstanding its abominable character, in order to observe if, as in 1888, the bees would construct works of defence at the time that the death's-head moths made their appearance. These bees were so aggressive that it was impossible to approach the hive within a few metres without being stung, which was very inconvenient for the inspection of the other colonies, as well as for work in the garden. We should have destroyed these bees that same evening, but we had the unfortunate idea of saving the combs containing brood, and we contented ourselves by moving the hive sixty metres from the road, behind some trees, and putting an empty hive with a comb in its place.

Next day the *gatherum* came back to their old spot and into the empty hive, and we decided to destroy them in the evening. But many bees remained in the other hive, and, to get rid of them, about four o'clock they were smoked, and we shook the bees off the combs with the queen into a box, and gave the brood to a swarm. The operation would certainly have succeeded with ordinary bees, which would have remained in the box the same as they do after being driven, but a portion of our Spaniards took to their wings and set to work to attack persons and beasts for fifty or sixty metres round. Our dog was able to hide itself before it was too late; the doors and windows of the house, as well as the stable, were closed; but it was necessary to protect the people in the road.

Two persons belonging to the house, protected by veils, took up their positions on the road armed with towels, which they offered to the passers-by, recommending them to wrap themselves round with them and to hurry past. Our two assistants, who perspired under their armour, were surrounded by furious bees. We, with them, were experiencing an anxiety difficult to describe, for this was the hour when there passed shoals of children, of all ages, going to bathe or for a walk, and if some persons had already been able, thanks to the towels, to rapidly clear the dangerous space without being stung, or had consented to turn back, could we also protect these children and remove them far away from this danger? At last we remembered that we had a large bottle of Bader apifuge. Hands and veils were soaked with this, and immediately the bees ceased to attack us. The towels were also moistened with this substance, and were sufficient to protect the passers-by. An hour later the bees were calmed, but this day was the most trying one that we have passed through in all our experience as a bee-keeper.

At night the terrible bees were destroyed, and as a scalded cat is afraid of hot water, the thirteen colonies that remain near the road will be transplanted to another apiary at the foot of the mountain.

The lesson to be derived from this incident, which, fortunately, did not have the bad results it might have had, is that a wall two metres high (three on the side of the garden, which is lower than the road) does not raise the flight of the bees sufficiently, so that the passers-by behind the wall are absolutely protected from the stings, *if the bees in the colonies are of an aggressive nature*. Why, however, should we have bees of bad character? Those of central Europe, besides having excellent qualities, are generally mild-tempered. It is only as one approaches the south that the bees become aggressive and less manageable. Several of our correspondents in the Pyrenees have told us about the viciousness of theirs; and if we go further south it is even worse. We have had a specimen of what the Spaniards are; the Cyprians, Syrians, and those of Palestine are no better, and their reputation is already sealed. As far as regards Egyptian bees, their ferocity surpasses all that can be imagined; travellers, as well as their attendants, have been attacked on the Upper Nile by swarms of bees, and have been horribly maltreated. Let us, then, now that the experiments have been made, abstain from introducing into our apiaries the vicious elements derived from the south, for, as far as regards returns, there is no compensation. We have successively tried the black bees from Algeria, Cyprians from two different localities, bad-tempered Italians and Spaniards [Minorcans—Ed. *B. B. J.*], and in return none of them have given us such good results as our own common bees, or the crosses obtained by selection with Italians from Bologna. Even the good and pure-Italians do not produce so much with us as the crossed ones.

Let those bee-keepers who have any curiosity about foreign races, or think that they can obtain good results by judicious crossing and infusion of fresh blood stick to Carniolans, which, when pure, are the quietest of all known races, and to Italians from good districts. As to those who have the taste for adventure with the southern races, they will do well to take warning by us, and to make their experiments far away from dwellings and public roads.—Ed. BERTRAND.—*Revue Internationale*.

Correspondence.

The Editors do not hold themselves responsible for the opinions expressed by correspondents. No notice will be taken of anonymous communications, and correspondents are requested to write on one side of the paper only, and give their real names and addresses, not necessarily for publication, but as a guarantee of good faith. Illustrations should be drawn on separate pieces of paper. We do not undertake to return rejected communications.

Communications relating to the literary department reports of Associations, Shows, Meetings, Echoes, Queries, Books for Review, &c., must be addressed only to 'The Editors of the "British Bee Journal," 17 King William Street, Strand, London, W.C.' All business communications relating to Advertisements, &c., must be addressed to Mr. J. HUCKLE, Kings Langley, Herts (see 1st page of Advertisements).

** In order to facilitate reference, Correspondents, when speaking of any letter or query previously inserted, will oblige by mentioning the number of the letter, as well as the page on which it appears.*

NOTES BY THE WAY.

[891.] As I write 1891 is fast drawing to a close; its successes and its failures are past and are irrevocable. And we ourselves, as we scan the past and sum up our individual success or otherwise, as the case may be, must feel that many opportunities have been allowed to slip during the year, in which we have not done our best, either for the *craft* collectively or ourselves individually; and, where our conscience condemns us for our shortcomings, let us resolve that in the coming year we will, as far as in us lies, do our best for one another. As I said in a recent 'Note,' my apiary is run on commercial lines, and I am pleased to be able to record that it has again been a success financially. Of course, connected as it is with one of our minor industries, the successes of bee-keeping must be small comparatively with success in larger undertakings; but, for the amount of capital invested and the amount of care and work expended on bee-keeping, I believe it is the most profitable of the minor industries, such as poultry, rabbit, or pig-keeping, and well worthy the attention of our County Councils as a special subject, and likely to produce better results than some other subjects which it is the intention of our Berks County Council to teach the rural population. I did not state in my last 'Notes' (881, p. 574) on self-hivers, that the majority of American hives have flat roofs; therefore, the placing of the hives to receive the swarms on the top of the parent hives is a very easy job, compared to fixing them on the top of our gabled hive-roofs in this country. I should

advise in our case that the swarm-box be placed by the side of the hive, only raised higher, so that the entrance of the empty hive to receive the swarm may be about on a level with the fillet that covers the joint of body-box and the roof. This would give a good ascent for the queen, and would also make it more distinctive after the swarm was returned.

If your correspondent 'Moss' (884, p. 575) would use full sheets or two-thirds-full sheets of foundation when he hives his next swarm, he would not have any trouble with combs built together; that is, supposing his frames are square and hang square. If his bees are put into winter quarters with a good supply of food, and are good strong colonies with young queens, he will not require to stimulate them at all, unless he has some large extent of early bee-pasture that he wishes to secure an early honey harvest from. Then, as to supering new swarms, much depends on the time of swarming and duration of the honey harvest in the district. The time to put on supers is when honey is coming in, and this is known by the fringe of light-coloured wax along the top rows of cells in the frames. This, in connexion with fine, warm weather, is the time when crates of sections are accepted, and work begun in them at once. Take notice of the usual period at which the principal honey-producing plants are in bloom, and one soon becomes conversant with the time to super to secure the best results. There is no accounting for the stock referred to not swarming for two years. I have had, in a few cases, stocks that have not swarmed for six, eight, or ten years, yet were always strong, and secured the best supers year after year—one was known as 'Jumbo,' another as the 'Old Hundredth' (having filled 100 sections in 1884), and another as the 'Bligh' hive. This hive is the same that secured honours in the national competition instituted by the Hon. and Rev. H. Bligh, and no doubt it will interest the hon. and rev. gentleman to know that it continues one of my best stocks, without a break since the competition, and this year nearly reached my record of 1884.

May I say a word on the question of nominal one-pound bottles? When in London recently I was shown honey in bottles sent out by a large firm in Breffit's 14-oz. screw-cap bottles, which the retailer was selling at 9d. per bottle, and on which I was told there was a very good profit—something like 33 per cent. The colour was good (amber), consistency fair, flavour fair; evidently foreign honey that had gone through some clarifying process, as it was bright and clear. I asked, 'Does this honey ever crystallise?' 'Oh, yes,' they said, 'in cold weather; but our customers like it best as it is now.' Here was honey retailing in screw-capped nominal one-pound bottles at 9d. per bottle! Why, I was asking the same price for the same size bottles wholesale, and the only point in which my honey was superior to the other was in flavour! But how is the grocer or confectioner to spare time to teach the consumer that the

1s. bottle of honey is superior to the foreign by 3*l.* per bottle, of the same size and quantity? If this honey had been in 16-oz. bottles I should have asked 10s. per dozen for them instead of 9s., and where would my chance of taking an order been? Very remote, I fear. No one wishes to be just in weights and measures more than myself, but I contend that we, as purchasers to the general public, under the present high-pressure competition, must go with the tide, and supply the public needs, as far as honey is concerned, in saleable packages; and if 14-oz. packages sell—at a penny less—better than the 16-oz. packages would, by all means we must supply the packages; and if we bee-keepers will not, depend upon it there are firms who are ready to do so and will do so. Then, on the other hand, if bottles of honey are sold at so much each, I fail to see where anything savouring of cheating can be cast at bee-keepers. I never feel any qualms of conscience when sending off a gross of sections at per dozen, though I know perfectly well that the contents of the sections vary, sometimes, three to four ounces; some may contain only 13½ to 14 ozs., while others turn the scale at 17 ozs. But so long as I sell at per dozen or per gross, I feel when I receive the cheque in payment that it is an honourable transaction; and my customers, I opine, think so too, for I have supplied some of them for ten years consecutively. Many other kinds of food are put up in packages of various sizes and sold at various prices, then why not honey? If a customer sends for a pot of honey he is charged net weight, or if he brings a vessel to put his purchase in he receives 16 ozs. to the pound; but if he does not do so, he has to buy at so much per bottle. In various other kinds of food, vessels such as glass tumblers, mugs, jugs, teacups, or tobacco-pots, are used as receptacles to contain them—*e.g.*, marmalade, jams, &c. These articles of everyday use are useful when empty, and to get more of the same kind of useful thing often induces a purchase of the article of food they contain. As one who has been in the supply trade I know of what I speak. Shall I say to bee-keepers and honey sellers, 'Go and copy the marmalade and jam makers or vendors, and increase your sales of honey manyfold?'—W. WOODLEY, *World's End, near Newbury.*

WINTERING BEES IN OUTHOUSES.

[892]. Your correspondent, Mr. Brown, who moved his bees into a shed for winter, need not, I think, be in fear of losing any more bees, as the late frost will have so far confined them that when flying they will mark their new stand.

I am a strong advocate of always keeping hives *the year through* in just such a house as he has built, because then far cheaper hives can be used, no roofs required, manipulations much more easily and quickly performed, robbing reduced to a minimum; when opening hives, bees instead of stinging fly out at the window; only

one roof to keep water-tight, &c. It is well to put separate porches outside the house for each entrance, making them of various shapes and colours to assist the bees in marking their own entrance, which should be cut the whole length of hive entrance, say ten inches. In a back number of the *B. B. J.* Mr. Brown will find an illustrated article of mine giving a full account of the house I use, which will hold 100 stocks. As the number is out of print I shall be happy to lend my copy if written to.—EDWARD J. GIBBINS, *Neath, Glamorgan, December 28th.*

[There is some fear that our correspondents will confuse the issue involved in the question which first gave rise to the title at the head of the above communication. 'Wintering Bees in Outhouses' as the query was put to us on page 565 is one thing, and as presented by our correspondent, Mr. Brown, on page 587, is another, while Mr. Gibbins, as we know, is a strong advocate for a bee-house as the best place for keeping hives all the year round. But he does not keep his stocks in the open at one time, move them into a bee-house at another, and then 'distribute the hives over the garden' when the winter is over. This is what we deprecated in our footnote, and must continue to do so.—Eds.]

BEE-KEEPING IN SOUTH AUSTRALIA.

[893.] It may be interesting to note that, according to *Nature* (December 24, 1891, p. 184) the bee-owners in South Australia roughly estimate that they had 25,383 hives in the colony last year, producing nearly 300 tons of honey, of which 80,793 pounds were exported.—J. S. DISMORR, *Gravesend.*

QUEENS FERTILISED IN FULL COLONIES WITH A LAYING QUEEN.

[894.] It was of special interest to read the article in *B. J.* for December 17th, page 579, reprinted from *Gleanings*, under the above title. It throws a little more light on my letter (646, p. 239), 'When Doctors and Professors Differ,' referring to the very same subject—*Doolittle v. Dr. Tinker*. From subsequent letters in *Gleanings* it would appear that Dr. Miller championed Dr. Tinker's theory, and Mr. C. W. Dayton upheld that of Mr. Doolittle. Dr. T. asserts that the young queens will be 'balled,' and under exactly similar conditions Mr. Doolittle has two fertilised queens laying in the same hive by giving an additional entrance-hole. Dr. Tinker says nothing about this latter, according to the editorial footnote, which also explains that under Tinker's plan the young queen would have to pass through the body-box, thus entering her rival's dominions, so that in all the cases it turns upon the question of a second entrance cut in the upper chamber, which contains the young queen. No doubt Mr. Dayton has practised what he preaches if the facts are as represented by him, and the same may be said of Doolittle also. The raising

of second queens in the same colony is rendered comparatively easy, and is a great step forward, and may turn out a key to success. In fact it will prevent swarming better and easier than any other method, avoiding splitting up the strength of stocks by division, but concentrating the whole population and doubling the brood-production for a time. By exchanging the old queen for a young one just when the honey-glut comes, the bees do not swarm out, and if the young queen is safely mated and begins laying in the same hive, the parent queen is then confined between two walls of queen-excluder zinc, and does not leave the hive until the following season with a swarm. If bees are found to tolerate and acknowledge two queens in one hive in this way, it is only necessary, in order to secure a successful result, to make a swarm artificially, by brushing the old queen and part of the bees into a new hive upon the old stand in the usual way, then placing the original, with all the brood and the remaining part of the bees on the top of it, dividing the two chambers by a queen-excluder. As soon as the loss of the old queen is noticed, all the older bees will join her in the lower chamber, and thus increase the swarm. Directly after the uproar I would divide or disconnect the two hives for two days, leaving the top story, or old hive, in perfect darkness, but with ventilation and a water supply. The bees should settle down at once to raising queen-cells. In from three to six days the bees in lower hive will have drawn the combs out; then reunite the two hives. The parent one above will have queen-cells, but if an already advanced queen-cell is available, I would insert it into one of the combs with brood. If all goes right, the bees will be joined together into one colony again with the old laying queen below upon the new combs, and the top hive with an advanced queen-cell ready to hatch out, say, in about four days.

Bearing in mind that young queens are said not to mate until six days old, we have at least a week in hand, and if we remove the frames with the queen-cell and all adhering bees into the lower hive, and lift the combs with the old laying queen into the upper one, and confine the queen in part of the latter, as Mr. Dayton recommends, by a wall of queen-excluder zinc, if this be properly done the bees will not notice the removal of the old queen into the upper story, and, as she is unable to deposit eggs on any combs but those on which she is confined, by this means the queen-cell now in the new swarm in lower story will be allowed to hatch, and the young queen returns mated, emerges into an eggless portion of the hive, and begins laying there. By this means a second separate entrance is not required at all. When both queens are laying, a large colony will be the result in time for the honey-glut; then the old queen can be destroyed, and the combs in upper hive become honey receptacles for the extractor. Additional supers may be added as required. Not only does changing of the old queen for a

young one induce more lively activity in the colony, but we also get a new set of combs built in addition, all with worker cells, without increasing the number of stocks and without swarming.—J. G. K., *Grove House, Southborough, Tunbridge Wells.*

Queries and Replies.

[469.] *Golden Syrup for Bee-food.*—A friend of mine having bought two hundredweight of sugar, &c., the settings from golden syrup, and only having one stock of bees, wished me to buy some at a penny per pound; but I prefer to have your advice on the subject first. Would it be in any way suitable for bee-food, as I have eleven stocks all in bar-frame hives, which will probably require feeding in spring, but do not believe in giving my bees rubbish?—A. DELBRIDGE, *Parracombe.*

REPLY.—You will find it pays better to buy suitable sugar for bee-food than using cheap substitutes. The granulated portion of the golden syrup will contain too much treacle to be wholesome food for bees.

[470.] Will you kindly answer the following questions in your next number? Is the nectar or secretion of the flower which the bee collects of the same chemical composition as honey? Or is the nectar converted into honey by the bee by some process or by mixing it with another secretion of its own?—F. W. P.

REPLY.—The nectar from flowers as gathered by the bee undergoes chemical changes before it is converted into honey. By means of a secretion produced by the salivary glands the cane sugar of nectar is converted into grape sugar of honey. Coagulated albumen is also found in honey, whereas it is not present in nectar. Moreover, formic acid is added to honey and acts as a powerful preservative.

CONCENTRATION OF FORCES AND NON-SWARMING.

I would be pleased to know all of the conditions, from beginning to the end, of the honey season in those localities where the reports show that no surplus honey has been secured the past season. I imagine that with my apiary, and my plan of concentration of forces, I could have taken some surplus in any of those localities that have been reported an entire failure the past season. Of course, I do not know all the facts, and, therefore, may be mistaken. But in my own locality—a closely farmed country, where our bees must depend solely on the black locust and white clover, I have never yet seen a season that there was not a 'honey-flow,' long or short, at some period during the season. It is true that more than one time I have been taken by surprise, and missed the opportunity to profit by it. But the 'honey-flow' has come and gone all the same.

I have frequently remarked that the season must be a mighty poor one if I cannot get some surplus with the honey-extractor. The remedy against poor honey seasons is *concentration of forces*.

Not a swarm should be allowed to issue. My plan to accomplish this is simple and easy, and requires but one single manipulation. All plans that require continual fussing with the bees have been discarded in my apiary. Just at the commencement of the honey season, and before any swarms issue, all the colonies strong enough to cast swarms are treated as follows:—All the combs containing brood are removed from the brood chamber, except one that contains but a small amount of unsealed brood and eggs; this is left in the brood chamber with the queen on it. If she is not found on it she must be hunted up and put upon this comb. The brood chamber is now filled out with empty combs, and a queen-excluder is placed on its top. The combs containing brood are adjusted in a super or hive body, and, if they do not fill it, it is filled out with empty combs. It now goes on top of the brood chamber with the queen-excluder between. We now have all the brood above the queen-excluder except what is in the one comb with the queen on it below the excluder. You now have nothing to do but to 'turn up' to suit the season. Treating all the colonies in this way, the season will have to be more than usually extended if there is a single swarm. Colonies treated in this way are the strongest colonies I ever handled, and I have never seen a season so barren of nectar that they fail to fill the combs above the excluder by the time all the brood they contain are hatched out. And if the season is a good one, they will surprise the 'natives,' and make you uneasy about the safety of your honey-house floor, like my bees did me the past season, though the season was but an average one.—G. W. DEMAREE, in '*Bee-keepers' Guide*.'

SHAKESPEARE AND BEES.

The following passage from *The Two Gentlemen of Verona* will show that Shakespeare had observed the fights that took place between wasps and bees:—

'Injurious wasps! to feed on such sweet honey,
And kill the bees, that yield it, with your
stings!' Act I., Scene 2.

'The honey boys steal from the humble-bees,
And for night tapers, crop their waxen thighs.'
Midsummer Night's Dream, Act III., Scene 2.

'The fox, the ape, and the humble-bee,
Were still at odds, being but three.'
Love's Labour Lost, Act III., Scene 1.

How well a worn-out worker is illustrated in the following:—

'Since I nor wax, nor honey can bring home,
I quickly were dissolved from my hive,
To give some labourers room.'
All's Well that Ends Well, Act I., Scene 2.

'They surfeited with honey, and began
To loathe the taste of sweetness, whereof a
Little more than a little is by much too much.'
Henry IV., Part 2, Act IV., Scene 4.

'Like one besotted on your sweet delights:
You have the honey still, but these the gall.'
Troilus and Cressida, Act II., Scene 2.

'We would purge the land of these drones
that rob the bee of her honey.'

Pericles, Prince of Tyre, Act II., Scene 1.

These are a few of the passages in which bees and honey are referred to, but there a good many more. Indeed, from the frequent allusions made by Shakespeare, this insect must have been a favourite with him, and it certainly furnished him with numerous similes; and, not content with the word 'honey,' both in a literal and metaphorical sense, he has interwoven it in several endearing epithets, such as 'honey love,' 'honey nurse,' and in *Julius Caesar* we find the following curious expression:—

'Enjoy the honey-heavy dew of slumber.'
Act II., Scene 1.

Many other poets have alluded to bees and honey, but none so frequently as Shakespeare.

Notices to Correspondents and Inquirers.

LONGLANDS.—*Bees Dying*.—We cannot say what has caused the death of the bees sent, or if they have died of disease, the internal organs of dead bees being quite unfit for microscopical examination unless perfectly fresh specimens are supplied. We should not think their death is attributable to a disease such as foul brood.

E. G. FLOWER (Stokenchurch).—*A Beginner's Troubles*.—Mr. Huckle, Kings Langley, Herts, is secretary of the B. B. K. A. There is also the Buckingham and District Association, of which Mr. W. Sturdy, Thornton Hall, Stony Stratford, is the Secretary. You must bear in mind that members of Bee Associations are only entitled to a visit from the Expert when the latter is on his regular tour in spring and autumn. Referring to your present trouble, you do not say if the swarms are in frame hives or in skeps, nor if they have been fed up at all for winter. Write us, giving these particulars, and we will do what we can to help you.

GARDENER (Staffordshire).—*Feeding Bees in Skeps in December*.—You may try feeding the bees with soft candy cake, placed on the floorboards, but we much prefer giving food in winter *overhead*. If a circular hole is cut in the crown of each skep, a good-sized ball of soft candy may be moulded into a shape that will lie close above the hole, and if carefully covered with warm material, no through-draught need be caused. The food will thus be easier got at by the bees than if placed below, and the supply may be renewed as required.

B. EXCLUDER (Derby).—*Candy-making*.—The sample of candy sent is of the right consistency, but we judge its clearness arises from your failure to keep it *stirred while cooling*. It is this stirring which causes the mass to granulate.

